

# Service Manual

## Air Conditioner

**Outdoor Unit**  
**CU-4Z80TBE**  
**CU-5Z90TBE**

**Destination**  
**Europe**

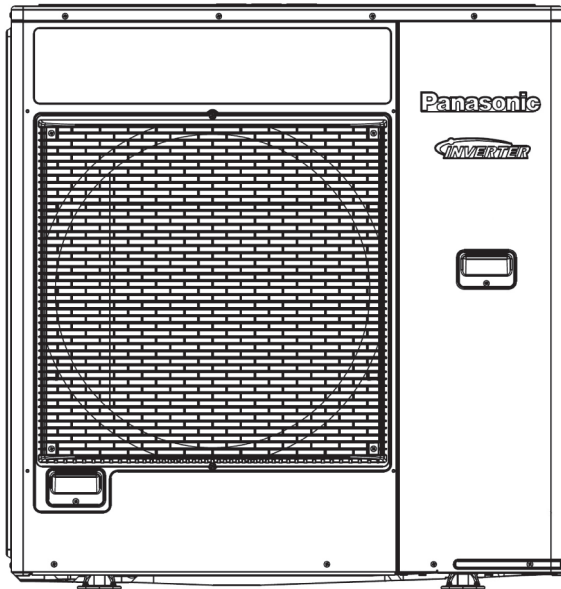

Please file and use this manual together with the service manual for Model No. CS-MZ16TKE CS-Z20TKEW CS-Z25TKEW CS-Z35TKEW CS-Z42TKEW CS-Z50TKEW CS-Z71TKEW CS-XZ20TKEW CS-XZ25TKEW CS-XZ35TKEW CS-XZ50TKEW CS-MTZ16TKE CS-TZ20TKEW CS-TZ25TKEW CS-TZ35TKEW CS-TZ42TKEW CS-TZ50TKEW CS-TZ60TKEW CS-TZ71TKEW CS-TE20TKEW CS-TE25TKEW CS-TE35TKEW CS-TE42TKEW CS-TE50TKEW CS-TE60TKEW CS-E9PD3EA CS-E12QD3EAW CS-E18RD3EAW CS-E9PB4EA CS-E12PB4EA CS-E18RB4EAW CS-E21RB4EAW  
 Order No. PAPAMY1702034CE PAPAMY1701023CE PAPAMY1702032CE PAPAMY1703046CE PAPAMY1704060CE PAPAMY1703052CE PAPAMY1704061CE PAPAMY1305054CE PAPAMY1406071CE PAPAMY1505102CE PAPAMY1305053CE PAPAMY1501055CE

### **WARNING**

This service information is designed for experienced repair technicians only and is not designed for use by the general public. It does not contain warnings or cautions to advise non-technical individuals of potential dangers in attempting to service a product. Products powered by electricity should be serviced or repaired only by experienced professional technicians. Any attempt to service or repair the products dealt with in this service information by anyone else could result in serious injury or death.

### **IMPORTANT SAFETY NOTICE**

There are special components used in this equipment which are important for safety. These parts are marked by  in the Schematic Diagrams, Circuit Board Diagrams, Exploded Views and Replacement Parts List. It is essential that these critical parts should be replaced with manufacturer's specified parts to prevent shock, fire or other hazards. Do not modify the original design without permission of manufacturer.

### **PRECAUTION OF LOW TEMPERATURE**



In order to avoid frostbite, be assured of no refrigerant leakage during the installation or repairing of refrigerant circuit.

# TABLE OF CONTENTS



	PAGE		PAGE
<b>1. Safety Precautions .....</b>	<b>3</b>	14.8 Deice Control.....	282
<b>2. Precaution for Using R32 Refrigerant .....</b>	<b>6</b>	14.9 Time Delay Safety Control (Restart Control) ..	282
<b>3. Specifications .....</b>	<b>10</b>	14.10 30 seconds Force Operation .....	282
3.1 CU-4Z80TBE .....	10	14.11 Total Current Control.....	282
3.2 CU-5Z90TBE .....	12	14.12 IPM (power transistor) Protection Control .....	282
<b>4. Dimensions .....</b>	<b>256</b>	14.13 Compressor Protection Control (Gas leak detection control 1) .....	283
<b>5. Refrigeration Cycle Diagram .....</b>	<b>257</b>	14.14 Compressor Protection Control (Gas leak detection control 2) .....	283
5.1 CU-4Z80TBE .....	257	14.15 Valve close detection control.....	283
5.2 CU-5Z90TBE .....	258	14.16 Compressor discharge high pressure protection control .....	283
<b>6. Block Diagram .....</b>	<b>259</b>	14.17 Compressor discharge high temperature protection control .....	284
6.1 CU-4Z80TBE .....	259	14.18 Cooling Outdoor Air Temperature Control (Cool).....	284
6.2 CU-5Z90TBE .....	260	14.19 Heating Outdoor Air Temperature Control (Heat).....	284
<b>7. Wiring Connection Diagram .....</b>	<b>261</b>	<b>15. Servicing Mode .....</b>	<b>285</b>
7.1 CU-4Z80TBE .....	261	<b>16. Troubleshooting Guide .....</b>	<b>287</b>
7.2 CU-5Z90TBE .....	262	16.1 Self Diagnosis Function.....	287
<b>8. Electronic Circuit Diagram .....</b>	<b>263</b>	16.2 Self-diagnosis Method.....	290
8.1 CU-4Z80TBE .....	263	<b>17. Disassembly and Assembly Instructions .....</b>	<b>313</b>
8.2 CU-5Z90TBE .....	264	17.1 Outdoor Unit Removal Procedure .....	313
<b>9. Printed Circuit Board .....</b>	<b>265</b>	<b>18. Technical Data .....</b>	<b>316</b>
9.1 Main Printed Circuit Board .....	265	18.1 Cool Mode Performance Data.....	316
9.2 Noise Filter Printed Circuit Board .....	266	18.2 Heat Mode Performance Data.....	514
9.3 Display Printed Circuit Board .....	266	<b>19. Service Data .....</b>	<b>842</b>
<b>10. Installation Information.....</b>	<b>267</b>	19.1 Operation Characteristics (CU-4Z80TBE).....	842
10.1 CU-4Z80TBE .....	267	19.2 Operation Characteristics (CU-5Z90TBE).....	872
10.2 CU-5Z90TBE .....	268	<b>20. Exploded View and Replacement Parts List.....</b>	<b>904</b>
<b>11. Installation Instruction .....</b>	<b>269</b>		
11.1 Select The Best Location .....	269		
11.2 Install The Outdoor Unit .....	270		
11.3 Connect The Piping .....	270		
11.4 Air Tightness Test on the Refrigerating System.....	272		
11.5 Connect The Cable To The Outdoor Unit .....	273		
11.6 Heat Insulation.....	275		
<b>12. Operation Control.....</b>	<b>276</b>		
12.1 Cooling Operation.....	276		
12.2 Heating Operation .....	278		
<b>13. Simultaneous Operation Control .....</b>	<b>279</b>		
<b>14. Protection Control.....</b>	<b>280</b>		
14.1 Freeze Prevention control (Cool) .....	280		
14.2 Dew Prevention control (Cool) .....	280		
14.3 Electronic Parts Temperature Rise Protection 1 (Cool).....	280		
14.4 Electronic Parts Temperature Rise Protection 2 (Cool).....	280		
14.5 Cooling overload control (Cool).....	281		
14.6 Heating overload control (Heat) .....	281		
14.7 Extreme Low Temperature Compressor low pressure protection control (Heat).....	281		

# 1. Safety Precautions



















- Read the following “SAFETY PRECAUTIONS” carefully before installation.
- Electrical work must be installed by a licensed electrician. Be sure to use the correct rating of the power plug and main circuit for the model to be installed.
- The caution items stated here must be followed because these important contents are related to safety. The meaning of each indication used is as below. Incorrect installation due to ignoring of the instruction will cause harm or damage, and the seriousness is classified by the following indications.

 <b>WARNING</b>	This indication shows the possibility of causing death or serious injury.
 <b>CAUTION</b>	This indication shows the possibility of causing injury or damage to properties only.















- The items to be followed are classified by the symbols:

	Symbol with white background denotes item that is PROHIBITED.
 	Symbol with dark background denotes item that must be carried out.

- Carry out test running to confirm that no abnormality occurs after the installation. Then, explain to user the operation, care and maintenance as stated in instructions. Please remind the customer to keep the operating instructions for future reference.
- This appliance is not intended for accessibility by the general public.











 <b>WARNING</b>		
1.	Do not use means to accelerate the defrosting process or to clean, other than those recommended by the manufacturer. Any unfit method or using incompatible material may cause product damage, burst and serious injury.	
2.	Do not install outdoor unit near handrail of veranda. When installing air-conditioner unit on veranda of a high rise building, child may climb up to outdoor unit and cross over the handrail causing an accident.	
3.	Do not use unspecified cord, modified cord, joint cord or extension cord for power supply cord. Do not share the single outlet with other electrical appliances. Poor contact, poor insulation or over current will cause electrical shock or fire.	
4.	The appliance shall be stored in a well ventilated room with indoor floor area larger than $A_{min}$ (m <sup>2</sup> ) [refer Table A] and without any continuously operating ignition source. Keep away from open flames, any operating gas appliances or any operating electric heater. Else, it may explode and cause injury or death.	
5.	Do not tie up the power supply cord into a bundle by band. Abnormal temperature rise on power supply cord may happen.	
6.	Do not insert your fingers or other objects into the unit, high speed rotating fan may cause injury. 	
7.	Do not sit or step on the unit, you may fall down accidentally. 	
8.	The appliance shall be installed, and/or operated in a room with floor area larger than $A_{min}$ (m <sup>2</sup> ) [refer Table A] and keep away from ignition sources, such as heat/sparks/open flame or hazardous areas such as gas appliances, gas cooking, reticulated gas supply systems or electric cooking appliances, etc.	
9.	Keep plastic bag (packaging material) away from small children, it may cling to nose and mouth and prevent breathing.	
10.	When installing or relocating air conditioner, do not let any substance other than the specified refrigerant, eg. air etc mix into refrigeration cycle (piping). Mixing of air etc. will cause abnormal high pressure in refrigeration cycle and result in explosion, injury etc.	
11.	Do not pierce or burn as the appliance is pressurized. Do not expose the appliance to heat, flame, sparks, or other sources of ignition. Else, it may explode and cause injury or death.	
12.	Do not add or replace refrigerant other than specified type. It may cause product damage, burst and injury etc.	
13.	Do not perform flare connection inside a building or dwelling or room, when joining the heat exchanger of indoor unit with interconnecting piping. Refrigerant connection inside a building or dwelling or room must be made by brazing or welding. Joint connection of indoor unit by flaring method can only be made at outdoor or at outside of a building or dwelling or room. Flare connection may cause gas leak and flammable atmosphere.	
14.	<ul style="list-style-type: none"> <li>• For R32 model, use piping, flare nut and tools which is specified for R32 refrigerant. Using of existing (R22) piping, flare nut and tools may cause abnormally high pressure in the refrigerant cycle (piping), and possibly result in explosion and injury.</li> <li>• Thickness for copper pipes used with R32 must be more than 0.8 mm. Never use copper pipes thinner than 0.8 mm.</li> <li>• It is desirable that the amount of residual oil less than 40 mg/10 m.</li> </ul>	
15.	Engage authorized dealer or specialist for installation. If installation done by the user is incorrect, it will cause water leakage, electrical shock or fire.	

 **WARNING**

16.	For refrigeration system work, install according to this installation instructions strictly. If installation is defective, it will cause water leakage, electrical shock or fire.	
17.	Use the attached accessories parts and specified parts for installation. Otherwise, it will cause the set to fall, water leakage, fire or electrical shock.	
18.	Install at a strong and firm location which is able to withstand weight of the set. If the strength is not enough or installation is not properly done, the set will drop and cause injury.	
19.	For electrical work, follow the national regulation, legislation and this installation instructions. An independent circuit and single outlet must be used. If electrical circuit capacity is not enough or defect found in the electrical work, it will cause electrical shock or fire.	
20.	Do not use joint cable for indoor/outdoor connection cable. Use the specified indoor/outdoor connection cable, refer to instruction ⑤ <b>CONNECT THE CABLE TO THE INDOOR UNIT</b> and connect tightly for indoor/outdoor connection. Clamp the cable so that no external force will have impact on the terminal. If connection or fixing is not perfect, it will cause heat up or fire at the connection.	
21.	Wire routing must be properly arranged so that control board cover is fixed properly. If control board cover is not fixed perfectly, it will cause fire or electrical shock.	
22.	This equipment is strongly recommended to be installed with Earth Leakage Circuit Breaker (ELCB) or Residual Current Device (RCD), with sensitivity of 30mA at 0.1 sec or less. Otherwise, it may cause electrical shock and fire in case of equipment breakdown or insulation breakdown.	
23.	During installation, install the refrigerant piping properly before running the compressor. Operation of compressor without fixing refrigeration piping and valves at opened position will cause suck-in of air, abnormal high pressure in refrigeration cycle and result in explosion, injury etc.	
24.	During pump down operation, stop the compressor before removing the refrigeration piping. Removal of refrigeration piping while compressor is operating and valves are opened will cause suck-in of air, abnormal high pressure in refrigeration cycle and result in explosion, injury etc.	
25.	Tighten the flare nut with torque wrench according to specified method. If the flare nut is over-tightened, after a long period, the flare may break and cause refrigerant gas leakage.	
26.	After completion of installation, confirm there is no leakage of refrigerant gas. It may generate toxic gas when the refrigerant contacts with fire.	
27.	Ventilate if there is refrigerant gas leakage during operation. It may cause toxic gas when the refrigerant contacts with fire.	
28.	Be aware that refrigerants may not contain an odour.	
29.	This equipment must be properly earthed. Earth line must not be connected to gas pipe, water pipe, earth of lightning rod and telephone. Otherwise, it may cause electrical shock in case of equipment breakdown or insulation breakdown.	





 **CAUTION**

1.	Do not install the unit in a place where leakage of flammable gas may occur. In case gas leaks and accumulates at surrounding of the unit, it may cause fire.	
2.	Prevent liquid or vapor from entering sumps or sewers since vapor is heavier than air and may form suffocating atmospheres.	
3.	Do not release refrigerant during piping work for installation, re-installation and during repairing refrigeration parts. Take care of the liquid refrigerant, it may cause frostbite.	
4.	Do not install this appliance in a laundry room or other location where water may drip from the ceiling, etc.	
5.	Do not touch the sharp aluminium fin, sharp parts may cause injury. 	
6.	Carry out drainage piping as mentioned in installation instructions. If drainage is not perfect, water may enter the room and damage the furniture.	
7.	Select an installation location which is easy for maintenance. Incorrect installation, service or repair of this air conditioner may increase the risk of rupture and this may result in loss damage or injury and/or property.	
8.	Power supply connection to the room air conditioner. Use power supply cord CU-4Z80*** (3 x 2.5 mm <sup>2</sup> ), CU-5Z90*** (3 x 4.0 mm <sup>2</sup> ) type designation 60245 IEC 57 or heavier cord. Connect the power supply cord of the air conditioner to the mains using one of the following method. Power supply point should be in easily accessible place for power disconnection in case of emergency. In some countries, permanent connection of this air conditioner to the power supply is prohibited. 1) Power supply connection to the receptacle using power plug. Use an approved 20A (CU-4Z80***), 25A (CU-5Z90***) power plug with earth pin for the connection to the socket. 2) Power supply connection to a circuit breaker for the permanent connection. Use an approved 20A (CU-4Z80***), 25A (CU-5Z90***) circuit breaker for the permanent connection. It must be a double pole switch with a minimum 3.0 mm contact gap.	
9.	Installation work. It may need two people to carry out the installation work.	

## 2. Precaution for Using R32 Refrigerant

- The basic installation work procedures are the same as conventional refrigerant (R410A, R22) models. However, pay careful attention to the following points:

 <b>WARNING</b>	
Since the working pressure is higher than that of refrigerant R22 models, some of the piping and installation and service tools are special. (See "2.1. Special tools for R32 (R410A)".)	
1.	Especially, when replacing a refrigerant R22 model with a new refrigerant R32 model, always replace the conventional piping and flare nuts with the R32 and R410A piping and flare nuts on the outdoor unit side. For R32 and R410A, the same flare nut on the outdoor unit side and pipe can be used.
2.	Models that use refrigerant R32 and R410A have a different charging port thread diameter to prevent erroneous charging with refrigerant R22 and for safety. Therefore, check beforehand. [The charging port thread diameter for R32 and R410A is 12.7 mm (1/2 inch).]
3.	Be more careful than R22 so that foreign matter (oil, water, etc.) does not enter the piping. Also, when storing the piping, securely seal the opening by pinching, taping, etc. (Handling of R32 is similar to R410A.)
 <b>CAUTION</b>	
Installation (Space)	
1.	<ul style="list-style-type: none"> <li>Must ensure the installation of pipe-work shall be kept to a minimum. Avoid use dented pipe and do not allow acute bending.</li> <li>Must ensure that pipe-work shall be protected from physical damage.</li> <li>Must comply with national gas regulations, state municipal rules and legislation. Notify relevant authorities in accordance with all applicable regulations.</li> <li>Must ensure mechanical connections be accessible for maintenance purposes.</li> <li>In cases that require mechanical ventilation, ventilation openings shall be kept clear of obstruction.</li> <li>When disposal of the product, do follow to the precautions in #12 and comply with national regulations.</li> </ul> <p>Always contact to local municipal offices for proper handling.</p>
Servicing	
2-1. Service personnel	
<ul style="list-style-type: none"> <li>Any qualified person who is involved with working on or breaking into a refrigerant circuit should hold a current valid certificate from an industry-accredited assessment authority, which authorizes their competence to handle refrigerants safely in accordance with an industry recognized assessment specification.</li> <li>Servicing shall only be performed as recommended by the equipment manufacturer. Maintenance and repair requiring the assistance of other skilled personnel shall be carried out under the supervision of the person competent in the use of flammable refrigerants.</li> <li>Servicing shall be performed only as recommended by the manufacturer.</li> </ul>	
2-2. Work	
<ul style="list-style-type: none"> <li>Prior to beginning work on systems containing flammable refrigerants, safety checks are necessary to ensure that the risk of ignition is minimised.</li> <li>For repair to the refrigerating system, the precautions in #2-2 to #2-8 must be followed before conducting work on the system.</li> <li>Work shall be undertaken under a controlled procedure so as to minimize the risk of a flammable gas or vapour being present while the work is being performed.</li> <li>All maintenance staff and others working in the local area shall be instructed and supervised on the nature of work being carried out.</li> <li>Avoid working in confined spaces.</li> <li>Wear appropriate protective equipment, including respiratory protection, as conditions warrant.</li> <li>Ensure that the conditions within the area have been made safe by limit of use of any flammable material. Keep all sources of ignition and hot metal surfaces away.</li> </ul>	
2.	2-3. Checking for presence of refrigerant
<ul style="list-style-type: none"> <li>The area shall be checked with an appropriate refrigerant detector prior to and during work, to ensure the technician is aware of potentially flammable atmospheres.</li> <li>Ensure that the leak detection equipment being used is suitable for use with flammable refrigerants, i.e. non sparking, adequately sealed or intrinsically safe.</li> <li>In case of leakage/spillage happened, immediately ventilate area and stay upwind and away from spill/release.</li> <li>In case of leakage/spillage happened, do notify persons down wind of the leaking/spill, isolate immediate hazard area and keep unauthorized personnel out.</li> </ul>	
2-4. Presence of fire extinguisher	
<ul style="list-style-type: none"> <li>If any hot work is to be conducted on the refrigeration equipment or any associated parts, appropriate fire extinguishing equipment shall be available at hand.</li> <li>Have a dry powder or CO<sub>2</sub> fire extinguisher adjacent to the charging area.</li> </ul>	
2-5. No ignition sources	
<ul style="list-style-type: none"> <li>No person carrying out work in relation to a refrigeration system which involves exposing any pipe work that contains or has contained flammable refrigerant shall use any sources of ignition in such a manner that it may lead to the risk of fire or explosion. He/She must not be smoking when carrying out such work.</li> <li>All possible ignition sources, including cigarette smoking, should be kept sufficiently far away from the site of installation, repairing, removing and disposal, during which flammable refrigerant can possibly be released to the surrounding space.</li> <li>Prior to work taking place, the area around the equipment is to be surveyed to make sure that there are no flammable hazards or ignition risks.</li> <li>"No Smoking" signs shall be displayed.</li> </ul>	

 **CAUTION**

2-6. Ventilated area

- Ensure that the area is in the open or that it is adequately ventilated before breaking into the system or conducting any hot work.
- A degree of ventilation shall continue during the period that the work is carried out.
- The ventilation should safely disperse any released refrigerant and preferably expel it externally into the atmosphere.

2-7. Checks to the refrigeration equipment

- Where electrical components are being changed, they shall be fit for the purpose and to the correct specification.
  - At all times the manufacturer's maintenance and service guidelines shall be followed.
  - If in doubt consult the manufacturer's technical department for assistance.
  - The following checks shall be applied to installations using flammable refrigerants.
    - The charge size is in accordance with the room size within which the refrigerant containing parts are installed.
    - The ventilation machinery and outlets are operating adequately and are not obstructed.
    - If an indirect refrigerating circuit is being used, the secondary circuit shall be checked for the presence of refrigerant.
    - Marking to the equipment continues to be visible and legible. Markings and signs that are illegible shall be corrected.
2. - Refrigeration pipe or components are installed in a position where they are unlikely to be exposed to any substance which may corrode refrigerant containing components, unless the components are constructed of materials which are inherently resistant to being corroded or are properly protected against being so corroded.

2-8. Checks to electrical devices

- Repair and maintenance to electrical components shall include initial safety checks and component inspection procedures.
- Initial safety checks shall include but not limit to:-
  - That capacitors are discharged: this shall be done in a safe manner to avoid possibility of sparking.
  - That there is no live electrical components and wiring are exposed while charging, recovering or purging the system.
  - That there is continuity of earth bonding.
- At all times the manufacturer's maintenance and service guidelines shall be followed.
- If in doubt consult the manufacturer's technical department for assistance.
- If a fault exists that could compromise safety, then no electrical supply shall be connected to the circuit until it is satisfactorily dealt with.
- If the fault cannot be corrected immediately but it is necessary to continue operation, an adequate temporary solution shall be used.
- The owner of the equipment must be informed or reported so all parties are advised thereafter.

Repairs to sealed components

- During repairs to sealed components, all electrical supplies shall be disconnected from the equipment being worked upon prior to any removal of sealed covers, etc.
  - If it is absolutely necessary to have an electrical supply to equipment during servicing, then a permanently operating form of leak detection shall be located at the most critical point to warn of a potentially hazardous situation.
  - Particular attention shall be paid to the following to ensure that by working on electrical components, the casing is not altered in such a way that the level of protection is affected. This shall include damage to cables, excessive number of connections, terminals not made to original specification, damage to seals, incorrect fitting of glands, etc.
3. • Ensure that apparatus is mounted securely.
- Ensure that seals or sealing materials have not degraded such that they no longer serve the purpose of preventing the ingress of flammable atmospheres.
  - Replacement parts shall be in accordance with the manufacturer's specifications.
- NOTE: The use of silicon sealant may inhibit the effectiveness of some types of leak detection equipment.  
Intrinsically safe components do not have to be isolated prior to working on them.

Repair to intrinsically safe components

- Do not apply any permanent inductive or capacitance loads to the circuit without ensuring that this will not exceed the permissible voltage and current permitted for the equipment in use.
4. • Intrinsically safe components are the only types that can be worked on while live in the presence of a flammable atmosphere.
- The test apparatus shall be at the correct rating.
  - Replace components only with parts specified by the manufacturer. Unspecified parts by manufacturer may result ignition of refrigerant in the atmosphere from a leak.

Cabling

5. • Check that cabling will not be subject to wear, corrosion, excessive pressure, vibration, sharp edges or any other adverse environmental effects.
- The check shall also take into account the effects of aging or continual vibration from sources such as compressors or fans.

Detection of flammable refrigerants

6. • Under no circumstances shall potential sources of ignition be used in the searching or detection of refrigerant leaks.
- A halide torch (or any other detector using a naked flame) shall not be used.

Leak detection methods

- Electronic leak detectors shall be used to detect flammable refrigerants, but the sensitivity may not be adequate, or may need re-calibration.  
(Detection equipment shall be calibrated in a refrigerant-free area.)
7. • Ensure that the detector is not a potential source of ignition and is suitable for the refrigerant used.
- Leak detection equipment shall be set at a percentage of the LFL of the refrigerant and shall be calibrated to the refrigerant employed and the appropriate percentage of gas (25 % maximum) is confirmed.
  - Leak detection fluids are suitable for use with most refrigerants but the use of detergents containing chlorine shall be avoided as the chlorine may react with the refrigerant and corrode the copper pipe-work.
  - If a leak is suspected, all naked flames shall be removed/extinguished.
  - If a leakage of refrigerant is found which requires brazing, all of the refrigerant shall be recovered from the system, or isolated (by means of shut off valves) in a part of the system remote from the leak. Oxygen free nitrogen (OFN) shall then be purged through the system both before and during the brazing process.

 CAUTION

Removal and evacuation

• When breaking into the refrigerant circuit to make repairs – or for any other purpose – conventional procedures shall be used. However, it is important that best practice is followed since flammability is a consideration. The following procedure shall be adhered to:

- remove refrigerant -> • purge the circuit with inert gas -> • evacuate -> • purge again with inert gas -> • open the circuit by cutting or brazing
  - The refrigerant charge shall be recovered into the correct recovery cylinders.
  - The system shall be “flushed” with OFN to render the unit safe.
- 8.
- This process may need to be repeated several times.
  - Compressed air or oxygen shall not be used for this task.
  - Flushing shall be achieved by breaking the vacuum in the system with OFN and continuing to fill until the working pressure is achieved, then venting to atmosphere, and finally pulling down to a vacuum.
  - This process shall be repeated until no refrigerant is within the system.
  - When the final OFN charge is used, the system shall be vented down to atmospheric pressure to enable work to take place.
  - This operation is absolutely vital if brazing operations on the pipe work are to take place.
  - Ensure that the outlet for the vacuum pump is not close to any ignition sources and there is ventilation available.

Charging procedures

- 9.
- In addition to conventional charging procedures, the following requirements shall be followed.
    - Ensure that contamination of different refrigerants does not occur when using charging equipment.
    - Hoses or lines shall be as short as possible to minimize the amount of refrigerant contained in them.
    - Cylinders shall be kept upright.
    - Ensure that the refrigeration system is earthed prior to charging the system with refrigerant.
    - Label the system when charging is complete (if not already).
  - Extreme care shall be taken not to over fill the refrigeration system.
  - Prior to recharging the system it shall be pressure tested with OFN (refer to #7).
  - The system shall be leak tested on completion of charging but prior to commissioning.
  - A follow up leak test shall be carried out prior to leaving the site.
  - Electrostatic charge may accumulate and create a hazardous condition when charging and discharging the refrigerant. To avoid fire or explosion, dissipate static electricity during transfer by grounding and bonding containers and equipment before charging/discharging.

Decommissioning

- Before carrying out this procedure, it is essential that the technician is completely familiar with the equipment and all its details.
- It is recommended good practice that all refrigerants are recovered safely.
- Prior to the task being carried out, an oil and refrigerant sample shall be taken in case analysis is required prior to re-use of reclaimed refrigerant.
- It is essential that electrical power is available before the task is commenced.
  - a) Become familiar with the equipment and its operation.
  - b) Isolate system electrically.
  - c) Before attempting the procedure ensure that:
    - mechanical handling equipment is available, if required, for handling refrigerant cylinders;
    - all personal protective equipment is available and being used correctly;
    - the recovery process is supervised at all times by a competent person;
    - recovery equipment and cylinders conform to the appropriate standards.
  - d) Pump down refrigerant system, if possible.
  - e) If a vacuum is not possible, make a manifold so that refrigerant can be removed from various parts of the system.
    - Electrostatic charge may accumulate and create a hazardous condition when charging or discharging the refrigerant. To avoid fire or explosion, dissipate static electricity during transfer by grounding and bonding containers and equipment before charging/discharging.
  - f) Make sure that cylinder is situated on the scales before recovery takes place.
  - g) Start the recovery machine and operate in accordance with manufacturer’s instructions.
  - h) Do not over fill cylinders. (No more than 80 % volume liquid charge).
  - i) Do not exceed the maximum working pressure of the cylinder, even temporarily.
  - j) When the cylinders have been filled correctly and the process completed, make sure that the cylinders and the equipment are removed from site promptly and all isolation valves on the equipment are closed off.
  - k) Recovered refrigerant shall not be charged into another refrigeration system unless it has been cleaned and checked.

Labelling

- 11.
- Equipment shall be labelled stating that it has been de-commissioned and emptied of refrigerant.
  - The label shall be dated and signed.
  - Ensure that there are labels on the equipment stating the equipment contains flammable refrigerant.

 **CAUTION**

**Recovery**

- When removing refrigerant from a system, either for servicing or decommissioning, it is recommended good practice that all refrigerants are removed safely.
- When transferring refrigerant into cylinders, ensure that only appropriate refrigerant recovery cylinders are employed.
- Ensure that the correct number of cylinders for holding the total system charge are available.
- All cylinders to be used are designated for the recovered refrigerant and labelled for that refrigerant (i.e. special cylinders for the recovery of refrigerant).
- Cylinders shall be complete with pressure relief valve and associated shut-off valves in good working order.
- Recovery cylinders are evacuated and, if possible, cooled before recovery occurs.
- The recovery equipment shall be in good working order with a set of instructions concerning the equipment that is at hand and shall be suitable for the recovery of flammable refrigerants.
- 12. • In addition, a set of calibrated weighing scales shall be available and in good working order.
- Hoses shall be complete with leak-free disconnect couplings and in good condition.
- Before using the recovery machine, check that it is in satisfactory working order, has been properly maintained and that any associated electrical components are sealed to prevent ignition in the event of a refrigerant release. Consult manufacturer if in doubt.
- The recovered refrigerant shall be returned to the refrigerant supplier in the correct recovery cylinder, and the relevant Waste Transfer Note arranged.
- Do not mix refrigerants in recovery units and especially not in cylinders.
- If compressors or compressor oils are to be removed, ensure that they have been evacuated to an acceptable level to make certain that flammable refrigerant does not remain within the lubricant.
- The evacuation process shall be carried out prior to returning the compressor to the suppliers.
- Only electric heating to the compressor body shall be employed to accelerate this process.
- When oil is drained from a system, it shall be carried out safely.

## 3. Specifications

### 3.1 CU-4Z80TBE

Item		Unit	OUTDOOR UNIT		
Indoor Unit Combination			2.0kW + 2.0kW + 2.0kW + 2.0kW		
Power Source			1 Phase, 230V, 50Hz (Power supply from outdoor unit)		
Cooling Operation	Capacity		kW	8.0 (3.0 ~ 9.2)	
			BTU/h	27300 (10200 ~ 31400)	
	Electrical Data	Running Current		A	9.5
		Power Input		kW	1.98 (0.53 ~ 2.87)
		EER		W/W	4.04 (5.66 ~ 3.21)
		ERP	Pdesign	kW	8.0
			SEER	W/W	7.9
	Annual Consumption		kWh	354	
	Power Factor		%	91	
	Noise		Sound Pressure Level	dB-A (H/L)	50 / -
		Sound Power Level	dB (H/L)	67 / -	
Heating Operation	Capacity		kW	9.4 (4.2 ~ 10.6)	
			BTU/h	32100 (14300 ~ 36100)	
	Electrical Data	Running Current		A	9.5
		Power Input		kW	2.03 (0.70 ~ 3.06)
		EER		W/W	4.63 (6.00 ~ 3.46)
		ERP	Pdesign	kW	6.8
			SCOP	W/W	4.7
	Annual Consumption		kWh	2026	
	Power Factor		%	93	
	Noise		Sound Pressure Level	dB-A (H/L)	52 / -
		Sound Power Level	dB (H/L)	68 / -	
Maximum Current		A	19.0		
Maximum Input Power		kW	4.33		
Starting Current		A	9.5		
Circuit Breaker Capacity		A	20		
Dimension	Height		mm	999	
	Width		mm	940	
	Depth		mm	340	
Net Weight		kg	80		
Connection Cable			4 x Ø1.5mm <sup>2</sup>		
Pipe Length Range (1 room)		m	3 ~ 25		
Maximum Pipe Length (Total Room)		m	70		
Refrigerant Pipe Diameter	Liquid Side		mm (inch)	6.35 (1/4)	
	Gas Side		mm (inch)	9.52 (3/8) [Z71TK : 12.7 (1/2)]	
Compressor	Type			Hermetic Motor / Rotary	
	Motor Type			Brushless (4-poles)	
	Rated Output		W	1.70k	
Fan Motor	Type			Propeller Fan	
	Motor Type			DC Motor (8-poles)	
	Rated Output		W	90	

Item		Unit	OUTDOOR UNIT		
Fan Speed	High (Cooling / Heating)	RPM	600 / 600		
Heat Exchanger	Type		Plate fin configuration forced draft type		
	Tube Material		Copper		
	Fin Material		Aluminum (Pre Coat)		
	Row / Stage		2 / 46		
	FPI		19		
Air Volume	High (Cooling / Heating)	m <sup>3</sup> /min (ft <sup>3</sup> /min)	50.4 (1780) / 55.6 (1960)		
Refrigerant Control Device			Expansion Valve		
Refrigerant Oil			FW50S (900cm <sup>3</sup> )		
Refrigerant (R32)		g	2.72k		
			Dry Bulb	Wet Bulb	
Indoor Operation Range	Cooling	Maximum	°C (°F)	32 (89.6)	23 (73.4)
		Minimum	°C (°F)	16 (60.8)	11 (51.8)
	Heating	Maximum	°C (°F)	30 (86.0)	-
		Minimum	°C (°F)	16 (60.8)	-
Indoor Operation Range	Cooling	Maximum	°C (°F)	46 (114.8)	26 (78.8)
		Minimum	°C (°F)	-10 (14.0)	-
	Heating	Maximum	°C (°F)	24 (75.2)	18 (64.4)
		Minimum	°C (°F)	-15 (5.0)	-16 (3.2)

**Note**

- Specifications are subject to change without notice for further improvement.

### 3.2 CU-5Z90TBE

Item		Unit	OUTDOOR UNIT			
Indoor Unit Combination			1.6kW + 1.6kW + 1.6kW + 1.6kW + 2.5kW			
Power Source			1 Phase, 230V, 50Hz (Power supply from outdoor unit)			
Cooling Operation	Capacity		kW	9.0 (2.9 ~ 11.5)		
			BTU/h	30700 (9890 ~ 39200)		
	Electrical Data	Running Current		A	10.5	
		Power Input		kW	2.20 (0.55 ~ 3.86)	
		EER		W/W	4.09 (5.27 ~ 2.98)	
		ERP	Pdesign		kW	9.0
			SEER		W/W	8.5
			Annual Consumption		kWh	371
	Power Factor		%	91		
	Noise	Sound Pressure Level		dB-A (H/L)	53 / -	
Sound Power Level		dB (H/L)	69 / -			
Heating Operation	Capacity		kW	10.4 (3.4 ~ 14.5)		
			BTU/h	35500 (11600 ~ 49400)		
	Electrical Data	Running Current		A	10.1	
		Power Input		kW	2.15 (0.53 ~ 4.24)	
		EER		W/W	4.84 (6.42 ~ 3.42)	
		ERP	Pdesign		kW	8.5
			SCOP		W/W	4.68
			Annual Consumption		kWh	2543
	Power Factor		%	93		
	Noise	Sound Pressure Level		dB-A (H/L)	54 / -	
Sound Power Level		dB (H/L)	70 / -			
Maximum Current		A	21.3			
Maximum Input Power		kW	4.84			
Starting Current		A	10.5			
Circuit Breaker Capacity		A	25			
Dimension	Height		mm	999		
	Width		mm	940		
	Depth		mm	340		
Net Weight		kg	81			
Connection Cable			4 x Ø1.5mm <sup>2</sup>			
Pipe Length Range (1 room)		m	3 ~ 25			
Maximum Pipe Length (Total Room)		m	80			
Refrigerant Pipe Diameter	Liquid Side		mm (inch)	6.35 (1/4)		
	Gas Side		mm (inch)	9.52 (3/8) [Z71TK : 12.7 (1/2)]		
Compressor	Type			Hermetic Motor / Rotary		
	Motor Type			Brushless (4-poles)		
	Rated Output		W	1.7k		
Fan Motor	Type			Propeller Fan		
	Motor Type			DC Motor (8-poles)		
	Rated Output		W	90		



Item		Unit	OUTDOOR UNIT		
Fan Speed	High (Cooling / Heating)	RPM	650 / 740		
Heat Exchanger	Type		Plate fin configuration forced draft type		
	Tube Material		Copper		
	Fin Material		Aluminum (Pre Coat)		
	Row / Stage		2 / 46		
	FPI		19		
Air Volume	High (Cooling / Heating)	m <sup>3</sup> /min (ft <sup>3</sup> /min)	60.8 (2145) / 70.1 (2475)		
Refrigerant Control Device			Expansion Valve		
Refrigerant Oil			FW50S (900cm <sup>3</sup> )		
Refrigerant (R32)		g	2.72k		
			Dry Bulb	Wet Bulb	
Indoor Operation Range	Cooling	Maximum	°C (°F)	32 (89.6)	23 (73.4)
		Minimum	°C (°F)	16 (60.8)	11 (51.8)
	Heating	Maximum	°C (°F)	30 (86.0)	-
		Minimum	°C (°F)	16 (60.8)	-
Outdoor Operation Range	Cooling	Maximum	°C (°F)	46 (114.8)	26 (78.8)
		Minimum	°C (°F)	-10 (14.0)	-
	Heating	Maximum	°C (°F)	24 (75.2)	18 (64.4)
		Minimum	°C (°F)	-15 (5.0)	-16 (3.2)

**Note**

- Specifications are subject to change without notice for further improvement.

- **Multi Split Combination Possibility:**

- A single outdoor unit enables air conditioning of up to four separate rooms for CU-4Z80TBE.

CONNECTABLE INDOOR UNIT		OUTDOOR UNIT				
		CU-4Z80TBE				
ROOM		A	B	C	D	
Wall	1.6kW	CS-MZ16TKE CS-MTZ16TKE	•	•	•	•
	2.0kW	CS-Z20TKEW CS-XZ20TKEW CS-TZ20TKEW CS-TE20TKEW	•	•	•	•
	2.5kW	CS-Z25TKEW CS-XZ25TKEW CS-TZ25TKEW CS-TE25TKEW CS-E9PD3EA CS-E9PB4EA	•	•	•	•
	3.5kW	CS-Z35TKEW CS-XZ35TKEW CS-TZ35TKEW CS-TE35TKEW CS-E12QD3EAW CS-E12PB4EA	•	•	•	•
	4.2kW	CS-Z42TKEW CS-TZ42TKEW CS-TE42TKEW	•	•	•	-
	5.0kW	CS-Z50TKEW CS-XZ50TKEW CS-TZ50TKEW CS-TE50TKEW CS-E18RD3EAW CS-E18RB4EAW	•	•	-	-
	6.0kW	CS-TZ60TKEW CS-TE60TKEW CS-E21RB4EAW	•	•	-	-
	7.0kW	CS-Z71TKEW CS-TZ71TKEW	•	•	-	-
Capacity range of connectable indoor units		4.5kW ~ 14.7kW				
Pipe length	1-room maximum pipe length (m)		25			
	Allowable elevation (m)		15			
	Total allowable pipe length (m)		70			
	Total pipe length for maximum chargeless length (m)		45			
	Additional gas amount over chargeless length (g/m)		20			
Note: "•" : Available						
<b>Remarks for CU-4Z80TBE</b>						
1. At least two indoor unit must be connected.						
2. The total nominal cooling capacity of indoor unit that will be connected to outdoor unit must be within connectable capacity range of indoor unit. (as shown in the table above) Example: The indoor units' combination below is possible to CU-4Z80TBE. (Total nominal capacity of indoor units is between 4.5kW to 14.7kW)						
1) Two CS-Z25TKEW only. (Total nominal cooling capacity is 5.0kW)						
2) Three CS-Z35TKEW only. (Total nominal cooling capacity is 10.5kW)						

- A single outdoor unit enables air conditioning of up to five separate rooms for CU-5Z90TBE.

CONNECTABLE INDOOR UNIT			OUTDOOR UNIT				
			CU-5Z90TBE				
ROOM			A	B	C	D	E
Wall	1.6kW	CS-MZ16TKE CS-MTZ16TKE	•	•	•	•	•
	2.0kW	CS-Z20TKEW CS-XZ20TKEW CS-TZ20TKEW CS-TE20TKEW	•	•	•	•	•
	2.5kW	CS-Z25TKEW CS-XZ25TKEW CS-TZ25TKEW CS-TE25TKEW CS-E9PD3EA CS-E9PB4EA	•	•	•	•	•
	3.5kW	CS-Z35TKEW CS-XZ35TKEW CS-TZ35TKEW CS-TE35TKEW CS-E12QD3EAW CS-E12PB4EA	•	•	•	•	•
	4.2kW	CS-Z42TKEW CS-TZ42TKEW CS-TE42TKEW	•	•	•	•	-
	5.0kW	CS-Z50TKEW CS-XZ50TKEW CS-TZ50TKEW CS-TE50TKEW CS-E18RD3EAW CS-E18RB4EAW	•	•	•	-	-
	6.0kW	CS-TZ60TKEW CS-TE60TKEW CS-E21RB4EAW	•	•	•	-	-
	7.0kW	CS-Z71TKEW CS-TZ71TKEW	•	•	-	-	-
Capacity range of connectable indoor units			4.5kW ~ 18.3kW				
Pipe length	1-room maximum pipe length (m)		25				
	Allowable elevation (m)		15				
	Total allowable pipe length (m)		80				
	Total pipe length for maximum chargeless length (m)		45				
	Additional gas amount over chargeless length (g/m)		20				
Note: "•" : Available							
<b>Remarks for CU-5Z90TBE</b>							
<ol style="list-style-type: none"> <li>At least two indoor unit must be connected.</li> <li>The total nominal cooling capacity of indoor unit that will be connected to outdoor unit must be within connectable capacity range of indoor unit. (as shown in the table above)  Example: The indoor units' combination below is possible to CU-5Z90TBE.  (Total nominal capacity of indoor units is between 4.5kW to 18.3kW)  1) Two CS-Z25TKEW only. (Total nominal cooling capacity is 5.0kW)  2) Three CS-Z42TKEW only. (Total nominal cooling capacity is 12.6kW)</li> </ol>							

- Indoor Unit : CS-MZ / Z / XZ wall mount series
- Outdoor Unit : CU-4Z80TBE

Indoor unit capacity Cooling	Total	Cooling Capacity (kW)						Input Power (W)		EER		
		Room A	Room B	Room C	Room D	Total	min ~ max	Rating	min ~ max	W/W	CLASS	
1 Room	1.6	1.6	1.60				1.60	1.3 0.0 2.3	400	250 ~ 640	4.00	A
	2.0	2.0	2.00				2.00	1.8 ~ 2.9	500	340 ~ 810	4.00	A
	2.5	2.5	2.50				2.50	1.8 ~ 2.9	630	340 ~ 810	3.97	A
	3.5	3.5	3.50				3.50	1.8 ~ 4.1	940	340 ~ 1360	3.72	A
	4.2	4.2	4.20				4.20	1.8 ~ 4.5	1370	340 ~ 1990	3.07	B
	5.0	5.0	5.00				5.00	1.9 ~ 5.7	1550	340 ~ 2130	3.23	A
	6.0	6.0	6.00				6.00	1.9 ~ 6.2	2030	340 ~ 2330	2.96	C
	7.1	7.1	7.10				7.10	2.0 ~ 7.2	2530	370 ~ 2770	2.81	C
2 Room	1.6 + 1.6	3.2	1.60	1.60			3.20	2.4 ~ 5.8	730	380 ~ 1990	4.38	A
	1.6 + 2.0	3.6	1.60	2.00			3.60	2.4 ~ 5.8	870	380 ~ 1990	4.14	A
	1.6 + 2.5	4.1	1.60	2.50			4.10	2.4 ~ 5.8	1070	380 ~ 1990	3.83	A
	1.6 + 3.5	5.1	1.60	3.50			5.10	2.4 ~ 5.8	1480	370 ~ 1920	3.45	A
	1.6 + 4.2	5.8	1.60	4.20			5.80	2.4 ~ 6.7	1820	370 ~ 2480	3.19	B
	1.6 + 5.0	6.6	1.60	5.00			6.60	2.4 ~ 7.2	2060	350 ~ 2480	3.20	A
	1.6 + 6.0	7.6	1.60	6.00			7.60	2.4 ~ 8.5	2690	350 ~ 3490	2.83	C
	1.6 + 7.1	8.7	1.47	6.53			8.00	2.5 ~ 8.5	2840	380 ~ 3340	2.82	C
	2.0 + 2.0	4.0	2.00	2.00			4.00	2.4 ~ 5.8	1010	380 ~ 1930	3.96	A
	2.0 + 2.5	4.5	2.00	2.50			4.50	2.4 ~ 5.8	1240	380 ~ 1930	3.63	A
	2.0 + 3.5	5.5	2.00	3.50			5.50	2.4 ~ 5.8	1650	370 ~ 1860	3.33	A
	2.0 + 4.2	6.2	2.00	4.20			6.20	2.4 ~ 7.2	2070	370 ~ 2900	3.00	C
	2.0 + 5.0	7.0	2.00	5.00			7.00	2.4 ~ 8.1	2210	350 ~ 3100	3.17	B
	2.0 + 6.0	8.0	2.00	6.00			8.00	2.4 ~ 8.5	2910	350 ~ 3490	2.75	D
	2.0 + 7.1	9.1	1.76	6.24			8.00	2.5 ~ 8.5	2770	380 ~ 3340	2.89	C
	2.5 + 2.5	5.0	2.50	2.50			5.00	2.4 ~ 5.8	1430	380 ~ 1930	3.50	A
	2.5 + 3.5	6.0	2.50	3.50			6.00	2.4 ~ 6.7	1940	370 ~ 2480	3.09	B
	2.5 + 4.2	6.7	2.50	4.20			6.70	2.4 ~ 7.2	2410	370 ~ 2900	2.78	D
	2.5 + 5.0	7.5	2.50	5.00			7.50	2.4 ~ 8.5	2550	350 ~ 3490	2.94	C
	2.5 + 6.0	8.5	2.35	5.65			8.00	2.5 ~ 8.5	2910	390 ~ 3490	2.75	D
	2.5 + 7.1	9.6	2.08	5.92			8.00	2.5 ~ 8.5	2770	380 ~ 3340	2.89	C
	3.5 + 3.5	7.0	3.50	3.50			7.00	2.4 ~ 8.1	2550	370 ~ 3630	2.75	D
	3.5 + 4.2	7.7	3.50	4.20			7.70	2.4 ~ 8.5	3040	370 ~ 4120	2.53	E
	3.5 + 5.0	8.5	3.29	4.71			8.00	2.5 ~ 8.5	2770	380 ~ 3340	2.89	C
	3.5 + 6.0	9.5	2.95	5.05			8.00	2.5 ~ 8.5	2770	380 ~ 3340	2.89	C
	3.5 + 7.1	10.6	2.64	5.36			8.00	2.5 ~ 8.6	2700	380 ~ 3340	2.96	C
	4.2 + 4.2	8.4	4.00	4.00			8.00	2.5 ~ 8.5	3340	400 ~ 4040	2.40	F
4.2 + 5.0	9.2	3.65	4.35			8.00	2.5 ~ 8.5	2770	380 ~ 3340	2.89	C	
4.2 + 6.0	10.2	3.29	4.71			8.00	2.5 ~ 8.6	2770	380 ~ 3420	2.89	C	
4.2 + 7.1	11.3	2.97	5.03			8.00	2.5 ~ 8.6	2700	380 ~ 3260	2.96	C	
5.0 + 5.0	10.0	4.00	4.00			8.00	2.5 ~ 8.6	2420	380 ~ 2950	3.31	A	
5.0 + 6.0	11.0	3.64	4.36			8.00	2.5 ~ 8.6	2420	380 ~ 2950	3.31	A	
5.0 + 7.1	12.1	3.31	4.69			8.00	2.5 ~ 8.6	2350	380 ~ 2880	3.40	A	
6.0 + 6.0	12.0	4.00	4.00			8.00	2.5 ~ 8.6	2420	380 ~ 2950	3.31	A	
6.0 + 7.1	13.1	3.66	4.34			8.00	2.5 ~ 8.6	2350	380 ~ 2880	3.40	A	
7.1 + 7.1	14.2	4.00	4.00			8.00	2.5 ~ 8.6	2280	410 ~ 2800	3.51	A	

	Indoor unit capacity Cooling	Annual Energy Consumption (kWh)	Current 230V (A)	ERP				Moisture Removal Volume l/h
				Pdesign (kW)	SEER		Annual Consumption (kWh)	
					WW	CLASS		
1 Room	1.6	200	2.0	-	-	-	-	1.0
	2.0	250	2.5	-	-	-	-	1.3
	2.5	315	3.2	-	-	-	-	1.5
	3.5	470	4.5	-	-	-	-	2.0
	4.2	685	6.4	-	-	-	-	2.4
	5.0	775	7.2	-	-	-	-	2.7
	6.0	1015	9.2	-	-	-	-	3.3
	7.1	1265	11.4	-	-	-	-	4.1
2 Room	1.6 + 1.6	365	3.7	3.20	5.60	A+	200	1.0 + 1.0
	1.6 + 2.0	435	4.3	3.60	5.60	A+	225	1.0 + 1.3
	1.6 + 2.5	535	5.2	4.10	5.60	A+	256	1.0 + 1.5
	1.6 + 3.5	740	7.2	5.10	5.60	A+	319	1.0 + 2.0
	1.6 + 4.2	910	8.7	5.80	5.60	A+	363	1.0 + 2.4
	1.6 + 5.0	1030	9.9	6.60	6.10	A++	379	1.0 + 2.7
	1.6 + 6.0	1345	12.9	7.60	6.10	A++	436	1.0 + 3.3
	1.6 + 7.1	1420	13.6	8.00	6.10	A++	459	0.9 + 3.7
	2.0 + 2.0	505	5.0	4.00	5.60	A+	250	1.3 + 1.3
	2.0 + 2.5	620	6.0	4.50	5.60	A+	281	1.3 + 1.5
	2.0 + 3.5	825	8.0	5.50	5.60	A+	344	1.3 + 2.0
	2.0 + 4.2	1035	9.9	6.20	5.60	A+	388	1.3 + 2.4
	2.0 + 5.0	1105	10.6	7.00	6.10	A++	402	1.3 + 2.7
	2.0 + 6.0	1455	13.9	8.00	6.10	A++	459	1.3 + 3.3
	2.0 + 7.1	1385	13.3	8.00	6.10	A++	459	1.1 + 3.5
	2.5 + 2.5	715	6.9	5.00	5.60	A+	313	1.5 + 1.5
	2.5 + 3.5	970	9.3	6.00	5.60	A+	375	1.5 + 2.0
	2.5 + 4.2	1205	11.5	6.70	5.60	A+	419	1.5 + 2.4
	2.5 + 5.0	1275	12.2	7.50	6.10	A++	430	1.5 + 2.7
	2.5 + 6.0	1455	13.9	8.00	6.10	A++	459	1.5 + 3.1
	2.5 + 7.1	1385	13.3	8.00	6.10	A++	459	1.3 + 3.3
	3.5 + 3.5	1275	12.2	7.00	5.60	A+	438	2.0 + 2.0
	3.5 + 4.2	1520	14.6	7.70	5.60	A+	481	2.0 + 2.4
	3.5 + 5.0	1385	13.3	8.00	6.10	A++	459	1.9 + 2.5
	3.5 + 6.0	1385	13.3	8.00	6.10	A++	459	1.7 + 2.8
	3.5 + 7.1	1350	12.9	8.00	6.10	A++	459	1.6 + 2.9
	4.2 + 4.2	1670	16.0	8.00	5.60	A+	500	2.3 + 2.3
	4.2 + 5.0	1385	13.3	8.00	6.10	A++	459	2.1 + 2.4
	4.2 + 6.0	1385	13.3	8.00	6.10	A++	459	1.9 + 2.5
	4.2 + 7.1	1350	12.9	8.00	6.10	A++	459	1.7 + 2.8
5.0 + 5.0	1210	11.6	8.00	6.10	A++	459	2.3 + 2.3	
5.0 + 6.0	1210	11.6	8.00	6.10	A++	459	2.1 + 2.4	
5.0 + 7.1	1175	11.2	8.00	6.10	A++	459	1.9 + 2.5	
6.0 + 6.0	1210	11.6	8.00	6.10	A++	459	2.3 + 2.3	
6.0 + 7.1	1175	11.2	8.00	6.10	A++	459	2.1 + 2.4	
7.1 + 7.1	1140	10.9	8.00	6.10	A++	459	2.3 + 2.3	

Indoor unit capacity Cooling	Total	Cooling Capacity (kW)						Input Power (W)		EER	
		Room A	Room B	Room C	Room D	Total	min ~ max	Rating	min ~ max	W/W	CLASS
1.6 + 1.6 + 1.6	4.8	1.60	1.60	1.60		4.80	3.0 ~ 8.5	1080	490 ~ 3110	4.44	A
1.6 + 1.6 + 2.0	5.2	1.60	1.60	2.00		5.20	3.0 ~ 8.5	1180	490 ~ 3110	4.41	A
1.6 + 1.6 + 2.5	5.7	1.60	1.60	2.50		5.70	3.0 ~ 8.5	1390	490 ~ 3110	4.10	A
1.6 + 1.6 + 3.5	6.7	1.60	1.60	3.50		6.70	3.0 ~ 8.5	1710	480 ~ 3030	3.92	A
1.6 + 1.6 + 4.2	7.4	1.60	1.60	4.20		7.40	3.0 ~ 8.5	2070	480 ~ 2950	3.57	A
1.6 + 1.6 + 5.0	8.2	1.56	1.56	4.88		8.00	3.0 ~ 8.6	2100	520 ~ 2730	3.81	A
1.6 + 1.6 + 6.0	9.2	1.39	1.39	5.22		8.00	3.0 ~ 8.6	2100	520 ~ 2730	3.81	A
1.6 + 1.6 + 7.1	10.3	1.24	1.24	5.52		8.00	3.0 ~ 8.8	2040	520 ~ 2800	3.92	A
1.6 + 2.0 + 2.0	5.6	1.60	2.00	2.00		5.60	3.0 ~ 8.5	1340	490 ~ 3030	4.18	A
1.6 + 2.0 + 2.5	6.1	1.60	2.00	2.50		6.10	3.0 ~ 8.5	1550	490 ~ 3030	3.94	A
1.6 + 2.0 + 3.5	7.1	1.60	2.00	3.50		7.10	3.0 ~ 8.5	1880	480 ~ 2950	3.78	A
1.6 + 2.0 + 4.2	7.8	1.60	2.00	4.20		7.80	3.0 ~ 8.5	2170	480 ~ 2950	3.59	A
1.6 + 2.0 + 5.0	8.6	1.49	1.86	4.65		8.00	3.0 ~ 8.6	2100	520 ~ 2730	3.81	A
1.6 + 2.0 + 6.0	9.6	1.33	1.67	5.00		8.00	3.0 ~ 8.6	2100	520 ~ 2730	3.81	A
1.6 + 2.0 + 7.1	10.7	1.20	1.50	5.30		8.00	3.0 ~ 8.8	2040	520 ~ 2800	3.92	A
1.6 + 2.5 + 2.5	6.6	1.60	2.50	2.50		6.60	3.0 ~ 8.5	1790	490 ~ 3030	3.69	A
1.6 + 2.5 + 3.5	7.6	1.60	2.50	3.50		7.60	3.0 ~ 8.5	2190	480 ~ 2950	3.47	A
1.6 + 2.5 + 4.2	8.3	1.54	2.41	4.05		8.00	3.0 ~ 8.6	2290	480 ~ 3030	3.49	A
1.6 + 2.5 + 5.0	9.1	1.41	2.20	4.39		8.00	3.0 ~ 8.6	2100	520 ~ 2730	3.81	A
1.6 + 2.5 + 6.0	10.1	1.27	1.98	4.75		8.00	3.0 ~ 8.8	2100	520 ~ 2800	3.81	A
1.6 + 2.5 + 7.1	11.2	1.14	1.79	5.07		8.00	3.0 ~ 8.8	2040	520 ~ 2800	3.92	A
1.6 + 3.5 + 3.5	8.6	1.48	3.26	3.26		8.00	3.0 ~ 8.6	2230	480 ~ 2950	3.59	A
1.6 + 3.5 + 4.2	9.3	1.38	3.01	3.61		8.00	3.0 ~ 8.6	2230	480 ~ 2950	3.59	A
1.6 + 3.5 + 5.0	10.1	1.27	2.77	3.96		8.00	3.0 ~ 8.8	2040	520 ~ 2800	3.92	A
1.6 + 3.5 + 6.0	11.1	1.15	2.52	4.33		8.00	3.0 ~ 8.8	2040	520 ~ 2800	3.92	A
1.6 + 3.5 + 7.1	12.2	1.05	2.30	4.65		8.00	3.0 ~ 9.0	2040	520 ~ 2870	3.92	A
1.6 + 4.2 + 4.2	10.0	1.28	3.36	3.36		8.00	3.0 ~ 8.8	2230	480 ~ 3100	3.59	A
1.6 + 4.2 + 5.0	10.8	1.19	3.11	3.70		8.00	3.0 ~ 8.8	2040	520 ~ 2800	3.92	A
1.6 + 4.2 + 6.0	11.8	1.08	2.85	4.07		8.00	3.0 ~ 9.0	2040	520 ~ 2870	3.92	A
1.6 + 4.2 + 7.1	12.9	0.99	2.60	4.41		8.00	3.0 ~ 9.0	1980	520 ~ 2800	4.04	A
1.6 + 5.0 + 5.0	11.6	1.10	3.45	3.45		8.00	3.0 ~ 8.8	1920	570 ~ 2580	4.17	A
1.6 + 5.0 + 6.0	12.6	1.02	3.17	3.81		8.00	3.0 ~ 9.0	1920	570 ~ 2650	4.17	A
1.6 + 5.0 + 7.1	13.7	0.93	2.92	4.15		8.00	3.0 ~ 9.0	1920	570 ~ 2650	4.17	A
1.6 + 6.0 + 6.0	13.6	0.94	3.53	3.53		8.00	3.0 ~ 9.0	1920	570 ~ 2650	4.17	A
1.6 + 6.0 + 7.1	14.7	0.87	3.27	3.86		8.00	3.0 ~ 9.0	1920	570 ~ 2650	4.17	A
2.0 + 2.0 + 2.0	6.0	2.00	2.00	2.00		6.00	3.0 ~ 8.5	1500	480 ~ 3030	4.00	A
2.0 + 2.0 + 2.5	6.5	2.00	2.00	2.50		6.50	3.0 ~ 8.5	1730	480 ~ 3030	3.76	A
2.0 + 2.0 + 3.5	7.5	2.00	2.00	3.50		7.50	3.0 ~ 8.5	2060	480 ~ 2950	3.64	A
2.0 + 2.0 + 4.2	8.2	1.95	1.95	4.10		8.00	3.0 ~ 8.6	2290	480 ~ 3030	3.49	A
2.0 + 2.0 + 5.0	9.0	1.78	1.78	4.44		8.00	3.0 ~ 8.6	2040	520 ~ 2650	3.92	A
2.0 + 2.0 + 6.0	10.0	1.60	1.60	4.80		8.00	3.0 ~ 8.8	2040	520 ~ 2800	3.92	A
2.0 + 2.0 + 7.1	11.1	1.44	1.44	5.12		8.00	3.0 ~ 8.8	2040	520 ~ 2720	3.92	A
2.0 + 2.5 + 2.5	7.0	2.00	2.50	2.50		7.00	3.0 ~ 8.5	1890	480 ~ 3030	3.70	A
2.0 + 2.5 + 3.5	8.0	2.00	2.50	3.50		8.00	3.0 ~ 8.6	2290	480 ~ 3030	3.49	A
2.0 + 2.5 + 4.2	8.7	1.84	2.30	3.86		8.00	3.0 ~ 8.6	2290	480 ~ 3030	3.49	A
2.0 + 2.5 + 5.0	9.5	1.68	2.11	4.21		8.00	3.0 ~ 8.6	2040	520 ~ 2650	3.92	A
2.0 + 2.5 + 6.0	10.5	1.52	1.90	4.58		8.00	3.0 ~ 8.8	2040	520 ~ 2800	3.92	A
2.0 + 2.5 + 7.1	11.6	1.38	1.72	4.90		8.00	3.0 ~ 8.8	2040	520 ~ 2720	3.92	A
2.0 + 3.5 + 3.5	9.0	1.78	3.11	3.11		8.00	3.0 ~ 8.6	2230	480 ~ 2950	3.59	A
2.0 + 3.5 + 4.2	9.7	1.65	2.89	3.46		8.00	3.0 ~ 8.6	2230	480 ~ 2950	3.59	A
2.0 + 3.5 + 5.0	10.5	1.52	2.67	3.81		8.00	3.0 ~ 8.8	2040	520 ~ 2800	3.92	A
2.0 + 3.5 + 6.0	11.5	1.39	2.43	4.18		8.00	3.0 ~ 8.8	2040	520 ~ 2800	3.92	A
2.0 + 3.5 + 7.1	12.6	1.27	2.22	4.51		8.00	3.0 ~ 9.0	1980	520 ~ 2800	4.04	A
2.0 + 4.2 + 4.2	10.4	1.54	3.23	3.23		8.00	3.0 ~ 8.8	2230	480 ~ 3030	3.59	A
2.0 + 4.2 + 5.0	11.2	1.43	3.00	3.57		8.00	3.0 ~ 8.8	2040	520 ~ 2720	3.92	A
2.0 + 4.2 + 6.0	12.2	1.31	2.75	3.94		8.00	3.0 ~ 9.0	2040	520 ~ 2870	3.92	A
2.0 + 4.2 + 7.1	13.3	1.20	2.53	4.27		8.00	3.0 ~ 9.0	1980	520 ~ 2800	4.04	A
2.0 + 5.0 + 5.0	12.0	1.33	3.33	3.33		7.99	3.0 ~ 9.0	1920	570 ~ 2650	4.16	A

3 Room

Indoor unit capacity Cooling	Annual Energy Consumption (kWh)	Current 230V (A)	ERP				Moisture Removal Volume l/h
			Pdesign (kW)	SEER		Annual Consumption (kWh)	
				W/W	CLASS		
1.6 + 1.6 + 1.6	540	5.3	4.80	7.40	A++	227	1.0 + 1.0 + 1.0
1.6 + 1.6 + 2.0	590	5.8	5.20	7.40	A++	246	1.0 + 1.0 + 1.3
1.6 + 1.6 + 2.5	695	6.7	5.70	7.40	A++	270	1.0 + 1.0 + 1.5
1.6 + 1.6 + 3.5	855	8.3	6.70	7.40	A++	317	1.0 + 1.0 + 2.0
1.6 + 1.6 + 4.2	1035	9.9	7.40	7.40	A++	350	1.0 + 1.0 + 2.4
1.6 + 1.6 + 5.0	1050	10.1	8.00	7.40	A++	378	1.0 + 1.0 + 2.7
1.6 + 1.6 + 6.0	1050	10.1	8.00	7.40	A++	378	0.9 + 0.9 + 2.9
1.6 + 1.6 + 7.1	1020	9.8	8.00	7.40	A++	378	0.8 + 0.8 + 3.0
1.6 + 2.0 + 2.0	670	6.5	5.60	7.40	A++	265	1.0 + 1.3 + 1.3
1.6 + 2.0 + 2.5	775	7.5	6.10	7.40	A++	289	1.0 + 1.3 + 1.5
1.6 + 2.0 + 3.5	940	9.0	7.10	7.40	A++	336	1.0 + 1.3 + 2.0
1.6 + 2.0 + 4.2	1085	10.4	7.80	7.40	A++	369	1.0 + 1.3 + 2.4
1.6 + 2.0 + 5.0	1050	10.1	8.00	7.40	A++	378	0.9 + 1.2 + 2.5
1.6 + 2.0 + 6.0	1050	10.1	8.00	7.40	A++	378	0.8 + 1.1 + 2.7
1.6 + 2.0 + 7.1	1020	9.8	8.00	7.40	A++	378	0.7 + 1.0 + 2.9
1.6 + 2.5 + 2.5	895	8.6	6.60	7.40	A++	312	1.0 + 1.5 + 1.5
1.6 + 2.5 + 3.5	1095	10.5	7.60	7.40	A++	359	1.0 + 1.5 + 2.0
1.6 + 2.5 + 4.2	1145	11.0	8.00	7.40	A++	378	1.0 + 1.5 + 2.3
1.6 + 2.5 + 5.0	1050	10.1	8.00	7.40	A++	378	0.9 + 1.4 + 2.4
1.6 + 2.5 + 6.0	1050	10.1	8.00	7.40	A++	378	0.8 + 1.3 + 2.6
1.6 + 2.5 + 7.1	1020	9.8	8.00	7.40	A++	378	0.7 + 1.2 + 2.8
1.6 + 3.5 + 3.5	1115	10.7	8.00	7.40	A++	378	0.9 + 1.9 + 1.9
1.6 + 3.5 + 4.2	1115	10.7	8.00	7.40	A++	378	0.9 + 1.7 + 2.1
1.6 + 3.5 + 5.0	1020	9.8	8.00	7.40	A++	378	0.8 + 1.6 + 2.3
1.6 + 3.5 + 6.0	1020	9.8	8.00	7.40	A++	378	0.7 + 1.5 + 2.4
1.6 + 3.5 + 7.1	1020	9.8	8.00	7.40	A++	378	0.7 + 1.5 + 2.5
1.6 + 4.2 + 4.2	1115	10.7	8.00	7.40	A++	378	0.8 + 1.9 + 1.9
1.6 + 4.2 + 5.0	1020	9.8	8.00	7.40	A++	378	0.7 + 1.8 + 2.2
1.6 + 4.2 + 6.0	1020	9.8	8.00	7.40	A++	378	0.7 + 1.7 + 2.3
1.6 + 4.2 + 7.1	990	9.5	8.00	7.40	A++	378	0.7 + 1.6 + 2.4
1.6 + 5.0 + 5.0	960	9.2	8.00	7.40	A++	378	0.7 + 2.0 + 2.0
1.6 + 5.0 + 6.0	960	9.2	8.00	7.40	A++	378	0.7 + 1.8 + 2.2
1.6 + 5.0 + 7.1	960	9.2	8.00	7.40	A++	378	0.7 + 1.7 + 2.4
1.6 + 6.0 + 6.0	960	9.2	8.00	7.40	A++	378	0.7 + 2.0 + 2.0
1.6 + 6.0 + 7.1	960	9.2	8.00	7.40	A++	378	0.7 + 1.9 + 2.3
2.0 + 2.0 + 2.0	750	7.3	6.00	7.40	A++	284	1.3 + 1.3 + 1.3
2.0 + 2.0 + 2.5	865	8.4	6.50	7.40	A++	307	1.3 + 1.3 + 1.5
2.0 + 2.0 + 3.5	1030	9.9	7.50	7.40	A++	355	1.3 + 1.3 + 2.0
2.0 + 2.0 + 4.2	1145	11.0	8.00	7.40	A++	378	1.3 + 1.3 + 2.3
2.0 + 2.0 + 5.0	1020	9.8	8.00	7.40	A++	378	1.1 + 1.1 + 2.5
2.0 + 2.0 + 6.0	1020	9.8	8.00	7.40	A++	378	1.0 + 1.0 + 2.6
2.0 + 2.0 + 7.1	1020	9.8	8.00	7.40	A++	378	0.9 + 0.9 + 2.8
2.0 + 2.5 + 2.5	945	9.0	7.00	7.40	A++	331	1.3 + 1.5 + 1.5
2.0 + 2.5 + 3.5	1145	11.0	8.00	7.40	A++	378	1.3 + 1.5 + 2.0
2.0 + 2.5 + 4.2	1145	11.0	8.00	7.40	A++	378	1.2 + 1.5 + 2.3
2.0 + 2.5 + 5.0	1020	9.8	8.00	7.40	A++	378	1.1 + 1.4 + 2.4
2.0 + 2.5 + 6.0	1020	9.8	8.00	7.40	A++	378	1.0 + 1.2 + 2.5
2.0 + 2.5 + 7.1	1020	9.8	8.00	7.40	A++	378	0.9 + 1.1 + 2.7
2.0 + 3.5 + 3.5	1115	10.7	8.00	7.40	A++	378	1.1 + 1.8 + 1.8
2.0 + 3.5 + 4.2	1115	10.7	8.00	7.40	A++	378	1.1 + 1.7 + 2.0
2.0 + 3.5 + 5.0	1020	9.8	8.00	7.40	A++	378	1.0 + 1.6 + 2.2
2.0 + 3.5 + 6.0	1020	9.8	8.00	7.40	A++	378	0.9 + 1.5 + 2.4
2.0 + 3.5 + 7.1	990	9.5	8.00	7.40	A++	378	0.8 + 1.4 + 2.5
2.0 + 4.2 + 4.2	1115	10.7	8.00	7.40	A++	378	1.0 + 1.8 + 1.8
2.0 + 4.2 + 5.0	1020	9.8	8.00	7.40	A++	378	0.9 + 1.7 + 2.1
2.0 + 4.2 + 6.0	1020	9.8	8.00	7.40	A++	378	0.8 + 1.6 + 2.3
2.0 + 4.2 + 7.1	990	9.5	8.00	7.40	A++	378	0.7 + 1.6 + 2.4
2.0 + 5.0 + 5.0	960	9.2	7.99	7.40	A++	378	0.8 + 1.9 + 1.9

3  
Room

Indoor unit capacity Cooling	Total	Cooling Capacity (kW)						Input Power (W)		EER		
		Room A	Room B	Room C	Room D	Total	min ~ max	Rating	min ~ max	W/W	CLASS	
3 Room	2.0 + 5.0 + 6.0	13.0	1.23	3.08	3.69		8.00	3.0 ~ 9.0	1920	570 ~ 2650	4.17	A
	2.0 + 5.0 + 7.1	14.1	1.13	2.84	4.03		8.00	3.0 ~ 9.0	1920	570 ~ 2650	4.17	A
	2.0 + 6.0 + 6.0	14.0	1.14	3.43	3.43		8.00	3.0 ~ 9.0	1920	570 ~ 2650	4.17	A
	2.5 + 2.5 + 2.5	7.5	2.50	2.50	2.50		7.50	3.0 ~ 8.5	2130	480 ~ 3030	3.52	A
	2.5 + 2.5 + 3.5	8.5	2.35	2.35	3.30		8.00	3.0 ~ 8.6	2290	480 ~ 3030	3.49	A
	2.5 + 2.5 + 4.2	9.2	2.17	2.17	3.66		8.00	3.0 ~ 8.6	2290	480 ~ 3030	3.49	A
	2.5 + 2.5 + 5.0	10.0	2.00	2.00	4.00		8.00	3.0 ~ 8.8	2040	520 ~ 2800	3.92	A
	2.5 + 2.5 + 6.0	11.0	1.82	1.82	4.36		8.00	3.0 ~ 8.8	2040	520 ~ 2800	3.92	A
	2.5 + 2.5 + 7.1	12.1	1.65	1.65	4.70		8.00	3.0 ~ 9.0	2040	520 ~ 2870	3.92	A
	2.5 + 3.5 + 3.5	9.5	2.10	2.95	2.95		8.00	3.0 ~ 8.6	2230	480 ~ 2950	3.59	A
	2.5 + 3.5 + 4.2	10.2	1.96	2.75	3.29		8.00	3.0 ~ 8.8	2230	480 ~ 3100	3.59	A
	2.5 + 3.5 + 5.0	11.0	1.82	2.55	3.63		8.00	3.0 ~ 8.8	2040	520 ~ 2800	3.92	A
	2.5 + 3.5 + 6.0	12.0	1.67	2.33	4.00		8.00	3.0 ~ 9.0	2040	520 ~ 2870	3.92	A
	2.5 + 3.5 + 7.1	13.1	1.53	2.14	4.33		8.00	3.0 ~ 9.0	1980	520 ~ 2800	4.04	A
	2.5 + 4.2 + 4.2	10.9	1.84	3.08	3.08		8.00	3.0 ~ 8.8	2230	480 ~ 3030	3.59	A
	2.5 + 4.2 + 5.0	11.7	1.71	2.87	3.42		8.00	3.0 ~ 8.8	2040	520 ~ 2720	3.92	A
	2.5 + 4.2 + 6.0	12.7	1.57	2.65	3.78		8.00	3.0 ~ 9.0	2040	520 ~ 2870	3.92	A
	2.5 + 4.2 + 7.1	13.8	1.45	2.43	4.12		8.00	3.0 ~ 9.0	1980	520 ~ 2800	4.04	A
	2.5 + 5.0 + 5.0	12.5	1.60	3.20	3.20		8.00	3.0 ~ 9.0	1920	570 ~ 2650	4.17	A
	2.5 + 5.0 + 6.0	13.5	1.48	2.96	3.56		8.00	3.0 ~ 9.0	1920	570 ~ 2650	4.17	A
	2.5 + 5.0 + 7.1	14.6	1.37	2.74	3.89		8.00	3.0 ~ 9.0	1920	570 ~ 2650	4.17	A
	2.5 + 6.0 + 6.0	14.5	1.38	3.31	3.31		8.00	3.0 ~ 9.0	1920	570 ~ 2650	4.17	A
	3.5 + 3.5 + 3.5	10.5	2.66	2.66	2.66		7.98	3.0 ~ 8.8	2170	480 ~ 3030	3.68	A
	3.5 + 3.5 + 4.2	11.2	2.50	2.50	3.00		8.00	3.0 ~ 8.8	2170	480 ~ 3030	3.69	A
	3.5 + 3.5 + 5.0	12.0	2.33	2.33	3.33		7.99	3.0 ~ 9.0	1980	520 ~ 2870	4.04	A
	3.5 + 3.5 + 6.0	13.0	2.15	2.15	3.70		8.00	3.0 ~ 9.0	1980	520 ~ 2870	4.04	A
	3.5 + 3.5 + 7.1	14.1	1.99	1.99	4.02		8.00	3.0 ~ 9.0	1980	520 ~ 2800	4.04	A
	3.5 + 4.2 + 4.2	11.9	2.36	2.82	2.82		8.00	3.0 ~ 9.0	2170	480 ~ 3100	3.69	A
3.5 + 4.2 + 5.0	12.7	2.20	2.65	3.15		8.00	3.0 ~ 9.0	1980	520 ~ 2800	4.04	A	
3.5 + 4.2 + 6.0	13.7	2.04	2.45	3.51		8.00	3.0 ~ 9.0	1980	520 ~ 2800	4.04	A	
3.5 + 5.0 + 5.0	13.5	2.08	2.96	2.96		8.00	3.0 ~ 9.0	1920	570 ~ 2650	4.17	A	
3.5 + 5.0 + 6.0	14.5	1.93	2.76	3.31		8.00	3.0 ~ 9.0	1920	570 ~ 2650	4.17	A	
4.2 + 4.2 + 4.2	12.6	2.66	2.66	2.66		7.98	3.0 ~ 9.0	2170	480 ~ 3100	3.68	A	
4.2 + 4.2 + 5.0	13.4	2.51	2.51	2.98		8.00	3.0 ~ 9.0	1980	520 ~ 2800	4.04	A	
4.2 + 4.2 + 6.0	14.4	2.33	2.33	3.33		7.99	3.0 ~ 9.0	1980	520 ~ 2800	4.04	A	
4.2 + 5.0 + 5.0	14.2	2.36	2.82	2.82		8.00	3.0 ~ 9.0	1920	570 ~ 2650	4.17	A	



	Indoor unit capacity Cooling	Annual Energy Consumption (kWh)	Current 230V (A)	ERP				Moisture Removal Volume l/h
				Pdesign (kW)	SEER		Annual Consumption (kWh)	
					W/W	CLASS		
3 Room	2.0 + 5.0 + 6.0	960	9.2	8.00	7.40	A++	378	0.8 + 1.7 + 2.1
	2.0 + 5.0 + 7.1	960	9.2	8.00	7.40	A++	378	0.7 + 1.7 + 2.3
	2.0 + 6.0 + 6.0	960	9.2	8.00	7.40	A++	378	0.7 + 2.0 + 2.0
	2.5 + 2.5 + 2.5	1065	10.2	7.50	7.40	A++	355	1.5 + 1.5 + 1.5
	2.5 + 2.5 + 3.5	1145	11.0	8.00	7.40	A++	378	1.5 + 1.5 + 1.9
	2.5 + 2.5 + 4.2	1145	11.0	8.00	7.40	A++	378	1.4 + 1.4 + 2.1
	2.5 + 2.5 + 5.0	1020	9.8	8.00	7.40	A++	378	1.3 + 1.3 + 2.3
	2.5 + 2.5 + 6.0	1020	9.8	8.00	7.40	A++	378	1.2 + 1.2 + 2.4
	2.5 + 2.5 + 7.1	1020	9.8	8.00	7.40	A++	378	1.1 + 1.1 + 2.5
	2.5 + 3.5 + 3.5	1115	10.7	8.00	7.40	A++	378	1.4 + 1.7 + 1.7
	2.5 + 3.5 + 4.2	1115	10.7	8.00	7.40	A++	378	1.3 + 1.6 + 1.9
	2.5 + 3.5 + 5.0	1020	9.8	8.00	7.40	A++	378	1.2 + 1.6 + 2.1
	2.5 + 3.5 + 6.0	1020	9.8	8.00	7.40	A++	378	1.1 + 1.5 + 2.3
	2.5 + 3.5 + 7.1	990	9.5	8.00	7.40	A++	378	1.0 + 1.4 + 2.4
	2.5 + 4.2 + 4.2	1115	10.7	8.00	7.40	A++	378	1.2 + 1.7 + 1.7
	2.5 + 4.2 + 5.0	1020	9.8	8.00	7.40	A++	378	1.1 + 1.7 + 2.0
	2.5 + 4.2 + 6.0	1020	9.8	8.00	7.40	A++	378	1.0 + 1.6 + 2.2
	2.5 + 4.2 + 7.1	990	9.5	8.00	7.40	A++	378	0.9 + 1.5 + 2.3
	2.5 + 5.0 + 5.0	960	9.2	8.00	7.40	A++	378	1.0 + 1.8 + 1.8
	2.5 + 5.0 + 6.0	960	9.2	8.00	7.40	A++	378	0.9 + 1.7 + 2.1
	2.5 + 5.0 + 7.1	960	9.2	8.00	7.40	A++	378	0.9 + 1.6 + 2.3
	2.5 + 6.0 + 6.0	960	9.2	8.00	7.40	A++	378	0.9 + 1.9 + 1.9
	3.5 + 3.5 + 3.5	1085	10.4	7.98	7.40	A++	377	1.6 + 1.6 + 1.6
	3.5 + 3.5 + 4.2	1085	10.4	8.00	7.40	A++	378	1.5 + 1.5 + 1.7
	3.5 + 3.5 + 5.0	990	9.5	7.99	7.40	A++	378	1.5 + 1.5 + 1.9
	3.5 + 3.5 + 6.0	990	9.5	8.00	7.40	A++	378	1.4 + 1.4 + 2.2
	3.5 + 3.5 + 7.1	990	9.5	8.00	7.40	A++	378	1.3 + 1.3 + 2.3
	3.5 + 4.2 + 4.2	1085	10.4	8.00	7.40	A++	378	1.5 + 1.7 + 1.7
	3.5 + 4.2 + 5.0	990	9.5	8.00	7.40	A++	378	1.4 + 1.6 + 1.8
	3.5 + 4.2 + 6.0	990	9.5	8.00	7.40	A++	378	1.3 + 1.5 + 2.0
	3.5 + 5.0 + 5.0	960	9.2	8.00	7.40	A++	378	1.3 + 1.7 + 1.7
	3.5 + 5.0 + 6.0	960	9.2	8.00	7.40	A++	378	1.2 + 1.6 + 1.9
	4.2 + 4.2 + 4.2	1085	10.4	7.98	7.40	A++	377	1.6 + 1.6 + 1.6
4.2 + 4.2 + 5.0	990	9.5	8.00	7.40	A++	378	1.5 + 1.5 + 1.7	
4.2 + 4.2 + 6.0	990	9.5	7.99	7.40	A++	378	1.5 + 1.5 + 1.9	
4.2 + 5.0 + 5.0	960	9.2	8.00	7.40	A++	378	1.5 + 1.7 + 1.7	

Indoor unit capacity Cooling	Total	Cooling Capacity (kW)						Input Power (W)		EER	
		Room A	Room B	Room C	Room D	Total	min ~ max	Rating	min ~ max	WW	CLASS
1.6 + 1.6 + 1.6 + 1.6	6.4	1.60	1.60	1.60	1.60	6.40	3.0 ~ 9.2	1490	520 ~ 2950	4.30	A
1.6 + 1.6 + 1.6 + 2.0	6.8	1.60	1.60	1.60	2.00	6.80	3.0 ~ 9.2	1590	520 ~ 2870	4.28	A
1.6 + 1.6 + 1.6 + 2.5	7.3	1.60	1.60	1.60	2.50	7.30	3.0 ~ 9.2	1760	520 ~ 2870	4.15	A
1.6 + 1.6 + 1.6 + 3.5	8.3	1.54	1.54	1.54	3.38	8.00	3.0 ~ 9.2	1980	530 ~ 2870	4.04	A
1.6 + 1.6 + 1.6 + 4.2	9.0	1.42	1.42	1.42	3.74	8.00	3.0 ~ 9.2	1980	530 ~ 2870	4.04	A
1.6 + 1.6 + 1.6 + 5.0	9.8	1.31	1.31	1.31	4.07	8.00	3.0 ~ 9.2	1870	620 ~ 2730	4.28	A
1.6 + 1.6 + 1.6 + 6.0	10.8	1.19	1.19	1.19	4.43	8.00	3.0 ~ 9.2	1870	620 ~ 2730	4.28	A
1.6 + 1.6 + 1.6 + 7.1	11.9	1.08	1.08	1.08	4.76	8.00	3.0 ~ 9.2	1870	620 ~ 2660	4.28	A
1.6 + 1.6 + 2.0 + 2.0	7.2	1.60	1.60	2.00	2.00	7.20	3.0 ~ 9.2	1700	530 ~ 2870	4.24	A
1.6 + 1.6 + 2.0 + 2.5	7.7	1.60	1.60	2.00	2.50	7.70	3.0 ~ 9.2	1860	530 ~ 2870	4.14	A
1.6 + 1.6 + 2.0 + 3.5	8.7	1.47	1.47	1.84	3.22	8.00	3.0 ~ 9.2	1920	530 ~ 2870	4.17	A
1.6 + 1.6 + 2.0 + 4.2	9.4	1.36	1.36	1.70	3.58	8.00	3.0 ~ 9.2	1920	560 ~ 2870	4.17	A
1.6 + 1.6 + 2.0 + 5.0	10.2	1.25	1.25	1.57	3.93	8.00	3.0 ~ 9.2	1870	620 ~ 2650	4.28	A
1.6 + 1.6 + 2.0 + 6.0	11.2	1.14	1.14	1.43	4.29	8.00	3.0 ~ 9.2	1870	620 ~ 2650	4.28	A
1.6 + 1.6 + 2.0 + 7.1	12.3	1.04	1.04	1.30	4.62	8.00	3.0 ~ 9.2	1870	620 ~ 2660	4.28	A
1.6 + 1.6 + 2.5 + 2.5	8.2	1.56	1.56	2.44	2.44	8.00	3.0 ~ 9.2	1980	530 ~ 2870	4.04	A
1.6 + 1.6 + 2.5 + 3.5	9.2	1.39	1.39	2.17	3.05	8.00	3.0 ~ 9.2	1920	530 ~ 2870	4.17	A
1.6 + 1.6 + 2.5 + 4.2	9.9	1.29	1.29	2.02	3.40	8.00	3.0 ~ 9.2	1920	560 ~ 2870	4.17	A
1.6 + 1.6 + 2.5 + 5.0	10.7	1.20	1.20	1.87	3.73	8.00	3.0 ~ 9.2	1870	620 ~ 2650	4.28	A
1.6 + 1.6 + 2.5 + 6.0	11.7	1.09	1.09	1.71	4.11	8.00	3.0 ~ 9.2	1870	620 ~ 2650	4.28	A
1.6 + 1.6 + 2.5 + 7.1	12.8	1.00	1.00	1.56	4.44	8.00	3.0 ~ 9.2	1870	620 ~ 2660	4.28	A
1.6 + 1.6 + 3.5 + 3.5	10.2	1.25	1.25	2.75	2.75	8.00	3.0 ~ 9.2	1920	570 ~ 2800	4.17	A
1.6 + 1.6 + 3.5 + 4.2	10.9	1.17	1.17	2.57	3.09	8.00	3.0 ~ 9.2	1920	570 ~ 2800	4.17	A
1.6 + 1.6 + 3.5 + 5.0	11.7	1.09	1.09	2.39	3.43	8.00	3.0 ~ 9.2	1870	620 ~ 2660	4.28	A
1.6 + 1.6 + 3.5 + 6.0	12.7	1.01	1.01	2.20	3.78	8.00	3.0 ~ 9.2	1870	620 ~ 2660	4.28	A
1.6 + 1.6 + 3.5 + 7.1	13.8	0.93	0.93	2.03	4.11	8.00	3.0 ~ 9.2	1870	630 ~ 2660	4.28	A
1.6 + 1.6 + 4.2 + 4.2	11.6	1.10	1.10	2.90	2.90	8.00	3.0 ~ 9.2	1920	570 ~ 2800	4.17	A
1.6 + 1.6 + 4.2 + 5.0	12.4	1.03	1.03	2.71	3.23	8.00	3.0 ~ 9.2	1870	620 ~ 2660	4.28	A
1.6 + 1.6 + 4.2 + 6.0	13.4	0.96	0.96	2.51	3.57	8.00	3.0 ~ 9.2	1870	620 ~ 2660	4.28	A
1.6 + 1.6 + 4.2 + 7.1	14.5	0.88	0.88	2.32	3.92	8.00	3.0 ~ 9.2	1870	630 ~ 2660	4.28	A
1.6 + 1.6 + 5.0 + 5.0	13.2	0.97	0.97	3.03	3.03	8.00	3.0 ~ 9.2	1880	690 ~ 2600	4.26	A
1.6 + 1.6 + 5.0 + 6.0	14.2	0.90	0.90	2.82	3.38	8.00	3.0 ~ 9.2	1880	690 ~ 2600	4.26	A
1.6 + 2.0 + 2.0 + 2.0	7.6	1.60	2.00	2.00	2.00	7.60	3.0 ~ 9.2	1870	530 ~ 2870	4.06	A
1.6 + 2.0 + 2.0 + 2.5	8.1	1.58	1.98	1.98	2.46	8.00	3.0 ~ 9.2	1980	530 ~ 2870	4.04	A
1.6 + 2.0 + 2.0 + 3.5	9.1	1.41	1.76	1.76	3.07	8.00	3.0 ~ 9.2	1920	570 ~ 2800	4.17	A
1.6 + 2.0 + 2.0 + 4.2	9.8	1.31	1.63	1.63	3.43	8.00	3.0 ~ 9.2	1920	570 ~ 2800	4.17	A
1.6 + 2.0 + 2.0 + 5.0	10.6	1.21	1.51	1.51	3.77	8.00	3.0 ~ 9.2	1870	620 ~ 2650	4.28	A
1.6 + 2.0 + 2.0 + 6.0	11.6	1.10	1.38	1.38	4.14	8.00	3.0 ~ 9.2	1870	620 ~ 2650	4.28	A
1.6 + 2.0 + 2.0 + 7.1	12.7	1.01	1.26	1.26	4.47	8.00	3.0 ~ 9.2	1870	630 ~ 2660	4.28	A
1.6 + 2.0 + 2.5 + 2.5	8.6	1.48	1.86	2.33	2.33	8.00	3.0 ~ 9.2	1980	530 ~ 2870	4.04	A
1.6 + 2.0 + 2.5 + 3.5	9.6	1.33	1.67	2.08	2.92	8.00	3.0 ~ 9.2	1920	570 ~ 2800	4.17	A
1.6 + 2.0 + 2.5 + 4.2	10.3	1.24	1.55	1.94	3.27	8.00	3.0 ~ 9.2	1920	570 ~ 2800	4.17	A
1.6 + 2.0 + 2.5 + 5.0	11.1	1.15	1.44	1.80	3.61	8.00	3.0 ~ 9.2	1870	620 ~ 2650	4.28	A
1.6 + 2.0 + 2.5 + 6.0	12.1	1.06	1.32	1.65	3.97	8.00	3.0 ~ 9.2	1870	620 ~ 2650	4.28	A
1.6 + 2.0 + 2.5 + 7.1	13.2	0.97	1.21	1.52	4.30	8.00	3.0 ~ 9.2	1870	630 ~ 2660	4.28	A
1.6 + 2.0 + 3.5 + 3.5	10.6	1.21	1.51	2.64	2.64	8.00	3.0 ~ 9.2	1920	570 ~ 2800	4.17	A
1.6 + 2.0 + 3.5 + 4.2	11.3	1.13	1.42	2.48	2.97	8.00	3.0 ~ 9.2	1920	570 ~ 2800	4.17	A
1.6 + 2.0 + 3.5 + 5.0	12.1	1.06	1.32	2.31	3.31	8.00	3.0 ~ 9.2	1870	630 ~ 2660	4.28	A
1.6 + 2.0 + 3.5 + 6.0	13.1	0.98	1.22	2.14	3.66	8.00	3.0 ~ 9.2	1870	630 ~ 2660	4.28	A
1.6 + 2.0 + 3.5 + 7.1	14.2	0.90	1.13	1.97	4.00	8.00	3.0 ~ 9.2	1870	630 ~ 2660	4.28	A
1.6 + 2.0 + 4.2 + 4.2	12.0	1.07	1.33	2.80	2.80	8.00	3.0 ~ 9.2	1920	570 ~ 2800	4.17	A
1.6 + 2.0 + 4.2 + 5.0	12.8	1.00	1.25	2.63	3.12	8.00	3.0 ~ 9.2	1870	630 ~ 2660	4.28	A
1.6 + 2.0 + 4.2 + 6.0	13.8	0.93	1.16	2.43	3.48	8.00	3.0 ~ 9.2	1870	630 ~ 2660	4.28	A
1.6 + 2.0 + 5.0 + 5.0	13.6	0.94	1.18	2.94	2.94	8.00	3.0 ~ 9.2	1890	690 ~ 2600	4.23	A
1.6 + 2.0 + 5.0 + 6.0	14.6	0.88	1.10	2.74	3.28	8.00	3.0 ~ 9.2	1890	690 ~ 2600	4.23	A
1.6 + 2.5 + 2.5 + 2.5	9.1	1.40	2.20	2.20	2.20	8.00	3.0 ~ 9.2	1980	530 ~ 2870	4.04	A
1.6 + 2.5 + 2.5 + 3.5	10.1	1.27	1.98	1.98	2.77	8.00	3.0 ~ 9.2	1920	570 ~ 2800	4.17	A
1.6 + 2.5 + 2.5 + 4.2	10.8	1.19	1.85	1.85	3.11	8.00	3.0 ~ 9.2	1920	570 ~ 2800	4.17	A

	Indoor unit capacity Cooling	Annual Energy Consumption (kWh)	Current 230V (A)	ERP				Moisture Removal Volume l/h
				Pdesign (kW)	SEER		Annual Consumption (kWh)	
					WW	CLASS		
4 Room	1.6 + 1.6 + 1.6 + 1.6	745	7.2	6.40	8.50	A+++	264	1.0 + 1.0 + 1.0 + 1.0
	1.6 + 1.6 + 1.6 + 2.0	795	7.7	6.80	8.50	A+++	280	1.0 + 1.0 + 1.0 + 1.3
	1.6 + 1.6 + 1.6 + 2.5	880	8.4	7.30	7.90	A++	323	1.0 + 1.0 + 1.0 + 1.5
	1.6 + 1.6 + 1.6 + 3.5	990	9.5	8.00	7.90	A++	354	1.0 + 1.0 + 1.0 + 1.9
	1.6 + 1.6 + 1.6 + 4.2	990	9.5	8.00	7.90	A++	354	0.9 + 0.9 + 0.9 + 2.2
	1.6 + 1.6 + 1.6 + 5.0	935	9.0	8.00	7.90	A++	354	0.8 + 0.8 + 0.8 + 2.3
	1.6 + 1.6 + 1.6 + 6.0	935	9.0	8.00	7.90	A++	354	0.7 + 0.7 + 0.7 + 2.5
	1.6 + 1.6 + 1.6 + 7.1	935	9.0	8.00	7.90	A++	354	0.7 + 0.7 + 0.7 + 2.6
	1.6 + 1.6 + 2.0 + 2.0	850	8.2	7.20	7.90	A++	319	1.0 + 1.0 + 1.3 + 1.3
	1.6 + 1.6 + 2.0 + 2.5	930	8.9	7.70	7.90	A++	341	1.0 + 1.0 + 1.3 + 1.5
	1.6 + 1.6 + 2.0 + 3.5	960	9.2	8.00	7.90	A++	354	0.9 + 0.9 + 1.2 + 1.8
	1.6 + 1.6 + 2.0 + 4.2	960	9.2	8.00	7.90	A++	354	0.9 + 0.9 + 1.1 + 2.1
	1.6 + 1.6 + 2.0 + 5.0	935	9.0	8.00	7.90	A++	354	0.8 + 0.8 + 1.0 + 2.3
	1.6 + 1.6 + 2.0 + 6.0	935	9.0	8.00	7.90	A++	354	0.7 + 0.7 + 0.9 + 2.4
	1.6 + 1.6 + 2.0 + 7.1	935	9.0	8.00	7.90	A++	354	0.7 + 0.7 + 0.8 + 2.5
	1.6 + 1.6 + 2.5 + 2.5	990	9.5	8.00	7.90	A++	354	1.0 + 1.0 + 1.5 + 1.5
	1.6 + 1.6 + 2.5 + 3.5	960	9.2	8.00	7.90	A++	354	0.9 + 0.9 + 1.4 + 1.7
	1.6 + 1.6 + 2.5 + 4.2	960	9.2	8.00	7.90	A++	354	0.8 + 0.8 + 1.3 + 1.9
	1.6 + 1.6 + 2.5 + 5.0	935	9.0	8.00	7.90	A++	354	0.7 + 0.7 + 1.2 + 2.2
	1.6 + 1.6 + 2.5 + 6.0	935	9.0	8.00	7.90	A++	354	0.7 + 0.7 + 1.1 + 2.3
	1.6 + 1.6 + 2.5 + 7.1	935	9.0	8.00	7.90	A++	354	0.7 + 0.7 + 1.0 + 2.5
	1.6 + 1.6 + 3.5 + 3.5	960	9.2	8.00	7.90	A++	354	0.8 + 0.8 + 1.6 + 1.6
	1.6 + 1.6 + 3.5 + 4.2	960	9.2	8.00	7.90	A++	354	0.7 + 0.7 + 1.6 + 1.7
	1.6 + 1.6 + 3.5 + 5.0	935	9.0	8.00	7.90	A++	354	0.7 + 0.7 + 1.5 + 2.0
	1.6 + 1.6 + 3.5 + 6.0	935	9.0	8.00	7.90	A++	354	0.7 + 0.7 + 1.4 + 2.2
	1.6 + 1.6 + 3.5 + 7.1	935	9.0	8.00	7.90	A++	354	0.7 + 0.7 + 1.3 + 2.3
	1.6 + 1.6 + 4.2 + 4.2	960	9.2	8.00	7.90	A++	354	0.7 + 0.7 + 1.7 + 1.7
	1.6 + 1.6 + 4.2 + 5.0	935	9.0	8.00	7.90	A++	354	0.7 + 0.7 + 1.6 + 1.8
	1.6 + 1.6 + 4.2 + 6.0	935	9.0	8.00	7.90	A++	354	0.7 + 0.7 + 1.5 + 2.1
	1.6 + 1.6 + 4.2 + 7.1	935	9.0	8.00	7.90	A++	354	0.7 + 0.7 + 1.5 + 2.3
	1.6 + 1.6 + 5.0 + 5.0	940	9.0	8.00	7.90	A++	354	0.7 + 0.7 + 1.7 + 1.7
	1.6 + 1.6 + 5.0 + 6.0	940	9.0	8.00	7.90	A++	354	0.7 + 0.7 + 1.7 + 1.9
	1.6 + 2.0 + 2.0 + 2.0	935	9.0	7.60	7.90	A++	337	1.0 + 1.3 + 1.3 + 1.3
	1.6 + 2.0 + 2.0 + 2.5	990	9.5	8.00	7.90	A++	354	1.0 + 1.3 + 1.3 + 1.5
	1.6 + 2.0 + 2.0 + 3.5	960	9.2	8.00	7.90	A++	354	0.9 + 1.1 + 1.1 + 1.7
	1.6 + 2.0 + 2.0 + 4.2	960	9.2	8.00	7.90	A++	354	0.8 + 1.0 + 1.0 + 2.0
	1.6 + 2.0 + 2.0 + 5.0	935	9.0	8.00	7.90	A++	354	0.8 + 1.0 + 1.0 + 2.2
	1.6 + 2.0 + 2.0 + 6.0	935	9.0	8.00	7.90	A++	354	0.7 + 0.9 + 0.9 + 2.4
	1.6 + 2.0 + 2.0 + 7.1	935	9.0	8.00	7.90	A++	354	0.7 + 0.8 + 0.8 + 2.5
	1.6 + 2.0 + 2.5 + 2.5	990	9.5	8.00	7.90	A++	354	0.9 + 1.2 + 1.5 + 1.5
	1.6 + 2.0 + 2.5 + 3.5	960	9.2	8.00	7.90	A++	354	0.8 + 1.1 + 1.3 + 1.7
	1.6 + 2.0 + 2.5 + 4.2	960	9.2	8.00	7.90	A++	354	0.8 + 1.0 + 1.3 + 1.9
1.6 + 2.0 + 2.5 + 5.0	935	9.0	8.00	7.90	A++	354	0.7 + 0.9 + 1.2 + 2.1	
1.6 + 2.0 + 2.5 + 6.0	935	9.0	8.00	7.90	A++	354	0.7 + 0.8 + 1.1 + 2.3	
1.6 + 2.0 + 2.5 + 7.1	935	9.0	8.00	7.90	A++	354	0.7 + 0.8 + 1.0 + 2.4	
1.6 + 2.0 + 3.5 + 3.5	960	9.2	8.00	7.90	A++	354	0.8 + 1.0 + 1.6 + 1.6	
1.6 + 2.0 + 3.5 + 4.2	960	9.2	8.00	7.90	A++	354	0.7 + 0.9 + 1.5 + 1.7	
1.6 + 2.0 + 3.5 + 5.0	935	9.0	8.00	7.90	A++	354	0.7 + 0.8 + 1.5 + 1.9	
1.6 + 2.0 + 3.5 + 6.0	935	9.0	8.00	7.90	A++	354	0.7 + 0.8 + 1.4 + 2.1	
1.6 + 2.0 + 3.5 + 7.1	935	9.0	8.00	7.90	A++	354	0.7 + 0.7 + 1.3 + 2.3	
1.6 + 2.0 + 4.2 + 4.2	960	9.2	8.00	7.90	A++	354	0.7 + 0.8 + 1.6 + 1.6	
1.6 + 2.0 + 4.2 + 5.0	935	9.0	8.00	7.90	A++	354	0.7 + 0.8 + 1.6 + 1.8	
1.6 + 2.0 + 4.2 + 6.0	935	9.0	8.00	7.90	A++	354	0.7 + 0.7 + 1.5 + 2.0	
1.6 + 2.0 + 5.0 + 5.0	945	9.0	8.00	7.90	A++	354	0.7 + 0.7 + 1.7 + 1.7	
1.6 + 2.0 + 5.0 + 6.0	945	9.0	8.00	7.90	A++	354	0.7 + 0.7 + 1.6 + 1.9	
1.6 + 2.5 + 2.5 + 2.5	990	9.5	8.00	7.90	A++	354	0.9 + 1.4 + 1.4 + 1.4	
1.6 + 2.5 + 2.5 + 3.5	960	9.2	8.00	7.90	A++	354	0.8 + 1.3 + 1.3 + 1.6	
1.6 + 2.5 + 2.5 + 4.2	960	9.2	8.00	7.90	A++	354	0.7 + 1.2 + 1.2 + 1.8	

Indoor unit capacity Cooling	Total	Cooling Capacity (kW)						Input Power (W)		EER	
		Room A	Room B	Room C	Room D	Total	min ~ max	Rating	min ~ max	W/W	CLASS
1.6 + 2.5 + 2.5 + 5.0	11.6	1.10	1.72	1.72	3.46	8.00	3.0 ~ 9.2	1870	620 ~ 2650	4.28	A
1.6 + 2.5 + 2.5 + 6.0	12.6	1.02	1.59	1.59	3.80	8.00	3.0 ~ 9.2	1870	620 ~ 2650	4.28	A
1.6 + 2.5 + 2.5 + 7.1	13.7	0.93	1.46	1.46	4.15	8.00	3.0 ~ 9.2	1870	630 ~ 2660	4.28	A
1.6 + 2.5 + 3.5 + 3.5	11.1	1.15	1.81	2.52	2.52	8.00	3.0 ~ 9.2	1920	570 ~ 2800	4.17	A
1.6 + 2.5 + 3.5 + 4.2	11.8	1.08	1.69	2.37	2.86	8.00	3.0 ~ 9.2	1920	570 ~ 2800	4.17	A
1.6 + 2.5 + 3.5 + 5.0	12.6	1.02	1.59	2.22	3.17	8.00	3.0 ~ 9.2	1870	630 ~ 2660	4.28	A
1.6 + 2.5 + 3.5 + 6.0	13.6	0.94	1.47	2.06	3.53	8.00	3.0 ~ 9.2	1870	630 ~ 2660	4.28	A
1.6 + 2.5 + 3.5 + 7.1	14.7	0.87	1.36	1.90	3.87	8.00	3.0 ~ 9.2	1870	630 ~ 2660	4.28	A
1.6 + 2.5 + 4.2 + 4.2	12.5	1.02	1.60	2.69	2.69	8.00	3.0 ~ 9.2	1920	570 ~ 2800	4.17	A
1.6 + 2.5 + 4.2 + 5.0	13.3	0.96	1.50	2.53	3.01	8.00	3.0 ~ 9.2	1870	630 ~ 2660	4.28	A
1.6 + 2.5 + 4.2 + 6.0	14.3	0.90	1.40	2.35	3.35	8.00	3.0 ~ 9.2	1870	630 ~ 2660	4.28	A
1.6 + 2.5 + 5.0 + 5.0	14.1	0.90	1.42	2.84	2.84	8.00	3.0 ~ 9.2	1890	690 ~ 2600	4.23	A
1.6 + 3.5 + 3.5 + 3.5	12.1	1.07	2.31	2.31	2.31	8.00	3.0 ~ 9.2	1920	570 ~ 2800	4.17	A
1.6 + 3.5 + 3.5 + 4.2	12.8	1.00	2.19	2.19	2.62	8.00	3.0 ~ 9.2	1920	570 ~ 2720	4.17	A
1.6 + 3.5 + 3.5 + 5.0	13.6	0.94	2.06	2.06	2.94	8.00	3.0 ~ 9.2	1870	630 ~ 2660	4.28	A
1.6 + 3.5 + 3.5 + 6.0	14.6	0.88	1.92	1.92	3.28	8.00	3.0 ~ 9.2	1870	630 ~ 2660	4.28	A
1.6 + 3.5 + 4.2 + 4.2	13.5	0.95	2.07	2.49	2.49	8.00	3.0 ~ 9.2	1920	570 ~ 2720	4.17	A
1.6 + 3.5 + 4.2 + 5.0	14.3	0.90	1.96	2.35	2.79	8.00	3.0 ~ 9.2	1870	630 ~ 2660	4.28	A
1.6 + 4.2 + 4.2 + 4.2	14.2	0.89	2.37	2.37	2.37	8.00	3.0 ~ 9.2	1920	570 ~ 2720	4.17	A
2.0 + 2.0 + 2.0 + 2.0	8.0	2.00	2.00	2.00	2.00	8.00	3.0 ~ 9.2	1980	530 ~ 2870	4.04	A
2.0 + 2.0 + 2.0 + 2.5	8.5	1.88	1.88	1.88	2.36	8.00	3.0 ~ 9.2	1980	530 ~ 2870	4.04	A
2.0 + 2.0 + 2.0 + 3.5	9.5	1.68	1.68	1.68	2.96	8.00	3.0 ~ 9.2	1920	570 ~ 2800	4.17	A
2.0 + 2.0 + 2.0 + 4.2	10.2	1.57	1.57	1.57	3.29	8.00	3.0 ~ 9.2	1920	570 ~ 2800	4.17	A
2.0 + 2.0 + 2.0 + 5.0	11.0	1.45	1.45	1.45	3.65	8.00	3.0 ~ 9.2	1870	620 ~ 2650	4.28	A
2.0 + 2.0 + 2.0 + 6.0	12.0	1.33	1.33	1.33	4.01	8.00	3.0 ~ 9.2	1870	620 ~ 2650	4.28	A
2.0 + 2.0 + 2.0 + 7.1	13.1	1.22	1.22	1.22	4.34	8.00	3.0 ~ 9.2	1870	630 ~ 2660	4.28	A
2.0 + 2.0 + 2.5 + 2.5	9.0	1.78	1.78	2.22	2.22	8.00	3.0 ~ 9.2	1980	530 ~ 2870	4.04	A
2.0 + 2.0 + 2.5 + 3.5	10.0	1.60	1.60	2.00	2.80	8.00	3.0 ~ 9.2	1920	570 ~ 2800	4.17	A
2.0 + 2.0 + 2.5 + 4.2	10.7	1.50	1.50	1.87	3.13	8.00	3.0 ~ 9.2	1920	570 ~ 2800	4.17	A
2.0 + 2.0 + 2.5 + 5.0	11.5	1.39	1.39	1.74	3.48	8.00	3.0 ~ 9.2	1870	620 ~ 2650	4.28	A
2.0 + 2.0 + 2.5 + 6.0	12.5	1.28	1.28	1.60	3.84	8.00	3.0 ~ 9.2	1870	620 ~ 2650	4.28	A
2.0 + 2.0 + 2.5 + 7.1	13.6	1.18	1.18	1.47	4.17	8.00	3.0 ~ 9.2	1870	630 ~ 2660	4.28	A
2.0 + 2.0 + 3.5 + 3.5	11.0	1.45	1.45	2.55	2.55	8.00	3.0 ~ 9.2	1920	570 ~ 2800	4.17	A
2.0 + 2.0 + 3.5 + 4.2	11.7	1.37	1.37	2.39	2.87	8.00	3.0 ~ 9.2	1920	570 ~ 2800	4.17	A
2.0 + 2.0 + 3.5 + 5.0	12.5	1.28	1.28	2.24	3.20	8.00	3.0 ~ 9.2	1870	630 ~ 2660	4.28	A
2.0 + 2.0 + 3.5 + 6.0	13.5	1.19	1.19	2.07	3.55	8.00	3.0 ~ 9.2	1870	630 ~ 2660	4.28	A
2.0 + 2.0 + 3.5 + 7.1	14.6	1.10	1.10	1.92	3.88	8.00	3.0 ~ 9.2	1870	630 ~ 2660	4.28	A
2.0 + 2.0 + 4.2 + 4.2	12.4	1.29	1.29	2.71	2.71	8.00	3.0 ~ 9.2	1920	570 ~ 2800	4.17	A
2.0 + 2.0 + 4.2 + 5.0	13.2	1.21	1.21	2.55	3.03	8.00	3.0 ~ 9.2	1870	630 ~ 2660	4.28	A
2.0 + 2.0 + 4.2 + 6.0	14.2	1.13	1.13	2.37	3.37	8.00	3.0 ~ 9.2	1870	630 ~ 2660	4.28	A
2.0 + 2.0 + 5.0 + 5.0	14.0	1.14	1.14	2.86	2.86	8.00	3.0 ~ 9.2	1890	700 ~ 2600	4.23	A
2.0 + 2.5 + 2.5 + 2.5	9.5	1.67	2.11	2.11	2.11	8.00	3.0 ~ 9.2	1980	530 ~ 2870	4.04	A
2.0 + 2.5 + 2.5 + 3.5	10.5	1.52	1.90	1.90	2.68	8.00	3.0 ~ 9.2	1920	570 ~ 2800	4.17	A
2.0 + 2.5 + 2.5 + 4.2	11.2	1.43	1.79	1.79	2.99	8.00	3.0 ~ 9.2	1920	570 ~ 800	4.17	A
2.0 + 2.5 + 2.5 + 5.0	12.0	1.33	1.67	1.67	3.33	8.00	3.0 ~ 9.2	1870	620 ~ 2650	4.28	A
2.0 + 2.5 + 2.5 + 6.0	13.0	1.23	1.54	1.54	3.69	8.00	3.0 ~ 9.2	1870	620 ~ 2650	4.28	A
2.0 + 2.5 + 2.5 + 7.1	14.1	1.13	1.42	1.42	4.03	8.00	3.0 ~ 9.2	1870	630 ~ 2660	4.28	A
2.0 + 2.5 + 3.5 + 3.5	11.5	1.39	1.75	2.43	2.43	8.00	3.0 ~ 9.2	1920	570 ~ 2800	4.17	A
2.0 + 2.5 + 3.5 + 4.2	12.2	1.31	1.64	2.30	2.75	8.00	3.0 ~ 9.2	1920	570 ~ 2800	4.17	A
2.0 + 2.5 + 3.5 + 5.0	13.0	1.23	1.54	2.15	3.08	8.00	3.0 ~ 9.2	1870	630 ~ 2660	4.28	A
2.0 + 2.5 + 3.5 + 6.0	14.0	1.14	1.43	2.00	3.43	8.00	3.0 ~ 9.2	1870	630 ~ 2660	4.28	A
2.0 + 2.5 + 4.2 + 4.2	12.9	1.24	1.56	2.60	2.60	8.00	3.0 ~ 9.2	1920	570 ~ 2800	4.17	A
2.0 + 2.5 + 4.2 + 5.0	13.7	1.17	1.46	2.45	2.92	8.00	3.0 ~ 9.2	1870	630 ~ 2660	4.28	A
2.0 + 2.5 + 4.2 + 6.0	14.7	1.09	1.36	2.29	3.26	8.00	3.0 ~ 9.2	1870	630 ~ 2660	4.28	A
2.0 + 2.5 + 5.0 + 5.0	14.5	1.10	1.38	2.76	2.76	8.00	3.0 ~ 9.2	1890	700 ~ 2600	4.23	A
2.0 + 3.5 + 3.5 + 3.5	12.5	1.28	2.24	2.24	2.24	8.00	3.0 ~ 9.2	1920	570 ~ 2720	4.17	A
2.0 + 3.5 + 3.5 + 4.2	13.2	1.21	2.12	2.12	2.55	8.00	3.0 ~ 9.2	1920	570 ~ 2720	4.17	A
2.0 + 3.5 + 3.5 + 5.0	14.0	1.14	2.00	2.00	2.86	8.00	3.0 ~ 9.2	1870	630 ~ 2660	4.28	A

Indoor unit capacity Cooling	Annual Energy Consumption (kWh)	Current 230V (A)	ERP				Moisture Removal Volume l/h
			Pdesign (kW)	SEER		Annual Consumption (kWh)	
				W/W	CLASS		
1.6 + 2.5 + 2.5 + 5.0	935	9.0	8.00	7.90	A++	354	0.7 + 1.1 + 1.1 + 2.0
1.6 + 2.5 + 2.5 + 6.0	935	9.0	8.00	7.90	A++	354	0.7 + 1.0 + 1.0 + 2.2
1.6 + 2.5 + 2.5 + 7.1	935	9.0	8.00	7.90	A++	354	0.7 + 0.9 + 0.9 + 2.4
1.6 + 2.5 + 3.5 + 3.5	960	9.2	8.00	7.90	A++	354	0.7 + 1.2 + 1.5 + 1.5
1.6 + 2.5 + 3.5 + 4.2	960	9.2	8.00	7.90	A++	354	0.7 + 1.1 + 1.5 + 1.7
1.6 + 2.5 + 3.5 + 5.0	935	9.0	8.00	7.90	A++	354	0.7 + 1.0 + 1.4 + 1.8
1.6 + 2.5 + 3.5 + 6.0	935	9.0	8.00	7.90	A++	354	0.7 + 0.9 + 1.3 + 2.0
1.6 + 2.5 + 3.5 + 7.1	935	9.0	8.00	7.90	A++	354	0.7 + 0.9 + 1.2 + 2.3
1.6 + 2.5 + 4.2 + 4.2	960	9.2	8.00	7.90	A++	354	0.7 + 1.0 + 1.6 + 1.6
1.6 + 2.5 + 4.2 + 5.0	935	9.0	8.00	7.90	A++	354	0.7 + 1.0 + 1.6 + 1.7
1.6 + 2.5 + 4.2 + 6.0	935	9.0	8.00	7.90	A++	354	0.7 + 0.9 + 1.5 + 1.9
1.6 + 2.5 + 5.0 + 5.0	945	9.0	8.00	7.90	A++	354	0.7 + 0.9 + 1.7 + 1.7
1.6 + 3.5 + 3.5 + 3.5	960	9.2	8.00	7.90	A++	354	0.7 + 1.5 + 1.5 + 1.5
1.6 + 3.5 + 3.5 + 4.2	960	9.2	8.00	7.90	A++	354	0.7 + 1.4 + 1.4 + 1.6
1.6 + 3.5 + 3.5 + 5.0	935	9.0	8.00	7.90	A++	354	0.7 + 1.3 + 1.3 + 1.7
1.6 + 3.5 + 3.5 + 6.0	935	9.0	8.00	7.90	A++	354	0.7 + 1.2 + 1.2 + 1.9
1.6 + 3.5 + 4.2 + 4.2	960	9.2	8.00	7.90	A++	354	0.7 + 1.3 + 1.5 + 1.5
1.6 + 3.5 + 4.2 + 5.0	935	9.0	8.00	7.90	A++	354	0.7 + 1.3 + 1.5 + 1.6
1.6 + 4.2 + 4.2 + 4.2	960	9.2	8.00	7.90	A++	354	0.7 + 1.5 + 1.5 + 1.5
2.0 + 2.0 + 2.0 + 2.0	990	9.5	8.00	7.90	A++	354	1.3 + 1.3 + 1.3 + 1.3
2.0 + 2.0 + 2.0 + 2.5	990	9.5	8.00	7.90	A++	354	1.2 + 1.2 + 1.2 + 1.5
2.0 + 2.0 + 2.0 + 3.5	960	9.2	8.00	7.90	A++	354	1.1 + 1.1 + 1.1 + 1.7
2.0 + 2.0 + 2.0 + 4.2	960	9.2	8.00	7.90	A++	354	1.0 + 1.0 + 1.0 + 1.9
2.0 + 2.0 + 2.0 + 5.0	935	9.0	8.00	7.90	A++	354	0.9 + 0.9 + 0.9 + 2.1
2.0 + 2.0 + 2.0 + 6.0	935	9.0	8.00	7.90	A++	354	0.8 + 0.8 + 0.8 + 2.3
2.0 + 2.0 + 2.0 + 7.1	935	9.0	8.00	7.90	A++	354	0.8 + 0.8 + 0.8 + 2.4
2.0 + 2.0 + 2.5 + 2.5	990	9.5	8.00	7.90	A++	354	1.1 + 1.1 + 1.4 + 1.4
2.0 + 2.0 + 2.5 + 3.5	960	9.2	8.00	7.90	A++	354	1.0 + 1.0 + 1.3 + 1.6
2.0 + 2.0 + 2.5 + 4.2	960	9.2	8.00	7.90	A++	354	1.0 + 1.0 + 1.2 + 1.8
2.0 + 2.0 + 2.5 + 5.0	935	9.0	8.00	7.90	A++	354	0.9 + 0.9 + 1.1 + 2.0
2.0 + 2.0 + 2.5 + 6.0	935	9.0	8.00	7.90	A++	354	0.8 + 0.8 + 1.0 + 2.2
2.0 + 2.0 + 2.5 + 7.1	935	9.0	8.00	7.90	A++	354	0.7 + 0.7 + 0.9 + 2.4
2.0 + 2.0 + 3.5 + 3.5	960	9.2	8.00	7.90	A++	354	0.9 + 0.9 + 1.6 + 1.6
2.0 + 2.0 + 3.5 + 4.2	960	9.2	8.00	7.90	A++	354	0.9 + 0.9 + 1.5 + 1.7
2.0 + 2.0 + 3.5 + 5.0	935	9.0	8.00	7.90	A++	354	0.8 + 0.8 + 1.5 + 1.8
2.0 + 2.0 + 3.5 + 6.0	935	9.0	8.00	7.90	A++	354	0.7 + 0.7 + 1.3 + 2.1
2.0 + 2.0 + 3.5 + 7.1	935	9.0	8.00	7.90	A++	354	0.7 + 0.7 + 1.2 + 2.3
2.0 + 2.0 + 4.2 + 4.2	960	9.2	8.00	7.90	A++	354	0.8 + 0.8 + 1.6 + 1.6
2.0 + 2.0 + 4.2 + 5.0	935	9.0	8.00	7.90	A++	354	0.8 + 0.8 + 1.6 + 1.7
2.0 + 2.0 + 4.2 + 6.0	935	9.0	8.00	7.90	A++	354	0.7 + 0.7 + 1.5 + 1.9
2.0 + 2.0 + 5.0 + 5.0	945	9.0	8.00	7.90	A++	354	0.7 + 0.7 + 1.7 + 1.7
2.0 + 2.5 + 2.5 + 2.5	990	9.5	8.00	7.90	A++	354	1.1 + 1.4 + 1.4 + 1.4
2.0 + 2.5 + 2.5 + 3.5	960	9.2	8.00	7.90	A++	354	1.0 + 1.2 + 1.2 + 1.6
2.0 + 2.5 + 2.5 + 4.2	960	9.2	8.00	7.90	A++	354	0.9 + 1.2 + 1.2 + 1.7
2.0 + 2.5 + 2.5 + 5.0	935	9.0	8.00	7.90	A++	354	0.8 + 1.1 + 1.1 + 1.9
2.0 + 2.5 + 2.5 + 6.0	935	9.0	8.00	7.90	A++	354	0.8 + 1.0 + 1.0 + 2.1
2.0 + 2.5 + 2.5 + 7.1	935	9.0	8.00	7.90	A++	354	0.7 + 0.9 + 0.9 + 2.3
2.0 + 2.5 + 3.5 + 3.5	960	9.2	8.00	7.90	A++	354	0.9 + 1.1 + 1.5 + 1.5
2.0 + 2.5 + 3.5 + 4.2	960	9.2	8.00	7.90	A++	354	0.8 + 1.0 + 1.5 + 1.6
2.0 + 2.5 + 3.5 + 5.0	935	9.0	8.00	7.90	A++	354	0.8 + 1.0 + 1.4 + 1.7
2.0 + 2.5 + 3.5 + 6.0	935	9.0	8.00	7.90	A++	354	0.7 + 0.9 + 1.3 + 2.0
2.0 + 2.5 + 4.2 + 4.2	960	9.2	8.00	7.90	A++	354	0.8 + 1.0 + 1.6 + 1.6
2.0 + 2.5 + 4.2 + 5.0	935	9.0	8.00	7.90	A++	354	0.7 + 0.9 + 1.5 + 1.7
2.0 + 2.5 + 4.2 + 6.0	935	9.0	8.00	7.90	A++	354	0.7 + 0.9 + 1.5 + 1.9
2.0 + 2.5 + 5.0 + 5.0	945	9.0	8.00	7.90	A++	354	0.7 + 0.9 + 1.6 + 1.6
2.0 + 3.5 + 3.5 + 3.5	960	9.2	8.00	7.90	A++	354	0.8 + 1.5 + 1.5 + 1.5
2.0 + 3.5 + 3.5 + 4.2	960	9.2	8.00	7.90	A++	354	0.8 + 1.4 + 1.4 + 1.6
2.0 + 3.5 + 3.5 + 5.0	935	9.0	8.00	7.90	A++	354	0.7 + 1.3 + 1.3 + 1.7

4  
Room

Indoor unit capacity Cooling		Total	Cooling Capacity (kW)						Input Power (W)		EER	
			Room A	Room B	Room C	Room D	Total	min ~ max	Rating	min ~ max	W/W	CLASS
4 Room	2.0 + 3.5 + 4.2 + 4.2	13.9	1.15	2.01	2.42	2.42	8.00	3.0 ~ 9.2	1920	570 ~ 2720	4.17	A
	2.0 + 3.5 + 4.2 + 5.0	14.7	1.09	1.90	2.29	2.72	8.00	3.0 ~ 9.2	1870	630 ~ 2660	4.28	A
	2.0 + 4.2 + 4.2 + 4.2	14.6	1.10	2.30	2.30	2.30	8.00	3.0 ~ 9.2	1870	580 ~ 2720	4.28	A
	2.5 + 2.5 + 2.5 + 2.5	10.0	2.00	2.00	2.00	2.00	8.00	3.0 ~ 9.2	1980	530 ~ 2870	4.04	A
	2.5 + 2.5 + 2.5 + 3.5	11.0	1.82	1.82	1.82	2.54	8.00	3.0 ~ 9.2	1920	570 ~ 2800	4.17	A
	2.5 + 2.5 + 2.5 + 4.2	11.7	1.71	1.71	1.71	2.87	8.00	3.0 ~ 9.2	1920	570 ~ 2800	4.17	A
	2.5 + 2.5 + 2.5 + 5.0	12.5	1.60	1.60	1.60	3.20	8.00	3.0 ~ 9.2	1870	620 ~ 2650	4.28	A
	2.5 + 2.5 + 2.5 + 6.0	13.5	1.48	1.48	1.48	3.56	8.00	3.0 ~ 9.2	1870	620 ~ 2650	4.28	A
	2.5 + 2.5 + 2.5 + 7.1	14.6	1.37	1.37	1.37	3.89	8.00	3.0 ~ 9.2	1870	630 ~ 2660	4.28	A
	2.5 + 2.5 + 3.5 + 3.5	12.0	1.67	1.67	2.33	2.33	8.00	3.0 ~ 9.2	1920	570 ~ 2800	4.17	A
	2.5 + 2.5 + 3.5 + 4.2	12.7	1.57	1.57	2.20	2.66	8.00	3.0 ~ 9.2	1920	570 ~ 2800	4.17	A
	2.5 + 2.5 + 3.5 + 5.0	13.5	1.48	1.48	2.07	2.97	8.00	3.0 ~ 9.2	1870	630 ~ 2660	4.28	A
	2.5 + 2.5 + 3.5 + 6.0	14.5	1.38	1.38	1.93	3.31	8.00	3.0 ~ 9.2	1870	630 ~ 2660	4.28	A
	2.5 + 2.5 + 4.2 + 4.2	13.4	1.49	1.49	2.51	2.51	8.00	3.0 ~ 9.2	1920	570 ~ 2800	4.17	A
	2.5 + 2.5 + 4.2 + 5.0	14.2	1.41	1.41	2.37	2.81	8.00	3.0 ~ 9.2	1870	630 ~ 2660	4.28	A
	2.5 + 3.5 + 3.5 + 3.5	13.0	1.55	2.15	2.15	2.15	8.00	3.0 ~ 9.2	1920	570 ~ 2720	4.17	A
	2.5 + 3.5 + 3.5 + 4.2	13.7	1.46	2.04	2.04	2.46	8.00	3.0 ~ 9.2	1920	570 ~ 2720	4.17	A
	2.5 + 3.5 + 3.5 + 5.0	14.5	1.38	1.93	1.93	2.76	8.00	3.0 ~ 9.2	1870	630 ~ 2660	4.28	A
	2.5 + 3.5 + 4.2 + 4.2	14.4	1.39	1.95	2.33	2.33	8.00	3.0 ~ 9.2	1920	570 ~ 2720	4.17	A
	3.5 + 3.5 + 3.5 + 3.5	14.0	2.00	2.00	2.00	2.00	8.00	3.0 ~ 9.2	1870	580 ~ 2720	4.28	A
3.5 + 3.5 + 3.5 + 4.2	14.7	1.90	1.90	1.90	2.30	8.00	3.0 ~ 9.2	1870	580 ~ 2720	4.28	A	

Indoor unit capacity Cooling	Annual Energy Consumption (kWh)	Current 230V (A)	ERP				Moisture Removal Volume l/h
			Pdesign (kW)	SEER		Annual Consumption (kWh)	
				WW	CLASS		
2.0 + 3.5 + 4.2 + 4.2	960	9.2	8.00	7.90	A++	354	0.7 + 1.3 + 1.5 + 1.5
2.0 + 3.5 + 4.2 + 5.0	935	9.0	8.00	7.90	A++	354	0.7 + 1.2 + 1.5 + 1.6
2.0 + 4.2 + 4.2 + 4.2	935	9.0	8.00	7.90	A++	354	0.7 + 1.5 + 1.5 + 1.5
2.5 + 2.5 + 2.5 + 2.5	990	9.5	8.00	7.90	A++	354	1.3 + 1.3 + 1.3 + 1.3
2.5 + 2.5 + 2.5 + 3.5	960	9.2	8.00	7.90	A++	354	1.2 + 1.2 + 1.2 + 1.6
2.5 + 2.5 + 2.5 + 4.2	960	9.2	8.00	7.90	A++	354	1.1 + 1.1 + 1.1 + 1.7
2.5 + 2.5 + 2.5 + 5.0	935	9.0	8.00	7.90	A++	354	1.0 + 1.0 + 1.0 + 1.8
2.5 + 2.5 + 2.5 + 6.0	935	9.0	8.00	7.90	A++	354	0.9 + 0.9 + 0.9 + 2.1
2.5 + 2.5 + 2.5 + 7.1	935	9.0	8.00	7.90	A++	354	0.9 + 0.9 + 0.9 + 2.3
2.5 + 2.5 + 3.5 + 3.5	960	9.2	8.00	7.90	A++	354	1.1 + 1.1 + 1.5 + 1.5
2.5 + 2.5 + 3.5 + 4.2	960	9.2	8.00	7.90	A++	354	1.0 + 1.0 + 1.4 + 1.6
2.5 + 2.5 + 3.5 + 5.0	935	9.0	8.00	7.90	A++	354	0.9 + 0.9 + 1.3 + 1.7
2.5 + 2.5 + 3.5 + 6.0	935	9.0	8.00	7.90	A++	354	0.9 + 0.9 + 1.2 + 1.9
2.5 + 2.5 + 4.2 + 4.2	960	9.2	8.00	7.90	A++	354	0.9 + 0.9 + 1.5 + 1.5
2.5 + 2.5 + 4.2 + 5.0	935	9.0	8.00	7.90	A++	354	0.9 + 0.9 + 1.5 + 1.6
2.5 + 3.5 + 3.5 + 3.5	960	9.2	8.00	7.90	A++	354	1.0 + 1.4 + 1.4 + 1.4
2.5 + 3.5 + 3.5 + 4.2	960	9.2	8.00	7.90	A++	354	0.9 + 1.3 + 1.3 + 1.5
2.5 + 3.5 + 3.5 + 5.0	935	9.0	8.00	7.90	A++	354	0.9 + 1.2 + 1.2 + 1.6
2.5 + 3.5 + 4.2 + 4.2	960	9.2	8.00	7.90	A++	354	0.9 + 1.3 + 1.5 + 1.5
3.5 + 3.5 + 3.5 + 3.5	935	9.0	8.00	7.90	A++	354	1.3 + 1.3 + 1.3 + 1.3
3.5 + 3.5 + 3.5 + 4.2	935	9.0	8.00	7.90	A++	354	1.2 + 1.2 + 1.2 + 1.5

- Indoor Unit : CS-MZ / Z / XZ wall mount series
- Outdoor Unit : CU-4Z80TBE

Indoor unit capacity Heating	Total	Heating Capacity (kW)						Input Power (W)		COP		
		Room A	Room B	Room C	Room D	Total	min ~ max	Rating	min ~ max	W/W	CLASS	
1 Room	1.6	1.6	2.60				2.60	1.2 ~ 3.2	600	300 ~ 960	4.33	A
	2.0	2.0	3.20				3.20	1.2 ~ 4.1	740	300 ~ 1230	4.32	A
	2.5	2.5	3.60				3.60	1.2 ~ 4.3	940	300 ~ 1230	3.83	A
	3.5	3.5	4.50				4.50	1.2 ~ 5.8	1230	300 ~ 2100	3.66	A
	4.2	4.2	5.60				5.60	1.2 ~ 6.8	1720	300 ~ 2930	3.26	C
	5.0	5.0	6.80				6.80	1.2 ~ 6.9	2100	300 ~ 2520	3.24	C
	6.0	6.0	8.50				8.50	1.3 ~ 9.0	2400	620 ~ 2550	3.54	B
	7.1	7.1	8.70				8.70	1.4 ~ 9.2	2550	680 ~ 2720	3.41	B
2 Room	1.6 + 1.6	3.2	2.60	2.60			5.20	2.2 ~ 8.2	1560	430 ~ 2840	3.33	C
	1.6 + 2.0	3.6	2.58	3.22			5.80	2.2 ~ 8.2	1680	430 ~ 2830	3.45	B
	1.6 + 2.5	4.1	2.42	3.78			6.20	2.2 ~ 8.2	1820	430 ~ 2830	3.41	B
	1.6 + 3.5	5.1	2.23	4.87			7.10	2.2 ~ 8.6	1990	380 ~ 2910	3.57	B
	1.6 + 4.2	5.8	2.26	5.94			8.20	2.2 ~ 9.8	2370	370 ~ 3440	3.46	B
	1.6 + 5.0	6.6	2.28	7.12			9.40	2.2 ~ 10.0	2460	330 ~ 3250	3.82	A
	1.6 + 6.0	7.6	1.98	7.42			9.40	2.2 ~ 10.0	2460	330 ~ 3250	3.82	A
	1.6 + 7.1	8.7	1.73	7.67			9.40	2.2 ~ 10.3	2400	320 ~ 3420	3.92	A
	2.0 + 2.0	4.0	3.20	3.20			6.40	2.2 ~ 8.2	1860	390 ~ 2820	3.44	B
	2.0 + 2.5	4.5	3.02	3.78			6.80	2.2 ~ 8.2	1920	390 ~ 2820	3.54	B
	2.0 + 3.5	5.5	2.80	4.90			7.70	2.2 ~ 8.6	2170	370 ~ 2850	3.55	B
	2.0 + 4.2	6.2	2.84	5.96			8.80	2.2 ~ 10.0	2420	370 ~ 3550	3.64	A
	2.0 + 5.0	7.0	2.69	6.71			9.40	2.2 ~ 10.0	2450	320 ~ 3230	3.84	A
	2.0 + 6.0	8.0	2.35	7.05			9.40	2.2 ~ 10.0	2450	320 ~ 3230	3.84	A
	2.0 + 7.1	9.1	2.07	7.33			9.40	2.2 ~ 10.3	2390	320 ~ 3400	3.93	A
	2.5 + 2.5	5.0	3.60	3.60			7.20	2.2 ~ 8.6	2050	390 ~ 2930	3.51	B
	2.5 + 3.5	6.0	3.37	4.73			8.10	2.2 ~ 9.8	2320	370 ~ 3440	3.49	B
	2.5 + 4.2	6.7	3.43	5.77			9.20	2.2 ~ 10.0	2570	370 ~ 3550	3.58	B
	2.5 + 5.0	7.5	3.13	6.27			9.40	2.2 ~ 10.0	2450	320 ~ 3230	3.84	A
	2.5 + 6.0	8.5	2.76	6.64			9.40	2.2 ~ 10.0	2450	320 ~ 3230	3.84	A
	2.5 + 7.1	9.6	2.45	6.95			9.40	2.2 ~ 10.3	2390	320 ~ 3400	3.93	A
	3.5 + 3.5	7.0	4.50	4.50			9.00	2.2 ~ 10.0	2450	360 ~ 3470	3.67	A
	3.5 + 4.2	7.7	4.27	5.13			9.40	2.2 ~ 10.0	2590	350 ~ 3460	3.63	A
	3.5 + 5.0	8.5	3.87	5.53			9.40	2.2 ~ 10.0	2380	320 ~ 3200	3.95	A
	3.5 + 6.0	9.5	3.46	5.94			9.40	2.2 ~ 10.3	2380	320 ~ 3320	3.95	A
	3.5 + 7.1	10.6	3.10	6.30			9.40	2.2 ~ 10.5	2360	310 ~ 3430	3.98	A
	4.2 + 4.2	8.4	4.70	4.70			9.40	2.2 ~ 10.0	2580	350 ~ 3450	3.64	A
4.2 + 5.0	9.2	4.29	5.11			9.40	2.2 ~ 10.3	2360	320 ~ 3310	3.98	A	
4.2 + 6.0	10.2	3.87	5.53			9.40	2.2 ~ 10.3	2360	320 ~ 3310	3.98	A	
4.2 + 7.1	11.3	3.49	5.91			9.40	2.2 ~ 10.5	2350	310 ~ 3420	4.00	A	
5.0 + 5.0	10.0	4.70	4.70			9.40	2.2 ~ 10.3	2200	310 ~ 3090	4.27	A	
5.0 + 6.0	11.0	4.27	5.13			9.40	2.2 ~ 10.5	2200	310 ~ 3150	4.27	A	
5.0 + 7.1	12.1	3.88	5.52			9.40	2.2 ~ 10.5	2180	310 ~ 3130	4.31	A	
6.0 + 6.0	12.0	4.70	4.70			9.40	2.2 ~ 10.5	2200	310 ~ 3150	4.27	A	
6.0 + 7.1	13.1	4.31	5.09			9.40	2.2 ~ 10.5	2180	310 ~ 3130	4.31	A	
7.1 + 7.1	14.2	4.70	4.70			9.40	2.2 ~ 10.5	2170	320 ~ 3120	4.33	A	



	Indoor unit capacity Heating	Annual Energy Consumption (kWh)	Current 230V (A)	ERP				Moisture Removal Volume l/h
				Pdesign (kW)	SCOP		Annual Consumption (kWh)	
					WW	CLASS		
1 Room	1.6	300	3.0	-	-	-	-	
	2.0	370	3.7	-	-	-	-	
	2.5	470	4.7	-	-	-	-	
	3.5	615	6.0	-	-	-	-	
	4.2	860	8.0	-	-	-	-	
	5.0	1050	9.7	-	-	-	-	
	6.0	1200	11.1	-	-	-	-	
	7.1	1275	11.8	-	-	-	-	
2 Room	1.6 + 1.6	780	7.4	3.50	3.90	A	1256	
	1.6 + 2.0	840	8.0	3.50	3.90	A	1256	
	1.6 + 2.5	910	8.6	3.50	3.90	A	1256	
	1.6 + 3.5	995	9.4	4.50	3.90	A	1615	
	1.6 + 4.2	1185	11.1	4.50	3.90	A	1615	
	1.6 + 5.0	1230	11.6	5.50	4.10	A+	1878	
	1.6 + 6.0	1230	11.6	5.50	4.10	A+	1878	
	1.6 + 7.1	1200	11.3	5.50	4.10	A+	1878	
	2.0 + 2.0	930	8.7	3.50	3.90	A	1256	
	2.0 + 2.5	960	9.0	3.50	3.90	A	1256	
	2.0 + 3.5	1085	10.2	4.50	3.90	A	1615	
	2.0 + 4.2	1210	11.4	4.50	3.90	A	1615	
	2.0 + 5.0	1225	11.5	5.50	4.10	A+	1878	
	2.0 + 6.0	1225	11.5	5.50	4.10	A+	1878	
	2.0 + 7.1	1195	11.2	5.50	4.10	A+	1878	
	2.5 + 2.5	1025	9.6	3.50	3.90	A	1256	
	2.5 + 3.5	1160	10.9	4.50	3.90	A	1615	
	2.5 + 4.2	1285	12.1	4.50	3.90	A	1615	
	2.5 + 5.0	1225	11.5	5.50	4.10	A+	1878	
	2.5 + 6.0	1225	11.5	5.50	4.10	A+	1878	
	2.5 + 7.1	1195	11.2	5.50	4.10	A+	1878	
	3.5 + 3.5	1225	11.5	4.50	3.90	A	1615	
	3.5 + 4.2	1295	12.2	4.50	3.90	A	1615	
	3.5 + 5.0	1190	11.2	5.50	4.10	A+	1878	
	3.5 + 6.0	1190	11.2	5.50	4.10	A+	1878	
	3.5 + 7.1	1180	11.1	5.50	4.10	A+	1878	
	4.2 + 4.2	1290	12.1	4.50	3.90	A	1615	
	4.2 + 5.0	1180	11.1	5.50	4.10	A+	1878	
	4.2 + 6.0	1180	11.1	5.50	4.10	A+	1878	
	4.2 + 7.1	1175	11.0	5.50	4.10	A+	1878	
5.0 + 5.0	1100	10.3	6.80	4.10	A+	2322		
5.0 + 6.0	1100	10.3	6.80	4.10	A+	2322		
5.0 + 7.1	1090	10.2	6.80	4.10	A+	2322		
6.0 + 6.0	1100	10.3	6.80	4.10	A+	2322		
6.0 + 7.1	1090	10.2	6.80	4.10	A+	2322		
7.1 + 7.1	1085	10.2	6.80	4.10	A+	2322		

Indoor unit capacity Heating	Total	Heating Capacity (kW)					Input Power (W)		COP		
		Room A	Room B	Room C	Room D	Total	min ~ max	Rating	min ~ max	W/W	CLASS
1.6 + 1.6 + 1.6	4.8	2.60	2.60	2.60		7.80	3.2 ~ 10.4	1880	500 ~ 3340	4.15	A
1.6 + 1.6 + 2.0	5.2	2.58	2.58	3.24		8.40	3.2 ~ 10.4	2110	500 ~ 3260	3.98	A
1.6 + 1.6 + 2.5	5.7	2.47	2.47	3.86		8.80	3.2 ~ 10.4	2090	500 ~ 3260	4.21	A
1.6 + 1.6 + 3.5	6.7	2.24	2.24	4.92		9.40	3.2 ~ 10.4	2250	490 ~ 3230	4.18	A
1.6 + 1.6 + 4.2	7.4	2.03	2.03	5.34		9.40	3.2 ~ 10.4	2240	490 ~ 3210	4.20	A
1.6 + 1.6 + 5.0	8.2	1.83	1.83	5.74		9.40	3.2 ~ 10.4	2130	480 ~ 3000	4.41	A
1.6 + 1.6 + 6.0	9.2	1.63	1.63	6.14		9.40	3.2 ~ 10.5	2130	480 ~ 3060	4.41	A
1.6 + 1.6 + 7.1	10.3	1.46	1.46	6.48		9.40	3.2 ~ 10.5	2120	510 ~ 3040	4.43	A
1.6 + 2.0 + 2.0	5.6	2.58	3.21	3.21		9.00	3.2 ~ 10.4	2130	490 ~ 3250	4.23	A
1.6 + 2.0 + 2.5	6.1	2.47	3.08	3.85		9.40	3.2 ~ 10.4	2270	490 ~ 3250	4.14	A
1.6 + 2.0 + 3.5	7.1	2.12	2.65	4.63		9.40	3.2 ~ 10.4	2240	490 ~ 3210	4.20	A
1.6 + 2.0 + 4.2	7.8	1.93	2.41	5.06		9.40	3.2 ~ 10.4	2230	490 ~ 3200	4.22	A
1.6 + 2.0 + 5.0	8.6	1.75	2.19	5.46		9.40	3.2 ~ 10.5	2120	510 ~ 3050	4.43	A
1.6 + 2.0 + 6.0	9.6	1.57	1.96	5.87		9.40	3.2 ~ 10.5	2120	510 ~ 3050	4.43	A
1.6 + 2.0 + 7.1	10.7	1.41	1.76	6.23		9.40	3.2 ~ 10.5	2110	510 ~ 3030	4.45	A
1.6 + 2.5 + 2.5	6.6	2.28	3.56	3.56		9.40	3.2 ~ 10.4	2270	490 ~ 3250	4.14	A
1.6 + 2.5 + 3.5	7.6	1.98	3.09	4.33		9.40	3.2 ~ 10.4	2240	490 ~ 3210	4.20	A
1.6 + 2.5 + 4.2	8.3	1.81	2.83	4.76		9.40	3.2 ~ 10.4	2230	490 ~ 3200	4.22	A
1.6 + 2.5 + 5.0	9.1	1.65	2.58	5.17		9.40	3.2 ~ 10.5	2120	510 ~ 3050	4.43	A
1.6 + 2.5 + 6.0	10.1	1.49	2.33	5.58		9.40	3.2 ~ 10.5	2120	510 ~ 3050	4.43	A
1.6 + 2.5 + 7.1	11.2	1.34	2.10	5.96		9.40	3.2 ~ 10.6	2110	510 ~ 3090	4.45	A
1.6 + 3.5 + 3.5	8.6	1.74	3.83	3.83		9.40	3.2 ~ 10.5	2210	480 ~ 3240	4.25	A
1.6 + 3.5 + 4.2	9.3	1.62	3.54	4.24		9.40	3.2 ~ 10.5	2200	480 ~ 3160	4.27	A
1.6 + 3.5 + 5.0	10.1	1.49	3.26	4.65		9.40	3.2 ~ 10.5	2090	510 ~ 3010	4.50	A
1.6 + 3.5 + 6.0	11.1	1.35	2.96	5.09		9.40	3.2 ~ 10.6	2090	510 ~ 3070	4.50	A
1.6 + 3.5 + 7.1	12.2	1.23	2.70	5.47		9.40	3.2 ~ 10.6	2080	510 ~ 3060	4.52	A
1.6 + 4.2 + 4.2	10.0	1.50	3.95	3.95		9.40	3.2 ~ 10.5	2190	480 ~ 3150	4.29	A
1.6 + 4.2 + 5.0	10.8	1.39	3.66	4.35		9.40	3.2 ~ 10.5	2090	510 ~ 3000	4.50	A
1.6 + 4.2 + 6.0	11.8	1.27	3.35	4.78		9.40	3.2 ~ 10.6	2090	510 ~ 3060	4.50	A
1.6 + 4.2 + 7.1	12.9	1.17	3.06	5.17		9.40	3.2 ~ 10.6	2070	510 ~ 3040	4.54	A
1.6 + 5.0 + 5.0	11.6	1.30	4.05	4.05		9.40	3.2 ~ 10.6	2000	570 ~ 2930	4.70	A
1.6 + 5.0 + 6.0	12.6	1.19	3.73	4.48		9.40	3.2 ~ 10.6	2000	570 ~ 2930	4.70	A
1.6 + 5.0 + 7.1	13.7	1.10	3.43	4.87		9.40	3.2 ~ 10.6	1990	590 ~ 2920	4.72	A
1.6 + 6.0 + 6.0	13.6	1.10	4.15	4.15		9.40	3.2 ~ 10.6	2000	570 ~ 2930	4.70	A
1.6 + 6.0 + 7.1	14.7	1.02	3.84	4.54		9.40	3.2 ~ 10.6	1990	590 ~ 2920	4.72	A
2.0 + 2.0 + 2.0	6.0	3.13	3.13	3.13		9.39	3.2 ~ 10.4	2260	490 ~ 3240	4.15	A
2.0 + 2.0 + 2.5	6.5	2.89	2.89	3.62		9.40	3.2 ~ 10.4	2260	490 ~ 3240	4.16	A
2.0 + 2.0 + 3.5	7.5	2.51	2.51	4.38		9.40	3.2 ~ 10.4	2230	490 ~ 3200	4.22	A
2.0 + 2.0 + 4.2	8.2	2.29	2.29	4.82		9.40	3.2 ~ 10.4	2220	480 ~ 3190	4.23	A
2.0 + 2.0 + 5.0	9.0	2.09	2.09	5.22		9.40	3.2 ~ 10.5	2110	510 ~ 3030	4.45	A
2.0 + 2.0 + 6.0	10.0	1.88	1.88	5.64		9.40	3.2 ~ 10.5	2110	510 ~ 3030	4.45	A
2.0 + 2.0 + 7.1	11.1	1.69	1.69	6.02		9.40	3.2 ~ 10.6	2100	510 ~ 3080	4.48	A
2.0 + 2.5 + 2.5	7.0	2.68	3.36	3.36		9.40	3.2 ~ 10.4	2260	490 ~ 3240	4.16	A
2.0 + 2.5 + 3.5	8.0	2.35	2.94	4.11		9.40	3.2 ~ 10.4	2230	490 ~ 3200	4.22	A
2.0 + 2.5 + 4.2	8.7	2.16	2.70	4.54		9.40	3.2 ~ 10.5	2220	480 ~ 3250	4.23	A
2.0 + 2.5 + 5.0	9.5	1.98	2.47	4.95		9.40	3.2 ~ 10.5	2110	510 ~ 3030	4.45	A
2.0 + 2.5 + 6.0	10.5	1.79	2.24	5.37		9.40	3.2 ~ 10.5	2110	510 ~ 3030	4.45	A
2.0 + 2.5 + 7.1	11.6	1.62	2.03	5.75		9.40	3.2 ~ 10.6	2100	510 ~ 3080	4.48	A
2.0 + 3.5 + 3.5	9.0	2.08	3.66	3.66		9.40	3.2 ~ 10.5	2200	480 ~ 3160	4.27	A
2.0 + 3.5 + 4.2	9.7	1.94	3.39	4.07		9.40	3.2 ~ 10.5	2190	480 ~ 3150	4.29	A
2.0 + 3.5 + 5.0	10.5	1.79	3.13	4.48		9.40	3.2 ~ 10.5	2090	510 ~ 3000	4.50	A
2.0 + 3.5 + 6.0	11.5	1.63	2.86	4.91		9.40	3.2 ~ 10.6	2090	510 ~ 3060	4.50	A
2.0 + 3.5 + 7.1	12.6	1.49	2.61	5.30		9.40	3.2 ~ 10.6	2070	510 ~ 3040	4.54	A
2.0 + 4.2 + 4.2	10.4	1.80	3.80	3.80		9.40	3.2 ~ 10.5	2180	480 ~ 3140	4.31	A
2.0 + 4.2 + 5.0	11.2	1.68	3.53	4.19		9.40	3.2 ~ 10.6	2080	510 ~ 3050	4.52	A
2.0 + 4.2 + 6.0	12.2	1.54	3.24	4.62		9.40	3.2 ~ 10.6	2080	510 ~ 3050	4.52	A
2.0 + 4.2 + 7.1	13.3	1.41	2.97	5.02		9.40	3.2 ~ 10.6	2070	520 ~ 3030	4.54	A
2.0 + 5.0 + 5.0	12.0	1.56	3.92	3.92		9.40	3.2 ~ 10.6	1990	590 ~ 2920	4.72	A

3  
Room

Indoor unit capacity Heating	Annual Energy Consumption (kWh)	Current 230V (A)	ERP				Moisture Removal Volume l/h
			Pdesign (kW)	SCOP		Annual Consumption (kWh)	
				W/W	CLASS		
1.6 + 1.6 + 1.6	940	8.8	5.00	4.20	A+	1667	
1.6 + 1.6 + 2.0	1055	9.9	5.00	4.20	A+	1667	
1.6 + 1.6 + 2.5	1045	9.8	5.00	4.20	A+	1667	
1.6 + 1.6 + 3.5	1125	10.6	6.00	4.30	A+	1953	
1.6 + 1.6 + 4.2	1120	10.5	6.00	4.30	A+	1953	
1.6 + 1.6 + 5.0	1065	10.0	6.80	4.40	A+	2164	
1.6 + 1.6 + 6.0	1065	10.0	6.80	4.40	A+	2164	
1.6 + 1.6 + 7.1	1060	10.0	6.80	4.40	A+	2164	
1.6 + 2.0 + 2.0	1065	10.0	5.00	4.20	A+	1667	
1.6 + 2.0 + 2.5	1135	10.7	6.00	4.30	A+	1953	
1.6 + 2.0 + 3.5	1120	10.5	6.00	4.30	A+	1953	
1.6 + 2.0 + 4.2	1115	10.5	6.00	4.30	A+	1953	
1.6 + 2.0 + 5.0	1060	10.0	6.80	4.40	A+	2164	
1.6 + 2.0 + 6.0	1060	10.0	6.80	4.40	A+	2164	
1.6 + 2.0 + 7.1	1055	9.9	6.80	4.40	A+	2164	
1.6 + 2.5 + 2.5	1135	10.7	6.00	4.30	A+	1953	
1.6 + 2.5 + 3.5	1120	10.5	6.00	4.30	A+	1953	
1.6 + 2.5 + 4.2	1115	10.5	6.80	4.40	A+	2164	
1.6 + 2.5 + 5.0	1060	10.0	6.80	4.40	A+	2164	
1.6 + 2.5 + 6.0	1060	10.0	6.80	4.40	A+	2164	
1.6 + 2.5 + 7.1	1055	9.9	6.80	4.40	A+	2164	
1.6 + 3.5 + 3.5	1105	10.4	6.80	4.40	A+	2164	
1.6 + 3.5 + 4.2	1100	10.3	6.80	4.40	A+	2164	
1.6 + 3.5 + 5.0	1045	9.8	6.80	4.40	A+	2164	
1.6 + 3.5 + 6.0	1045	9.8	6.80	4.40	A+	2164	
1.6 + 3.5 + 7.1	1040	9.8	6.80	4.40	A+	2164	
1.6 + 4.2 + 4.2	1095	10.3	6.80	4.40	A+	2164	
1.6 + 4.2 + 5.0	1045	9.8	6.80	4.40	A+	2164	
1.6 + 4.2 + 6.0	1045	9.8	6.80	4.40	A+	2164	
1.6 + 4.2 + 7.1	1035	9.7	6.80	4.40	A+	2164	
1.6 + 5.0 + 5.0	1000	9.4	6.80	4.40	A+	2164	
1.6 + 5.0 + 6.0	1000	9.4	6.80	4.40	A+	2164	
1.6 + 5.0 + 7.1	995	9.4	6.80	4.40	A+	2164	
1.6 + 6.0 + 6.0	1000	9.4	6.80	4.40	A+	2164	
1.6 + 6.0 + 7.1	995	9.4	6.80	4.40	A+	2164	
2.0 + 2.0 + 2.0	1130	10.6	6.00	4.30	A+	1953	
2.0 + 2.0 + 2.5	1130	10.6	6.00	4.30	A+	1953	
2.0 + 2.0 + 3.5	1115	10.5	6.00	4.30	A+	1953	
2.0 + 2.0 + 4.2	1110	10.4	6.80	4.40	A+	2164	
2.0 + 2.0 + 5.0	1055	9.9	6.80	4.40	A+	2164	
2.0 + 2.0 + 6.0	1055	9.9	6.80	4.40	A+	2164	
2.0 + 2.0 + 7.1	1050	9.9	6.80	4.40	A+	2164	
2.0 + 2.5 + 2.5	1130	10.6	6.00	4.30	A+	1953	
2.0 + 2.5 + 3.5	1115	10.5	6.80	4.40	A+	2164	
2.0 + 2.5 + 4.2	1110	10.4	6.80	4.40	A+	2164	
2.0 + 2.5 + 5.0	1055	9.9	6.80	4.40	A+	2164	
2.0 + 2.5 + 6.0	1055	9.9	6.80	4.40	A+	2164	
2.0 + 2.5 + 7.1	1050	9.9	6.80	4.40	A+	2164	
2.0 + 3.5 + 3.5	1100	10.3	6.80	4.40	A+	2164	
2.0 + 3.5 + 4.2	1095	10.3	6.80	4.40	A+	2164	
2.0 + 3.5 + 5.0	1045	9.8	6.80	4.40	A+	2164	
2.0 + 3.5 + 6.0	1045	9.8	6.80	4.40	A+	2164	
2.0 + 3.5 + 7.1	1035	9.7	6.80	4.40	A+	2164	
2.0 + 4.2 + 4.2	1090	10.2	6.80	4.40	A+	2164	
2.0 + 4.2 + 5.0	1040	9.8	6.80	4.40	A+	2164	
2.0 + 4.2 + 6.0	1040	9.8	6.80	4.40	A+	2164	
2.0 + 4.2 + 7.1	1035	9.7	6.80	4.40	A+	2164	
2.0 + 5.0 + 5.0	995	9.4	6.80	4.40	A+	2164	

3 Room

Indoor unit capacity Heating	Total	Heating Capacity (kW)						Input Power (W)		COP	
		Room A	Room B	Room C	Room D	Total	min ~ max	Rating	min ~ max	W/W	CLASS
2.0 + 5.0 + 6.0	13.0	1.45	3.62	4.33		9.40	3.2 ~ 10.6	1990	590 ~ 2920	4.72	A
2.0 + 5.0 + 7.1	14.1	1.33	3.33	4.74		9.40	3.2 ~ 10.6	1980	600 ~ 2910	4.75	A
2.0 + 6.0 + 6.0	14.0	1.34	4.03	4.03		9.40	3.2 ~ 10.6	1990	590 ~ 2920	4.72	A
2.5 + 2.5 + 2.5	7.5	3.13	3.13	3.13		9.39	3.2 ~ 10.4	2260	490 ~ 3240	4.15	A
2.5 + 2.5 + 3.5	8.5	2.76	2.76	3.88		9.40	3.2 ~ 10.4	2230	490 ~ 3200	4.22	A
2.5 + 2.5 + 4.2	9.2	2.55	2.55	4.30		9.40	3.2 ~ 10.5	2220	480 ~ 3250	4.23	A
2.5 + 2.5 + 5.0	10.0	2.35	2.35	4.70		9.40	3.2 ~ 10.5	2110	510 ~ 3030	4.45	A
2.5 + 2.5 + 6.0	11.0	2.14	2.14	5.12		9.40	3.2 ~ 10.5	2110	510 ~ 3030	4.45	A
2.5 + 2.5 + 7.1	12.1	1.94	1.94	5.52		9.40	3.2 ~ 10.6	2100	510 ~ 3080	4.48	A
2.5 + 3.5 + 3.5	9.5	2.48	3.46	3.46		9.40	3.2 ~ 10.5	2200	480 ~ 3160	4.27	A
2.5 + 3.5 + 4.2	10.2	2.30	3.23	3.87		9.40	3.2 ~ 10.5	2190	480 ~ 3150	4.29	A
2.5 + 3.5 + 5.0	11.0	2.14	2.99	4.27		9.40	3.2 ~ 10.5	2090	510 ~ 3000	4.50	A
2.5 + 3.5 + 6.0	12.0	1.96	2.74	4.70		9.40	3.2 ~ 10.6	2090	510 ~ 3060	4.50	A
2.5 + 3.5 + 7.1	13.1	1.79	2.51	5.10		9.40	3.2 ~ 10.6	2070	510 ~ 3040	4.54	A
2.5 + 4.2 + 4.2	10.9	2.16	3.62	3.62		9.40	3.2 ~ 10.5	2180	480 ~ 3140	4.31	A
2.5 + 4.2 + 5.0	11.7	2.01	3.37	4.02		9.40	3.2 ~ 10.6	2080	510 ~ 3050	4.52	A
2.5 + 4.2 + 6.0	12.7	1.85	3.11	4.44		9.40	3.2 ~ 10.6	2080	510 ~ 3050	4.52	A
2.5 + 4.2 + 7.1	13.8	1.70	2.86	4.84		9.40	3.2 ~ 10.6	2070	520 ~ 3030	4.54	A
2.5 + 5.0 + 5.0	12.5	1.88	3.76	3.76		9.40	3.2 ~ 10.6	1990	590 ~ 2920	4.72	A
2.5 + 5.0 + 6.0	13.5	1.74	3.48	4.18		9.40	3.2 ~ 10.6	1990	590 ~ 2920	4.72	A
2.5 + 5.0 + 7.1	14.6	1.61	3.22	4.57		9.40	3.2 ~ 10.6	1980	600 ~ 2910	4.75	A
2.5 + 6.0 + 6.0	14.5	1.62	3.89	3.89		9.40	3.2 ~ 10.6	1990	590 ~ 2920	4.72	A
3.5 + 3.5 + 3.5	10.5	3.13	3.13	3.13		9.39	3.2 ~ 10.5	2180	480 ~ 3130	4.31	A
3.5 + 3.5 + 4.2	11.2	2.94	2.94	3.52		9.40	3.2 ~ 10.6	2170	480 ~ 3170	4.33	A
3.5 + 3.5 + 5.0	12.0	2.74	2.74	3.92		9.40	3.2 ~ 10.6	2060	520 ~ 3030	4.56	A
3.5 + 3.5 + 6.0	13.0	2.53	2.53	4.34		9.40	3.2 ~ 10.6	2060	520 ~ 3030	4.56	A
3.5 + 3.5 + 7.1	14.1	2.33	2.33	4.74		9.40	3.2 ~ 10.6	2050	520 ~ 3010	4.59	A
3.5 + 4.2 + 4.2	11.9	2.76	3.32	3.32		9.40	3.2 ~ 10.6	2160	480 ~ 3160	4.35	A
3.5 + 4.2 + 5.0	12.7	2.59	3.11	3.70		9.40	3.2 ~ 10.6	2050	520 ~ 3020	4.59	A
3.5 + 4.2 + 6.0	13.7	2.40	2.88	4.12		9.40	3.2 ~ 10.6	2050	520 ~ 3020	4.59	A
3.5 + 5.0 + 5.0	13.5	2.44	3.48	3.48		9.40	3.2 ~ 10.6	1970	600 ~ 2890	4.77	A
3.5 + 5.0 + 6.0	14.5	2.27	3.24	3.89		9.40	3.2 ~ 10.6	1970	600 ~ 2890	4.77	A
4.2 + 4.2 + 4.2	12.6	3.13	3.13	3.13		9.39	3.2 ~ 10.6	2150	480 ~ 3150	4.37	A
4.2 + 4.2 + 5.0	13.4	2.95	2.95	3.50		9.40	3.2 ~ 10.6	2050	540 ~ 3000	4.59	A
4.2 + 4.2 + 6.0	14.4	2.74	2.74	3.92		9.40	3.2 ~ 10.6	2050	540 ~ 3000	4.59	A
4.2 + 5.0 + 5.0	14.2	2.78	3.31	3.31		9.40	3.2 ~ 10.6	1970	610 ~ 2880	4.77	A

3  
Room

Indoor unit capacity Heating	Annual Energy Consumption (kWh)	Current 230V (A)	ERP				Moisture Removal Volume l/h
			Pdesign (kW)	SCOP		Annual Consumption (kWh)	
				WW	CLASS		
3 Room	2.0 + 5.0 + 6.0	995	9.4	6.80	4.40	A+	2164
	2.0 + 5.0 + 7.1	990	9.3	6.80	4.40	A+	2164
	2.0 + 6.0 + 6.0	995	9.4	6.80	4.40	A+	2164
	2.5 + 2.5 + 2.5	1130	10.6	6.00	4.30	A+	1953
	2.5 + 2.5 + 3.5	1115	10.5	6.80	4.40	A+	2164
	2.5 + 2.5 + 4.2	1110	10.4	6.80	4.40	A+	2164
	2.5 + 2.5 + 5.0	1055	9.9	6.80	4.40	A+	2164
	2.5 + 2.5 + 6.0	1055	9.9	6.80	4.40	A+	2164
	2.5 + 2.5 + 7.1	1050	9.9	6.80	4.40	A+	2164
	2.5 + 3.5 + 3.5	1100	10.3	6.80	4.40	A+	2164
	2.5 + 3.5 + 4.2	1095	10.3	6.80	4.40	A+	2164
	2.5 + 3.5 + 5.0	1045	9.8	6.80	4.40	A+	2164
	2.5 + 3.5 + 6.0	1045	9.8	6.80	4.40	A+	2164
	2.5 + 3.5 + 7.1	1035	9.7	6.80	4.40	A+	2164
	2.5 + 4.2 + 4.2	1090	10.2	6.80	4.40	A+	2164
	2.5 + 4.2 + 5.0	1040	9.8	6.80	4.40	A+	2164
	2.5 + 4.2 + 6.0	1040	9.8	6.80	4.40	A+	2164
	2.5 + 4.2 + 7.1	1035	9.7	6.80	4.40	A+	2164
	2.5 + 5.0 + 5.0	995	9.4	6.80	4.40	A+	2164
	2.5 + 5.0 + 6.0	995	9.4	6.80	4.40	A+	2164
	2.5 + 5.0 + 7.1	990	9.3	6.80	4.40	A+	2164
	2.5 + 6.0 + 6.0	995	9.4	6.80	4.40	A+	2164
	3.5 + 3.5 + 3.5	1090	10.2	6.80	4.40	A+	2164
	3.5 + 3.5 + 4.2	1085	10.2	6.80	4.40	A+	2164
	3.5 + 3.5 + 5.0	1030	9.7	6.80	4.40	A+	2164
	3.5 + 3.5 + 6.0	1030	9.7	6.80	4.40	A+	2164
	3.5 + 3.5 + 7.1	1025	9.6	6.80	4.40	A+	2164
	3.5 + 4.2 + 4.2	1080	10.2	6.80	4.40	A+	2164
	3.5 + 4.2 + 5.0	1025	9.6	6.80	4.40	A+	2164
	3.5 + 4.2 + 6.0	1025	9.6	6.80	4.40	A+	2164
3.5 + 5.0 + 5.0	985	9.3	6.80	4.40	A+	2164	
3.5 + 5.0 + 6.0	985	9.3	6.80	4.40	A+	2164	
4.2 + 4.2 + 4.2	1075	10.1	6.80	4.40	A+	2164	
4.2 + 4.2 + 5.0	1025	9.6	6.80	4.40	A+	2164	
4.2 + 4.2 + 6.0	1025	9.6	6.80	4.40	A+	2164	
4.2 + 5.0 + 5.0	985	9.3	6.80	4.40	A+	2164	

Indoor unit capacity Heating	Total	Heating Capacity (kW)						Input Power (W)		COP	
		Room A	Room B	Room C	Room D	Total	min ~ max	Rating	min ~ max	W/W	CLASS
1.6 + 1.6 + 1.6 + 1.6	6.4	2.35	2.35	2.35	2.35	9.40	4.2 ~ 10.6	2070	680 ~ 3030	4.54	A
1.6 + 1.6 + 1.6 + 2.0	6.8	2.21	2.21	2.21	2.77	9.40	4.2 ~ 10.6	2060	680 ~ 3020	4.56	A
1.6 + 1.6 + 1.6 + 2.5	7.3	2.06	2.06	2.06	3.22	9.40	4.2 ~ 10.6	2060	680 ~ 3020	4.56	A
1.6 + 1.6 + 1.6 + 3.5	8.3	1.81	1.81	1.81	3.97	9.40	4.2 ~ 10.6	2040	690 ~ 2990	4.61	A
1.6 + 1.6 + 1.6 + 4.2	9.0	1.67	1.67	1.67	4.39	9.40	4.2 ~ 10.6	2030	690 ~ 2980	4.63	A
1.6 + 1.6 + 1.6 + 5.0	9.8	1.53	1.53	1.53	4.81	9.40	4.2 ~ 10.6	2000	760 ~ 2860	4.70	A
1.6 + 1.6 + 1.6 + 6.0	10.8	1.39	1.39	1.39	5.23	9.40	4.2 ~ 10.6	2000	760 ~ 2860	4.70	A
1.6 + 1.6 + 1.6 + 7.1	11.9	1.26	1.26	1.26	5.62	9.40	4.2 ~ 10.6	1990	770 ~ 2850	4.72	A
1.6 + 1.6 + 2.0 + 2.0	7.2	2.09	2.09	2.61	2.61	9.40	4.2 ~ 10.6	2050	680 ~ 3010	4.59	A
1.6 + 1.6 + 2.0 + 2.5	7.7	1.95	1.95	2.44	3.06	9.40	4.2 ~ 10.6	2050	680 ~ 3010	4.59	A
1.6 + 1.6 + 2.0 + 3.5	8.7	1.73	1.73	2.16	3.78	9.40	4.2 ~ 10.6	2030	690 ~ 2980	4.63	A
1.6 + 1.6 + 2.0 + 4.2	9.4	1.60	1.60	2.00	4.20	9.40	4.2 ~ 10.6	2020	710 ~ 2970	4.65	A
1.6 + 1.6 + 2.0 + 5.0	10.2	1.47	1.47	1.84	4.62	9.40	4.2 ~ 10.6	1990	770 ~ 2850	4.72	A
1.6 + 1.6 + 2.0 + 6.0	11.2	1.34	1.34	1.68	5.04	9.40	4.2 ~ 10.6	1990	770 ~ 2850	4.72	A
1.6 + 1.6 + 2.0 + 7.1	12.3	1.22	1.22	1.53	5.43	9.40	4.2 ~ 10.6	1980	790 ~ 2900	4.75	A
1.6 + 1.6 + 2.5 + 2.5	8.2	1.83	1.83	2.87	2.87	9.40	4.2 ~ 10.6	2050	680 ~ 3010	4.59	A
1.6 + 1.6 + 2.5 + 3.5	9.2	1.63	1.63	2.55	3.59	9.40	4.2 ~ 10.6	2030	690 ~ 2980	4.63	A
1.6 + 1.6 + 2.5 + 4.2	9.9	1.52	1.52	2.37	3.99	9.40	4.2 ~ 10.6	2020	710 ~ 2970	4.65	A
1.6 + 1.6 + 2.5 + 5.0	10.7	1.41	1.41	2.20	4.38	9.40	4.2 ~ 10.6	1990	770 ~ 2850	4.72	A
1.6 + 1.6 + 2.5 + 6.0	11.7	1.29	1.29	2.01	4.81	9.40	4.2 ~ 10.6	1990	770 ~ 2850	4.72	A
1.6 + 1.6 + 2.5 + 7.1	12.8	1.18	1.18	1.84	5.20	9.40	4.2 ~ 10.6	1980	790 ~ 2900	4.75	A
1.6 + 1.6 + 3.5 + 3.5	10.2	1.47	1.47	3.23	3.23	9.40	4.2 ~ 10.6	2010	720 ~ 2950	4.68	A
1.6 + 1.6 + 3.5 + 4.2	10.9	1.38	1.38	3.02	3.62	9.40	4.2 ~ 10.6	2000	720 ~ 2940	4.70	A
1.6 + 1.6 + 3.5 + 5.0	11.7	1.29	1.29	2.81	4.01	9.40	4.2 ~ 10.6	1980	800 ~ 2890	4.75	A
1.6 + 1.6 + 3.5 + 6.0	12.7	1.18	1.18	2.59	4.45	9.40	4.2 ~ 10.6	1980	800 ~ 2890	4.75	A
1.6 + 1.6 + 3.5 + 7.1	13.8	1.09	1.09	2.38	4.84	9.40	4.2 ~ 10.6	1970	800 ~ 2870	4.77	A
1.6 + 1.6 + 4.2 + 4.2	11.6	1.30	1.30	3.40	3.40	9.40	4.2 ~ 10.6	2000	720 ~ 2930	4.70	A
1.6 + 1.6 + 4.2 + 5.0	12.4	1.21	1.21	3.18	3.80	9.40	4.2 ~ 10.6	1970	800 ~ 2880	4.77	A
1.6 + 1.6 + 4.2 + 6.0	13.4	1.12	1.12	2.95	4.21	9.40	4.2 ~ 10.6	1970	800 ~ 2880	4.77	A
1.6 + 1.6 + 4.2 + 7.1	14.5	1.04	1.04	2.72	4.60	9.40	4.2 ~ 10.6	1970	810 ~ 2870	4.77	A
1.6 + 1.6 + 5.0 + 5.0	13.2	1.14	1.14	3.56	3.56	9.40	4.2 ~ 10.6	2010	920 ~ 2850	4.68	A
1.6 + 1.6 + 5.0 + 6.0	14.2	1.06	1.06	3.31	3.97	9.40	4.2 ~ 10.6	2010	920 ~ 2850	4.68	A
1.6 + 2.0 + 2.0 + 2.0	7.6	1.99	2.47	2.47	2.47	9.40	4.2 ~ 10.6	2040	690 ~ 3000	4.61	A
1.6 + 2.0 + 2.0 + 2.5	8.1	1.86	2.32	2.32	2.90	9.40	4.2 ~ 10.6	2040	690 ~ 3000	4.61	A
1.6 + 2.0 + 2.0 + 3.5	9.1	1.65	2.07	2.07	3.61	9.40	4.2 ~ 10.6	2020	710 ~ 2970	4.65	A
1.6 + 2.0 + 2.0 + 4.2	9.8	1.53	1.92	1.92	4.03	9.40	4.2 ~ 10.6	2010	710 ~ 2960	4.68	A
1.6 + 2.0 + 2.0 + 5.0	10.6	1.42	1.77	1.77	4.44	9.40	4.2 ~ 10.6	1990	790 ~ 2900	4.72	A
1.6 + 2.0 + 2.0 + 6.0	11.6	1.30	1.62	1.62	4.86	9.40	4.2 ~ 10.6	1990	790 ~ 2900	4.72	A
1.6 + 2.0 + 2.0 + 7.1	12.7	1.18	1.48	1.48	5.26	9.40	4.2 ~ 10.6	1980	800 ~ 2890	4.75	A
1.6 + 2.0 + 2.5 + 2.5	8.6	1.75	2.19	2.73	2.73	9.40	4.2 ~ 10.6	2040	690 ~ 3000	4.61	A
1.6 + 2.0 + 2.5 + 3.5	9.6	1.57	1.96	2.45	3.42	9.40	4.2 ~ 10.6	2020	710 ~ 2970	4.65	A
1.6 + 2.0 + 2.5 + 4.2	10.3	1.46	1.83	2.28	3.83	9.40	4.2 ~ 10.6	2010	710 ~ 2960	4.68	A
1.6 + 2.0 + 2.5 + 5.0	11.1	1.35	1.69	2.12	4.24	9.40	4.2 ~ 10.6	1990	790 ~ 2900	4.72	A
1.6 + 2.0 + 2.5 + 6.0	12.1	1.24	1.55	1.94	4.67	9.40	4.2 ~ 10.6	1990	790 ~ 2900	4.72	A
1.6 + 2.0 + 2.5 + 7.1	13.2	1.14	1.42	1.78	5.06	9.40	4.2 ~ 10.6	1980	800 ~ 2890	4.75	A
1.6 + 2.0 + 3.5 + 3.5	10.6	1.42	1.78	3.10	3.10	9.40	4.2 ~ 10.6	2000	720 ~ 2940	4.70	A
1.6 + 2.0 + 3.5 + 4.2	11.3	1.33	1.66	2.91	3.50	9.40	4.2 ~ 10.6	2000	720 ~ 2930	4.70	A
1.6 + 2.0 + 3.5 + 5.0	12.1	1.24	1.55	2.72	3.89	9.40	4.2 ~ 10.6	1970	800 ~ 2880	4.77	A
1.6 + 2.0 + 3.5 + 6.0	13.1	1.15	1.44	2.51	4.30	9.40	4.2 ~ 10.6	1970	800 ~ 2880	4.77	A
1.6 + 2.0 + 3.5 + 7.1	14.2	1.06	1.32	2.32	4.70	9.40	4.2 ~ 10.6	1970	810 ~ 2870	4.77	A
1.6 + 2.0 + 4.2 + 4.2	12.0	1.25	1.57	3.29	3.29	9.40	4.2 ~ 10.6	1990	720 ~ 2920	4.72	A
1.6 + 2.0 + 4.2 + 5.0	12.8	1.18	1.47	3.08	3.67	9.40	4.2 ~ 10.6	1970	810 ~ 2870	4.77	A
1.6 + 2.0 + 4.2 + 6.0	13.8	1.09	1.36	2.86	4.09	9.40	4.2 ~ 10.6	1970	810 ~ 2870	4.77	A
1.6 + 2.0 + 5.0 + 5.0	13.6	1.10	1.38	3.46	3.46	9.40	4.2 ~ 10.6	2010	930 ~ 2900	4.68	A
1.6 + 2.0 + 5.0 + 6.0	14.6	1.03	1.29	3.22	3.86	9.40	4.2 ~ 10.6	2010	930 ~ 2900	4.68	A
1.6 + 2.5 + 2.5 + 2.5	9.1	1.66	2.58	2.58	2.58	9.40	4.2 ~ 10.6	2040	690 ~ 3000	4.61	A
1.6 + 2.5 + 2.5 + 3.5	10.1	1.49	2.33	2.33	3.25	9.40	4.2 ~ 10.6	2020	710 ~ 2970	4.65	A
1.6 + 2.5 + 2.5 + 4.2	10.8	1.39	2.18	2.18	3.65	9.40	4.2 ~ 10.6	2010	710 ~ 2960	4.68	A

Indoor unit capacity Heating	Annual Energy Consumption (kWh)	Current 230V (A)	ERP				Moisture Removal Volume l/h
			Pdesign (kW)	SCOP		Annual Consumption (kWh)	
				W/W	CLASS		
1.6 + 1.6 + 1.6 + 1.6	1035	9.7	6.80	4.60	A++	2070	
1.6 + 1.6 + 1.6 + 2.0	1030	9.7	6.80	4.60	A++	2070	
1.6 + 1.6 + 1.6 + 2.5	1030	9.7	6.80	4.60	A++	2070	
1.6 + 1.6 + 1.6 + 3.5	1020	9.6	6.80	4.70	A++	2026	
1.6 + 1.6 + 1.6 + 4.2	1015	9.5	6.80	4.70	A++	2026	
1.6 + 1.6 + 1.6 + 5.0	1000	9.4	6.80	4.70	A++	2026	
1.6 + 1.6 + 1.6 + 6.0	1000	9.4	6.80	4.70	A++	2026	
1.6 + 1.6 + 1.6 + 7.1	995	9.4	6.80	4.70	A++	2026	
1.6 + 1.6 + 2.0 + 2.0	1025	9.6	6.80	4.60	A++	2070	
1.6 + 1.6 + 2.0 + 2.5	1025	9.6	6.80	4.60	A++	2070	
1.6 + 1.6 + 2.0 + 3.5	1015	9.5	6.80	4.70	A++	2026	
1.6 + 1.6 + 2.0 + 4.2	1010	9.5	6.80	4.70	A++	2026	
1.6 + 1.6 + 2.0 + 5.0	995	9.4	6.80	4.70	A++	2026	
1.6 + 1.6 + 2.0 + 6.0	995	9.4	6.80	4.70	A++	2026	
1.6 + 1.6 + 2.0 + 7.1	990	9.3	6.80	4.70	A++	2026	
1.6 + 1.6 + 2.5 + 2.5	1025	9.6	6.80	4.70	A++	2026	
1.6 + 1.6 + 2.5 + 3.5	1015	9.5	6.80	4.70	A++	2026	
1.6 + 1.6 + 2.5 + 4.2	1010	9.5	6.80	4.70	A++	2026	
1.6 + 1.6 + 2.5 + 5.0	995	9.4	6.80	4.70	A++	2026	
1.6 + 1.6 + 2.5 + 6.0	995	9.4	6.80	4.70	A++	2026	
1.6 + 1.6 + 2.5 + 7.1	990	9.3	6.80	4.70	A++	2026	
1.6 + 1.6 + 3.5 + 3.5	1005	9.4	6.80	4.70	A++	2026	
1.6 + 1.6 + 3.5 + 4.2	1000	9.4	6.80	4.70	A++	2026	
1.6 + 1.6 + 3.5 + 5.0	990	9.3	6.80	4.70	A++	2026	
1.6 + 1.6 + 3.5 + 6.0	990	9.3	6.80	4.70	A++	2026	
1.6 + 1.6 + 3.5 + 7.1	985	9.3	6.80	4.70	A++	2026	
1.6 + 1.6 + 4.2 + 4.2	1000	9.4	6.80	4.70	A++	2026	
1.6 + 1.6 + 4.2 + 5.0	985	9.3	6.80	4.70	A++	2026	
1.6 + 1.6 + 4.2 + 6.0	985	9.3	6.80	4.70	A++	2026	
1.6 + 1.6 + 4.2 + 7.1	985	9.3	6.80	4.70	A++	2026	
1.6 + 1.6 + 5.0 + 5.0	1005	9.4	6.80	4.70	A++	2026	
1.6 + 1.6 + 5.0 + 6.0	1005	9.4	6.80	4.70	A++	2026	
1.6 + 2.0 + 2.0 + 2.0	1020	9.6	6.80	4.60	A++	2070	
1.6 + 2.0 + 2.0 + 2.5	1020	9.6	6.80	4.70	A++	2026	
1.6 + 2.0 + 2.0 + 3.5	1010	9.5	6.80	4.70	A++	2026	
1.6 + 2.0 + 2.0 + 4.2	1005	9.4	6.80	4.70	A++	2026	
1.6 + 2.0 + 2.0 + 5.0	995	9.4	6.80	4.70	A++	2026	
1.6 + 2.0 + 2.0 + 6.0	995	9.4	6.80	4.70	A++	2026	
1.6 + 2.0 + 2.0 + 7.1	990	9.3	6.80	4.70	A++	2026	
1.6 + 2.0 + 2.5 + 2.5	1020	9.6	6.80	4.70	A++	2026	
1.6 + 2.0 + 2.5 + 3.5	1010	9.5	6.80	4.70	A++	2026	
1.6 + 2.0 + 2.5 + 4.2	1005	9.4	6.80	4.70	A++	2026	
1.6 + 2.0 + 2.5 + 5.0	995	9.4	6.80	4.70	A++	2026	
1.6 + 2.0 + 2.5 + 6.0	995	9.4	6.80	4.70	A++	2026	
1.6 + 2.0 + 2.5 + 7.1	990	9.3	6.80	4.70	A++	2026	
1.6 + 2.0 + 3.5 + 3.5	1000	9.4	6.80	4.70	A++	2026	
1.6 + 2.0 + 3.5 + 4.2	1000	9.4	6.80	4.70	A++	2026	
1.6 + 2.0 + 3.5 + 5.0	985	9.3	6.80	4.70	A++	2026	
1.6 + 2.0 + 3.5 + 6.0	985	9.3	6.80	4.70	A++	2026	
1.6 + 2.0 + 3.5 + 7.1	985	9.3	6.80	4.70	A++	2026	
1.6 + 2.0 + 4.2 + 4.2	995	9.4	6.80	4.70	A++	2026	
1.6 + 2.0 + 4.2 + 5.0	985	9.3	6.80	4.70	A++	2026	
1.6 + 2.0 + 4.2 + 6.0	985	9.3	6.80	4.70	A++	2026	
1.6 + 2.0 + 5.0 + 5.0	1005	9.4	6.80	4.70	A++	2026	
1.6 + 2.0 + 5.0 + 6.0	1005	9.4	6.80	4.70	A++	2026	
1.6 + 2.5 + 2.5 + 2.5	1020	9.6	6.80	4.70	A++	2026	
1.6 + 2.5 + 2.5 + 3.5	1010	9.5	6.80	4.70	A++	2026	
1.6 + 2.5 + 2.5 + 4.2	1005	9.4	6.80	4.70	A++	2026	

4 Room

Indoor unit capacity Heating	Total	Heating Capacity (kW)					Input Power (W)		COP		
		Room A	Room B	Room C	Room D	Total	min ~ max	Rating	min ~ max	W/W	CLASS
1.6 + 2.5 + 2.5 + 5.0	11.6	1.30	2.03	2.03	4.04	9.40	4.2 ~ 10.6	1990	790 ~ 2900	4.72	A
1.6 + 2.5 + 2.5 + 6.0	12.6	1.19	1.87	1.87	4.47	9.40	4.2 ~ 10.6	1990	790 ~ 2900	4.72	A
1.6 + 2.5 + 2.5 + 7.1	13.7	1.10	1.72	1.72	4.86	9.40	4.2 ~ 10.6	1980	800 ~ 2890	4.75	A
1.6 + 2.5 + 3.5 + 3.5	11.1	1.35	2.13	2.96	2.96	9.40	4.2 ~ 10.6	2000	720 ~ 2940	4.70	A
1.6 + 2.5 + 3.5 + 4.2	11.8	1.27	1.99	2.79	3.35	9.40	4.2 ~ 10.6	2000	720 ~ 2930	4.70	A
1.6 + 2.5 + 3.5 + 5.0	12.6	1.19	1.87	2.61	3.73	9.40	4.2 ~ 10.6	1970	800 ~ 2880	4.77	A
1.6 + 2.5 + 3.5 + 6.0	13.6	1.10	1.73	2.42	4.15	9.40	4.2 ~ 10.6	1970	800 ~ 2880	4.77	A
1.6 + 2.5 + 3.5 + 7.1	14.7	1.02	1.60	2.24	4.54	9.40	4.2 ~ 10.6	1970	810 ~ 2870	4.77	A
1.6 + 2.5 + 4.2 + 4.2	12.5	1.20	1.88	3.16	3.16	9.40	4.2 ~ 10.6	1990	720 ~ 2920	4.72	A
1.6 + 2.5 + 4.2 + 5.0	13.3	1.13	1.77	2.97	3.53	9.40	4.2 ~ 10.6	1970	810 ~ 2870	4.77	A
1.6 + 2.5 + 4.2 + 6.0	14.3	1.05	1.64	2.76	3.95	9.40	4.2 ~ 10.6	1970	810 ~ 2870	4.77	A
1.6 + 2.5 + 5.0 + 5.0	14.1	1.07	1.67	3.33	3.33	9.40	4.2 ~ 10.6	2010	930 ~ 2900	4.68	A
1.6 + 3.5 + 3.5 + 3.5	12.1	1.24	2.72	2.72	2.72	9.40	4.2 ~ 10.6	1980	720 ~ 2910	4.75	A
1.6 + 3.5 + 3.5 + 4.2	12.8	1.18	2.57	2.57	3.08	9.40	4.2 ~ 10.6	1980	750 ~ 2900	4.75	A
1.6 + 3.5 + 3.5 + 5.0	13.6	1.11	2.42	2.42	3.45	9.40	4.2 ~ 10.6	2000	840 ~ 2860	4.70	A
1.6 + 3.5 + 3.5 + 6.0	14.6	1.03	2.25	2.25	3.87	9.40	4.2 ~ 10.6	2000	840 ~ 2860	4.70	A
1.6 + 3.5 + 4.2 + 4.2	13.5	1.11	2.45	2.92	2.92	9.40	4.2 ~ 10.6	1970	750 ~ 2890	4.77	A
1.6 + 3.5 + 4.2 + 5.0	14.3	1.05	2.30	2.76	3.29	9.40	4.2 ~ 10.6	2000	840 ~ 2850	4.70	A
1.6 + 4.2 + 4.2 + 4.2	14.2	1.06	2.78	2.78	2.78	9.40	4.2 ~ 10.6	1970	760 ~ 2880	4.77	A
2.0 + 2.0 + 2.0 + 2.0	8.0	2.35	2.35	2.35	2.35	9.40	4.2 ~ 10.6	2030	690 ~ 2990	4.63	A
2.0 + 2.0 + 2.0 + 2.5	8.5	2.21	2.21	2.21	2.77	9.40	4.2 ~ 10.6	2030	690 ~ 2990	4.63	A
2.0 + 2.0 + 2.0 + 3.5	9.5	1.98	1.98	1.98	3.46	9.40	4.2 ~ 10.6	2010	710 ~ 2960	4.68	A
2.0 + 2.0 + 2.0 + 4.2	10.2	1.84	1.84	1.84	3.88	9.40	4.2 ~ 10.6	2010	720 ~ 2950	4.68	A
2.0 + 2.0 + 2.0 + 5.0	11.0	1.71	1.71	1.71	4.27	9.40	4.2 ~ 10.6	1980	800 ~ 2890	4.75	A
2.0 + 2.0 + 2.0 + 6.0	12.0	1.57	1.57	1.57	4.69	9.40	4.2 ~ 10.6	1980	800 ~ 2890	4.75	A
2.0 + 2.0 + 2.0 + 7.1	13.1	1.44	1.44	1.44	5.08	9.40	4.2 ~ 10.6	1970	800 ~ 2880	4.77	A
2.0 + 2.0 + 2.5 + 2.5	9.0	2.09	2.09	2.61	2.61	9.40	4.2 ~ 10.6	2030	690 ~ 2990	4.63	A
2.0 + 2.0 + 2.5 + 3.5	10.0	1.88	1.88	2.35	3.29	9.40	4.2 ~ 10.6	2010	710 ~ 2960	4.68	A
2.0 + 2.0 + 2.5 + 4.2	10.7	1.76	1.76	2.20	3.68	9.40	4.2 ~ 10.6	2010	720 ~ 2950	4.68	A
2.0 + 2.0 + 2.5 + 5.0	11.5	1.63	1.63	2.04	4.10	9.40	4.2 ~ 10.6	1980	800 ~ 2890	4.75	A
2.0 + 2.0 + 2.5 + 6.0	12.5	1.50	1.50	1.88	4.52	9.40	4.2 ~ 10.6	1980	800 ~ 2890	4.75	A
2.0 + 2.0 + 2.5 + 7.1	13.6	1.38	1.38	1.73	4.91	9.40	4.2 ~ 10.6	1970	800 ~ 2880	4.77	A
2.0 + 2.0 + 3.5 + 3.5	11.0	1.71	1.71	2.99	2.99	9.40	4.2 ~ 10.6	2000	720 ~ 2930	4.70	A
2.0 + 2.0 + 3.5 + 4.2	11.7	1.61	1.61	2.81	3.37	9.40	4.2 ~ 10.6	1990	720 ~ 2920	4.72	A
2.0 + 2.0 + 3.5 + 5.0	12.5	1.50	1.50	2.63	3.77	9.40	4.2 ~ 10.6	1970	810 ~ 2870	4.77	A
2.0 + 2.0 + 3.5 + 6.0	13.5	1.39	1.39	2.44	4.18	9.40	4.2 ~ 10.6	1970	810 ~ 2870	4.77	A
2.0 + 2.0 + 3.5 + 7.1	14.6	1.29	1.29	2.25	4.57	9.40	4.2 ~ 10.6	2000	830 ~ 2860	4.70	A
2.0 + 2.0 + 4.2 + 4.2	12.4	1.52	1.52	3.18	3.18	9.40	4.2 ~ 10.6	1980	720 ~ 2910	4.75	A
2.0 + 2.0 + 4.2 + 5.0	13.2	1.42	1.42	2.99	3.57	9.40	4.2 ~ 10.6	2000	810 ~ 2860	4.70	A
2.0 + 2.0 + 4.2 + 6.0	14.2	1.32	1.32	2.78	3.98	9.40	4.2 ~ 10.6	2000	810 ~ 2860	4.70	A
2.0 + 2.0 + 5.0 + 5.0	14.0	1.34	1.34	3.36	3.36	9.40	4.2 ~ 10.6	2010	940 ~ 2890	4.68	A
2.0 + 2.5 + 2.5 + 2.5	9.5	1.99	2.47	2.47	2.47	9.40	4.2 ~ 10.6	2030	690 ~ 2990	4.63	A
2.0 + 2.5 + 2.5 + 3.5	10.5	1.79	2.24	2.24	3.13	9.40	4.2 ~ 10.6	2010	710 ~ 2960	4.68	A
2.0 + 2.5 + 2.5 + 4.2	11.2	1.68	2.10	2.10	3.52	9.40	4.2 ~ 10.6	2010	720 ~ 2950	4.68	A
2.0 + 2.5 + 2.5 + 5.0	12.0	1.57	1.96	1.96	3.91	9.40	4.2 ~ 10.6	1980	800 ~ 2890	4.75	A
2.0 + 2.5 + 2.5 + 6.0	13.0	1.45	1.81	1.81	4.33	9.40	4.2 ~ 10.6	1980	800 ~ 2890	4.75	A
2.0 + 2.5 + 2.5 + 7.1	14.1	1.33	1.67	1.67	4.73	9.40	4.2 ~ 10.6	1970	800 ~ 2880	4.77	A
2.0 + 2.5 + 3.5 + 3.5	11.5	1.63	2.05	2.86	2.86	9.40	4.2 ~ 10.6	2000	720 ~ 2930	4.70	A
2.0 + 2.5 + 3.5 + 4.2	12.2	1.54	1.93	2.70	3.23	9.40	4.2 ~ 10.6	1990	720 ~ 2920	4.72	A
2.0 + 2.5 + 3.5 + 5.0	13.0	1.45	1.81	2.53	3.61	9.40	4.2 ~ 10.6	1970	810 ~ 2870	4.77	A
2.0 + 2.5 + 3.5 + 6.0	14.0	1.34	1.68	2.35	4.03	9.40	4.2 ~ 10.6	1970	810 ~ 2870	4.77	A
2.0 + 2.5 + 4.2 + 4.2	12.9	1.46	1.82	3.06	3.06	9.40	4.2 ~ 10.6	1980	720 ~ 2910	4.75	A
2.0 + 2.5 + 4.2 + 5.0	13.7	1.37	1.72	2.88	3.43	9.40	4.2 ~ 10.6	2000	810 ~ 2860	4.70	A
2.0 + 2.5 + 4.2 + 6.0	14.7	1.28	1.60	2.69	3.83	9.40	4.2 ~ 10.6	2000	810 ~ 2860	4.70	A
2.0 + 2.5 + 5.0 + 5.0	14.5	1.30	1.62	3.24	3.24	9.40	4.2 ~ 10.6	2010	940 ~ 2890	4.68	A
2.0 + 3.5 + 3.5 + 3.5	12.5	1.51	2.63	2.63	2.63	9.40	4.2 ~ 10.6	1980	750 ~ 2900	4.75	A
2.0 + 3.5 + 3.5 + 4.2	13.2	1.42	2.49	2.49	3.00	9.40	4.2 ~ 10.6	1970	750 ~ 2890	4.77	A
2.0 + 3.5 + 3.5 + 5.0	14.0	1.34	2.35	2.35	3.36	9.40	4.2 ~ 10.6	2000	840 ~ 2850	4.70	A



Indoor unit capacity Heating	Annual Energy Consumption (kWh)	Current 230V (A)	ERP				Moisture Removal Volume l/h
			Pdesign (kW)	SCOP		Annual Consumption (kWh)	
				W/W	CLASS		
1.6 + 2.5 + 2.5 + 5.0	995	9.4	6.80	4.70	A++	2026	
1.6 + 2.5 + 2.5 + 6.0	995	9.4	6.80	4.70	A++	2026	
1.6 + 2.5 + 2.5 + 7.1	990	9.3	6.80	4.70	A++	2026	
1.6 + 2.5 + 3.5 + 3.5	1000	9.4	6.80	4.70	A++	2026	
1.6 + 2.5 + 3.5 + 4.2	1000	9.4	6.80	4.70	A++	2026	
1.6 + 2.5 + 3.5 + 5.0	985	9.3	6.80	4.70	A++	2026	
1.6 + 2.5 + 3.5 + 6.0	985	9.3	6.80	4.70	A++	2026	
1.6 + 2.5 + 3.5 + 7.1	985	9.3	6.80	4.70	A++	2026	
1.6 + 2.5 + 4.2 + 4.2	995	9.4	6.80	4.70	A++	2026	
1.6 + 2.5 + 4.2 + 5.0	985	9.3	6.80	4.70	A++	2026	
1.6 + 2.5 + 4.2 + 6.0	985	9.3	6.80	4.70	A++	2026	
1.6 + 2.5 + 5.0 + 5.0	1005	9.4	6.80	4.70	A++	2026	
1.6 + 3.5 + 3.5 + 3.5	990	9.3	6.80	4.70	A++	2026	
1.6 + 3.5 + 3.5 + 4.2	990	9.3	6.80	4.70	A++	2026	
1.6 + 3.5 + 3.5 + 5.0	1000	9.4	6.80	4.70	A++	2026	
1.6 + 3.5 + 3.5 + 6.0	1000	9.4	6.80	4.70	A++	2026	
1.6 + 3.5 + 4.2 + 4.2	985	9.3	6.80	4.70	A++	2026	
1.6 + 3.5 + 4.2 + 5.0	1000	9.4	6.80	4.70	A++	2026	
1.6 + 4.2 + 4.2 + 4.2	985	9.3	6.80	4.70	A++	2026	
2.0 + 2.0 + 2.0 + 2.0	1015	9.5	6.80	4.70	A++	2026	
2.0 + 2.0 + 2.0 + 2.5	1015	9.5	6.80	4.70	A++	2026	
2.0 + 2.0 + 2.0 + 3.5	1005	9.4	6.80	4.70	A++	2026	
2.0 + 2.0 + 2.0 + 4.2	1005	9.4	6.80	4.70	A++	2026	
2.0 + 2.0 + 2.0 + 5.0	990	9.3	6.80	4.70	A++	2026	
2.0 + 2.0 + 2.0 + 6.0	990	9.3	6.80	4.70	A++	2026	
2.0 + 2.0 + 2.0 + 7.1	985	9.3	6.80	4.70	A++	2026	
2.0 + 2.0 + 2.5 + 2.5	1015	9.5	6.80	4.70	A++	2026	
2.0 + 2.0 + 2.5 + 3.5	1005	9.4	6.80	4.70	A++	2026	
2.0 + 2.0 + 2.5 + 4.2	1005	9.4	6.80	4.70	A++	2026	
2.0 + 2.0 + 2.5 + 5.0	990	9.3	6.80	4.70	A++	2026	
2.0 + 2.0 + 2.5 + 6.0	990	9.3	6.80	4.70	A++	2026	
2.0 + 2.0 + 2.5 + 7.1	985	9.3	6.80	4.70	A++	2026	
2.0 + 2.0 + 3.5 + 3.5	1000	9.4	6.80	4.70	A++	2026	
2.0 + 2.0 + 3.5 + 4.2	995	9.4	6.80	4.70	A++	2026	
2.0 + 2.0 + 3.5 + 5.0	985	9.3	6.80	4.70	A++	2026	
2.0 + 2.0 + 3.5 + 6.0	985	9.3	6.80	4.70	A++	2026	
2.0 + 2.0 + 3.5 + 7.1	1000	9.4	6.80	4.70	A++	2026	
2.0 + 2.0 + 4.2 + 4.2	990	9.3	6.80	4.70	A++	2026	
2.0 + 2.0 + 4.2 + 5.0	1000	9.4	6.80	4.70	A++	2026	
2.0 + 2.0 + 4.2 + 6.0	1000	9.4	6.80	4.70	A++	2026	
2.0 + 2.0 + 5.0 + 5.0	1005	9.4	6.80	4.70	A++	2026	
2.0 + 2.5 + 2.5 + 2.5	1015	9.5	6.80	4.70	A++	2026	
2.0 + 2.5 + 2.5 + 3.5	1005	9.4	6.80	4.70	A++	2026	
2.0 + 2.5 + 2.5 + 4.2	1005	9.4	6.80	4.70	A++	2026	
2.0 + 2.5 + 2.5 + 5.0	990	9.3	6.80	4.70	A++	2026	
2.0 + 2.5 + 2.5 + 6.0	990	9.3	6.80	4.70	A++	2026	
2.0 + 2.5 + 2.5 + 7.1	985	9.3	6.80	4.70	A++	2026	
2.0 + 2.5 + 3.5 + 3.5	1000	9.4	6.80	4.70	A++	2026	
2.0 + 2.5 + 3.5 + 4.2	995	9.4	6.80	4.70	A++	2026	
2.0 + 2.5 + 3.5 + 5.0	985	9.3	6.80	4.70	A++	2026	
2.0 + 2.5 + 3.5 + 6.0	985	9.3	6.80	4.70	A++	2026	
2.0 + 2.5 + 4.2 + 4.2	990	9.3	6.80	4.70	A++	2026	
2.0 + 2.5 + 4.2 + 5.0	1000	9.4	6.80	4.70	A++	2026	
2.0 + 2.5 + 4.2 + 6.0	1000	9.4	6.80	4.70	A++	2026	
2.0 + 2.5 + 5.0 + 5.0	1005	9.4	6.80	4.70	A++	2026	
2.0 + 3.5 + 3.5 + 3.5	990	9.3	6.80	4.70	A++	2026	
2.0 + 3.5 + 3.5 + 4.2	985	9.3	6.80	4.70	A++	2026	
2.0 + 3.5 + 3.5 + 5.0	1000	9.4	6.80	4.70	A++	2026	

4 Room

Indoor unit capacity Heating		Total	Heating Capacity (kW)					Input Power (W)		COP		
			Room A	Room B	Room C	Room D	Total	min ~ max	Rating	min ~ max	W/W	CLASS
4 Room	2.0 + 3.5 + 4.2 + 4.2	13.9	1.35	2.37	2.84	2.84	9.40	4.2 ~ 10.6	1970	760 ~ 2880	4.77	A
	2.0 + 3.5 + 4.2 + 5.0	14.7	1.28	2.24	2.69	3.19	9.40	4.2 ~ 10.6	1990	850 ~ 2840	4.72	A
	2.0 + 4.2 + 4.2 + 4.2	14.6	1.30	2.70	2.70	2.70	9.40	4.2 ~ 10.6	2000	760 ~ 2870	4.70	A
	2.5 + 2.5 + 2.5 + 2.5	10.0	2.35	2.35	2.35	2.35	9.40	4.2 ~ 10.6	2030	690 ~ 2990	4.63	A
	2.5 + 2.5 + 2.5 + 3.5	11.0	2.14	2.14	2.14	2.98	9.40	4.2 ~ 10.6	2010	710 ~ 2960	4.68	A
	2.5 + 2.5 + 2.5 + 4.2	11.7	2.01	2.01	2.01	3.37	9.40	4.2 ~ 10.6	2010	720 ~ 2950	4.68	A
	2.5 + 2.5 + 2.5 + 5.0	12.5	1.88	1.88	1.88	3.76	9.40	4.2 ~ 10.6	1980	800 ~ 2890	4.75	A
	2.5 + 2.5 + 2.5 + 6.0	13.5	1.74	1.74	1.74	4.18	9.40	4.2 ~ 10.6	1980	800 ~ 2890	4.75	A
	2.5 + 2.5 + 2.5 + 7.1	14.6	1.61	1.61	1.61	4.57	9.40	4.2 ~ 10.6	1970	800 ~ 2880	4.77	A
	2.5 + 2.5 + 3.5 + 3.5	12.0	1.96	1.96	2.74	2.74	9.40	4.2 ~ 10.6	2000	720 ~ 2930	4.70	A
	2.5 + 2.5 + 3.5 + 4.2	12.7	1.85	1.85	2.59	3.11	9.40	4.2 ~ 10.6	1990	720 ~ 2920	4.72	A
	2.5 + 2.5 + 3.5 + 5.0	13.5	1.74	1.74	2.44	3.48	9.40	4.2 ~ 10.6	1970	810 ~ 2870	4.77	A
	2.5 + 2.5 + 3.5 + 6.0	14.5	1.62	1.62	2.27	3.89	9.40	4.2 ~ 10.6	1970	810 ~ 2870	4.77	A
	2.5 + 2.5 + 4.2 + 4.2	13.4	1.75	1.75	2.95	2.95	9.40	4.2 ~ 10.6	1980	720 ~ 2910	4.75	A
	2.5 + 2.5 + 4.2 + 5.0	14.2	1.65	1.65	2.78	3.32	9.40	4.2 ~ 10.6	2000	810 ~ 2860	4.70	A
	2.5 + 3.5 + 3.5 + 3.5	13.0	1.81	2.53	2.53	2.53	9.40	4.2 ~ 10.6	1980	750 ~ 2900	4.75	A
	2.5 + 3.5 + 3.5 + 4.2	13.7	1.72	2.40	2.40	2.88	9.40	4.2 ~ 10.6	1970	750 ~ 2890	4.77	A
	2.5 + 3.5 + 3.5 + 5.0	14.5	1.62	2.27	2.27	3.24	9.40	4.2 ~ 10.6	2000	840 ~ 2850	4.70	A
	2.5 + 3.5 + 4.2 + 4.2	14.4	1.63	2.29	2.74	2.74	9.40	4.2 ~ 10.6	1970	760 ~ 2880	4.77	A
	3.5 + 3.5 + 3.5 + 3.5	14.0	2.35	2.35	2.35	2.35	9.40	4.2 ~ 10.6	2000	760 ~ 2870	4.70	A
3.5 + 3.5 + 3.5 + 4.2	14.7	2.24	2.24	2.24	2.68	9.40	4.2 ~ 10.6	2000	760 ~ 2860	4.70	A	

Indoor unit capacity Heating	Annual Energy Consumption (kWh)	Current 230V (A)	ERP				Moisture Removal Volume l/h	
			Pdesign (kW)	SCOP		Annual Consumption (kWh)		
				W/W	CLASS			
4 Room	2.0 + 3.5 + 4.2 + 4.2	985	9.3	6.80	4.70	A++	2026	
	2.0 + 3.5 + 4.2 + 5.0	995	9.4	6.80	4.70	A++	2026	
	2.0 + 4.2 + 4.2 + 4.2	1000	9.4	6.80	4.70	A++	2026	
	2.5 + 2.5 + 2.5 + 2.5	1015	9.5	6.80	4.70	A++	2026	
	2.5 + 2.5 + 2.5 + 3.5	1005	9.4	6.80	4.70	A++	2026	
	2.5 + 2.5 + 2.5 + 4.2	1005	9.4	6.80	4.70	A++	2026	
	2.5 + 2.5 + 2.5 + 5.0	990	9.3	6.80	4.70	A++	2026	
	2.5 + 2.5 + 2.5 + 6.0	990	9.3	6.80	4.70	A++	2026	
	2.5 + 2.5 + 2.5 + 7.1	985	9.3	6.80	4.70	A++	2026	
	2.5 + 2.5 + 3.5 + 3.5	1000	9.4	6.80	4.70	A++	2026	
	2.5 + 2.5 + 3.5 + 4.2	995	9.4	6.80	4.70	A++	2026	
	2.5 + 2.5 + 3.5 + 5.0	985	9.3	6.80	4.70	A++	2026	
	2.5 + 2.5 + 3.5 + 6.0	985	9.3	6.80	4.70	A++	2026	
	2.5 + 2.5 + 4.2 + 4.2	990	9.3	6.80	4.70	A++	2026	
	2.5 + 2.5 + 4.2 + 5.0	1000	9.4	6.80	4.70	A++	2026	
	2.5 + 3.5 + 3.5 + 3.5	990	9.3	6.80	4.70	A++	2026	
	2.5 + 3.5 + 3.5 + 4.2	985	9.3	6.80	4.70	A++	2026	
	2.5 + 3.5 + 3.5 + 5.0	1000	9.4	6.80	4.70	A++	2026	
	2.5 + 3.5 + 4.2 + 4.2	985	9.3	6.80	4.70	A++	2026	
	3.5 + 3.5 + 3.5 + 3.5	1000	9.4	6.80	4.70	A++	2026	
3.5 + 3.5 + 3.5 + 4.2	1000	9.4	6.80	4.70	A++	2026		

- Indoor Unit : Combination of all wall mount series (CS-MZ / Z / XZ / MTZ / TZ / TE)
- Outdoor Unit : CU-4Z80TBE

Indoor unit capacity Cooling	Total	Cooling Capacity (kW)						Input Power (W)		EER		
		Room A	Room B	Room C	Room D	Total	min ~ max	Rating	min ~ max	W/W	CLASS	
1 Room	1.6	1.6	1.60				1.60	1.3 0.0 2.3	420	250 ~ 660	3.81	A
	2.0	2.0	2.00				2.00	1.8 ~ 2.9	520	340 ~ 830	3.85	A
	2.5	2.5	2.50				2.50	1.8 ~ 2.9	650	340 ~ 830	3.85	A
	3.5	3.5	3.50				3.50	1.8 ~ 4.1	960	340 ~ 1380	3.65	A
	4.2	4.2	4.20				4.20	1.8 ~ 4.5	1390	340 ~ 2010	3.02	B
	5.0	5.0	5.00				5.00	1.9 ~ 5.7	1570	340 ~ 2150	3.18	B
	6.0	6.0	6.00				6.00	1.9 ~ 6.2	2050	340 ~ 2350	2.93	C
	7.1	7.1	7.10				7.10	2.0 ~ 7.2	2550	370 ~ 2790	2.78	D
2 Room	1.6 + 1.6	3.2	1.60	1.60			3.20	2.4 ~ 5.8	770	380 ~ 2030	4.16	A
	1.6 + 2.0	3.6	1.60	2.00			3.60	2.4 ~ 5.8	910	380 ~ 2030	3.96	A
	1.6 + 2.5	4.1	1.60	2.50			4.10	2.4 ~ 5.8	1110	380 ~ 2030	3.69	A
	1.6 + 3.5	5.1	1.60	3.50			5.10	2.4 ~ 5.8	1520	370 ~ 1960	3.36	A
	1.6 + 4.2	5.8	1.60	4.20			5.80	2.4 ~ 6.7	1860	370 ~ 2520	3.12	B
	1.6 + 5.0	6.6	1.60	5.00			6.60	2.4 ~ 7.2	2100	350 ~ 2520	3.14	B
	1.6 + 6.0	7.6	1.60	6.00			7.60	2.4 ~ 8.5	2730	350 ~ 3530	2.78	D
	1.6 + 7.1	8.7	1.47	6.53			8.00	2.5 ~ 8.5	2880	380 ~ 3380	2.78	D
	2.0 + 2.0	4.0	2.00	2.00			4.00	2.4 ~ 5.8	1050	380 ~ 1970	3.81	A
	2.0 + 2.5	4.5	2.00	2.50			4.50	2.4 ~ 5.8	1280	380 ~ 1970	3.52	A
	2.0 + 3.5	5.5	2.00	3.50			5.50	2.4 ~ 5.8	1690	370 ~ 1900	3.25	A
	2.0 + 4.2	6.2	2.00	4.20			6.20	2.4 ~ 7.2	2110	370 ~ 2940	2.94	C
	2.0 + 5.0	7.0	2.00	5.00			7.00	2.4 ~ 8.1	2250	350 ~ 3140	3.11	B
	2.0 + 6.0	8.0	2.00	6.00			8.00	2.4 ~ 8.5	2950	350 ~ 3530	2.71	D
	2.0 + 7.1	9.1	1.76	6.24			8.00	2.5 ~ 8.5	2810	380 ~ 3380	2.85	C
	2.5 + 2.5	5.0	2.50	2.50			5.00	2.4 ~ 5.8	1470	380 ~ 1970	3.40	A
	2.5 + 3.5	6.0	2.50	3.50			6.00	2.4 ~ 6.7	1980	370 ~ 2520	3.03	B
	2.5 + 4.2	6.7	2.50	4.20			6.70	2.4 ~ 7.2	2450	370 ~ 2940	2.73	D
	2.5 + 5.0	7.5	2.50	5.00			7.50	2.4 ~ 8.5	2590	350 ~ 3530	2.90	C
	2.5 + 6.0	8.5	2.35	5.65			8.00	2.5 ~ 8.5	2950	390 ~ 3530	2.71	D
	2.5 + 7.1	9.6	2.08	5.92			8.00	2.5 ~ 8.5	2810	380 ~ 3380	2.85	C
	3.5 + 3.5	7.0	3.50	3.50			7.00	2.4 ~ 8.1	2590	370 ~ 3670	2.70	D
	3.5 + 4.2	7.7	3.50	4.20			7.70	2.4 ~ 8.5	3080	370 ~ 4160	2.50	E
	3.5 + 5.0	8.5	3.29	4.71			8.00	2.5 ~ 8.5	2810	380 ~ 3380	2.85	C
	3.5 + 6.0	9.5	2.95	5.05			8.00	2.5 ~ 8.5	2810	380 ~ 3380	2.85	C
	3.5 + 7.1	10.6	2.64	5.36			8.00	2.5 ~ 8.6	2740	380 ~ 3380	2.92	C
	4.2 + 4.2	8.4	4.00	4.00			8.00	2.5 ~ 8.5	3380	400 ~ 4080	2.37	F
4.2 + 5.0	9.2	3.65	4.35			8.00	2.5 ~ 8.5	2810	380 ~ 3380	2.85	C	
4.2 + 6.0	10.2	3.29	4.71			8.00	2.5 ~ 8.6	2810	380 ~ 3460	2.85	C	
4.2 + 7.1	11.3	2.97	5.03			8.00	2.5 ~ 8.6	2740	380 ~ 3300	2.92	C	
5.0 + 5.0	10.0	4.00	4.00			8.00	2.5 ~ 8.6	2460	380 ~ 2990	3.25	A	
5.0 + 6.0	11.0	3.64	4.36			8.00	2.5 ~ 8.6	2460	380 ~ 2990	3.25	A	
5.0 + 7.1	12.1	3.31	4.69			8.00	2.5 ~ 8.6	2390	380 ~ 2920	3.35	A	
6.0 + 6.0	12.0	4.00	4.00			8.00	2.5 ~ 8.6	2460	380 ~ 2990	3.25	A	
6.0 + 7.1	13.1	3.66	4.34			8.00	2.5 ~ 8.6	2390	380 ~ 2920	3.35	A	
7.1 + 7.1	14.2	4.00	4.00			8.00	2.5 ~ 8.6	2320	410 ~ 2840	3.45	A	

	Indoor unit capacity Cooling	Annual Energy Consumption (kWh)	Current 230V (A)	ERP				Moisture Removal Volume l/h
				Pdesign (kW)	SEER		Annual Consumption (kWh)	
					WW	CLASS		
1 Room	1.6	210	2.1	-	-	-	-	1.0
	2.0	260	2.6	-	-	-	-	1.3
	2.5	325	3.2	-	-	-	-	1.5
	3.5	480	4.6	-	-	-	-	2.0
	4.2	695	6.5	-	-	-	-	2.4
	5.0	785	7.3	-	-	-	-	2.7
	6.0	1025	9.3	-	-	-	-	3.3
	7.1	1275	11.5	-	-	-	-	4.1
2 Room	1.6 + 1.6	385	3.9	3.20	5.10	A	220	1.0 + 1.0
	1.6 + 2.0	455	4.5	3.60	5.10	A	247	1.0 + 1.3
	1.6 + 2.5	555	5.4	4.10	5.10	A	281	1.0 + 1.5
	1.6 + 3.5	760	7.4	5.10	5.10	A	350	1.0 + 2.0
	1.6 + 4.2	930	8.9	5.80	5.10	A	398	1.0 + 2.4
	1.6 + 5.0	1050	10.1	6.60	5.10	A	453	1.0 + 2.7
	1.6 + 6.0	1365	13.1	7.60	5.10	A	522	1.0 + 3.3
	1.6 + 7.1	1440	13.8	8.00	5.10	A	549	0.9 + 3.7
	2.0 + 2.0	525	5.1	4.00	5.10	A	275	1.3 + 1.3
	2.0 + 2.5	640	6.2	4.50	5.10	A	309	1.3 + 1.5
	2.0 + 3.5	845	8.2	5.50	5.10	A	377	1.3 + 2.0
	2.0 + 4.2	1055	10.1	6.20	5.10	A	425	1.3 + 2.4
	2.0 + 5.0	1125	10.8	7.00	5.10	A	480	1.3 + 2.7
	2.0 + 6.0	1475	14.1	8.00	5.10	A	549	1.3 + 3.3
	2.0 + 7.1	1405	13.5	8.00	5.10	A	549	1.1 + 3.5
	2.5 + 2.5	735	7.1	5.00	5.10	A	343	1.5 + 1.5
	2.5 + 3.5	990	9.5	6.00	5.10	A	412	1.5 + 2.0
	2.5 + 4.2	1225	11.7	6.70	5.10	A	460	1.5 + 2.4
	2.5 + 5.0	1295	12.4	7.50	5.10	A	515	1.5 + 2.7
	2.5 + 6.0	1475	14.1	8.00	5.10	A	549	1.5 + 3.1
	2.5 + 7.1	1405	13.5	8.00	5.10	A	549	1.3 + 3.3
	3.5 + 3.5	1295	12.4	7.00	5.10	A	480	2.0 + 2.0
	3.5 + 4.2	1540	14.7	7.70	5.10	A	528	2.0 + 2.4
	3.5 + 5.0	1405	13.5	8.00	5.10	A	549	1.9 + 2.5
	3.5 + 6.0	1405	13.5	8.00	5.10	A	549	1.7 + 2.8
	3.5 + 7.1	1370	13.1	8.00	5.10	A	549	1.6 + 2.9
	4.2 + 4.2	1690	16.2	8.00	5.10	A	549	2.3 + 2.3
	4.2 + 5.0	1405	13.5	8.00	5.10	A	549	2.1 + 2.4
	4.2 + 6.0	1405	13.5	8.00	5.10	A	549	1.9 + 2.5
	4.2 + 7.1	1370	13.1	8.00	5.10	A	549	1.7 + 2.8
	5.0 + 5.0	1230	11.8	8.00	5.10	A	549	2.3 + 2.3
	5.0 + 6.0	1230	11.8	8.00	5.10	A	549	2.1 + 2.4
5.0 + 7.1	1195	11.4	8.00	5.10	A	549	1.9 + 2.5	
6.0 + 6.0	1230	11.8	8.00	5.10	A	549	2.3 + 2.3	
6.0 + 7.1	1195	11.4	8.00	5.10	A	549	2.1 + 2.4	
7.1 + 7.1	1160	11.1	8.00	5.10	A	549	2.3 + 2.3	

Indoor unit capacity Cooling	Total	Cooling Capacity (kW)						Input Power (W)		EER	
		Room A	Room B	Room C	Room D	Total	min ~ max	Rating	min ~ max	W/W	CLASS
1.6 + 1.6 + 1.6	4.8	1.60	1.60	1.60		4.80	3.0 ~ 8.5	1140	490 ~ 3170	4.21	A
1.6 + 1.6 + 2.0	5.2	1.60	1.60	2.00		5.20	3.0 ~ 8.5	1240	490 ~ 3170	4.19	A
1.6 + 1.6 + 2.5	5.7	1.60	1.60	2.50		5.70	3.0 ~ 8.5	1450	490 ~ 3170	3.93	A
1.6 + 1.6 + 3.5	6.7	1.60	1.60	3.50		6.70	3.0 ~ 8.5	1770	480 ~ 3090	3.79	A
1.6 + 1.6 + 4.2	7.4	1.60	1.60	4.20		7.40	3.0 ~ 8.5	2130	480 ~ 3010	3.47	A
1.6 + 1.6 + 5.0	8.2	1.56	1.56	4.88		8.00	3.0 ~ 8.6	2160	520 ~ 2790	3.70	A
1.6 + 1.6 + 6.0	9.2	1.39	1.39	5.22		8.00	3.0 ~ 8.6	2160	520 ~ 2790	3.70	A
1.6 + 1.6 + 7.1	10.3	1.24	1.24	5.52		8.00	3.0 ~ 8.8	2100	520 ~ 2860	3.81	A
1.6 + 2.0 + 2.0	5.6	1.60	2.00	2.00		5.60	3.0 ~ 8.5	1400	490 ~ 3090	4.00	A
1.6 + 2.0 + 2.5	6.1	1.60	2.00	2.50		6.10	3.0 ~ 8.5	1610	490 ~ 3090	3.79	A
1.6 + 2.0 + 3.5	7.1	1.60	2.00	3.50		7.10	3.0 ~ 8.5	1940	480 ~ 3010	3.66	A
1.6 + 2.0 + 4.2	7.8	1.60	2.00	4.20		7.80	3.0 ~ 8.5	2230	480 ~ 3010	3.50	A
1.6 + 2.0 + 5.0	8.6	1.49	1.86	4.65		8.00	3.0 ~ 8.6	2160	520 ~ 2790	3.70	A
1.6 + 2.0 + 6.0	9.6	1.33	1.67	5.00		8.00	3.0 ~ 8.6	2160	520 ~ 2790	3.70	A
1.6 + 2.0 + 7.1	10.7	1.20	1.50	5.30		8.00	3.0 ~ 8.8	2100	520 ~ 2860	3.81	A
1.6 + 2.5 + 2.5	6.6	1.60	2.50	2.50		6.60	3.0 ~ 8.5	1850	490 ~ 3090	3.57	A
1.6 + 2.5 + 3.5	7.6	1.60	2.50	3.50		7.60	3.0 ~ 8.5	2250	480 ~ 3010	3.38	A
1.6 + 2.5 + 4.2	8.3	1.54	2.41	4.05		8.00	3.0 ~ 8.6	2350	480 ~ 3090	3.40	A
1.6 + 2.5 + 5.0	9.1	1.41	2.20	4.39		8.00	3.0 ~ 8.6	2160	520 ~ 2790	3.70	A
1.6 + 2.5 + 6.0	10.1	1.27	1.98	4.75		8.00	3.0 ~ 8.8	2160	520 ~ 2860	3.70	A
1.6 + 2.5 + 7.1	11.2	1.14	1.79	5.07		8.00	3.0 ~ 8.8	2100	520 ~ 2860	3.81	A
1.6 + 3.5 + 3.5	8.6	1.48	3.26	3.26		8.00	3.0 ~ 8.6	2290	480 ~ 3010	3.49	A
1.6 + 3.5 + 4.2	9.3	1.38	3.01	3.61		8.00	3.0 ~ 8.6	2290	480 ~ 3010	3.49	A
1.6 + 3.5 + 5.0	10.1	1.27	2.77	3.96		8.00	3.0 ~ 8.8	2100	520 ~ 2860	3.81	A
1.6 + 3.5 + 6.0	11.1	1.15	2.52	4.33		8.00	3.0 ~ 8.8	2100	520 ~ 2860	3.81	A
1.6 + 3.5 + 7.1	12.2	1.05	2.30	4.65		8.00	3.0 ~ 9.0	2100	520 ~ 2930	3.81	A
1.6 + 4.2 + 4.2	10.0	1.28	3.36	3.36		8.00	3.0 ~ 8.8	2290	480 ~ 3160	3.49	A
1.6 + 4.2 + 5.0	10.8	1.19	3.11	3.70		8.00	3.0 ~ 8.8	2100	520 ~ 2860	3.81	A
1.6 + 4.2 + 6.0	11.8	1.08	2.85	4.07		8.00	3.0 ~ 9.0	2100	520 ~ 2930	3.81	A
1.6 + 4.2 + 7.1	12.9	0.99	2.60	4.41		8.00	3.0 ~ 9.0	2040	520 ~ 2860	3.92	A
1.6 + 5.0 + 5.0	11.6	1.10	3.45	3.45		8.00	3.0 ~ 8.8	1980	570 ~ 2640	4.04	A
1.6 + 5.0 + 6.0	12.6	1.02	3.17	3.81		8.00	3.0 ~ 9.0	1980	570 ~ 2710	4.04	A
1.6 + 5.0 + 7.1	13.7	0.93	2.92	4.15		8.00	3.0 ~ 9.0	1980	570 ~ 2710	4.04	A
1.6 + 6.0 + 6.0	13.6	0.94	3.53	3.53		8.00	3.0 ~ 9.0	1980	570 ~ 2710	4.04	A
1.6 + 6.0 + 7.1	14.7	0.87	3.27	3.86		8.00	3.0 ~ 9.0	1980	570 ~ 2710	4.04	A
2.0 + 2.0 + 2.0	6.0	2.00	2.00	2.00		6.00	3.0 ~ 8.5	1560	480 ~ 3090	3.85	A
2.0 + 2.0 + 2.5	6.5	2.00	2.00	2.50		6.50	3.0 ~ 8.5	1790	480 ~ 3090	3.63	A
2.0 + 2.0 + 3.5	7.5	2.00	2.00	3.50		7.50	3.0 ~ 8.5	2120	480 ~ 3010	3.54	A
2.0 + 2.0 + 4.2	8.2	1.95	1.95	4.10		8.00	3.0 ~ 8.6	2350	480 ~ 3090	3.40	A
2.0 + 2.0 + 5.0	9.0	1.78	1.78	4.44		8.00	3.0 ~ 8.6	2100	520 ~ 2710	3.81	A
2.0 + 2.0 + 6.0	10.0	1.60	1.60	4.80		8.00	3.0 ~ 8.8	2100	520 ~ 2860	3.81	A
2.0 + 2.0 + 7.1	11.1	1.44	1.44	5.12		8.00	3.0 ~ 8.8	2100	520 ~ 2780	3.81	A
2.0 + 2.5 + 2.5	7.0	2.00	2.50	2.50		7.00	3.0 ~ 8.5	1950	480 ~ 3090	3.59	A
2.0 + 2.5 + 3.5	8.0	2.00	2.50	3.50		8.00	3.0 ~ 8.6	2350	480 ~ 3090	3.40	A
2.0 + 2.5 + 4.2	8.7	1.84	2.30	3.86		8.00	3.0 ~ 8.6	2350	480 ~ 3090	3.40	A
2.0 + 2.5 + 5.0	9.5	1.68	2.11	4.21		8.00	3.0 ~ 8.6	2100	520 ~ 2710	3.81	A
2.0 + 2.5 + 6.0	10.5	1.52	1.90	4.58		8.00	3.0 ~ 8.8	2100	520 ~ 2860	3.81	A
2.0 + 2.5 + 7.1	11.6	1.38	1.72	4.90		8.00	3.0 ~ 8.8	2100	520 ~ 2780	3.81	A
2.0 + 3.5 + 3.5	9.0	1.78	3.11	3.11		8.00	3.0 ~ 8.6	2290	480 ~ 3010	3.49	A
2.0 + 3.5 + 4.2	9.7	1.65	2.89	3.46		8.00	3.0 ~ 8.6	2290	480 ~ 3010	3.49	A
2.0 + 3.5 + 5.0	10.5	1.52	2.67	3.81		8.00	3.0 ~ 8.8	2100	520 ~ 2860	3.81	A
2.0 + 3.5 + 6.0	11.5	1.39	2.43	4.18		8.00	3.0 ~ 8.8	2100	520 ~ 2860	3.81	A
2.0 + 3.5 + 7.1	12.6	1.27	2.22	4.51		8.00	3.0 ~ 9.0	2040	520 ~ 2860	3.92	A
2.0 + 4.2 + 4.2	10.4	1.54	3.23	3.23		8.00	3.0 ~ 8.8	2290	480 ~ 3090	3.49	A
2.0 + 4.2 + 5.0	11.2	1.43	3.00	3.57		8.00	3.0 ~ 8.8	2100	520 ~ 2780	3.81	A
2.0 + 4.2 + 6.0	12.2	1.31	2.75	3.94		8.00	3.0 ~ 9.0	2100	520 ~ 2930	3.81	A
2.0 + 4.2 + 7.1	13.3	1.20	2.53	4.27		8.00	3.0 ~ 9.0	2040	520 ~ 2860	3.92	A
2.0 + 5.0 + 5.0	12.0	1.33	3.33	3.33		7.99	3.0 ~ 9.0	1980	570 ~ 2710	4.04	A

3  
Room

Indoor unit capacity Cooling	Annual Energy Consumption (kWh)	Current 230V (A)	ERP				Moisture Removal Volume l/h
			Pdesign (kW)	SEER		Annual Consumption (kWh)	
				W/W	CLASS		
1.6 + 1.6 + 1.6	570	5.6	4.80	6.90	A++	243	1.0 + 1.0 + 1.0
1.6 + 1.6 + 2.0	620	6.0	5.20	6.90	A++	264	1.0 + 1.0 + 1.3
1.6 + 1.6 + 2.5	725	7.0	5.70	6.90	A++	289	1.0 + 1.0 + 1.5
1.6 + 1.6 + 3.5	885	8.5	6.70	6.90	A++	340	1.0 + 1.0 + 2.0
1.6 + 1.6 + 4.2	1065	10.2	7.40	6.90	A++	375	1.0 + 1.0 + 2.4
1.6 + 1.6 + 5.0	1080	10.3	8.00	6.90	A++	406	1.0 + 1.0 + 2.7
1.6 + 1.6 + 6.0	1080	10.3	8.00	6.90	A++	406	0.9 + 0.9 + 2.9
1.6 + 1.6 + 7.1	1050	10.1	8.00	6.90	A++	406	0.8 + 0.8 + 3.0
1.6 + 2.0 + 2.0	700	6.8	5.60	6.90	A++	284	1.0 + 1.3 + 1.3
1.6 + 2.0 + 2.5	805	7.8	6.10	6.90	A++	309	1.0 + 1.3 + 1.5
1.6 + 2.0 + 3.5	970	9.3	7.10	6.90	A++	360	1.0 + 1.3 + 2.0
1.6 + 2.0 + 4.2	1115	10.7	7.80	6.90	A++	396	1.0 + 1.3 + 2.4
1.6 + 2.0 + 5.0	1080	10.3	8.00	6.90	A++	406	0.9 + 1.2 + 2.5
1.6 + 2.0 + 6.0	1080	10.3	8.00	6.90	A++	406	0.8 + 1.1 + 2.7
1.6 + 2.0 + 7.1	1050	10.1	8.00	6.90	A++	406	0.7 + 1.0 + 2.9
1.6 + 2.5 + 2.5	925	8.9	6.60	6.90	A++	335	1.0 + 1.5 + 1.5
1.6 + 2.5 + 3.5	1125	10.8	7.60	6.90	A++	386	1.0 + 1.5 + 2.0
1.6 + 2.5 + 4.2	1175	11.2	8.00	6.90	A++	406	1.0 + 1.5 + 2.3
1.6 + 2.5 + 5.0	1080	10.3	8.00	6.90	A++	406	0.9 + 1.4 + 2.4
1.6 + 2.5 + 6.0	1080	10.3	8.00	6.90	A++	406	0.8 + 1.3 + 2.6
1.6 + 2.5 + 7.1	1050	10.1	8.00	6.90	A++	406	0.7 + 1.2 + 2.8
1.6 + 3.5 + 3.5	1145	11.0	8.00	6.90	A++	406	0.9 + 1.9 + 1.9
1.6 + 3.5 + 4.2	1145	11.0	8.00	6.90	A++	406	0.9 + 1.7 + 2.1
1.6 + 3.5 + 5.0	1050	10.1	8.00	6.90	A++	406	0.8 + 1.6 + 2.3
1.6 + 3.5 + 6.0	1050	10.1	8.00	6.90	A++	406	0.7 + 1.5 + 2.4
1.6 + 3.5 + 7.1	1050	10.1	8.00	6.90	A++	406	0.7 + 1.5 + 2.5
1.6 + 4.2 + 4.2	1145	11.0	8.00	6.90	A++	406	0.8 + 1.9 + 1.9
1.6 + 4.2 + 5.0	1050	10.1	8.00	6.90	A++	406	0.7 + 1.8 + 2.2
1.6 + 4.2 + 6.0	1050	10.1	8.00	6.90	A++	406	0.7 + 1.7 + 2.3
1.6 + 4.2 + 7.1	1020	9.8	8.00	6.90	A++	406	0.7 + 1.6 + 2.4
1.6 + 5.0 + 5.0	990	9.5	8.00	6.90	A++	406	0.7 + 2.0 + 2.0
1.6 + 5.0 + 6.0	990	9.5	8.00	6.90	A++	406	0.7 + 1.8 + 2.2
1.6 + 5.0 + 7.1	990	9.5	8.00	6.90	A++	406	0.7 + 1.7 + 2.4
1.6 + 6.0 + 6.0	990	9.5	8.00	6.90	A++	406	0.7 + 2.0 + 2.0
1.6 + 6.0 + 7.1	990	9.5	8.00	6.90	A++	406	0.7 + 1.9 + 2.3
2.0 + 2.0 + 2.0	780	7.5	6.00	6.90	A++	304	1.3 + 1.3 + 1.3
2.0 + 2.0 + 2.5	895	8.6	6.50	6.90	A++	330	1.3 + 1.3 + 1.5
2.0 + 2.0 + 3.5	1060	10.1	7.50	6.90	A++	380	1.3 + 1.3 + 2.0
2.0 + 2.0 + 4.2	1175	11.2	8.00	6.90	A++	406	1.3 + 1.3 + 2.3
2.0 + 2.0 + 5.0	1050	10.1	8.00	6.90	A++	406	1.1 + 1.1 + 2.5
2.0 + 2.0 + 6.0	1050	10.1	8.00	6.90	A++	406	1.0 + 1.0 + 2.6
2.0 + 2.0 + 7.1	1050	10.1	8.00	6.90	A++	406	0.9 + 0.9 + 2.8
2.0 + 2.5 + 2.5	975	9.3	7.00	6.90	A++	355	1.3 + 1.5 + 1.5
2.0 + 2.5 + 3.5	1175	11.2	8.00	6.90	A++	406	1.3 + 1.5 + 2.0
2.0 + 2.5 + 4.2	1175	11.2	8.00	6.90	A++	406	1.2 + 1.5 + 2.3
2.0 + 2.5 + 5.0	1050	10.1	8.00	6.90	A++	406	1.1 + 1.4 + 2.4
2.0 + 2.5 + 6.0	1050	10.1	8.00	6.90	A++	406	1.0 + 1.2 + 2.5
2.0 + 2.5 + 7.1	1050	10.1	8.00	6.90	A++	406	0.9 + 1.1 + 2.7
2.0 + 3.5 + 3.5	1145	11.0	8.00	6.90	A++	406	1.1 + 1.8 + 1.8
2.0 + 3.5 + 4.2	1145	11.0	8.00	6.90	A++	406	1.1 + 1.7 + 2.0
2.0 + 3.5 + 5.0	1050	10.1	8.00	6.90	A++	406	1.0 + 1.6 + 2.2
2.0 + 3.5 + 6.0	1050	10.1	8.00	6.90	A++	406	0.9 + 1.5 + 2.4
2.0 + 3.5 + 7.1	1020	9.8	8.00	6.90	A++	406	0.8 + 1.4 + 2.5
2.0 + 4.2 + 4.2	1145	11.0	8.00	6.90	A++	406	1.0 + 1.8 + 1.8
2.0 + 4.2 + 5.0	1050	10.1	8.00	6.90	A++	406	0.9 + 1.7 + 2.1
2.0 + 4.2 + 6.0	1050	10.1	8.00	6.90	A++	406	0.8 + 1.6 + 2.3
2.0 + 4.2 + 7.1	1020	9.8	8.00	6.90	A++	406	0.7 + 1.6 + 2.4
2.0 + 5.0 + 5.0	990	9.5	7.99	6.90	A++	405	0.8 + 1.9 + 1.9

3  
Room

Indoor unit capacity Cooling	Total	Cooling Capacity (kW)						Input Power (W)		EER	
		Room A	Room B	Room C	Room D	Total	min ~ max	Rating	min ~ max	W/W	CLASS
2.0 + 5.0 + 6.0	13.0	1.23	3.08	3.69		8.00	3.0 ~ 9.0	1980	570 ~ 2710	4.04	A
2.0 + 5.0 + 7.1	14.1	1.13	2.84	4.03		8.00	3.0 ~ 9.0	1980	570 ~ 2710	4.04	A
2.0 + 6.0 + 6.0	14.0	1.14	3.43	3.43		8.00	3.0 ~ 9.0	1980	570 ~ 2710	4.04	A
2.5 + 2.5 + 2.5	7.5	2.50	2.50	2.50		7.50	3.0 ~ 8.5	2190	480 ~ 3090	3.42	A
2.5 + 2.5 + 3.5	8.5	2.35	2.35	3.30		8.00	3.0 ~ 8.6	2350	480 ~ 3090	3.40	A
2.5 + 2.5 + 4.2	9.2	2.17	2.17	3.66		8.00	3.0 ~ 8.6	2350	480 ~ 3090	3.40	A
2.5 + 2.5 + 5.0	10.0	2.00	2.00	4.00		8.00	3.0 ~ 8.8	2100	520 ~ 2860	3.81	A
2.5 + 2.5 + 6.0	11.0	1.82	1.82	4.36		8.00	3.0 ~ 8.8	2100	520 ~ 2860	3.81	A
2.5 + 2.5 + 7.1	12.1	1.65	1.65	4.70		8.00	3.0 ~ 9.0	2100	520 ~ 2930	3.81	A
2.5 + 3.5 + 3.5	9.5	2.10	2.95	2.95		8.00	3.0 ~ 8.6	2290	480 ~ 3010	3.49	A
2.5 + 3.5 + 4.2	10.2	1.96	2.75	3.29		8.00	3.0 ~ 8.8	2290	480 ~ 3160	3.49	A
2.5 + 3.5 + 5.0	11.0	1.82	2.55	3.63		8.00	3.0 ~ 8.8	2100	520 ~ 2860	3.81	A
2.5 + 3.5 + 6.0	12.0	1.67	2.33	4.00		8.00	3.0 ~ 9.0	2100	520 ~ 2930	3.81	A
2.5 + 3.5 + 7.1	13.1	1.53	2.14	4.33		8.00	3.0 ~ 9.0	2040	520 ~ 2860	3.92	A
2.5 + 4.2 + 4.2	10.9	1.84	3.08	3.08		8.00	3.0 ~ 8.8	2290	480 ~ 3090	3.49	A
2.5 + 4.2 + 5.0	11.7	1.71	2.87	3.42		8.00	3.0 ~ 8.8	2100	520 ~ 2780	3.81	A
2.5 + 4.2 + 6.0	12.7	1.57	2.65	3.78		8.00	3.0 ~ 9.0	2100	520 ~ 2930	3.81	A
2.5 + 4.2 + 7.1	13.8	1.45	2.43	4.12		8.00	3.0 ~ 9.0	2040	520 ~ 2860	3.92	A
2.5 + 5.0 + 5.0	12.5	1.60	3.20	3.20		8.00	3.0 ~ 9.0	1980	570 ~ 2710	4.04	A
2.5 + 5.0 + 6.0	13.5	1.48	2.96	3.56		8.00	3.0 ~ 9.0	1980	570 ~ 2710	4.04	A
2.5 + 5.0 + 7.1	14.6	1.37	2.74	3.89		8.00	3.0 ~ 9.0	1980	570 ~ 2710	4.04	A
2.5 + 6.0 + 6.0	14.5	1.38	3.31	3.31		8.00	3.0 ~ 9.0	1980	570 ~ 2710	4.04	A
3.5 + 3.5 + 3.5	10.5	2.66	2.66	2.66		7.98	3.0 ~ 8.8	2230	480 ~ 3090	3.58	A
3.5 + 3.5 + 4.2	11.2	2.50	2.50	3.00		8.00	3.0 ~ 8.8	2230	480 ~ 3090	3.59	A
3.5 + 3.5 + 5.0	12.0	2.33	2.33	3.33		7.99	3.0 ~ 9.0	2040	520 ~ 2930	3.92	A
3.5 + 3.5 + 6.0	13.0	2.15	2.15	3.70		8.00	3.0 ~ 9.0	2040	520 ~ 2930	3.92	A
3.5 + 3.5 + 7.1	14.1	1.99	1.99	4.02		8.00	3.0 ~ 9.0	2040	520 ~ 2860	3.92	A
3.5 + 4.2 + 4.2	11.9	2.36	2.82	2.82		8.00	3.0 ~ 9.0	2230	480 ~ 3160	3.59	A
3.5 + 4.2 + 5.0	12.7	2.20	2.65	3.15		8.00	3.0 ~ 9.0	2040	520 ~ 2860	3.92	A
3.5 + 4.2 + 6.0	13.7	2.04	2.45	3.51		8.00	3.0 ~ 9.0	2040	520 ~ 2860	3.92	A
3.5 + 5.0 + 5.0	13.5	2.08	2.96	2.96		8.00	3.0 ~ 9.0	1980	570 ~ 2710	4.04	A
3.5 + 5.0 + 6.0	14.5	1.93	2.76	3.31		8.00	3.0 ~ 9.0	1980	570 ~ 2710	4.04	A
4.2 + 4.2 + 4.2	12.6	2.66	2.66	2.66		7.98	3.0 ~ 9.0	2230	480 ~ 3160	3.58	A
4.2 + 4.2 + 5.0	13.4	2.51	2.51	2.98		8.00	3.0 ~ 9.0	2040	520 ~ 2860	3.92	A
4.2 + 4.2 + 6.0	14.4	2.33	2.33	3.33		7.99	3.0 ~ 9.0	2040	520 ~ 2860	3.92	A
4.2 + 5.0 + 5.0	14.2	2.36	2.82	2.82		8.00	3.0 ~ 9.0	1980	570 ~ 2710	4.04	A

3  
Room



Indoor unit capacity Cooling	Annual Energy Consumption (kWh)	Current 230V (A)	ERP				Moisture Removal Volume l/h	
			Pdesign (kW)	SEER		Annual Consumption (kWh)		
				WW	CLASS			
3 Room	2.0 + 5.0 + 6.0	990	9.5	8.00	6.90	A++	406	0.8 + 1.7 + 2.1
	2.0 + 5.0 + 7.1	990	9.5	8.00	6.90	A++	406	0.7 + 1.7 + 2.3
	2.0 + 6.0 + 6.0	990	9.5	8.00	6.90	A++	406	0.7 + 2.0 + 2.0
	2.5 + 2.5 + 2.5	1095	10.5	7.50	6.90	A++	380	1.5 + 1.5 + 1.5
	2.5 + 2.5 + 3.5	1175	11.2	8.00	6.90	A++	406	1.5 + 1.5 + 1.9
	2.5 + 2.5 + 4.2	1175	11.2	8.00	6.90	A++	406	1.4 + 1.4 + 2.1
	2.5 + 2.5 + 5.0	1050	10.1	8.00	6.90	A++	406	1.3 + 1.3 + 2.3
	2.5 + 2.5 + 6.0	1050	10.1	8.00	6.90	A++	406	1.2 + 1.2 + 2.4
	2.5 + 2.5 + 7.1	1050	10.1	8.00	6.90	A++	406	1.1 + 1.1 + 2.5
	2.5 + 3.5 + 3.5	1145	11.0	8.00	6.90	A++	406	1.4 + 1.7 + 1.7
	2.5 + 3.5 + 4.2	1145	11.0	8.00	6.90	A++	406	1.3 + 1.6 + 1.9
	2.5 + 3.5 + 5.0	1050	10.1	8.00	6.90	A++	406	1.2 + 1.6 + 2.1
	2.5 + 3.5 + 6.0	1050	10.1	8.00	6.90	A++	406	1.1 + 1.5 + 2.3
	2.5 + 3.5 + 7.1	1020	9.8	8.00	6.90	A++	406	1.0 + 1.4 + 2.4
	2.5 + 4.2 + 4.2	1145	11.0	8.00	6.90	A++	406	1.2 + 1.7 + 1.7
	2.5 + 4.2 + 5.0	1050	10.1	8.00	6.90	A++	406	1.1 + 1.7 + 2.0
	2.5 + 4.2 + 6.0	1050	10.1	8.00	6.90	A++	406	1.0 + 1.6 + 2.2
	2.5 + 4.2 + 7.1	1020	9.8	8.00	6.90	A++	406	0.9 + 1.5 + 2.3
	2.5 + 5.0 + 5.0	990	9.5	8.00	6.90	A++	406	1.0 + 1.8 + 1.8
	2.5 + 5.0 + 6.0	990	9.5	8.00	6.90	A++	406	0.9 + 1.7 + 2.1
	2.5 + 5.0 + 7.1	990	9.5	8.00	6.90	A++	406	0.9 + 1.6 + 2.3
	2.5 + 6.0 + 6.0	990	9.5	8.00	6.90	A++	406	0.9 + 1.9 + 1.9
	3.5 + 3.5 + 3.5	1115	10.7	7.98	6.90	A++	405	1.6 + 1.6 + 1.6
	3.5 + 3.5 + 4.2	1115	10.7	8.00	6.90	A++	406	1.5 + 1.5 + 1.7
	3.5 + 3.5 + 5.0	1020	9.8	7.99	6.90	A++	405	1.5 + 1.5 + 1.9
	3.5 + 3.5 + 6.0	1020	9.8	8.00	6.90	A++	406	1.4 + 1.4 + 2.2
	3.5 + 3.5 + 7.1	1020	9.8	8.00	6.90	A++	406	1.3 + 1.3 + 2.3
	3.5 + 4.2 + 4.2	1115	10.7	8.00	6.90	A++	406	1.5 + 1.7 + 1.7
	3.5 + 4.2 + 5.0	1020	9.8	8.00	6.90	A++	406	1.4 + 1.6 + 1.8
	3.5 + 4.2 + 6.0	1020	9.8	8.00	6.90	A++	406	1.3 + 1.5 + 2.0
3.5 + 5.0 + 5.0	990	9.5	8.00	6.90	A++	406	1.3 + 1.7 + 1.7	
3.5 + 5.0 + 6.0	990	9.5	8.00	6.90	A++	406	1.2 + 1.6 + 1.9	
4.2 + 4.2 + 4.2	1115	10.7	7.98	6.90	A++	405	1.6 + 1.6 + 1.6	
4.2 + 4.2 + 5.0	1020	9.8	8.00	6.90	A++	406	1.5 + 1.5 + 1.7	
4.2 + 4.2 + 6.0	1020	9.8	7.99	6.90	A++	405	1.5 + 1.5 + 1.9	
4.2 + 5.0 + 5.0	990	9.5	8.00	6.90	A++	406	1.5 + 1.7 + 1.7	

Indoor unit capacity Cooling	Total	Cooling Capacity (kW)						Input Power (W)		EER	
		Room A	Room B	Room C	Room D	Total	min ~ max	Rating	min ~ max	W/W	CLASS
1.6 + 1.6 + 1.6 + 1.6	6.4	1.60	1.60	1.60	1.60	6.40	3.0 ~ 9.2	1570	520 ~ 3030	4.08	A
1.6 + 1.6 + 1.6 + 2.0	6.8	1.60	1.60	1.60	2.00	6.80	3.0 ~ 9.2	1670	520 ~ 2950	4.07	A
1.6 + 1.6 + 1.6 + 2.5	7.3	1.60	1.60	1.60	2.50	7.30	3.0 ~ 9.2	1840	520 ~ 2950	3.97	A
1.6 + 1.6 + 1.6 + 3.5	8.3	1.54	1.54	1.54	3.38	8.00	3.0 ~ 9.2	2060	530 ~ 2950	3.88	A
1.6 + 1.6 + 1.6 + 4.2	9.0	1.42	1.42	1.42	3.74	8.00	3.0 ~ 9.2	2060	530 ~ 2950	3.88	A
1.6 + 1.6 + 1.6 + 5.0	9.8	1.31	1.31	1.31	4.07	8.00	3.0 ~ 9.2	1950	620 ~ 2810	4.10	A
1.6 + 1.6 + 1.6 + 6.0	10.8	1.19	1.19	1.19	4.43	8.00	3.0 ~ 9.2	1950	620 ~ 2810	4.10	A
1.6 + 1.6 + 1.6 + 7.1	11.9	1.08	1.08	1.08	4.76	8.00	3.0 ~ 9.2	1950	620 ~ 2740	4.10	A
1.6 + 1.6 + 2.0 + 2.0	7.2	1.60	1.60	2.00	2.00	7.20	3.0 ~ 9.2	1780	530 ~ 2950	4.04	A
1.6 + 1.6 + 2.0 + 2.5	7.7	1.60	1.60	2.00	2.50	7.70	3.0 ~ 9.2	1940	530 ~ 2950	3.97	A
1.6 + 1.6 + 2.0 + 3.5	8.7	1.47	1.47	1.84	3.22	8.00	3.0 ~ 9.2	2000	530 ~ 2950	4.00	A
1.6 + 1.6 + 2.0 + 4.2	9.4	1.36	1.36	1.70	3.58	8.00	3.0 ~ 9.2	2000	560 ~ 2950	4.00	A
1.6 + 1.6 + 2.0 + 5.0	10.2	1.25	1.25	1.57	3.93	8.00	3.0 ~ 9.2	1950	620 ~ 2730	4.10	A
1.6 + 1.6 + 2.0 + 6.0	11.2	1.14	1.14	1.43	4.29	8.00	3.0 ~ 9.2	1950	620 ~ 2730	4.10	A
1.6 + 1.6 + 2.0 + 7.1	12.3	1.04	1.04	1.30	4.62	8.00	3.0 ~ 9.2	1950	620 ~ 2740	4.10	A
1.6 + 1.6 + 2.5 + 2.5	8.2	1.56	1.56	2.44	2.44	8.00	3.0 ~ 9.2	2060	530 ~ 2950	3.88	A
1.6 + 1.6 + 2.5 + 3.5	9.2	1.39	1.39	2.17	3.05	8.00	3.0 ~ 9.2	2000	530 ~ 2950	4.00	A
1.6 + 1.6 + 2.5 + 4.2	9.9	1.29	1.29	2.02	3.40	8.00	3.0 ~ 9.2	2000	560 ~ 2950	4.00	A
1.6 + 1.6 + 2.5 + 5.0	10.7	1.20	1.20	1.87	3.73	8.00	3.0 ~ 9.2	1950	620 ~ 2730	4.10	A
1.6 + 1.6 + 2.5 + 6.0	11.7	1.09	1.09	1.71	4.11	8.00	3.0 ~ 9.2	1950	620 ~ 2730	4.10	A
1.6 + 1.6 + 2.5 + 7.1	12.8	1.00	1.00	1.56	4.44	8.00	3.0 ~ 9.2	1950	620 ~ 2740	4.10	A
1.6 + 1.6 + 3.5 + 3.5	10.2	1.25	1.25	2.75	2.75	8.00	3.0 ~ 9.2	2000	570 ~ 2880	4.00	A
1.6 + 1.6 + 3.5 + 4.2	10.9	1.17	1.17	2.57	3.09	8.00	3.0 ~ 9.2	2000	570 ~ 2880	4.00	A
1.6 + 1.6 + 3.5 + 5.0	11.7	1.09	1.09	2.39	3.43	8.00	3.0 ~ 9.2	1950	620 ~ 2740	4.10	A
1.6 + 1.6 + 3.5 + 6.0	12.7	1.01	1.01	2.20	3.78	8.00	3.0 ~ 9.2	1950	620 ~ 2740	4.10	A
1.6 + 1.6 + 3.5 + 7.1	13.8	0.93	0.93	2.03	4.11	8.00	3.0 ~ 9.2	1950	630 ~ 2740	4.10	A
1.6 + 1.6 + 4.2 + 4.2	11.6	1.10	1.10	2.90	2.90	8.00	3.0 ~ 9.2	2000	570 ~ 2880	4.00	A
1.6 + 1.6 + 4.2 + 5.0	12.4	1.03	1.03	2.71	3.23	8.00	3.0 ~ 9.2	1950	620 ~ 2740	4.10	A
1.6 + 1.6 + 4.2 + 6.0	13.4	0.96	0.96	2.51	3.57	8.00	3.0 ~ 9.2	1950	620 ~ 2740	4.10	A
1.6 + 1.6 + 4.2 + 7.1	14.5	0.88	0.88	2.32	3.92	8.00	3.0 ~ 9.2	1950	630 ~ 2740	4.10	A
1.6 + 1.6 + 5.0 + 5.0	13.2	0.97	0.97	3.03	3.03	8.00	3.0 ~ 9.2	1960	690 ~ 2680	4.08	A
1.6 + 1.6 + 5.0 + 6.0	14.2	0.90	0.90	2.82	3.38	8.00	3.0 ~ 9.2	1960	690 ~ 2680	4.08	A
1.6 + 2.0 + 2.0 + 2.0	7.6	1.60	2.00	2.00	2.00	7.60	3.0 ~ 9.2	1950	530 ~ 2950	3.90	A
1.6 + 2.0 + 2.0 + 2.5	8.1	1.58	1.98	1.98	2.46	8.00	3.0 ~ 9.2	2060	530 ~ 2950	3.88	A
1.6 + 2.0 + 2.0 + 3.5	9.1	1.41	1.76	1.76	3.07	8.00	3.0 ~ 9.2	2000	570 ~ 2880	4.00	A
1.6 + 2.0 + 2.0 + 4.2	9.8	1.31	1.63	1.63	3.43	8.00	3.0 ~ 9.2	2000	570 ~ 2880	4.00	A
1.6 + 2.0 + 2.0 + 5.0	10.6	1.21	1.51	1.51	3.77	8.00	3.0 ~ 9.2	1950	620 ~ 2730	4.10	A
1.6 + 2.0 + 2.0 + 6.0	11.6	1.10	1.38	1.38	4.14	8.00	3.0 ~ 9.2	1950	620 ~ 2730	4.10	A
1.6 + 2.0 + 2.0 + 7.1	12.7	1.01	1.26	1.26	4.47	8.00	3.0 ~ 9.2	1950	630 ~ 2740	4.10	A
1.6 + 2.0 + 2.5 + 2.5	8.6	1.48	1.86	2.33	2.33	8.00	3.0 ~ 9.2	2060	530 ~ 2950	3.88	A
1.6 + 2.0 + 2.5 + 3.5	9.6	1.33	1.67	2.08	2.92	8.00	3.0 ~ 9.2	2000	570 ~ 2880	4.00	A
1.6 + 2.0 + 2.5 + 4.2	10.3	1.24	1.55	1.94	3.27	8.00	3.0 ~ 9.2	2000	570 ~ 2880	4.00	A
1.6 + 2.0 + 2.5 + 5.0	11.1	1.15	1.44	1.80	3.61	8.00	3.0 ~ 9.2	1950	620 ~ 2730	4.10	A
1.6 + 2.0 + 2.5 + 6.0	12.1	1.06	1.32	1.65	3.97	8.00	3.0 ~ 9.2	1950	620 ~ 2730	4.10	A
1.6 + 2.0 + 2.5 + 7.1	13.2	0.97	1.21	1.52	4.30	8.00	3.0 ~ 9.2	1950	630 ~ 2740	4.10	A
1.6 + 2.0 + 3.5 + 3.5	10.6	1.21	1.51	2.64	2.64	8.00	3.0 ~ 9.2	2000	570 ~ 2880	4.00	A
1.6 + 2.0 + 3.5 + 4.2	11.3	1.13	1.42	2.48	2.97	8.00	3.0 ~ 9.2	2000	570 ~ 2880	4.00	A
1.6 + 2.0 + 3.5 + 5.0	12.1	1.06	1.32	2.31	3.31	8.00	3.0 ~ 9.2	1950	630 ~ 2740	4.10	A
1.6 + 2.0 + 3.5 + 6.0	13.1	0.98	1.22	2.14	3.66	8.00	3.0 ~ 9.2	1950	630 ~ 2740	4.10	A
1.6 + 2.0 + 3.5 + 7.1	14.2	0.90	1.13	1.97	4.00	8.00	3.0 ~ 9.2	1950	630 ~ 2740	4.10	A
1.6 + 2.0 + 4.2 + 4.2	12.0	1.07	1.33	2.80	2.80	8.00	3.0 ~ 9.2	2000	570 ~ 2880	4.00	A
1.6 + 2.0 + 4.2 + 5.0	12.8	1.00	1.25	2.63	3.12	8.00	3.0 ~ 9.2	1950	630 ~ 2740	4.10	A
1.6 + 2.0 + 4.2 + 6.0	13.8	0.93	1.16	2.43	3.48	8.00	3.0 ~ 9.2	1950	630 ~ 2740	4.10	A
1.6 + 2.0 + 5.0 + 5.0	13.6	0.94	1.18	2.94	2.94	8.00	3.0 ~ 9.2	1970	690 ~ 2680	4.06	A
1.6 + 2.0 + 5.0 + 6.0	14.6	0.88	1.10	2.74	3.28	8.00	3.0 ~ 9.2	1970	690 ~ 2680	4.06	A
1.6 + 2.5 + 2.5 + 2.5	9.1	1.40	2.20	2.20	2.20	8.00	3.0 ~ 9.2	2060	530 ~ 2950	3.88	A
1.6 + 2.5 + 2.5 + 3.5	10.1	1.27	1.98	1.98	2.77	8.00	3.0 ~ 9.2	2000	570 ~ 2880	4.00	A
1.6 + 2.5 + 2.5 + 4.2	10.8	1.19	1.85	1.85	3.11	8.00	3.0 ~ 9.2	2000	570 ~ 2880	4.00	A

Indoor unit capacity Cooling	Annual Energy Consumption (kWh)	Current 230V (A)	ERP					Moisture Removal Volume l/h
			Pdesign (kW)	SEER		Annual Consumption (kWh)		
				W/W	CLASS			
1.6 + 1.6 + 1.6 + 1.6	785	7.6	6.40	7.90	A++	284	1.0 + 1.0 + 1.0 + 1.0	
1.6 + 1.6 + 1.6 + 2.0	835	8.1	6.80	7.90	A++	301	1.0 + 1.0 + 1.0 + 1.3	
1.6 + 1.6 + 1.6 + 2.5	920	8.8	7.30	7.50	A++	341	1.0 + 1.0 + 1.0 + 1.5	
1.6 + 1.6 + 1.6 + 3.5	1030	9.9	8.00	7.50	A++	373	1.0 + 1.0 + 1.0 + 1.9	
1.6 + 1.6 + 1.6 + 4.2	1030	9.9	8.00	7.50	A++	373	0.9 + 0.9 + 0.9 + 2.2	
1.6 + 1.6 + 1.6 + 5.0	975	9.3	8.00	7.50	A++	373	0.8 + 0.8 + 0.8 + 2.3	
1.6 + 1.6 + 1.6 + 6.0	975	9.3	8.00	7.50	A++	373	0.7 + 0.7 + 0.7 + 2.5	
1.6 + 1.6 + 1.6 + 7.1	975	9.3	8.00	7.50	A++	373	0.7 + 0.7 + 0.7 + 2.6	
1.6 + 1.6 + 2.0 + 2.0	890	8.5	7.20	7.50	A++	336	1.0 + 1.0 + 1.3 + 1.3	
1.6 + 1.6 + 2.0 + 2.5	970	9.3	7.70	7.50	A++	359	1.0 + 1.0 + 1.3 + 1.5	
1.6 + 1.6 + 2.0 + 3.5	1000	9.6	8.00	7.50	A++	373	0.9 + 0.9 + 1.2 + 1.8	
1.6 + 1.6 + 2.0 + 4.2	1000	9.6	8.00	7.50	A++	373	0.9 + 0.9 + 1.1 + 2.1	
1.6 + 1.6 + 2.0 + 5.0	975	9.3	8.00	7.50	A++	373	0.8 + 0.8 + 1.0 + 2.3	
1.6 + 1.6 + 2.0 + 6.0	975	9.3	8.00	7.50	A++	373	0.7 + 0.7 + 0.9 + 2.4	
1.6 + 1.6 + 2.0 + 7.1	975	9.3	8.00	7.50	A++	373	0.7 + 0.7 + 0.8 + 2.5	
1.6 + 1.6 + 2.5 + 2.5	1030	9.9	8.00	7.50	A++	373	1.0 + 1.0 + 1.5 + 1.5	
1.6 + 1.6 + 2.5 + 3.5	1000	9.6	8.00	7.50	A++	373	0.9 + 0.9 + 1.4 + 1.7	
1.6 + 1.6 + 2.5 + 4.2	1000	9.6	8.00	7.50	A++	373	0.8 + 0.8 + 1.3 + 1.9	
1.6 + 1.6 + 2.5 + 5.0	975	9.3	8.00	7.50	A++	373	0.7 + 0.7 + 1.2 + 2.2	
1.6 + 1.6 + 2.5 + 6.0	975	9.3	8.00	7.50	A++	373	0.7 + 0.7 + 1.1 + 2.3	
1.6 + 1.6 + 2.5 + 7.1	975	9.3	8.00	7.50	A++	373	0.7 + 0.7 + 1.0 + 2.5	
1.6 + 1.6 + 3.5 + 3.5	1000	9.6	8.00	7.50	A++	373	0.8 + 0.8 + 1.6 + 1.6	
1.6 + 1.6 + 3.5 + 4.2	1000	9.6	8.00	7.50	A++	373	0.7 + 0.7 + 1.6 + 1.7	
1.6 + 1.6 + 3.5 + 5.0	975	9.3	8.00	7.50	A++	373	0.7 + 0.7 + 1.5 + 2.0	
1.6 + 1.6 + 3.5 + 6.0	975	9.3	8.00	7.50	A++	373	0.7 + 0.7 + 1.4 + 2.2	
1.6 + 1.6 + 3.5 + 7.1	975	9.3	8.00	7.50	A++	373	0.7 + 0.7 + 1.3 + 2.3	
1.6 + 1.6 + 4.2 + 4.2	1000	9.6	8.00	7.50	A++	373	0.7 + 0.7 + 1.7 + 1.7	
1.6 + 1.6 + 4.2 + 5.0	975	9.3	8.00	7.50	A++	373	0.7 + 0.7 + 1.6 + 1.8	
1.6 + 1.6 + 4.2 + 6.0	975	9.3	8.00	7.50	A++	373	0.7 + 0.7 + 1.5 + 2.1	
1.6 + 1.6 + 4.2 + 7.1	975	9.3	8.00	7.50	A++	373	0.7 + 0.7 + 1.5 + 2.3	
1.6 + 1.6 + 5.0 + 5.0	980	9.4	8.00	7.50	A++	373	0.7 + 0.7 + 1.7 + 1.7	
1.6 + 1.6 + 5.0 + 6.0	980	9.4	8.00	7.50	A++	373	0.7 + 0.7 + 1.7 + 1.9	
1.6 + 2.0 + 2.0 + 2.0	975	9.3	7.60	7.50	A++	355	1.0 + 1.3 + 1.3 + 1.3	
1.6 + 2.0 + 2.0 + 2.5	1030	9.9	8.00	7.50	A++	373	1.0 + 1.3 + 1.3 + 1.5	
1.6 + 2.0 + 2.0 + 3.5	1000	9.6	8.00	7.50	A++	373	0.9 + 1.1 + 1.1 + 1.7	
1.6 + 2.0 + 2.0 + 4.2	1000	9.6	8.00	7.50	A++	373	0.8 + 1.0 + 1.0 + 2.0	
1.6 + 2.0 + 2.0 + 5.0	975	9.3	8.00	7.50	A++	373	0.8 + 1.0 + 1.0 + 2.2	
1.6 + 2.0 + 2.0 + 6.0	975	9.3	8.00	7.50	A++	373	0.7 + 0.9 + 0.9 + 2.4	
1.6 + 2.0 + 2.0 + 7.1	975	9.3	8.00	7.50	A++	373	0.7 + 0.8 + 0.8 + 2.5	
1.6 + 2.0 + 2.5 + 2.5	1030	9.9	8.00	7.50	A++	373	0.9 + 1.2 + 1.5 + 1.5	
1.6 + 2.0 + 2.5 + 3.5	1000	9.6	8.00	7.50	A++	373	0.8 + 1.1 + 1.3 + 1.7	
1.6 + 2.0 + 2.5 + 4.2	1000	9.6	8.00	7.50	A++	373	0.8 + 1.0 + 1.3 + 1.9	
1.6 + 2.0 + 2.5 + 5.0	975	9.3	8.00	7.50	A++	373	0.7 + 0.9 + 1.2 + 2.1	
1.6 + 2.0 + 2.5 + 6.0	975	9.3	8.00	7.50	A++	373	0.7 + 0.8 + 1.1 + 2.3	
1.6 + 2.0 + 2.5 + 7.1	975	9.3	8.00	7.50	A++	373	0.7 + 0.8 + 1.0 + 2.4	
1.6 + 2.0 + 3.5 + 3.5	1000	9.6	8.00	7.50	A++	373	0.8 + 1.0 + 1.6 + 1.6	
1.6 + 2.0 + 3.5 + 4.2	1000	9.6	8.00	7.50	A++	373	0.7 + 0.9 + 1.5 + 1.7	
1.6 + 2.0 + 3.5 + 5.0	975	9.3	8.00	7.50	A++	373	0.7 + 0.8 + 1.5 + 1.9	
1.6 + 2.0 + 3.5 + 6.0	975	9.3	8.00	7.50	A++	373	0.7 + 0.8 + 1.4 + 2.1	
1.6 + 2.0 + 3.5 + 7.1	975	9.3	8.00	7.50	A++	373	0.7 + 0.7 + 1.3 + 2.3	
1.6 + 2.0 + 4.2 + 4.2	1000	9.6	8.00	7.50	A++	373	0.7 + 0.8 + 1.6 + 1.6	
1.6 + 2.0 + 4.2 + 5.0	975	9.3	8.00	7.50	A++	373	0.7 + 0.8 + 1.6 + 1.8	
1.6 + 2.0 + 4.2 + 6.0	975	9.3	8.00	7.50	A++	373	0.7 + 0.7 + 1.5 + 2.0	
1.6 + 2.0 + 5.0 + 5.0	985	9.4	8.00	7.50	A++	373	0.7 + 0.7 + 1.7 + 1.7	
1.6 + 2.0 + 5.0 + 6.0	985	9.4	8.00	7.50	A++	373	0.7 + 0.7 + 1.6 + 1.9	
1.6 + 2.5 + 2.5 + 2.5	1030	9.9	8.00	7.50	A++	373	0.9 + 1.4 + 1.4 + 1.4	
1.6 + 2.5 + 2.5 + 3.5	1000	9.6	8.00	7.50	A++	373	0.8 + 1.3 + 1.3 + 1.6	
1.6 + 2.5 + 2.5 + 4.2	1000	9.6	8.00	7.50	A++	373	0.7 + 1.2 + 1.2 + 1.8	

4  
Room

Indoor unit capacity Cooling	Total	Cooling Capacity (kW)						Input Power (W)		EER	
		Room A	Room B	Room C	Room D	Total	min ~ max	Rating	min ~ max	W/W	CLASS
1.6 + 2.5 + 2.5 + 5.0	11.6	1.10	1.72	1.72	3.46	8.00	3.0 ~ 9.2	1950	620 ~ 2730	4.10	A
1.6 + 2.5 + 2.5 + 6.0	12.6	1.02	1.59	1.59	3.80	8.00	3.0 ~ 9.2	1950	620 ~ 2730	4.10	A
1.6 + 2.5 + 2.5 + 7.1	13.7	0.93	1.46	1.46	4.15	8.00	3.0 ~ 9.2	1950	630 ~ 2740	4.10	A
1.6 + 2.5 + 3.5 + 3.5	11.1	1.15	1.81	2.52	2.52	8.00	3.0 ~ 9.2	2000	570 ~ 2880	4.00	A
1.6 + 2.5 + 3.5 + 4.2	11.8	1.08	1.69	2.37	2.86	8.00	3.0 ~ 9.2	2000	570 ~ 2880	4.00	A
1.6 + 2.5 + 3.5 + 5.0	12.6	1.02	1.59	2.22	3.17	8.00	3.0 ~ 9.2	1950	630 ~ 2740	4.10	A
1.6 + 2.5 + 3.5 + 6.0	13.6	0.94	1.47	2.06	3.53	8.00	3.0 ~ 9.2	1950	630 ~ 2740	4.10	A
1.6 + 2.5 + 3.5 + 7.1	14.7	0.87	1.36	1.90	3.87	8.00	3.0 ~ 9.2	1950	630 ~ 2740	4.10	A
1.6 + 2.5 + 4.2 + 4.2	12.5	1.02	1.60	2.69	2.69	8.00	3.0 ~ 9.2	2000	570 ~ 2880	4.00	A
1.6 + 2.5 + 4.2 + 5.0	13.3	0.96	1.50	2.53	3.01	8.00	3.0 ~ 9.2	1950	630 ~ 2740	4.10	A
1.6 + 2.5 + 4.2 + 6.0	14.3	0.90	1.40	2.35	3.35	8.00	3.0 ~ 9.2	1950	630 ~ 2740	4.10	A
1.6 + 2.5 + 5.0 + 5.0	14.1	0.90	1.42	2.84	2.84	8.00	3.0 ~ 9.2	1970	690 ~ 2680	4.06	A
1.6 + 3.5 + 3.5 + 3.5	12.1	1.07	2.31	2.31	2.31	8.00	3.0 ~ 9.2	2000	570 ~ 2880	4.00	A
1.6 + 3.5 + 3.5 + 4.2	12.8	1.00	2.19	2.19	2.62	8.00	3.0 ~ 9.2	2000	570 ~ 2800	4.00	A
1.6 + 3.5 + 3.5 + 5.0	13.6	0.94	2.06	2.06	2.94	8.00	3.0 ~ 9.2	1950	630 ~ 2740	4.10	A
1.6 + 3.5 + 3.5 + 6.0	14.6	0.88	1.92	1.92	3.28	8.00	3.0 ~ 9.2	1950	630 ~ 2740	4.10	A
1.6 + 3.5 + 4.2 + 4.2	13.5	0.95	2.07	2.49	2.49	8.00	3.0 ~ 9.2	2000	570 ~ 2800	4.00	A
1.6 + 3.5 + 4.2 + 5.0	14.3	0.90	1.96	2.35	2.79	8.00	3.0 ~ 9.2	1950	630 ~ 2740	4.10	A
1.6 + 4.2 + 4.2 + 4.2	14.2	0.89	2.37	2.37	2.37	8.00	3.0 ~ 9.2	2000	570 ~ 2800	4.00	A
2.0 + 2.0 + 2.0 + 2.0	8.0	2.00	2.00	2.00	2.00	8.00	3.0 ~ 9.2	2060	530 ~ 2950	3.88	A
2.0 + 2.0 + 2.0 + 2.5	8.5	1.88	1.88	1.88	2.36	8.00	3.0 ~ 9.2	2060	530 ~ 2950	3.88	A
2.0 + 2.0 + 2.0 + 3.5	9.5	1.68	1.68	1.68	2.96	8.00	3.0 ~ 9.2	2000	570 ~ 2880	4.00	A
2.0 + 2.0 + 2.0 + 4.2	10.2	1.57	1.57	1.57	3.29	8.00	3.0 ~ 9.2	2000	570 ~ 2880	4.00	A
2.0 + 2.0 + 2.0 + 5.0	11.0	1.45	1.45	1.45	3.65	8.00	3.0 ~ 9.2	1950	620 ~ 2730	4.10	A
2.0 + 2.0 + 2.0 + 6.0	12.0	1.33	1.33	1.33	4.01	8.00	3.0 ~ 9.2	1950	620 ~ 2730	4.10	A
2.0 + 2.0 + 2.0 + 7.1	13.1	1.22	1.22	1.22	4.34	8.00	3.0 ~ 9.2	1950	630 ~ 2740	4.10	A
2.0 + 2.0 + 2.5 + 2.5	9.0	1.78	1.78	2.22	2.22	8.00	3.0 ~ 9.2	2060	530 ~ 2950	3.88	A
2.0 + 2.0 + 2.5 + 3.5	10.0	1.60	1.60	2.00	2.80	8.00	3.0 ~ 9.2	2000	570 ~ 2880	4.00	A
2.0 + 2.0 + 2.5 + 4.2	10.7	1.50	1.50	1.87	3.13	8.00	3.0 ~ 9.2	2000	570 ~ 2880	4.00	A
2.0 + 2.0 + 2.5 + 5.0	11.5	1.39	1.39	1.74	3.48	8.00	3.0 ~ 9.2	1950	620 ~ 2730	4.10	A
2.0 + 2.0 + 2.5 + 6.0	12.5	1.28	1.28	1.60	3.84	8.00	3.0 ~ 9.2	1950	620 ~ 2730	4.10	A
2.0 + 2.0 + 2.5 + 7.1	13.6	1.18	1.18	1.47	4.17	8.00	3.0 ~ 9.2	1950	630 ~ 2740	4.10	A
2.0 + 2.0 + 3.5 + 3.5	11.0	1.45	1.45	2.55	2.55	8.00	3.0 ~ 9.2	2000	570 ~ 2880	4.00	A
2.0 + 2.0 + 3.5 + 4.2	11.7	1.37	1.37	2.39	2.87	8.00	3.0 ~ 9.2	2000	570 ~ 2880	4.00	A
2.0 + 2.0 + 3.5 + 5.0	12.5	1.28	1.28	2.24	3.20	8.00	3.0 ~ 9.2	1950	630 ~ 2740	4.10	A
2.0 + 2.0 + 3.5 + 6.0	13.5	1.19	1.19	2.07	3.55	8.00	3.0 ~ 9.2	1950	630 ~ 2740	4.10	A
2.0 + 2.0 + 3.5 + 7.1	14.6	1.10	1.10	1.92	3.88	8.00	3.0 ~ 9.2	1950	630 ~ 2740	4.10	A
2.0 + 2.0 + 4.2 + 4.2	12.4	1.29	1.29	2.71	2.71	8.00	3.0 ~ 9.2	2000	570 ~ 2880	4.00	A
2.0 + 2.0 + 4.2 + 5.0	13.2	1.21	1.21	2.55	3.03	8.00	3.0 ~ 9.2	1950	630 ~ 2740	4.10	A
2.0 + 2.0 + 4.2 + 6.0	14.2	1.13	1.13	2.37	3.37	8.00	3.0 ~ 9.2	1950	630 ~ 2740	4.10	A
2.0 + 2.0 + 5.0 + 5.0	14.0	1.14	1.14	2.86	2.86	8.00	3.0 ~ 9.2	1970	700 ~ 2680	4.06	A
2.0 + 2.5 + 2.5 + 2.5	9.5	1.67	2.11	2.11	2.11	8.00	3.0 ~ 9.2	2060	530 ~ 2950	3.88	A
2.0 + 2.5 + 2.5 + 3.5	10.5	1.52	1.90	1.90	2.68	8.00	3.0 ~ 9.2	2000	570 ~ 2880	4.00	A
2.0 + 2.5 + 2.5 + 4.2	11.2	1.43	1.79	1.79	2.99	8.00	3.0 ~ 9.2	2000	570 ~ 2880	4.00	A
2.0 + 2.5 + 2.5 + 5.0	12.0	1.33	1.67	1.67	3.33	8.00	3.0 ~ 9.2	1950	620 ~ 2730	4.10	A
2.0 + 2.5 + 2.5 + 6.0	13.0	1.23	1.54	1.54	3.69	8.00	3.0 ~ 9.2	1950	620 ~ 2730	4.10	A
2.0 + 2.5 + 2.5 + 7.1	14.1	1.13	1.42	1.42	4.03	8.00	3.0 ~ 9.2	1950	630 ~ 2740	4.10	A
2.0 + 2.5 + 3.5 + 3.5	11.5	1.39	1.75	2.43	2.43	8.00	3.0 ~ 9.2	2000	570 ~ 2880	4.00	A
2.0 + 2.5 + 3.5 + 4.2	12.2	1.31	1.64	2.30	2.75	8.00	3.0 ~ 9.2	2000	570 ~ 2880	4.00	A
2.0 + 2.5 + 3.5 + 5.0	13.0	1.23	1.54	2.15	3.08	8.00	3.0 ~ 9.2	1950	630 ~ 2740	4.10	A
2.0 + 2.5 + 3.5 + 6.0	14.0	1.14	1.43	2.00	3.43	8.00	3.0 ~ 9.2	1950	630 ~ 2740	4.10	A
2.0 + 2.5 + 4.2 + 4.2	12.9	1.24	1.56	2.60	2.60	8.00	3.0 ~ 9.2	2000	570 ~ 2880	4.00	A
2.0 + 2.5 + 4.2 + 5.0	13.7	1.17	1.46	2.45	2.92	8.00	3.0 ~ 9.2	1950	630 ~ 2740	4.10	A
2.0 + 2.5 + 4.2 + 6.0	14.7	1.09	1.36	2.29	3.26	8.00	3.0 ~ 9.2	1950	630 ~ 2740	4.10	A
2.0 + 2.5 + 5.0 + 5.0	14.5	1.10	1.38	2.76	2.76	8.00	3.0 ~ 9.2	1970	700 ~ 2680	4.06	A
2.0 + 3.5 + 3.5 + 3.5	12.5	1.28	2.24	2.24	2.24	8.00	3.0 ~ 9.2	2000	570 ~ 2800	4.00	A
2.0 + 3.5 + 3.5 + 4.2	13.2	1.21	2.12	2.12	2.55	8.00	3.0 ~ 9.2	2000	570 ~ 2800	4.00	A
2.0 + 3.5 + 3.5 + 5.0	14.0	1.14	2.00	2.00	2.86	8.00	3.0 ~ 9.2	1950	630 ~ 2740	4.10	A

Indoor unit capacity Cooling	Annual Energy Consumption (kWh)	Current 230V (A)	ERP				Moisture Removal Volume l/h
			Pdesign (kW)	SEER		Annual Consumption (kWh)	
				W/W	CLASS		
1.6 + 2.5 + 2.5 + 5.0	975	9.3	8.00	7.50	A++	373	0.7 + 1.1 + 1.1 + 2.0
1.6 + 2.5 + 2.5 + 6.0	975	9.3	8.00	7.50	A++	373	0.7 + 1.0 + 1.0 + 2.2
1.6 + 2.5 + 2.5 + 7.1	975	9.3	8.00	7.50	A++	373	0.7 + 0.9 + 0.9 + 2.4
1.6 + 2.5 + 3.5 + 3.5	1000	9.6	8.00	7.50	A++	373	0.7 + 1.2 + 1.5 + 1.5
1.6 + 2.5 + 3.5 + 4.2	1000	9.6	8.00	7.50	A++	373	0.7 + 1.1 + 1.5 + 1.7
1.6 + 2.5 + 3.5 + 5.0	975	9.3	8.00	7.50	A++	373	0.7 + 1.0 + 1.4 + 1.8
1.6 + 2.5 + 3.5 + 6.0	975	9.3	8.00	7.50	A++	373	0.7 + 0.9 + 1.3 + 2.0
1.6 + 2.5 + 3.5 + 7.1	975	9.3	8.00	7.50	A++	373	0.7 + 0.9 + 1.2 + 2.3
1.6 + 2.5 + 4.2 + 4.2	1000	9.6	8.00	7.50	A++	373	0.7 + 1.0 + 1.6 + 1.6
1.6 + 2.5 + 4.2 + 5.0	975	9.3	8.00	7.50	A++	373	0.7 + 1.0 + 1.6 + 1.7
1.6 + 2.5 + 4.2 + 6.0	975	9.3	8.00	7.50	A++	373	0.7 + 0.9 + 1.5 + 1.9
1.6 + 2.5 + 5.0 + 5.0	985	9.4	8.00	7.50	A++	373	0.7 + 0.9 + 1.7 + 1.7
1.6 + 3.5 + 3.5 + 3.5	1000	9.6	8.00	7.50	A++	373	0.7 + 1.5 + 1.5 + 1.5
1.6 + 3.5 + 3.5 + 4.2	1000	9.6	8.00	7.50	A++	373	0.7 + 1.4 + 1.4 + 1.6
1.6 + 3.5 + 3.5 + 5.0	975	9.3	8.00	7.50	A++	373	0.7 + 1.3 + 1.3 + 1.7
1.6 + 3.5 + 3.5 + 6.0	975	9.3	8.00	7.50	A++	373	0.7 + 1.2 + 1.2 + 1.9
1.6 + 3.5 + 4.2 + 4.2	1000	9.6	8.00	7.50	A++	373	0.7 + 1.3 + 1.5 + 1.5
1.6 + 3.5 + 4.2 + 5.0	975	9.3	8.00	7.50	A++	373	0.7 + 1.3 + 1.5 + 1.6
1.6 + 4.2 + 4.2 + 4.2	1000	9.6	8.00	7.50	A++	373	0.7 + 1.5 + 1.5 + 1.5
2.0 + 2.0 + 2.0 + 2.0	1030	9.9	8.00	7.50	A++	373	1.3 + 1.3 + 1.3 + 1.3
2.0 + 2.0 + 2.0 + 2.5	1030	9.9	8.00	7.50	A++	373	1.2 + 1.2 + 1.2 + 1.5
2.0 + 2.0 + 2.0 + 3.5	1000	9.6	8.00	7.50	A++	373	1.1 + 1.1 + 1.1 + 1.7
2.0 + 2.0 + 2.0 + 4.2	1000	9.6	8.00	7.50	A++	373	1.0 + 1.0 + 1.0 + 1.9
2.0 + 2.0 + 2.0 + 5.0	975	9.3	8.00	7.50	A++	373	0.9 + 0.9 + 0.9 + 2.1
2.0 + 2.0 + 2.0 + 6.0	975	9.3	8.00	7.50	A++	373	0.8 + 0.8 + 0.8 + 2.3
2.0 + 2.0 + 2.0 + 7.1	975	9.3	8.00	7.50	A++	373	0.8 + 0.8 + 0.8 + 2.4
2.0 + 2.0 + 2.5 + 2.5	1030	9.9	8.00	7.50	A++	373	1.1 + 1.1 + 1.4 + 1.4
2.0 + 2.0 + 2.5 + 3.5	1000	9.6	8.00	7.50	A++	373	1.0 + 1.0 + 1.3 + 1.6
2.0 + 2.0 + 2.5 + 4.2	1000	9.6	8.00	7.50	A++	373	1.0 + 1.0 + 1.2 + 1.8
2.0 + 2.0 + 2.5 + 5.0	975	9.3	8.00	7.50	A++	373	0.9 + 0.9 + 1.1 + 2.0
2.0 + 2.0 + 2.5 + 6.0	975	9.3	8.00	7.50	A++	373	0.8 + 0.8 + 1.0 + 2.2
2.0 + 2.0 + 2.5 + 7.1	975	9.3	8.00	7.50	A++	373	0.7 + 0.7 + 0.9 + 2.4
2.0 + 2.0 + 3.5 + 3.5	1000	9.6	8.00	7.50	A++	373	0.9 + 0.9 + 1.6 + 1.6
2.0 + 2.0 + 3.5 + 4.2	1000	9.6	8.00	7.50	A++	373	0.9 + 0.9 + 1.5 + 1.7
2.0 + 2.0 + 3.5 + 5.0	975	9.3	8.00	7.50	A++	373	0.8 + 0.8 + 1.5 + 1.8
2.0 + 2.0 + 3.5 + 6.0	975	9.3	8.00	7.50	A++	373	0.7 + 0.7 + 1.3 + 2.1
2.0 + 2.0 + 3.5 + 7.1	975	9.3	8.00	7.50	A++	373	0.7 + 0.7 + 1.2 + 2.3
2.0 + 2.0 + 4.2 + 4.2	1000	9.6	8.00	7.50	A++	373	0.8 + 0.8 + 1.6 + 1.6
2.0 + 2.0 + 4.2 + 5.0	975	9.3	8.00	7.50	A++	373	0.8 + 0.8 + 1.6 + 1.7
2.0 + 2.0 + 4.2 + 6.0	975	9.3	8.00	7.50	A++	373	0.7 + 0.7 + 1.5 + 1.9
2.0 + 2.0 + 5.0 + 5.0	985	9.4	8.00	7.50	A++	373	0.7 + 0.7 + 1.7 + 1.7
2.0 + 2.5 + 2.5 + 2.5	1030	9.9	8.00	7.50	A++	373	1.1 + 1.4 + 1.4 + 1.4
2.0 + 2.5 + 2.5 + 3.5	1000	9.6	8.00	7.50	A++	373	1.0 + 1.2 + 1.2 + 1.6
2.0 + 2.5 + 2.5 + 4.2	1000	9.6	8.00	7.50	A++	373	0.9 + 1.2 + 1.2 + 1.7
2.0 + 2.5 + 2.5 + 5.0	975	9.3	8.00	7.50	A++	373	0.8 + 1.1 + 1.1 + 1.9
2.0 + 2.5 + 2.5 + 6.0	975	9.3	8.00	7.50	A++	373	0.8 + 1.0 + 1.0 + 2.1
2.0 + 2.5 + 2.5 + 7.1	975	9.3	8.00	7.50	A++	373	0.7 + 0.9 + 0.9 + 2.3
2.0 + 2.5 + 3.5 + 3.5	1000	9.6	8.00	7.50	A++	373	0.9 + 1.1 + 1.5 + 1.5
2.0 + 2.5 + 3.5 + 4.2	1000	9.6	8.00	7.50	A++	373	0.8 + 1.0 + 1.5 + 1.6
2.0 + 2.5 + 3.5 + 5.0	975	9.3	8.00	7.50	A++	373	0.8 + 1.0 + 1.4 + 1.7
2.0 + 2.5 + 3.5 + 6.0	975	9.3	8.00	7.50	A++	373	0.7 + 0.9 + 1.3 + 2.0
2.0 + 2.5 + 4.2 + 4.2	1000	9.6	8.00	7.50	A++	373	0.8 + 1.0 + 1.6 + 1.6
2.0 + 2.5 + 4.2 + 5.0	975	9.3	8.00	7.50	A++	373	0.7 + 0.9 + 1.5 + 1.7
2.0 + 2.5 + 4.2 + 6.0	975	9.3	8.00	7.50	A++	373	0.7 + 0.9 + 1.5 + 1.9
2.0 + 2.5 + 5.0 + 5.0	985	9.4	8.00	7.50	A++	373	0.7 + 0.9 + 1.6 + 1.6
2.0 + 3.5 + 3.5 + 3.5	1000	9.6	8.00	7.50	A++	373	0.8 + 1.5 + 1.5 + 1.5
2.0 + 3.5 + 3.5 + 4.2	1000	9.6	8.00	7.50	A++	373	0.8 + 1.4 + 1.4 + 1.6
2.0 + 3.5 + 3.5 + 5.0	975	9.3	8.00	7.50	A++	373	0.7 + 1.3 + 1.3 + 1.7

4  
Room

Indoor unit capacity Cooling		Total	Cooling Capacity (kW)						Input Power (W)		EER	
			Room A	Room B	Room C	Room D	Total	min ~ max	Rating	min ~ max	W/W	CLASS
4 Room	2.0 + 3.5 + 4.2 + 4.2	13.9	1.15	2.01	2.42	2.42	8.00	3.0 ~ 9.2	2000	570 ~ 2800	4.00	A
	2.0 + 3.5 + 4.2 + 5.0	14.7	1.09	1.90	2.29	2.72	8.00	3.0 ~ 9.2	1950	630 ~ 2740	4.10	A
	2.0 + 4.2 + 4.2 + 4.2	14.6	1.10	2.30	2.30	2.30	8.00	3.0 ~ 9.2	1950	580 ~ 2800	4.10	A
	2.5 + 2.5 + 2.5 + 2.5	10.0	2.00	2.00	2.00	2.00	8.00	3.0 ~ 9.2	2060	530 ~ 2950	3.88	A
	2.5 + 2.5 + 2.5 + 3.5	11.0	1.82	1.82	1.82	2.54	8.00	3.0 ~ 9.2	2000	570 ~ 2880	4.00	A
	2.5 + 2.5 + 2.5 + 4.2	11.7	1.71	1.71	1.71	2.87	8.00	3.0 ~ 9.2	2000	570 ~ 2880	4.00	A
	2.5 + 2.5 + 2.5 + 5.0	12.5	1.60	1.60	1.60	3.20	8.00	3.0 ~ 9.2	1950	620 ~ 2730	4.10	A
	2.5 + 2.5 + 2.5 + 6.0	13.5	1.48	1.48	1.48	3.56	8.00	3.0 ~ 9.2	1950	620 ~ 2730	4.10	A
	2.5 + 2.5 + 2.5 + 7.1	14.6	1.37	1.37	1.37	3.89	8.00	3.0 ~ 9.2	1950	630 ~ 2740	4.10	A
	2.5 + 2.5 + 3.5 + 3.5	12.0	1.67	1.67	2.33	2.33	8.00	3.0 ~ 9.2	2000	570 ~ 2880	4.00	A
	2.5 + 2.5 + 3.5 + 4.2	12.7	1.57	1.57	2.20	2.66	8.00	3.0 ~ 9.2	2000	570 ~ 2880	4.00	A
	2.5 + 2.5 + 3.5 + 5.0	13.5	1.48	1.48	2.07	2.97	8.00	3.0 ~ 9.2	1950	630 ~ 2740	4.10	A
	2.5 + 2.5 + 3.5 + 6.0	14.5	1.38	1.38	1.93	3.31	8.00	3.0 ~ 9.2	1950	630 ~ 2740	4.10	A
	2.5 + 2.5 + 4.2 + 4.2	13.4	1.49	1.49	2.51	2.51	8.00	3.0 ~ 9.2	2000	570 ~ 2880	4.00	A
	2.5 + 2.5 + 4.2 + 5.0	14.2	1.41	1.41	2.37	2.81	8.00	3.0 ~ 9.2	1950	630 ~ 2740	4.10	A
	2.5 + 3.5 + 3.5 + 3.5	13.0	1.55	2.15	2.15	2.15	8.00	3.0 ~ 9.2	2000	570 ~ 2800	4.00	A
	2.5 + 3.5 + 3.5 + 4.2	13.7	1.46	2.04	2.04	2.46	8.00	3.0 ~ 9.2	2000	570 ~ 2800	4.00	A
	2.5 + 3.5 + 3.5 + 5.0	14.5	1.38	1.93	1.93	2.76	8.00	3.0 ~ 9.2	1950	630 ~ 2740	4.10	A
	2.5 + 3.5 + 4.2 + 4.2	14.4	1.39	1.95	2.33	2.33	8.00	3.0 ~ 9.2	2000	570 ~ 2800	4.00	A
	3.5 + 3.5 + 3.5 + 3.5	14.0	2.00	2.00	2.00	2.00	8.00	3.0 ~ 9.2	1950	580 ~ 2800	4.10	A
3.5 + 3.5 + 3.5 + 4.2	14.7	1.90	1.90	1.90	2.30	8.00	3.0 ~ 9.2	1950	580 ~ 2800	4.10	A	

Indoor unit capacity Cooling	Annual Energy Consumption (kWh)	Current 230V (A)	ERP				Moisture Removal Volume l/h
			Pdesign (kW)	SEER		Annual Consumption (kWh)	
				WW	CLASS		
2.0 + 3.5 + 4.2 + 4.2	1000	9.6	8.00	7.50	A++	373	0.7 + 1.3 + 1.5 + 1.5
2.0 + 3.5 + 4.2 + 5.0	975	9.3	8.00	7.50	A++	373	0.7 + 1.2 + 1.5 + 1.6
2.0 + 4.2 + 4.2 + 4.2	975	9.3	8.00	7.50	A++	373	0.7 + 1.5 + 1.5 + 1.5
2.5 + 2.5 + 2.5 + 2.5	1030	9.9	8.00	7.50	A++	373	1.3 + 1.3 + 1.3 + 1.3
2.5 + 2.5 + 2.5 + 3.5	1000	9.6	8.00	7.50	A++	373	1.2 + 1.2 + 1.2 + 1.6
2.5 + 2.5 + 2.5 + 4.2	1000	9.6	8.00	7.50	A++	373	1.1 + 1.1 + 1.1 + 1.7
2.5 + 2.5 + 2.5 + 5.0	975	9.3	8.00	7.50	A++	373	1.0 + 1.0 + 1.0 + 1.8
2.5 + 2.5 + 2.5 + 6.0	975	9.3	8.00	7.50	A++	373	0.9 + 0.9 + 0.9 + 2.1
2.5 + 2.5 + 2.5 + 7.1	975	9.3	8.00	7.50	A++	373	0.9 + 0.9 + 0.9 + 2.3
2.5 + 2.5 + 3.5 + 3.5	1000	9.6	8.00	7.50	A++	373	1.1 + 1.1 + 1.5 + 1.5
2.5 + 2.5 + 3.5 + 4.2	1000	9.6	8.00	7.50	A++	373	1.0 + 1.0 + 1.4 + 1.6
2.5 + 2.5 + 3.5 + 5.0	975	9.3	8.00	7.50	A++	373	0.9 + 0.9 + 1.3 + 1.7
2.5 + 2.5 + 3.5 + 6.0	975	9.3	8.00	7.50	A++	373	0.9 + 0.9 + 1.2 + 1.9
2.5 + 2.5 + 4.2 + 4.2	1000	9.6	8.00	7.50	A++	373	0.9 + 0.9 + 1.5 + 1.5
2.5 + 2.5 + 4.2 + 5.0	975	9.3	8.00	7.50	A++	373	0.9 + 0.9 + 1.5 + 1.6
2.5 + 3.5 + 3.5 + 3.5	1000	9.6	8.00	7.50	A++	373	1.0 + 1.4 + 1.4 + 1.4
2.5 + 3.5 + 3.5 + 4.2	1000	9.6	8.00	7.50	A++	373	0.9 + 1.3 + 1.3 + 1.5
2.5 + 3.5 + 3.5 + 5.0	975	9.3	8.00	7.50	A++	373	0.9 + 1.2 + 1.2 + 1.6
2.5 + 3.5 + 4.2 + 4.2	1000	9.6	8.00	7.50	A++	373	0.9 + 1.3 + 1.5 + 1.5
3.5 + 3.5 + 3.5 + 3.5	975	9.3	8.00	7.50	A++	373	1.3 + 1.3 + 1.3 + 1.3
3.5 + 3.5 + 3.5 + 4.2	975	9.3	8.00	7.50	A++	373	1.2 + 1.2 + 1.2 + 1.5

- Indoor Unit : Combination of all wall mount series (CS-MZ / Z / XZ / MTZ / TZ / TE)
- Outdoor Unit : CU-4Z80TBE

Indoor unit capacity Heating	Total	Heating Capacity (kW)						Input Power (W)		COP		
		Room A	Room B	Room C	Room D	Total	min ~ max	Rating	min ~ max	W/W	CLASS	
1 Room	1.6	1.6	2.60				2.60	1.2 ~ 3.2	640	300 ~ 1000	4.06	A
	2.0	2.0	3.20				3.20	1.2 ~ 4.1	780	300 ~ 1270	4.10	A
	2.5	2.5	3.60				3.60	1.2 ~ 4.3	980	300 ~ 1270	3.67	A
	3.5	3.5	4.50				4.50	1.2 ~ 5.8	1270	300 ~ 2140	3.54	B
	4.2	4.2	5.60				5.60	1.2 ~ 6.8	1760	300 ~ 2970	3.18	D
	5.0	5.0	6.80				6.80	1.2 ~ 6.9	2140	300 ~ 2560	3.18	D
	6.0	6.0	8.50				8.50	1.3 ~ 9.0	2440	620 ~ 2590	3.48	B
	7.1	7.1	8.70				8.70	1.4 ~ 9.2	2590	680 ~ 2760	3.36	C
2 Room	1.6 + 1.6	3.2	2.60	2.60			5.20	2.2 ~ 8.2	1640	430 ~ 2920	3.17	D
	1.6 + 2.0	3.6	2.58	3.22			5.80	2.2 ~ 8.2	1760	430 ~ 2910	3.30	C
	1.6 + 2.5	4.1	2.42	3.78			6.20	2.2 ~ 8.2	1900	430 ~ 2910	3.26	C
	1.6 + 3.5	5.1	2.23	4.87			7.10	2.2 ~ 8.6	2070	380 ~ 2990	3.43	B
	1.6 + 4.2	5.8	2.26	5.94			8.20	2.2 ~ 9.8	2450	370 ~ 3520	3.35	C
	1.6 + 5.0	6.6	2.28	7.12			9.40	2.2 ~ 10.0	2540	330 ~ 3330	3.70	A
	1.6 + 6.0	7.6	1.98	7.42			9.40	2.2 ~ 10.0	2540	330 ~ 3330	3.70	A
	1.6 + 7.1	8.7	1.73	7.67			9.40	2.2 ~ 10.3	2480	320 ~ 3500	3.79	A
	2.0 + 2.0	4.0	3.20	3.20			6.40	2.2 ~ 8.2	1940	390 ~ 2900	3.30	C
	2.0 + 2.5	4.5	3.02	3.78			6.80	2.2 ~ 8.2	2000	390 ~ 2900	3.40	C
	2.0 + 3.5	5.5	2.80	4.90			7.70	2.2 ~ 8.6	2250	370 ~ 2930	3.42	B
	2.0 + 4.2	6.2	2.84	5.96			8.80	2.2 ~ 10.0	2500	370 ~ 3630	3.52	B
	2.0 + 5.0	7.0	2.69	6.71			9.40	2.2 ~ 10.0	2530	320 ~ 3310	3.72	A
	2.0 + 6.0	8.0	2.35	7.05			9.40	2.2 ~ 10.0	2530	320 ~ 3310	3.72	A
	2.0 + 7.1	9.1	2.07	7.33			9.40	2.2 ~ 10.3	2470	320 ~ 3480	3.81	A
	2.5 + 2.5	5.0	3.60	3.60			7.20	2.2 ~ 8.6	2130	390 ~ 3010	3.38	C
	2.5 + 3.5	6.0	3.37	4.73			8.10	2.2 ~ 9.8	2400	370 ~ 3520	3.38	C
	2.5 + 4.2	6.7	3.43	5.77			9.20	2.2 ~ 10.0	2650	370 ~ 3630	3.47	B
	2.5 + 5.0	7.5	3.13	6.27			9.40	2.2 ~ 10.0	2530	320 ~ 3310	3.72	A
	2.5 + 6.0	8.5	2.76	6.64			9.40	2.2 ~ 10.0	2530	320 ~ 3310	3.72	A
	2.5 + 7.1	9.6	2.45	6.95			9.40	2.2 ~ 10.3	2470	320 ~ 3480	3.81	A
	3.5 + 3.5	7.0	4.50	4.50			9.00	2.2 ~ 10.0	2530	360 ~ 3550	3.56	B
	3.5 + 4.2	7.7	4.27	5.13			9.40	2.2 ~ 10.0	2670	350 ~ 3540	3.52	B
	3.5 + 5.0	8.5	3.87	5.53			9.40	2.2 ~ 10.0	2460	320 ~ 3280	3.82	A
	3.5 + 6.0	9.5	3.46	5.94			9.40	2.2 ~ 10.3	2460	320 ~ 3400	3.82	A
	3.5 + 7.1	10.6	3.10	6.30			9.40	2.2 ~ 10.5	2440	310 ~ 3510	3.85	A
	4.2 + 4.2	8.4	4.70	4.70			9.40	2.2 ~ 10.0	2660	350 ~ 3530	3.53	B
4.2 + 5.0	9.2	4.29	5.11			9.40	2.2 ~ 10.3	2440	320 ~ 3390	3.85	A	
4.2 + 6.0	10.2	3.87	5.53			9.40	2.2 ~ 10.3	2440	320 ~ 3390	3.85	A	
4.2 + 7.1	11.3	3.49	5.91			9.40	2.2 ~ 10.5	2430	310 ~ 3500	3.87	A	
5.0 + 5.0	10.0	4.70	4.70			9.40	2.2 ~ 10.3	2280	310 ~ 3170	4.12	A	
5.0 + 6.0	11.0	4.27	5.13			9.40	2.2 ~ 10.5	2280	310 ~ 3230	4.12	A	
5.0 + 7.1	12.1	3.88	5.52			9.40	2.2 ~ 10.5	2260	310 ~ 3210	4.16	A	
6.0 + 6.0	12.0	4.70	4.70			9.40	2.2 ~ 10.5	2280	310 ~ 3230	4.12	A	
6.0 + 7.1	13.1	4.31	5.09			9.40	2.2 ~ 10.5	2260	310 ~ 3210	4.16	A	
7.1 + 7.1	14.2	4.70	4.70			9.40	2.2 ~ 10.5	2250	320 ~ 3200	4.18	A	



	Indoor unit capacity Heating	Annual Energy Consumption (kWh)	Current 230V (A)	ERP				Moisture Removal Volume l/h
				Pdesign (kW)	SCOP		Annual Consumption (kWh)	
					WW	CLASS		
1 Room	1.6	320	3.1	-	-	-	-	
	2.0	390	3.8	-	-	-	-	
	2.5	490	4.9	-	-	-	-	
	3.5	635	6.2	-	-	-	-	
	4.2	880	8.1	-	-	-	-	
	5.0	1070	9.9	-	-	-	-	
	6.0	1220	11.3	-	-	-	-	
	7.1	1295	11.9	-	-	-	-	
2 Room	1.6 + 1.6	820	7.8	3.50	3.80	A	1289	
	1.6 + 2.0	880	8.3	3.50	3.80	A	1289	
	1.6 + 2.5	950	8.9	3.50	3.80	A	1289	
	1.6 + 3.5	1035	9.7	4.50	3.80	A	1658	
	1.6 + 4.2	1225	11.5	4.50	3.80	A	1658	
	1.6 + 5.0	1270	11.9	5.50	3.90	A	1974	
	1.6 + 6.0	1270	11.9	5.50	3.90	A	1974	
	1.6 + 7.1	1240	11.7	5.50	3.90	A	1974	
	2.0 + 2.0	970	9.1	3.50	3.80	A	1289	
	2.0 + 2.5	1000	9.4	3.50	3.80	A	1289	
	2.0 + 3.5	1125	10.6	4.50	3.80	A	1658	
	2.0 + 4.2	1250	11.7	4.50	3.80	A	1658	
	2.0 + 5.0	1265	11.9	5.50	3.90	A	1974	
	2.0 + 6.0	1265	11.9	5.50	3.90	A	1974	
	2.0 + 7.1	1235	11.6	5.50	3.90	A	1974	
	2.5 + 2.5	1065	10.0	3.50	3.80	A	1289	
	2.5 + 3.5	1200	11.3	4.50	3.80	A	1658	
	2.5 + 4.2	1325	12.5	4.50	3.80	A	1658	
	2.5 + 5.0	1265	11.9	5.50	3.90	A	1974	
	2.5 + 6.0	1265	11.9	5.50	3.90	A	1974	
	2.5 + 7.1	1235	11.6	5.50	3.90	A	1974	
	3.5 + 3.5	1265	11.9	4.50	3.80	A	1658	
	3.5 + 4.2	1335	12.5	4.50	3.80	A	1658	
	3.5 + 5.0	1230	11.6	5.50	3.90	A	1974	
	3.5 + 6.0	1230	11.6	5.50	3.90	A	1974	
	3.5 + 7.1	1220	11.5	5.50	3.90	A	1974	
	4.2 + 4.2	1330	12.5	4.50	3.80	A	1658	
	4.2 + 5.0	1220	11.5	5.50	3.90	A	1974	
	4.2 + 6.0	1220	11.5	5.50	3.90	A	1974	
	4.2 + 7.1	1215	11.4	5.50	3.90	A	1974	
5.0 + 5.0	1140	10.7	6.80	3.90	A	2441		
5.0 + 6.0	1140	10.7	6.80	3.90	A	2441		
5.0 + 7.1	1130	10.6	6.80	3.90	A	2441		
6.0 + 6.0	1140	10.7	6.80	3.90	A	2441		
6.0 + 7.1	1130	10.6	6.80	3.90	A	2441		
7.1 + 7.1	1125	10.6	6.80	3.90	A	2441		

Indoor unit capacity Heating	Total	Heating Capacity (kW)					Input Power (W)		COP		
		Room A	Room B	Room C	Room D	Total	min ~ max	Rating	min ~ max	W/W	CLASS
1.6 + 1.6 + 1.6	4.8	2.60	2.60	2.60		7.80	3.2 ~ 10.4	2000	500 ~ 3460	3.90	A
1.6 + 1.6 + 2.0	5.2	2.58	2.58	3.24		8.40	3.2 ~ 10.4	2230	500 ~ 3380	3.77	A
1.6 + 1.6 + 2.5	5.7	2.47	2.47	3.86		8.80	3.2 ~ 10.4	2210	500 ~ 3380	3.98	A
1.6 + 1.6 + 3.5	6.7	2.24	2.24	4.92		9.40	3.2 ~ 10.4	2370	490 ~ 3350	3.97	A
1.6 + 1.6 + 4.2	7.4	2.03	2.03	5.34		9.40	3.2 ~ 10.4	2360	490 ~ 3330	3.98	A
1.6 + 1.6 + 5.0	8.2	1.83	1.83	5.74		9.40	3.2 ~ 10.4	2250	480 ~ 3120	4.18	A
1.6 + 1.6 + 6.0	9.2	1.63	1.63	6.14		9.40	3.2 ~ 10.5	2250	480 ~ 3180	4.18	A
1.6 + 1.6 + 7.1	10.3	1.46	1.46	6.48		9.40	3.2 ~ 10.5	2240	510 ~ 3160	4.20	A
1.6 + 2.0 + 2.0	5.6	2.58	3.21	3.21		9.00	3.2 ~ 10.4	2250	490 ~ 3370	4.00	A
1.6 + 2.0 + 2.5	6.1	2.47	3.08	3.85		9.40	3.2 ~ 10.4	2390	490 ~ 3370	3.93	A
1.6 + 2.0 + 3.5	7.1	2.12	2.65	4.63		9.40	3.2 ~ 10.4	2360	490 ~ 3330	3.98	A
1.6 + 2.0 + 4.2	7.8	1.93	2.41	5.06		9.40	3.2 ~ 10.4	2350	490 ~ 3320	4.00	A
1.6 + 2.0 + 5.0	8.6	1.75	2.19	5.46		9.40	3.2 ~ 10.5	2240	510 ~ 3170	4.20	A
1.6 + 2.0 + 6.0	9.6	1.57	1.96	5.87		9.40	3.2 ~ 10.5	2240	510 ~ 3170	4.20	A
1.6 + 2.0 + 7.1	10.7	1.41	1.76	6.23		9.40	3.2 ~ 10.5	2230	510 ~ 3150	4.22	A
1.6 + 2.5 + 2.5	6.6	2.28	3.56	3.56		9.40	3.2 ~ 10.4	2390	490 ~ 3370	3.93	A
1.6 + 2.5 + 3.5	7.6	1.98	3.09	4.33		9.40	3.2 ~ 10.4	2360	490 ~ 3330	3.98	A
1.6 + 2.5 + 4.2	8.3	1.81	2.83	4.76		9.40	3.2 ~ 10.4	2350	490 ~ 3320	4.00	A
1.6 + 2.5 + 5.0	9.1	1.65	2.58	5.17		9.40	3.2 ~ 10.5	2240	510 ~ 3170	4.20	A
1.6 + 2.5 + 6.0	10.1	1.49	2.33	5.58		9.40	3.2 ~ 10.5	2240	510 ~ 3170	4.20	A
1.6 + 2.5 + 7.1	11.2	1.34	2.10	5.96		9.40	3.2 ~ 10.6	2230	510 ~ 3210	4.22	A
1.6 + 3.5 + 3.5	8.6	1.74	3.83	3.83		9.40	3.2 ~ 10.5	2330	480 ~ 3360	4.03	A
1.6 + 3.5 + 4.2	9.3	1.62	3.54	4.24		9.40	3.2 ~ 10.5	2320	480 ~ 3280	4.05	A
1.6 + 3.5 + 5.0	10.1	1.49	3.26	4.65		9.40	3.2 ~ 10.5	2210	510 ~ 3130	4.25	A
1.6 + 3.5 + 6.0	11.1	1.35	2.96	5.09		9.40	3.2 ~ 10.6	2210	510 ~ 3190	4.25	A
1.6 + 3.5 + 7.1	12.2	1.23	2.70	5.47		9.40	3.2 ~ 10.6	2200	510 ~ 3180	4.27	A
1.6 + 4.2 + 4.2	10.0	1.50	3.95	3.95		9.40	3.2 ~ 10.5	2310	480 ~ 3270	4.07	A
1.6 + 4.2 + 5.0	10.8	1.39	3.66	4.35		9.40	3.2 ~ 10.5	2210	510 ~ 3120	4.25	A
1.6 + 4.2 + 6.0	11.8	1.27	3.35	4.78		9.40	3.2 ~ 10.6	2210	510 ~ 3180	4.25	A
1.6 + 4.2 + 7.1	12.9	1.17	3.06	5.17		9.40	3.2 ~ 10.6	2190	510 ~ 3160	4.29	A
1.6 + 5.0 + 5.0	11.6	1.30	4.05	4.05		9.40	3.2 ~ 10.6	2120	570 ~ 3050	4.43	A
1.6 + 5.0 + 6.0	12.6	1.19	3.73	4.48		9.40	3.2 ~ 10.6	2120	570 ~ 3050	4.43	A
1.6 + 5.0 + 7.1	13.7	1.10	3.43	4.87		9.40	3.2 ~ 10.6	2110	590 ~ 3040	4.45	A
1.6 + 6.0 + 6.0	13.6	1.10	4.15	4.15		9.40	3.2 ~ 10.6	2120	570 ~ 3050	4.43	A
1.6 + 6.0 + 7.1	14.7	1.02	3.84	4.54		9.40	3.2 ~ 10.6	2110	590 ~ 3040	4.45	A
2.0 + 2.0 + 2.0	6.0	3.13	3.13	3.13		9.39	3.2 ~ 10.4	2380	490 ~ 3360	3.95	A
2.0 + 2.0 + 2.5	6.5	2.89	2.89	3.62		9.40	3.2 ~ 10.4	2380	490 ~ 3360	3.95	A
2.0 + 2.0 + 3.5	7.5	2.51	2.51	4.38		9.40	3.2 ~ 10.4	2350	490 ~ 3320	4.00	A
2.0 + 2.0 + 4.2	8.2	2.29	2.29	4.82		9.40	3.2 ~ 10.4	2340	480 ~ 3310	4.02	A
2.0 + 2.0 + 5.0	9.0	2.09	2.09	5.22		9.40	3.2 ~ 10.5	2230	510 ~ 3150	4.22	A
2.0 + 2.0 + 6.0	10.0	1.88	1.88	5.64		9.40	3.2 ~ 10.5	2230	510 ~ 3150	4.22	A
2.0 + 2.0 + 7.1	11.1	1.69	1.69	6.02		9.40	3.2 ~ 10.6	2220	510 ~ 3200	4.23	A
2.0 + 2.5 + 2.5	7.0	2.68	3.36	3.36		9.40	3.2 ~ 10.4	2380	490 ~ 3360	3.95	A
2.0 + 2.5 + 3.5	8.0	2.35	2.94	4.11		9.40	3.2 ~ 10.4	2350	490 ~ 3320	4.00	A
2.0 + 2.5 + 4.2	8.7	2.16	2.70	4.54		9.40	3.2 ~ 10.5	2340	480 ~ 3370	4.02	A
2.0 + 2.5 + 5.0	9.5	1.98	2.47	4.95		9.40	3.2 ~ 10.5	2230	510 ~ 3150	4.22	A
2.0 + 2.5 + 6.0	10.5	1.79	2.24	5.37		9.40	3.2 ~ 10.5	2230	510 ~ 3150	4.22	A
2.0 + 2.5 + 7.1	11.6	1.62	2.03	5.75		9.40	3.2 ~ 10.6	2220	510 ~ 3200	4.23	A
2.0 + 3.5 + 3.5	9.0	2.08	3.66	3.66		9.40	3.2 ~ 10.5	2320	480 ~ 3280	4.05	A
2.0 + 3.5 + 4.2	9.7	1.94	3.39	4.07		9.40	3.2 ~ 10.5	2310	480 ~ 3270	4.07	A
2.0 + 3.5 + 5.0	10.5	1.79	3.13	4.48		9.40	3.2 ~ 10.5	2210	510 ~ 3120	4.25	A
2.0 + 3.5 + 6.0	11.5	1.63	2.86	4.91		9.40	3.2 ~ 10.6	2210	510 ~ 3180	4.25	A
2.0 + 3.5 + 7.1	12.6	1.49	2.61	5.30		9.40	3.2 ~ 10.6	2190	510 ~ 3160	4.29	A
2.0 + 4.2 + 4.2	10.4	1.80	3.80	3.80		9.40	3.2 ~ 10.5	2300	480 ~ 3260	4.09	A
2.0 + 4.2 + 5.0	11.2	1.68	3.53	4.19		9.40	3.2 ~ 10.6	2200	510 ~ 3170	4.27	A
2.0 + 4.2 + 6.0	12.2	1.54	3.24	4.62		9.40	3.2 ~ 10.6	2200	510 ~ 3170	4.27	A
2.0 + 4.2 + 7.1	13.3	1.41	2.97	5.02		9.40	3.2 ~ 10.6	2190	520 ~ 3150	4.29	A
2.0 + 5.0 + 5.0	12.0	1.56	3.92	3.92		9.40	3.2 ~ 10.6	2110	590 ~ 3040	4.45	A

3  
Room

Indoor unit capacity Heating	Annual Energy Consumption (kWh)	Current 230V (A)	ERP				Moisture Removal Volume l/h
			Pdesign (kW)	SCOP		Annual Consumption (kWh)	
				W/W	CLASS		
1.6 + 1.6 + 1.6	1000	9.4	5.00	4.10	A+	1707	
1.6 + 1.6 + 2.0	1115	10.5	5.00	4.10	A+	1707	
1.6 + 1.6 + 2.5	1105	10.4	5.00	4.10	A+	1707	
1.6 + 1.6 + 3.5	1185	11.1	6.00	4.20	A+	2000	
1.6 + 1.6 + 4.2	1180	11.1	6.00	4.20	A+	2000	
1.6 + 1.6 + 5.0	1125	10.6	6.80	4.20	A+	2267	
1.6 + 1.6 + 6.0	1125	10.6	6.80	4.20	A+	2267	
1.6 + 1.6 + 7.1	1120	10.5	6.80	4.20	A+	2267	
1.6 + 2.0 + 2.0	1125	10.6	5.00	4.10	A+	1707	
1.6 + 2.0 + 2.5	1195	11.2	6.00	4.20	A+	2000	
1.6 + 2.0 + 3.5	1180	11.1	6.00	4.20	A+	2000	
1.6 + 2.0 + 4.2	1175	11.0	6.00	4.20	A+	2000	
1.6 + 2.0 + 5.0	1120	10.5	6.80	4.20	A+	2267	
1.6 + 2.0 + 6.0	1120	10.5	6.80	4.20	A+	2267	
1.6 + 2.0 + 7.1	1115	10.5	6.80	4.20	A+	2267	
1.6 + 2.5 + 2.5	1195	11.2	6.00	4.20	A+	2000	
1.6 + 2.5 + 3.5	1180	11.1	6.00	4.20	A+	2000	
1.6 + 2.5 + 4.2	1175	11.0	6.80	4.20	A+	2267	
1.6 + 2.5 + 5.0	1120	10.5	6.80	4.20	A+	2267	
1.6 + 2.5 + 6.0	1120	10.5	6.80	4.20	A+	2267	
1.6 + 2.5 + 7.1	1115	10.5	6.80	4.20	A+	2267	
1.6 + 3.5 + 3.5	1165	10.9	6.80	4.20	A+	2267	
1.6 + 3.5 + 4.2	1160	10.9	6.80	4.20	A+	2267	
1.6 + 3.5 + 5.0	1105	10.4	6.80	4.20	A+	2267	
1.6 + 3.5 + 6.0	1105	10.4	6.80	4.20	A+	2267	
1.6 + 3.5 + 7.1	1100	10.3	6.80	4.20	A+	2267	
1.6 + 4.2 + 4.2	1155	10.9	6.80	4.20	A+	2267	
1.6 + 4.2 + 5.0	1105	10.4	6.80	4.20	A+	2267	
1.6 + 4.2 + 6.0	1105	10.4	6.80	4.20	A+	2267	
1.6 + 4.2 + 7.1	1095	10.3	6.80	4.20	A+	2267	
1.6 + 5.0 + 5.0	1060	10.0	6.80	4.20	A+	2267	
1.6 + 5.0 + 6.0	1060	10.0	6.80	4.20	A+	2267	
1.6 + 5.0 + 7.1	1055	9.9	6.80	4.20	A+	2267	
1.6 + 6.0 + 6.0	1060	10.0	6.80	4.20	A+	2267	
1.6 + 6.0 + 7.1	1055	9.9	6.80	4.20	A+	2267	
2.0 + 2.0 + 2.0	1190	11.2	6.00	4.20	A+	2000	
2.0 + 2.0 + 2.5	1190	11.2	6.00	4.20	A+	2000	
2.0 + 2.0 + 3.5	1175	11.0	6.00	4.20	A+	2000	
2.0 + 2.0 + 4.2	1170	11.0	6.80	4.20	A+	2267	
2.0 + 2.0 + 5.0	1115	10.5	6.80	4.20	A+	2267	
2.0 + 2.0 + 6.0	1115	10.5	6.80	4.20	A+	2267	
2.0 + 2.0 + 7.1	1110	10.4	6.80	4.20	A+	2267	
2.0 + 2.5 + 2.5	1190	11.2	6.00	4.20	A+	2000	
2.0 + 2.5 + 3.5	1175	11.0	6.80	4.20	A+	2267	
2.0 + 2.5 + 4.2	1170	11.0	6.80	4.20	A+	2267	
2.0 + 2.5 + 5.0	1115	10.5	6.80	4.20	A+	2267	
2.0 + 2.5 + 6.0	1115	10.5	6.80	4.20	A+	2267	
2.0 + 2.5 + 7.1	1110	10.4	6.80	4.20	A+	2267	
2.0 + 3.5 + 3.5	1160	10.9	6.80	4.20	A+	2267	
2.0 + 3.5 + 4.2	1155	10.9	6.80	4.20	A+	2267	
2.0 + 3.5 + 5.0	1105	10.4	6.80	4.20	A+	2267	
2.0 + 3.5 + 6.0	1105	10.4	6.80	4.20	A+	2267	
2.0 + 3.5 + 7.1	1095	10.3	6.80	4.20	A+	2267	
2.0 + 4.2 + 4.2	1150	10.8	6.80	4.20	A+	2267	
2.0 + 4.2 + 5.0	1100	10.3	6.80	4.20	A+	2267	
2.0 + 4.2 + 6.0	1100	10.3	6.80	4.20	A+	2267	
2.0 + 4.2 + 7.1	1095	10.3	6.80	4.20	A+	2267	
2.0 + 5.0 + 5.0	1055	9.9	6.80	4.20	A+	2267	

3  
Room

Indoor unit capacity Heating	Total	Heating Capacity (kW)						Input Power (W)		COP		
		Room A	Room B	Room C	Room D	Total	min ~ max	Rating	min ~ max	W/W	CLASS	
3 Room	2.0 + 5.0 + 6.0	13.0	1.45	3.62	4.33		9.40	3.2 ~ 10.6	2110	590 ~ 3040	4.45	A
	2.0 + 5.0 + 7.1	14.1	1.33	3.33	4.74		9.40	3.2 ~ 10.6	2100	600 ~ 3030	4.48	A
	2.0 + 6.0 + 6.0	14.0	1.34	4.03	4.03		9.40	3.2 ~ 10.6	2110	590 ~ 3040	4.45	A
	2.5 + 2.5 + 2.5	7.5	3.13	3.13	3.13		9.39	3.2 ~ 10.4	2380	490 ~ 3360	3.95	A
	2.5 + 2.5 + 3.5	8.5	2.76	2.76	3.88		9.40	3.2 ~ 10.4	2350	490 ~ 3320	4.00	A
	2.5 + 2.5 + 4.2	9.2	2.55	2.55	4.30		9.40	3.2 ~ 10.5	2340	480 ~ 3370	4.02	A
	2.5 + 2.5 + 5.0	10.0	2.35	2.35	4.70		9.40	3.2 ~ 10.5	2230	510 ~ 3150	4.22	A
	2.5 + 2.5 + 6.0	11.0	2.14	2.14	5.12		9.40	3.2 ~ 10.5	2230	510 ~ 3150	4.22	A
	2.5 + 2.5 + 7.1	12.1	1.94	1.94	5.52		9.40	3.2 ~ 10.6	2220	510 ~ 3200	4.23	A
	2.5 + 3.5 + 3.5	9.5	2.48	3.46	3.46		9.40	3.2 ~ 10.5	2320	480 ~ 3280	4.05	A
	2.5 + 3.5 + 4.2	10.2	2.30	3.23	3.87		9.40	3.2 ~ 10.5	2310	480 ~ 3270	4.07	A
	2.5 + 3.5 + 5.0	11.0	2.14	2.99	4.27		9.40	3.2 ~ 10.5	2210	510 ~ 3120	4.25	A
	2.5 + 3.5 + 6.0	12.0	1.96	2.74	4.70		9.40	3.2 ~ 10.6	2210	510 ~ 3180	4.25	A
	2.5 + 3.5 + 7.1	13.1	1.79	2.51	5.10		9.40	3.2 ~ 10.6	2190	510 ~ 3160	4.29	A
	2.5 + 4.2 + 4.2	10.9	2.16	3.62	3.62		9.40	3.2 ~ 10.5	2300	480 ~ 3260	4.09	A
	2.5 + 4.2 + 5.0	11.7	2.01	3.37	4.02		9.40	3.2 ~ 10.6	2200	510 ~ 3170	4.27	A
	2.5 + 4.2 + 6.0	12.7	1.85	3.11	4.44		9.40	3.2 ~ 10.6	2200	510 ~ 3170	4.27	A
	2.5 + 4.2 + 7.1	13.8	1.70	2.86	4.84		9.40	3.2 ~ 10.6	2190	520 ~ 3150	4.29	A
	2.5 + 5.0 + 5.0	12.5	1.88	3.76	3.76		9.40	3.2 ~ 10.6	2110	590 ~ 3040	4.45	A
	2.5 + 5.0 + 6.0	13.5	1.74	3.48	4.18		9.40	3.2 ~ 10.6	2110	590 ~ 3040	4.45	A
	2.5 + 5.0 + 7.1	14.6	1.61	3.22	4.57		9.40	3.2 ~ 10.6	2100	600 ~ 3030	4.48	A
	2.5 + 6.0 + 6.0	14.5	1.62	3.89	3.89		9.40	3.2 ~ 10.6	2110	590 ~ 3040	4.45	A
	3.5 + 3.5 + 3.5	10.5	3.13	3.13	3.13		9.39	3.2 ~ 10.5	2300	480 ~ 3250	4.08	A
	3.5 + 3.5 + 4.2	11.2	2.94	2.94	3.52		9.40	3.2 ~ 10.6	2290	480 ~ 3290	4.10	A
	3.5 + 3.5 + 5.0	12.0	2.74	2.74	3.92		9.40	3.2 ~ 10.6	2180	520 ~ 3150	4.31	A
	3.5 + 3.5 + 6.0	13.0	2.53	2.53	4.34		9.40	3.2 ~ 10.6	2180	520 ~ 3150	4.31	A
	3.5 + 3.5 + 7.1	14.1	2.33	2.33	4.74		9.40	3.2 ~ 10.6	2170	520 ~ 3130	4.33	A
	3.5 + 4.2 + 4.2	11.9	2.76	3.32	3.32		9.40	3.2 ~ 10.6	2280	480 ~ 3280	4.12	A
3.5 + 4.2 + 5.0	12.7	2.59	3.11	3.70		9.40	3.2 ~ 10.6	2170	520 ~ 3140	4.33	A	
3.5 + 4.2 + 6.0	13.7	2.40	2.88	4.12		9.40	3.2 ~ 10.6	2170	520 ~ 3140	4.33	A	
3.5 + 5.0 + 5.0	13.5	2.44	3.48	3.48		9.40	3.2 ~ 10.6	2090	600 ~ 3010	4.50	A	
3.5 + 5.0 + 6.0	14.5	2.27	3.24	3.89		9.40	3.2 ~ 10.6	2090	600 ~ 3010	4.50	A	
4.2 + 4.2 + 4.2	12.6	3.13	3.13	3.13		9.39	3.2 ~ 10.6	2270	480 ~ 3270	4.14	A	
4.2 + 4.2 + 5.0	13.4	2.95	2.95	3.50		9.40	3.2 ~ 10.6	2170	540 ~ 3120	4.33	A	
4.2 + 4.2 + 6.0	14.4	2.74	2.74	3.92		9.40	3.2 ~ 10.6	2170	540 ~ 3120	4.33	A	
4.2 + 5.0 + 5.0	14.2	2.78	3.31	3.31		9.40	3.2 ~ 10.6	2090	610 ~ 3000	4.50	A	

Indoor unit capacity Heating	Annual Energy Consumption (kWh)	Current 230V (A)	ERP				Moisture Removal Volume l/h	
			Pdesign (kW)	SCOP		Annual Consumption (kWh)		
				WW	CLASS			
3 Room	2.0 + 5.0 + 6.0	1055	9.9	6.80	4.20	A+	2267	
	2.0 + 5.0 + 7.1	1050	9.9	6.80	4.20	A+	2267	
	2.0 + 6.0 + 6.0	1055	9.9	6.80	4.20	A+	2267	
	2.5 + 2.5 + 2.5	1190	11.2	6.00	4.20	A+	2000	
	2.5 + 2.5 + 3.5	1175	11.0	6.80	4.20	A+	2267	
	2.5 + 2.5 + 4.2	1170	11.0	6.80	4.20	A+	2267	
	2.5 + 2.5 + 5.0	1115	10.5	6.80	4.20	A+	2267	
	2.5 + 2.5 + 6.0	1115	10.5	6.80	4.20	A+	2267	
	2.5 + 2.5 + 7.1	1110	10.4	6.80	4.20	A+	2267	
	2.5 + 3.5 + 3.5	1160	10.9	6.80	4.20	A+	2267	
	2.5 + 3.5 + 4.2	1155	10.9	6.80	4.20	A+	2267	
	2.5 + 3.5 + 5.0	1105	10.4	6.80	4.20	A+	2267	
	2.5 + 3.5 + 6.0	1105	10.4	6.80	4.20	A+	2267	
	2.5 + 3.5 + 7.1	1095	10.3	6.80	4.20	A+	2267	
	2.5 + 4.2 + 4.2	1150	10.8	6.80	4.20	A+	2267	
	2.5 + 4.2 + 5.0	1100	10.3	6.80	4.20	A+	2267	
	2.5 + 4.2 + 6.0	1100	10.3	6.80	4.20	A+	2267	
	2.5 + 4.2 + 7.1	1095	10.3	6.80	4.20	A+	2267	
	2.5 + 5.0 + 5.0	1055	9.9	6.80	4.20	A+	2267	
	2.5 + 5.0 + 6.0	1055	9.9	6.80	4.20	A+	2267	
	2.5 + 5.0 + 7.1	1050	9.9	6.80	4.20	A+	2267	
	2.5 + 6.0 + 6.0	1055	9.9	6.80	4.20	A+	2267	
	3.5 + 3.5 + 3.5	1150	10.8	6.80	4.20	A+	2267	
	3.5 + 3.5 + 4.2	1145	10.8	6.80	4.20	A+	2267	
	3.5 + 3.5 + 5.0	1090	10.2	6.80	4.20	A+	2267	
	3.5 + 3.5 + 6.0	1090	10.2	6.80	4.20	A+	2267	
	3.5 + 3.5 + 7.1	1085	10.2	6.80	4.20	A+	2267	
	3.5 + 4.2 + 4.2	1140	10.7	6.80	4.20	A+	2267	
	3.5 + 4.2 + 5.0	1085	10.2	6.80	4.20	A+	2267	
	3.5 + 4.2 + 6.0	1085	10.2	6.80	4.20	A+	2267	
3.5 + 5.0 + 5.0	1045	9.8	6.80	4.20	A+	2267		
3.5 + 5.0 + 6.0	1045	9.8	6.80	4.20	A+	2267		
4.2 + 4.2 + 4.2	1135	10.7	6.80	4.20	A+	2267		
4.2 + 4.2 + 5.0	1085	10.2	6.80	4.20	A+	2267		
4.2 + 4.2 + 6.0	1085	10.2	6.80	4.20	A+	2267		
4.2 + 5.0 + 5.0	1045	9.8	6.80	4.20	A+	2267		

Indoor unit capacity Heating	Total	Heating Capacity (kW)					Input Power (W)		COP		
		Room A	Room B	Room C	Room D	Total	min ~ max	Rating	min ~ max	W/W	CLASS
1.6 + 1.6 + 1.6 + 1.6	6.4	2.35	2.35	2.35	2.35	9.40	4.2 ~ 10.6	2230	680 ~ 3190	4.22	A
1.6 + 1.6 + 1.6 + 2.0	6.8	2.21	2.21	2.21	2.77	9.40	4.2 ~ 10.6	2220	680 ~ 3180	4.23	A
1.6 + 1.6 + 1.6 + 2.5	7.3	2.06	2.06	2.06	3.22	9.40	4.2 ~ 10.6	2220	680 ~ 3180	4.23	A
1.6 + 1.6 + 1.6 + 3.5	8.3	1.81	1.81	1.81	3.97	9.40	4.2 ~ 10.6	2200	690 ~ 3150	4.27	A
1.6 + 1.6 + 1.6 + 4.2	9.0	1.67	1.67	1.67	4.39	9.40	4.2 ~ 10.6	2190	690 ~ 3140	4.29	A
1.6 + 1.6 + 1.6 + 5.0	9.8	1.53	1.53	1.53	4.81	9.40	4.2 ~ 10.6	2160	760 ~ 3020	4.35	A
1.6 + 1.6 + 1.6 + 6.0	10.8	1.39	1.39	1.39	5.23	9.40	4.2 ~ 10.6	2160	760 ~ 3020	4.35	A
1.6 + 1.6 + 1.6 + 7.1	11.9	1.26	1.26	1.26	5.62	9.40	4.2 ~ 10.6	2150	770 ~ 3010	4.37	A
1.6 + 1.6 + 2.0 + 2.0	7.2	2.09	2.09	2.61	2.61	9.40	4.2 ~ 10.6	2210	680 ~ 3170	4.25	A
1.6 + 1.6 + 2.0 + 2.5	7.7	1.95	1.95	2.44	3.06	9.40	4.2 ~ 10.6	2210	680 ~ 3170	4.25	A
1.6 + 1.6 + 2.0 + 3.5	8.7	1.73	1.73	2.16	3.78	9.40	4.2 ~ 10.6	2190	690 ~ 3140	4.29	A
1.6 + 1.6 + 2.0 + 4.2	9.4	1.60	1.60	2.00	4.20	9.40	4.2 ~ 10.6	2180	710 ~ 3130	4.31	A
1.6 + 1.6 + 2.0 + 5.0	10.2	1.47	1.47	1.84	4.62	9.40	4.2 ~ 10.6	2150	770 ~ 3010	4.37	A
1.6 + 1.6 + 2.0 + 6.0	11.2	1.34	1.34	1.68	5.04	9.40	4.2 ~ 10.6	2150	770 ~ 3010	4.37	A
1.6 + 1.6 + 2.0 + 7.1	12.3	1.22	1.22	1.53	5.43	9.40	4.2 ~ 10.6	2140	790 ~ 3060	4.39	A
1.6 + 1.6 + 2.5 + 2.5	8.2	1.83	1.83	2.87	2.87	9.40	4.2 ~ 10.6	2210	680 ~ 3170	4.25	A
1.6 + 1.6 + 2.5 + 3.5	9.2	1.63	1.63	2.55	3.59	9.40	4.2 ~ 10.6	2190	690 ~ 3140	4.29	A
1.6 + 1.6 + 2.5 + 4.2	9.9	1.52	1.52	2.37	3.99	9.40	4.2 ~ 10.6	2180	710 ~ 3130	4.31	A
1.6 + 1.6 + 2.5 + 5.0	10.7	1.41	1.41	2.20	4.38	9.40	4.2 ~ 10.6	2150	770 ~ 3010	4.37	A
1.6 + 1.6 + 2.5 + 6.0	11.7	1.29	1.29	2.01	4.81	9.40	4.2 ~ 10.6	2150	770 ~ 3010	4.37	A
1.6 + 1.6 + 2.5 + 7.1	12.8	1.18	1.18	1.84	5.20	9.40	4.2 ~ 10.6	2140	790 ~ 3060	4.39	A
1.6 + 1.6 + 3.5 + 3.5	10.2	1.47	1.47	3.23	3.23	9.40	4.2 ~ 10.6	2170	720 ~ 3110	4.33	A
1.6 + 1.6 + 3.5 + 4.2	10.9	1.38	1.38	3.02	3.62	9.40	4.2 ~ 10.6	2160	720 ~ 3100	4.35	A
1.6 + 1.6 + 3.5 + 5.0	11.7	1.29	1.29	2.81	4.01	9.40	4.2 ~ 10.6	2140	800 ~ 3050	4.39	A
1.6 + 1.6 + 3.5 + 6.0	12.7	1.18	1.18	2.59	4.45	9.40	4.2 ~ 10.6	2140	800 ~ 3050	4.39	A
1.6 + 1.6 + 3.5 + 7.1	13.8	1.09	1.09	2.38	4.84	9.40	4.2 ~ 10.6	2130	800 ~ 3030	4.41	A
1.6 + 1.6 + 4.2 + 4.2	11.6	1.30	1.30	3.40	3.40	9.40	4.2 ~ 10.6	2160	720 ~ 3090	4.35	A
1.6 + 1.6 + 4.2 + 5.0	12.4	1.21	1.21	3.18	3.80	9.40	4.2 ~ 10.6	2130	800 ~ 3040	4.41	A
1.6 + 1.6 + 4.2 + 6.0	13.4	1.12	1.12	2.95	4.21	9.40	4.2 ~ 10.6	2130	800 ~ 3040	4.41	A
1.6 + 1.6 + 4.2 + 7.1	14.5	1.04	1.04	2.72	4.60	9.40	4.2 ~ 10.6	2130	810 ~ 3030	4.41	A
1.6 + 1.6 + 5.0 + 5.0	13.2	1.14	1.14	3.56	3.56	9.40	4.2 ~ 10.6	2170	920 ~ 3010	4.33	A
1.6 + 1.6 + 5.0 + 6.0	14.2	1.06	1.06	3.31	3.97	9.40	4.2 ~ 10.6	2170	920 ~ 3010	4.33	A
1.6 + 2.0 + 2.0 + 2.0	7.6	1.99	2.47	2.47	2.47	9.40	4.2 ~ 10.6	2200	690 ~ 3160	4.27	A
1.6 + 2.0 + 2.0 + 2.5	8.1	1.86	2.32	2.32	2.90	9.40	4.2 ~ 10.6	2200	690 ~ 3160	4.27	A
1.6 + 2.0 + 2.0 + 3.5	9.1	1.65	2.07	2.07	3.61	9.40	4.2 ~ 10.6	2180	710 ~ 3130	4.31	A
1.6 + 2.0 + 2.0 + 4.2	9.8	1.53	1.92	1.92	4.03	9.40	4.2 ~ 10.6	2170	710 ~ 3120	4.33	A
1.6 + 2.0 + 2.0 + 5.0	10.6	1.42	1.77	1.77	4.44	9.40	4.2 ~ 10.6	2150	790 ~ 3060	4.37	A
1.6 + 2.0 + 2.0 + 6.0	11.6	1.30	1.62	1.62	4.86	9.40	4.2 ~ 10.6	2150	790 ~ 3060	4.37	A
1.6 + 2.0 + 2.0 + 7.1	12.7	1.18	1.48	1.48	5.26	9.40	4.2 ~ 10.6	2140	800 ~ 3050	4.39	A
1.6 + 2.0 + 2.5 + 2.5	8.6	1.75	2.19	2.73	2.73	9.40	4.2 ~ 10.6	2200	690 ~ 3160	4.27	A
1.6 + 2.0 + 2.5 + 3.5	9.6	1.57	1.96	2.45	3.42	9.40	4.2 ~ 10.6	2180	710 ~ 3130	4.31	A
1.6 + 2.0 + 2.5 + 4.2	10.3	1.46	1.83	2.28	3.83	9.40	4.2 ~ 10.6	2170	710 ~ 3120	4.33	A
1.6 + 2.0 + 2.5 + 5.0	11.1	1.35	1.69	2.12	4.24	9.40	4.2 ~ 10.6	2150	790 ~ 3060	4.37	A
1.6 + 2.0 + 2.5 + 6.0	12.1	1.24	1.55	1.94	4.67	9.40	4.2 ~ 10.6	2150	790 ~ 3060	4.37	A
1.6 + 2.0 + 2.5 + 7.1	13.2	1.14	1.42	1.78	5.06	9.40	4.2 ~ 10.6	2140	800 ~ 3050	4.39	A
1.6 + 2.0 + 3.5 + 3.5	10.6	1.42	1.78	3.10	3.10	9.40	4.2 ~ 10.6	2160	720 ~ 3100	4.35	A
1.6 + 2.0 + 3.5 + 4.2	11.3	1.33	1.66	2.91	3.50	9.40	4.2 ~ 10.6	2160	720 ~ 3090	4.35	A
1.6 + 2.0 + 3.5 + 5.0	12.1	1.24	1.55	2.72	3.89	9.40	4.2 ~ 10.6	2130	800 ~ 3040	4.41	A
1.6 + 2.0 + 3.5 + 6.0	13.1	1.15	1.44	2.51	4.30	9.40	4.2 ~ 10.6	2130	800 ~ 3040	4.41	A
1.6 + 2.0 + 3.5 + 7.1	14.2	1.06	1.32	2.32	4.70	9.40	4.2 ~ 10.6	2130	810 ~ 3030	4.41	A
1.6 + 2.0 + 4.2 + 4.2	12.0	1.25	1.57	3.29	3.29	9.40	4.2 ~ 10.6	2150	720 ~ 3080	4.37	A
1.6 + 2.0 + 4.2 + 5.0	12.8	1.18	1.47	3.08	3.67	9.40	4.2 ~ 10.6	2130	810 ~ 3030	4.41	A
1.6 + 2.0 + 4.2 + 6.0	13.8	1.09	1.36	2.86	4.09	9.40	4.2 ~ 10.6	2130	810 ~ 3030	4.41	A
1.6 + 2.0 + 5.0 + 5.0	13.6	1.10	1.38	3.46	3.46	9.40	4.2 ~ 10.6	2170	930 ~ 3060	4.33	A
1.6 + 2.0 + 5.0 + 6.0	14.6	1.03	1.29	3.22	3.86	9.40	4.2 ~ 10.6	2170	930 ~ 3060	4.33	A
1.6 + 2.5 + 2.5 + 2.5	9.1	1.66	2.58	2.58	2.58	9.40	4.2 ~ 10.6	2200	690 ~ 3160	4.27	A
1.6 + 2.5 + 2.5 + 3.5	10.1	1.49	2.33	2.33	3.25	9.40	4.2 ~ 10.6	2180	710 ~ 3130	4.31	A
1.6 + 2.5 + 2.5 + 4.2	10.8	1.39	2.18	2.18	3.65	9.40	4.2 ~ 10.6	2170	710 ~ 3120	4.33	A

Indoor unit capacity Heating	Annual Energy Consumption (kWh)	Current 230V (A)	ERP				Moisture Removal Volume l/h
			Pdesign (kW)	SCOP		Annual Consumption (kWh)	
				W/W	CLASS		
1.6 + 1.6 + 1.6 + 1.6	1115	10.5	6.80	4.30	A+	2214	
1.6 + 1.6 + 1.6 + 2.0	1110	10.4	6.80	4.30	A+	2214	
1.6 + 1.6 + 1.6 + 2.5	1110	10.4	6.80	4.30	A+	2214	
1.6 + 1.6 + 1.6 + 3.5	1100	10.3	6.80	4.40	A+	2164	
1.6 + 1.6 + 1.6 + 4.2	1095	10.3	6.80	4.40	A+	2164	
1.6 + 1.6 + 1.6 + 5.0	1080	10.2	6.80	4.40	A+	2164	
1.6 + 1.6 + 1.6 + 6.0	1080	10.2	6.80	4.40	A+	2164	
1.6 + 1.6 + 1.6 + 7.1	1075	10.1	6.80	4.40	A+	2164	
1.6 + 1.6 + 2.0 + 2.0	1105	10.4	6.80	4.30	A+	2214	
1.6 + 1.6 + 2.0 + 2.5	1105	10.4	6.80	4.30	A+	2214	
1.6 + 1.6 + 2.0 + 3.5	1095	10.3	6.80	4.40	A+	2164	
1.6 + 1.6 + 2.0 + 4.2	1090	10.2	6.80	4.40	A+	2164	
1.6 + 1.6 + 2.0 + 5.0	1075	10.1	6.80	4.40	A+	2164	
1.6 + 1.6 + 2.0 + 6.0	1075	10.1	6.80	4.40	A+	2164	
1.6 + 1.6 + 2.0 + 7.1	1070	10.1	6.80	4.40	A+	2164	
1.6 + 1.6 + 2.5 + 2.5	1105	10.4	6.80	4.40	A+	2164	
1.6 + 1.6 + 2.5 + 3.5	1095	10.3	6.80	4.40	A+	2164	
1.6 + 1.6 + 2.5 + 4.2	1090	10.2	6.80	4.40	A+	2164	
1.6 + 1.6 + 2.5 + 5.0	1075	10.1	6.80	4.40	A+	2164	
1.6 + 1.6 + 2.5 + 6.0	1075	10.1	6.80	4.40	A+	2164	
1.6 + 1.6 + 2.5 + 7.1	1070	10.1	6.80	4.40	A+	2164	
1.6 + 1.6 + 3.5 + 3.5	1085	10.2	6.80	4.40	A+	2164	
1.6 + 1.6 + 3.5 + 4.2	1080	10.2	6.80	4.40	A+	2164	
1.6 + 1.6 + 3.5 + 5.0	1070	10.1	6.80	4.40	A+	2164	
1.6 + 1.6 + 3.5 + 6.0	1070	10.1	6.80	4.40	A+	2164	
1.6 + 1.6 + 3.5 + 7.1	1065	10.0	6.80	4.40	A+	2164	
1.6 + 1.6 + 4.2 + 4.2	1080	10.2	6.80	4.40	A+	2164	
1.6 + 1.6 + 4.2 + 5.0	1065	10.0	6.80	4.40	A+	2164	
1.6 + 1.6 + 4.2 + 6.0	1065	10.0	6.80	4.40	A+	2164	
1.6 + 1.6 + 4.2 + 7.1	1065	10.0	6.80	4.40	A+	2164	
1.6 + 1.6 + 5.0 + 5.0	1085	10.2	6.80	4.40	A+	2164	
1.6 + 1.6 + 5.0 + 6.0	1085	10.2	6.80	4.40	A+	2164	
1.6 + 2.0 + 2.0 + 2.0	1100	10.3	6.80	4.30	A+	2214	
1.6 + 2.0 + 2.0 + 2.5	1100	10.3	6.80	4.40	A+	2164	
1.6 + 2.0 + 2.0 + 3.5	1090	10.2	6.80	4.40	A+	2164	
1.6 + 2.0 + 2.0 + 4.2	1085	10.2	6.80	4.40	A+	2164	
1.6 + 2.0 + 2.0 + 5.0	1075	10.1	6.80	4.40	A+	2164	
1.6 + 2.0 + 2.0 + 6.0	1075	10.1	6.80	4.40	A+	2164	
1.6 + 2.0 + 2.0 + 7.1	1070	10.1	6.80	4.40	A+	2164	
1.6 + 2.0 + 2.5 + 2.5	1100	10.3	6.80	4.40	A+	2164	
1.6 + 2.0 + 2.5 + 3.5	1090	10.2	6.80	4.40	A+	2164	
1.6 + 2.0 + 2.5 + 4.2	1085	10.2	6.80	4.40	A+	2164	
1.6 + 2.0 + 2.5 + 5.0	1075	10.1	6.80	4.40	A+	2164	
1.6 + 2.0 + 2.5 + 6.0	1075	10.1	6.80	4.40	A+	2164	
1.6 + 2.0 + 2.5 + 7.1	1070	10.1	6.80	4.40	A+	2164	
1.6 + 2.0 + 3.5 + 3.5	1080	10.2	6.80	4.40	A+	2164	
1.6 + 2.0 + 3.5 + 4.2	1080	10.2	6.80	4.40	A+	2164	
1.6 + 2.0 + 3.5 + 5.0	1065	10.0	6.80	4.40	A+	2164	
1.6 + 2.0 + 3.5 + 6.0	1065	10.0	6.80	4.40	A+	2164	
1.6 + 2.0 + 3.5 + 7.1	1065	10.0	6.80	4.40	A+	2164	
1.6 + 2.0 + 4.2 + 4.2	1075	10.1	6.80	4.40	A+	2164	
1.6 + 2.0 + 4.2 + 5.0	1065	10.0	6.80	4.40	A+	2164	
1.6 + 2.0 + 4.2 + 6.0	1065	10.0	6.80	4.40	A+	2164	
1.6 + 2.0 + 5.0 + 5.0	1085	10.2	6.80	4.40	A+	2164	
1.6 + 2.0 + 5.0 + 6.0	1085	10.2	6.80	4.40	A+	2164	
1.6 + 2.5 + 2.5 + 2.5	1100	10.3	6.80	4.40	A+	2164	
1.6 + 2.5 + 2.5 + 3.5	1090	10.2	6.80	4.40	A+	2164	
1.6 + 2.5 + 2.5 + 4.2	1085	10.2	6.80	4.40	A+	2164	

4 Room

Indoor unit capacity Heating	Total	Heating Capacity (kW)					Input Power (W)		COP		
		Room A	Room B	Room C	Room D	Total	min ~ max	Rating	min ~ max	W/W	CLASS
1.6 + 2.5 + 2.5 + 5.0	11.6	1.30	2.03	2.03	4.04	9.40	4.2 ~ 10.6	2150	790 ~ 3060	4.37	A
1.6 + 2.5 + 2.5 + 6.0	12.6	1.19	1.87	1.87	4.47	9.40	4.2 ~ 10.6	2150	790 ~ 3060	4.37	A
1.6 + 2.5 + 2.5 + 7.1	13.7	1.10	1.72	1.72	4.86	9.40	4.2 ~ 10.6	2140	800 ~ 3050	4.39	A
1.6 + 2.5 + 3.5 + 3.5	11.1	1.35	2.13	2.96	2.96	9.40	4.2 ~ 10.6	2160	720 ~ 3100	4.35	A
1.6 + 2.5 + 3.5 + 4.2	11.8	1.27	1.99	2.79	3.35	9.40	4.2 ~ 10.6	2160	720 ~ 3090	4.35	A
1.6 + 2.5 + 3.5 + 5.0	12.6	1.19	1.87	2.61	3.73	9.40	4.2 ~ 10.6	2130	800 ~ 3040	4.41	A
1.6 + 2.5 + 3.5 + 6.0	13.6	1.10	1.73	2.42	4.15	9.40	4.2 ~ 10.6	2130	800 ~ 3040	4.41	A
1.6 + 2.5 + 3.5 + 7.1	14.7	1.02	1.60	2.24	4.54	9.40	4.2 ~ 10.6	2130	810 ~ 3030	4.41	A
1.6 + 2.5 + 4.2 + 4.2	12.5	1.20	1.88	3.16	3.16	9.40	4.2 ~ 10.6	2150	720 ~ 3080	4.37	A
1.6 + 2.5 + 4.2 + 5.0	13.3	1.13	1.77	2.97	3.53	9.40	4.2 ~ 10.6	2130	810 ~ 3030	4.41	A
1.6 + 2.5 + 4.2 + 6.0	14.3	1.05	1.64	2.76	3.95	9.40	4.2 ~ 10.6	2130	810 ~ 3030	4.41	A
1.6 + 2.5 + 5.0 + 5.0	14.1	1.07	1.67	3.33	3.33	9.40	4.2 ~ 10.6	2170	930 ~ 3060	4.33	A
1.6 + 3.5 + 3.5 + 3.5	12.1	1.24	2.72	2.72	2.72	9.40	4.2 ~ 10.6	2140	720 ~ 3070	4.39	A
1.6 + 3.5 + 3.5 + 4.2	12.8	1.18	2.57	2.57	3.08	9.40	4.2 ~ 10.6	2140	750 ~ 3060	4.39	A
1.6 + 3.5 + 3.5 + 5.0	13.6	1.11	2.42	2.42	3.45	9.40	4.2 ~ 10.6	2160	840 ~ 3020	4.35	A
1.6 + 3.5 + 3.5 + 6.0	14.6	1.03	2.25	2.25	3.87	9.40	4.2 ~ 10.6	2160	840 ~ 3020	4.35	A
1.6 + 3.5 + 4.2 + 4.2	13.5	1.11	2.45	2.92	2.92	9.40	4.2 ~ 10.6	2130	750 ~ 3050	4.41	A
1.6 + 3.5 + 4.2 + 5.0	14.3	1.05	2.30	2.76	3.29	9.40	4.2 ~ 10.6	2160	840 ~ 3010	4.35	A
1.6 + 4.2 + 4.2 + 4.2	14.2	1.06	2.78	2.78	2.78	9.40	4.2 ~ 10.6	2130	760 ~ 3040	4.41	A
2.0 + 2.0 + 2.0 + 2.0	8.0	2.35	2.35	2.35	2.35	9.40	4.2 ~ 10.6	2190	690 ~ 3150	4.29	A
2.0 + 2.0 + 2.0 + 2.5	8.5	2.21	2.21	2.21	2.77	9.40	4.2 ~ 10.6	2190	690 ~ 3150	4.29	A
2.0 + 2.0 + 2.0 + 3.5	9.5	1.98	1.98	1.98	3.46	9.40	4.2 ~ 10.6	2170	710 ~ 3120	4.33	A
2.0 + 2.0 + 2.0 + 4.2	10.2	1.84	1.84	1.84	3.88	9.40	4.2 ~ 10.6	2170	720 ~ 3110	4.33	A
2.0 + 2.0 + 2.0 + 5.0	11.0	1.71	1.71	1.71	4.27	9.40	4.2 ~ 10.6	2140	800 ~ 3050	4.39	A
2.0 + 2.0 + 2.0 + 6.0	12.0	1.57	1.57	1.57	4.69	9.40	4.2 ~ 10.6	2140	800 ~ 3050	4.39	A
2.0 + 2.0 + 2.0 + 7.1	13.1	1.44	1.44	1.44	5.08	9.40	4.2 ~ 10.6	2130	800 ~ 3040	4.41	A
2.0 + 2.0 + 2.5 + 2.5	9.0	2.09	2.09	2.61	2.61	9.40	4.2 ~ 10.6	2190	690 ~ 3150	4.29	A
2.0 + 2.0 + 2.5 + 3.5	10.0	1.88	1.88	2.35	3.29	9.40	4.2 ~ 10.6	2170	710 ~ 3120	4.33	A
2.0 + 2.0 + 2.5 + 4.2	10.7	1.76	1.76	2.20	3.68	9.40	4.2 ~ 10.6	2170	720 ~ 3110	4.33	A
2.0 + 2.0 + 2.5 + 5.0	11.5	1.63	1.63	2.04	4.10	9.40	4.2 ~ 10.6	2140	800 ~ 3050	4.39	A
2.0 + 2.0 + 2.5 + 6.0	12.5	1.50	1.50	1.88	4.52	9.40	4.2 ~ 10.6	2140	800 ~ 3050	4.39	A
2.0 + 2.0 + 2.5 + 7.1	13.6	1.38	1.38	1.73	4.91	9.40	4.2 ~ 10.6	2130	800 ~ 3040	4.41	A
2.0 + 2.0 + 3.5 + 3.5	11.0	1.71	1.71	2.99	2.99	9.40	4.2 ~ 10.6	2160	720 ~ 3090	4.35	A
2.0 + 2.0 + 3.5 + 4.2	11.7	1.61	1.61	2.81	3.37	9.40	4.2 ~ 10.6	2150	720 ~ 3080	4.37	A
2.0 + 2.0 + 3.5 + 5.0	12.5	1.50	1.50	2.63	3.77	9.40	4.2 ~ 10.6	2130	810 ~ 3030	4.41	A
2.0 + 2.0 + 3.5 + 6.0	13.5	1.39	1.39	2.44	4.18	9.40	4.2 ~ 10.6	2130	810 ~ 3030	4.41	A
2.0 + 2.0 + 3.5 + 7.1	14.6	1.29	1.29	2.25	4.57	9.40	4.2 ~ 10.6	2160	830 ~ 3020	4.35	A
2.0 + 2.0 + 4.2 + 4.2	12.4	1.52	1.52	3.18	3.18	9.40	4.2 ~ 10.6	2140	720 ~ 3070	4.39	A
2.0 + 2.0 + 4.2 + 5.0	13.2	1.42	1.42	2.99	3.57	9.40	4.2 ~ 10.6	2160	810 ~ 3020	4.35	A
2.0 + 2.0 + 4.2 + 6.0	14.2	1.32	1.32	2.78	3.98	9.40	4.2 ~ 10.6	2160	810 ~ 3020	4.35	A
2.0 + 2.0 + 5.0 + 5.0	14.0	1.34	1.34	3.36	3.36	9.40	4.2 ~ 10.6	2170	940 ~ 3050	4.33	A
2.0 + 2.5 + 2.5 + 2.5	9.5	1.99	2.47	2.47	2.47	9.40	4.2 ~ 10.6	2190	690 ~ 3150	4.29	A
2.0 + 2.5 + 2.5 + 3.5	10.5	1.79	2.24	2.24	3.13	9.40	4.2 ~ 10.6	2170	710 ~ 3120	4.33	A
2.0 + 2.5 + 2.5 + 4.2	11.2	1.68	2.10	2.10	3.52	9.40	4.2 ~ 10.6	2170	720 ~ 3110	4.33	A
2.0 + 2.5 + 2.5 + 5.0	12.0	1.57	1.96	1.96	3.91	9.40	4.2 ~ 10.6	2140	800 ~ 3050	4.39	A
2.0 + 2.5 + 2.5 + 6.0	13.0	1.45	1.81	1.81	4.33	9.40	4.2 ~ 10.6	2140	800 ~ 3050	4.39	A
2.0 + 2.5 + 2.5 + 7.1	14.1	1.33	1.67	1.67	4.73	9.40	4.2 ~ 10.6	2130	800 ~ 3040	4.41	A
2.0 + 2.5 + 3.5 + 3.5	11.5	1.63	2.05	2.86	2.86	9.40	4.2 ~ 10.6	2160	720 ~ 3090	4.35	A
2.0 + 2.5 + 3.5 + 4.2	12.2	1.54	1.93	2.70	3.23	9.40	4.2 ~ 10.6	2150	720 ~ 3080	4.37	A
2.0 + 2.5 + 3.5 + 5.0	13.0	1.45	1.81	2.53	3.61	9.40	4.2 ~ 10.6	2130	810 ~ 3030	4.41	A
2.0 + 2.5 + 3.5 + 6.0	14.0	1.34	1.68	2.35	4.03	9.40	4.2 ~ 10.6	2130	810 ~ 3030	4.41	A
2.0 + 2.5 + 4.2 + 4.2	12.9	1.46	1.82	3.06	3.06	9.40	4.2 ~ 10.6	2140	720 ~ 3070	4.39	A
2.0 + 2.5 + 4.2 + 5.0	13.7	1.37	1.72	2.88	3.43	9.40	4.2 ~ 10.6	2160	810 ~ 3020	4.35	A
2.0 + 2.5 + 4.2 + 6.0	14.7	1.28	1.60	2.69	3.83	9.40	4.2 ~ 10.6	2160	810 ~ 3020	4.35	A
2.0 + 2.5 + 5.0 + 5.0	14.5	1.30	1.62	3.24	3.24	9.40	4.2 ~ 10.6	2170	940 ~ 3050	4.33	A
2.0 + 3.5 + 3.5 + 3.5	12.5	1.51	2.63	2.63	2.63	9.40	4.2 ~ 10.6	2140	750 ~ 3060	4.39	A
2.0 + 3.5 + 3.5 + 4.2	13.2	1.42	2.49	2.49	3.00	9.40	4.2 ~ 10.6	2130	750 ~ 3050	4.41	A
2.0 + 3.5 + 3.5 + 5.0	14.0	1.34	2.35	2.35	3.36	9.40	4.2 ~ 10.6	2160	840 ~ 3010	4.35	A



Indoor unit capacity Heating	Annual Energy Consumption (kWh)	Current 230V (A)	ERP				Moisture Removal Volume l/h
			Pdesign (kW)	SCOP		Annual Consumption (kWh)	
				W/W	CLASS		
1.6 + 2.5 + 2.5 + 5.0	1075	10.1	6.80	4.40	A+	2164	
1.6 + 2.5 + 2.5 + 6.0	1075	10.1	6.80	4.40	A+	2164	
1.6 + 2.5 + 2.5 + 7.1	1070	10.1	6.80	4.40	A+	2164	
1.6 + 2.5 + 3.5 + 3.5	1080	10.2	6.80	4.40	A+	2164	
1.6 + 2.5 + 3.5 + 4.2	1080	10.2	6.80	4.40	A+	2164	
1.6 + 2.5 + 3.5 + 5.0	1065	10.0	6.80	4.40	A+	2164	
1.6 + 2.5 + 3.5 + 6.0	1065	10.0	6.80	4.40	A+	2164	
1.6 + 2.5 + 3.5 + 7.1	1065	10.0	6.80	4.40	A+	2164	
1.6 + 2.5 + 4.2 + 4.2	1075	10.1	6.80	4.40	A+	2164	
1.6 + 2.5 + 4.2 + 5.0	1065	10.0	6.80	4.40	A+	2164	
1.6 + 2.5 + 4.2 + 6.0	1065	10.0	6.80	4.40	A+	2164	
1.6 + 2.5 + 5.0 + 5.0	1085	10.2	6.80	4.40	A+	2164	
1.6 + 3.5 + 3.5 + 3.5	1070	10.1	6.80	4.40	A+	2164	
1.6 + 3.5 + 3.5 + 4.2	1070	10.1	6.80	4.40	A+	2164	
1.6 + 3.5 + 3.5 + 5.0	1080	10.2	6.80	4.40	A+	2164	
1.6 + 3.5 + 3.5 + 6.0	1080	10.2	6.80	4.40	A+	2164	
1.6 + 3.5 + 4.2 + 4.2	1065	10.0	6.80	4.40	A+	2164	
1.6 + 3.5 + 4.2 + 5.0	1080	10.2	6.80	4.40	A+	2164	
1.6 + 4.2 + 4.2 + 4.2	1065	10.0	6.80	4.40	A+	2164	
2.0 + 2.0 + 2.0 + 2.0	1095	10.3	6.80	4.40	A+	2164	
2.0 + 2.0 + 2.0 + 2.5	1095	10.3	6.80	4.40	A+	2164	
2.0 + 2.0 + 2.0 + 3.5	1085	10.2	6.80	4.40	A+	2164	
2.0 + 2.0 + 2.0 + 4.2	1085	10.2	6.80	4.40	A+	2164	
2.0 + 2.0 + 2.0 + 5.0	1070	10.1	6.80	4.40	A+	2164	
2.0 + 2.0 + 2.0 + 6.0	1070	10.1	6.80	4.40	A+	2164	
2.0 + 2.0 + 2.0 + 7.1	1065	10.0	6.80	4.40	A+	2164	
2.0 + 2.0 + 2.5 + 2.5	1095	10.3	6.80	4.40	A+	2164	
2.0 + 2.0 + 2.5 + 3.5	1085	10.2	6.80	4.40	A+	2164	
2.0 + 2.0 + 2.5 + 4.2	1085	10.2	6.80	4.40	A+	2164	
2.0 + 2.0 + 2.5 + 5.0	1070	10.1	6.80	4.40	A+	2164	
2.0 + 2.0 + 2.5 + 6.0	1070	10.1	6.80	4.40	A+	2164	
2.0 + 2.0 + 2.5 + 7.1	1065	10.0	6.80	4.40	A+	2164	
2.0 + 2.0 + 3.5 + 3.5	1080	10.2	6.80	4.40	A+	2164	
2.0 + 2.0 + 3.5 + 4.2	1075	10.1	6.80	4.40	A+	2164	
2.0 + 2.0 + 3.5 + 5.0	1065	10.0	6.80	4.40	A+	2164	
2.0 + 2.0 + 3.5 + 6.0	1065	10.0	6.80	4.40	A+	2164	
2.0 + 2.0 + 3.5 + 7.1	1080	10.2	6.80	4.40	A+	2164	
2.0 + 2.0 + 4.2 + 4.2	1070	10.1	6.80	4.40	A+	2164	
2.0 + 2.0 + 4.2 + 5.0	1080	10.2	6.80	4.40	A+	2164	
2.0 + 2.0 + 4.2 + 6.0	1080	10.2	6.80	4.40	A+	2164	
2.0 + 2.0 + 5.0 + 5.0	1085	10.2	6.80	4.40	A+	2164	
2.0 + 2.5 + 2.5 + 2.5	1095	10.3	6.80	4.40	A+	2164	
2.0 + 2.5 + 2.5 + 3.5	1085	10.2	6.80	4.40	A+	2164	
2.0 + 2.5 + 2.5 + 4.2	1085	10.2	6.80	4.40	A+	2164	
2.0 + 2.5 + 2.5 + 5.0	1070	10.1	6.80	4.40	A+	2164	
2.0 + 2.5 + 2.5 + 6.0	1070	10.1	6.80	4.40	A+	2164	
2.0 + 2.5 + 2.5 + 7.1	1065	10.0	6.80	4.40	A+	2164	
2.0 + 2.5 + 3.5 + 3.5	1080	10.2	6.80	4.40	A+	2164	
2.0 + 2.5 + 3.5 + 4.2	1075	10.1	6.80	4.40	A+	2164	
2.0 + 2.5 + 3.5 + 5.0	1065	10.0	6.80	4.40	A+	2164	
2.0 + 2.5 + 3.5 + 6.0	1065	10.0	6.80	4.40	A+	2164	
2.0 + 2.5 + 4.2 + 4.2	1070	10.1	6.80	4.40	A+	2164	
2.0 + 2.5 + 4.2 + 5.0	1080	10.2	6.80	4.40	A+	2164	
2.0 + 2.5 + 4.2 + 6.0	1080	10.2	6.80	4.40	A+	2164	
2.0 + 2.5 + 5.0 + 5.0	1085	10.2	6.80	4.40	A+	2164	
2.0 + 3.5 + 3.5 + 3.5	1070	10.1	6.80	4.40	A+	2164	
2.0 + 3.5 + 3.5 + 4.2	1065	10.0	6.80	4.40	A+	2164	
2.0 + 3.5 + 3.5 + 5.0	1080	10.2	6.80	4.40	A+	2164	

4 Room

Indoor unit capacity Heating		Total	Heating Capacity (kW)					Input Power (W)		COP		
			Room A	Room B	Room C	Room D	Total	min ~ max	Rating	min ~ max	W/W	CLASS
4 Room	2.0 + 3.5 + 4.2 + 4.2	13.9	1.35	2.37	2.84	2.84	9.40	4.2 ~ 10.6	2130	760 ~ 3040	4.41	A
	2.0 + 3.5 + 4.2 + 5.0	14.7	1.28	2.24	2.69	3.19	9.40	4.2 ~ 10.6	2150	850 ~ 3000	4.37	A
	2.0 + 4.2 + 4.2 + 4.2	14.6	1.30	2.70	2.70	2.70	9.40	4.2 ~ 10.6	2160	760 ~ 3030	4.35	A
	2.5 + 2.5 + 2.5 + 2.5	10.0	2.35	2.35	2.35	2.35	9.40	4.2 ~ 10.6	2190	690 ~ 3150	4.29	A
	2.5 + 2.5 + 2.5 + 3.5	11.0	2.14	2.14	2.14	2.98	9.40	4.2 ~ 10.6	2170	710 ~ 3120	4.33	A
	2.5 + 2.5 + 2.5 + 4.2	11.7	2.01	2.01	2.01	3.37	9.40	4.2 ~ 10.6	2170	720 ~ 3110	4.33	A
	2.5 + 2.5 + 2.5 + 5.0	12.5	1.88	1.88	1.88	3.76	9.40	4.2 ~ 10.6	2140	800 ~ 3050	4.39	A
	2.5 + 2.5 + 2.5 + 6.0	13.5	1.74	1.74	1.74	4.18	9.40	4.2 ~ 10.6	2140	800 ~ 3050	4.39	A
	2.5 + 2.5 + 2.5 + 7.1	14.6	1.61	1.61	1.61	4.57	9.40	4.2 ~ 10.6	2130	800 ~ 3040	4.41	A
	2.5 + 2.5 + 3.5 + 3.5	12.0	1.96	1.96	2.74	2.74	9.40	4.2 ~ 10.6	2160	720 ~ 3090	4.35	A
	2.5 + 2.5 + 3.5 + 4.2	12.7	1.85	1.85	2.59	3.11	9.40	4.2 ~ 10.6	2150	720 ~ 3080	4.37	A
	2.5 + 2.5 + 3.5 + 5.0	13.5	1.74	1.74	2.44	3.48	9.40	4.2 ~ 10.6	2130	810 ~ 3030	4.41	A
	2.5 + 2.5 + 3.5 + 6.0	14.5	1.62	1.62	2.27	3.89	9.40	4.2 ~ 10.6	2130	810 ~ 3030	4.41	A
	2.5 + 2.5 + 4.2 + 4.2	13.4	1.75	1.75	2.95	2.95	9.40	4.2 ~ 10.6	2140	720 ~ 3070	4.39	A
	2.5 + 2.5 + 4.2 + 5.0	14.2	1.65	1.65	2.78	3.32	9.40	4.2 ~ 10.6	2160	810 ~ 3020	4.35	A
	2.5 + 3.5 + 3.5 + 3.5	13.0	1.81	2.53	2.53	2.53	9.40	4.2 ~ 10.6	2140	750 ~ 3060	4.39	A
	2.5 + 3.5 + 3.5 + 4.2	13.7	1.72	2.40	2.40	2.88	9.40	4.2 ~ 10.6	2130	750 ~ 3050	4.41	A
	2.5 + 3.5 + 3.5 + 5.0	14.5	1.62	2.27	2.27	3.24	9.40	4.2 ~ 10.6	2160	840 ~ 3010	4.35	A
	2.5 + 3.5 + 4.2 + 4.2	14.4	1.63	2.29	2.74	2.74	9.40	4.2 ~ 10.6	2130	760 ~ 3040	4.41	A
	3.5 + 3.5 + 3.5 + 3.5	14.0	2.35	2.35	2.35	2.35	9.40	4.2 ~ 10.6	2160	760 ~ 3030	4.35	A
3.5 + 3.5 + 3.5 + 4.2	14.7	2.24	2.24	2.24	2.68	9.40	4.2 ~ 10.6	2160	760 ~ 3020	4.35	A	

Indoor unit capacity Heating	Annual Energy Consumption (kWh)	Current 230V (A)	ERP				Moisture Removal Volume l/h
			Pdesign (kW)	SCOP		Annual Consumption (kWh)	
				W/W	CLASS		
4 Room	2.0 + 3.5 + 4.2 + 4.2	1065	10.0	6.80	4.40	A+	2164
	2.0 + 3.5 + 4.2 + 5.0	1075	10.1	6.80	4.40	A+	2164
	2.0 + 4.2 + 4.2 + 4.2	1080	10.2	6.80	4.40	A+	2164
	2.5 + 2.5 + 2.5 + 2.5	1095	10.3	6.80	4.40	A+	2164
	2.5 + 2.5 + 2.5 + 3.5	1085	10.2	6.80	4.40	A+	2164
	2.5 + 2.5 + 2.5 + 4.2	1085	10.2	6.80	4.40	A+	2164
	2.5 + 2.5 + 2.5 + 5.0	1070	10.1	6.80	4.40	A+	2164
	2.5 + 2.5 + 2.5 + 6.0	1070	10.1	6.80	4.40	A+	2164
	2.5 + 2.5 + 2.5 + 7.1	1065	10.0	6.80	4.40	A+	2164
	2.5 + 2.5 + 3.5 + 3.5	1080	10.2	6.80	4.40	A+	2164
	2.5 + 2.5 + 3.5 + 4.2	1075	10.1	6.80	4.40	A+	2164
	2.5 + 2.5 + 3.5 + 5.0	1065	10.0	6.80	4.40	A+	2164
	2.5 + 2.5 + 3.5 + 6.0	1065	10.0	6.80	4.40	A+	2164
	2.5 + 2.5 + 4.2 + 4.2	1070	10.1	6.80	4.40	A+	2164
	2.5 + 2.5 + 4.2 + 5.0	1080	10.2	6.80	4.40	A+	2164
	2.5 + 3.5 + 3.5 + 3.5	1070	10.1	6.80	4.40	A+	2164
	2.5 + 3.5 + 3.5 + 4.2	1065	10.0	6.80	4.40	A+	2164
	2.5 + 3.5 + 3.5 + 5.0	1080	10.2	6.80	4.40	A+	2164
	2.5 + 3.5 + 4.2 + 4.2	1065	10.0	6.80	4.40	A+	2164
	3.5 + 3.5 + 3.5 + 3.5	1080	10.2	6.80	4.40	A+	2164
3.5 + 3.5 + 3.5 + 4.2	1080	10.2	6.80	4.40	A+	2164	

- Indoor Unit : Combination of all type of wall and non-wall series (CS-MZ / Z / XZ / MTZ / TZ / TE / E)
- Outdoor Unit : CU-4Z80TBE

Indoor unit capacity Cooling	Total	Cooling Capacity (kW)						Input Power (W)		EER		
		Room A	Room B	Room C	Room D	Total	min ~ max	Rating	min ~ max	W/W	CLASS	
1 Room	1.6	1.6	1.60				1.60	1.3 0.0 2.3	450	250 ~ 690	3.56	A
	2.0	2.0	2.00				2.00	1.8 ~ 2.9	550	340 ~ 860	3.64	A
	2.5	2.5	2.50				2.50	1.8 ~ 2.9	680	340 ~ 860	3.68	A
	3.5	3.5	3.50				3.50	1.8 ~ 4.1	990	340 ~ 1410	3.54	A
	4.2	4.2	4.20				4.20	1.8 ~ 4.5	1420	340 ~ 2040	2.96	C
	5.0	5.0	5.00				5.00	1.9 ~ 5.7	1600	340 ~ 2180	3.13	B
	6.0	6.0	6.00				6.00	1.9 ~ 6.2	2080	340 ~ 2380	2.88	C
	7.1	7.1	7.10				7.10	2.0 ~ 7.2	2580	370 ~ 2820	2.75	D
2 Room	1.6 + 1.6	3.2	1.60	1.60			3.20	2.4 ~ 5.8	830	380 ~ 2090	3.86	A
	1.6 + 2.0	3.6	1.60	2.00			3.60	2.4 ~ 5.8	970	380 ~ 2090	3.71	A
	1.6 + 2.5	4.1	1.60	2.50			4.10	2.4 ~ 5.8	1170	380 ~ 2090	3.50	A
	1.6 + 3.5	5.1	1.60	3.50			5.10	2.4 ~ 5.8	1580	370 ~ 2020	3.23	A
	1.6 + 4.2	5.8	1.60	4.20			5.80	2.4 ~ 6.7	1920	370 ~ 2580	3.02	B
	1.6 + 5.0	6.6	1.60	5.00			6.60	2.4 ~ 7.2	2160	350 ~ 2580	3.06	B
	1.6 + 6.0	7.6	1.60	6.00			7.60	2.4 ~ 8.5	2790	350 ~ 3590	2.72	D
	1.6 + 7.1	8.7	1.47	6.53			8.00	2.5 ~ 8.5	2940	380 ~ 3440	2.72	D
	2.0 + 2.0	4.0	2.00	2.00			4.00	2.4 ~ 5.8	1110	380 ~ 2030	3.60	A
	2.0 + 2.5	4.5	2.00	2.50			4.50	2.4 ~ 5.8	1340	380 ~ 2030	3.36	A
	2.0 + 3.5	5.5	2.00	3.50			5.50	2.4 ~ 5.8	1750	370 ~ 1960	3.14	B
	2.0 + 4.2	6.2	2.00	4.20			6.20	2.4 ~ 7.2	2170	370 ~ 3000	2.86	C
	2.0 + 5.0	7.0	2.00	5.00			7.00	2.4 ~ 8.1	2310	350 ~ 3200	3.03	B
	2.0 + 6.0	8.0	2.00	6.00			8.00	2.4 ~ 8.5	3010	350 ~ 3590	2.66	D
	2.0 + 7.1	9.1	1.76	6.24			8.00	2.5 ~ 8.5	2870	380 ~ 3440	2.79	D
	2.5 + 2.5	5.0	2.50	2.50			5.00	2.4 ~ 5.8	1530	380 ~ 2030	3.27	A
	2.5 + 3.5	6.0	2.50	3.50			6.00	2.4 ~ 6.7	2040	370 ~ 2580	2.94	C
	2.5 + 4.2	6.7	2.50	4.20			6.70	2.4 ~ 7.2	2510	370 ~ 3000	2.67	D
	2.5 + 5.0	7.5	2.50	5.00			7.50	2.4 ~ 8.5	2650	350 ~ 3590	2.83	C
	2.5 + 6.0	8.5	2.35	5.65			8.00	2.5 ~ 8.5	3010	390 ~ 3590	2.66	D
	2.5 + 7.1	9.6	2.08	5.92			8.00	2.5 ~ 8.5	2870	380 ~ 3440	2.79	D
	3.5 + 3.5	7.0	3.50	3.50			7.00	2.4 ~ 8.1	2650	370 ~ 3730	2.64	D
	3.5 + 4.2	7.7	3.50	4.20			7.70	2.4 ~ 8.5	3140	370 ~ 4220	2.45	E
	3.5 + 5.0	8.5	3.29	4.71			8.00	2.5 ~ 8.5	2870	380 ~ 3440	2.79	D
	3.5 + 6.0	9.5	2.95	5.05			8.00	2.5 ~ 8.5	2870	380 ~ 3440	2.79	D
	3.5 + 7.1	10.6	2.64	5.36			8.00	2.5 ~ 8.6	2800	380 ~ 3440	2.86	C
	4.2 + 4.2	8.4	4.00	4.00			8.00	2.5 ~ 8.5	3440	400 ~ 4140	2.33	F
4.2 + 5.0	9.2	3.65	4.35			8.00	2.5 ~ 8.5	2870	380 ~ 3440	2.79	D	
4.2 + 6.0	10.2	3.29	4.71			8.00	2.5 ~ 8.6	2870	380 ~ 3520	2.79	D	
4.2 + 7.1	11.3	2.97	5.03			8.00	2.5 ~ 8.6	2800	380 ~ 3360	2.86	C	
5.0 + 5.0	10.0	4.00	4.00			8.00	2.5 ~ 8.6	2520	380 ~ 3050	3.17	B	
5.0 + 6.0	11.0	3.64	4.36			8.00	2.5 ~ 8.6	2520	380 ~ 3050	3.17	B	
5.0 + 7.1	12.1	3.31	4.69			8.00	2.5 ~ 8.6	2450	380 ~ 2980	3.27	A	
6.0 + 6.0	12.0	4.00	4.00			8.00	2.5 ~ 8.6	2520	380 ~ 3050	3.17	B	
6.0 + 7.1	13.1	3.66	4.34			8.00	2.5 ~ 8.6	2450	380 ~ 2980	3.27	A	
7.1 + 7.1	14.2	4.00	4.00			8.00	2.5 ~ 8.6	2380	410 ~ 2900	3.36	A	

	Indoor unit capacity Cooling	Annual Energy Consumption (kWh)	Current 230V (A)	ERP				Moisture Removal Volume l/h
				Pdesign (kW)	SEER		Annual Consumption (kWh)	
					WW	CLASS		
1 Room	1.6	225	2.3	-	-	-	-	1.0
	2.0	275	2.7	-	-	-	-	1.3
	2.5	340	3.4	-	-	-	-	1.5
	3.5	495	4.8	-	-	-	-	2.0
	4.2	710	6.6	-	-	-	-	2.4
	5.0	800	7.5	-	-	-	-	2.7
	6.0	1040	9.4	-	-	-	-	3.3
	7.1	1290	11.7	-	-	-	-	4.1
2 Room	1.6 + 1.6	415	4.1	3.20	5.10	A	220	1.0 + 1.0
	1.6 + 2.0	485	4.8	3.60	5.10	A	247	1.0 + 1.3
	1.6 + 2.5	585	5.7	4.10	5.10	A	281	1.0 + 1.5
	1.6 + 3.5	790	7.6	5.10	5.10	A	350	1.0 + 2.0
	1.6 + 4.2	960	9.2	5.80	5.10	A	398	1.0 + 2.4
	1.6 + 5.0	1080	10.3	6.60	5.10	A	453	1.0 + 2.7
	1.6 + 6.0	1395	13.4	7.60	5.10	A	522	1.0 + 3.3
	1.6 + 7.1	1470	14.1	8.00	5.10	A	549	0.9 + 3.7
	2.0 + 2.0	555	5.4	4.00	5.10	A	275	1.3 + 1.3
	2.0 + 2.5	670	6.5	4.50	5.10	A	309	1.3 + 1.5
	2.0 + 3.5	875	8.4	5.50	5.10	A	377	1.3 + 2.0
	2.0 + 4.2	1085	10.4	6.20	5.10	A	425	1.3 + 2.4
	2.0 + 5.0	1155	11.1	7.00	5.10	A	480	1.3 + 2.7
	2.0 + 6.0	1505	14.4	8.00	5.10	A	549	1.3 + 3.3
	2.0 + 7.1	1435	13.7	8.00	5.10	A	549	1.1 + 3.5
	2.5 + 2.5	765	7.4	5.00	5.10	A	343	1.5 + 1.5
	2.5 + 3.5	1020	9.8	6.00	5.10	A	412	1.5 + 2.0
	2.5 + 4.2	1255	12.0	6.70	5.10	A	460	1.5 + 2.4
	2.5 + 5.0	1325	12.7	7.50	5.10	A	515	1.5 + 2.7
	2.5 + 6.0	1505	14.4	8.00	5.10	A	549	1.5 + 3.1
	2.5 + 7.1	1435	13.7	8.00	5.10	A	549	1.3 + 3.3
	3.5 + 3.5	1325	12.7	7.00	5.10	A	480	2.0 + 2.0
	3.5 + 4.2	1570	15.0	7.70	5.10	A	528	2.0 + 2.4
	3.5 + 5.0	1435	13.7	8.00	5.10	A	549	1.9 + 2.5
	3.5 + 6.0	1435	13.7	8.00	5.10	A	549	1.7 + 2.8
	3.5 + 7.1	1400	13.4	8.00	5.10	A	549	1.6 + 2.9
	4.2 + 4.2	1720	16.5	8.00	5.10	A	549	2.3 + 2.3
	4.2 + 5.0	1435	13.7	8.00	5.10	A	549	2.1 + 2.4
	4.2 + 6.0	1435	13.7	8.00	5.10	A	549	1.9 + 2.5
	4.2 + 7.1	1400	13.4	8.00	5.10	A	549	1.7 + 2.8
5.0 + 5.0	1260	12.1	8.00	5.10	A	549	2.3 + 2.3	
5.0 + 6.0	1260	12.1	8.00	5.10	A	549	2.1 + 2.4	
5.0 + 7.1	1225	11.7	8.00	5.10	A	549	1.9 + 2.5	
6.0 + 6.0	1260	12.1	8.00	5.10	A	549	2.3 + 2.3	
6.0 + 7.1	1225	11.7	8.00	5.10	A	549	2.1 + 2.4	
7.1 + 7.1	1190	11.4	8.00	5.10	A	549	2.3 + 2.3	

Indoor unit capacity Cooling	Total	Cooling Capacity (kW)						Input Power (W)		EER	
		Room A	Room B	Room C	Room D	Total	min ~ max	Rating	min ~ max	W/W	CLASS
1.6 + 1.6 + 1.6	4.8	1.60	1.60	1.60		4.80	3.0 ~ 8.5	1230	490 ~ 3260	3.90	A
1.6 + 1.6 + 2.0	5.2	1.60	1.60	2.00		5.20	3.0 ~ 8.5	1330	490 ~ 3260	3.91	A
1.6 + 1.6 + 2.5	5.7	1.60	1.60	2.50		5.70	3.0 ~ 8.5	1540	490 ~ 3260	3.70	A
1.6 + 1.6 + 3.5	6.7	1.60	1.60	3.50		6.70	3.0 ~ 8.5	1860	480 ~ 3180	3.60	A
1.6 + 1.6 + 4.2	7.4	1.60	1.60	4.20		7.40	3.0 ~ 8.5	2220	480 ~ 3100	3.33	A
1.6 + 1.6 + 5.0	8.2	1.56	1.56	4.88		8.00	3.0 ~ 8.6	2250	520 ~ 2880	3.56	A
1.6 + 1.6 + 6.0	9.2	1.39	1.39	5.22		8.00	3.0 ~ 8.6	2250	520 ~ 2880	3.56	A
1.6 + 1.6 + 7.1	10.3	1.24	1.24	5.52		8.00	3.0 ~ 8.8	2190	520 ~ 2950	3.65	A
1.6 + 2.0 + 2.0	5.6	1.60	2.00	2.00		5.60	3.0 ~ 8.5	1490	490 ~ 3180	3.76	A
1.6 + 2.0 + 2.5	6.1	1.60	2.00	2.50		6.10	3.0 ~ 8.5	1700	490 ~ 3180	3.59	A
1.6 + 2.0 + 3.5	7.1	1.60	2.00	3.50		7.10	3.0 ~ 8.5	2030	480 ~ 3100	3.50	A
1.6 + 2.0 + 4.2	7.8	1.60	2.00	4.20		7.80	3.0 ~ 8.5	2320	480 ~ 3100	3.36	A
1.6 + 2.0 + 5.0	8.6	1.49	1.86	4.65		8.00	3.0 ~ 8.6	2250	520 ~ 2880	3.56	A
1.6 + 2.0 + 6.0	9.6	1.33	1.67	5.00		8.00	3.0 ~ 8.6	2250	520 ~ 2880	3.56	A
1.6 + 2.0 + 7.1	10.7	1.20	1.50	5.30		8.00	3.0 ~ 8.8	2190	520 ~ 2950	3.65	A
1.6 + 2.5 + 2.5	6.6	1.60	2.50	2.50		6.60	3.0 ~ 8.5	1940	490 ~ 3180	3.40	A
1.6 + 2.5 + 3.5	7.6	1.60	2.50	3.50		7.60	3.0 ~ 8.5	2340	480 ~ 3100	3.25	A
1.6 + 2.5 + 4.2	8.3	1.54	2.41	4.05		8.00	3.0 ~ 8.6	2440	480 ~ 3180	3.28	A
1.6 + 2.5 + 5.0	9.1	1.41	2.20	4.39		8.00	3.0 ~ 8.6	2250	520 ~ 2880	3.56	A
1.6 + 2.5 + 6.0	10.1	1.27	1.98	4.75		8.00	3.0 ~ 8.8	2250	520 ~ 2950	3.56	A
1.6 + 2.5 + 7.1	11.2	1.14	1.79	5.07		8.00	3.0 ~ 8.8	2190	520 ~ 2950	3.65	A
1.6 + 3.5 + 3.5	8.6	1.48	3.26	3.26		8.00	3.0 ~ 8.6	2380	480 ~ 3100	3.36	A
1.6 + 3.5 + 4.2	9.3	1.38	3.01	3.61		8.00	3.0 ~ 8.6	2380	480 ~ 3100	3.36	A
1.6 + 3.5 + 5.0	10.1	1.27	2.77	3.96		8.00	3.0 ~ 8.8	2190	520 ~ 2950	3.65	A
1.6 + 3.5 + 6.0	11.1	1.15	2.52	4.33		8.00	3.0 ~ 8.8	2190	520 ~ 2950	3.65	A
1.6 + 3.5 + 7.1	12.2	1.05	2.30	4.65		8.00	3.0 ~ 9.0	2190	520 ~ 3020	3.65	A
1.6 + 4.2 + 4.2	10.0	1.28	3.36	3.36		8.00	3.0 ~ 8.8	2380	480 ~ 3250	3.36	A
1.6 + 4.2 + 5.0	10.8	1.19	3.11	3.70		8.00	3.0 ~ 8.8	2190	520 ~ 2950	3.65	A
1.6 + 4.2 + 6.0	11.8	1.08	2.85	4.07		8.00	3.0 ~ 9.0	2190	520 ~ 3020	3.65	A
1.6 + 4.2 + 7.1	12.9	0.99	2.60	4.41		8.00	3.0 ~ 9.0	2130	520 ~ 2950	3.76	A
1.6 + 5.0 + 5.0	11.6	1.10	3.45	3.45		8.00	3.0 ~ 8.8	2070	570 ~ 2730	3.86	A
1.6 + 5.0 + 6.0	12.6	1.02	3.17	3.81		8.00	3.0 ~ 9.0	2070	570 ~ 2800	3.86	A
1.6 + 5.0 + 7.1	13.7	0.93	2.92	4.15		8.00	3.0 ~ 9.0	2070	570 ~ 2800	3.86	A
1.6 + 6.0 + 6.0	13.6	0.94	3.53	3.53		8.00	3.0 ~ 9.0	2070	570 ~ 2800	3.86	A
1.6 + 6.0 + 7.1	14.7	0.87	3.27	3.86		8.00	3.0 ~ 9.0	2070	570 ~ 2800	3.86	A
2.0 + 2.0 + 2.0	6.0	2.00	2.00	2.00		6.00	3.0 ~ 8.5	1650	480 ~ 3180	3.64	A
2.0 + 2.0 + 2.5	6.5	2.00	2.00	2.50		6.50	3.0 ~ 8.5	1880	480 ~ 3180	3.46	A
2.0 + 2.0 + 3.5	7.5	2.00	2.00	3.50		7.50	3.0 ~ 8.5	2210	480 ~ 3100	3.39	A
2.0 + 2.0 + 4.2	8.2	1.95	1.95	4.10		8.00	3.0 ~ 8.6	2440	480 ~ 3180	3.28	A
2.0 + 2.0 + 5.0	9.0	1.78	1.78	4.44		8.00	3.0 ~ 8.6	2190	520 ~ 2800	3.65	A
2.0 + 2.0 + 6.0	10.0	1.60	1.60	4.80		8.00	3.0 ~ 8.8	2190	520 ~ 2950	3.65	A
2.0 + 2.0 + 7.1	11.1	1.44	1.44	5.12		8.00	3.0 ~ 8.8	2190	520 ~ 2870	3.65	A
2.0 + 2.5 + 2.5	7.0	2.00	2.50	2.50		7.00	3.0 ~ 8.5	2040	480 ~ 3180	3.43	A
2.0 + 2.5 + 3.5	8.0	2.00	2.50	3.50		8.00	3.0 ~ 8.6	2440	480 ~ 3180	3.28	A
2.0 + 2.5 + 4.2	8.7	1.84	2.30	3.86		8.00	3.0 ~ 8.6	2440	480 ~ 3180	3.28	A
2.0 + 2.5 + 5.0	9.5	1.68	2.11	4.21		8.00	3.0 ~ 8.6	2190	520 ~ 2800	3.65	A
2.0 + 2.5 + 6.0	10.5	1.52	1.90	4.58		8.00	3.0 ~ 8.8	2190	520 ~ 2950	3.65	A
2.0 + 2.5 + 7.1	11.6	1.38	1.72	4.90		8.00	3.0 ~ 8.8	2190	520 ~ 2870	3.65	A
2.0 + 3.5 + 3.5	9.0	1.78	3.11	3.11		8.00	3.0 ~ 8.6	2380	480 ~ 3100	3.36	A
2.0 + 3.5 + 4.2	9.7	1.65	2.89	3.46		8.00	3.0 ~ 8.6	2380	480 ~ 3100	3.36	A
2.0 + 3.5 + 5.0	10.5	1.52	2.67	3.81		8.00	3.0 ~ 8.8	2190	520 ~ 2950	3.65	A
2.0 + 3.5 + 6.0	11.5	1.39	2.43	4.18		8.00	3.0 ~ 8.8	2190	520 ~ 2950	3.65	A
2.0 + 3.5 + 7.1	12.6	1.27	2.22	4.51		8.00	3.0 ~ 9.0	2130	520 ~ 2950	3.76	A
2.0 + 4.2 + 4.2	10.4	1.54	3.23	3.23		8.00	3.0 ~ 8.8	2380	480 ~ 3180	3.36	A
2.0 + 4.2 + 5.0	11.2	1.43	3.00	3.57		8.00	3.0 ~ 8.8	2190	520 ~ 2870	3.65	A
2.0 + 4.2 + 6.0	12.2	1.31	2.75	3.94		8.00	3.0 ~ 9.0	2190	520 ~ 3020	3.65	A
2.0 + 4.2 + 7.1	13.3	1.20	2.53	4.27		8.00	3.0 ~ 9.0	2130	520 ~ 2950	3.76	A
2.0 + 5.0 + 5.0	12.0	1.33	3.33	3.33		7.99	3.0 ~ 9.0	2070	570 ~ 2800	3.86	A

3  
Room

Indoor unit capacity Cooling	Annual Energy Consumption (kWh)	Current 230V (A)	ERP				Moisture Removal Volume l/h
			Pdesign (kW)	SEER		Annual Consumption (kWh)	
				W/W	CLASS		
1.6 + 1.6 + 1.6	615	5.9	4.80	5.60	A+	300	1.0 + 1.0 + 1.0
1.6 + 1.6 + 2.0	665	6.4	5.20	5.60	A+	325	1.0 + 1.0 + 1.3
1.6 + 1.6 + 2.5	770	7.4	5.70	5.60	A+	356	1.0 + 1.0 + 1.5
1.6 + 1.6 + 3.5	930	8.9	6.70	5.60	A+	419	1.0 + 1.0 + 2.0
1.6 + 1.6 + 4.2	1110	10.6	7.40	5.60	A+	463	1.0 + 1.0 + 2.4
1.6 + 1.6 + 5.0	1125	10.8	8.00	5.60	A+	500	1.0 + 1.0 + 2.7
1.6 + 1.6 + 6.0	1125	10.8	8.00	5.60	A+	500	0.9 + 0.9 + 2.9
1.6 + 1.6 + 7.1	1095	10.5	8.00	5.60	A+	500	0.8 + 0.8 + 3.0
1.6 + 2.0 + 2.0	745	7.2	5.60	5.60	A+	350	1.0 + 1.3 + 1.3
1.6 + 2.0 + 2.5	850	8.2	6.10	5.60	A+	381	1.0 + 1.3 + 1.5
1.6 + 2.0 + 3.5	1015	9.7	7.10	5.60	A+	444	1.0 + 1.3 + 2.0
1.6 + 2.0 + 4.2	1160	11.1	7.80	5.60	A+	488	1.0 + 1.3 + 2.4
1.6 + 2.0 + 5.0	1125	10.8	8.00	5.60	A+	500	0.9 + 1.2 + 2.5
1.6 + 2.0 + 6.0	1125	10.8	8.00	5.60	A+	500	0.8 + 1.1 + 2.7
1.6 + 2.0 + 7.1	1095	10.5	8.00	5.60	A+	500	0.7 + 1.0 + 2.9
1.6 + 2.5 + 2.5	970	9.3	6.60	5.60	A+	413	1.0 + 1.5 + 1.5
1.6 + 2.5 + 3.5	1170	11.2	7.60	5.60	A+	475	1.0 + 1.5 + 2.0
1.6 + 2.5 + 4.2	1220	11.7	8.00	5.60	A+	500	1.0 + 1.5 + 2.3
1.6 + 2.5 + 5.0	1125	10.8	8.00	5.60	A+	500	0.9 + 1.4 + 2.4
1.6 + 2.5 + 6.0	1125	10.8	8.00	5.60	A+	500	0.8 + 1.3 + 2.6
1.6 + 2.5 + 7.1	1095	10.5	8.00	5.60	A+	500	0.7 + 1.2 + 2.8
1.6 + 3.5 + 3.5	1190	11.4	8.00	5.60	A+	500	0.9 + 1.9 + 1.9
1.6 + 3.5 + 4.2	1190	11.4	8.00	5.60	A+	500	0.9 + 1.7 + 2.1
1.6 + 3.5 + 5.0	1095	10.5	8.00	5.60	A+	500	0.8 + 1.6 + 2.3
1.6 + 3.5 + 6.0	1095	10.5	8.00	5.60	A+	500	0.7 + 1.5 + 2.4
1.6 + 3.5 + 7.1	1095	10.5	8.00	5.60	A+	500	0.7 + 1.5 + 2.5
1.6 + 4.2 + 4.2	1190	11.4	8.00	5.60	A+	500	0.8 + 1.9 + 1.9
1.6 + 4.2 + 5.0	1095	10.5	8.00	5.60	A+	500	0.7 + 1.8 + 2.2
1.6 + 4.2 + 6.0	1095	10.5	8.00	5.60	A+	500	0.7 + 1.7 + 2.3
1.6 + 4.2 + 7.1	1065	10.2	8.00	5.60	A+	500	0.7 + 1.6 + 2.4
1.6 + 5.0 + 5.0	1035	9.9	8.00	5.60	A+	500	0.7 + 2.0 + 2.0
1.6 + 5.0 + 6.0	1035	9.9	8.00	5.60	A+	500	0.7 + 1.8 + 2.2
1.6 + 5.0 + 7.1	1035	9.9	8.00	5.60	A+	500	0.7 + 1.7 + 2.4
1.6 + 6.0 + 6.0	1035	9.9	8.00	5.60	A+	500	0.7 + 2.0 + 2.0
1.6 + 6.0 + 7.1	1035	9.9	8.00	5.60	A+	500	0.7 + 1.9 + 2.3
2.0 + 2.0 + 2.0	825	8.0	6.00	5.60	A+	375	1.3 + 1.3 + 1.3
2.0 + 2.0 + 2.5	940	9.0	6.50	5.60	A+	406	1.3 + 1.3 + 1.5
2.0 + 2.0 + 3.5	1105	10.6	7.50	5.60	A+	469	1.3 + 1.3 + 2.0
2.0 + 2.0 + 4.2	1220	11.7	8.00	5.60	A+	500	1.3 + 1.3 + 2.3
2.0 + 2.0 + 5.0	1095	10.5	8.00	5.60	A+	500	1.1 + 1.1 + 2.5
2.0 + 2.0 + 6.0	1095	10.5	8.00	5.60	A+	500	1.0 + 1.0 + 2.6
2.0 + 2.0 + 7.1	1095	10.5	8.00	5.60	A+	500	0.9 + 0.9 + 2.8
2.0 + 2.5 + 2.5	1020	9.8	7.00	5.60	A+	438	1.3 + 1.5 + 1.5
2.0 + 2.5 + 3.5	1220	11.7	8.00	5.60	A+	500	1.3 + 1.5 + 2.0
2.0 + 2.5 + 4.2	1220	11.7	8.00	5.60	A+	500	1.2 + 1.5 + 2.3
2.0 + 2.5 + 5.0	1095	10.5	8.00	5.60	A+	500	1.1 + 1.4 + 2.4
2.0 + 2.5 + 6.0	1095	10.5	8.00	5.60	A+	500	1.0 + 1.2 + 2.5
2.0 + 2.5 + 7.1	1095	10.5	8.00	5.60	A+	500	0.9 + 1.1 + 2.7
2.0 + 3.5 + 3.5	1190	11.4	8.00	5.60	A+	500	1.1 + 1.8 + 1.8
2.0 + 3.5 + 4.2	1190	11.4	8.00	5.60	A+	500	1.1 + 1.7 + 2.0
2.0 + 3.5 + 5.0	1095	10.5	8.00	5.60	A+	500	1.0 + 1.6 + 2.2
2.0 + 3.5 + 6.0	1095	10.5	8.00	5.60	A+	500	0.9 + 1.5 + 2.4
2.0 + 3.5 + 7.1	1065	10.2	8.00	5.60	A+	500	0.8 + 1.4 + 2.5
2.0 + 4.2 + 4.2	1190	11.4	8.00	5.60	A+	500	1.0 + 1.8 + 1.8
2.0 + 4.2 + 5.0	1095	10.5	8.00	5.60	A+	500	0.9 + 1.7 + 2.1
2.0 + 4.2 + 6.0	1095	10.5	8.00	5.60	A+	500	0.8 + 1.6 + 2.3
2.0 + 4.2 + 7.1	1065	10.2	8.00	5.60	A+	500	0.7 + 1.6 + 2.4
2.0 + 5.0 + 5.0	1035	9.9	7.99	5.60	A+	499	0.8 + 1.9 + 1.9

3  
Room

Indoor unit capacity Cooling	Total	Cooling Capacity (kW)						Input Power (W)		EER	
		Room A	Room B	Room C	Room D	Total	min ~ max	Rating	min ~ max	W/W	CLASS
2.0 + 5.0 + 6.0	13.0	1.23	3.08	3.69		8.00	3.0 ~ 9.0	2070	570 ~ 2800	3.86	A
2.0 + 5.0 + 7.1	14.1	1.13	2.84	4.03		8.00	3.0 ~ 9.0	2070	570 ~ 2800	3.86	A
2.0 + 6.0 + 6.0	14.0	1.14	3.43	3.43		8.00	3.0 ~ 9.0	2070	570 ~ 2800	3.86	A
2.5 + 2.5 + 2.5	7.5	2.50	2.50	2.50		7.50	3.0 ~ 8.5	2280	480 ~ 3180	3.29	A
2.5 + 2.5 + 3.5	8.5	2.35	2.35	3.30		8.00	3.0 ~ 8.6	2440	480 ~ 3180	3.28	A
2.5 + 2.5 + 4.2	9.2	2.17	2.17	3.66		8.00	3.0 ~ 8.6	2440	480 ~ 3180	3.28	A
2.5 + 2.5 + 5.0	10.0	2.00	2.00	4.00		8.00	3.0 ~ 8.8	2190	520 ~ 2950	3.65	A
2.5 + 2.5 + 6.0	11.0	1.82	1.82	4.36		8.00	3.0 ~ 8.8	2190	520 ~ 2950	3.65	A
2.5 + 2.5 + 7.1	12.1	1.65	1.65	4.70		8.00	3.0 ~ 9.0	2190	520 ~ 3020	3.65	A
2.5 + 3.5 + 3.5	9.5	2.10	2.95	2.95		8.00	3.0 ~ 8.6	2380	480 ~ 3100	3.36	A
2.5 + 3.5 + 4.2	10.2	1.96	2.75	3.29		8.00	3.0 ~ 8.8	2380	480 ~ 3250	3.36	A
2.5 + 3.5 + 5.0	11.0	1.82	2.55	3.63		8.00	3.0 ~ 8.8	2190	520 ~ 2950	3.65	A
2.5 + 3.5 + 6.0	12.0	1.67	2.33	4.00		8.00	3.0 ~ 9.0	2190	520 ~ 3020	3.65	A
2.5 + 3.5 + 7.1	13.1	1.53	2.14	4.33		8.00	3.0 ~ 9.0	2130	520 ~ 2950	3.76	A
2.5 + 4.2 + 4.2	10.9	1.84	3.08	3.08		8.00	3.0 ~ 8.8	2380	480 ~ 3180	3.36	A
2.5 + 4.2 + 5.0	11.7	1.71	2.87	3.42		8.00	3.0 ~ 8.8	2190	520 ~ 2870	3.65	A
2.5 + 4.2 + 6.0	12.7	1.57	2.65	3.78		8.00	3.0 ~ 9.0	2190	520 ~ 3020	3.65	A
2.5 + 4.2 + 7.1	13.8	1.45	2.43	4.12		8.00	3.0 ~ 9.0	2130	520 ~ 2950	3.76	A
2.5 + 5.0 + 5.0	12.5	1.60	3.20	3.20		8.00	3.0 ~ 9.0	2070	570 ~ 2800	3.86	A
2.5 + 5.0 + 6.0	13.5	1.48	2.96	3.56		8.00	3.0 ~ 9.0	2070	570 ~ 2800	3.86	A
2.5 + 5.0 + 7.1	14.6	1.37	2.74	3.89		8.00	3.0 ~ 9.0	2070	570 ~ 2800	3.86	A
2.5 + 6.0 + 6.0	14.5	1.38	3.31	3.31		8.00	3.0 ~ 9.0	2070	570 ~ 2800	3.86	A
3.5 + 3.5 + 3.5	10.5	2.66	2.66	2.66		7.98	3.0 ~ 8.8	2320	480 ~ 3180	3.44	A
3.5 + 3.5 + 4.2	11.2	2.50	2.50	3.00		8.00	3.0 ~ 8.8	2320	480 ~ 3180	3.45	A
3.5 + 3.5 + 5.0	12.0	2.33	2.33	3.33		7.99	3.0 ~ 9.0	2130	520 ~ 3020	3.75	A
3.5 + 3.5 + 6.0	13.0	2.15	2.15	3.70		8.00	3.0 ~ 9.0	2130	520 ~ 3020	3.76	A
3.5 + 3.5 + 7.1	14.1	1.99	1.99	4.02		8.00	3.0 ~ 9.0	2130	520 ~ 2950	3.76	A
3.5 + 4.2 + 4.2	11.9	2.36	2.82	2.82		8.00	3.0 ~ 9.0	2320	480 ~ 3250	3.45	A
3.5 + 4.2 + 5.0	12.7	2.20	2.65	3.15		8.00	3.0 ~ 9.0	2130	520 ~ 2950	3.76	A
3.5 + 4.2 + 6.0	13.7	2.04	2.45	3.51		8.00	3.0 ~ 9.0	2130	520 ~ 2950	3.76	A
3.5 + 5.0 + 5.0	13.5	2.08	2.96	2.96		8.00	3.0 ~ 9.0	2070	570 ~ 2800	3.86	A
3.5 + 5.0 + 6.0	14.5	1.93	2.76	3.31		8.00	3.0 ~ 9.0	2070	570 ~ 2800	3.86	A
4.2 + 4.2 + 4.2	12.6	2.66	2.66	2.66		7.98	3.0 ~ 9.0	2320	480 ~ 3250	3.44	A
4.2 + 4.2 + 5.0	13.4	2.51	2.51	2.98		8.00	3.0 ~ 9.0	2130	520 ~ 2950	3.76	A
4.2 + 4.2 + 6.0	14.4	2.33	2.33	3.33		7.99	3.0 ~ 9.0	2130	520 ~ 2950	3.75	A
4.2 + 5.0 + 5.0	14.2	2.36	2.82	2.82		8.00	3.0 ~ 9.0	2070	570 ~ 2800	3.86	A

3  
Room



Indoor unit capacity Cooling	Annual Energy Consumption (kWh)	Current 230V (A)	ERP				Moisture Removal Volume l/h	
			Pdesign (kW)	SEER		Annual Consumption (kWh)		
				WW	CLASS			
3 Room	2.0 + 5.0 + 6.0	1035	9.9	8.00	5.60	A+	500	0.8 + 1.7 + 2.1
	2.0 + 5.0 + 7.1	1035	9.9	8.00	5.60	A+	500	0.7 + 1.7 + 2.3
	2.0 + 6.0 + 6.0	1035	9.9	8.00	5.60	A+	500	0.7 + 2.0 + 2.0
	2.5 + 2.5 + 2.5	1140	10.9	7.50	5.60	A+	469	1.5 + 1.5 + 1.5
	2.5 + 2.5 + 3.5	1220	11.7	8.00	5.60	A+	500	1.5 + 1.5 + 1.9
	2.5 + 2.5 + 4.2	1220	11.7	8.00	5.60	A+	500	1.4 + 1.4 + 2.1
	2.5 + 2.5 + 5.0	1095	10.5	8.00	5.60	A+	500	1.3 + 1.3 + 2.3
	2.5 + 2.5 + 6.0	1095	10.5	8.00	5.60	A+	500	1.2 + 1.2 + 2.4
	2.5 + 2.5 + 7.1	1095	10.5	8.00	5.60	A+	500	1.1 + 1.1 + 2.5
	2.5 + 3.5 + 3.5	1190	11.4	8.00	5.60	A+	500	1.4 + 1.7 + 1.7
	2.5 + 3.5 + 4.2	1190	11.4	8.00	5.60	A+	500	1.3 + 1.6 + 1.9
	2.5 + 3.5 + 5.0	1095	10.5	8.00	5.60	A+	500	1.2 + 1.6 + 2.1
	2.5 + 3.5 + 6.0	1095	10.5	8.00	5.60	A+	500	1.1 + 1.5 + 2.3
	2.5 + 3.5 + 7.1	1065	10.2	8.00	5.60	A+	500	1.0 + 1.4 + 2.4
	2.5 + 4.2 + 4.2	1190	11.4	8.00	5.60	A+	500	1.2 + 1.7 + 1.7
	2.5 + 4.2 + 5.0	1095	10.5	8.00	5.60	A+	500	1.1 + 1.7 + 2.0
	2.5 + 4.2 + 6.0	1095	10.5	8.00	5.60	A+	500	1.0 + 1.6 + 2.2
	2.5 + 4.2 + 7.1	1065	10.2	8.00	5.60	A+	500	0.9 + 1.5 + 2.3
	2.5 + 5.0 + 5.0	1035	9.9	8.00	5.60	A+	500	1.0 + 1.8 + 1.8
	2.5 + 5.0 + 6.0	1035	9.9	8.00	5.60	A+	500	0.9 + 1.7 + 2.1
	2.5 + 5.0 + 7.1	1035	9.9	8.00	5.60	A+	500	0.9 + 1.6 + 2.3
	2.5 + 6.0 + 6.0	1035	9.9	8.00	5.60	A+	500	0.9 + 1.9 + 1.9
	3.5 + 3.5 + 3.5	1160	11.1	7.98	5.60	A+	499	1.6 + 1.6 + 1.6
	3.5 + 3.5 + 4.2	1160	11.1	8.00	5.60	A+	500	1.5 + 1.5 + 1.7
	3.5 + 3.5 + 5.0	1065	10.2	7.99	5.60	A+	499	1.5 + 1.5 + 1.9
	3.5 + 3.5 + 6.0	1065	10.2	8.00	5.60	A+	500	1.4 + 1.4 + 2.2
	3.5 + 3.5 + 7.1	1065	10.2	8.00	5.60	A+	500	1.3 + 1.3 + 2.3
	3.5 + 4.2 + 4.2	1160	11.1	8.00	5.60	A+	500	1.5 + 1.7 + 1.7
	3.5 + 4.2 + 5.0	1065	10.2	8.00	5.60	A+	500	1.4 + 1.6 + 1.8
	3.5 + 4.2 + 6.0	1065	10.2	8.00	5.60	A+	500	1.3 + 1.5 + 2.0
3.5 + 5.0 + 5.0	1035	9.9	8.00	5.60	A+	500	1.3 + 1.7 + 1.7	
3.5 + 5.0 + 6.0	1035	9.9	8.00	5.60	A+	500	1.2 + 1.6 + 1.9	
4.2 + 4.2 + 4.2	1160	11.1	7.98	5.60	A+	499	1.6 + 1.6 + 1.6	
4.2 + 4.2 + 5.0	1065	10.2	8.00	5.60	A+	500	1.5 + 1.5 + 1.7	
4.2 + 4.2 + 6.0	1065	10.2	7.99	5.60	A+	499	1.5 + 1.5 + 1.9	
4.2 + 5.0 + 5.0	1035	9.9	8.00	5.60	A+	500	1.5 + 1.7 + 1.7	

Indoor unit capacity Cooling	Total	Cooling Capacity (kW)						Input Power (W)		EER	
		Room A	Room B	Room C	Room D	Total	min ~ max	Rating	min ~ max	W/W	CLASS
1.6 + 1.6 + 1.6 + 1.6	6.4	1.60	1.60	1.60	1.60	6.40	3.0 ~ 9.2	1690	520 ~ 3150	3.79	A
1.6 + 1.6 + 1.6 + 2.0	6.8	1.60	1.60	1.60	2.00	6.80	3.0 ~ 9.2	1790	520 ~ 3070	3.80	A
1.6 + 1.6 + 1.6 + 2.5	7.3	1.60	1.60	1.60	2.50	7.30	3.0 ~ 9.2	1960	520 ~ 3070	3.72	A
1.6 + 1.6 + 1.6 + 3.5	8.3	1.54	1.54	1.54	3.38	8.00	3.0 ~ 9.2	2180	530 ~ 3070	3.67	A
1.6 + 1.6 + 1.6 + 4.2	9.0	1.42	1.42	1.42	3.74	8.00	3.0 ~ 9.2	2180	530 ~ 3070	3.67	A
1.6 + 1.6 + 1.6 + 5.0	9.8	1.31	1.31	1.31	4.07	8.00	3.0 ~ 9.2	2070	620 ~ 2930	3.86	A
1.6 + 1.6 + 1.6 + 6.0	10.8	1.19	1.19	1.19	4.43	8.00	3.0 ~ 9.2	2070	620 ~ 2930	3.86	A
1.6 + 1.6 + 1.6 + 7.1	11.9	1.08	1.08	1.08	4.76	8.00	3.0 ~ 9.2	2070	620 ~ 2860	3.86	A
1.6 + 1.6 + 2.0 + 2.0	7.2	1.60	1.60	2.00	2.00	7.20	3.0 ~ 9.2	1900	530 ~ 3070	3.79	A
1.6 + 1.6 + 2.0 + 2.5	7.7	1.60	1.60	2.00	2.50	7.70	3.0 ~ 9.2	2060	530 ~ 3070	3.74	A
1.6 + 1.6 + 2.0 + 3.5	8.7	1.47	1.47	1.84	3.22	8.00	3.0 ~ 9.2	2120	530 ~ 3070	3.77	A
1.6 + 1.6 + 2.0 + 4.2	9.4	1.36	1.36	1.70	3.58	8.00	3.0 ~ 9.2	2120	560 ~ 3070	3.77	A
1.6 + 1.6 + 2.0 + 5.0	10.2	1.25	1.25	1.57	3.93	8.00	3.0 ~ 9.2	2070	620 ~ 2850	3.86	A
1.6 + 1.6 + 2.0 + 6.0	11.2	1.14	1.14	1.43	4.29	8.00	3.0 ~ 9.2	2070	620 ~ 2850	3.86	A
1.6 + 1.6 + 2.0 + 7.1	12.3	1.04	1.04	1.30	4.62	8.00	3.0 ~ 9.2	2070	620 ~ 2860	3.86	A
1.6 + 1.6 + 2.5 + 2.5	8.2	1.56	1.56	2.44	2.44	8.00	3.0 ~ 9.2	2180	530 ~ 3070	3.67	A
1.6 + 1.6 + 2.5 + 3.5	9.2	1.39	1.39	2.17	3.05	8.00	3.0 ~ 9.2	2120	530 ~ 3070	3.77	A
1.6 + 1.6 + 2.5 + 4.2	9.9	1.29	1.29	2.02	3.40	8.00	3.0 ~ 9.2	2120	560 ~ 3070	3.77	A
1.6 + 1.6 + 2.5 + 5.0	10.7	1.20	1.20	1.87	3.73	8.00	3.0 ~ 9.2	2070	620 ~ 2850	3.86	A
1.6 + 1.6 + 2.5 + 6.0	11.7	1.09	1.09	1.71	4.11	8.00	3.0 ~ 9.2	2070	620 ~ 2850	3.86	A
1.6 + 1.6 + 2.5 + 7.1	12.8	1.00	1.00	1.56	4.44	8.00	3.0 ~ 9.2	2070	620 ~ 2860	3.86	A
1.6 + 1.6 + 3.5 + 3.5	10.2	1.25	1.25	2.75	2.75	8.00	3.0 ~ 9.2	2120	570 ~ 3000	3.77	A
1.6 + 1.6 + 3.5 + 4.2	10.9	1.17	1.17	2.57	3.09	8.00	3.0 ~ 9.2	2120	570 ~ 3000	3.77	A
1.6 + 1.6 + 3.5 + 5.0	11.7	1.09	1.09	2.39	3.43	8.00	3.0 ~ 9.2	2070	620 ~ 2860	3.86	A
1.6 + 1.6 + 3.5 + 6.0	12.7	1.01	1.01	2.20	3.78	8.00	3.0 ~ 9.2	2070	620 ~ 2860	3.86	A
1.6 + 1.6 + 3.5 + 7.1	13.8	0.93	0.93	2.03	4.11	8.00	3.0 ~ 9.2	2070	630 ~ 2860	3.86	A
1.6 + 1.6 + 4.2 + 4.2	11.6	1.10	1.10	2.90	2.90	8.00	3.0 ~ 9.2	2120	570 ~ 3000	3.77	A
1.6 + 1.6 + 4.2 + 5.0	12.4	1.03	1.03	2.71	3.23	8.00	3.0 ~ 9.2	2070	620 ~ 2860	3.86	A
1.6 + 1.6 + 4.2 + 6.0	13.4	0.96	0.96	2.51	3.57	8.00	3.0 ~ 9.2	2070	620 ~ 2860	3.86	A
1.6 + 1.6 + 4.2 + 7.1	14.5	0.88	0.88	2.32	3.92	8.00	3.0 ~ 9.2	2070	630 ~ 2860	3.86	A
1.6 + 1.6 + 5.0 + 5.0	13.2	0.97	0.97	3.03	3.03	8.00	3.0 ~ 9.2	2080	690 ~ 2800	3.85	A
1.6 + 1.6 + 5.0 + 6.0	14.2	0.90	0.90	2.82	3.38	8.00	3.0 ~ 9.2	2080	690 ~ 2800	3.85	A
1.6 + 2.0 + 2.0 + 2.0	7.6	1.60	2.00	2.00	2.00	7.60	3.0 ~ 9.2	2070	530 ~ 3070	3.67	A
1.6 + 2.0 + 2.0 + 2.5	8.1	1.58	1.98	1.98	2.46	8.00	3.0 ~ 9.2	2180	530 ~ 3070	3.67	A
1.6 + 2.0 + 2.0 + 3.5	9.1	1.41	1.76	1.76	3.07	8.00	3.0 ~ 9.2	2120	570 ~ 3000	3.77	A
1.6 + 2.0 + 2.0 + 4.2	9.8	1.31	1.63	1.63	3.43	8.00	3.0 ~ 9.2	2120	570 ~ 3000	3.77	A
1.6 + 2.0 + 2.0 + 5.0	10.6	1.21	1.51	1.51	3.77	8.00	3.0 ~ 9.2	2070	620 ~ 2850	3.86	A
1.6 + 2.0 + 2.0 + 6.0	11.6	1.10	1.38	1.38	4.14	8.00	3.0 ~ 9.2	2070	620 ~ 2850	3.86	A
1.6 + 2.0 + 2.0 + 7.1	12.7	1.01	1.26	1.26	4.47	8.00	3.0 ~ 9.2	2070	630 ~ 2860	3.86	A
1.6 + 2.0 + 2.5 + 2.5	8.6	1.48	1.86	2.33	2.33	8.00	3.0 ~ 9.2	2180	530 ~ 3070	3.67	A
1.6 + 2.0 + 2.5 + 3.5	9.6	1.33	1.67	2.08	2.92	8.00	3.0 ~ 9.2	2120	570 ~ 3000	3.77	A
1.6 + 2.0 + 2.5 + 4.2	10.3	1.24	1.55	1.94	3.27	8.00	3.0 ~ 9.2	2120	570 ~ 3000	3.77	A
1.6 + 2.0 + 2.5 + 5.0	11.1	1.15	1.44	1.80	3.61	8.00	3.0 ~ 9.2	2070	620 ~ 2850	3.86	A
1.6 + 2.0 + 2.5 + 6.0	12.1	1.06	1.32	1.65	3.97	8.00	3.0 ~ 9.2	2070	620 ~ 2850	3.86	A
1.6 + 2.0 + 2.5 + 7.1	13.2	0.97	1.21	1.52	4.30	8.00	3.0 ~ 9.2	2070	630 ~ 2860	3.86	A
1.6 + 2.0 + 3.5 + 3.5	10.6	1.21	1.51	2.64	2.64	8.00	3.0 ~ 9.2	2120	570 ~ 3000	3.77	A
1.6 + 2.0 + 3.5 + 4.2	11.3	1.13	1.42	2.48	2.97	8.00	3.0 ~ 9.2	2120	570 ~ 3000	3.77	A
1.6 + 2.0 + 3.5 + 5.0	12.1	1.06	1.32	2.31	3.31	8.00	3.0 ~ 9.2	2070	630 ~ 2860	3.86	A
1.6 + 2.0 + 3.5 + 6.0	13.1	0.98	1.22	2.14	3.66	8.00	3.0 ~ 9.2	2070	630 ~ 2860	3.86	A
1.6 + 2.0 + 3.5 + 7.1	14.2	0.90	1.13	1.97	4.00	8.00	3.0 ~ 9.2	2070	630 ~ 2860	3.86	A
1.6 + 2.0 + 4.2 + 4.2	12.0	1.07	1.33	2.80	2.80	8.00	3.0 ~ 9.2	2120	570 ~ 3000	3.77	A
1.6 + 2.0 + 4.2 + 5.0	12.8	1.00	1.25	2.63	3.12	8.00	3.0 ~ 9.2	2070	630 ~ 2860	3.86	A
1.6 + 2.0 + 4.2 + 6.0	13.8	0.93	1.16	2.43	3.48	8.00	3.0 ~ 9.2	2070	630 ~ 2860	3.86	A
1.6 + 2.0 + 5.0 + 5.0	13.6	0.94	1.18	2.94	2.94	8.00	3.0 ~ 9.2	2090	690 ~ 2800	3.83	A
1.6 + 2.0 + 5.0 + 6.0	14.6	0.88	1.10	2.74	3.28	8.00	3.0 ~ 9.2	2090	690 ~ 2800	3.83	A
1.6 + 2.5 + 2.5 + 2.5	9.1	1.40	2.20	2.20	2.20	8.00	3.0 ~ 9.2	2180	530 ~ 3070	3.67	A
1.6 + 2.5 + 2.5 + 3.5	10.1	1.27	1.98	1.98	2.77	8.00	3.0 ~ 9.2	2120	570 ~ 3000	3.77	A
1.6 + 2.5 + 2.5 + 4.2	10.8	1.19	1.85	1.85	3.11	8.00	3.0 ~ 9.2	2120	570 ~ 3000	3.77	A

Indoor unit capacity Cooling	Annual Energy Consumption (kWh)	Current 230V (A)	ERP				Moisture Removal Volume l/h
			Pdesign (kW)	SEER		Annual Consumption (kWh)	
				WW	CLASS		
1.6 + 1.6 + 1.6 + 1.6	845	8.2	6.40	6.00	A+	373	1.0 + 1.0 + 1.0 + 1.0
1.6 + 1.6 + 1.6 + 2.0	895	8.6	6.80	6.00	A+	397	1.0 + 1.0 + 1.0 + 1.3
1.6 + 1.6 + 1.6 + 2.5	980	9.4	7.30	6.00	A+	426	1.0 + 1.0 + 1.0 + 1.5
1.6 + 1.6 + 1.6 + 3.5	1090	10.4	8.00	6.00	A+	467	1.0 + 1.0 + 1.0 + 1.9
1.6 + 1.6 + 1.6 + 4.2	1090	10.4	8.00	6.00	A+	467	0.9 + 0.9 + 0.9 + 2.2
1.6 + 1.6 + 1.6 + 5.0	1035	9.9	8.00	6.00	A+	467	0.8 + 0.8 + 0.8 + 2.3
1.6 + 1.6 + 1.6 + 6.0	1035	9.9	8.00	6.00	A+	467	0.7 + 0.7 + 0.7 + 2.5
1.6 + 1.6 + 1.6 + 7.1	1035	9.9	8.00	6.00	A+	467	0.7 + 0.7 + 0.7 + 2.6
1.6 + 1.6 + 2.0 + 2.0	950	9.1	7.20	6.00	A+	420	1.0 + 1.0 + 1.3 + 1.3
1.6 + 1.6 + 2.0 + 2.5	1030	9.9	7.70	6.00	A+	449	1.0 + 1.0 + 1.3 + 1.5
1.6 + 1.6 + 2.0 + 3.5	1060	10.1	8.00	6.00	A+	467	0.9 + 0.9 + 1.2 + 1.8
1.6 + 1.6 + 2.0 + 4.2	1060	10.1	8.00	6.00	A+	467	0.9 + 0.9 + 1.1 + 2.1
1.6 + 1.6 + 2.0 + 5.0	1035	9.9	8.00	6.00	A+	467	0.8 + 0.8 + 1.0 + 2.3
1.6 + 1.6 + 2.0 + 6.0	1035	9.9	8.00	6.00	A+	467	0.7 + 0.7 + 0.9 + 2.4
1.6 + 1.6 + 2.0 + 7.1	1035	9.9	8.00	6.00	A+	467	0.7 + 0.7 + 0.8 + 2.5
1.6 + 1.6 + 2.5 + 2.5	1090	10.4	8.00	6.00	A+	467	1.0 + 1.0 + 1.5 + 1.5
1.6 + 1.6 + 2.5 + 3.5	1060	10.1	8.00	6.00	A+	467	0.9 + 0.9 + 1.4 + 1.7
1.6 + 1.6 + 2.5 + 4.2	1060	10.1	8.00	6.00	A+	467	0.8 + 0.8 + 1.3 + 1.9
1.6 + 1.6 + 2.5 + 5.0	1035	9.9	8.00	6.00	A+	467	0.7 + 0.7 + 1.2 + 2.2
1.6 + 1.6 + 2.5 + 6.0	1035	9.9	8.00	6.00	A+	467	0.7 + 0.7 + 1.1 + 2.3
1.6 + 1.6 + 2.5 + 7.1	1035	9.9	8.00	6.00	A+	467	0.7 + 0.7 + 1.0 + 2.5
1.6 + 1.6 + 3.5 + 3.5	1060	10.1	8.00	6.00	A+	467	0.8 + 0.8 + 1.6 + 1.6
1.6 + 1.6 + 3.5 + 4.2	1060	10.1	8.00	6.00	A+	467	0.7 + 0.7 + 1.6 + 1.7
1.6 + 1.6 + 3.5 + 5.0	1035	9.9	8.00	6.00	A+	467	0.7 + 0.7 + 1.5 + 2.0
1.6 + 1.6 + 3.5 + 6.0	1035	9.9	8.00	6.00	A+	467	0.7 + 0.7 + 1.4 + 2.2
1.6 + 1.6 + 3.5 + 7.1	1035	9.9	8.00	6.00	A+	467	0.7 + 0.7 + 1.3 + 2.3
1.6 + 1.6 + 4.2 + 4.2	1060	10.1	8.00	6.00	A+	467	0.7 + 0.7 + 1.7 + 1.7
1.6 + 1.6 + 4.2 + 5.0	1035	9.9	8.00	6.00	A+	467	0.7 + 0.7 + 1.6 + 1.8
1.6 + 1.6 + 4.2 + 6.0	1035	9.9	8.00	6.00	A+	467	0.7 + 0.7 + 1.5 + 2.1
1.6 + 1.6 + 4.2 + 7.1	1035	9.9	8.00	6.00	A+	467	0.7 + 0.7 + 1.5 + 2.3
1.6 + 1.6 + 5.0 + 5.0	1040	10.0	8.00	6.00	A+	467	0.7 + 0.7 + 1.7 + 1.7
1.6 + 1.6 + 5.0 + 6.0	1040	10.0	8.00	6.00	A+	467	0.7 + 0.7 + 1.7 + 1.9
1.6 + 2.0 + 2.0 + 2.0	1035	9.9	7.60	6.00	A+	443	1.0 + 1.3 + 1.3 + 1.3
1.6 + 2.0 + 2.0 + 2.5	1090	10.4	8.00	6.00	A+	467	1.0 + 1.3 + 1.3 + 1.5
1.6 + 2.0 + 2.0 + 3.5	1060	10.1	8.00	6.00	A+	467	0.9 + 1.1 + 1.1 + 1.7
1.6 + 2.0 + 2.0 + 4.2	1060	10.1	8.00	6.00	A+	467	0.8 + 1.0 + 1.0 + 2.0
1.6 + 2.0 + 2.0 + 5.0	1035	9.9	8.00	6.00	A+	467	0.8 + 1.0 + 1.0 + 2.2
1.6 + 2.0 + 2.0 + 6.0	1035	9.9	8.00	6.00	A+	467	0.7 + 0.9 + 0.9 + 2.4
1.6 + 2.0 + 2.0 + 7.1	1035	9.9	8.00	6.00	A+	467	0.7 + 0.8 + 0.8 + 2.5
1.6 + 2.0 + 2.5 + 2.5	1090	10.4	8.00	6.00	A+	467	0.9 + 1.2 + 1.5 + 1.5
1.6 + 2.0 + 2.5 + 3.5	1060	10.1	8.00	6.00	A+	467	0.8 + 1.1 + 1.3 + 1.7
1.6 + 2.0 + 2.5 + 4.2	1060	10.1	8.00	6.00	A+	467	0.8 + 1.0 + 1.3 + 1.9
1.6 + 2.0 + 2.5 + 5.0	1035	9.9	8.00	6.00	A+	467	0.7 + 0.9 + 1.2 + 2.1
1.6 + 2.0 + 2.5 + 6.0	1035	9.9	8.00	6.00	A+	467	0.7 + 0.8 + 1.1 + 2.3
1.6 + 2.0 + 2.5 + 7.1	1035	9.9	8.00	6.00	A+	467	0.7 + 0.8 + 1.0 + 2.4
1.6 + 2.0 + 3.5 + 3.5	1060	10.1	8.00	6.00	A+	467	0.8 + 1.0 + 1.6 + 1.6
1.6 + 2.0 + 3.5 + 4.2	1060	10.1	8.00	6.00	A+	467	0.7 + 0.9 + 1.5 + 1.7
1.6 + 2.0 + 3.5 + 5.0	1035	9.9	8.00	6.00	A+	467	0.7 + 0.8 + 1.5 + 1.9
1.6 + 2.0 + 3.5 + 6.0	1035	9.9	8.00	6.00	A+	467	0.7 + 0.8 + 1.4 + 2.1
1.6 + 2.0 + 3.5 + 7.1	1035	9.9	8.00	6.00	A+	467	0.7 + 0.7 + 1.3 + 2.3
1.6 + 2.0 + 4.2 + 4.2	1060	10.1	8.00	6.00	A+	467	0.7 + 0.8 + 1.6 + 1.6
1.6 + 2.0 + 4.2 + 5.0	1035	9.9	8.00	6.00	A+	467	0.7 + 0.8 + 1.6 + 1.8
1.6 + 2.0 + 4.2 + 6.0	1035	9.9	8.00	6.00	A+	467	0.7 + 0.7 + 1.5 + 2.0
1.6 + 2.0 + 5.0 + 5.0	1045	10.0	8.00	6.00	A+	467	0.7 + 0.7 + 1.7 + 1.7
1.6 + 2.0 + 5.0 + 6.0	1045	10.0	8.00	6.00	A+	467	0.7 + 0.7 + 1.6 + 1.9
1.6 + 2.5 + 2.5 + 2.5	1090	10.4	8.00	6.00	A+	467	0.9 + 1.4 + 1.4 + 1.4
1.6 + 2.5 + 2.5 + 3.5	1060	10.1	8.00	6.00	A+	467	0.8 + 1.3 + 1.3 + 1.6
1.6 + 2.5 + 2.5 + 4.2	1060	10.1	8.00	6.00	A+	467	0.7 + 1.2 + 1.2 + 1.8

4  
Room

Indoor unit capacity Cooling	Total	Cooling Capacity (kW)						Input Power (W)		EER	
		Room A	Room B	Room C	Room D	Total	min ~ max	Rating	min ~ max	W/W	CLASS
1.6 + 2.5 + 2.5 + 5.0	11.6	1.10	1.72	1.72	3.46	8.00	3.0 ~ 9.2	2070	620 ~ 2850	3.86	A
1.6 + 2.5 + 2.5 + 6.0	12.6	1.02	1.59	1.59	3.80	8.00	3.0 ~ 9.2	2070	620 ~ 2850	3.86	A
1.6 + 2.5 + 2.5 + 7.1	13.7	0.93	1.46	1.46	4.15	8.00	3.0 ~ 9.2	2070	630 ~ 2860	3.86	A
1.6 + 2.5 + 3.5 + 3.5	11.1	1.15	1.81	2.52	2.52	8.00	3.0 ~ 9.2	2120	570 ~ 3000	3.77	A
1.6 + 2.5 + 3.5 + 4.2	11.8	1.08	1.69	2.37	2.86	8.00	3.0 ~ 9.2	2120	570 ~ 3000	3.77	A
1.6 + 2.5 + 3.5 + 5.0	12.6	1.02	1.59	2.22	3.17	8.00	3.0 ~ 9.2	2070	630 ~ 2860	3.86	A
1.6 + 2.5 + 3.5 + 6.0	13.6	0.94	1.47	2.06	3.53	8.00	3.0 ~ 9.2	2070	630 ~ 2860	3.86	A
1.6 + 2.5 + 3.5 + 7.1	14.7	0.87	1.36	1.90	3.87	8.00	3.0 ~ 9.2	2070	630 ~ 2860	3.86	A
1.6 + 2.5 + 4.2 + 4.2	12.5	1.02	1.60	2.69	2.69	8.00	3.0 ~ 9.2	2120	570 ~ 3000	3.77	A
1.6 + 2.5 + 4.2 + 5.0	13.3	0.96	1.50	2.53	3.01	8.00	3.0 ~ 9.2	2070	630 ~ 2860	3.86	A
1.6 + 2.5 + 4.2 + 6.0	14.3	0.90	1.40	2.35	3.35	8.00	3.0 ~ 9.2	2070	630 ~ 2860	3.86	A
1.6 + 2.5 + 5.0 + 5.0	14.1	0.90	1.42	2.84	2.84	8.00	3.0 ~ 9.2	2090	690 ~ 2800	3.83	A
1.6 + 3.5 + 3.5 + 3.5	12.1	1.07	2.31	2.31	2.31	8.00	3.0 ~ 9.2	2120	570 ~ 3000	3.77	A
1.6 + 3.5 + 3.5 + 4.2	12.8	1.00	2.19	2.19	2.62	8.00	3.0 ~ 9.2	2120	570 ~ 2920	3.77	A
1.6 + 3.5 + 3.5 + 5.0	13.6	0.94	2.06	2.06	2.94	8.00	3.0 ~ 9.2	2070	630 ~ 2860	3.86	A
1.6 + 3.5 + 3.5 + 6.0	14.6	0.88	1.92	1.92	3.28	8.00	3.0 ~ 9.2	2070	630 ~ 2860	3.86	A
1.6 + 3.5 + 4.2 + 4.2	13.5	0.95	2.07	2.49	2.49	8.00	3.0 ~ 9.2	2120	570 ~ 2920	3.77	A
1.6 + 3.5 + 4.2 + 5.0	14.3	0.90	1.96	2.35	2.79	8.00	3.0 ~ 9.2	2070	630 ~ 2860	3.86	A
1.6 + 4.2 + 4.2 + 4.2	14.2	0.89	2.37	2.37	2.37	8.00	3.0 ~ 9.2	2120	570 ~ 2920	3.77	A
2.0 + 2.0 + 2.0 + 2.0	8.0	2.00	2.00	2.00	2.00	8.00	3.0 ~ 9.2	2180	530 ~ 3070	3.67	A
2.0 + 2.0 + 2.0 + 2.5	8.5	1.88	1.88	1.88	2.36	8.00	3.0 ~ 9.2	2180	530 ~ 3070	3.67	A
2.0 + 2.0 + 2.0 + 3.5	9.5	1.68	1.68	1.68	2.96	8.00	3.0 ~ 9.2	2120	570 ~ 3000	3.77	A
2.0 + 2.0 + 2.0 + 4.2	10.2	1.57	1.57	1.57	3.29	8.00	3.0 ~ 9.2	2120	570 ~ 3000	3.77	A
2.0 + 2.0 + 2.0 + 5.0	11.0	1.45	1.45	1.45	3.65	8.00	3.0 ~ 9.2	2070	620 ~ 2850	3.86	A
2.0 + 2.0 + 2.0 + 6.0	12.0	1.33	1.33	1.33	4.01	8.00	3.0 ~ 9.2	2070	620 ~ 2850	3.86	A
2.0 + 2.0 + 2.0 + 7.1	13.1	1.22	1.22	1.22	4.34	8.00	3.0 ~ 9.2	2070	630 ~ 2860	3.86	A
2.0 + 2.0 + 2.5 + 2.5	9.0	1.78	1.78	2.22	2.22	8.00	3.0 ~ 9.2	2180	530 ~ 3070	3.67	A
2.0 + 2.0 + 2.5 + 3.5	10.0	1.60	1.60	2.00	2.80	8.00	3.0 ~ 9.2	2120	570 ~ 3000	3.77	A
2.0 + 2.0 + 2.5 + 4.2	10.7	1.50	1.50	1.87	3.13	8.00	3.0 ~ 9.2	2120	570 ~ 3000	3.77	A
2.0 + 2.0 + 2.5 + 5.0	11.5	1.39	1.39	1.74	3.48	8.00	3.0 ~ 9.2	2070	620 ~ 2850	3.86	A
2.0 + 2.0 + 2.5 + 6.0	12.5	1.28	1.28	1.60	3.84	8.00	3.0 ~ 9.2	2070	620 ~ 2850	3.86	A
2.0 + 2.0 + 2.5 + 7.1	13.6	1.18	1.18	1.47	4.17	8.00	3.0 ~ 9.2	2070	630 ~ 2860	3.86	A
2.0 + 2.0 + 3.5 + 3.5	11.0	1.45	1.45	2.55	2.55	8.00	3.0 ~ 9.2	2120	570 ~ 3000	3.77	A
2.0 + 2.0 + 3.5 + 4.2	11.7	1.37	1.37	2.39	2.87	8.00	3.0 ~ 9.2	2120	570 ~ 3000	3.77	A
2.0 + 2.0 + 3.5 + 5.0	12.5	1.28	1.28	2.24	3.20	8.00	3.0 ~ 9.2	2070	630 ~ 2860	3.86	A
2.0 + 2.0 + 3.5 + 6.0	13.5	1.19	1.19	2.07	3.55	8.00	3.0 ~ 9.2	2070	630 ~ 2860	3.86	A
2.0 + 2.0 + 3.5 + 7.1	14.6	1.10	1.10	1.92	3.88	8.00	3.0 ~ 9.2	2070	630 ~ 2860	3.86	A
2.0 + 2.0 + 4.2 + 4.2	12.4	1.29	1.29	2.71	2.71	8.00	3.0 ~ 9.2	2120	570 ~ 3000	3.77	A
2.0 + 2.0 + 4.2 + 5.0	13.2	1.21	1.21	2.55	3.03	8.00	3.0 ~ 9.2	2070	630 ~ 2860	3.86	A
2.0 + 2.0 + 4.2 + 6.0	14.2	1.13	1.13	2.37	3.37	8.00	3.0 ~ 9.2	2070	630 ~ 2860	3.86	A
2.0 + 2.0 + 5.0 + 5.0	14.0	1.14	1.14	2.86	2.86	8.00	3.0 ~ 9.2	2090	700 ~ 2800	3.83	A
2.0 + 2.5 + 2.5 + 2.5	9.5	1.67	2.11	2.11	2.11	8.00	3.0 ~ 9.2	2180	530 ~ 3070	3.67	A
2.0 + 2.5 + 2.5 + 3.5	10.5	1.52	1.90	1.90	2.68	8.00	3.0 ~ 9.2	2120	570 ~ 3000	3.77	A
2.0 + 2.5 + 2.5 + 4.2	11.2	1.43	1.79	1.79	2.99	8.00	3.0 ~ 9.2	2120	570 ~ 3000	3.77	A
2.0 + 2.5 + 2.5 + 5.0	12.0	1.33	1.67	1.67	3.33	8.00	3.0 ~ 9.2	2070	620 ~ 2850	3.86	A
2.0 + 2.5 + 2.5 + 6.0	13.0	1.23	1.54	1.54	3.69	8.00	3.0 ~ 9.2	2070	620 ~ 2850	3.86	A
2.0 + 2.5 + 2.5 + 7.1	14.1	1.13	1.42	1.42	4.03	8.00	3.0 ~ 9.2	2070	630 ~ 2860	3.86	A
2.0 + 2.5 + 3.5 + 3.5	11.5	1.39	1.75	2.43	2.43	8.00	3.0 ~ 9.2	2120	570 ~ 3000	3.77	A
2.0 + 2.5 + 3.5 + 4.2	12.2	1.31	1.64	2.30	2.75	8.00	3.0 ~ 9.2	2120	570 ~ 3000	3.77	A
2.0 + 2.5 + 3.5 + 5.0	13.0	1.23	1.54	2.15	3.08	8.00	3.0 ~ 9.2	2070	630 ~ 2860	3.86	A
2.0 + 2.5 + 3.5 + 6.0	14.0	1.14	1.43	2.00	3.43	8.00	3.0 ~ 9.2	2070	630 ~ 2860	3.86	A
2.0 + 2.5 + 4.2 + 4.2	12.9	1.24	1.56	2.60	2.60	8.00	3.0 ~ 9.2	2120	570 ~ 3000	3.77	A
2.0 + 2.5 + 4.2 + 5.0	13.7	1.17	1.46	2.45	2.92	8.00	3.0 ~ 9.2	2070	630 ~ 2860	3.86	A
2.0 + 2.5 + 4.2 + 6.0	14.7	1.09	1.36	2.29	3.26	8.00	3.0 ~ 9.2	2070	630 ~ 2860	3.86	A
2.0 + 2.5 + 5.0 + 5.0	14.5	1.10	1.38	2.76	2.76	8.00	3.0 ~ 9.2	2090	700 ~ 2800	3.83	A
2.0 + 3.5 + 3.5 + 3.5	12.5	1.28	2.24	2.24	2.24	8.00	3.0 ~ 9.2	2120	570 ~ 2920	3.77	A
2.0 + 3.5 + 3.5 + 4.2	13.2	1.21	2.12	2.12	2.55	8.00	3.0 ~ 9.2	2120	570 ~ 2920	3.77	A
2.0 + 3.5 + 3.5 + 5.0	14.0	1.14	2.00	2.00	2.86	8.00	3.0 ~ 9.2	2070	630 ~ 2860	3.86	A

Indoor unit capacity Cooling	Annual Energy Consumption (kWh)	Current 230V (A)	ERP				Moisture Removal Volume l/h
			Pdesign (kW)	SEER		Annual Consumption (kWh)	
				WW	CLASS		
1.6 + 2.5 + 2.5 + 5.0	1035	9.9	8.00	6.00	A+	467	0.7 + 1.1 + 1.1 + 2.0
1.6 + 2.5 + 2.5 + 6.0	1035	9.9	8.00	6.00	A+	467	0.7 + 1.0 + 1.0 + 2.2
1.6 + 2.5 + 2.5 + 7.1	1035	9.9	8.00	6.00	A+	467	0.7 + 0.9 + 0.9 + 2.4
1.6 + 2.5 + 3.5 + 3.5	1060	10.1	8.00	6.00	A+	467	0.7 + 1.2 + 1.5 + 1.5
1.6 + 2.5 + 3.5 + 4.2	1060	10.1	8.00	6.00	A+	467	0.7 + 1.1 + 1.5 + 1.7
1.6 + 2.5 + 3.5 + 5.0	1035	9.9	8.00	6.00	A+	467	0.7 + 1.0 + 1.4 + 1.8
1.6 + 2.5 + 3.5 + 6.0	1035	9.9	8.00	6.00	A+	467	0.7 + 0.9 + 1.3 + 2.0
1.6 + 2.5 + 3.5 + 7.1	1035	9.9	8.00	6.00	A+	467	0.7 + 0.9 + 1.2 + 2.3
1.6 + 2.5 + 4.2 + 4.2	1060	10.1	8.00	6.00	A+	467	0.7 + 1.0 + 1.6 + 1.6
1.6 + 2.5 + 4.2 + 5.0	1035	9.9	8.00	6.00	A+	467	0.7 + 1.0 + 1.6 + 1.7
1.6 + 2.5 + 4.2 + 6.0	1035	9.9	8.00	6.00	A+	467	0.7 + 0.9 + 1.5 + 1.9
1.6 + 2.5 + 5.0 + 5.0	1045	10.0	8.00	6.00	A+	467	0.7 + 0.9 + 1.7 + 1.7
1.6 + 3.5 + 3.5 + 3.5	1060	10.1	8.00	6.00	A+	467	0.7 + 1.5 + 1.5 + 1.5
1.6 + 3.5 + 3.5 + 4.2	1060	10.1	8.00	6.00	A+	467	0.7 + 1.4 + 1.4 + 1.6
1.6 + 3.5 + 3.5 + 5.0	1035	9.9	8.00	6.00	A+	467	0.7 + 1.3 + 1.3 + 1.7
1.6 + 3.5 + 3.5 + 6.0	1035	9.9	8.00	6.00	A+	467	0.7 + 1.2 + 1.2 + 1.9
1.6 + 3.5 + 4.2 + 4.2	1060	10.1	8.00	6.00	A+	467	0.7 + 1.3 + 1.5 + 1.5
1.6 + 3.5 + 4.2 + 5.0	1035	9.9	8.00	6.00	A+	467	0.7 + 1.3 + 1.5 + 1.6
1.6 + 4.2 + 4.2 + 4.2	1060	10.1	8.00	6.00	A+	467	0.7 + 1.5 + 1.5 + 1.5
2.0 + 2.0 + 2.0 + 2.0	1090	10.4	8.00	6.00	A+	467	1.3 + 1.3 + 1.3 + 1.3
2.0 + 2.0 + 2.0 + 2.5	1090	10.4	8.00	6.00	A+	467	1.2 + 1.2 + 1.2 + 1.5
2.0 + 2.0 + 2.0 + 3.5	1060	10.1	8.00	6.00	A+	467	1.1 + 1.1 + 1.1 + 1.7
2.0 + 2.0 + 2.0 + 4.2	1060	10.1	8.00	6.00	A+	467	1.0 + 1.0 + 1.0 + 1.9
2.0 + 2.0 + 2.0 + 5.0	1035	9.9	8.00	6.00	A+	467	0.9 + 0.9 + 0.9 + 2.1
2.0 + 2.0 + 2.0 + 6.0	1035	9.9	8.00	6.00	A+	467	0.8 + 0.8 + 0.8 + 2.3
2.0 + 2.0 + 2.0 + 7.1	1035	9.9	8.00	6.00	A+	467	0.8 + 0.8 + 0.8 + 2.4
2.0 + 2.0 + 2.5 + 2.5	1090	10.4	8.00	6.00	A+	467	1.1 + 1.1 + 1.4 + 1.4
2.0 + 2.0 + 2.5 + 3.5	1060	10.1	8.00	6.00	A+	467	1.0 + 1.0 + 1.3 + 1.6
2.0 + 2.0 + 2.5 + 4.2	1060	10.1	8.00	6.00	A+	467	1.0 + 1.0 + 1.2 + 1.8
2.0 + 2.0 + 2.5 + 5.0	1035	9.9	8.00	6.00	A+	467	0.9 + 0.9 + 1.1 + 2.0
2.0 + 2.0 + 2.5 + 6.0	1035	9.9	8.00	6.00	A+	467	0.8 + 0.8 + 1.0 + 2.2
2.0 + 2.0 + 2.5 + 7.1	1035	9.9	8.00	6.00	A+	467	0.7 + 0.7 + 0.9 + 2.4
2.0 + 2.0 + 3.5 + 3.5	1060	10.1	8.00	6.00	A+	467	0.9 + 0.9 + 1.6 + 1.6
2.0 + 2.0 + 3.5 + 4.2	1060	10.1	8.00	6.00	A+	467	0.9 + 0.9 + 1.5 + 1.7
2.0 + 2.0 + 3.5 + 5.0	1035	9.9	8.00	6.00	A+	467	0.8 + 0.8 + 1.5 + 1.8
2.0 + 2.0 + 3.5 + 6.0	1035	9.9	8.00	6.00	A+	467	0.7 + 0.7 + 1.3 + 2.1
2.0 + 2.0 + 3.5 + 7.1	1035	9.9	8.00	6.00	A+	467	0.7 + 0.7 + 1.2 + 2.3
2.0 + 2.0 + 4.2 + 4.2	1060	10.1	8.00	6.00	A+	467	0.8 + 0.8 + 1.6 + 1.6
2.0 + 2.0 + 4.2 + 5.0	1035	9.9	8.00	6.00	A+	467	0.8 + 0.8 + 1.6 + 1.7
2.0 + 2.0 + 4.2 + 6.0	1035	9.9	8.00	6.00	A+	467	0.7 + 0.7 + 1.5 + 1.9
2.0 + 2.0 + 5.0 + 5.0	1045	10.0	8.00	6.00	A+	467	0.7 + 0.7 + 1.7 + 1.7
2.0 + 2.5 + 2.5 + 2.5	1090	10.4	8.00	6.00	A+	467	1.1 + 1.4 + 1.4 + 1.4
2.0 + 2.5 + 2.5 + 3.5	1060	10.1	8.00	6.00	A+	467	1.0 + 1.2 + 1.2 + 1.6
2.0 + 2.5 + 2.5 + 4.2	1060	10.1	8.00	6.00	A+	467	0.9 + 1.2 + 1.2 + 1.7
2.0 + 2.5 + 2.5 + 5.0	1035	9.9	8.00	6.00	A+	467	0.8 + 1.1 + 1.1 + 1.9
2.0 + 2.5 + 2.5 + 6.0	1035	9.9	8.00	6.00	A+	467	0.8 + 1.0 + 1.0 + 2.1
2.0 + 2.5 + 2.5 + 7.1	1035	9.9	8.00	6.00	A+	467	0.7 + 0.9 + 0.9 + 2.3
2.0 + 2.5 + 3.5 + 3.5	1060	10.1	8.00	6.00	A+	467	0.9 + 1.1 + 1.5 + 1.5
2.0 + 2.5 + 3.5 + 4.2	1060	10.1	8.00	6.00	A+	467	0.8 + 1.0 + 1.5 + 1.6
2.0 + 2.5 + 3.5 + 5.0	1035	9.9	8.00	6.00	A+	467	0.8 + 1.0 + 1.4 + 1.7
2.0 + 2.5 + 3.5 + 6.0	1035	9.9	8.00	6.00	A+	467	0.7 + 0.9 + 1.3 + 2.0
2.0 + 2.5 + 4.2 + 4.2	1060	10.1	8.00	6.00	A+	467	0.8 + 1.0 + 1.6 + 1.6
2.0 + 2.5 + 4.2 + 5.0	1035	9.9	8.00	6.00	A+	467	0.7 + 0.9 + 1.5 + 1.7
2.0 + 2.5 + 4.2 + 6.0	1035	9.9	8.00	6.00	A+	467	0.7 + 0.9 + 1.5 + 1.9
2.0 + 2.5 + 5.0 + 5.0	1045	10.0	8.00	6.00	A+	467	0.7 + 0.9 + 1.6 + 1.6
2.0 + 3.5 + 3.5 + 3.5	1060	10.1	8.00	6.00	A+	467	0.8 + 1.5 + 1.5 + 1.5
2.0 + 3.5 + 3.5 + 4.2	1060	10.1	8.00	6.00	A+	467	0.8 + 1.4 + 1.4 + 1.6
2.0 + 3.5 + 3.5 + 5.0	1035	9.9	8.00	6.00	A+	467	0.7 + 1.3 + 1.3 + 1.7

4  
Room

Indoor unit capacity Cooling	Total	Cooling Capacity (kW)						Input Power (W)		EER	
		Room A	Room B	Room C	Room D	Total	min ~ max	Rating	min ~ max	W/W	CLASS
2.0 + 3.5 + 4.2 + 4.2	13.9	1.15	2.01	2.42	2.42	8.00	3.0 ~ 9.2	2120	570 ~ 2920	3.77	A
2.0 + 3.5 + 4.2 + 5.0	14.7	1.09	1.90	2.29	2.72	8.00	3.0 ~ 9.2	2070	630 ~ 2860	3.86	A
2.0 + 4.2 + 4.2 + 4.2	14.6	1.10	2.30	2.30	2.30	8.00	3.0 ~ 9.2	2070	580 ~ 2920	3.86	A
2.5 + 2.5 + 2.5 + 2.5	10.0	2.00	2.00	2.00	2.00	8.00	3.0 ~ 9.2	2180	530 ~ 3070	3.67	A
2.5 + 2.5 + 2.5 + 3.5	11.0	1.82	1.82	1.82	2.54	8.00	3.0 ~ 9.2	2120	570 ~ 3000	3.77	A
2.5 + 2.5 + 2.5 + 4.2	11.7	1.71	1.71	1.71	2.87	8.00	3.0 ~ 9.2	2120	570 ~ 3000	3.77	A
2.5 + 2.5 + 2.5 + 5.0	12.5	1.60	1.60	1.60	3.20	8.00	3.0 ~ 9.2	2070	620 ~ 2850	3.86	A
2.5 + 2.5 + 2.5 + 6.0	13.5	1.48	1.48	1.48	3.56	8.00	3.0 ~ 9.2	2070	620 ~ 2850	3.86	A
2.5 + 2.5 + 2.5 + 7.1	14.6	1.37	1.37	1.37	3.89	8.00	3.0 ~ 9.2	2070	630 ~ 2860	3.86	A
2.5 + 2.5 + 3.5 + 3.5	12.0	1.67	1.67	2.33	2.33	8.00	3.0 ~ 9.2	2120	570 ~ 3000	3.77	A
2.5 + 2.5 + 3.5 + 4.2	12.7	1.57	1.57	2.20	2.66	8.00	3.0 ~ 9.2	2120	570 ~ 3000	3.77	A
2.5 + 2.5 + 3.5 + 5.0	13.5	1.48	1.48	2.07	2.97	8.00	3.0 ~ 9.2	2070	630 ~ 2860	3.86	A
2.5 + 2.5 + 3.5 + 6.0	14.5	1.38	1.38	1.93	3.31	8.00	3.0 ~ 9.2	2070	630 ~ 2860	3.86	A
2.5 + 2.5 + 4.2 + 4.2	13.4	1.49	1.49	2.51	2.51	8.00	3.0 ~ 9.2	2120	570 ~ 3000	3.77	A
2.5 + 2.5 + 4.2 + 5.0	14.2	1.41	1.41	2.37	2.81	8.00	3.0 ~ 9.2	2070	630 ~ 2860	3.86	A
2.5 + 3.5 + 3.5 + 3.5	13.0	1.55	2.15	2.15	2.15	8.00	3.0 ~ 9.2	2120	570 ~ 2920	3.77	A
2.5 + 3.5 + 3.5 + 4.2	13.7	1.46	2.04	2.04	2.46	8.00	3.0 ~ 9.2	2120	570 ~ 2920	3.77	A
2.5 + 3.5 + 3.5 + 5.0	14.5	1.38	1.93	1.93	2.76	8.00	3.0 ~ 9.2	2070	630 ~ 2860	3.86	A
2.5 + 3.5 + 4.2 + 4.2	14.4	1.39	1.95	2.33	2.33	8.00	3.0 ~ 9.2	2120	570 ~ 2920	3.77	A
3.5 + 3.5 + 3.5 + 3.5	14.0	2.00	2.00	2.00	2.00	8.00	3.0 ~ 9.2	2070	580 ~ 2920	3.86	A
3.5 + 3.5 + 3.5 + 4.2	14.7	1.90	1.90	1.90	2.30	8.00	3.0 ~ 9.2	2070	580 ~ 2920	3.86	A

Indoor unit capacity Cooling	Annual Energy Consumption (kWh)	Current 230V (A)	ERP				Moisture Removal Volume l/h	
			Pdesign (kW)	SEER		Annual Consumption (kWh)		
				WW	CLASS			
4 Room	2.0 + 3.5 + 4.2 + 4.2	1060	10.1	8.00	6.00	A+	467	0.7 + 1.3 + 1.5 + 1.5
	2.0 + 3.5 + 4.2 + 5.0	1035	9.9	8.00	6.00	A+	467	0.7 + 1.2 + 1.5 + 1.6
	2.0 + 4.2 + 4.2 + 4.2	1035	9.9	8.00	6.00	A+	467	0.7 + 1.5 + 1.5 + 1.5
	2.5 + 2.5 + 2.5 + 2.5	1090	10.4	8.00	6.00	A+	467	1.3 + 1.3 + 1.3 + 1.3
	2.5 + 2.5 + 2.5 + 3.5	1060	10.1	8.00	6.00	A+	467	1.2 + 1.2 + 1.2 + 1.6
	2.5 + 2.5 + 2.5 + 4.2	1060	10.1	8.00	6.00	A+	467	1.1 + 1.1 + 1.1 + 1.7
	2.5 + 2.5 + 2.5 + 5.0	1035	9.9	8.00	6.00	A+	467	1.0 + 1.0 + 1.0 + 1.8
	2.5 + 2.5 + 2.5 + 6.0	1035	9.9	8.00	6.00	A+	467	0.9 + 0.9 + 0.9 + 2.1
	2.5 + 2.5 + 2.5 + 7.1	1035	9.9	8.00	6.00	A+	467	0.9 + 0.9 + 0.9 + 2.3
	2.5 + 2.5 + 3.5 + 3.5	1060	10.1	8.00	6.00	A+	467	1.1 + 1.1 + 1.5 + 1.5
	2.5 + 2.5 + 3.5 + 4.2	1060	10.1	8.00	6.00	A+	467	1.0 + 1.0 + 1.4 + 1.6
	2.5 + 2.5 + 3.5 + 5.0	1035	9.9	8.00	6.00	A+	467	0.9 + 0.9 + 1.3 + 1.7
	2.5 + 2.5 + 3.5 + 6.0	1035	9.9	8.00	6.00	A+	467	0.9 + 0.9 + 1.2 + 1.9
	2.5 + 2.5 + 4.2 + 4.2	1060	10.1	8.00	6.00	A+	467	0.9 + 0.9 + 1.5 + 1.5
	2.5 + 2.5 + 4.2 + 5.0	1035	9.9	8.00	6.00	A+	467	0.9 + 0.9 + 1.5 + 1.6
	2.5 + 3.5 + 3.5 + 3.5	1060	10.1	8.00	6.00	A+	467	1.0 + 1.4 + 1.4 + 1.4
	2.5 + 3.5 + 3.5 + 4.2	1060	10.1	8.00	6.00	A+	467	0.9 + 1.3 + 1.3 + 1.5
	2.5 + 3.5 + 3.5 + 5.0	1035	9.9	8.00	6.00	A+	467	0.9 + 1.2 + 1.2 + 1.6
	2.5 + 3.5 + 4.2 + 4.2	1060	10.1	8.00	6.00	A+	467	0.9 + 1.3 + 1.5 + 1.5
	3.5 + 3.5 + 3.5 + 3.5	1035	9.9	8.00	6.00	A+	467	1.3 + 1.3 + 1.3 + 1.3
3.5 + 3.5 + 3.5 + 4.2	1035	9.9	8.00	6.00	A+	467	1.2 + 1.2 + 1.2 + 1.5	

- Indoor Unit : Combination of all type of wall and non-wall series (CS-MZ / Z / XZ / MTZ / TZ / TE / E)
- Outdoor Unit : CU-4Z80TBE

Indoor unit capacity Heating	Total	Heating Capacity (kW)						Input Power (W)		COP		
		Room A	Room B	Room C	Room D	Total	min ~ max	Rating	min ~ max	W/W	CLASS	
1 Room	1.6	1.6	2.60				2.60	1.2 ~ 3.2	700	300 ~ 1060	3.71	A
	2.0	2.0	3.20				3.20	1.2 ~ 4.1	840	300 ~ 1330	3.81	A
	2.5	2.5	3.60				3.60	1.2 ~ 4.3	1040	300 ~ 1330	3.46	B
	3.5	3.5	4.50				4.50	1.2 ~ 5.8	1330	300 ~ 2200	3.38	C
	4.2	4.2	5.60				5.60	1.2 ~ 6.8	1820	300 ~ 3030	3.08	D
	5.0	5.0	6.80				6.80	1.2 ~ 6.9	2200	300 ~ 2620	3.09	D
	6.0	6.0	8.50				8.50	1.3 ~ 9.0	2500	620 ~ 2650	3.40	C
	7.1	7.1	8.70				8.70	1.4 ~ 9.2	2650	680 ~ 2820	3.28	C
2 Room	1.6 + 1.6	3.2	2.60	2.60			5.20	2.2 ~ 8.2	1760	430 ~ 3040	2.95	D
	1.6 + 2.0	3.6	2.58	3.22			5.80	2.2 ~ 8.2	1880	430 ~ 3030	3.09	D
	1.6 + 2.5	4.1	2.42	3.78			6.20	2.2 ~ 8.2	2020	430 ~ 3030	3.07	D
	1.6 + 3.5	5.1	2.23	4.87			7.10	2.2 ~ 8.6	2190	380 ~ 3110	3.24	C
	1.6 + 4.2	5.8	2.26	5.94			8.20	2.2 ~ 9.8	2570	370 ~ 3640	3.19	D
	1.6 + 5.0	6.6	2.28	7.12			9.40	2.2 ~ 10.0	2660	330 ~ 3450	3.53	B
	1.6 + 6.0	7.6	1.98	7.42			9.40	2.2 ~ 10.0	2660	330 ~ 3450	3.53	B
	1.6 + 7.1	8.7	1.73	7.67			9.40	2.2 ~ 10.3	2600	320 ~ 3620	3.62	A
	2.0 + 2.0	4.0	3.20	3.20			6.40	2.2 ~ 8.2	2060	390 ~ 3020	3.11	D
	2.0 + 2.5	4.5	3.02	3.78			6.80	2.2 ~ 8.2	2120	390 ~ 3020	3.21	C
	2.0 + 3.5	5.5	2.80	4.90			7.70	2.2 ~ 8.6	2370	370 ~ 3050	3.25	C
	2.0 + 4.2	6.2	2.84	5.96			8.80	2.2 ~ 10.0	2620	370 ~ 3750	3.36	C
	2.0 + 5.0	7.0	2.69	6.71			9.40	2.2 ~ 10.0	2650	320 ~ 3430	3.55	B
	2.0 + 6.0	8.0	2.35	7.05			9.40	2.2 ~ 10.0	2650	320 ~ 3430	3.55	B
	2.0 + 7.1	9.1	2.07	7.33			9.40	2.2 ~ 10.3	2590	320 ~ 3600	3.63	A
	2.5 + 2.5	5.0	3.60	3.60			7.20	2.2 ~ 8.6	2250	390 ~ 3130	3.20	D
	2.5 + 3.5	6.0	3.37	4.73			8.10	2.2 ~ 9.8	2520	370 ~ 3640	3.21	C
	2.5 + 4.2	6.7	3.43	5.77			9.20	2.2 ~ 10.0	2770	370 ~ 3750	3.32	C
	2.5 + 5.0	7.5	3.13	6.27			9.40	2.2 ~ 10.0	2650	320 ~ 3430	3.55	B
	2.5 + 6.0	8.5	2.76	6.64			9.40	2.2 ~ 10.0	2650	320 ~ 3430	3.55	B
	2.5 + 7.1	9.6	2.45	6.95			9.40	2.2 ~ 10.3	2590	320 ~ 3600	3.63	A
	3.5 + 3.5	7.0	4.50	4.50			9.00	2.2 ~ 10.0	2650	360 ~ 3670	3.40	C
	3.5 + 4.2	7.7	4.27	5.13			9.40	2.2 ~ 10.0	2790	350 ~ 3660	3.37	C
	3.5 + 5.0	8.5	3.87	5.53			9.40	2.2 ~ 10.0	2580	320 ~ 3400	3.64	A
	3.5 + 6.0	9.5	3.46	5.94			9.40	2.2 ~ 10.3	2580	320 ~ 3520	3.64	A
	3.5 + 7.1	10.6	3.10	6.30			9.40	2.2 ~ 10.5	2560	310 ~ 3630	3.67	A
	4.2 + 4.2	8.4	4.70	4.70			9.40	2.2 ~ 10.0	2780	350 ~ 3650	3.38	C
4.2 + 5.0	9.2	4.29	5.11			9.40	2.2 ~ 10.3	2560	320 ~ 3510	3.67	A	
4.2 + 6.0	10.2	3.87	5.53			9.40	2.2 ~ 10.3	2560	320 ~ 3510	3.67	A	
4.2 + 7.1	11.3	3.49	5.91			9.40	2.2 ~ 10.5	2550	310 ~ 3620	3.69	A	
5.0 + 5.0	10.0	4.70	4.70			9.40	2.2 ~ 10.3	2400	310 ~ 3290	3.92	A	
5.0 + 6.0	11.0	4.27	5.13			9.40	2.2 ~ 10.5	2400	310 ~ 3350	3.92	A	
5.0 + 7.1	12.1	3.88	5.52			9.40	2.2 ~ 10.5	2380	310 ~ 3330	3.95	A	
6.0 + 6.0	12.0	4.70	4.70			9.40	2.2 ~ 10.5	2400	310 ~ 3350	3.92	A	
6.0 + 7.1	13.1	4.31	5.09			9.40	2.2 ~ 10.5	2380	310 ~ 3330	3.95	A	
7.1 + 7.1	14.2	4.70	4.70			9.40	2.2 ~ 10.5	2370	320 ~ 3320	3.97	A	



	Indoor unit capacity Heating	Annual Energy Consumption (kWh)	Current 230V (A)	ERP				Moisture Removal Volume l/h
				Pdesign (kW)	SCOP		Annual Consumption (kWh)	
					WW	CLASS		
1 Room	1.6	350	3.3	-	-	-	-	
	2.0	420	4.1	-	-	-	-	
	2.5	520	5.1	-	-	-	-	
	3.5	665	6.5	-	-	-	-	
	4.2	910	8.4	-	-	-	-	
	5.0	1100	10.1	-	-	-	-	
	6.0	1250	11.5	-	-	-	-	
	7.1	1325	12.2	-	-	-	-	
2 Room	1.6 + 1.6	880	8.3	2.80	3.80	A	1032	
	1.6 + 2.0	940	8.8	2.80	3.80	A	1032	
	1.6 + 2.5	1010	9.5	2.80	3.80	A	1032	
	1.6 + 3.5	1095	10.3	3.80	3.80	A	1400	
	1.6 + 4.2	1285	12.1	3.80	3.80	A	1400	
	1.6 + 5.0	1330	12.5	4.80	3.80	A	1768	
	1.6 + 6.0	1330	12.5	4.80	3.80	A	1768	
	1.6 + 7.1	1300	12.2	4.80	3.80	A	1768	
	2.0 + 2.0	1030	9.7	2.80	3.80	A	1032	
	2.0 + 2.5	1060	10.0	2.80	3.80	A	1032	
	2.0 + 3.5	1185	11.1	3.80	3.80	A	1400	
	2.0 + 4.2	1310	12.3	3.80	3.80	A	1400	
	2.0 + 5.0	1325	12.5	4.80	3.80	A	1768	
	2.0 + 6.0	1325	12.5	4.80	3.80	A	1768	
	2.0 + 7.1	1295	12.2	4.80	3.80	A	1768	
	2.5 + 2.5	1125	10.6	2.80	3.80	A	1032	
	2.5 + 3.5	1260	11.8	3.80	3.80	A	1400	
	2.5 + 4.2	1385	13.0	3.80	3.80	A	1400	
	2.5 + 5.0	1325	12.5	4.80	3.80	A	1768	
	2.5 + 6.0	1325	12.5	4.80	3.80	A	1768	
	2.5 + 7.1	1295	12.2	4.80	3.80	A	1768	
	3.5 + 3.5	1325	12.5	3.80	3.80	A	1400	
	3.5 + 4.2	1395	13.1	3.80	3.80	A	1400	
	3.5 + 5.0	1290	12.1	4.80	3.80	A	1768	
	3.5 + 6.0	1290	12.1	4.80	3.80	A	1768	
	3.5 + 7.1	1280	12.0	4.80	3.80	A	1768	
	4.2 + 4.2	1390	13.1	3.80	3.80	A	1400	
	4.2 + 5.0	1280	12.0	4.80	3.80	A	1768	
	4.2 + 6.0	1280	12.0	4.80	3.80	A	1768	
	4.2 + 7.1	1275	12.0	4.80	3.80	A	1768	
5.0 + 5.0	1200	11.3	6.10	3.80	A	2247		
5.0 + 6.0	1200	11.3	6.10	3.80	A	2247		
5.0 + 7.1	1190	11.2	6.10	3.80	A	2247		
6.0 + 6.0	1200	11.3	6.10	3.80	A	2247		
6.0 + 7.1	1190	11.2	6.10	3.80	A	2247		
7.1 + 7.1	1185	11.1	6.10	3.80	A	2247		

Indoor unit capacity Heating	Total	Heating Capacity (kW)					Input Power (W)		COP		
		Room A	Room B	Room C	Room D	Total	min ~ max	Rating	min ~ max	W/W	CLASS
1.6 + 1.6 + 1.6	4.8	2.60	2.60	2.60		7.80	3.2 ~ 10.4	2180	500 ~ 3640	3.58	B
1.6 + 1.6 + 2.0	5.2	2.58	2.58	3.24		8.40	3.2 ~ 10.4	2410	500 ~ 3560	3.49	B
1.6 + 1.6 + 2.5	5.7	2.47	2.47	3.86		8.80	3.2 ~ 10.4	2390	500 ~ 3560	3.68	A
1.6 + 1.6 + 3.5	6.7	2.24	2.24	4.92		9.40	3.2 ~ 10.4	2550	490 ~ 3530	3.69	A
1.6 + 1.6 + 4.2	7.4	2.03	2.03	5.34		9.40	3.2 ~ 10.4	2540	490 ~ 3510	3.70	A
1.6 + 1.6 + 5.0	8.2	1.83	1.83	5.74		9.40	3.2 ~ 10.4	2430	480 ~ 3300	3.87	A
1.6 + 1.6 + 6.0	9.2	1.63	1.63	6.14		9.40	3.2 ~ 10.5	2430	480 ~ 3360	3.87	A
1.6 + 1.6 + 7.1	10.3	1.46	1.46	6.48		9.40	3.2 ~ 10.5	2420	510 ~ 3340	3.88	A
1.6 + 2.0 + 2.0	5.6	2.58	3.21	3.21		9.00	3.2 ~ 10.4	2430	490 ~ 3550	3.70	A
1.6 + 2.0 + 2.5	6.1	2.47	3.08	3.85		9.40	3.2 ~ 10.4	2570	490 ~ 3550	3.66	A
1.6 + 2.0 + 3.5	7.1	2.12	2.65	4.63		9.40	3.2 ~ 10.4	2540	490 ~ 3510	3.70	A
1.6 + 2.0 + 4.2	7.8	1.93	2.41	5.06		9.40	3.2 ~ 10.4	2530	490 ~ 3500	3.72	A
1.6 + 2.0 + 5.0	8.6	1.75	2.19	5.46		9.40	3.2 ~ 10.5	2420	510 ~ 3350	3.88	A
1.6 + 2.0 + 6.0	9.6	1.57	1.96	5.87		9.40	3.2 ~ 10.5	2420	510 ~ 3350	3.88	A
1.6 + 2.0 + 7.1	10.7	1.41	1.76	6.23		9.40	3.2 ~ 10.5	2410	510 ~ 3330	3.90	A
1.6 + 2.5 + 2.5	6.6	2.28	3.56	3.56		9.40	3.2 ~ 10.4	2570	490 ~ 3550	3.66	A
1.6 + 2.5 + 3.5	7.6	1.98	3.09	4.33		9.40	3.2 ~ 10.4	2540	490 ~ 3510	3.70	A
1.6 + 2.5 + 4.2	8.3	1.81	2.83	4.76		9.40	3.2 ~ 10.4	2530	490 ~ 3500	3.72	A
1.6 + 2.5 + 5.0	9.1	1.65	2.58	5.17		9.40	3.2 ~ 10.5	2420	510 ~ 3350	3.88	A
1.6 + 2.5 + 6.0	10.1	1.49	2.33	5.58		9.40	3.2 ~ 10.5	2420	510 ~ 3350	3.88	A
1.6 + 2.5 + 7.1	11.2	1.34	2.10	5.96		9.40	3.2 ~ 10.6	2410	510 ~ 3390	3.90	A
1.6 + 3.5 + 3.5	8.6	1.74	3.83	3.83		9.40	3.2 ~ 10.5	2510	480 ~ 3540	3.75	A
1.6 + 3.5 + 4.2	9.3	1.62	3.54	4.24		9.40	3.2 ~ 10.5	2500	480 ~ 3460	3.76	A
1.6 + 3.5 + 5.0	10.1	1.49	3.26	4.65		9.40	3.2 ~ 10.5	2390	510 ~ 3310	3.93	A
1.6 + 3.5 + 6.0	11.1	1.35	2.96	5.09		9.40	3.2 ~ 10.6	2390	510 ~ 3370	3.93	A
1.6 + 3.5 + 7.1	12.2	1.23	2.70	5.47		9.40	3.2 ~ 10.6	2380	510 ~ 3360	3.95	A
1.6 + 4.2 + 4.2	10.0	1.50	3.95	3.95		9.40	3.2 ~ 10.5	2490	480 ~ 3450	3.78	A
1.6 + 4.2 + 5.0	10.8	1.39	3.66	4.35		9.40	3.2 ~ 10.5	2390	510 ~ 3300	3.93	A
1.6 + 4.2 + 6.0	11.8	1.27	3.35	4.78		9.40	3.2 ~ 10.6	2390	510 ~ 3360	3.93	A
1.6 + 4.2 + 7.1	12.9	1.17	3.06	5.17		9.40	3.2 ~ 10.6	2370	510 ~ 3340	3.97	A
1.6 + 5.0 + 5.0	11.6	1.30	4.05	4.05		9.40	3.2 ~ 10.6	2300	570 ~ 3230	4.09	A
1.6 + 5.0 + 6.0	12.6	1.19	3.73	4.48		9.40	3.2 ~ 10.6	2300	570 ~ 3230	4.09	A
1.6 + 5.0 + 7.1	13.7	1.10	3.43	4.87		9.40	3.2 ~ 10.6	2290	590 ~ 3220	4.10	A
1.6 + 6.0 + 6.0	13.6	1.10	4.15	4.15		9.40	3.2 ~ 10.6	2300	570 ~ 3230	4.09	A
1.6 + 6.0 + 7.1	14.7	1.02	3.84	4.54		9.40	3.2 ~ 10.6	2290	590 ~ 3220	4.10	A
2.0 + 2.0 + 2.0	6.0	3.13	3.13	3.13		9.39	3.2 ~ 10.4	2560	490 ~ 3540	3.67	A
2.0 + 2.0 + 2.5	6.5	2.89	2.89	3.62		9.40	3.2 ~ 10.4	2560	490 ~ 3540	3.67	A
2.0 + 2.0 + 3.5	7.5	2.51	2.51	4.38		9.40	3.2 ~ 10.4	2530	490 ~ 3500	3.72	A
2.0 + 2.0 + 4.2	8.2	2.29	2.29	4.82		9.40	3.2 ~ 10.4	2520	480 ~ 3490	3.73	A
2.0 + 2.0 + 5.0	9.0	2.09	2.09	5.22		9.40	3.2 ~ 10.5	2410	510 ~ 3330	3.90	A
2.0 + 2.0 + 6.0	10.0	1.88	1.88	5.64		9.40	3.2 ~ 10.5	2410	510 ~ 3330	3.90	A
2.0 + 2.0 + 7.1	11.1	1.69	1.69	6.02		9.40	3.2 ~ 10.6	2400	510 ~ 3380	3.92	A
2.0 + 2.5 + 2.5	7.0	2.68	3.36	3.36		9.40	3.2 ~ 10.4	2560	490 ~ 3540	3.67	A
2.0 + 2.5 + 3.5	8.0	2.35	2.94	4.11		9.40	3.2 ~ 10.4	2530	490 ~ 3500	3.72	A
2.0 + 2.5 + 4.2	8.7	2.16	2.70	4.54		9.40	3.2 ~ 10.5	2520	480 ~ 3550	3.73	A
2.0 + 2.5 + 5.0	9.5	1.98	2.47	4.95		9.40	3.2 ~ 10.5	2410	510 ~ 3330	3.90	A
2.0 + 2.5 + 6.0	10.5	1.79	2.24	5.37		9.40	3.2 ~ 10.5	2410	510 ~ 3330	3.90	A
2.0 + 2.5 + 7.1	11.6	1.62	2.03	5.75		9.40	3.2 ~ 10.6	2400	510 ~ 3380	3.92	A
2.0 + 3.5 + 3.5	9.0	2.08	3.66	3.66		9.40	3.2 ~ 10.5	2500	480 ~ 3460	3.76	A
2.0 + 3.5 + 4.2	9.7	1.94	3.39	4.07		9.40	3.2 ~ 10.5	2490	480 ~ 3450	3.78	A
2.0 + 3.5 + 5.0	10.5	1.79	3.13	4.48		9.40	3.2 ~ 10.5	2390	510 ~ 3300	3.93	A
2.0 + 3.5 + 6.0	11.5	1.63	2.86	4.91		9.40	3.2 ~ 10.6	2390	510 ~ 3360	3.93	A
2.0 + 3.5 + 7.1	12.6	1.49	2.61	5.30		9.40	3.2 ~ 10.6	2370	510 ~ 3340	3.97	A
2.0 + 4.2 + 4.2	10.4	1.80	3.80	3.80		9.40	3.2 ~ 10.5	2480	480 ~ 3440	3.79	A
2.0 + 4.2 + 5.0	11.2	1.68	3.53	4.19		9.40	3.2 ~ 10.6	2380	510 ~ 3350	3.95	A
2.0 + 4.2 + 6.0	12.2	1.54	3.24	4.62		9.40	3.2 ~ 10.6	2380	510 ~ 3350	3.95	A
2.0 + 4.2 + 7.1	13.3	1.41	2.97	5.02		9.40	3.2 ~ 10.6	2370	520 ~ 3330	3.97	A
2.0 + 5.0 + 5.0	12.0	1.56	3.92	3.92		9.40	3.2 ~ 10.6	2290	590 ~ 3220	4.10	A

3  
Room

Indoor unit capacity Heating	Annual Energy Consumption (kWh)	Current 230V (A)	ERP				Moisture Removal Volume l/h
			Pdesign (kW)	SCOP		Annual Consumption (kWh)	
				W/W	CLASS		
1.6 + 1.6 + 1.6	1090	10.2	4.30	3.80	A	1584	
1.6 + 1.6 + 2.0	1205	11.3	4.30	3.80	A	1584	
1.6 + 1.6 + 2.5	1195	11.2	4.30	3.80	A	1584	
1.6 + 1.6 + 3.5	1275	12.0	5.30	3.80	A	1953	
1.6 + 1.6 + 4.2	1270	11.9	5.30	3.80	A	1953	
1.6 + 1.6 + 5.0	1215	11.4	6.10	3.80	A	2247	
1.6 + 1.6 + 6.0	1215	11.4	6.10	3.80	A	2247	
1.6 + 1.6 + 7.1	1210	11.4	6.10	3.80	A	2247	
1.6 + 2.0 + 2.0	1215	11.4	4.30	3.80	A	1584	
1.6 + 2.0 + 2.5	1285	12.1	5.30	3.80	A	1953	
1.6 + 2.0 + 3.5	1270	11.9	5.30	3.80	A	1953	
1.6 + 2.0 + 4.2	1265	11.9	5.30	3.80	A	1953	
1.6 + 2.0 + 5.0	1210	11.4	6.10	3.80	A	2247	
1.6 + 2.0 + 6.0	1210	11.4	6.10	3.80	A	2247	
1.6 + 2.0 + 7.1	1205	11.3	6.10	3.80	A	2247	
1.6 + 2.5 + 2.5	1285	12.1	5.30	3.80	A	1953	
1.6 + 2.5 + 3.5	1270	11.9	5.30	3.80	A	1953	
1.6 + 2.5 + 4.2	1265	11.9	6.10	3.80	A	2247	
1.6 + 2.5 + 5.0	1210	11.4	6.10	3.80	A	2247	
1.6 + 2.5 + 6.0	1210	11.4	6.10	3.80	A	2247	
1.6 + 2.5 + 7.1	1205	11.3	6.10	3.80	A	2247	
1.6 + 3.5 + 3.5	1255	11.8	6.10	3.80	A	2247	
1.6 + 3.5 + 4.2	1250	11.7	6.10	3.80	A	2247	
1.6 + 3.5 + 5.0	1195	11.2	6.10	3.80	A	2247	
1.6 + 3.5 + 6.0	1195	11.2	6.10	3.80	A	2247	
1.6 + 3.5 + 7.1	1190	11.2	6.10	3.80	A	2247	
1.6 + 4.2 + 4.2	1245	11.7	6.10	3.80	A	2247	
1.6 + 4.2 + 5.0	1195	11.2	6.10	3.80	A	2247	
1.6 + 4.2 + 6.0	1195	11.2	6.10	3.80	A	2247	
1.6 + 4.2 + 7.1	1185	11.1	6.10	3.80	A	2247	
1.6 + 5.0 + 5.0	1150	10.8	6.10	3.80	A	2247	
1.6 + 5.0 + 6.0	1150	10.8	6.10	3.80	A	2247	
1.6 + 5.0 + 7.1	1145	10.8	6.10	3.80	A	2247	
1.6 + 6.0 + 6.0	1150	10.8	6.10	3.80	A	2247	
1.6 + 6.0 + 7.1	1145	10.8	6.10	3.80	A	2247	
2.0 + 2.0 + 2.0	1280	12.0	5.30	3.80	A	1953	
2.0 + 2.0 + 2.5	1280	12.0	5.30	3.80	A	1953	
2.0 + 2.0 + 3.5	1265	11.9	5.30	3.80	A	1953	
2.0 + 2.0 + 4.2	1260	11.8	6.10	3.80	A	2247	
2.0 + 2.0 + 5.0	1205	11.3	6.10	3.80	A	2247	
2.0 + 2.0 + 6.0	1205	11.3	6.10	3.80	A	2247	
2.0 + 2.0 + 7.1	1200	11.3	6.10	3.80	A	2247	
2.0 + 2.5 + 2.5	1280	12.0	5.30	3.80	A	1953	
2.0 + 2.5 + 3.5	1265	11.9	6.10	3.80	A	2247	
2.0 + 2.5 + 4.2	1260	11.8	6.10	3.80	A	2247	
2.0 + 2.5 + 5.0	1205	11.3	6.10	3.80	A	2247	
2.0 + 2.5 + 6.0	1205	11.3	6.10	3.80	A	2247	
2.0 + 2.5 + 7.1	1200	11.3	6.10	3.80	A	2247	
2.0 + 3.5 + 3.5	1250	11.7	6.10	3.80	A	2247	
2.0 + 3.5 + 4.2	1245	11.7	6.10	3.80	A	2247	
2.0 + 3.5 + 5.0	1195	11.2	6.10	3.80	A	2247	
2.0 + 3.5 + 6.0	1195	11.2	6.10	3.80	A	2247	
2.0 + 3.5 + 7.1	1185	11.1	6.10	3.80	A	2247	
2.0 + 4.2 + 4.2	1240	11.7	6.10	3.80	A	2247	
2.0 + 4.2 + 5.0	1190	11.2	6.10	3.80	A	2247	
2.0 + 4.2 + 6.0	1190	11.2	6.10	3.80	A	2247	
2.0 + 4.2 + 7.1	1185	11.1	6.10	3.80	A	2247	
2.0 + 5.0 + 5.0	1145	10.8	6.10	3.80	A	2247	

3 Room

Indoor unit capacity Heating	Total	Heating Capacity (kW)						Input Power (W)		COP	
		Room A	Room B	Room C	Room D	Total	min ~ max	Rating	min ~ max	W/W	CLASS
2.0 + 5.0 + 6.0	13.0	1.45	3.62	4.33		9.40	3.2 ~ 10.6	2290	590 ~ 3220	4.10	A
2.0 + 5.0 + 7.1	14.1	1.33	3.33	4.74		9.40	3.2 ~ 10.6	2280	600 ~ 3210	4.12	A
2.0 + 6.0 + 6.0	14.0	1.34	4.03	4.03		9.40	3.2 ~ 10.6	2290	590 ~ 3220	4.10	A
2.5 + 2.5 + 2.5	7.5	3.13	3.13	3.13		9.39	3.2 ~ 10.4	2560	490 ~ 3540	3.67	A
2.5 + 2.5 + 3.5	8.5	2.76	2.76	3.88		9.40	3.2 ~ 10.4	2530	490 ~ 3500	3.72	A
2.5 + 2.5 + 4.2	9.2	2.55	2.55	4.30		9.40	3.2 ~ 10.5	2520	480 ~ 3550	3.73	A
2.5 + 2.5 + 5.0	10.0	2.35	2.35	4.70		9.40	3.2 ~ 10.5	2410	510 ~ 3330	3.90	A
2.5 + 2.5 + 6.0	11.0	2.14	2.14	5.12		9.40	3.2 ~ 10.5	2410	510 ~ 3330	3.90	A
2.5 + 2.5 + 7.1	12.1	1.94	1.94	5.52		9.40	3.2 ~ 10.6	2400	510 ~ 3380	3.92	A
2.5 + 3.5 + 3.5	9.5	2.48	3.46	3.46		9.40	3.2 ~ 10.5	2500	480 ~ 3460	3.76	A
2.5 + 3.5 + 4.2	10.2	2.30	3.23	3.87		9.40	3.2 ~ 10.5	2490	480 ~ 3450	3.78	A
2.5 + 3.5 + 5.0	11.0	2.14	2.99	4.27		9.40	3.2 ~ 10.5	2390	510 ~ 3300	3.93	A
2.5 + 3.5 + 6.0	12.0	1.96	2.74	4.70		9.40	3.2 ~ 10.6	2390	510 ~ 3360	3.93	A
2.5 + 3.5 + 7.1	13.1	1.79	2.51	5.10		9.40	3.2 ~ 10.6	2370	510 ~ 3340	3.97	A
2.5 + 4.2 + 4.2	10.9	2.16	3.62	3.62		9.40	3.2 ~ 10.5	2480	480 ~ 3440	3.79	A
2.5 + 4.2 + 5.0	11.7	2.01	3.37	4.02		9.40	3.2 ~ 10.6	2380	510 ~ 3350	3.95	A
2.5 + 4.2 + 6.0	12.7	1.85	3.11	4.44		9.40	3.2 ~ 10.6	2380	510 ~ 3350	3.95	A
2.5 + 4.2 + 7.1	13.8	1.70	2.86	4.84		9.40	3.2 ~ 10.6	2370	520 ~ 3330	3.97	A
2.5 + 5.0 + 5.0	12.5	1.88	3.76	3.76		9.40	3.2 ~ 10.6	2290	590 ~ 3220	4.10	A
2.5 + 5.0 + 6.0	13.5	1.74	3.48	4.18		9.40	3.2 ~ 10.6	2290	590 ~ 3220	4.10	A
2.5 + 5.0 + 7.1	14.6	1.61	3.22	4.57		9.40	3.2 ~ 10.6	2280	600 ~ 3210	4.12	A
2.5 + 6.0 + 6.0	14.5	1.62	3.89	3.89		9.40	3.2 ~ 10.6	2290	590 ~ 3220	4.10	A
3.5 + 3.5 + 3.5	10.5	3.13	3.13	3.13		9.39	3.2 ~ 10.5	2480	480 ~ 3430	3.79	A
3.5 + 3.5 + 4.2	11.2	2.94	2.94	3.52		9.40	3.2 ~ 10.6	2470	480 ~ 3470	3.81	A
3.5 + 3.5 + 5.0	12.0	2.74	2.74	3.92		9.40	3.2 ~ 10.6	2360	520 ~ 3330	3.98	A
3.5 + 3.5 + 6.0	13.0	2.53	2.53	4.34		9.40	3.2 ~ 10.6	2360	520 ~ 3330	3.98	A
3.5 + 3.5 + 7.1	14.1	2.33	2.33	4.74		9.40	3.2 ~ 10.6	2350	520 ~ 3310	4.00	A
3.5 + 4.2 + 4.2	11.9	2.76	3.32	3.32		9.40	3.2 ~ 10.6	2460	480 ~ 3460	3.82	A
3.5 + 4.2 + 5.0	12.7	2.59	3.11	3.70		9.40	3.2 ~ 10.6	2350	520 ~ 3320	4.00	A
3.5 + 4.2 + 6.0	13.7	2.40	2.88	4.12		9.40	3.2 ~ 10.6	2350	520 ~ 3320	4.00	A
3.5 + 5.0 + 5.0	13.5	2.44	3.48	3.48		9.40	3.2 ~ 10.6	2270	600 ~ 3190	4.14	A
3.5 + 5.0 + 6.0	14.5	2.27	3.24	3.89		9.40	3.2 ~ 10.6	2270	600 ~ 3190	4.14	A
4.2 + 4.2 + 4.2	12.6	3.13	3.13	3.13		9.39	3.2 ~ 10.6	2450	480 ~ 3450	3.83	A
4.2 + 4.2 + 5.0	13.4	2.95	2.95	3.50		9.40	3.2 ~ 10.6	2350	540 ~ 3300	4.00	A
4.2 + 4.2 + 6.0	14.4	2.74	2.74	3.92		9.40	3.2 ~ 10.6	2350	540 ~ 3300	4.00	A
4.2 + 5.0 + 5.0	14.2	2.78	3.31	3.31		9.40	3.2 ~ 10.6	2270	610 ~ 3180	4.14	A

3  
Room

	Indoor unit capacity Heating	Annual Energy Consumption (kWh)	Current 230V (A)	ERP				Moisture Removal Volume l/h
				Pdesign (kW)	SCOP		Annual Consumption (kWh)	
					W/W	CLASS		
3 Room	2.0 + 5.0 + 6.0	1145	10.8	6.10	3.80	A	2247	
	2.0 + 5.0 + 7.1	1140	10.7	6.10	3.80	A	2247	
	2.0 + 6.0 + 6.0	1145	10.8	6.10	3.80	A	2247	
	2.5 + 2.5 + 2.5	1280	12.0	5.30	3.80	A	1953	
	2.5 + 2.5 + 3.5	1265	11.9	6.10	3.80	A	2247	
	2.5 + 2.5 + 4.2	1260	11.8	6.10	3.80	A	2247	
	2.5 + 2.5 + 5.0	1205	11.3	6.10	3.80	A	2247	
	2.5 + 2.5 + 6.0	1205	11.3	6.10	3.80	A	2247	
	2.5 + 2.5 + 7.1	1200	11.3	6.10	3.80	A	2247	
	2.5 + 3.5 + 3.5	1250	11.7	6.10	3.80	A	2247	
	2.5 + 3.5 + 4.2	1245	11.7	6.10	3.80	A	2247	
	2.5 + 3.5 + 5.0	1195	11.2	6.10	3.80	A	2247	
	2.5 + 3.5 + 6.0	1195	11.2	6.10	3.80	A	2247	
	2.5 + 3.5 + 7.1	1185	11.1	6.10	3.80	A	2247	
	2.5 + 4.2 + 4.2	1240	11.7	6.10	3.80	A	2247	
	2.5 + 4.2 + 5.0	1190	11.2	6.10	3.80	A	2247	
	2.5 + 4.2 + 6.0	1190	11.2	6.10	3.80	A	2247	
	2.5 + 4.2 + 7.1	1185	11.1	6.10	3.80	A	2247	
	2.5 + 5.0 + 5.0	1145	10.8	6.10	3.80	A	2247	
	2.5 + 5.0 + 6.0	1145	10.8	6.10	3.80	A	2247	
	2.5 + 5.0 + 7.1	1140	10.7	6.10	3.80	A	2247	
	2.5 + 6.0 + 6.0	1145	10.8	6.10	3.80	A	2247	
	3.5 + 3.5 + 3.5	1240	11.7	6.10	3.80	A	2247	
	3.5 + 3.5 + 4.2	1235	11.6	6.10	3.80	A	2247	
	3.5 + 3.5 + 5.0	1180	11.1	6.10	3.80	A	2247	
	3.5 + 3.5 + 6.0	1180	11.1	6.10	3.80	A	2247	
	3.5 + 3.5 + 7.1	1175	11.0	6.10	3.80	A	2247	
	3.5 + 4.2 + 4.2	1230	11.6	6.10	3.80	A	2247	
	3.5 + 4.2 + 5.0	1175	11.0	6.10	3.80	A	2247	
	3.5 + 4.2 + 6.0	1175	11.0	6.10	3.80	A	2247	
3.5 + 5.0 + 5.0	1135	10.7	6.10	3.80	A	2247		
3.5 + 5.0 + 6.0	1135	10.7	6.10	3.80	A	2247		
4.2 + 4.2 + 4.2	1225	11.5	6.10	3.80	A	2247		
4.2 + 4.2 + 5.0	1175	11.0	6.10	3.80	A	2247		
4.2 + 4.2 + 6.0	1175	11.0	6.10	3.80	A	2247		
4.2 + 5.0 + 5.0	1135	10.7	6.10	3.80	A	2247		

Indoor unit capacity Heating	Total	Heating Capacity (kW)					Input Power (W)		COP		
		Room A	Room B	Room C	Room D	Total	min ~ max	Rating	min ~ max	W/W	CLASS
1.6 + 1.6 + 1.6 + 1.6	6.4	2.35	2.35	2.35	2.35	9.40	4.2 ~ 10.6	2470	680 ~ 3430	3.81	A
1.6 + 1.6 + 1.6 + 2.0	6.8	2.21	2.21	2.21	2.77	9.40	4.2 ~ 10.6	2460	680 ~ 3420	3.82	A
1.6 + 1.6 + 1.6 + 2.5	7.3	2.06	2.06	2.06	3.22	9.40	4.2 ~ 10.6	2460	680 ~ 3420	3.82	A
1.6 + 1.6 + 1.6 + 3.5	8.3	1.81	1.81	1.81	3.97	9.40	4.2 ~ 10.6	2440	690 ~ 3390	3.85	A
1.6 + 1.6 + 1.6 + 4.2	9.0	1.67	1.67	1.67	4.39	9.40	4.2 ~ 10.6	2430	690 ~ 3380	3.87	A
1.6 + 1.6 + 1.6 + 5.0	9.8	1.53	1.53	1.53	4.81	9.40	4.2 ~ 10.6	2400	760 ~ 3260	3.92	A
1.6 + 1.6 + 1.6 + 6.0	10.8	1.39	1.39	1.39	5.23	9.40	4.2 ~ 10.6	2400	760 ~ 3260	3.92	A
1.6 + 1.6 + 1.6 + 7.1	11.9	1.26	1.26	1.26	5.62	9.40	4.2 ~ 10.6	2390	770 ~ 3250	3.93	A
1.6 + 1.6 + 2.0 + 2.0	7.2	2.09	2.09	2.61	2.61	9.40	4.2 ~ 10.6	2450	680 ~ 3410	3.84	A
1.6 + 1.6 + 2.0 + 2.5	7.7	1.95	1.95	2.44	3.06	9.40	4.2 ~ 10.6	2450	680 ~ 3410	3.84	A
1.6 + 1.6 + 2.0 + 3.5	8.7	1.73	1.73	2.16	3.78	9.40	4.2 ~ 10.6	2430	690 ~ 3380	3.87	A
1.6 + 1.6 + 2.0 + 4.2	9.4	1.60	1.60	2.00	4.20	9.40	4.2 ~ 10.6	2420	710 ~ 3370	3.88	A
1.6 + 1.6 + 2.0 + 5.0	10.2	1.47	1.47	1.84	4.62	9.40	4.2 ~ 10.6	2390	770 ~ 3250	3.93	A
1.6 + 1.6 + 2.0 + 6.0	11.2	1.34	1.34	1.68	5.04	9.40	4.2 ~ 10.6	2390	770 ~ 3250	3.93	A
1.6 + 1.6 + 2.0 + 7.1	12.3	1.22	1.22	1.53	5.43	9.40	4.2 ~ 10.6	2380	790 ~ 3300	3.95	A
1.6 + 1.6 + 2.5 + 2.5	8.2	1.83	1.83	2.87	2.87	9.40	4.2 ~ 10.6	2450	680 ~ 3410	3.84	A
1.6 + 1.6 + 2.5 + 3.5	9.2	1.63	1.63	2.55	3.59	9.40	4.2 ~ 10.6	2430	690 ~ 3380	3.87	A
1.6 + 1.6 + 2.5 + 4.2	9.9	1.52	1.52	2.37	3.99	9.40	4.2 ~ 10.6	2420	710 ~ 3370	3.88	A
1.6 + 1.6 + 2.5 + 5.0	10.7	1.41	1.41	2.20	4.38	9.40	4.2 ~ 10.6	2390	770 ~ 3250	3.93	A
1.6 + 1.6 + 2.5 + 6.0	11.7	1.29	1.29	2.01	4.81	9.40	4.2 ~ 10.6	2390	770 ~ 3250	3.93	A
1.6 + 1.6 + 2.5 + 7.1	12.8	1.18	1.18	1.84	5.20	9.40	4.2 ~ 10.6	2380	790 ~ 3300	3.95	A
1.6 + 1.6 + 3.5 + 3.5	10.2	1.47	1.47	3.23	3.23	9.40	4.2 ~ 10.6	2410	720 ~ 3350	3.90	A
1.6 + 1.6 + 3.5 + 4.2	10.9	1.38	1.38	3.02	3.62	9.40	4.2 ~ 10.6	2400	720 ~ 3340	3.92	A
1.6 + 1.6 + 3.5 + 5.0	11.7	1.29	1.29	2.81	4.01	9.40	4.2 ~ 10.6	2380	800 ~ 3290	3.95	A
1.6 + 1.6 + 3.5 + 6.0	12.7	1.18	1.18	2.59	4.45	9.40	4.2 ~ 10.6	2380	800 ~ 3290	3.95	A
1.6 + 1.6 + 3.5 + 7.1	13.8	1.09	1.09	2.38	4.84	9.40	4.2 ~ 10.6	2370	800 ~ 3270	3.97	A
1.6 + 1.6 + 4.2 + 4.2	11.6	1.30	1.30	3.40	3.40	9.40	4.2 ~ 10.6	2400	720 ~ 3330	3.92	A
1.6 + 1.6 + 4.2 + 5.0	12.4	1.21	1.21	3.18	3.80	9.40	4.2 ~ 10.6	2370	800 ~ 3280	3.97	A
1.6 + 1.6 + 4.2 + 6.0	13.4	1.12	1.12	2.95	4.21	9.40	4.2 ~ 10.6	2370	800 ~ 3280	3.97	A
1.6 + 1.6 + 4.2 + 7.1	14.5	1.04	1.04	2.72	4.60	9.40	4.2 ~ 10.6	2370	810 ~ 3270	3.97	A
1.6 + 1.6 + 5.0 + 5.0	13.2	1.14	1.14	3.56	3.56	9.40	4.2 ~ 10.6	2410	920 ~ 3250	3.90	A
1.6 + 1.6 + 5.0 + 6.0	14.2	1.06	1.06	3.31	3.97	9.40	4.2 ~ 10.6	2410	920 ~ 3250	3.90	A
1.6 + 2.0 + 2.0 + 2.0	7.6	1.99	2.47	2.47	2.47	9.40	4.2 ~ 10.6	2440	690 ~ 3400	3.85	A
1.6 + 2.0 + 2.0 + 2.5	8.1	1.86	2.32	2.32	2.90	9.40	4.2 ~ 10.6	2440	690 ~ 3400	3.85	A
1.6 + 2.0 + 2.0 + 3.5	9.1	1.65	2.07	2.07	3.61	9.40	4.2 ~ 10.6	2420	710 ~ 3370	3.88	A
1.6 + 2.0 + 2.0 + 4.2	9.8	1.53	1.92	1.92	4.03	9.40	4.2 ~ 10.6	2410	710 ~ 3360	3.90	A
1.6 + 2.0 + 2.0 + 5.0	10.6	1.42	1.77	1.77	4.44	9.40	4.2 ~ 10.6	2390	790 ~ 3300	3.93	A
1.6 + 2.0 + 2.0 + 6.0	11.6	1.30	1.62	1.62	4.86	9.40	4.2 ~ 10.6	2390	790 ~ 3300	3.93	A
1.6 + 2.0 + 2.0 + 7.1	12.7	1.18	1.48	1.48	5.26	9.40	4.2 ~ 10.6	2380	800 ~ 3290	3.95	A
1.6 + 2.0 + 2.5 + 2.5	8.6	1.75	2.19	2.73	2.73	9.40	4.2 ~ 10.6	2440	690 ~ 3400	3.85	A
1.6 + 2.0 + 2.5 + 3.5	9.6	1.57	1.96	2.45	3.42	9.40	4.2 ~ 10.6	2420	710 ~ 3370	3.88	A
1.6 + 2.0 + 2.5 + 4.2	10.3	1.46	1.83	2.28	3.83	9.40	4.2 ~ 10.6	2410	710 ~ 3360	3.90	A
1.6 + 2.0 + 2.5 + 5.0	11.1	1.35	1.69	2.12	4.24	9.40	4.2 ~ 10.6	2390	790 ~ 3300	3.93	A
1.6 + 2.0 + 2.5 + 6.0	12.1	1.24	1.55	1.94	4.67	9.40	4.2 ~ 10.6	2390	790 ~ 3300	3.93	A
1.6 + 2.0 + 2.5 + 7.1	13.2	1.14	1.42	1.78	5.06	9.40	4.2 ~ 10.6	2380	800 ~ 3290	3.95	A
1.6 + 2.0 + 3.5 + 3.5	10.6	1.42	1.78	3.10	3.10	9.40	4.2 ~ 10.6	2400	720 ~ 3340	3.92	A
1.6 + 2.0 + 3.5 + 4.2	11.3	1.33	1.66	2.91	3.50	9.40	4.2 ~ 10.6	2400	720 ~ 3330	3.92	A
1.6 + 2.0 + 3.5 + 5.0	12.1	1.24	1.55	2.72	3.89	9.40	4.2 ~ 10.6	2370	800 ~ 3280	3.97	A
1.6 + 2.0 + 3.5 + 6.0	13.1	1.15	1.44	2.51	4.30	9.40	4.2 ~ 10.6	2370	800 ~ 3280	3.97	A
1.6 + 2.0 + 3.5 + 7.1	14.2	1.06	1.32	2.32	4.70	9.40	4.2 ~ 10.6	2370	810 ~ 3270	3.97	A
1.6 + 2.0 + 4.2 + 4.2	12.0	1.25	1.57	3.29	3.29	9.40	4.2 ~ 10.6	2390	720 ~ 3320	3.93	A
1.6 + 2.0 + 4.2 + 5.0	12.8	1.18	1.47	3.08	3.67	9.40	4.2 ~ 10.6	2370	810 ~ 3270	3.97	A
1.6 + 2.0 + 4.2 + 6.0	13.8	1.09	1.36	2.86	4.09	9.40	4.2 ~ 10.6	2370	810 ~ 3270	3.97	A
1.6 + 2.0 + 5.0 + 5.0	13.6	1.10	1.38	3.46	3.46	9.40	4.2 ~ 10.6	2410	930 ~ 3300	3.90	A
1.6 + 2.0 + 5.0 + 6.0	14.6	1.03	1.29	3.22	3.86	9.40	4.2 ~ 10.6	2410	930 ~ 3300	3.90	A
1.6 + 2.5 + 2.5 + 2.5	9.1	1.66	2.58	2.58	2.58	9.40	4.2 ~ 10.6	2440	690 ~ 3400	3.85	A
1.6 + 2.5 + 2.5 + 3.5	10.1	1.49	2.33	2.33	3.25	9.40	4.2 ~ 10.6	2420	710 ~ 3370	3.88	A
1.6 + 2.5 + 2.5 + 4.2	10.8	1.39	2.18	2.18	3.65	9.40	4.2 ~ 10.6	2410	710 ~ 3360	3.90	A

Indoor unit capacity Heating	Annual Energy Consumption (kWh)	Current 230V (A)	ERP				Moisture Removal Volume l/h
			Pdesign (kW)	SCOP		Annual Consumption (kWh)	
				W/W	CLASS		
1.6 + 1.6 + 1.6 + 1.6	1235	11.6	6.10	3.80	A	2247	
1.6 + 1.6 + 1.6 + 2.0	1230	11.6	6.10	3.80	A	2247	
1.6 + 1.6 + 1.6 + 2.5	1230	11.6	6.10	3.80	A	2247	
1.6 + 1.6 + 1.6 + 3.5	1220	11.5	6.10	3.80	A	2247	
1.6 + 1.6 + 1.6 + 4.2	1215	11.4	6.10	3.80	A	2247	
1.6 + 1.6 + 1.6 + 5.0	1200	11.3	6.10	3.80	A	2247	
1.6 + 1.6 + 1.6 + 6.0	1200	11.3	6.10	3.80	A	2247	
1.6 + 1.6 + 1.6 + 7.1	1195	11.2	6.10	3.80	A	2247	
1.6 + 1.6 + 2.0 + 2.0	1225	11.5	6.10	3.80	A	2247	
1.6 + 1.6 + 2.0 + 2.5	1225	11.5	6.10	3.80	A	2247	
1.6 + 1.6 + 2.0 + 3.5	1215	11.4	6.10	3.80	A	2247	
1.6 + 1.6 + 2.0 + 4.2	1210	11.4	6.10	3.80	A	2247	
1.6 + 1.6 + 2.0 + 5.0	1195	11.2	6.10	3.80	A	2247	
1.6 + 1.6 + 2.0 + 6.0	1195	11.2	6.10	3.80	A	2247	
1.6 + 1.6 + 2.0 + 7.1	1190	11.2	6.10	3.80	A	2247	
1.6 + 1.6 + 2.5 + 2.5	1225	11.5	6.10	3.80	A	2247	
1.6 + 1.6 + 2.5 + 3.5	1215	11.4	6.10	3.80	A	2247	
1.6 + 1.6 + 2.5 + 4.2	1210	11.4	6.10	3.80	A	2247	
1.6 + 1.6 + 2.5 + 5.0	1195	11.2	6.10	3.80	A	2247	
1.6 + 1.6 + 2.5 + 6.0	1195	11.2	6.10	3.80	A	2247	
1.6 + 1.6 + 2.5 + 7.1	1190	11.2	6.10	3.80	A	2247	
1.6 + 1.6 + 3.5 + 3.5	1205	11.3	6.10	3.80	A	2247	
1.6 + 1.6 + 3.5 + 4.2	1200	11.3	6.10	3.80	A	2247	
1.6 + 1.6 + 3.5 + 5.0	1190	11.2	6.10	3.80	A	2247	
1.6 + 1.6 + 3.5 + 6.0	1190	11.2	6.10	3.80	A	2247	
1.6 + 1.6 + 3.5 + 7.1	1185	11.1	6.10	3.80	A	2247	
1.6 + 1.6 + 4.2 + 4.2	1200	11.3	6.10	3.80	A	2247	
1.6 + 1.6 + 4.2 + 5.0	1185	11.1	6.10	3.80	A	2247	
1.6 + 1.6 + 4.2 + 6.0	1185	11.1	6.10	3.80	A	2247	
1.6 + 1.6 + 4.2 + 7.1	1185	11.1	6.10	3.80	A	2247	
1.6 + 1.6 + 5.0 + 5.0	1205	11.3	6.10	3.80	A	2247	
1.6 + 1.6 + 5.0 + 6.0	1205	11.3	6.10	3.80	A	2247	
1.6 + 2.0 + 2.0 + 2.0	1220	11.5	6.10	3.80	A	2247	
1.6 + 2.0 + 2.0 + 2.5	1220	11.5	6.10	3.80	A	2247	
1.6 + 2.0 + 2.0 + 3.5	1210	11.4	6.10	3.80	A	2247	
1.6 + 2.0 + 2.0 + 4.2	1205	11.3	6.10	3.80	A	2247	
1.6 + 2.0 + 2.0 + 5.0	1195	11.2	6.10	3.80	A	2247	
1.6 + 2.0 + 2.0 + 6.0	1195	11.2	6.10	3.80	A	2247	
1.6 + 2.0 + 2.0 + 7.1	1190	11.2	6.10	3.80	A	2247	
1.6 + 2.0 + 2.5 + 2.5	1220	11.5	6.10	3.80	A	2247	
1.6 + 2.0 + 2.5 + 3.5	1210	11.4	6.10	3.80	A	2247	
1.6 + 2.0 + 2.5 + 4.2	1205	11.3	6.10	3.80	A	2247	
1.6 + 2.0 + 2.5 + 5.0	1195	11.2	6.10	3.80	A	2247	
1.6 + 2.0 + 2.5 + 6.0	1195	11.2	6.10	3.80	A	2247	
1.6 + 2.0 + 2.5 + 7.1	1190	11.2	6.10	3.80	A	2247	
1.6 + 2.0 + 3.5 + 3.5	1200	11.3	6.10	3.80	A	2247	
1.6 + 2.0 + 3.5 + 4.2	1200	11.3	6.10	3.80	A	2247	
1.6 + 2.0 + 3.5 + 5.0	1185	11.1	6.10	3.80	A	2247	
1.6 + 2.0 + 3.5 + 6.0	1185	11.1	6.10	3.80	A	2247	
1.6 + 2.0 + 3.5 + 7.1	1185	11.1	6.10	3.80	A	2247	
1.6 + 2.0 + 4.2 + 4.2	1195	11.2	6.10	3.80	A	2247	
1.6 + 2.0 + 4.2 + 5.0	1185	11.1	6.10	3.80	A	2247	
1.6 + 2.0 + 4.2 + 6.0	1185	11.1	6.10	3.80	A	2247	
1.6 + 2.0 + 5.0 + 5.0	1205	11.3	6.10	3.80	A	2247	
1.6 + 2.0 + 5.0 + 6.0	1205	11.3	6.10	3.80	A	2247	
1.6 + 2.5 + 2.5 + 2.5	1220	11.5	6.10	3.80	A	2247	
1.6 + 2.5 + 2.5 + 3.5	1210	11.4	6.10	3.80	A	2247	
1.6 + 2.5 + 2.5 + 4.2	1205	11.3	6.10	3.80	A	2247	

4 Room

Indoor unit capacity Heating	Total	Heating Capacity (kW)					Input Power (W)		COP		
		Room A	Room B	Room C	Room D	Total	min ~ max	Rating	min ~ max	W/W	CLASS
1.6 + 2.5 + 2.5 + 5.0	11.6	1.30	2.03	2.03	4.04	9.40	4.2 ~ 10.6	2390	790 ~ 3300	3.93	A
1.6 + 2.5 + 2.5 + 6.0	12.6	1.19	1.87	1.87	4.47	9.40	4.2 ~ 10.6	2390	790 ~ 3300	3.93	A
1.6 + 2.5 + 2.5 + 7.1	13.7	1.10	1.72	1.72	4.86	9.40	4.2 ~ 10.6	2380	800 ~ 3290	3.95	A
1.6 + 2.5 + 3.5 + 3.5	11.1	1.35	2.13	2.96	2.96	9.40	4.2 ~ 10.6	2400	720 ~ 3340	3.92	A
1.6 + 2.5 + 3.5 + 4.2	11.8	1.27	1.99	2.79	3.35	9.40	4.2 ~ 10.6	2400	720 ~ 3330	3.92	A
1.6 + 2.5 + 3.5 + 5.0	12.6	1.19	1.87	2.61	3.73	9.40	4.2 ~ 10.6	2370	800 ~ 3280	3.97	A
1.6 + 2.5 + 3.5 + 6.0	13.6	1.10	1.73	2.42	4.15	9.40	4.2 ~ 10.6	2370	800 ~ 3280	3.97	A
1.6 + 2.5 + 3.5 + 7.1	14.7	1.02	1.60	2.24	4.54	9.40	4.2 ~ 10.6	2370	810 ~ 3270	3.97	A
1.6 + 2.5 + 4.2 + 4.2	12.5	1.20	1.88	3.16	3.16	9.40	4.2 ~ 10.6	2390	720 ~ 3320	3.93	A
1.6 + 2.5 + 4.2 + 5.0	13.3	1.13	1.77	2.97	3.53	9.40	4.2 ~ 10.6	2370	810 ~ 3270	3.97	A
1.6 + 2.5 + 4.2 + 6.0	14.3	1.05	1.64	2.76	3.95	9.40	4.2 ~ 10.6	2370	810 ~ 3270	3.97	A
1.6 + 2.5 + 5.0 + 5.0	14.1	1.07	1.67	3.33	3.33	9.40	4.2 ~ 10.6	2410	930 ~ 3300	3.90	A
1.6 + 3.5 + 3.5 + 3.5	12.1	1.24	2.72	2.72	2.72	9.40	4.2 ~ 10.6	2380	720 ~ 3310	3.95	A
1.6 + 3.5 + 3.5 + 4.2	12.8	1.18	2.57	2.57	3.08	9.40	4.2 ~ 10.6	2380	750 ~ 3300	3.95	A
1.6 + 3.5 + 3.5 + 5.0	13.6	1.11	2.42	2.42	3.45	9.40	4.2 ~ 10.6	2400	840 ~ 3260	3.92	A
1.6 + 3.5 + 3.5 + 6.0	14.6	1.03	2.25	2.25	3.87	9.40	4.2 ~ 10.6	2400	840 ~ 3260	3.92	A
1.6 + 3.5 + 4.2 + 4.2	13.5	1.11	2.45	2.92	2.92	9.40	4.2 ~ 10.6	2370	750 ~ 3290	3.97	A
1.6 + 3.5 + 4.2 + 5.0	14.3	1.05	2.30	2.76	3.29	9.40	4.2 ~ 10.6	2400	840 ~ 3250	3.92	A
1.6 + 4.2 + 4.2 + 4.2	14.2	1.06	2.78	2.78	2.78	9.40	4.2 ~ 10.6	2370	760 ~ 3280	3.97	A
2.0 + 2.0 + 2.0 + 2.0	8.0	2.35	2.35	2.35	2.35	9.40	4.2 ~ 10.6	2430	690 ~ 3390	3.87	A
2.0 + 2.0 + 2.0 + 2.5	8.5	2.21	2.21	2.21	2.77	9.40	4.2 ~ 10.6	2430	690 ~ 3390	3.87	A
2.0 + 2.0 + 2.0 + 3.5	9.5	1.98	1.98	1.98	3.46	9.40	4.2 ~ 10.6	2410	710 ~ 3360	3.90	A
2.0 + 2.0 + 2.0 + 4.2	10.2	1.84	1.84	1.84	3.88	9.40	4.2 ~ 10.6	2410	720 ~ 3350	3.90	A
2.0 + 2.0 + 2.0 + 5.0	11.0	1.71	1.71	1.71	4.27	9.40	4.2 ~ 10.6	2380	800 ~ 3290	3.95	A
2.0 + 2.0 + 2.0 + 6.0	12.0	1.57	1.57	1.57	4.69	9.40	4.2 ~ 10.6	2380	800 ~ 3290	3.95	A
2.0 + 2.0 + 2.0 + 7.1	13.1	1.44	1.44	1.44	5.08	9.40	4.2 ~ 10.6	2370	800 ~ 3280	3.97	A
2.0 + 2.0 + 2.5 + 2.5	9.0	2.09	2.09	2.61	2.61	9.40	4.2 ~ 10.6	2430	690 ~ 3390	3.87	A
2.0 + 2.0 + 2.5 + 3.5	10.0	1.88	1.88	2.35	3.29	9.40	4.2 ~ 10.6	2410	710 ~ 3360	3.90	A
2.0 + 2.0 + 2.5 + 4.2	10.7	1.76	1.76	2.20	3.68	9.40	4.2 ~ 10.6	2410	720 ~ 3350	3.90	A
2.0 + 2.0 + 2.5 + 5.0	11.5	1.63	1.63	2.04	4.10	9.40	4.2 ~ 10.6	2380	800 ~ 3290	3.95	A
2.0 + 2.0 + 2.5 + 6.0	12.5	1.50	1.50	1.88	4.52	9.40	4.2 ~ 10.6	2380	800 ~ 3290	3.95	A
2.0 + 2.0 + 2.5 + 7.1	13.6	1.38	1.38	1.73	4.91	9.40	4.2 ~ 10.6	2370	800 ~ 3280	3.97	A
2.0 + 2.0 + 3.5 + 3.5	11.0	1.71	1.71	2.99	2.99	9.40	4.2 ~ 10.6	2400	720 ~ 3330	3.92	A
2.0 + 2.0 + 3.5 + 4.2	11.7	1.61	1.61	2.81	3.37	9.40	4.2 ~ 10.6	2390	720 ~ 3320	3.93	A
2.0 + 2.0 + 3.5 + 5.0	12.5	1.50	1.50	2.63	3.77	9.40	4.2 ~ 10.6	2370	810 ~ 3270	3.97	A
2.0 + 2.0 + 3.5 + 6.0	13.5	1.39	1.39	2.44	4.18	9.40	4.2 ~ 10.6	2370	810 ~ 3270	3.97	A
2.0 + 2.0 + 3.5 + 7.1	14.6	1.29	1.29	2.25	4.57	9.40	4.2 ~ 10.6	2400	830 ~ 3260	3.92	A
2.0 + 2.0 + 4.2 + 4.2	12.4	1.52	1.52	3.18	3.18	9.40	4.2 ~ 10.6	2380	720 ~ 3310	3.95	A
2.0 + 2.0 + 4.2 + 5.0	13.2	1.42	1.42	2.99	3.57	9.40	4.2 ~ 10.6	2400	810 ~ 3260	3.92	A
2.0 + 2.0 + 4.2 + 6.0	14.2	1.32	1.32	2.78	3.98	9.40	4.2 ~ 10.6	2400	810 ~ 3260	3.92	A
2.0 + 2.0 + 5.0 + 5.0	14.0	1.34	1.34	3.36	3.36	9.40	4.2 ~ 10.6	2410	940 ~ 3290	3.90	A
2.0 + 2.5 + 2.5 + 2.5	9.5	1.99	2.47	2.47	2.47	9.40	4.2 ~ 10.6	2430	690 ~ 3390	3.87	A
2.0 + 2.5 + 2.5 + 3.5	10.5	1.79	2.24	2.24	3.13	9.40	4.2 ~ 10.6	2410	710 ~ 3360	3.90	A
2.0 + 2.5 + 2.5 + 4.2	11.2	1.68	2.10	2.10	3.52	9.40	4.2 ~ 10.6	2410	720 ~ 3350	3.90	A
2.0 + 2.5 + 2.5 + 5.0	12.0	1.57	1.96	1.96	3.91	9.40	4.2 ~ 10.6	2380	800 ~ 3290	3.95	A
2.0 + 2.5 + 2.5 + 6.0	13.0	1.45	1.81	1.81	4.33	9.40	4.2 ~ 10.6	2380	800 ~ 3290	3.95	A
2.0 + 2.5 + 2.5 + 7.1	14.1	1.33	1.67	1.67	4.73	9.40	4.2 ~ 10.6	2370	800 ~ 3280	3.97	A
2.0 + 2.5 + 3.5 + 3.5	11.5	1.63	2.05	2.86	2.86	9.40	4.2 ~ 10.6	2400	720 ~ 3330	3.92	A
2.0 + 2.5 + 3.5 + 4.2	12.2	1.54	1.93	2.70	3.23	9.40	4.2 ~ 10.6	2390	720 ~ 3320	3.93	A
2.0 + 2.5 + 3.5 + 5.0	13.0	1.45	1.81	2.53	3.61	9.40	4.2 ~ 10.6	2370	810 ~ 3270	3.97	A
2.0 + 2.5 + 3.5 + 6.0	14.0	1.34	1.68	2.35	4.03	9.40	4.2 ~ 10.6	2370	810 ~ 3270	3.97	A
2.0 + 2.5 + 4.2 + 4.2	12.9	1.46	1.82	3.06	3.06	9.40	4.2 ~ 10.6	2380	720 ~ 3310	3.95	A
2.0 + 2.5 + 4.2 + 5.0	13.7	1.37	1.72	2.88	3.43	9.40	4.2 ~ 10.6	2400	810 ~ 3260	3.92	A
2.0 + 2.5 + 4.2 + 6.0	14.7	1.28	1.60	2.69	3.83	9.40	4.2 ~ 10.6	2400	810 ~ 3260	3.92	A
2.0 + 2.5 + 5.0 + 5.0	14.5	1.30	1.62	3.24	3.24	9.40	4.2 ~ 10.6	2410	940 ~ 3290	3.90	A
2.0 + 3.5 + 3.5 + 3.5	12.5	1.51	2.63	2.63	2.63	9.40	4.2 ~ 10.6	2380	750 ~ 3300	3.95	A
2.0 + 3.5 + 3.5 + 4.2	13.2	1.42	2.49	2.49	3.00	9.40	4.2 ~ 10.6	2370	750 ~ 3290	3.97	A
2.0 + 3.5 + 3.5 + 5.0	14.0	1.34	2.35	2.35	3.36	9.40	4.2 ~ 10.6	2400	840 ~ 3250	3.92	A



Indoor unit capacity Heating	Annual Energy Consumption (kWh)	Current 230V (A)	ERP				Moisture Removal Volume l/h
			Pdesign (kW)	SCOP		Annual Consumption (kWh)	
				W/W	CLASS		
1.6 + 2.5 + 2.5 + 5.0	1195	11.2	6.10	3.80	A	2247	
1.6 + 2.5 + 2.5 + 6.0	1195	11.2	6.10	3.80	A	2247	
1.6 + 2.5 + 2.5 + 7.1	1190	11.2	6.10	3.80	A	2247	
1.6 + 2.5 + 3.5 + 3.5	1200	11.3	6.10	3.80	A	2247	
1.6 + 2.5 + 3.5 + 4.2	1200	11.3	6.10	3.80	A	2247	
1.6 + 2.5 + 3.5 + 5.0	1185	11.1	6.10	3.80	A	2247	
1.6 + 2.5 + 3.5 + 6.0	1185	11.1	6.10	3.80	A	2247	
1.6 + 2.5 + 3.5 + 7.1	1185	11.1	6.10	3.80	A	2247	
1.6 + 2.5 + 4.2 + 4.2	1195	11.2	6.10	3.80	A	2247	
1.6 + 2.5 + 4.2 + 5.0	1185	11.1	6.10	3.80	A	2247	
1.6 + 2.5 + 4.2 + 6.0	1185	11.1	6.10	3.80	A	2247	
1.6 + 2.5 + 5.0 + 5.0	1205	11.3	6.10	3.80	A	2247	
1.6 + 3.5 + 3.5 + 3.5	1190	11.2	6.10	3.80	A	2247	
1.6 + 3.5 + 3.5 + 4.2	1190	11.2	6.10	3.80	A	2247	
1.6 + 3.5 + 3.5 + 5.0	1200	11.3	6.10	3.80	A	2247	
1.6 + 3.5 + 3.5 + 6.0	1200	11.3	6.10	3.80	A	2247	
1.6 + 3.5 + 4.2 + 4.2	1185	11.1	6.10	3.80	A	2247	
1.6 + 3.5 + 4.2 + 5.0	1200	11.3	6.10	3.80	A	2247	
1.6 + 4.2 + 4.2 + 4.2	1185	11.1	6.10	3.80	A	2247	
2.0 + 2.0 + 2.0 + 2.0	1215	11.4	6.10	3.80	A	2247	
2.0 + 2.0 + 2.0 + 2.5	1215	11.4	6.10	3.80	A	2247	
2.0 + 2.0 + 2.0 + 3.5	1205	11.3	6.10	3.80	A	2247	
2.0 + 2.0 + 2.0 + 4.2	1205	11.3	6.10	3.80	A	2247	
2.0 + 2.0 + 2.0 + 5.0	1190	11.2	6.10	3.80	A	2247	
2.0 + 2.0 + 2.0 + 6.0	1190	11.2	6.10	3.80	A	2247	
2.0 + 2.0 + 2.0 + 7.1	1185	11.1	6.10	3.80	A	2247	
2.0 + 2.0 + 2.5 + 2.5	1215	11.4	6.10	3.80	A	2247	
2.0 + 2.0 + 2.5 + 3.5	1205	11.3	6.10	3.80	A	2247	
2.0 + 2.0 + 2.5 + 4.2	1205	11.3	6.10	3.80	A	2247	
2.0 + 2.0 + 2.5 + 5.0	1190	11.2	6.10	3.80	A	2247	
2.0 + 2.0 + 2.5 + 6.0	1190	11.2	6.10	3.80	A	2247	
2.0 + 2.0 + 2.5 + 7.1	1185	11.1	6.10	3.80	A	2247	
2.0 + 2.0 + 3.5 + 3.5	1200	11.3	6.10	3.80	A	2247	
2.0 + 2.0 + 3.5 + 4.2	1195	11.2	6.10	3.80	A	2247	
2.0 + 2.0 + 3.5 + 5.0	1185	11.1	6.10	3.80	A	2247	
2.0 + 2.0 + 3.5 + 6.0	1185	11.1	6.10	3.80	A	2247	
2.0 + 2.0 + 3.5 + 7.1	1200	11.3	6.10	3.80	A	2247	
2.0 + 2.0 + 4.2 + 4.2	1190	11.2	6.10	3.80	A	2247	
2.0 + 2.0 + 4.2 + 5.0	1200	11.3	6.10	3.80	A	2247	
2.0 + 2.0 + 4.2 + 6.0	1200	11.3	6.10	3.80	A	2247	
2.0 + 2.0 + 5.0 + 5.0	1205	11.3	6.10	3.80	A	2247	
2.0 + 2.5 + 2.5 + 2.5	1215	11.4	6.10	3.80	A	2247	
2.0 + 2.5 + 2.5 + 3.5	1205	11.3	6.10	3.80	A	2247	
2.0 + 2.5 + 2.5 + 4.2	1205	11.3	6.10	3.80	A	2247	
2.0 + 2.5 + 2.5 + 5.0	1190	11.2	6.10	3.80	A	2247	
2.0 + 2.5 + 2.5 + 6.0	1190	11.2	6.10	3.80	A	2247	
2.0 + 2.5 + 2.5 + 7.1	1185	11.1	6.10	3.80	A	2247	
2.0 + 2.5 + 3.5 + 3.5	1200	11.3	6.10	3.80	A	2247	
2.0 + 2.5 + 3.5 + 4.2	1195	11.2	6.10	3.80	A	2247	
2.0 + 2.5 + 3.5 + 5.0	1185	11.1	6.10	3.80	A	2247	
2.0 + 2.5 + 3.5 + 6.0	1185	11.1	6.10	3.80	A	2247	
2.0 + 2.5 + 4.2 + 4.2	1190	11.2	6.10	3.80	A	2247	
2.0 + 2.5 + 4.2 + 5.0	1200	11.3	6.10	3.80	A	2247	
2.0 + 2.5 + 4.2 + 6.0	1200	11.3	6.10	3.80	A	2247	
2.0 + 2.5 + 5.0 + 5.0	1205	11.3	6.10	3.80	A	2247	
2.0 + 3.5 + 3.5 + 3.5	1190	11.2	6.10	3.80	A	2247	
2.0 + 3.5 + 3.5 + 4.2	1185	11.1	6.10	3.80	A	2247	
2.0 + 3.5 + 3.5 + 5.0	1200	11.3	6.10	3.80	A	2247	

4 Room

Indoor unit capacity Heating		Total	Heating Capacity (kW)					Input Power (W)		COP		
			Room A	Room B	Room C	Room D	Total	min ~ max	Rating	min ~ max	W/W	CLASS
4 Room	2.0 + 3.5 + 4.2 + 4.2	13.9	1.35	2.37	2.84	2.84	9.40	4.2 ~ 10.6	2370	760 ~ 3280	3.97	A
	2.0 + 3.5 + 4.2 + 5.0	14.7	1.28	2.24	2.69	3.19	9.40	4.2 ~ 10.6	2390	850 ~ 3240	3.93	A
	2.0 + 4.2 + 4.2 + 4.2	14.6	1.30	2.70	2.70	2.70	9.40	4.2 ~ 10.6	2400	760 ~ 3270	3.92	A
	2.5 + 2.5 + 2.5 + 2.5	10.0	2.35	2.35	2.35	2.35	9.40	4.2 ~ 10.6	2430	690 ~ 3390	3.87	A
	2.5 + 2.5 + 2.5 + 3.5	11.0	2.14	2.14	2.14	2.98	9.40	4.2 ~ 10.6	2410	710 ~ 3360	3.90	A
	2.5 + 2.5 + 2.5 + 4.2	11.7	2.01	2.01	2.01	3.37	9.40	4.2 ~ 10.6	2410	720 ~ 3350	3.90	A
	2.5 + 2.5 + 2.5 + 5.0	12.5	1.88	1.88	1.88	3.76	9.40	4.2 ~ 10.6	2380	800 ~ 3290	3.95	A
	2.5 + 2.5 + 2.5 + 6.0	13.5	1.74	1.74	1.74	4.18	9.40	4.2 ~ 10.6	2380	800 ~ 3290	3.95	A
	2.5 + 2.5 + 2.5 + 7.1	14.6	1.61	1.61	1.61	4.57	9.40	4.2 ~ 10.6	2370	800 ~ 3280	3.97	A
	2.5 + 2.5 + 3.5 + 3.5	12.0	1.96	1.96	2.74	2.74	9.40	4.2 ~ 10.6	2400	720 ~ 3330	3.92	A
	2.5 + 2.5 + 3.5 + 4.2	12.7	1.85	1.85	2.59	3.11	9.40	4.2 ~ 10.6	2390	720 ~ 3320	3.93	A
	2.5 + 2.5 + 3.5 + 5.0	13.5	1.74	1.74	2.44	3.48	9.40	4.2 ~ 10.6	2370	810 ~ 3270	3.97	A
	2.5 + 2.5 + 3.5 + 6.0	14.5	1.62	1.62	2.27	3.89	9.40	4.2 ~ 10.6	2370	810 ~ 3270	3.97	A
	2.5 + 2.5 + 4.2 + 4.2	13.4	1.75	1.75	2.95	2.95	9.40	4.2 ~ 10.6	2380	720 ~ 3310	3.95	A
	2.5 + 2.5 + 4.2 + 5.0	14.2	1.65	1.65	2.78	3.32	9.40	4.2 ~ 10.6	2400	810 ~ 3260	3.92	A
	2.5 + 3.5 + 3.5 + 3.5	13.0	1.81	2.53	2.53	2.53	9.40	4.2 ~ 10.6	2380	750 ~ 3300	3.95	A
	2.5 + 3.5 + 3.5 + 4.2	13.7	1.72	2.40	2.40	2.88	9.40	4.2 ~ 10.6	2370	750 ~ 3290	3.97	A
	2.5 + 3.5 + 3.5 + 5.0	14.5	1.62	2.27	2.27	3.24	9.40	4.2 ~ 10.6	2400	840 ~ 3250	3.92	A
	2.5 + 3.5 + 4.2 + 4.2	14.4	1.63	2.29	2.74	2.74	9.40	4.2 ~ 10.6	2370	760 ~ 3280	3.97	A
	3.5 + 3.5 + 3.5 + 3.5	14.0	2.35	2.35	2.35	2.35	9.40	4.2 ~ 10.6	2400	760 ~ 3270	3.92	A
3.5 + 3.5 + 3.5 + 4.2	14.7	2.24	2.24	2.24	2.68	9.40	4.2 ~ 10.6	2400	760 ~ 3260	3.92	A	

Indoor unit capacity Heating	Annual Energy Consumption (kWh)	Current 230V (A)	ERP				Moisture Removal Volume l/h
			Pdesign (kW)	SCOP		Annual Consumption (kWh)	
				W/W	CLASS		
4 Room	2.0 + 3.5 + 4.2 + 4.2	1185	11.1	6.10	3.80	A	2247
	2.0 + 3.5 + 4.2 + 5.0	1195	11.2	6.10	3.80	A	2247
	2.0 + 4.2 + 4.2 + 4.2	1200	11.3	6.10	3.80	A	2247
	2.5 + 2.5 + 2.5 + 2.5	1215	11.4	6.10	3.80	A	2247
	2.5 + 2.5 + 2.5 + 3.5	1205	11.3	6.10	3.80	A	2247
	2.5 + 2.5 + 2.5 + 4.2	1205	11.3	6.10	3.80	A	2247
	2.5 + 2.5 + 2.5 + 5.0	1190	11.2	6.10	3.80	A	2247
	2.5 + 2.5 + 2.5 + 6.0	1190	11.2	6.10	3.80	A	2247
	2.5 + 2.5 + 2.5 + 7.1	1185	11.1	6.10	3.80	A	2247
	2.5 + 2.5 + 3.5 + 3.5	1200	11.3	6.10	3.80	A	2247
	2.5 + 2.5 + 3.5 + 4.2	1195	11.2	6.10	3.80	A	2247
	2.5 + 2.5 + 3.5 + 5.0	1185	11.1	6.10	3.80	A	2247
	2.5 + 2.5 + 3.5 + 6.0	1185	11.1	6.10	3.80	A	2247
	2.5 + 2.5 + 4.2 + 4.2	1190	11.2	6.10	3.80	A	2247
	2.5 + 2.5 + 4.2 + 5.0	1200	11.3	6.10	3.80	A	2247
	2.5 + 3.5 + 3.5 + 3.5	1190	11.2	6.10	3.80	A	2247
	2.5 + 3.5 + 3.5 + 4.2	1185	11.1	6.10	3.80	A	2247
	2.5 + 3.5 + 3.5 + 5.0	1200	11.3	6.10	3.80	A	2247
	2.5 + 3.5 + 4.2 + 4.2	1185	11.1	6.10	3.80	A	2247
	3.5 + 3.5 + 3.5 + 3.5	1200	11.3	6.10	3.80	A	2247
3.5 + 3.5 + 3.5 + 4.2	1200	11.3	6.10	3.80	A	2247	

- Indoor Unit : CS-MZ / Z / XZ wall mount series
- Outdoor Unit : CU-5Z90TBE

	Indoor unit capacity Cooling	Total	Cooling Capacity (kW)						Input Power (W)		EER		
			Room A	Room B	Room C	Room D	Room E	Total	min ~ max	Rating	min ~ max	W/W	CLASS
1 Room	1.6	1.6	1.60					1.60	1.3 ~ 2.3	400	250 ~ 640	4.00	A
	2.0	2.0	2.00					2.00	1.8 ~ 2.9	500	340 ~ 810	4.00	A
	2.5	2.5	2.50					2.50	1.8 ~ 2.9	630	340 ~ 810	3.97	A
	3.5	3.5	3.50					3.50	1.8 ~ 4.1	940	340 ~ 1360	3.72	A
	4.2	4.2	4.20					4.20	1.8 ~ 4.5	1370	340 ~ 1990	3.07	B
	5.0	5.0	5.00					5.00	1.9 ~ 5.7	1550	340 ~ 2130	3.23	A
	6.0	6.0	6.00					6.00	1.9 ~ 6.2	2030	340 ~ 2330	2.96	C
	7.1	7.1	7.10					7.10	2.0 ~ 7.2	2530	370 ~ 2770	2.81	C
2 Room	1.6 + 1.6	3.2	1.60	1.60				3.20	2.4 ~ 5.8	660	270 ~ 1740	4.85	A
	1.6 + 2.0	3.6	1.60	2.00				3.60	2.4 ~ 5.8	790	270 ~ 1740	4.56	A
	1.6 + 2.5	4.1	1.60	2.50				4.10	2.4 ~ 5.8	960	270 ~ 1740	4.27	A
	1.6 + 3.5	5.1	1.60	3.50				5.10	2.4 ~ 5.8	1320	260 ~ 1680	3.86	A
	1.6 + 4.2	5.8	1.60	4.20				5.80	2.4 ~ 6.7	1630	260 ~ 2130	3.56	A
	1.6 + 5.0	6.6	1.60	5.00				6.60	2.4 ~ 7.2	1840	250 ~ 2130	3.59	A
	1.6 + 6.0	7.6	1.60	6.00				7.60	2.4 ~ 8.6	2370	250 ~ 3080	3.21	A
	1.6 + 7.1	8.7	1.60	7.10				8.70	2.5 ~ 9.1	2920	270 ~ 3160	2.98	C
	2.0 + 2.0	4.0	2.00	2.00				4.00	2.4 ~ 5.8	920	260 ~ 1680	4.35	A
	2.0 + 2.5	4.5	2.00	2.50				4.50	2.4 ~ 5.8	1120	260 ~ 1680	4.02	A
	2.0 + 3.5	5.5	2.00	3.50				5.50	2.4 ~ 5.8	1470	260 ~ 1630	3.74	A
	2.0 + 4.2	6.2	2.00	4.20				6.20	2.4 ~ 7.2	1840	260 ~ 2490	3.37	A
	2.0 + 5.0	7.0	2.00	5.00				7.00	2.4 ~ 8.1	1950	250 ~ 2610	3.59	A
	2.0 + 6.0	8.0	2.00	6.00				8.00	2.4 ~ 8.6	2550	250 ~ 3010	3.14	B
	2.0 + 7.1	9.1	1.98	7.02				9.00	2.5 ~ 10.0	3120	270 ~ 4030	2.88	C
	2.5 + 2.5	5.0	2.50	2.50				5.00	2.4 ~ 5.8	1270	260 ~ 1680	3.94	A
	2.5 + 3.5	6.0	2.50	3.50				6.00	2.4 ~ 6.7	1730	260 ~ 2130	3.47	A
	2.5 + 4.2	6.7	2.50	4.20				6.70	2.4 ~ 7.2	2130	260 ~ 2490	3.15	B
	2.5 + 5.0	7.5	2.50	5.00				7.50	2.4 ~ 8.6	2250	250 ~ 3010	3.33	A
	2.5 + 6.0	8.5	2.50	6.00				8.50	2.5 ~ 9.1	2940	270 ~ 3290	2.89	C
	2.5 + 7.1	9.6	2.34	6.66				9.00	2.5 ~ 10.1	3120	270 ~ 4180	2.88	C
	3.5 + 3.5	7.0	3.50	3.50				7.00	2.4 ~ 8.1	2250	260 ~ 3060	3.11	B
	3.5 + 4.2	7.7	3.50	4.20				7.70	2.4 ~ 8.6	2670	260 ~ 3550	2.88	C
	3.5 + 5.0	8.5	3.50	5.00				8.50	2.5 ~ 9.1	2810	270 ~ 3160	3.02	B
	3.5 + 6.0	9.5	3.32	5.68				9.00	2.5 ~ 10.1	3190	270 ~ 4180	2.82	C
	3.5 + 7.1	10.6	2.97	6.03				9.00	2.5 ~ 10.4	2990	270 ~ 4340	3.01	B
	4.2 + 4.2	8.4	4.20	4.20				8.40	2.5 ~ 9.1	3340	280 ~ 3960	2.51	E
4.2 + 5.0	9.2	4.11	4.89				9.00	2.5 ~ 10.0	3120	270 ~ 4030	2.88	C	
4.2 + 6.0	10.2	3.71	5.29				9.00	2.5 ~ 10.4	3120	270 ~ 4330	2.88	C	
4.2 + 7.1	11.3	3.35	5.65				9.00	2.5 ~ 10.4	2990	270 ~ 4340	3.01	B	
5.0 + 5.0	10.0	4.50	4.50				9.00	2.5 ~ 10.4	2660	260 ~ 3610	3.38	A	
5.0 + 6.0	11.0	4.09	4.91				9.00	2.5 ~ 10.4	2660	260 ~ 3610	3.38	A	
5.0 + 7.1	12.1	3.72	5.28				9.00	2.5 ~ 10.4	2600	260 ~ 3480	3.46	A	
6.0 + 6.0	12.0	4.50	4.50				9.00	2.5 ~ 10.4	2660	260 ~ 3610	3.38	A	
6.0 + 7.1	13.1	4.12	4.88				9.00	2.5 ~ 10.4	2600	260 ~ 3480	3.46	A	
7.1 + 7.1	14.2	4.50	4.50				9.00	2.5 ~ 10.4	2470	290 ~ 3340	3.64	A	

	Indoor unit capacity Cooling	Annual Energy Consumption (kWh)	Current 230V (A)	ERP				Moisture Removal Volume l/h
				Pdesign (kW)	SEER		Annual Consumption (kWh)	
					W/W	CLASS		
1 Room	1.6	200	2.0	-	-	-	-	1.0
	2.0	250	2.5	-	-	-	-	1.3
	2.5	315	3.2	-	-	-	-	1.5
	3.5	470	4.5	-	-	-	-	2.0
	4.2	685	6.4	-	-	-	-	2.4
	5.0	775	7.2	-	-	-	-	2.7
	6.0	1015	9.2	-	-	-	-	3.3
	7.1	1265	11.4	-	-	-	-	4.1
2 Room	1.6 + 1.6	330	3.4	3.20	5.60	A+	200	1.0 + 1.0
	1.6 + 2.0	395	4.0	3.60	5.60	A+	225	1.0 + 1.3
	1.6 + 2.5	480	4.7	4.10	5.60	A+	256	1.0 + 1.5
	1.6 + 3.5	660	6.4	5.10	5.60	A+	319	1.0 + 2.0
	1.6 + 4.2	815	7.9	5.80	5.60	A+	363	1.0 + 2.4
	1.6 + 5.0	920	8.8	6.60	6.10	A++	379	1.0 + 2.7
	1.6 + 6.0	1185	11.3	7.60	6.10	A++	436	1.0 + 3.3
	1.6 + 7.1	1460	14.0	8.70	6.10	A++	499	1.0 + 4.1
	2.0 + 2.0	460	4.5	4.00	5.60	A+	250	1.3 + 1.3
	2.0 + 2.5	560	5.5	4.50	5.60	A+	281	1.3 + 1.5
	2.0 + 3.5	735	7.1	5.50	5.60	A+	344	1.3 + 2.0
	2.0 + 4.2	920	8.8	6.20	5.60	A+	388	1.3 + 2.4
	2.0 + 5.0	975	9.3	7.00	6.10	A++	402	1.3 + 2.7
	2.0 + 6.0	1275	12.2	8.00	6.10	A++	459	1.3 + 3.3
	2.0 + 7.1	1560	14.9	9.00	6.10	A++	516	1.3 + 4.0
	2.5 + 2.5	635	6.1	5.00	5.60	A+	313	1.5 + 1.5
	2.5 + 3.5	865	8.4	6.00	5.60	A+	375	1.5 + 2.0
	2.5 + 4.2	1065	10.2	6.70	5.60	A+	419	1.5 + 2.4
	2.5 + 5.0	1125	10.8	7.50	6.10	A++	430	1.5 + 2.7
	2.5 + 6.0	1470	14.1	8.50	6.10	A++	488	1.5 + 3.3
	2.5 + 7.1	1560	14.9	9.00	6.10	A++	516	1.5 + 3.8
	3.5 + 3.5	1125	10.8	7.00	5.60	A+	438	2.0 + 2.0
	3.5 + 4.2	1335	12.8	7.70	5.60	A+	481	2.0 + 2.4
	3.5 + 5.0	1405	13.5	8.50	6.10	A++	488	2.0 + 2.7
	3.5 + 6.0	1595	15.3	9.00	6.10	A++	516	1.9 + 3.1
	3.5 + 7.1	1495	14.3	9.00	6.10	A++	516	1.7 + 3.3
	4.2 + 4.2	1670	16.0	8.40	5.60	A+	525	2.4 + 2.4
4.2 + 5.0	1560	14.9	9.00	6.10	A++	516	2.3 + 2.7	
4.2 + 6.0	1560	14.9	9.00	6.10	A++	516	2.2 + 2.9	
4.2 + 7.1	1495	14.3	9.00	6.10	A++	516	1.9 + 3.1	
5.0 + 5.0	1330	12.7	9.00	6.10	A++	516	2.5 + 2.5	
5.0 + 6.0	1330	12.7	9.00	6.10	A++	516	2.3 + 2.7	
5.0 + 7.1	1300	12.4	9.00	6.10	A++	516	2.2 + 2.9	
6.0 + 6.0	1330	12.7	9.00	6.10	A++	516	2.5 + 2.5	
6.0 + 7.1	1300	12.4	9.00	6.10	A++	516	2.3 + 2.7	
7.1 + 7.1	1235	11.8	9.00	6.10	A++	516	2.5 + 2.5	

	Indoor unit capacity Cooling	Total	Cooling Capacity (kW)						Input Power (W)		EER		
			Room A	Room B	Room C	Room D	Room E	Total	min ~ max	Rating	min ~ max	WW	CLASS
3 Room	1.6 + 1.6 + 1.6	4.8	1.60	1.60	1.60			4.80	2.9 ~ 8.5	990	320 ~ 2620	4.85	A
	1.6 + 1.6 + 2.0	5.2	1.60	1.60	2.00			5.20	2.9 ~ 8.5	1100	320 ~ 2620	4.73	A
	1.6 + 1.6 + 2.5	5.7	1.60	1.60	2.50			5.70	2.9 ~ 8.5	1290	320 ~ 2620	4.42	A
	1.6 + 1.6 + 3.5	6.7	1.60	1.60	3.50			6.70	2.9 ~ 8.5	1610	310 ~ 2550	4.16	A
	1.6 + 1.6 + 4.2	7.4	1.60	1.60	4.20			7.40	2.9 ~ 8.5	1950	340 ~ 2490	3.79	A
	1.6 + 1.6 + 5.0	8.2	1.60	1.60	5.00			8.20	2.9 ~ 8.7	2110	340 ~ 2290	3.89	A
	1.6 + 1.6 + 6.0	9.2	1.57	1.57	5.86			9.00	2.9 ~ 10.1	2470	340 ~ 3000	3.64	A
	1.6 + 1.6 + 7.1	10.3	1.40	1.40	6.20			9.00	2.9 ~ 10.7	2410	340 ~ 3340	3.73	A
	1.6 + 2.0 + 2.0	5.6	1.60	2.00	2.00			5.60	2.9 ~ 8.5	1240	310 ~ 2550	4.52	A
	1.6 + 2.0 + 2.5	6.1	1.60	2.00	2.50			6.10	2.9 ~ 8.5	1450	310 ~ 2550	4.21	A
	1.6 + 2.0 + 3.5	7.1	1.60	2.00	3.50			7.10	2.9 ~ 8.5	1780	340 ~ 2490	3.99	A
	1.6 + 2.0 + 4.2	7.8	1.60	2.00	4.20			7.80	2.9 ~ 8.5	2060	340 ~ 2490	3.79	A
	1.6 + 2.0 + 5.0	8.6	1.60	2.00	5.00			8.60	2.9 ~ 9.6	2300	340 ~ 2620	3.74	A
	1.6 + 2.0 + 6.0	9.6	1.49	1.88	5.63			9.00	2.9 ~ 10.1	2410	340 ~ 2940	3.73	A
	1.6 + 2.0 + 7.1	10.7	1.35	1.68	5.97			9.00	2.9 ~ 10.7	2350	340 ~ 3340	3.83	A
	1.6 + 2.5 + 2.5	6.6	1.60	2.50	2.50			6.60	2.9 ~ 8.5	1660	310 ~ 2550	3.98	A
	1.6 + 2.5 + 3.5	7.6	1.60	2.50	3.50			7.60	2.9 ~ 8.5	2060	340 ~ 2490	3.69	A
	1.6 + 2.5 + 4.2	8.3	1.60	2.50	4.20			8.30	2.9 ~ 8.7	2360	340 ~ 2540	3.52	A
	1.6 + 2.5 + 5.0	9.1	1.58	2.47	4.95			9.00	2.9 ~ 10.1	2410	340 ~ 2940	3.73	A
	1.6 + 2.5 + 6.0	10.1	1.42	2.23	5.35			9.00	2.9 ~ 10.7	2410	340 ~ 3480	3.73	A
	1.6 + 2.5 + 7.1	11.2	1.28	2.01	5.71			9.00	2.9 ~ 10.7	2350	340 ~ 3340	3.83	A
	1.6 + 3.5 + 3.5	8.6	1.60	3.50	3.50			8.60	2.9 ~ 9.6	2490	340 ~ 2930	3.45	A
	1.6 + 3.5 + 4.2	9.3	1.55	3.39	4.06			9.00	2.9 ~ 10.1	2660	340 ~ 3330	3.38	A
	1.6 + 3.5 + 5.0	10.1	1.42	3.12	4.46			9.00	2.9 ~ 10.7	2410	340 ~ 3340	3.73	A
	1.6 + 3.5 + 6.0	11.1	1.30	2.84	4.86			9.00	2.9 ~ 10.7	2410	340 ~ 3340	3.73	A
	1.6 + 3.5 + 7.1	12.2	1.18	2.58	5.24			9.00	2.9 ~ 10.7	2350	340 ~ 3200	3.83	A
	1.6 + 4.2 + 4.2	10.0	1.44	3.78	3.78			9.00	2.9 ~ 10.7	2660	340 ~ 3910	3.38	A
	1.6 + 4.2 + 5.0	10.8	1.33	3.50	4.17			9.00	2.9 ~ 10.7	2350	340 ~ 3340	3.83	A
	1.6 + 4.2 + 6.0	11.8	1.22	3.20	4.58			9.00	2.9 ~ 10.7	2350	340 ~ 3340	3.83	A
	1.6 + 4.2 + 7.1	12.9	1.12	2.93	4.95			9.00	2.9 ~ 10.7	2280	370 ~ 3200	3.95	A
	1.6 + 5.0 + 5.0	11.6	1.24	3.88	3.88			9.00	2.9 ~ 10.7	2160	370 ~ 2940	4.17	A
	1.6 + 5.0 + 6.0	12.6	1.14	3.57	4.29			9.00	2.9 ~ 10.7	2160	370 ~ 2940	4.17	A
	1.6 + 5.0 + 7.1	13.7	1.05	3.28	4.67			9.00	3.0 ~ 10.7	2170	400 ~ 2870	4.15	A
	1.6 + 6.0 + 6.0	13.6	1.06	3.97	3.97			9.00	3.0 ~ 10.7	2160	400 ~ 2940	4.17	A
	1.6 + 6.0 + 7.1	14.7	0.98	3.67	4.35			9.00	3.0 ~ 10.7	2170	400 ~ 2870	4.15	A
	1.6 + 7.1 + 7.1	15.8	0.92	4.04	4.04			9.00	3.0 ~ 10.7	2110	400 ~ 2810	4.27	A
	2.0 + 2.0 + 2.0	6.0	2.00	2.00	2.00			6.00	2.9 ~ 8.5	1390	310 ~ 2550	4.32	A
	2.0 + 2.0 + 2.5	6.5	2.00	2.00	2.50			6.50	2.9 ~ 8.5	1600	310 ~ 2550	4.06	A
	2.0 + 2.0 + 3.5	7.5	2.00	2.00	3.50			7.50	2.9 ~ 8.5	1950	340 ~ 2490	3.85	A
	2.0 + 2.0 + 4.2	8.2	2.00	2.00	4.20			8.20	2.9 ~ 8.7	2300	340 ~ 2540	3.57	A
	2.0 + 2.0 + 5.0	9.0	2.00	2.00	5.00			9.00	2.9 ~ 9.6	2410	340 ~ 2620	3.73	A
	2.0 + 2.0 + 6.0	10.0	1.80	1.80	5.40			9.00	2.9 ~ 10.7	2410	340 ~ 3410	3.73	A
2.0 + 2.0 + 7.1	11.1	1.62	1.62	5.76			9.00	2.9 ~ 10.7	2350	340 ~ 3270	3.83	A	
2.0 + 2.5 + 2.5	7.0	2.00	2.50	2.50			7.00	2.9 ~ 8.5	1780	310 ~ 2550	3.93	A	
2.0 + 2.5 + 3.5	8.0	2.00	2.50	3.50			8.00	2.9 ~ 8.5	2180	340 ~ 2490	3.67	A	
2.0 + 2.5 + 4.2	8.7	2.00	2.50	4.20			8.70	2.9 ~ 9.6	2540	340 ~ 3000	3.43	A	
2.0 + 2.5 + 5.0	9.5	1.89	2.37	4.74			9.00	2.9 ~ 10.1	2410	340 ~ 2940	3.73	A	
2.0 + 2.5 + 6.0	10.5	1.71	2.14	5.15			9.00	2.9 ~ 10.7	2410	340 ~ 3410	3.73	A	
2.0 + 2.5 + 7.1	11.6	1.55	1.94	5.51			9.00	2.9 ~ 10.7	2350	340 ~ 3270	3.83	A	
2.0 + 3.5 + 3.5	9.0	2.00	3.50	3.50			9.00	2.9 ~ 9.6	2660	340 ~ 2930	3.38	A	
2.0 + 3.5 + 4.2	9.7	1.85	3.25	3.90			9.00	2.9 ~ 10.7	2660	340 ~ 3910	3.38	A	
2.0 + 3.5 + 5.0	10.5	1.71	3.00	4.29			9.00	2.9 ~ 10.7	2350	340 ~ 3340	3.83	A	
2.0 + 3.5 + 6.0	11.5	1.56	2.74	4.70			9.00	2.9 ~ 10.7	2350	340 ~ 3340	3.83	A	
2.0 + 3.5 + 7.1	12.6	1.43	2.50	5.07			9.00	2.9 ~ 10.7	2280	370 ~ 3200	3.95	A	
2.0 + 4.2 + 4.2	10.4	1.74	3.63	3.63			9.00	2.9 ~ 10.7	2600	340 ~ 3910	3.46	A	
2.0 + 4.2 + 5.0	11.2	1.60	3.38	4.02			9.00	2.9 ~ 10.7	2350	340 ~ 3270	3.83	A	
2.0 + 4.2 + 6.0	12.2	1.47	3.10	4.43			9.00	2.9 ~ 10.7	2350	340 ~ 3270	3.83	A	
2.0 + 4.2 + 7.1	13.3	1.35	2.84	4.81			9.00	2.9 ~ 10.7	2280	370 ~ 3200	3.95	A	

	Indoor unit capacity Cooling	Annual Energy Consumption (kWh)	Current 230V (A)	ERP				Moisture Removal Volume l/h
				Pdesign (kW)	SEER		Annual Consumption (kWh)	
					WW	CLASS		
3 Room	1.6 + 1.6 + 1.6	495	4.9	4.80	7.20	A++	233	1.0 + 1.0 + 1.0
	1.6 + 1.6 + 2.0	550	5.4	5.20	7.20	A++	253	1.0 + 1.0 + 1.3
	1.6 + 1.6 + 2.5	645	6.2	5.70	7.20	A++	277	1.0 + 1.0 + 1.5
	1.6 + 1.6 + 3.5	805	7.8	6.70	7.20	A++	326	1.0 + 1.0 + 2.0
	1.6 + 1.6 + 4.2	975	9.3	7.40	7.20	A++	360	1.0 + 1.0 + 2.4
	1.6 + 1.6 + 5.0	1055	10.1	8.20	7.20	A++	399	1.0 + 1.0 + 2.7
	1.6 + 1.6 + 6.0	1235	11.8	9.00	7.20	A++	438	1.0 + 1.0 + 3.2
	1.6 + 1.6 + 7.1	1205	11.5	9.00	7.20	A++	438	0.9 + 0.9 + 3.5
	1.6 + 2.0 + 2.0	620	6.0	5.60	7.20	A++	272	1.0 + 1.3 + 1.3
	1.6 + 2.0 + 2.5	725	7.0	6.10	7.20	A++	297	1.0 + 1.3 + 1.5
	1.6 + 2.0 + 3.5	890	8.5	7.10	7.20	A++	345	1.0 + 1.3 + 2.0
	1.6 + 2.0 + 4.2	1030	9.9	7.80	7.20	A++	379	1.0 + 1.3 + 2.4
	1.6 + 2.0 + 5.0	1150	11.0	8.60	7.20	A++	418	1.0 + 1.3 + 2.7
	1.6 + 2.0 + 6.0	1205	11.5	9.00	7.20	A++	438	0.9 + 1.2 + 3.1
	1.6 + 2.0 + 7.1	1175	11.2	9.00	7.20	A++	438	0.9 + 1.1 + 3.3
	1.6 + 2.5 + 2.5	830	8.0	6.60	7.20	A++	321	1.0 + 1.5 + 1.5
	1.6 + 2.5 + 3.5	1030	9.9	7.60	7.20	A++	369	1.0 + 1.5 + 2.0
	1.6 + 2.5 + 4.2	1180	11.3	8.30	7.20	A++	403	1.0 + 1.5 + 2.4
	1.6 + 2.5 + 5.0	1205	11.5	9.00	7.20	A++	438	1.0 + 1.5 + 2.7
	1.6 + 2.5 + 6.0	1205	11.5	9.00	7.20	A++	438	0.9 + 1.5 + 2.9
	1.6 + 2.5 + 7.1	1175	11.2	9.00	7.20	A++	438	0.8 + 1.3 + 3.1
	1.6 + 3.5 + 3.5	1245	11.9	8.60	7.20	A++	418	1.0 + 2.0 + 2.0
	1.6 + 3.5 + 4.2	1330	12.7	9.00	7.20	A++	438	1.0 + 1.9 + 2.3
	1.6 + 3.5 + 5.0	1205	11.5	9.00	7.20	A++	438	0.9 + 1.8 + 2.5
	1.6 + 3.5 + 6.0	1205	11.5	9.00	7.20	A++	438	0.8 + 1.7 + 2.6
	1.6 + 3.5 + 7.1	1175	11.2	9.00	7.20	A++	438	0.7 + 1.6 + 2.9
	1.6 + 4.2 + 4.2	1330	12.7	9.00	7.20	A++	438	0.9 + 2.2 + 2.2
	1.6 + 4.2 + 5.0	1175	11.2	9.00	7.20	A++	438	0.8 + 2.0 + 2.4
	1.6 + 4.2 + 6.0	1175	11.2	9.00	7.20	A++	438	0.8 + 1.8 + 2.5
	1.6 + 4.2 + 7.1	1140	10.9	9.00	7.20	A++	438	0.7 + 1.7 + 2.7
	1.6 + 5.0 + 5.0	1080	10.3	9.00	7.20	A++	438	0.8 + 2.3 + 2.3
	1.6 + 5.0 + 6.0	1080	10.3	9.00	7.20	A++	438	0.7 + 2.1 + 2.4
	1.6 + 5.0 + 7.1	1085	10.4	9.00	7.20	A++	438	0.7 + 1.9 + 2.5
	1.6 + 6.0 + 6.0	1080	10.3	9.00	7.20	A++	438	0.7 + 2.3 + 2.3
	1.6 + 6.0 + 7.1	1085	10.4	9.00	7.20	A++	438	0.7 + 2.1 + 2.4
	1.6 + 7.1 + 7.1	1055	10.1	9.00	7.20	A++	438	0.7 + 2.3 + 2.3
	2.0 + 2.0 + 2.0	695	6.7	6.00	7.20	A++	292	1.3 + 1.3 + 1.3
	2.0 + 2.0 + 2.5	800	7.7	6.50	7.20	A++	316	1.3 + 1.3 + 1.5
	2.0 + 2.0 + 3.5	975	9.3	7.50	7.20	A++	365	1.3 + 1.3 + 2.0
	2.0 + 2.0 + 4.2	1150	11.0	8.20	7.20	A++	399	1.3 + 1.3 + 2.4
2.0 + 2.0 + 5.0	1205	11.5	9.00	7.20	A++	438	1.3 + 1.3 + 2.7	
2.0 + 2.0 + 6.0	1205	11.5	9.00	7.20	A++	438	1.2 + 1.2 + 2.9	
2.0 + 2.0 + 7.1	1175	11.2	9.00	7.20	A++	438	1.0 + 1.0 + 3.2	
2.0 + 2.5 + 2.5	890	8.5	7.00	7.20	A++	340	1.3 + 1.5 + 1.5	
2.0 + 2.5 + 3.5	1090	10.4	8.00	7.20	A++	389	1.3 + 1.5 + 2.0	
2.0 + 2.5 + 4.2	1270	12.2	8.70	7.20	A++	423	1.3 + 1.5 + 2.4	
2.0 + 2.5 + 5.0	1205	11.5	9.00	7.20	A++	438	1.2 + 1.5 + 2.6	
2.0 + 2.5 + 6.0	1205	11.5	9.00	7.20	A++	438	1.1 + 1.4 + 2.8	
2.0 + 2.5 + 7.1	1175	11.2	9.00	7.20	A++	438	1.0 + 1.3 + 3.0	
2.0 + 3.5 + 3.5	1330	12.7	9.00	7.20	A++	438	1.3 + 2.0 + 2.0	
2.0 + 3.5 + 4.2	1330	12.7	9.00	7.20	A++	438	1.2 + 1.8 + 2.3	
2.0 + 3.5 + 5.0	1175	11.2	9.00	7.20	A++	438	1.1 + 1.7 + 2.4	
2.0 + 3.5 + 6.0	1175	11.2	9.00	7.20	A++	438	1.0 + 1.6 + 2.5	
2.0 + 3.5 + 7.1	1140	10.9	9.00	7.20	A++	438	0.9 + 1.5 + 2.8	
2.0 + 4.2 + 4.2	1300	12.4	9.00	7.20	A++	438	1.1 + 2.1 + 2.1	
2.0 + 4.2 + 5.0	1175	11.2	9.00	7.20	A++	438	1.0 + 1.9 + 2.3	
2.0 + 4.2 + 6.0	1175	11.2	9.00	7.20	A++	438	0.9 + 1.7 + 2.5	
2.0 + 4.2 + 7.1	1140	10.9	9.00	7.20	A++	438	0.9 + 1.7 + 2.6	

	Indoor unit capacity Cooling	Total	Cooling Capacity (kW)						Input Power (W)		EER		
			Room A	Room B	Room C	Room D	Room E	Total	min ~ max	Rating	min ~ max	WW	CLASS
3 Room	2.0 + 5.0 + 5.0	12.0	1.50	3.75	3.75			9.00	2.9 ~ 10.7	2160	370 ~ 2940	4.17	A
	2.0 + 5.0 + 6.0	13.0	1.38	3.46	4.16			9.00	2.9 ~ 10.7	2160	370 ~ 2940	4.17	A
	2.0 + 5.0 + 7.1	14.1	1.28	3.19	4.53			9.00	3.0 ~ 10.7	2170	400 ~ 2870	4.15	A
	2.0 + 6.0 + 6.0	14.0	1.28	3.86	3.86			9.00	3.0 ~ 10.7	2160	400 ~ 2940	4.17	A
	2.0 + 6.0 + 7.1	15.1	1.19	3.58	4.23			9.00	3.0 ~ 10.7	2170	400 ~ 2870	4.15	A
	2.0 + 7.1 + 7.1	16.2	1.12	3.94	3.94			9.00	3.0 ~ 10.7	2110	410 ~ 2810	4.27	A
	2.5 + 2.5 + 2.5	7.5	2.50	2.50	2.50			7.50	2.9 ~ 8.5	2010	310 ~ 2550	3.73	A
	2.5 + 2.5 + 3.5	8.5	2.50	2.50	3.50			8.50	2.9 ~ 9.6	2490	340 ~ 3000	3.41	A
	2.5 + 2.5 + 4.2	9.2	2.45	2.45	4.10			9.00	2.9 ~ 10.1	2730	340 ~ 3400	3.30	A
	2.5 + 2.5 + 5.0	10.0	2.25	2.25	4.50			9.00	2.9 ~ 10.7	2410	340 ~ 3410	3.73	A
	2.5 + 2.5 + 6.0	11.0	2.05	2.05	4.90			9.00	2.9 ~ 10.7	2410	340 ~ 3410	3.73	A
	2.5 + 2.5 + 7.1	12.1	1.86	1.86	5.28			9.00	2.9 ~ 10.7	2350	340 ~ 3270	3.83	A
	2.5 + 3.5 + 3.5	9.5	2.36	3.32	3.32			9.00	2.9 ~ 10.1	2660	340 ~ 3330	3.38	A
	2.5 + 3.5 + 4.2	10.2	2.20	3.09	3.71			9.00	2.9 ~ 10.7	2660	340 ~ 3910	3.38	A
	2.5 + 3.5 + 5.0	11.0	2.05	2.86	4.09			9.00	2.9 ~ 10.7	2350	340 ~ 3340	3.83	A
	2.5 + 3.5 + 6.0	12.0	1.87	2.63	4.50			9.00	2.9 ~ 10.7	2350	340 ~ 3340	3.83	A
	2.5 + 3.5 + 7.1	13.1	1.72	2.40	4.88			9.00	2.9 ~ 10.7	2280	370 ~ 3200	3.95	A
	2.5 + 4.2 + 4.2	10.9	2.06	3.47	3.47			9.00	2.9 ~ 10.7	2600	340 ~ 3910	3.46	A
	2.5 + 4.2 + 5.0	11.7	1.92	3.23	3.85			9.00	2.9 ~ 10.7	2350	340 ~ 3270	3.83	A
	2.5 + 4.2 + 6.0	12.7	1.77	2.98	4.25			9.00	2.9 ~ 10.7	2350	340 ~ 3270	3.83	A
	2.5 + 4.2 + 7.1	13.8	1.63	2.74	4.63			9.00	3.0 ~ 10.7	2280	370 ~ 3200	3.95	A
	2.5 + 5.0 + 5.0	12.5	1.80	3.60	3.60			9.00	2.9 ~ 10.7	2160	370 ~ 2940	4.17	A
	2.5 + 5.0 + 6.0	13.5	1.67	3.33	4.00			9.00	3.0 ~ 10.7	2160	400 ~ 2940	4.17	A
	2.5 + 5.0 + 7.1	14.6	1.54	3.08	4.38			9.00	3.0 ~ 10.7	2170	400 ~ 2870	4.15	A
	2.5 + 6.0 + 6.0	14.5	1.56	3.72	3.72			9.00	3.0 ~ 10.7	2160	400 ~ 2940	4.17	A
	2.5 + 6.0 + 7.1	15.6	1.44	3.46	4.10			9.00	3.0 ~ 10.7	2170	400 ~ 2870	4.15	A
	2.5 + 7.1 + 7.1	16.7	1.34	3.83	3.83			9.00	3.0 ~ 10.7	2110	410 ~ 2810	4.27	A
	3.5 + 3.5 + 3.5	10.5	3.00	3.00	3.00			9.00	2.9 ~ 10.7	2600	340 ~ 3830	3.46	A
	3.5 + 3.5 + 4.2	11.2	2.81	2.81	3.38			9.00	2.9 ~ 10.7	2600	340 ~ 3760	3.46	A
	3.5 + 3.5 + 5.0	12.0	2.63	2.63	3.74			9.00	2.9 ~ 10.7	2350	340 ~ 3200	3.83	A
	3.5 + 3.5 + 6.0	13.0	2.42	2.42	4.16			9.00	2.9 ~ 10.7	2350	340 ~ 3200	3.83	A
	3.5 + 3.5 + 7.1	14.1	2.23	2.23	4.54			9.00	3.0 ~ 10.7	2280	370 ~ 3140	3.95	A
	3.5 + 4.2 + 4.2	11.9	2.64	3.18	3.18			9.00	2.9 ~ 10.7	2530	340 ~ 3760	3.56	A
	3.5 + 4.2 + 5.0	12.7	2.48	2.98	3.54			9.00	2.9 ~ 10.7	2280	370 ~ 3200	3.95	A
	3.5 + 4.2 + 6.0	13.7	2.30	2.76	3.94			9.00	3.0 ~ 10.7	2280	370 ~ 3200	3.95	A
	3.5 + 4.2 + 7.1	14.8	2.13	2.55	4.32			9.00	3.0 ~ 10.7	2280	370 ~ 3140	3.95	A
	3.5 + 5.0 + 5.0	13.5	2.34	3.33	3.33			9.00	3.0 ~ 10.7	2170	400 ~ 2870	4.15	A
	3.5 + 5.0 + 6.0	14.5	2.17	3.10	3.73			9.00	3.0 ~ 10.7	2170	400 ~ 2870	4.15	A
	3.5 + 5.0 + 7.1	15.6	2.02	2.88	4.10			9.00	3.0 ~ 10.7	2110	400 ~ 2810	4.27	A
	3.5 + 6.0 + 6.0	15.5	2.04	3.48	3.48			9.00	3.0 ~ 10.7	2170	400 ~ 2870	4.15	A
3.5 + 6.0 + 7.1	16.6	1.90	3.25	3.85			9.00	3.0 ~ 10.7	2110	400 ~ 2810	4.27	A	
3.5 + 7.1 + 7.1	17.7	1.78	3.61	3.61			9.00	3.0 ~ 10.7	2110	430 ~ 2810	4.27	A	
4.2 + 4.2 + 4.2	12.6	3.00	3.00	3.00			9.00	2.9 ~ 10.7	2530	340 ~ 3690	3.56	A	
4.2 + 4.2 + 5.0	13.4	2.82	2.82	3.36			9.00	2.9 ~ 10.7	2280	370 ~ 3200	3.95	A	
4.2 + 4.2 + 6.0	14.4	2.63	2.63	3.74			9.00	3.0 ~ 10.7	2280	370 ~ 3200	3.95	A	
4.2 + 4.2 + 7.1	15.5	2.44	2.44	4.12			9.00	3.0 ~ 10.7	2280	370 ~ 3070	3.95	A	
4.2 + 5.0 + 5.0	14.2	2.66	3.17	3.17			9.00	3.0 ~ 10.7	2170	400 ~ 2870	4.15	A	
4.2 + 5.0 + 6.0	15.2	2.49	2.96	3.55			9.00	3.0 ~ 10.7	2170	400 ~ 2870	4.15	A	
4.2 + 5.0 + 7.1	16.3	2.32	2.76	3.92			9.00	3.0 ~ 10.7	2110	410 ~ 2810	4.27	A	
4.2 + 6.0 + 6.0	16.2	2.34	3.33	3.33			9.00	3.0 ~ 10.7	2170	400 ~ 2870	4.15	A	
4.2 + 6.0 + 7.1	17.3	2.18	3.12	3.70			9.00	3.0 ~ 10.7	2110	410 ~ 2810	4.27	A	
5.0 + 5.0 + 5.0	15.0	3.00	3.00	3.00			9.00	3.0 ~ 10.7	2060	440 ~ 2680	4.37	A	
5.0 + 5.0 + 6.0	16.0	2.81	2.81	3.38			9.00	3.0 ~ 10.7	2060	440 ~ 2680	4.37	A	
5.0 + 5.0 + 7.1	17.1	2.63	2.63	3.74			9.00	3.0 ~ 10.7	2060	470 ~ 2690	4.37	A	
5.0 + 6.0 + 6.0	17.0	2.64	3.18	3.18			9.00	3.0 ~ 10.7	2060	440 ~ 2680	4.37	A	
5.0 + 6.0 + 7.1	18.1	2.49	2.98	3.53			9.00	3.0 ~ 10.7	2060	470 ~ 2690	4.37	A	
6.0 + 6.0 + 6.0	18.0	3.00	3.00	3.00			9.00	3.0 ~ 10.7	2060	440 ~ 2680	4.37	A	



	Indoor unit capacity Cooling	Annual Energy Consumption (kWh)	Current 230V (A)	ERP				Moisture Removal Volume l/h
				Pdesign (kW)	SEER		Annual Consumption (kWh)	
					WW	CLASS		
3 Room	2.0 + 5.0 + 5.0	1080	10.3	9.00	7.20	A++	438	1.0 + 2.2 + 2.2
	2.0 + 5.0 + 6.0	1080	10.3	9.00	7.20	A++	438	0.9 + 2.0 + 2.4
	2.0 + 5.0 + 7.1	1085	10.4	9.00	7.20	A++	438	0.8 + 1.8 + 2.5
	2.0 + 6.0 + 6.0	1080	10.3	9.00	7.20	A++	438	0.8 + 2.3 + 2.3
	2.0 + 6.0 + 7.1	1085	10.4	9.00	7.20	A++	438	0.7 + 2.1 + 2.4
	2.0 + 7.1 + 7.1	1055	10.1	9.00	7.20	A++	438	0.7 + 2.3 + 2.3
	2.5 + 2.5 + 2.5	1005	9.6	7.50	7.20	A++	365	1.5 + 1.5 + 1.5
	2.5 + 2.5 + 3.5	1245	11.9	8.50	7.20	A++	413	1.5 + 1.5 + 2.0
	2.5 + 2.5 + 4.2	1365	13.1	9.00	7.20	A++	438	1.5 + 1.5 + 2.3
	2.5 + 2.5 + 5.0	1205	11.5	9.00	7.20	A++	438	1.5 + 1.5 + 2.5
	2.5 + 2.5 + 6.0	1205	11.5	9.00	7.20	A++	438	1.3 + 1.3 + 2.7
	2.5 + 2.5 + 7.1	1175	11.2	9.00	7.20	A++	438	1.2 + 1.2 + 2.9
	2.5 + 3.5 + 3.5	1330	12.7	9.00	7.20	A++	438	1.5 + 1.9 + 1.9
	2.5 + 3.5 + 4.2	1330	12.7	9.00	7.20	A++	438	1.4 + 1.7 + 2.2
	2.5 + 3.5 + 5.0	1175	11.2	9.00	7.20	A++	438	1.3 + 1.7 + 2.3
	2.5 + 3.5 + 6.0	1175	11.2	9.00	7.20	A++	438	1.2 + 1.6 + 2.5
	2.5 + 3.5 + 7.1	1140	10.9	9.00	7.20	A++	438	1.1 + 1.5 + 2.7
	2.5 + 4.2 + 4.2	1300	12.4	9.00	7.20	A++	438	1.3 + 2.0 + 2.0
	2.5 + 4.2 + 5.0	1175	11.2	9.00	7.20	A++	438	1.2 + 1.8 + 2.3
	2.5 + 4.2 + 6.0	1175	11.2	9.00	7.20	A++	438	1.1 + 1.7 + 2.4
	2.5 + 4.2 + 7.1	1140	10.9	9.00	7.20	A++	438	1.0 + 1.6 + 2.5
	2.5 + 5.0 + 5.0	1080	10.3	9.00	7.20	A++	438	1.2 + 2.1 + 2.1
	2.5 + 5.0 + 6.0	1080	10.3	9.00	7.20	A++	438	1.1 + 1.9 + 2.3
	2.5 + 5.0 + 7.1	1085	10.4	9.00	7.20	A++	438	1.0 + 1.7 + 2.4
	2.5 + 6.0 + 6.0	1080	10.3	9.00	7.20	A++	438	1.0 + 2.2 + 2.2
	2.5 + 6.0 + 7.1	1085	10.4	9.00	7.20	A++	438	0.9 + 2.0 + 2.3
	2.5 + 7.1 + 7.1	1055	10.1	9.00	7.20	A++	438	0.8 + 2.2 + 2.2
	3.5 + 3.5 + 3.5	1300	12.4	9.00	7.20	A++	438	1.7 + 1.7 + 1.7
	3.5 + 3.5 + 4.2	1300	12.4	9.00	7.20	A++	438	1.6 + 1.6 + 1.9
	3.5 + 3.5 + 5.0	1175	11.2	9.00	7.20	A++	438	1.6 + 1.6 + 2.2
	3.5 + 3.5 + 6.0	1175	11.2	9.00	7.20	A++	438	1.5 + 1.5 + 2.4
	3.5 + 3.5 + 7.1	1140	10.9	9.00	7.20	A++	438	1.5 + 1.5 + 2.5
	3.5 + 4.2 + 4.2	1265	12.1	9.00	7.20	A++	438	1.6 + 1.8 + 1.8
	3.5 + 4.2 + 5.0	1140	10.9	9.00	7.20	A++	438	1.5 + 1.7 + 2.0
	3.5 + 4.2 + 6.0	1140	10.9	9.00	7.20	A++	438	1.5 + 1.6 + 2.3
	3.5 + 4.2 + 7.1	1140	10.9	9.00	7.20	A++	438	1.4 + 1.6 + 2.4
	3.5 + 5.0 + 5.0	1085	10.4	9.00	7.20	A++	438	1.5 + 1.9 + 1.9
	3.5 + 5.0 + 6.0	1085	10.4	9.00	7.20	A++	438	1.4 + 1.7 + 2.2
	3.5 + 5.0 + 7.1	1055	10.1	9.00	7.20	A++	438	1.3 + 1.7 + 2.3
	3.5 + 6.0 + 6.0	1085	10.4	9.00	7.20	A++	438	1.3 + 2.0 + 2.0
	3.5 + 6.0 + 7.1	1055	10.1	9.00	7.20	A++	438	1.2 + 1.8 + 2.3
	3.5 + 7.1 + 7.1	1055	10.1	9.00	7.20	A++	438	1.1 + 2.1 + 2.1
	4.2 + 4.2 + 4.2	1265	12.1	9.00	7.20	A++	438	1.7 + 1.7 + 1.7
	4.2 + 4.2 + 5.0	1140	10.9	9.00	7.20	A++	438	1.7 + 1.7 + 1.9
	4.2 + 4.2 + 6.0	1140	10.9	9.00	7.20	A++	438	1.6 + 1.6 + 2.2
4.2 + 4.2 + 7.1	1140	10.9	9.00	7.20	A++	438	1.5 + 1.5 + 2.3	
4.2 + 5.0 + 5.0	1085	10.4	9.00	7.20	A++	438	1.6 + 1.8 + 1.8	
4.2 + 5.0 + 6.0	1085	10.4	9.00	7.20	A++	438	1.5 + 1.7 + 2.1	
4.2 + 5.0 + 7.1	1055	10.1	9.00	7.20	A++	438	1.5 + 1.6 + 2.3	
4.2 + 6.0 + 6.0	1085	10.4	9.00	7.20	A++	438	1.5 + 1.9 + 1.9	
4.2 + 6.0 + 7.1	1055	10.1	9.00	7.20	A++	438	1.4 + 1.8 + 2.2	
5.0 + 5.0 + 5.0	1030	9.9	9.00	7.20	A++	438	1.7 + 1.7 + 1.7	
5.0 + 5.0 + 6.0	1030	9.9	9.00	7.20	A++	438	1.6 + 1.6 + 1.9	
5.0 + 5.0 + 7.1	1030	9.9	9.00	7.20	A++	438	1.6 + 1.6 + 2.2	
5.0 + 6.0 + 6.0	1030	9.9	9.00	7.20	A++	438	1.6 + 1.8 + 1.8	
5.0 + 6.0 + 7.1	1030	9.9	9.00	7.20	A++	438	1.5 + 1.7 + 2.0	
6.0 + 6.0 + 6.0	1030	9.9	9.00	7.20	A++	438	1.7 + 1.7 + 1.7	

Indoor unit capacity Cooling	Total	Cooling Capacity (kW)						Input Power (W)		EER		
		Room A	Room B	Room C	Room D	Room E	Total	min ~ max	Rating	min ~ max	WW	CLASS
1.6 + 1.6 + 1.6 + 1.6	6.4	1.60	1.60	1.60	1.60		6.40	2.9 ~ 10.6	1400	370 ~ 3480	4.57	A
1.6 + 1.6 + 1.6 + 2.0	6.8	1.60	1.60	1.60	2.00		6.80	2.9 ~ 10.6	1540	370 ~ 3480	4.42	A
1.6 + 1.6 + 1.6 + 2.5	7.3	1.60	1.60	1.60	2.50		7.30	2.9 ~ 10.6	1700	370 ~ 3480	4.29	A
1.6 + 1.6 + 1.6 + 3.5	8.3	1.60	1.60	1.60	3.50		8.30	2.9 ~ 10.6	2090	370 ~ 3400	3.97	A
1.6 + 1.6 + 1.6 + 4.2	9.0	1.60	1.60	1.60	4.20		9.00	2.9 ~ 10.6	2380	370 ~ 3400	3.78	A
1.6 + 1.6 + 1.6 + 5.0	9.8	1.47	1.47	1.47	4.59		9.00	2.9 ~ 10.6	2250	410 ~ 3110	4.00	A
1.6 + 1.6 + 1.6 + 6.0	10.8	1.33	1.33	1.33	5.01		9.00	2.9 ~ 10.6	2250	410 ~ 3110	4.00	A
1.6 + 1.6 + 1.6 + 7.1	11.9	1.21	1.21	1.21	5.37		9.00	2.9 ~ 10.6	2260	410 ~ 3040	3.98	A
1.6 + 1.6 + 2.0 + 2.0	7.2	1.60	1.60	2.00	2.00		7.20	2.9 ~ 10.6	1650	370 ~ 3400	4.36	A
1.6 + 1.6 + 2.0 + 2.5	7.7	1.60	1.60	2.00	2.50		7.70	2.9 ~ 10.6	1850	370 ~ 3400	4.16	A
1.6 + 1.6 + 2.0 + 3.5	8.7	1.60	1.60	2.00	3.50		8.70	2.9 ~ 10.6	2250	370 ~ 3330	3.87	A
1.6 + 1.6 + 2.0 + 4.2	9.4	1.53	1.53	1.91	4.03		9.00	2.9 ~ 10.6	2380	370 ~ 3330	3.78	A
1.6 + 1.6 + 2.0 + 5.0	10.2	1.41	1.41	1.76	4.42		9.00	2.9 ~ 10.6	2250	410 ~ 3110	4.00	A
1.6 + 1.6 + 2.0 + 6.0	11.2	1.29	1.29	1.60	4.82		9.00	2.9 ~ 10.6	2250	410 ~ 3110	4.00	A
1.6 + 1.6 + 2.0 + 7.1	12.3	1.17	1.17	1.46	5.20		9.00	2.9 ~ 10.8	2260	410 ~ 3180	3.98	A
1.6 + 1.6 + 2.5 + 2.5	8.2	1.60	1.60	2.50	2.50		8.20	2.9 ~ 10.6	2030	370 ~ 3400	4.04	A
1.6 + 1.6 + 2.5 + 3.5	9.2	1.57	1.57	2.44	3.42		9.00	2.9 ~ 10.6	2380	370 ~ 3330	3.78	A
1.6 + 1.6 + 2.5 + 4.2	9.9	1.45	1.45	2.27	3.83		9.00	2.9 ~ 10.6	2380	370 ~ 3330	3.78	A
1.6 + 1.6 + 2.5 + 5.0	10.7	1.35	1.35	2.09	4.21		9.00	2.9 ~ 10.6	2250	410 ~ 3110	4.00	A
1.6 + 1.6 + 2.5 + 6.0	11.7	1.23	1.23	1.92	4.62		9.00	2.9 ~ 10.6	2250	410 ~ 3110	4.00	A
1.6 + 1.6 + 2.5 + 7.1	12.8	1.13	1.13	1.75	4.99		9.00	2.9 ~ 10.8	2260	410 ~ 3180	3.98	A
1.6 + 1.6 + 3.5 + 3.5	10.2	1.41	1.41	3.09	3.09		9.00	2.9 ~ 10.6	2380	370 ~ 3330	3.78	A
1.6 + 1.6 + 3.5 + 4.2	10.9	1.32	1.32	2.89	3.47		9.00	2.9 ~ 10.6	2310	370 ~ 3250	3.90	A
1.6 + 1.6 + 3.5 + 5.0	11.7	1.23	1.23	2.69	3.85		9.00	2.9 ~ 10.6	2260	410 ~ 3040	3.98	A
1.6 + 1.6 + 3.5 + 6.0	12.7	1.13	1.13	2.48	4.26		9.00	2.9 ~ 10.8	2260	410 ~ 3180	3.98	A
1.6 + 1.6 + 3.5 + 7.1	13.8	1.04	1.04	2.28	4.64		9.00	2.9 ~ 10.8	2200	440 ~ 3110	4.09	A
1.6 + 1.6 + 4.2 + 4.2	11.6	1.24	1.24	3.26	3.26		9.00	2.9 ~ 10.6	2310	370 ~ 3250	3.90	A
1.6 + 1.6 + 4.2 + 5.0	12.4	1.16	1.16	3.05	3.63		9.00	2.9 ~ 10.8	2260	410 ~ 3180	3.98	A
1.6 + 1.6 + 4.2 + 6.0	13.4	1.07	1.07	2.82	4.04		9.00	2.9 ~ 10.8	2260	410 ~ 3180	3.98	A
1.6 + 1.6 + 4.2 + 7.1	14.5	0.99	0.99	2.61	4.41		9.00	3.0 ~ 11.0	2200	440 ~ 3260	4.09	A
1.6 + 1.6 + 5.0 + 5.0	13.2	1.09	1.09	3.41	3.41		9.00	2.9 ~ 10.8	2210	480 ~ 2980	4.07	A
1.6 + 1.6 + 5.0 + 6.0	14.2	1.01	1.01	3.17	3.81		9.00	3.0 ~ 11.0	2210	480 ~ 3120	4.07	A
1.6 + 1.6 + 5.0 + 7.1	15.3	0.94	0.94	2.94	4.18		9.00	3.0 ~ 11.0	2210	520 ~ 3120	4.07	A
1.6 + 1.6 + 6.0 + 6.0	15.2	0.95	0.95	3.55	3.55		9.00	3.0 ~ 11.0	2210	480 ~ 3120	4.07	A
1.6 + 1.6 + 6.0 + 7.1	16.3	0.88	0.88	3.31	3.93		9.00	3.0 ~ 11.2	2210	520 ~ 3200	4.07	A
1.6 + 1.6 + 7.1 + 7.1	17.4	0.83	0.83	3.67	3.67		9.00	3.0 ~ 11.2	2150	520 ~ 3200	4.19	A
1.6 + 2.0 + 2.0 + 2.0	7.6	1.60	2.00	2.00	2.00		7.60	2.9 ~ 10.6	1820	370 ~ 3400	4.18	A
1.6 + 2.0 + 2.0 + 2.5	8.1	1.60	2.00	2.00	2.50		8.10	2.9 ~ 10.6	1970	370 ~ 3400	4.11	A
1.6 + 2.0 + 2.0 + 3.5	9.1	1.58	1.98	1.98	3.46		9.00	2.9 ~ 10.6	2380	370 ~ 3330	3.78	A
1.6 + 2.0 + 2.0 + 4.2	9.8	1.46	1.84	1.84	3.86		9.00	2.9 ~ 10.6	2380	370 ~ 3330	3.78	A
1.6 + 2.0 + 2.0 + 5.0	10.6	1.35	1.70	1.70	4.25		9.00	2.9 ~ 10.6	2250	410 ~ 3040	4.00	A
1.6 + 2.0 + 2.0 + 6.0	11.6	1.24	1.55	1.55	4.66		9.00	2.9 ~ 10.6	2250	410 ~ 3040	4.00	A
1.6 + 2.0 + 2.0 + 7.1	12.7	1.13	1.42	1.42	5.03		9.00	2.9 ~ 10.8	2260	440 ~ 3110	3.98	A
1.6 + 2.0 + 2.5 + 2.5	8.6	1.60	2.00	2.50	2.50		8.60	2.9 ~ 10.6	2210	370 ~ 3400	3.89	A
1.6 + 2.0 + 2.5 + 3.5	9.6	1.50	1.88	2.34	3.28		9.00	2.9 ~ 10.6	2380	370 ~ 3330	3.78	A
1.6 + 2.0 + 2.5 + 4.2	10.3	1.40	1.75	2.18	3.67		9.00	2.9 ~ 10.6	2380	370 ~ 3330	3.78	A
1.6 + 2.0 + 2.5 + 5.0	11.1	1.30	1.62	2.03	4.05		9.00	2.9 ~ 10.6	2250	410 ~ 3040	4.00	A
1.6 + 2.0 + 2.5 + 6.0	12.1	1.19	1.49	1.86	4.46		9.00	2.9 ~ 10.8	2250	410 ~ 3180	4.00	A
1.6 + 2.0 + 2.5 + 7.1	13.2	1.09	1.36	1.70	4.85		9.00	2.9 ~ 10.8	2260	440 ~ 3110	3.98	A
1.6 + 2.0 + 3.5 + 3.5	10.6	1.36	1.70	2.97	2.97		9.00	2.9 ~ 10.6	2310	370 ~ 3250	3.90	A
1.6 + 2.0 + 3.5 + 4.2	11.3	1.27	1.59	2.79	3.35		9.00	2.9 ~ 10.6	2310	370 ~ 3250	3.90	A
1.6 + 2.0 + 3.5 + 5.0	12.1	1.19	1.49	2.60	3.72		9.00	2.9 ~ 10.8	2260	410 ~ 3180	3.98	A
1.6 + 2.0 + 3.5 + 6.0	13.1	1.10	1.37	2.40	4.13		9.00	2.9 ~ 10.8	2260	410 ~ 3180	3.98	A
1.6 + 2.0 + 3.5 + 7.1	14.2	1.01	1.27	2.22	4.50		9.00	3.0 ~ 11.0	2200	440 ~ 3260	4.09	A
1.6 + 2.0 + 4.2 + 4.2	12.0	1.20	1.50	3.15	3.15		9.00	2.9 ~ 10.6	2310	370 ~ 3250	3.90	A
1.6 + 2.0 + 4.2 + 5.0	12.8	1.12	1.41	2.95	3.52		9.00	2.9 ~ 10.8	2260	440 ~ 3110	3.98	A
1.6 + 2.0 + 4.2 + 6.0	13.8	1.04	1.30	2.74	3.92		9.00	2.9 ~ 10.8	2260	440 ~ 3110	3.98	A
1.6 + 2.0 + 4.2 + 7.1	14.9	0.96	1.21	2.54	4.29		9.00	3.0 ~ 11.0	2200	440 ~ 3190	4.09	A

4  
Room

Indoor unit capacity Cooling	Annual Energy Consumption (kWh)	Current 230V (A)	ERP				Moisture Removal Volume l/h
			Pdesign (kW)	SEER		Annual Consumption (kWh)	
				WW	CLASS		
1.6 + 1.6 + 1.6 + 1.6	700	6.8	6.40	8.50	A+++	264	1.0 + 1.0 + 1.0 + 1.0
1.6 + 1.6 + 1.6 + 2.0	770	7.4	6.80	8.50	A+++	280	1.0 + 1.0 + 1.0 + 1.3
1.6 + 1.6 + 1.6 + 2.5	850	8.2	7.30	8.00	A++	319	1.0 + 1.0 + 1.0 + 1.5
1.6 + 1.6 + 1.6 + 3.5	1045	10.0	8.30	8.00	A++	363	1.0 + 1.0 + 1.0 + 2.0
1.6 + 1.6 + 1.6 + 4.2	1190	11.4	9.00	8.00	A++	394	1.0 + 1.0 + 1.0 + 2.4
1.6 + 1.6 + 1.6 + 5.0	1125	10.8	9.00	8.00	A++	394	0.9 + 0.9 + 0.9 + 2.5
1.6 + 1.6 + 1.6 + 6.0	1125	10.8	9.00	8.00	A++	394	0.8 + 0.8 + 0.8 + 2.7
1.6 + 1.6 + 1.6 + 7.1	1130	10.8	9.00	8.00	A++	394	0.8 + 0.8 + 0.8 + 2.9
1.6 + 1.6 + 2.0 + 2.0	825	8.0	7.20	8.00	A++	315	1.0 + 1.0 + 1.3 + 1.3
1.6 + 1.6 + 2.0 + 2.5	925	8.9	7.70	8.00	A++	337	1.0 + 1.0 + 1.3 + 1.5
1.6 + 1.6 + 2.0 + 3.5	1125	10.8	8.70	8.00	A++	381	1.0 + 1.0 + 1.3 + 2.0
1.6 + 1.6 + 2.0 + 4.2	1190	11.4	9.00	8.00	A++	394	1.0 + 1.0 + 1.2 + 2.3
1.6 + 1.6 + 2.0 + 5.0	1125	10.8	9.00	8.00	A++	394	0.9 + 0.9 + 1.1 + 2.4
1.6 + 1.6 + 2.0 + 6.0	1125	10.8	9.00	8.00	A++	394	0.8 + 0.8 + 1.0 + 2.6
1.6 + 1.6 + 2.0 + 7.1	1130	10.8	9.00	8.00	A++	394	0.7 + 0.7 + 0.9 + 2.9
1.6 + 1.6 + 2.5 + 2.5	1015	9.7	8.20	8.00	A++	359	1.0 + 1.0 + 1.5 + 1.5
1.6 + 1.6 + 2.5 + 3.5	1190	11.4	9.00	8.00	A++	394	1.0 + 1.0 + 1.5 + 2.0
1.6 + 1.6 + 2.5 + 4.2	1190	11.4	9.00	8.00	A++	394	0.9 + 0.9 + 1.5 + 2.2
1.6 + 1.6 + 2.5 + 5.0	1125	10.8	9.00	8.00	A++	394	0.9 + 0.9 + 1.4 + 2.4
1.6 + 1.6 + 2.5 + 6.0	1125	10.8	9.00	8.00	A++	394	0.8 + 0.8 + 1.2 + 2.5
1.6 + 1.6 + 2.5 + 7.1	1130	10.8	9.00	8.00	A++	394	0.7 + 0.7 + 1.1 + 2.7
1.6 + 1.6 + 3.5 + 3.5	1190	11.4	9.00	8.00	A++	394	0.9 + 0.9 + 1.7 + 1.7
1.6 + 1.6 + 3.5 + 4.2	1155	11.1	9.00	8.00	A++	394	0.8 + 0.8 + 1.7 + 2.0
1.6 + 1.6 + 3.5 + 5.0	1130	10.8	9.00	8.00	A++	394	0.8 + 0.8 + 1.6 + 2.3
1.6 + 1.6 + 3.5 + 6.0	1130	10.8	9.00	8.00	A++	394	0.7 + 0.7 + 1.5 + 2.4
1.6 + 1.6 + 3.5 + 7.1	1100	10.5	9.00	8.00	A++	394	0.7 + 0.7 + 1.5 + 2.5
1.6 + 1.6 + 4.2 + 4.2	1155	11.1	9.00	8.00	A++	394	0.8 + 0.8 + 1.9 + 1.9
1.6 + 1.6 + 4.2 + 5.0	1130	10.8	9.00	8.00	A++	394	0.7 + 0.7 + 1.7 + 2.1
1.6 + 1.6 + 4.2 + 6.0	1130	10.8	9.00	8.00	A++	394	0.7 + 0.7 + 1.7 + 2.3
1.6 + 1.6 + 4.2 + 7.1	1100	10.5	9.00	8.00	A++	394	0.7 + 0.7 + 1.6 + 2.4
1.6 + 1.6 + 5.0 + 5.0	1105	10.6	9.00	8.00	A++	394	0.7 + 0.7 + 2.0 + 2.0
1.6 + 1.6 + 5.0 + 6.0	1105	10.6	9.00	8.00	A++	394	0.7 + 0.7 + 1.8 + 2.2
1.6 + 1.6 + 5.0 + 7.1	1105	10.6	9.00	8.00	A++	394	0.7 + 0.7 + 1.7 + 2.4
1.6 + 1.6 + 6.0 + 6.0	1105	10.6	9.00	8.00	A++	394	0.7 + 0.7 + 2.1 + 2.1
1.6 + 1.6 + 6.0 + 7.1	1105	10.6	9.00	8.00	A++	394	0.7 + 0.7 + 1.9 + 2.3
1.6 + 1.6 + 7.1 + 7.1	1075	10.3	9.00	8.00	A++	394	0.7 + 0.7 + 2.1 + 2.1
1.6 + 2.0 + 2.0 + 2.0	910	8.7	7.60	8.00	A++	333	1.0 + 1.3 + 1.3 + 1.3
1.6 + 2.0 + 2.0 + 2.5	985	9.4	8.10	8.00	A++	354	1.0 + 1.3 + 1.3 + 1.5
1.6 + 2.0 + 2.0 + 3.5	1190	11.4	9.00	8.00	A++	394	1.0 + 1.3 + 1.3 + 2.0
1.6 + 2.0 + 2.0 + 4.2	1190	11.4	9.00	8.00	A++	394	0.9 + 1.2 + 1.2 + 2.3
1.6 + 2.0 + 2.0 + 5.0	1125	10.8	9.00	8.00	A++	394	0.9 + 1.1 + 1.1 + 2.4
1.6 + 2.0 + 2.0 + 6.0	1125	10.8	9.00	8.00	A++	394	0.8 + 1.0 + 1.0 + 2.5
1.6 + 2.0 + 2.0 + 7.1	1130	10.8	9.00	8.00	A++	394	0.7 + 0.9 + 0.9 + 2.8
1.6 + 2.0 + 2.5 + 2.5	1105	10.6	8.60	8.00	A++	376	1.0 + 1.3 + 1.5 + 1.5
1.6 + 2.0 + 2.5 + 3.5	1190	11.4	9.00	8.00	A++	394	1.0 + 1.2 + 1.5 + 1.9
1.6 + 2.0 + 2.5 + 4.2	1190	11.4	9.00	8.00	A++	394	0.9 + 1.1 + 1.4 + 2.1
1.6 + 2.0 + 2.5 + 5.0	1125	10.8	9.00	8.00	A++	394	0.8 + 1.0 + 1.3 + 2.3
1.6 + 2.0 + 2.5 + 6.0	1125	10.8	9.00	8.00	A++	394	0.7 + 0.9 + 1.2 + 2.5
1.6 + 2.0 + 2.5 + 7.1	1130	10.8	9.00	8.00	A++	394	0.7 + 0.9 + 1.1 + 2.6
1.6 + 2.0 + 3.5 + 3.5	1155	11.1	9.00	8.00	A++	394	0.9 + 1.1 + 1.7 + 1.7
1.6 + 2.0 + 3.5 + 4.2	1155	11.1	9.00	8.00	A++	394	0.8 + 1.0 + 1.6 + 1.9
1.6 + 2.0 + 3.5 + 5.0	1130	10.8	9.00	8.00	A++	394	0.7 + 0.9 + 1.6 + 2.2
1.6 + 2.0 + 3.5 + 6.0	1130	10.8	9.00	8.00	A++	394	0.7 + 0.9 + 1.5 + 2.3
1.6 + 2.0 + 3.5 + 7.1	1100	10.5	9.00	8.00	A++	394	0.7 + 0.8 + 1.4 + 2.5
1.6 + 2.0 + 4.2 + 4.2	1155	11.1	9.00	8.00	A++	394	0.7 + 1.0 + 1.8 + 1.8
1.6 + 2.0 + 4.2 + 5.0	1130	10.8	9.00	8.00	A++	394	0.7 + 0.9 + 1.7 + 2.0
1.6 + 2.0 + 4.2 + 6.0	1130	10.8	9.00	8.00	A++	394	0.7 + 0.8 + 1.6 + 2.3
1.6 + 2.0 + 4.2 + 7.1	1100	10.5	9.00	8.00	A++	394	0.7 + 0.8 + 1.6 + 2.4

4  
Room

	Indoor unit capacity Cooling	Total	Cooling Capacity (kW)						Input Power (W)		EER		
			Room A	Room B	Room C	Room D	Room E	Total	min ~ max	Rating	min ~ max	WW	CLASS
4 Room	1.6 + 2.0 + 5.0 + 5.0	13.6	1.06	1.32	3.31	3.31		9.00	2.9 ~ 10.8	2210	490 ~ 2980	4.07	A
	1.6 + 2.0 + 5.0 + 6.0	14.6	0.99	1.23	3.08	3.70		9.00	3.0 ~ 11.0	2210	490 ~ 3120	4.07	A
	1.6 + 2.0 + 5.0 + 7.1	15.7	0.91	1.15	2.87	4.07		9.00	3.0 ~ 11.0	2210	520 ~ 3050	4.07	A
	1.6 + 2.0 + 6.0 + 6.0	15.6	0.92	1.16	3.46	3.46		9.00	3.0 ~ 11.0	2210	490 ~ 3120	4.07	A
	1.6 + 2.0 + 6.0 + 7.1	16.7	0.86	1.08	3.23	3.83		9.00	3.0 ~ 11.2	2210	520 ~ 3200	4.07	A
	1.6 + 2.0 + 7.1 + 7.1	17.8	0.81	1.01	3.59	3.59		9.00	3.0 ~ 11.2	2160	530 ~ 3200	4.17	A
	1.6 + 2.5 + 2.5 + 2.5	9.1	1.59	2.47	2.47	2.47		9.00	2.9 ~ 10.6	2380	370 ~ 3400	3.78	A
	1.6 + 2.5 + 2.5 + 3.5	10.1	1.42	2.23	2.23	3.12		9.00	2.9 ~ 10.6	2380	370 ~ 3330	3.78	A
	1.6 + 2.5 + 2.5 + 4.2	10.8	1.33	2.08	2.08	3.51		9.00	2.9 ~ 10.6	2380	370 ~ 3330	3.78	A
	1.6 + 2.5 + 2.5 + 5.0	11.6	1.24	1.94	1.94	3.88		9.00	2.9 ~ 10.6	2250	410 ~ 3040	4.00	A
	1.6 + 2.5 + 2.5 + 6.0	12.6	1.13	1.79	1.79	4.29		9.00	2.9 ~ 10.8	2250	410 ~ 3180	4.00	A
	1.6 + 2.5 + 2.5 + 7.1	13.7	1.05	1.64	1.64	4.67		9.00	2.9 ~ 10.8	2260	440 ~ 3110	3.98	A
	1.6 + 2.5 + 3.5 + 3.5	11.1	1.29	2.03	2.84	2.84		9.00	2.9 ~ 10.6	2310	370 ~ 3250	3.90	A
	1.6 + 2.5 + 3.5 + 4.2	11.8	1.22	1.91	2.67	3.20		9.00	2.9 ~ 10.6	2310	370 ~ 3250	3.90	A
	1.6 + 2.5 + 3.5 + 5.0	12.6	1.14	1.79	2.50	3.57		9.00	2.9 ~ 10.8	2260	410 ~ 3180	3.98	A
	1.6 + 2.5 + 3.5 + 6.0	13.6	1.06	1.65	2.32	3.97		9.00	2.9 ~ 10.8	2260	410 ~ 3180	3.98	A
	1.6 + 2.5 + 3.5 + 7.1	14.7	0.98	1.53	2.14	4.35		9.00	3.0 ~ 11.0	2200	440 ~ 3260	4.09	A
	1.6 + 2.5 + 4.2 + 4.2	12.5	1.15	1.81	3.02	3.02		9.00	2.9 ~ 10.8	2310	370 ~ 3400	3.90	A
	1.6 + 2.5 + 4.2 + 5.0	13.3	1.08	1.69	2.84	3.39		9.00	2.9 ~ 10.8	2260	440 ~ 3110	3.98	A
	1.6 + 2.5 + 4.2 + 6.0	14.3	1.01	1.57	2.64	3.78		9.00	3.0 ~ 11.0	2260	440 ~ 3260	3.98	A
	1.6 + 2.5 + 4.2 + 7.1	15.4	0.94	1.46	2.45	4.15		9.00	3.0 ~ 11.0	2200	440 ~ 3190	4.09	A
	1.6 + 2.5 + 5.0 + 5.0	14.1	1.02	1.60	3.19	3.19		9.00	2.9 ~ 10.8	2210	490 ~ 2980	4.07	A
	1.6 + 2.5 + 5.0 + 6.0	15.1	0.95	1.49	2.98	3.58		9.00	3.0 ~ 11.0	2210	490 ~ 3120	4.07	A
	1.6 + 2.5 + 5.0 + 7.1	16.2	0.89	1.39	2.78	3.94		9.00	3.0 ~ 11.2	2210	520 ~ 3200	4.07	A
	1.6 + 2.5 + 6.0 + 6.0	16.1	0.89	1.41	3.35	3.35		9.00	3.0 ~ 11.2	2210	490 ~ 3190	4.07	A
	1.6 + 2.5 + 6.0 + 7.1	17.2	0.83	1.31	3.14	3.72		9.00	3.0 ~ 11.2	2210	520 ~ 3200	4.07	A
	1.6 + 2.5 + 7.1 + 7.1	18.3	0.79	1.23	3.49	3.49		9.00	3.0 ~ 11.2	2160	530 ~ 3200	4.17	A
	1.6 + 3.5 + 3.5 + 3.5	12.1	1.20	2.60	2.60	2.60		9.00	2.9 ~ 10.8	2310	380 ~ 3330	3.90	A
	1.6 + 3.5 + 3.5 + 4.2	12.8	1.13	2.46	2.46	2.95		9.00	2.9 ~ 10.8	2310	400 ~ 3330	3.90	A
	1.6 + 3.5 + 3.5 + 5.0	13.6	1.05	2.32	2.32	3.31		9.00	2.9 ~ 10.8	2200	440 ~ 3110	4.09	A
	1.6 + 3.5 + 3.5 + 6.0	14.6	0.98	2.16	2.16	3.70		9.00	3.0 ~ 11.0	2200	440 ~ 3260	4.09	A
	1.6 + 3.5 + 3.5 + 7.1	15.7	0.91	2.01	2.01	4.07		9.00	3.0 ~ 11.0	2200	470 ~ 3190	4.09	A
	1.6 + 3.5 + 4.2 + 4.2	13.5	1.07	2.33	2.80	2.80		9.00	2.9 ~ 10.8	2310	400 ~ 3330	3.90	A
	1.6 + 3.5 + 4.2 + 5.0	14.3	1.01	2.20	2.64	3.15		9.00	3.0 ~ 11.0	2200	440 ~ 3260	4.09	A
	1.6 + 3.5 + 4.2 + 6.0	15.3	0.94	2.06	2.47	3.53		9.00	3.0 ~ 11.0	2200	440 ~ 3260	4.09	A
	1.6 + 3.5 + 4.2 + 7.1	16.4	0.88	1.92	2.30	3.90		9.00	3.0 ~ 11.2	2200	470 ~ 3330	4.09	A
	1.6 + 3.5 + 5.0 + 5.0	15.1	0.95	2.09	2.98	2.98		9.00	3.0 ~ 11.0	2210	520 ~ 3050	4.07	A
	1.6 + 3.5 + 5.0 + 6.0	16.1	0.89	1.96	2.80	3.35		9.00	3.0 ~ 11.2	2210	520 ~ 3200	4.07	A
	1.6 + 3.5 + 5.0 + 7.1	17.2	0.83	1.83	2.62	3.72		9.00	3.0 ~ 11.2	2150	520 ~ 3200	4.19	A
	1.6 + 3.5 + 6.0 + 6.0	17.1	0.84	1.84	3.16	3.16		9.00	3.0 ~ 11.2	2210	520 ~ 3200	4.07	A
1.6 + 3.5 + 6.0 + 7.1	18.2	0.79	1.73	2.97	3.51		9.00	3.0 ~ 11.2	2150	520 ~ 3200	4.19	A	
1.6 + 4.2 + 4.2 + 4.2	14.2	1.02	2.66	2.66	2.66		9.00	3.0 ~ 11.0	2310	400 ~ 3480	3.90	A	
1.6 + 4.2 + 4.2 + 5.0	15.0	0.96	2.52	2.52	3.00		9.00	3.0 ~ 11.0	2200	440 ~ 3190	4.09	A	
1.6 + 4.2 + 4.2 + 6.0	16.0	0.90	2.36	2.36	3.38		9.00	3.0 ~ 11.2	2200	440 ~ 3330	4.09	A	
1.6 + 4.2 + 4.2 + 7.1	17.1	0.84	2.21	2.21	3.74		9.00	3.0 ~ 11.2	2200	480 ~ 3340	4.09	A	
1.6 + 4.2 + 5.0 + 5.0	15.8	0.91	2.39	2.85	2.85		9.00	3.0 ~ 11.2	2210	520 ~ 3200	4.07	A	
1.6 + 4.2 + 5.0 + 6.0	16.8	0.86	2.25	2.68	3.21		9.00	3.0 ~ 11.2	2210	520 ~ 3200	4.07	A	
1.6 + 4.2 + 5.0 + 7.1	17.9	0.80	2.11	2.51	3.58		9.00	3.0 ~ 11.2	2160	530 ~ 3200	4.17	A	
1.6 + 4.2 + 6.0 + 6.0	17.8	0.81	2.13	3.03	3.03		9.00	3.0 ~ 11.2	2210	520 ~ 3200	4.07	A	
1.6 + 5.0 + 5.0 + 5.0	16.6	0.87	2.71	2.71	2.71		9.00	3.0 ~ 11.2	2170	570 ~ 3140	4.15	A	
1.6 + 5.0 + 5.0 + 6.0	17.6	0.81	2.56	2.56	3.07		9.00	3.0 ~ 11.2	2170	570 ~ 3140	4.15	A	
2.0 + 2.0 + 2.0 + 2.0	8.0	2.00	2.00	2.00	2.00		8.00	2.9 ~ 10.6	1970	370 ~ 3400	4.06	A	
2.0 + 2.0 + 2.0 + 2.5	8.5	2.00	2.00	2.00	2.50		8.50	2.9 ~ 10.6	2150	370 ~ 3400	3.95	A	
2.0 + 2.0 + 2.0 + 3.5	9.5	1.89	1.89	1.89	3.33		9.00	2.9 ~ 10.6	2380	370 ~ 3330	3.78	A	
2.0 + 2.0 + 2.0 + 4.2	10.2	1.76	1.76	1.76	3.72		9.00	2.9 ~ 10.6	2380	370 ~ 3330	3.78	A	
2.0 + 2.0 + 2.0 + 5.0	11.0	1.64	1.64	1.64	4.08		9.00	2.9 ~ 10.6	2250	410 ~ 3040	4.00	A	
2.0 + 2.0 + 2.0 + 6.0	12.0	1.50	1.50	1.50	4.50		9.00	2.9 ~ 10.6	2250	410 ~ 3040	4.00	A	
2.0 + 2.0 + 2.0 + 7.1	13.1	1.37	1.37	1.37	4.89		9.00	2.9 ~ 10.8	2200	440 ~ 3110	4.09	A	

Indoor unit capacity Cooling	Annual Energy Consumption (kWh)	Current 230V (A)	ERP				Moisture Removal Volume l/h
			Pdesign (kW)	SEER		Annual Consumption (kWh)	
				WW	CLASS		
1.6 + 2.0 + 5.0 + 5.0	1105	10.6	9.00	8.00	A++	394	0.7 + 0.8 + 1.9 + 1.9
1.6 + 2.0 + 5.0 + 6.0	1105	10.6	9.00	8.00	A++	394	0.7 + 0.8 + 1.7 + 2.2
1.6 + 2.0 + 5.0 + 7.1	1105	10.6	9.00	8.00	A++	394	0.7 + 0.7 + 1.7 + 2.3
1.6 + 2.0 + 6.0 + 6.0	1105	10.6	9.00	8.00	A++	394	0.7 + 0.7 + 2.0 + 2.0
1.6 + 2.0 + 6.0 + 7.1	1105	10.6	9.00	8.00	A++	394	0.7 + 0.7 + 1.8 + 2.2
1.6 + 2.0 + 7.1 + 7.1	1080	10.3	9.00	8.00	A++	394	0.7 + 0.7 + 2.1 + 2.1
1.6 + 2.5 + 2.5 + 2.5	1190	11.4	9.00	8.00	A++	394	1.0 + 1.5 + 1.5 + 1.5
1.6 + 2.5 + 2.5 + 3.5	1190	11.4	9.00	8.00	A++	394	0.9 + 1.5 + 1.5 + 1.8
1.6 + 2.5 + 2.5 + 4.2	1190	11.4	9.00	8.00	A++	394	0.8 + 1.3 + 1.3 + 2.0
1.6 + 2.5 + 2.5 + 5.0	1125	10.8	9.00	8.00	A++	394	0.8 + 1.3 + 1.3 + 2.3
1.6 + 2.5 + 2.5 + 6.0	1125	10.8	9.00	8.00	A++	394	0.7 + 1.2 + 1.2 + 2.4
1.6 + 2.5 + 2.5 + 7.1	1130	10.8	9.00	8.00	A++	394	0.7 + 1.0 + 1.0 + 2.5
1.6 + 2.5 + 3.5 + 3.5	1155	11.1	9.00	8.00	A++	394	0.8 + 1.3 + 1.7 + 1.7
1.6 + 2.5 + 3.5 + 4.2	1155	11.1	9.00	8.00	A++	394	0.8 + 1.2 + 1.6 + 1.8
1.6 + 2.5 + 3.5 + 5.0	1130	10.8	9.00	8.00	A++	394	0.7 + 1.2 + 1.5 + 2.1
1.6 + 2.5 + 3.5 + 6.0	1130	10.8	9.00	8.00	A++	394	0.7 + 1.1 + 1.5 + 2.3
1.6 + 2.5 + 3.5 + 7.1	1100	10.5	9.00	8.00	A++	394	0.7 + 1.0 + 1.4 + 2.4
1.6 + 2.5 + 4.2 + 4.2	1155	11.1	9.00	8.00	A++	394	0.7 + 1.2 + 1.7 + 1.7
1.6 + 2.5 + 4.2 + 5.0	1130	10.8	9.00	8.00	A++	394	0.7 + 1.1 + 1.7 + 1.9
1.6 + 2.5 + 4.2 + 6.0	1130	10.8	9.00	8.00	A++	394	0.7 + 1.0 + 1.6 + 2.2
1.6 + 2.5 + 4.2 + 7.1	1100	10.5	9.00	8.00	A++	394	0.7 + 0.9 + 1.5 + 2.4
1.6 + 2.5 + 5.0 + 5.0	1105	10.6	9.00	8.00	A++	394	0.7 + 1.0 + 1.8 + 1.8
1.6 + 2.5 + 5.0 + 6.0	1105	10.6	9.00	8.00	A++	394	0.7 + 0.9 + 1.7 + 2.1
1.6 + 2.5 + 5.0 + 7.1	1105	10.6	9.00	8.00	A++	394	0.7 + 0.9 + 1.6 + 2.3
1.6 + 2.5 + 6.0 + 6.0	1105	10.6	9.00	8.00	A++	394	0.7 + 0.9 + 1.9 + 1.9
1.6 + 2.5 + 6.0 + 7.1	1105	10.6	9.00	8.00	A++	394	0.7 + 0.8 + 1.8 + 2.2
1.6 + 2.5 + 7.1 + 7.1	1080	10.3	9.00	8.00	A++	394	0.7 + 0.8 + 2.0 + 2.0
1.6 + 3.5 + 3.5 + 3.5	1155	11.1	9.00	8.00	A++	394	0.7 + 1.6 + 1.6 + 1.6
1.6 + 3.5 + 3.5 + 4.2	1155	11.1	9.00	8.00	A++	394	0.7 + 1.5 + 1.5 + 1.7
1.6 + 3.5 + 3.5 + 5.0	1100	10.5	9.00	8.00	A++	394	0.7 + 1.5 + 1.5 + 1.9
1.6 + 3.5 + 3.5 + 6.0	1100	10.5	9.00	8.00	A++	394	0.7 + 1.4 + 1.4 + 2.2
1.6 + 3.5 + 3.5 + 7.1	1100	10.5	9.00	8.00	A++	394	0.7 + 1.3 + 1.3 + 2.3
1.6 + 3.5 + 4.2 + 4.2	1155	11.1	9.00	8.00	A++	394	0.7 + 1.5 + 1.6 + 1.6
1.6 + 3.5 + 4.2 + 5.0	1100	10.5	9.00	8.00	A++	394	0.7 + 1.4 + 1.6 + 1.8
1.6 + 3.5 + 4.2 + 6.0	1100	10.5	9.00	8.00	A++	394	0.7 + 1.3 + 1.5 + 2.0
1.6 + 3.5 + 4.2 + 7.1	1100	10.5	9.00	8.00	A++	394	0.7 + 1.2 + 1.5 + 2.3
1.6 + 3.5 + 5.0 + 5.0	1105	10.6	9.00	8.00	A++	394	0.7 + 1.4 + 1.7 + 1.7
1.6 + 3.5 + 5.0 + 6.0	1105	10.6	9.00	8.00	A++	394	0.7 + 1.3 + 1.6 + 1.9
1.6 + 3.5 + 5.0 + 7.1	1075	10.3	9.00	8.00	A++	394	0.7 + 1.2 + 1.6 + 2.2
1.6 + 3.5 + 6.0 + 6.0	1105	10.6	9.00	8.00	A++	394	0.7 + 1.2 + 1.8 + 1.8
1.6 + 3.5 + 6.0 + 7.1	1075	10.3	9.00	8.00	A++	394	0.7 + 1.1 + 1.7 + 2.0
1.6 + 4.2 + 4.2 + 4.2	1155	11.1	9.00	8.00	A++	394	0.7 + 1.6 + 1.6 + 1.6
1.6 + 4.2 + 4.2 + 5.0	1100	10.5	9.00	8.00	A++	394	0.7 + 1.5 + 1.5 + 1.7
1.6 + 4.2 + 4.2 + 6.0	1100	10.5	9.00	8.00	A++	394	0.7 + 1.5 + 1.5 + 1.9
1.6 + 4.2 + 4.2 + 7.1	1100	10.5	9.00	8.00	A++	394	0.7 + 1.4 + 1.4 + 2.2
1.6 + 4.2 + 5.0 + 5.0	1105	10.6	9.00	8.00	A++	394	0.7 + 1.5 + 1.7 + 1.7
1.6 + 4.2 + 5.0 + 6.0	1105	10.6	9.00	8.00	A++	394	0.7 + 1.5 + 1.6 + 1.8
1.6 + 4.2 + 5.0 + 7.1	1080	10.3	9.00	8.00	A++	394	0.7 + 1.4 + 1.5 + 2.1
1.6 + 4.2 + 6.0 + 6.0	1105	10.6	9.00	8.00	A++	394	0.7 + 1.4 + 1.7 + 1.7
1.6 + 5.0 + 5.0 + 5.0	1085	10.4	9.00	8.00	A++	394	0.7 + 1.6 + 1.6 + 1.6
1.6 + 5.0 + 5.0 + 6.0	1085	10.4	9.00	8.00	A++	394	0.7 + 1.6 + 1.6 + 1.7
2.0 + 2.0 + 2.0 + 2.0	985	9.4	8.00	8.00	A++	350	1.3 + 1.3 + 1.3 + 1.3
2.0 + 2.0 + 2.0 + 2.5	1075	10.3	8.50	8.00	A++	372	1.3 + 1.3 + 1.3 + 1.5
2.0 + 2.0 + 2.0 + 3.5	1190	11.4	9.00	8.00	A++	394	1.2 + 1.2 + 1.2 + 1.9
2.0 + 2.0 + 2.0 + 4.2	1190	11.4	9.00	8.00	A++	394	1.1 + 1.1 + 1.1 + 2.2
2.0 + 2.0 + 2.0 + 5.0	1125	10.8	9.00	8.00	A++	394	1.0 + 1.0 + 1.0 + 2.3
2.0 + 2.0 + 2.0 + 6.0	1125	10.8	9.00	8.00	A++	394	1.0 + 1.0 + 1.0 + 2.5
2.0 + 2.0 + 2.0 + 7.1	1100	10.5	9.00	8.00	A++	394	0.9 + 0.9 + 0.9 + 2.7

4  
Room

Indoor unit capacity Cooling	Total	Cooling Capacity (kW)							Input Power (W)		EER	
		Room A	Room B	Room C	Room D	Room E	Total	min ~ max	Rating	min ~ max	WW	CLASS
2.0 + 2.0 + 2.5 + 2.5	9.0	2.00	2.00	2.50	2.50		9.00	2.9 ~ 10.6	2380	370 ~ 3400	3.78	A
2.0 + 2.0 + 2.5 + 3.5	10.0	1.80	1.80	2.25	3.15		9.00	2.9 ~ 10.6	2380	370 ~ 3330	3.78	A
2.0 + 2.0 + 2.5 + 4.2	10.7	1.68	1.68	2.10	3.54		9.00	2.9 ~ 10.6	2380	370 ~ 3330	3.78	A
2.0 + 2.0 + 2.5 + 5.0	11.5	1.57	1.57	1.95	3.91		9.00	2.9 ~ 10.6	2250	410 ~ 3040	4.00	A
2.0 + 2.0 + 2.5 + 6.0	12.5	1.44	1.44	1.80	4.32		9.00	2.9 ~ 10.8	2250	410 ~ 3180	4.00	A
2.0 + 2.0 + 2.5 + 7.1	13.6	1.32	1.32	1.65	4.71		9.00	2.9 ~ 10.8	2200	440 ~ 3110	4.09	A
2.0 + 2.0 + 3.5 + 3.5	11.0	1.64	1.64	2.86	2.86		9.00	2.9 ~ 10.6	2310	370 ~ 3250	3.90	A
2.0 + 2.0 + 3.5 + 4.2	11.7	1.54	1.54	2.69	3.23		9.00	2.9 ~ 10.6	2310	370 ~ 3250	3.90	A
2.0 + 2.0 + 3.5 + 5.0	12.5	1.44	1.44	2.52	3.60		9.00	2.9 ~ 10.8	2260	440 ~ 3110	3.98	A
2.0 + 2.0 + 3.5 + 6.0	13.5	1.33	1.33	2.33	4.01		9.00	2.9 ~ 10.8	2260	440 ~ 3110	3.98	A
2.0 + 2.0 + 3.5 + 7.1	14.6	1.23	1.23	2.16	4.38		9.00	3.0 ~ 11.0	2200	440 ~ 3190	4.09	A
2.0 + 2.0 + 4.2 + 4.2	12.4	1.45	1.45	3.05	3.05		9.00	2.9 ~ 10.8	2310	370 ~ 3400	3.90	A
2.0 + 2.0 + 4.2 + 5.0	13.2	1.36	1.36	2.86	3.42		9.00	2.9 ~ 10.8	2200	440 ~ 3110	4.09	A
2.0 + 2.0 + 4.2 + 6.0	14.2	1.27	1.27	2.66	3.80		9.00	3.0 ~ 11.0	2200	440 ~ 3260	4.09	A
2.0 + 2.0 + 4.2 + 7.1	15.3	1.18	1.18	2.46	4.18		9.00	3.0 ~ 11.0	2200	450 ~ 3190	4.09	A
2.0 + 2.0 + 5.0 + 5.0	14.0	1.29	1.29	3.21	3.21		9.00	2.9 ~ 10.8	2210	490 ~ 2980	4.07	A
2.0 + 2.0 + 5.0 + 6.0	15.0	1.20	1.20	3.00	3.60		9.00	3.0 ~ 11.0	2210	490 ~ 3120	4.07	A
2.0 + 2.0 + 5.0 + 7.1	16.1	1.12	1.12	2.79	3.97		9.00	3.0 ~ 11.2	2150	520 ~ 3200	4.19	A
2.0 + 2.0 + 6.0 + 6.0	16.0	1.12	1.12	3.38	3.38		9.00	3.0 ~ 11.2	2210	490 ~ 3190	4.07	A
2.0 + 2.0 + 6.0 + 7.1	17.1	1.05	1.05	3.16	3.74		9.00	3.0 ~ 11.2	2150	520 ~ 3200	4.19	A
2.0 + 2.0 + 7.1 + 7.1	18.2	0.99	0.99	3.51	3.51		9.00	3.0 ~ 11.2	2160	530 ~ 3130	4.17	A
2.0 + 2.5 + 2.5 + 2.5	9.5	1.89	2.37	2.37	2.37		9.00	2.9 ~ 10.6	2380	370 ~ 3400	3.78	A
2.0 + 2.5 + 2.5 + 3.5	10.5	1.71	2.14	2.14	3.01		9.00	2.9 ~ 10.6	2380	370 ~ 3330	3.78	A
2.0 + 2.5 + 2.5 + 4.2	11.2	1.60	2.01	2.01	3.38		9.00	2.9 ~ 10.6	2380	370 ~ 3330	3.78	A
2.0 + 2.5 + 2.5 + 5.0	12.0	1.49	1.88	1.88	3.75		9.00	2.9 ~ 10.6	2250	410 ~ 3040	4.00	A
2.0 + 2.5 + 2.5 + 6.0	13.0	1.38	1.73	1.73	4.16		9.00	2.9 ~ 10.8	2250	410 ~ 3180	4.00	A
2.0 + 2.5 + 2.5 + 7.1	14.1	1.27	1.60	1.60	4.53		9.00	2.9 ~ 10.8	2200	440 ~ 3110	4.09	A
2.0 + 2.5 + 3.5 + 3.5	11.5	1.56	1.96	2.74	2.74		9.00	2.9 ~ 10.6	2310	370 ~ 3250	3.90	A
2.0 + 2.5 + 3.5 + 4.2	12.2	1.48	1.84	2.58	3.10		9.00	2.9 ~ 10.8	2310	370 ~ 3400	3.90	A
2.0 + 2.5 + 3.5 + 5.0	13.0	1.38	1.73	2.42	3.47		9.00	2.9 ~ 10.8	2260	440 ~ 3110	3.98	A
2.0 + 2.5 + 3.5 + 6.0	14.0	1.28	1.61	2.25	3.86		9.00	2.9 ~ 10.8	2260	440 ~ 3110	3.98	A
2.0 + 2.5 + 3.5 + 7.1	15.1	1.19	1.49	2.09	4.23		9.00	3.0 ~ 11.0	2200	440 ~ 3190	4.09	A
2.0 + 2.5 + 4.2 + 4.2	12.9	1.40	1.74	2.93	2.93		9.00	2.9 ~ 10.8	2310	370 ~ 3400	3.90	A
2.0 + 2.5 + 4.2 + 5.0	13.7	1.31	1.64	2.76	3.29		9.00	2.9 ~ 10.8	2200	440 ~ 3110	4.09	A
2.0 + 2.5 + 4.2 + 6.0	14.7	1.22	1.53	2.57	3.68		9.00	3.0 ~ 11.0	2200	440 ~ 3260	4.09	A
2.0 + 2.5 + 4.2 + 7.1	15.8	1.14	1.42	2.39	4.05		9.00	3.0 ~ 11.2	2200	450 ~ 3330	4.09	A
2.0 + 2.5 + 5.0 + 5.0	14.5	1.24	1.55	3.10	3.11		9.00	3.0 ~ 11.0	2210	490 ~ 3120	4.07	A
2.0 + 2.5 + 5.0 + 6.0	15.5	1.16	1.45	2.90	3.49		9.00	3.0 ~ 11.0	2210	490 ~ 3120	4.07	A
2.0 + 2.5 + 5.0 + 7.1	16.6	1.08	1.36	2.71	3.85		9.00	3.0 ~ 11.2	2150	520 ~ 3200	4.19	A
2.0 + 2.5 + 6.0 + 6.0	16.5	1.09	1.37	3.27	3.27		9.00	3.0 ~ 11.2	2210	490 ~ 3190	4.07	A
2.0 + 2.5 + 6.0 + 7.1	17.6	1.02	1.28	3.07	3.63		9.00	3.0 ~ 11.2	2150	520 ~ 3200	4.19	A
2.0 + 3.5 + 3.5 + 3.5	12.5	1.44	2.52	2.52	2.52		9.00	2.9 ~ 10.8	2310	400 ~ 3330	3.90	A
2.0 + 3.5 + 3.5 + 4.2	13.2	1.36	2.39	2.39	2.86		9.00	2.9 ~ 10.8	2310	400 ~ 3330	3.90	A
2.0 + 3.5 + 3.5 + 5.0	14.0	1.29	2.25	2.25	3.21		9.00	2.9 ~ 10.8	2200	440 ~ 3110	4.09	A
2.0 + 3.5 + 3.5 + 6.0	15.0	1.20	2.10	2.10	3.60		9.00	3.0 ~ 11.0	2200	440 ~ 3260	4.09	A
2.0 + 3.5 + 3.5 + 7.1	16.1	1.11	1.96	1.96	3.97		9.00	3.0 ~ 11.2	2200	470 ~ 3330	4.09	A
2.0 + 3.5 + 4.2 + 4.2	13.9	1.29	2.27	2.72	2.72		9.00	2.9 ~ 10.8	2310	400 ~ 3330	3.90	A
2.0 + 3.5 + 4.2 + 5.0	14.7	1.22	2.14	2.57	3.07		9.00	3.0 ~ 11.0	2200	440 ~ 3190	4.09	A
2.0 + 3.5 + 4.2 + 6.0	15.7	1.14	2.01	2.41	3.44		9.00	3.0 ~ 11.0	2200	440 ~ 3190	4.09	A
2.0 + 3.5 + 4.2 + 7.1	16.8	1.07	1.88	2.25	3.80		9.00	3.0 ~ 11.2	2200	480 ~ 3340	4.09	A
2.0 + 3.5 + 5.0 + 5.0	15.5	1.16	2.04	2.90	2.90		9.00	3.0 ~ 11.0	2210	520 ~ 3050	4.07	A
2.0 + 3.5 + 5.0 + 6.0	16.5	1.09	1.91	2.73	3.27		9.00	3.0 ~ 11.2	2210	520 ~ 3200	4.07	A
2.0 + 3.5 + 5.0 + 7.1	17.6	1.02	1.79	2.56	3.63		9.00	3.0 ~ 11.2	2160	530 ~ 3200	4.17	A
2.0 + 3.5 + 6.0 + 6.0	17.5	1.02	1.80	3.09	3.09		9.00	3.0 ~ 11.2	2210	520 ~ 3200	4.07	A
2.0 + 4.2 + 4.2 + 4.2	14.6	1.23	2.59	2.59	2.59		9.00	3.0 ~ 11.0	2310	400 ~ 3400	3.90	A
2.0 + 4.2 + 4.2 + 5.0	15.4	1.17	2.45	2.45	2.93		9.00	3.0 ~ 11.0	2200	450 ~ 3190	4.09	A
2.0 + 4.2 + 4.2 + 6.0	16.4	1.10	2.30	2.30	3.30		9.00	3.0 ~ 11.2	2200	450 ~ 3330	4.09	A
2.0 + 4.2 + 4.2 + 7.1	17.5	1.03	2.16	2.16	3.65		9.00	3.0 ~ 11.2	2200	480 ~ 3260	4.09	A

4  
Room

	Indoor unit capacity Cooling	Annual Energy Consumption (kWh)	Current 230V (A)	ERP				Moisture Removal Volume l/h
				Pdesign (kW)	SEER		Annual Consumption (kWh)	
					WW	CLASS		
4 Room	2.0 + 2.0 + 2.5 + 2.5	1190	11.4	9.00	8.00	A++	394	1.3 + 1.3 + 1.5 + 1.5
	2.0 + 2.0 + 2.5 + 3.5	1190	11.4	9.00	8.00	A++	394	1.2 + 1.2 + 1.5 + 1.8
	2.0 + 2.0 + 2.5 + 4.2	1190	11.4	9.00	8.00	A++	394	1.1 + 1.1 + 1.4 + 2.0
	2.0 + 2.0 + 2.5 + 5.0	1125	10.8	9.00	8.00	A++	394	1.0 + 1.0 + 1.3 + 2.3
	2.0 + 2.0 + 2.5 + 6.0	1125	10.8	9.00	8.00	A++	394	0.9 + 0.9 + 1.2 + 2.4
	2.0 + 2.0 + 2.5 + 7.1	1100	10.5	9.00	8.00	A++	394	0.8 + 0.8 + 1.1 + 2.5
	2.0 + 2.0 + 3.5 + 3.5	1155	11.1	9.00	8.00	A++	394	1.0 + 1.0 + 1.7 + 1.7
	2.0 + 2.0 + 3.5 + 4.2	1155	11.1	9.00	8.00	A++	394	1.0 + 1.0 + 1.6 + 1.8
	2.0 + 2.0 + 3.5 + 5.0	1130	10.8	9.00	8.00	A++	394	0.9 + 0.9 + 1.5 + 2.1
	2.0 + 2.0 + 3.5 + 6.0	1130	10.8	9.00	8.00	A++	394	0.8 + 0.8 + 1.5 + 2.3
	2.0 + 2.0 + 3.5 + 7.1	1100	10.5	9.00	8.00	A++	394	0.8 + 0.8 + 1.4 + 2.4
	2.0 + 2.0 + 4.2 + 4.2	1155	11.1	9.00	8.00	A++	394	0.9 + 0.9 + 1.7 + 1.7
	2.0 + 2.0 + 4.2 + 5.0	1100	10.5	9.00	8.00	A++	394	0.9 + 0.9 + 1.7 + 2.0
	2.0 + 2.0 + 4.2 + 6.0	1100	10.5	9.00	8.00	A++	394	0.8 + 0.8 + 1.6 + 2.2
	2.0 + 2.0 + 4.2 + 7.1	1100	10.5	9.00	8.00	A++	394	0.7 + 0.7 + 1.5 + 2.4
	2.0 + 2.0 + 5.0 + 5.0	1105	10.6	9.00	8.00	A++	394	0.8 + 0.8 + 1.8 + 1.8
	2.0 + 2.0 + 5.0 + 6.0	1105	10.6	9.00	8.00	A++	394	0.7 + 0.7 + 1.7 + 2.1
	2.0 + 2.0 + 5.0 + 7.1	1075	10.3	9.00	8.00	A++	394	0.7 + 0.7 + 1.6 + 2.3
	2.0 + 2.0 + 6.0 + 6.0	1105	10.6	9.00	8.00	A++	394	0.7 + 0.7 + 1.9 + 1.9
	2.0 + 2.0 + 6.0 + 7.1	1075	10.3	9.00	8.00	A++	394	0.7 + 0.7 + 1.8 + 2.2
	2.0 + 2.0 + 7.1 + 7.1	1080	10.3	9.00	8.00	A++	394	0.7 + 0.7 + 2.0 + 2.0
	2.0 + 2.5 + 2.5 + 2.5	1190	11.4	9.00	8.00	A++	394	1.2 + 1.5 + 1.5 + 1.5
	2.0 + 2.5 + 2.5 + 3.5	1190	11.4	9.00	8.00	A++	394	1.1 + 1.4 + 1.4 + 1.7
	2.0 + 2.5 + 2.5 + 4.2	1190	11.4	9.00	8.00	A++	394	1.0 + 1.3 + 1.3 + 1.9
	2.0 + 2.5 + 2.5 + 5.0	1125	10.8	9.00	8.00	A++	394	0.9 + 1.2 + 1.2 + 2.2
	2.0 + 2.5 + 2.5 + 6.0	1125	10.8	9.00	8.00	A++	394	0.9 + 1.1 + 1.1 + 2.4
	2.0 + 2.5 + 2.5 + 7.1	1100	10.5	9.00	8.00	A++	394	0.8 + 1.0 + 1.0 + 2.5
	2.0 + 2.5 + 3.5 + 3.5	1155	11.1	9.00	8.00	A++	394	1.0 + 1.3 + 1.6 + 1.6
	2.0 + 2.5 + 3.5 + 4.2	1155	11.1	9.00	8.00	A++	394	0.9 + 1.2 + 1.6 + 1.7
	2.0 + 2.5 + 3.5 + 5.0	1130	10.8	9.00	8.00	A++	394	0.9 + 1.1 + 1.5 + 2.0
	2.0 + 2.5 + 3.5 + 6.0	1130	10.8	9.00	8.00	A++	394	0.8 + 1.0 + 1.5 + 2.3
	2.0 + 2.5 + 3.5 + 7.1	1100	10.5	9.00	8.00	A++	394	0.7 + 0.9 + 1.4 + 2.4
	2.0 + 2.5 + 4.2 + 4.2	1155	11.1	9.00	8.00	A++	394	0.9 + 1.1 + 1.7 + 1.7
	2.0 + 2.5 + 4.2 + 5.0	1100	10.5	9.00	8.00	A++	394	0.8 + 1.0 + 1.6 + 1.9
	2.0 + 2.5 + 4.2 + 6.0	1100	10.5	9.00	8.00	A++	394	0.8 + 1.0 + 1.6 + 2.1
	2.0 + 2.5 + 4.2 + 7.1	1100	10.5	9.00	8.00	A++	394	0.7 + 0.9 + 1.5 + 2.3
	2.0 + 2.5 + 5.0 + 5.0	1105	10.6	9.00	8.00	A++	394	0.8 + 1.0 + 1.7 + 1.8
	2.0 + 2.5 + 5.0 + 6.0	1105	10.6	9.00	8.00	A++	394	0.7 + 0.9 + 1.7 + 2.0
	2.0 + 2.5 + 5.0 + 7.1	1075	10.3	9.00	8.00	A++	394	0.7 + 0.9 + 1.6 + 2.3
	2.0 + 2.5 + 6.0 + 6.0	1105	10.6	9.00	8.00	A++	394	0.7 + 0.9 + 1.9 + 1.9
	2.0 + 2.5 + 6.0 + 7.1	1075	10.3	9.00	8.00	A++	394	0.7 + 0.8 + 1.7 + 2.1
	2.0 + 3.5 + 3.5 + 3.5	1155	11.1	9.00	8.00	A++	394	0.9 + 1.5 + 1.5 + 1.5
2.0 + 3.5 + 3.5 + 4.2	1155	11.1	9.00	8.00	A++	394	0.9 + 1.5 + 1.5 + 1.7	
2.0 + 3.5 + 3.5 + 5.0	1100	10.5	9.00	8.00	A++	394	0.8 + 1.5 + 1.5 + 1.8	
2.0 + 3.5 + 3.5 + 6.0	1100	10.5	9.00	8.00	A++	394	0.7 + 1.4 + 1.4 + 2.1	
2.0 + 3.5 + 3.5 + 7.1	1100	10.5	9.00	8.00	A++	394	0.7 + 1.3 + 1.3 + 2.3	
2.0 + 3.5 + 4.2 + 4.2	1155	11.1	9.00	8.00	A++	394	0.8 + 1.5 + 1.6 + 1.6	
2.0 + 3.5 + 4.2 + 5.0	1100	10.5	9.00	8.00	A++	394	0.8 + 1.4 + 1.6 + 1.7	
2.0 + 3.5 + 4.2 + 6.0	1100	10.5	9.00	8.00	A++	394	0.7 + 1.3 + 1.5 + 2.0	
2.0 + 3.5 + 4.2 + 7.1	1100	10.5	9.00	8.00	A++	394	0.7 + 1.2 + 1.5 + 2.2	
2.0 + 3.5 + 5.0 + 5.0	1105	10.6	9.00	8.00	A++	394	0.7 + 1.3 + 1.7 + 1.7	
2.0 + 3.5 + 5.0 + 6.0	1105	10.6	9.00	8.00	A++	394	0.7 + 1.2 + 1.6 + 1.9	
2.0 + 3.5 + 5.0 + 7.1	1080	10.3	9.00	8.00	A++	394	0.7 + 1.2 + 1.6 + 2.1	
2.0 + 3.5 + 6.0 + 6.0	1105	10.6	9.00	8.00	A++	394	0.7 + 1.2 + 1.7 + 1.7	
2.0 + 4.2 + 4.2 + 4.2	1155	11.1	9.00	8.00	A++	394	0.8 + 1.6 + 1.6 + 1.6	
2.0 + 4.2 + 4.2 + 5.0	1100	10.5	9.00	8.00	A++	394	0.7 + 1.5 + 1.5 + 1.7	
2.0 + 4.2 + 4.2 + 6.0	1100	10.5	9.00	8.00	A++	394	0.7 + 1.5 + 1.5 + 1.9	
2.0 + 4.2 + 4.2 + 7.1	1100	10.5	9.00	8.00	A++	394	0.7 + 1.4 + 1.4 + 2.1	

Indoor unit capacity Cooling	Total	Cooling Capacity (kW)							Input Power (W)		EER	
		Room A	Room B	Room C	Room D	Room E	Total	min ~ max	Rating	min ~ max	WW	CLASS
2.0 + 4.2 + 5.0 + 5.0	16.2	1.11	2.33	2.78	2.78		9.00	3.0 ~ 11.2	2150	520 ~ 3200	4.19	A
2.0 + 4.2 + 5.0 + 6.0	17.2	1.04	2.20	2.62	3.14		9.00	3.0 ~ 11.2	2150	520 ~ 3200	4.19	A
2.0 + 4.2 + 5.0 + 7.1	18.3	0.98	2.07	2.46	3.49		9.00	3.0 ~ 11.2	2160	530 ~ 3130	4.17	A
2.0 + 4.2 + 6.0 + 6.0	18.2	0.98	2.08	2.97	2.97		9.00	3.0 ~ 11.2	2150	520 ~ 3200	4.19	A
2.0 + 5.0 + 5.0 + 5.0	17.0	1.05	2.65	2.65	2.65		9.00	3.0 ~ 11.2	2170	580 ~ 3140	4.15	A
2.0 + 5.0 + 5.0 + 6.0	18.0	1.00	2.50	2.50	3.00		9.00	3.0 ~ 11.2	2170	580 ~ 3140	4.15	A
2.5 + 2.5 + 2.5 + 2.5	10.0	2.25	2.25	2.25	2.25		9.00	2.9 ~ 10.6	2380	370 ~ 3400	3.78	A
2.5 + 2.5 + 2.5 + 3.5	11.0	2.05	2.05	2.05	2.85		9.00	2.9 ~ 10.6	2380	370 ~ 3330	3.78	A
2.5 + 2.5 + 2.5 + 4.2	11.7	1.92	1.92	1.92	3.24		9.00	2.9 ~ 10.6	2380	370 ~ 3330	3.78	A
2.5 + 2.5 + 2.5 + 5.0	12.5	1.80	1.80	1.80	3.60		9.00	2.9 ~ 10.8	2250	410 ~ 3180	4.00	A
2.5 + 2.5 + 2.5 + 6.0	13.5	1.67	1.67	1.67	3.99		9.00	2.9 ~ 10.8	2250	410 ~ 3180	4.00	A
2.5 + 2.5 + 2.5 + 7.1	14.6	1.54	1.54	1.54	4.38		9.00	3.0 ~ 11.0	2200	440 ~ 3260	4.09	A
2.5 + 2.5 + 3.5 + 3.5	12.0	1.87	1.87	2.63	2.63		9.00	2.9 ~ 10.6	2310	370 ~ 3250	3.90	A
2.5 + 2.5 + 3.5 + 4.2	12.7	1.77	1.77	2.48	2.98		9.00	2.9 ~ 10.8	2310	370 ~ 3400	3.90	A
2.5 + 2.5 + 3.5 + 5.0	13.5	1.67	1.67	2.33	3.33		9.00	2.9 ~ 10.8	2260	440 ~ 3110	3.98	A
2.5 + 2.5 + 3.5 + 6.0	14.5	1.55	1.55	2.17	3.73		9.00	3.0 ~ 11.0	2260	440 ~ 3260	3.98	A
2.5 + 2.5 + 3.5 + 7.1	15.6	1.44	1.44	2.02	4.10		9.00	3.0 ~ 11.0	2200	440 ~ 3190	4.09	A
2.5 + 2.5 + 4.2 + 4.2	13.4	1.68	1.68	2.82	2.82		9.00	2.9 ~ 10.8	2310	370 ~ 3400	3.90	A
2.5 + 2.5 + 4.2 + 5.0	14.2	1.58	1.58	2.66	3.18		9.00	3.0 ~ 11.0	2200	440 ~ 3260	4.09	A
2.5 + 2.5 + 4.2 + 6.0	15.2	1.48	1.48	2.49	3.55		9.00	3.0 ~ 11.0	2200	440 ~ 3260	4.09	A
2.5 + 2.5 + 4.2 + 7.1	16.3	1.38	1.38	2.32	3.92		9.00	3.0 ~ 11.2	2200	450 ~ 3330	4.09	A
2.5 + 2.5 + 5.0 + 5.0	15.0	1.50	1.50	3.00	3.00		9.00	3.0 ~ 11.0	2210	490 ~ 3120	4.07	A
2.5 + 2.5 + 5.0 + 6.0	16.0	1.41	1.41	2.80	3.38		9.00	3.0 ~ 11.2	2210	490 ~ 3190	4.07	A
2.5 + 2.5 + 5.0 + 7.1	17.1	1.32	1.32	2.62	3.74		9.00	3.0 ~ 11.2	2150	520 ~ 3200	4.19	A
2.5 + 2.5 + 6.0 + 6.0	17.0	1.32	1.32	3.18	3.18		9.00	3.0 ~ 11.2	2210	490 ~ 3190	4.07	A
2.5 + 2.5 + 6.0 + 7.1	18.1	1.24	1.24	2.98	3.54		9.00	3.0 ~ 11.2	2150	520 ~ 3200	4.19	A
2.5 + 3.5 + 3.5 + 3.5	13.0	1.74	2.42	2.42	2.42		9.00	2.9 ~ 10.8	2310	400 ~ 3330	3.90	A
2.5 + 3.5 + 3.5 + 4.2	13.7	1.64	2.30	2.30	2.76		9.00	2.9 ~ 10.8	2310	400 ~ 3330	3.90	A
2.5 + 3.5 + 3.5 + 5.0	14.5	1.55	2.17	2.17	3.11		9.00	3.0 ~ 11.0	2200	440 ~ 3260	4.09	A
2.5 + 3.5 + 3.5 + 6.0	15.5	1.45	2.03	2.03	3.49		9.00	3.0 ~ 11.0	2200	440 ~ 3260	4.09	A
2.5 + 3.5 + 3.5 + 7.1	16.6	1.35	1.90	1.90	3.85		9.00	3.0 ~ 11.2	2200	470 ~ 3330	4.09	A
2.5 + 3.5 + 4.2 + 4.2	14.4	1.55	2.19	2.63	2.63		9.00	3.0 ~ 11.0	2310	400 ~ 3480	3.90	A
2.5 + 3.5 + 4.2 + 5.0	15.2	1.48	2.07	2.49	2.96		9.00	3.0 ~ 11.0	2200	440 ~ 3190	4.09	A
2.5 + 3.5 + 4.2 + 6.0	16.2	1.39	1.95	2.33	3.33		9.00	3.0 ~ 11.2	2200	440 ~ 3330	4.09	A
2.5 + 3.5 + 4.2 + 7.1	17.3	1.30	1.82	2.18	3.70		9.00	3.0 ~ 11.2	2200	480 ~ 3340	4.09	A
2.5 + 3.5 + 5.0 + 5.0	16.0	1.41	1.97	2.81	2.81		9.00	3.0 ~ 11.2	2210	520 ~ 3200	4.07	A
2.5 + 3.5 + 5.0 + 6.0	17.0	1.32	1.85	2.65	3.18		9.00	3.0 ~ 11.2	2210	520 ~ 3200	4.07	A
2.5 + 3.5 + 5.0 + 7.1	18.1	1.24	1.74	2.49	3.53		9.00	3.0 ~ 11.2	2160	530 ~ 3200	4.17	A
2.5 + 3.5 + 6.0 + 6.0	18.0	1.25	1.75	3.00	3.00		9.00	3.0 ~ 11.2	2210	520 ~ 3200	4.07	A
2.5 + 4.2 + 4.2 + 4.2	15.1	1.50	2.50	2.50	2.50		9.00	3.0 ~ 11.0	2310	400 ~ 3400	3.90	A
2.5 + 4.2 + 4.2 + 5.0	15.9	1.41	2.38	2.38	2.83		9.00	3.0 ~ 11.2	2200	450 ~ 3330	4.09	A
2.5 + 4.2 + 4.2 + 6.0	16.9	1.32	2.24	2.24	3.20		9.00	3.0 ~ 11.2	2200	450 ~ 3330	4.09	A
2.5 + 4.2 + 4.2 + 7.1	18.0	1.25	2.10	2.10	3.55		9.00	3.0 ~ 11.2	2200	480 ~ 3260	4.09	A
2.5 + 4.2 + 5.0 + 5.0	16.7	1.35	2.27	2.69	2.69		9.00	3.0 ~ 11.2	2150	520 ~ 3200	4.19	A
2.5 + 4.2 + 5.0 + 6.0	17.7	1.27	2.14	2.54	3.05		9.00	3.0 ~ 11.2	2150	520 ~ 3200	4.19	A
2.5 + 5.0 + 5.0 + 5.0	17.5	1.29	2.57	2.57	2.57		9.00	3.0 ~ 11.2	2170	580 ~ 3140	4.15	A
3.5 + 3.5 + 3.5 + 3.5	14.0	2.25	2.25	2.25	2.25		9.00	2.9 ~ 10.8	2250	400 ~ 3250	4.00	A
3.5 + 3.5 + 3.5 + 4.2	14.7	2.14	2.14	2.14	2.58		9.00	3.0 ~ 11.0	2250	410 ~ 3400	4.00	A
3.5 + 3.5 + 3.5 + 5.0	15.5	2.03	2.03	2.03	2.91		9.00	3.0 ~ 11.0	2200	470 ~ 3190	4.09	A
3.5 + 3.5 + 3.5 + 6.0	16.5	1.91	1.91	1.91	3.27		9.00	3.0 ~ 11.2	2200	470 ~ 3330	4.09	A
3.5 + 3.5 + 3.5 + 7.1	17.6	1.79	1.79	1.79	3.63		9.00	3.0 ~ 11.2	2200	480 ~ 3260	4.09	A
3.5 + 3.5 + 4.2 + 4.2	15.4	2.05	2.05	2.45	2.45		9.00	3.0 ~ 11.0	2250	410 ~ 3400	4.00	A
3.5 + 3.5 + 4.2 + 5.0	16.2	1.94	1.94	2.33	2.79		9.00	3.0 ~ 11.2	2200	470 ~ 3330	4.09	A
3.5 + 3.5 + 4.2 + 6.0	17.2	1.83	1.83	2.20	3.14		9.00	3.0 ~ 11.2	2200	470 ~ 3330	4.09	A
3.5 + 3.5 + 4.2 + 7.1	18.3	1.72	1.72	2.07	3.49		9.00	3.0 ~ 11.2	2200	480 ~ 3260	4.09	A
3.5 + 3.5 + 5.0 + 5.0	17.0	1.85	1.85	2.65	2.65		9.00	3.0 ~ 11.2	2160	520 ~ 3200	4.17	A
3.5 + 3.5 + 5.0 + 6.0	18.0	1.75	1.75	2.50	3.00		9.00	3.0 ~ 11.2	2160	520 ~ 3200	4.17	A
3.5 + 4.2 + 4.2 + 4.2	16.1	1.95	2.35	2.35	2.35		9.00	3.0 ~ 11.2	2250	410 ~ 3560	4.00	A



Indoor unit capacity Cooling	Annual Energy Consumption (kWh)	Current 230V (A)	ERP				Moisture Removal Volume l/h
			Pdesign (kW)	SEER		Annual Consumption (kWh)	
				WW	CLASS		
2.0 + 4.2 + 5.0 + 5.0	1075	10.3	9.00	8.00	A++	394	0.7 + 1.5 + 1.6 + 1.6
2.0 + 4.2 + 5.0 + 6.0	1075	10.3	9.00	8.00	A++	394	0.7 + 1.4 + 1.6 + 1.8
2.0 + 4.2 + 5.0 + 7.1	1080	10.3	9.00	8.00	A++	394	0.7 + 1.3 + 1.5 + 2.0
2.0 + 4.2 + 6.0 + 6.0	1075	10.3	9.00	8.00	A++	394	0.7 + 1.3 + 1.7 + 1.7
2.0 + 5.0 + 5.0 + 5.0	1085	10.4	9.00	8.00	A++	394	0.7 + 1.6 + 1.6 + 1.6
2.0 + 5.0 + 5.0 + 6.0	1085	10.4	9.00	8.00	A++	394	0.7 + 1.5 + 1.5 + 1.7
2.5 + 2.5 + 2.5 + 2.5	1190	11.4	9.00	8.00	A++	394	1.5 + 1.5 + 1.5 + 1.5
2.5 + 2.5 + 2.5 + 3.5	1190	11.4	9.00	8.00	A++	394	1.3 + 1.3 + 1.3 + 1.7
2.5 + 2.5 + 2.5 + 4.2	1190	11.4	9.00	8.00	A++	394	1.2 + 1.2 + 1.2 + 1.8
2.5 + 2.5 + 2.5 + 5.0	1125	10.8	9.00	8.00	A++	394	1.2 + 1.2 + 1.2 + 2.1
2.5 + 2.5 + 2.5 + 6.0	1125	10.8	9.00	8.00	A++	394	1.1 + 1.1 + 1.1 + 2.3
2.5 + 2.5 + 2.5 + 7.1	1100	10.5	9.00	8.00	A++	394	1.0 + 1.0 + 1.0 + 2.4
2.5 + 2.5 + 3.5 + 3.5	1155	11.1	9.00	8.00	A++	394	1.2 + 1.2 + 1.6 + 1.6
2.5 + 2.5 + 3.5 + 4.2	1155	11.1	9.00	8.00	A++	394	1.1 + 1.1 + 1.5 + 1.7
2.5 + 2.5 + 3.5 + 5.0	1130	10.8	9.00	8.00	A++	394	1.1 + 1.1 + 1.5 + 1.9
2.5 + 2.5 + 3.5 + 6.0	1130	10.8	9.00	8.00	A++	394	1.0 + 1.0 + 1.4 + 2.2
2.5 + 2.5 + 3.5 + 7.1	1100	10.5	9.00	8.00	A++	394	0.9 + 0.9 + 1.3 + 2.3
2.5 + 2.5 + 4.2 + 4.2	1155	11.1	9.00	8.00	A++	394	1.1 + 1.1 + 1.7 + 1.7
2.5 + 2.5 + 4.2 + 5.0	1100	10.5	9.00	8.00	A++	394	1.0 + 1.0 + 1.6 + 1.8
2.5 + 2.5 + 4.2 + 6.0	1100	10.5	9.00	8.00	A++	394	0.9 + 0.9 + 1.5 + 2.1
2.5 + 2.5 + 4.2 + 7.1	1100	10.5	9.00	8.00	A++	394	0.9 + 0.9 + 1.5 + 2.3
2.5 + 2.5 + 5.0 + 5.0	1105	10.6	9.00	8.00	A++	394	1.0 + 1.0 + 1.7 + 1.7
2.5 + 2.5 + 5.0 + 6.0	1105	10.6	9.00	8.00	A++	394	0.9 + 0.9 + 1.6 + 1.9
2.5 + 2.5 + 5.0 + 7.1	1075	10.3	9.00	8.00	A++	394	0.8 + 0.8 + 1.6 + 2.2
2.5 + 2.5 + 6.0 + 6.0	1105	10.6	9.00	8.00	A++	394	0.8 + 0.8 + 1.8 + 1.8
2.5 + 2.5 + 6.0 + 7.1	1075	10.3	9.00	8.00	A++	394	0.8 + 0.8 + 1.7 + 2.0
2.5 + 3.5 + 3.5 + 3.5	1155	11.1	9.00	8.00	A++	394	1.1 + 1.5 + 1.5 + 1.5
2.5 + 3.5 + 3.5 + 4.2	1155	11.1	9.00	8.00	A++	394	1.0 + 1.5 + 1.5 + 1.6
2.5 + 3.5 + 3.5 + 5.0	1100	10.5	9.00	8.00	A++	394	1.0 + 1.4 + 1.4 + 1.8
2.5 + 3.5 + 3.5 + 6.0	1100	10.5	9.00	8.00	A++	394	0.9 + 1.3 + 1.3 + 2.0
2.5 + 3.5 + 3.5 + 7.1	1100	10.5	9.00	8.00	A++	394	0.9 + 1.2 + 1.2 + 2.3
2.5 + 3.5 + 4.2 + 4.2	1155	11.1	9.00	8.00	A++	394	1.0 + 1.4 + 1.6 + 1.6
2.5 + 3.5 + 4.2 + 5.0	1100	10.5	9.00	8.00	A++	394	0.9 + 1.3 + 1.5 + 1.7
2.5 + 3.5 + 4.2 + 6.0	1100	10.5	9.00	8.00	A++	394	0.9 + 1.3 + 1.5 + 1.9
2.5 + 3.5 + 4.2 + 7.1	1100	10.5	9.00	8.00	A++	394	0.8 + 1.2 + 1.4 + 2.2
2.5 + 3.5 + 5.0 + 5.0	1105	10.6	9.00	8.00	A++	394	0.9 + 1.3 + 1.6 + 1.6
2.5 + 3.5 + 5.0 + 6.0	1105	10.6	9.00	8.00	A++	394	0.8 + 1.2 + 1.6 + 1.8
2.5 + 3.5 + 5.0 + 7.1	1080	10.3	9.00	8.00	A++	394	0.8 + 1.1 + 1.5 + 2.0
2.5 + 3.5 + 6.0 + 6.0	1105	10.6	9.00	8.00	A++	394	0.8 + 1.1 + 1.7 + 1.7
2.5 + 4.2 + 4.2 + 4.2	1155	11.1	9.00	8.00	A++	394	1.0 + 1.5 + 1.5 + 1.5
2.5 + 4.2 + 4.2 + 5.0	1100	10.5	9.00	8.00	A++	394	0.9 + 1.5 + 1.5 + 1.7
2.5 + 4.2 + 4.2 + 6.0	1100	10.5	9.00	8.00	A++	394	0.8 + 1.5 + 1.5 + 1.8
2.5 + 4.2 + 4.2 + 7.1	1100	10.5	9.00	8.00	A++	394	0.8 + 1.4 + 1.4 + 2.1
2.5 + 4.2 + 5.0 + 5.0	1075	10.3	9.00	8.00	A++	394	0.9 + 1.5 + 1.6 + 1.6
2.5 + 4.2 + 5.0 + 6.0	1075	10.3	9.00	8.00	A++	394	0.8 + 1.4 + 1.6 + 1.7
2.5 + 5.0 + 5.0 + 5.0	1085	10.4	9.00	8.00	A++	394	0.8 + 1.6 + 1.6 + 1.6
3.5 + 3.5 + 3.5 + 3.5	1125	10.8	9.00	8.00	A++	394	1.5 + 1.5 + 1.5 + 1.5
3.5 + 3.5 + 3.5 + 4.2	1125	10.8	9.00	8.00	A++	394	1.4 + 1.4 + 1.4 + 1.6
3.5 + 3.5 + 3.5 + 5.0	1100	10.5	9.00	8.00	A++	394	1.3 + 1.3 + 1.3 + 1.7
3.5 + 3.5 + 3.5 + 6.0	1100	10.5	9.00	8.00	A++	394	1.2 + 1.2 + 1.2 + 1.9
3.5 + 3.5 + 3.5 + 7.1	1100	10.5	9.00	8.00	A++	394	1.2 + 1.2 + 1.2 + 2.1
3.5 + 3.5 + 4.2 + 4.2	1125	10.8	9.00	8.00	A++	394	1.3 + 1.3 + 1.5 + 1.5
3.5 + 3.5 + 4.2 + 5.0	1100	10.5	9.00	8.00	A++	394	1.3 + 1.3 + 1.5 + 1.6
3.5 + 3.5 + 4.2 + 6.0	1100	10.5	9.00	8.00	A++	394	1.2 + 1.2 + 1.4 + 1.8
3.5 + 3.5 + 4.2 + 7.1	1100	10.5	9.00	8.00	A++	394	1.1 + 1.1 + 1.3 + 2.0
3.5 + 3.5 + 5.0 + 5.0	1080	10.3	9.00	8.00	A++	394	1.2 + 1.2 + 1.6 + 1.6
3.5 + 3.5 + 5.0 + 6.0	1080	10.3	9.00	8.00	A++	394	1.1 + 1.1 + 1.5 + 1.7
3.5 + 4.2 + 4.2 + 4.2	1125	10.8	9.00	8.00	A++	394	1.3 + 1.5 + 1.5 + 1.5

4  
Room

Indoor unit capacity Cooling		Total	Cooling Capacity (kW)							Input Power (W)		EER	
			Room A	Room B	Room C	Room D	Room E	Total	min ~ max	Rating	min ~ max	WW	CLASS
4 Room	3.5 + 4.2 + 4.2 + 5.0	16.9	1.86	2.24	2.24	2.66		9.00	3.0 ~ 11.2	2200	480 ~ 3340	4.09	A
	3.5 + 4.2 + 4.2 + 6.0	17.9	1.76	2.11	2.11	3.02		9.00	3.0 ~ 11.2	2200	480 ~ 3340	4.09	A
	3.5 + 4.2 + 5.0 + 5.0	17.7	1.78	2.14	2.54	2.54		9.00	3.0 ~ 11.2	2160	530 ~ 3200	4.17	A
	4.2 + 4.2 + 4.2 + 4.2	16.8	2.25	2.25	2.25	2.25		9.00	3.0 ~ 11.2	2250	430 ~ 3480	4.00	A
	4.2 + 4.2 + 4.2 + 5.0	17.6	2.15	2.15	2.15	2.55		9.00	3.0 ~ 11.2	2200	480 ~ 3260	4.09	A

	Indoor unit capacity Cooling	Annual Energy Consumption (kWh)	Current 230V (A)	ERP				Moisture Removal Volume l/h
				Pdesign (kW)	SEER		Annual Consumption (kWh)	
					WW	CLASS		
4 Room	3.5 + 4.2 + 4.2 + 5.0	1100	10.5	9.00	8.00	A++	394	1.2 + 1.5 + 1.5 + 1.6
	3.5 + 4.2 + 4.2 + 6.0	1100	10.5	9.00	8.00	A++	394	1.1 + 1.4 + 1.4 + 1.7
	3.5 + 4.2 + 5.0 + 5.0	1080	10.3	9.00	8.00	A++	394	1.1 + 1.4 + 1.6 + 1.6
	4.2 + 4.2 + 4.2 + 4.2	1125	10.8	9.00	8.00	A++	394	1.5 + 1.5 + 1.5 + 1.5
	4.2 + 4.2 + 4.2 + 5.0	1100	10.5	9.00	8.00	A++	394	1.4 + 1.4 + 1.4 + 1.6

Indoor unit capacity Cooling	Total	Cooling Capacity (kW)							Input Power (W)		EER	
		Room A	Room B	Room C	Room D	Room E	Total	min ~ max	Rating	min ~ max	WW	CLASS
1.6 + 1.6 + 1.6 + 1.6 + 1.6	8.0	1.60	1.60	1.60	1.60	1.60	8.00	2.9 ~ 11.5	1870	450 ~ 3560	4.28	A
1.6 + 1.6 + 1.6 + 1.6 + 2.0	8.4	1.60	1.60	1.60	1.60	2.00	8.40	2.9 ~ 11.5	1980	450 ~ 3560	4.24	A
1.6 + 1.6 + 1.6 + 1.6 + 2.5	8.9	1.62	1.62	1.62	1.62	2.52	9.00	2.9 ~ 11.5	2200	450 ~ 3560	4.09	A
1.6 + 1.6 + 1.6 + 1.6 + 3.5	9.9	1.45	1.45	1.45	1.45	3.20	9.00	2.9 ~ 11.5	2200	450 ~ 3490	4.09	A
1.6 + 1.6 + 1.6 + 1.6 + 4.2	10.6	1.36	1.36	1.36	1.36	3.56	9.00	2.9 ~ 11.5	2200	450 ~ 3490	4.09	A
1.6 + 1.6 + 1.6 + 1.6 + 5.0	11.4	1.26	1.26	1.26	1.26	3.96	9.00	2.9 ~ 11.5	2160	530 ~ 3350	4.17	A
1.6 + 1.6 + 1.6 + 1.6 + 6.0	12.4	1.16	1.16	1.16	1.16	4.36	9.00	2.9 ~ 11.5	2160	530 ~ 3350	4.17	A
1.6 + 1.6 + 1.6 + 1.6 + 7.1	13.5	1.07	1.07	1.07	1.07	4.72	9.00	2.9 ~ 11.5	2160	540 ~ 3280	4.17	A
1.6 + 1.6 + 1.6 + 2.0 + 2.0	8.8	1.60	1.60	1.60	2.00	2.00	8.80	2.9 ~ 11.5	2140	450 ~ 3480	4.11	A
1.6 + 1.6 + 1.6 + 2.0 + 2.5	9.3	1.55	1.55	1.55	1.94	2.41	9.00	2.9 ~ 11.5	2200	450 ~ 3480	4.09	A
1.6 + 1.6 + 1.6 + 2.0 + 3.5	10.3	1.40	1.40	1.40	1.75	3.05	9.00	2.9 ~ 11.5	2200	450 ~ 3490	4.09	A
1.6 + 1.6 + 1.6 + 2.0 + 4.2	11.0	1.31	1.31	1.31	1.64	3.43	9.00	2.9 ~ 11.5	2200	480 ~ 3490	4.09	A
1.6 + 1.6 + 1.6 + 2.0 + 5.0	11.8	1.22	1.22	1.22	1.53	3.81	9.00	2.9 ~ 11.5	2160	530 ~ 3350	4.17	A
1.6 + 1.6 + 1.6 + 2.0 + 6.0	12.8	1.13	1.13	1.13	1.41	4.20	9.00	2.9 ~ 11.5	2160	530 ~ 3350	4.17	A
1.6 + 1.6 + 1.6 + 2.0 + 7.1	13.9	1.04	1.04	1.04	1.29	4.59	9.00	2.9 ~ 11.5	2170	540 ~ 3280	4.15	A
1.6 + 1.6 + 1.6 + 2.5 + 2.5	9.8	1.47	1.47	1.47	2.29	2.29	8.99	2.9 ~ 11.5	2200	450 ~ 3480	4.09	A
1.6 + 1.6 + 1.6 + 2.5 + 3.5	10.8	1.33	1.33	1.33	2.08	2.93	9.00	2.9 ~ 11.5	2200	450 ~ 3490	4.09	A
1.6 + 1.6 + 1.6 + 2.5 + 4.2	11.5	1.25	1.25	1.25	1.96	3.29	9.00	2.9 ~ 11.5	2200	480 ~ 3490	4.09	A
1.6 + 1.6 + 1.6 + 2.5 + 5.0	12.3	1.17	1.17	1.17	1.83	3.66	9.00	2.9 ~ 11.5	2160	530 ~ 3350	4.17	A
1.6 + 1.6 + 1.6 + 2.5 + 6.0	13.3	1.08	1.08	1.08	1.69	4.07	9.00	2.9 ~ 11.5	2160	530 ~ 3350	4.17	A
1.6 + 1.6 + 1.6 + 2.5 + 7.1	14.4	1.00	1.00	1.00	1.56	4.44	9.00	2.9 ~ 11.5	2170	540 ~ 3280	4.15	A
1.6 + 1.6 + 1.6 + 3.5 + 3.5	11.8	1.22	1.22	1.22	2.67	2.67	9.00	2.9 ~ 11.5	2210	480 ~ 3410	4.07	A
1.6 + 1.6 + 1.6 + 3.5 + 4.2	12.5	1.15	1.15	1.15	2.52	3.03	9.00	2.9 ~ 11.5	2210	480 ~ 3410	4.07	A
1.6 + 1.6 + 1.6 + 3.5 + 5.0	13.3	1.08	1.08	1.08	2.37	3.39	9.00	2.9 ~ 11.5	2170	540 ~ 3280	4.15	A
1.6 + 1.6 + 1.6 + 3.5 + 6.0	14.3	1.01	1.01	1.01	2.20	3.77	9.00	2.9 ~ 11.5	2170	540 ~ 3280	4.15	A
1.6 + 1.6 + 1.6 + 3.5 + 7.1	15.4	0.94	0.94	0.94	2.05	4.13	9.00	2.9 ~ 11.5	2170	570 ~ 3280	4.15	A
1.6 + 1.6 + 1.6 + 4.2 + 4.2	13.2	1.09	1.09	1.09	2.86	2.86	8.99	2.9 ~ 11.5	2210	490 ~ 3410	4.07	A
1.6 + 1.6 + 1.6 + 4.2 + 5.0	14.0	1.03	1.03	1.03	2.70	3.21	9.00	2.9 ~ 11.5	2170	540 ~ 3280	4.15	A
1.6 + 1.6 + 1.6 + 4.2 + 6.0	15.0	0.96	0.96	0.96	2.52	3.60	9.00	2.9 ~ 11.5	2170	540 ~ 3280	4.15	A
1.6 + 1.6 + 1.6 + 4.2 + 7.1	16.1	0.89	0.89	0.89	2.35	3.98	9.00	2.9 ~ 11.5	2170	570 ~ 3290	4.15	A
1.6 + 1.6 + 1.6 + 5.0 + 5.0	14.8	0.97	0.97	0.97	3.04	3.05	9.00	2.9 ~ 11.5	2190	620 ~ 3230	4.11	A
1.6 + 1.6 + 1.6 + 5.0 + 6.0	15.8	0.91	0.91	0.91	2.85	3.42	9.00	2.9 ~ 11.5	2190	620 ~ 3230	4.11	A
1.6 + 1.6 + 1.6 + 5.0 + 7.1	16.9	0.85	0.85	0.85	2.66	3.79	9.00	2.9 ~ 11.5	2260	660 ~ 3240	3.98	A
1.6 + 1.6 + 1.6 + 6.0 + 6.0	16.8	0.86	0.86	0.86	3.21	3.21	9.00	2.9 ~ 11.5	2190	620 ~ 3230	4.11	A
1.6 + 1.6 + 1.6 + 6.0 + 7.1	17.9	0.80	0.80	0.80	3.02	3.58	9.00	2.9 ~ 11.5	2260	660 ~ 3240	3.98	A
1.6 + 1.6 + 2.0 + 2.0 + 2.0	9.2	1.56	1.56	1.96	1.96	1.96	9.00	2.9 ~ 11.5	2200	450 ~ 3490	4.09	A
1.6 + 1.6 + 2.0 + 2.0 + 2.5	9.7	1.48	1.48	1.86	1.86	2.32	9.00	2.9 ~ 11.5	2200	450 ~ 3490	4.09	A
1.6 + 1.6 + 2.0 + 2.0 + 3.5	10.7	1.35	1.35	1.68	1.68	2.94	9.00	2.9 ~ 11.5	2200	480 ~ 3490	4.09	A
1.6 + 1.6 + 2.0 + 2.0 + 4.2	11.4	1.26	1.26	1.58	1.58	3.32	9.00	2.9 ~ 11.5	2200	480 ~ 3410	4.09	A
1.6 + 1.6 + 2.0 + 2.0 + 5.0	12.2	1.18	1.18	1.48	1.48	3.68	9.00	2.9 ~ 11.5	2160	530 ~ 3280	4.17	A
1.6 + 1.6 + 2.0 + 2.0 + 6.0	13.2	1.09	1.09	1.36	1.36	4.10	9.00	2.9 ~ 11.5	2160	530 ~ 3280	4.17	A
1.6 + 1.6 + 2.0 + 2.0 + 7.1	14.3	1.01	1.01	1.26	1.26	4.46	9.00	2.9 ~ 11.5	2170	570 ~ 3280	4.15	A
1.6 + 1.6 + 2.0 + 2.5 + 2.5	10.2	1.41	1.41	1.76	2.21	2.21	9.00	2.9 ~ 11.5	2200	450 ~ 3490	4.09	A
1.6 + 1.6 + 2.0 + 2.5 + 3.5	11.2	1.29	1.29	1.61	2.01	2.80	9.00	2.9 ~ 11.5	2200	480 ~ 3490	4.09	A
1.6 + 1.6 + 2.0 + 2.5 + 4.2	11.9	1.21	1.21	1.51	1.89	3.18	9.00	2.9 ~ 11.5	2200	480 ~ 3410	4.09	A
1.6 + 1.6 + 2.0 + 2.5 + 5.0	12.7	1.13	1.13	1.42	1.77	3.55	9.00	2.9 ~ 11.5	2160	530 ~ 3280	4.17	A
1.6 + 1.6 + 2.0 + 2.5 + 6.0	13.7	1.05	1.05	1.31	1.64	3.95	9.00	2.9 ~ 11.5	2160	530 ~ 3280	4.17	A
1.6 + 1.6 + 2.0 + 2.5 + 7.1	14.8	0.97	0.97	1.22	1.52	4.32	9.00	2.9 ~ 11.5	2170	570 ~ 3280	4.15	A
1.6 + 1.6 + 2.0 + 3.5 + 3.5	12.2	1.18	1.18	1.48	2.58	2.58	9.00	2.9 ~ 11.5	2210	490 ~ 3410	4.07	A
1.6 + 1.6 + 2.0 + 3.5 + 4.2	12.9	1.12	1.12	1.40	2.44	2.92	9.00	2.9 ~ 11.5	2210	490 ~ 3410	4.07	A
1.6 + 1.6 + 2.0 + 3.5 + 5.0	13.7	1.05	1.05	1.31	2.30	3.29	9.00	2.9 ~ 11.5	2170	540 ~ 3280	4.15	A
1.6 + 1.6 + 2.0 + 3.5 + 6.0	14.7	0.98	0.98	1.22	2.14	3.68	9.00	2.9 ~ 11.5	2170	540 ~ 3280	4.15	A
1.6 + 1.6 + 2.0 + 3.5 + 7.1	15.8	0.91	0.91	1.14	1.99	4.05	9.00	2.9 ~ 11.5	2170	570 ~ 3290	4.15	A
1.6 + 1.6 + 2.0 + 4.2 + 4.2	13.6	1.06	1.06	1.32	2.78	2.78	9.00	2.9 ~ 11.5	2210	490 ~ 3420	4.07	A
1.6 + 1.6 + 2.0 + 4.2 + 5.0	14.4	1.00	1.00	1.25	2.63	3.12	9.00	2.9 ~ 11.5	2170	570 ~ 3280	4.15	A
1.6 + 1.6 + 2.0 + 4.2 + 6.0	15.4	0.94	0.94	1.17	2.45	3.50	9.00	2.9 ~ 11.5	2170	570 ~ 3280	4.15	A
1.6 + 1.6 + 2.0 + 4.2 + 7.1	16.5	0.87	0.87	1.09	2.29	3.88	9.00	2.9 ~ 11.5	2170	580 ~ 3290	4.15	A
1.6 + 1.6 + 2.0 + 5.0 + 5.0	15.2	0.95	0.95	1.18	2.96	2.96	9.00	2.9 ~ 11.5	2260	630 ~ 3230	3.98	A

5 Room

	Indoor unit capacity Cooling	Annual Energy Consumption (kWh)	Current 230V (A)	ERP				Moisture Removal Volume l/h
				Pdesign (kW)	SEER		Annual Consumption (kWh)	
					W/W	CLASS		
5 Room	1.6 + 1.6 + 1.6 + 1.6 + 1.6	935	9.0	8.00	8.50	A+++	329	1.0 + 1.0 + 1.0 + 1.0 + 1.0
	1.6 + 1.6 + 1.6 + 1.6 + 2.0	990	9.5	8.40	8.50	A+++	346	1.0 + 1.0 + 1.0 + 1.0 + 1.3
	1.6 + 1.6 + 1.6 + 1.6 + 2.5	1100	10.5	9.00	8.50	A+++	371	1.0 + 1.0 + 1.0 + 1.0 + 1.5
	1.6 + 1.6 + 1.6 + 1.6 + 3.5	1100	10.5	9.00	8.50	A+++	371	0.9 + 0.9 + 0.9 + 0.9 + 1.8
	1.6 + 1.6 + 1.6 + 1.6 + 4.2	1100	10.5	9.00	8.50	A+++	371	0.9 + 0.9 + 0.9 + 0.9 + 2.1
	1.6 + 1.6 + 1.6 + 1.6 + 5.0	1080	10.3	9.00	8.50	A+++	371	0.8 + 0.8 + 0.8 + 0.8 + 2.3
	1.6 + 1.6 + 1.6 + 1.6 + 6.0	1080	10.3	9.00	8.50	A+++	371	0.7 + 0.7 + 0.7 + 0.7 + 2.4
	1.6 + 1.6 + 1.6 + 1.6 + 7.1	1080	10.3	9.00	8.50	A+++	371	0.7 + 0.7 + 0.7 + 0.7 + 2.5
	1.6 + 1.6 + 1.6 + 2.0 + 2.0	1070	10.2	8.80	8.50	A+++	362	1.0 + 1.0 + 1.0 + 1.3 + 1.3
	1.6 + 1.6 + 1.6 + 2.0 + 2.5	1100	10.5	9.00	8.50	A+++	371	1.0 + 1.0 + 1.0 + 1.3 + 1.5
	1.6 + 1.6 + 1.6 + 2.0 + 3.5	1100	10.5	9.00	8.50	A+++	371	0.9 + 0.9 + 0.9 + 1.1 + 1.7
	1.6 + 1.6 + 1.6 + 2.0 + 4.2	1100	10.5	9.00	8.50	A+++	371	0.8 + 0.8 + 0.8 + 1.0 + 2.0
	1.6 + 1.6 + 1.6 + 2.0 + 5.0	1080	10.3	9.00	8.50	A+++	371	0.8 + 0.8 + 0.8 + 1.0 + 2.2
	1.6 + 1.6 + 1.6 + 2.0 + 6.0	1080	10.3	9.00	8.50	A+++	371	0.7 + 0.7 + 0.7 + 0.9 + 2.4
	1.6 + 1.6 + 1.6 + 2.0 + 7.1	1085	10.4	9.00	8.50	A+++	371	0.7 + 0.7 + 0.7 + 0.8 + 2.5
	1.6 + 1.6 + 1.6 + 2.5 + 2.5	1100	10.5	8.99	8.50	A+++	370	0.9 + 0.9 + 0.9 + 1.5 + 1.5
	1.6 + 1.6 + 1.6 + 2.5 + 3.5	1100	10.5	9.00	8.50	A+++	371	0.8 + 0.8 + 0.8 + 1.3 + 1.7
	1.6 + 1.6 + 1.6 + 2.5 + 4.2	1100	10.5	9.00	8.50	A+++	371	0.8 + 0.8 + 0.8 + 1.3 + 1.9
	1.6 + 1.6 + 1.6 + 2.5 + 5.0	1080	10.3	9.00	8.50	A+++	371	0.7 + 0.7 + 0.7 + 1.2 + 2.1
	1.6 + 1.6 + 1.6 + 2.5 + 6.0	1080	10.3	9.00	8.50	A+++	371	0.7 + 0.7 + 0.7 + 1.1 + 2.3
	1.6 + 1.6 + 1.6 + 2.5 + 7.1	1085	10.4	9.00	8.50	A+++	371	0.7 + 0.7 + 0.7 + 1.0 + 2.5
	1.6 + 1.6 + 1.6 + 3.5 + 3.5	1105	10.6	9.00	8.50	A+++	371	0.8 + 0.8 + 0.8 + 1.6 + 1.6
	1.6 + 1.6 + 1.6 + 3.5 + 4.2	1105	10.6	9.00	8.50	A+++	371	0.7 + 0.7 + 0.7 + 1.5 + 1.7
	1.6 + 1.6 + 1.6 + 3.5 + 5.0	1085	10.4	9.00	8.50	A+++	371	0.7 + 0.7 + 0.7 + 1.5 + 1.9
	1.6 + 1.6 + 1.6 + 3.5 + 6.0	1085	10.4	9.00	8.50	A+++	371	0.7 + 0.7 + 0.7 + 1.4 + 2.2
	1.6 + 1.6 + 1.6 + 3.5 + 7.1	1085	10.4	9.00	8.50	A+++	371	0.7 + 0.7 + 0.7 + 1.3 + 2.3
	1.6 + 1.6 + 1.6 + 4.2 + 4.2	1105	10.6	8.99	8.50	A+++	370	0.7 + 0.7 + 0.7 + 1.7 + 1.7
	1.6 + 1.6 + 1.6 + 4.2 + 5.0	1085	10.4	9.00	8.50	A+++	371	0.7 + 0.7 + 0.7 + 1.6 + 1.8
	1.6 + 1.6 + 1.6 + 4.2 + 6.0	1085	10.4	9.00	8.50	A+++	371	0.7 + 0.7 + 0.7 + 1.5 + 2.1
	1.6 + 1.6 + 1.6 + 4.2 + 7.1	1085	10.4	9.00	8.50	A+++	371	0.7 + 0.7 + 0.7 + 1.5 + 2.3
	1.6 + 1.6 + 1.6 + 5.0 + 5.0	1095	10.5	9.00	8.50	A+++	371	0.7 + 0.7 + 0.7 + 1.7 + 1.7
	1.6 + 1.6 + 1.6 + 5.0 + 6.0	1095	10.5	9.00	8.50	A+++	371	0.7 + 0.7 + 0.7 + 1.7 + 2.0
	1.6 + 1.6 + 1.6 + 5.0 + 7.1	1130	10.8	9.00	8.50	A+++	371	0.7 + 0.7 + 0.7 + 1.6 + 2.2
	1.6 + 1.6 + 1.6 + 6.0 + 6.0	1095	10.5	9.00	8.50	A+++	371	0.7 + 0.7 + 0.7 + 1.8 + 1.8
	1.6 + 1.6 + 1.6 + 6.0 + 7.1	1130	10.8	9.00	8.50	A+++	371	0.7 + 0.7 + 0.7 + 1.7 + 2.1
	1.6 + 1.6 + 2.0 + 2.0 + 2.0	1100	10.5	9.00	8.50	A+++	371	1.0 + 1.0 + 1.3 + 1.3 + 1.3
	1.6 + 1.6 + 2.0 + 2.0 + 2.5	1100	10.5	9.00	8.50	A+++	371	0.9 + 0.9 + 1.2 + 1.2 + 1.5
	1.6 + 1.6 + 2.0 + 2.0 + 3.5	1100	10.5	9.00	8.50	A+++	371	0.9 + 0.9 + 1.1 + 1.1 + 1.7
	1.6 + 1.6 + 2.0 + 2.0 + 4.2	1100	10.5	9.00	8.50	A+++	371	0.8 + 0.8 + 1.0 + 1.0 + 1.9
	1.6 + 1.6 + 2.0 + 2.0 + 5.0	1080	10.3	9.00	8.50	A+++	371	0.7 + 0.7 + 0.9 + 0.9 + 2.1
1.6 + 1.6 + 2.0 + 2.0 + 6.0	1080	10.3	9.00	8.50	A+++	371	0.7 + 0.7 + 0.9 + 0.9 + 2.3	
1.6 + 1.6 + 2.0 + 2.0 + 7.1	1085	10.4	9.00	8.50	A+++	371	0.7 + 0.7 + 0.8 + 0.8 + 2.5	
1.6 + 1.6 + 2.0 + 2.5 + 2.5	1100	10.5	9.00	8.50	A+++	371	0.9 + 0.9 + 1.1 + 1.4 + 1.4	
1.6 + 1.6 + 2.0 + 2.5 + 3.5	1100	10.5	9.00	8.50	A+++	371	0.8 + 0.8 + 1.0 + 1.3 + 1.6	
1.6 + 1.6 + 2.0 + 2.5 + 4.2	1100	10.5	9.00	8.50	A+++	371	0.8 + 0.8 + 1.0 + 1.2 + 1.8	
1.6 + 1.6 + 2.0 + 2.5 + 5.0	1080	10.3	9.00	8.50	A+++	371	0.7 + 0.7 + 0.9 + 1.1 + 2.1	
1.6 + 1.6 + 2.0 + 2.5 + 6.0	1080	10.3	9.00	8.50	A+++	371	0.7 + 0.7 + 0.8 + 1.0 + 2.3	
1.6 + 1.6 + 2.0 + 2.5 + 7.1	1085	10.4	9.00	8.50	A+++	371	0.7 + 0.7 + 0.8 + 1.0 + 2.4	
1.6 + 1.6 + 2.0 + 3.5 + 3.5	1105	10.6	9.00	8.50	A+++	371	0.7 + 0.7 + 0.9 + 1.6 + 1.6	
1.6 + 1.6 + 2.0 + 3.5 + 4.2	1105	10.6	9.00	8.50	A+++	371	0.7 + 0.7 + 0.9 + 1.5 + 1.7	
1.6 + 1.6 + 2.0 + 3.5 + 5.0	1085	10.4	9.00	8.50	A+++	371	0.7 + 0.7 + 0.8 + 1.5 + 1.9	
1.6 + 1.6 + 2.0 + 3.5 + 6.0	1085	10.4	9.00	8.50	A+++	371	0.7 + 0.7 + 0.8 + 1.4 + 2.1	
1.6 + 1.6 + 2.0 + 3.5 + 7.1	1085	10.4	9.00	8.50	A+++	371	0.7 + 0.7 + 0.7 + 1.3 + 2.3	
1.6 + 1.6 + 2.0 + 4.2 + 4.2	1105	10.6	9.00	8.50	A+++	371	0.7 + 0.7 + 0.8 + 1.6 + 1.6	
1.6 + 1.6 + 2.0 + 4.2 + 5.0	1085	10.4	9.00	8.50	A+++	371	0.7 + 0.7 + 0.8 + 1.6 + 1.8	
1.6 + 1.6 + 2.0 + 4.2 + 6.0	1085	10.4	9.00	8.50	A+++	371	0.7 + 0.7 + 0.7 + 1.5 + 2.0	
1.6 + 1.6 + 2.0 + 4.2 + 7.1	1085	10.4	9.00	8.50	A+++	371	0.7 + 0.7 + 0.7 + 1.5 + 2.3	
1.6 + 1.6 + 2.0 + 5.0 + 5.0	1130	10.8	9.00	8.50	A+++	371	0.7 + 0.7 + 0.7 + 1.7 + 1.7	

Indoor unit capacity Cooling	Total	Cooling Capacity (kW)							Input Power (W)		EER	
		Room A	Room B	Room C	Room D	Room E	Total	min ~ max	Rating	min ~ max	WW	CLASS
1.6 + 1.6 + 2.0 + 5.0 + 6.0	16.2	0.89	0.89	1.11	2.78	3.33	9.00	2.9 ~ 11.5	2260	630 ~ 3230	3.98	A
1.6 + 1.6 + 2.0 + 5.0 + 7.1	17.3	0.83	0.83	1.04	2.60	3.70	9.00	2.9 ~ 11.5	2270	660 ~ 3240	3.96	A
1.6 + 1.6 + 2.0 + 6.0 + 6.0	17.2	0.84	0.84	1.04	3.14	3.14	9.00	2.9 ~ 11.5	2260	630 ~ 3230	3.98	A
1.6 + 1.6 + 2.0 + 6.0 + 7.1	18.3	0.79	0.79	0.98	2.95	3.49	9.00	2.9 ~ 11.5	2270	660 ~ 3240	3.96	A
1.6 + 1.6 + 2.5 + 2.5 + 2.5	10.7	1.35	1.35	2.10	2.10	2.10	9.00	2.9 ~ 11.5	2200	450 ~ 3490	4.09	A
1.6 + 1.6 + 2.5 + 2.5 + 3.5	11.7	1.23	1.23	1.92	1.92	2.70	9.00	2.9 ~ 11.5	2200	480 ~ 3490	4.09	A
1.6 + 1.6 + 2.5 + 2.5 + 4.2	12.4	1.16	1.16	1.81	1.81	3.06	9.00	2.9 ~ 11.5	2200	480 ~ 3410	4.09	A
1.6 + 1.6 + 2.5 + 2.5 + 5.0	13.2	1.09	1.09	1.70	1.70	3.42	9.00	2.9 ~ 11.5	2160	530 ~ 3280	4.17	A
1.6 + 1.6 + 2.5 + 2.5 + 6.0	14.2	1.01	1.01	1.58	1.58	3.82	9.00	2.9 ~ 11.5	2160	530 ~ 3280	4.17	A
1.6 + 1.6 + 2.5 + 2.5 + 7.1	15.3	0.94	0.94	1.47	1.47	4.18	9.00	2.9 ~ 11.5	2170	570 ~ 3280	4.15	A
1.6 + 1.6 + 2.5 + 3.5 + 3.5	12.7	1.13	1.13	1.78	2.48	2.48	9.00	2.9 ~ 11.5	2210	490 ~ 3410	4.07	A
1.6 + 1.6 + 2.5 + 3.5 + 4.2	13.4	1.07	1.07	1.68	2.35	2.83	9.00	2.9 ~ 11.5	2210	490 ~ 3410	4.07	A
1.6 + 1.6 + 2.5 + 3.5 + 5.0	14.2	1.01	1.01	1.58	2.22	3.18	9.00	2.9 ~ 11.5	2170	540 ~ 3280	4.15	A
1.6 + 1.6 + 2.5 + 3.5 + 6.0	15.2	0.95	0.95	1.48	2.07	3.55	9.00	2.9 ~ 11.5	2170	540 ~ 3280	4.15	A
1.6 + 1.6 + 2.5 + 3.5 + 7.1	16.3	0.88	0.88	1.38	1.93	3.93	9.00	2.9 ~ 11.5	2170	570 ~ 3290	4.15	A
1.6 + 1.6 + 2.5 + 4.2 + 4.2	14.1	1.02	1.02	1.60	2.68	2.68	9.00	2.9 ~ 11.5	2210	490 ~ 3420	4.07	A
1.6 + 1.6 + 2.5 + 4.2 + 5.0	14.9	0.97	0.97	1.51	2.54	3.01	9.00	2.9 ~ 11.5	2170	570 ~ 3280	4.15	A
1.6 + 1.6 + 2.5 + 4.2 + 6.0	15.9	0.91	0.91	1.42	2.38	3.38	9.00	2.9 ~ 11.5	2170	570 ~ 3280	4.15	A
1.6 + 1.6 + 2.5 + 4.2 + 7.1	17.0	0.85	0.85	1.32	2.22	3.76	9.00	2.9 ~ 11.5	2170	580 ~ 3290	4.15	A
1.6 + 1.6 + 2.5 + 5.0 + 5.0	15.7	0.92	0.92	1.42	2.87	2.87	9.00	2.9 ~ 11.5	2260	630 ~ 3230	3.98	A
1.6 + 1.6 + 2.5 + 5.0 + 6.0	16.7	0.86	0.86	1.35	2.69	3.24	9.00	2.9 ~ 11.5	2260	630 ~ 3230	3.98	A
1.6 + 1.6 + 2.5 + 5.0 + 7.1	17.8	0.81	0.81	1.26	2.53	3.59	9.00	2.9 ~ 11.5	2270	660 ~ 3240	3.96	A
1.6 + 1.6 + 2.5 + 6.0 + 6.0	17.7	0.81	0.81	1.28	3.05	3.05	9.00	2.9 ~ 11.5	2260	630 ~ 3230	3.98	A
1.6 + 1.6 + 3.5 + 3.5 + 3.5	13.7	1.05	1.05	2.30	2.30	2.30	9.00	2.9 ~ 11.5	2210	490 ~ 3420	4.07	A
1.6 + 1.6 + 3.5 + 3.5 + 4.2	14.4	1.00	1.00	2.19	2.19	2.62	9.00	2.9 ~ 11.5	2210	490 ~ 3420	4.07	A
1.6 + 1.6 + 3.5 + 3.5 + 5.0	15.2	0.95	0.95	2.07	2.07	2.96	9.00	2.9 ~ 11.5	2170	570 ~ 3280	4.15	A
1.6 + 1.6 + 3.5 + 3.5 + 6.0	16.2	0.89	0.89	1.94	1.94	3.34	9.00	2.9 ~ 11.5	2170	570 ~ 3280	4.15	A
1.6 + 1.6 + 3.5 + 3.5 + 7.1	17.3	0.83	0.83	1.82	1.82	3.70	9.00	2.9 ~ 11.5	2180	580 ~ 3290	4.13	A
1.6 + 1.6 + 3.5 + 4.2 + 4.2	15.1	0.95	0.95	2.10	2.50	2.50	9.00	2.9 ~ 11.5	2210	490 ~ 3340	4.07	A
1.6 + 1.6 + 3.5 + 4.2 + 5.0	15.9	0.91	0.91	1.98	2.38	2.82	9.00	2.9 ~ 11.5	2170	570 ~ 3290	4.15	A
1.6 + 1.6 + 3.5 + 4.2 + 6.0	16.9	0.85	0.85	1.86	2.24	3.20	9.00	2.9 ~ 11.5	2170	570 ~ 3290	4.15	A
1.6 + 1.6 + 3.5 + 4.2 + 7.1	18.0	0.80	0.80	1.75	2.10	3.55	9.00	2.9 ~ 11.5	2180	580 ~ 3290	4.13	A
1.6 + 1.6 + 3.5 + 5.0 + 5.0	16.7	0.86	0.86	1.90	2.69	2.69	9.00	2.9 ~ 11.5	2260	660 ~ 3240	3.98	A
1.6 + 1.6 + 3.5 + 5.0 + 6.0	17.7	0.81	0.81	1.78	2.54	3.06	9.00	2.9 ~ 11.5	2260	660 ~ 3240	3.98	A
1.6 + 1.6 + 4.2 + 4.2 + 4.2	15.8	0.91	0.91	2.39	2.39	2.39	8.99	2.9 ~ 11.5	2150	490 ~ 3340	4.18	A
1.6 + 1.6 + 4.2 + 4.2 + 5.0	16.6	0.87	0.87	2.28	2.28	2.70	9.00	2.9 ~ 11.5	2170	570 ~ 3290	4.15	A
1.6 + 1.6 + 4.2 + 4.2 + 6.0	17.6	0.82	0.82	2.15	2.15	3.06	9.00	2.9 ~ 11.5	2170	570 ~ 3290	4.15	A
1.6 + 1.6 + 4.2 + 5.0 + 5.0	17.4	0.83	0.83	2.16	2.59	2.59	9.00	2.9 ~ 11.5	2270	660 ~ 3240	3.96	A
1.6 + 1.6 + 5.0 + 5.0 + 5.0	18.2	0.79	0.79	2.47	2.47	2.47	8.99	2.9 ~ 11.5	2300	760 ~ 3270	3.91	A
1.6 + 2.0 + 2.0 + 2.0 + 2.0	9.6	1.48	1.88	1.88	1.88	1.88	9.00	2.9 ~ 11.5	2200	450 ~ 3490	4.09	A
1.6 + 2.0 + 2.0 + 2.0 + 2.5	10.1	1.43	1.78	1.78	1.78	2.23	9.00	2.9 ~ 11.5	2200	450 ~ 3490	4.09	A
1.6 + 2.0 + 2.0 + 2.0 + 3.5	11.1	1.30	1.62	1.62	1.62	2.84	9.00	2.9 ~ 11.5	2200	480 ~ 3410	4.09	A
1.6 + 2.0 + 2.0 + 2.0 + 4.2	11.8	1.22	1.53	1.53	1.53	3.19	9.00	2.9 ~ 11.5	2210	480 ~ 3410	4.07	A
1.6 + 2.0 + 2.0 + 2.0 + 5.0	12.6	1.14	1.43	1.43	1.43	3.57	9.00	2.9 ~ 11.5	2160	540 ~ 3280	4.17	A
1.6 + 2.0 + 2.0 + 2.0 + 6.0	13.6	1.06	1.32	1.32	1.32	3.98	9.00	2.9 ~ 11.5	2160	540 ~ 3280	4.17	A
1.6 + 2.0 + 2.0 + 2.0 + 7.1	14.7	0.98	1.22	1.22	1.22	4.36	9.00	2.9 ~ 11.5	2170	570 ~ 3280	4.15	A
1.6 + 2.0 + 2.0 + 2.5 + 2.5	10.6	1.36	1.70	1.70	2.12	2.12	9.00	2.9 ~ 11.5	2200	450 ~ 3490	4.09	A
1.6 + 2.0 + 2.0 + 2.5 + 3.5	11.6	1.24	1.55	1.55	1.94	2.72	9.00	2.9 ~ 11.5	2200	480 ~ 3410	4.09	A
1.6 + 2.0 + 2.0 + 2.5 + 4.2	12.3	1.17	1.46	1.46	1.83	3.08	9.00	2.9 ~ 11.5	2210	480 ~ 3410	4.07	A
1.6 + 2.0 + 2.0 + 2.5 + 5.0	13.1	1.10	1.37	1.37	1.72	3.44	9.00	2.9 ~ 11.5	2160	540 ~ 3280	4.17	A
1.6 + 2.0 + 2.0 + 2.5 + 6.0	14.1	1.02	1.28	1.28	1.60	3.82	9.00	2.9 ~ 11.5	2160	540 ~ 3280	4.17	A
1.6 + 2.0 + 2.0 + 2.5 + 7.1	15.2	0.95	1.18	1.18	1.48	4.21	9.00	2.9 ~ 11.5	2170	570 ~ 3280	4.15	A
1.6 + 2.0 + 2.0 + 3.5 + 3.5	12.6	1.14	1.43	1.43	2.50	2.50	9.00	2.9 ~ 11.5	2210	490 ~ 3410	4.07	A
1.6 + 2.0 + 2.0 + 3.5 + 4.2	13.3	1.08	1.35	1.35	2.37	2.85	9.00	2.9 ~ 11.5	2210	490 ~ 3420	4.07	A
1.6 + 2.0 + 2.0 + 3.5 + 5.0	14.1	1.02	1.28	1.28	2.23	3.19	9.00	2.9 ~ 11.5	2170	570 ~ 3280	4.15	A
1.6 + 2.0 + 2.0 + 3.5 + 6.0	15.1	0.95	1.19	1.19	2.09	3.58	9.00	2.9 ~ 11.5	2170	570 ~ 3280	4.15	A
1.6 + 2.0 + 2.0 + 3.5 + 7.1	16.2	0.89	1.11	1.11	1.94	3.95	9.00	2.9 ~ 11.5	2180	580 ~ 3290	4.13	A
1.6 + 2.0 + 2.0 + 4.2 + 4.2	14.0	1.02	1.29	1.29	2.70	2.70	9.00	2.9 ~ 11.5	2210	490 ~ 3420	4.07	A

5  
Room

	Indoor unit capacity Cooling	Annual Energy Consumption (kWh)	Current 230V (A)	ERP			Moisture Removal Volume l/h	
				Pdesign (kW)	SEER			Annual Consumption (kWh)
					W/W	CLASS		
5 Room	1.6 + 1.6 + 2.0 + 5.0 + 6.0	1130	10.8	9.00	8.50	A+++	371	0.7 + 0.7 + 0.7 + 1.6 + 1.9
	1.6 + 1.6 + 2.0 + 5.0 + 7.1	1135	10.9	9.00	8.50	A+++	371	0.7 + 0.7 + 0.7 + 1.6 + 2.2
	1.6 + 1.6 + 2.0 + 6.0 + 6.0	1130	10.8	9.00	8.50	A+++	371	0.7 + 0.7 + 0.7 + 1.8 + 1.8
	1.6 + 1.6 + 2.0 + 6.0 + 7.1	1135	10.9	9.00	8.50	A+++	371	0.7 + 0.7 + 0.7 + 1.7 + 2.0
	1.6 + 1.6 + 2.5 + 2.5 + 2.5	1100	10.5	9.00	8.50	A+++	371	0.9 + 0.9 + 1.4 + 1.4 + 1.4
	1.6 + 1.6 + 2.5 + 2.5 + 3.5	1100	10.5	9.00	8.50	A+++	371	0.8 + 0.8 + 1.2 + 1.2 + 1.6
	1.6 + 1.6 + 2.5 + 2.5 + 4.2	1100	10.5	9.00	8.50	A+++	371	0.7 + 0.7 + 1.2 + 1.2 + 1.7
	1.6 + 1.6 + 2.5 + 2.5 + 5.0	1080	10.3	9.00	8.50	A+++	371	0.7 + 0.7 + 1.1 + 1.1 + 2.0
	1.6 + 1.6 + 2.5 + 2.5 + 6.0	1080	10.3	9.00	8.50	A+++	371	0.7 + 0.7 + 1.0 + 1.0 + 2.2
	1.6 + 1.6 + 2.5 + 2.5 + 7.1	1085	10.4	9.00	8.50	A+++	371	0.7 + 0.7 + 0.9 + 0.9 + 2.4
	1.6 + 1.6 + 2.5 + 3.5 + 3.5	1105	10.6	9.00	8.50	A+++	371	0.7 + 0.7 + 1.1 + 1.5 + 1.5
	1.6 + 1.6 + 2.5 + 3.5 + 4.2	1105	10.6	9.00	8.50	A+++	371	0.7 + 0.7 + 1.1 + 1.5 + 1.7
	1.6 + 1.6 + 2.5 + 3.5 + 5.0	1085	10.4	9.00	8.50	A+++	371	0.7 + 0.7 + 1.0 + 1.4 + 1.8
	1.6 + 1.6 + 2.5 + 3.5 + 6.0	1085	10.4	9.00	8.50	A+++	371	0.7 + 0.7 + 0.9 + 1.3 + 2.1
	1.6 + 1.6 + 2.5 + 3.5 + 7.1	1085	10.4	9.00	8.50	A+++	371	0.7 + 0.7 + 0.9 + 1.2 + 2.3
	1.6 + 1.6 + 2.5 + 4.2 + 4.2	1105	10.6	9.00	8.50	A+++	371	0.7 + 0.7 + 1.0 + 1.6 + 1.6
	1.6 + 1.6 + 2.5 + 4.2 + 5.0	1085	10.4	9.00	8.50	A+++	371	0.7 + 0.7 + 1.0 + 1.6 + 1.7
	1.6 + 1.6 + 2.5 + 4.2 + 6.0	1085	10.4	9.00	8.50	A+++	371	0.7 + 0.7 + 0.9 + 1.5 + 1.9
	1.6 + 1.6 + 2.5 + 4.2 + 7.1	1085	10.4	9.00	8.50	A+++	371	0.7 + 0.7 + 0.8 + 1.4 + 2.2
	1.6 + 1.6 + 2.5 + 5.0 + 5.0	1130	10.8	9.00	8.50	A+++	371	0.7 + 0.7 + 0.9 + 1.7 + 1.7
	1.6 + 1.6 + 2.5 + 5.0 + 6.0	1130	10.8	9.00	8.50	A+++	371	0.7 + 0.7 + 0.9 + 1.6 + 1.8
	1.6 + 1.6 + 2.5 + 5.0 + 7.1	1135	10.9	9.00	8.50	A+++	371	0.7 + 0.7 + 0.8 + 1.6 + 2.1
	1.6 + 1.6 + 2.5 + 6.0 + 6.0	1130	10.8	9.00	8.50	A+++	371	0.7 + 0.7 + 0.8 + 1.7 + 1.7
	1.6 + 1.6 + 3.5 + 3.5 + 3.5	1105	10.6	9.00	8.50	A+++	371	0.7 + 0.7 + 1.5 + 1.5 + 1.5
	1.6 + 1.6 + 3.5 + 3.5 + 4.2	1105	10.6	9.00	8.50	A+++	371	0.7 + 0.7 + 1.4 + 1.4 + 1.6
	1.6 + 1.6 + 3.5 + 3.5 + 5.0	1085	10.4	9.00	8.50	A+++	371	0.7 + 0.7 + 1.3 + 1.3 + 1.7
	1.6 + 1.6 + 3.5 + 3.5 + 6.0	1085	10.4	9.00	8.50	A+++	371	0.7 + 0.7 + 1.3 + 1.3 + 1.9
	1.6 + 1.6 + 3.5 + 3.5 + 7.1	1090	10.4	9.00	8.50	A+++	371	0.7 + 0.7 + 1.2 + 1.2 + 2.2
	1.6 + 1.6 + 3.5 + 4.2 + 4.2	1105	10.6	9.00	8.50	A+++	371	0.7 + 0.7 + 1.4 + 1.5 + 1.5
	1.6 + 1.6 + 3.5 + 4.2 + 5.0	1085	10.4	9.00	8.50	A+++	371	0.7 + 0.7 + 1.3 + 1.5 + 1.7
	1.6 + 1.6 + 3.5 + 4.2 + 6.0	1085	10.4	9.00	8.50	A+++	371	0.7 + 0.7 + 1.2 + 1.5 + 1.8
	1.6 + 1.6 + 3.5 + 4.2 + 7.1	1090	10.4	9.00	8.50	A+++	371	0.7 + 0.7 + 1.1 + 1.4 + 2.1
	1.6 + 1.6 + 3.5 + 5.0 + 5.0	1130	10.8	9.00	8.50	A+++	371	0.7 + 0.7 + 1.2 + 1.6 + 1.6
	1.6 + 1.6 + 3.5 + 5.0 + 6.0	1130	10.8	9.00	8.50	A+++	371	0.7 + 0.7 + 1.1 + 1.6 + 1.7
	1.6 + 1.6 + 4.2 + 4.2 + 4.2	1075	10.3	8.99	8.50	A+++	370	0.7 + 0.7 + 1.5 + 1.5 + 1.5
	1.6 + 1.6 + 4.2 + 4.2 + 5.0	1085	10.4	9.00	8.50	A+++	371	0.7 + 0.7 + 1.5 + 1.5 + 1.6
	1.6 + 1.6 + 4.2 + 4.2 + 6.0	1085	10.4	9.00	8.50	A+++	371	0.7 + 0.7 + 1.4 + 1.4 + 1.7
	1.6 + 1.6 + 4.2 + 5.0 + 5.0	1135	10.9	9.00	8.50	A+++	371	0.7 + 0.7 + 1.4 + 1.6 + 1.6
	1.6 + 1.6 + 5.0 + 5.0 + 5.0	1150	11.0	8.99	8.50	A+++	370	0.7 + 0.7 + 1.5 + 1.5 + 1.5
	1.6 + 2.0 + 2.0 + 2.0 + 2.0	1100	10.5	9.00	8.50	A+++	371	0.9 + 1.2 + 1.2 + 1.2 + 1.2
	1.6 + 2.0 + 2.0 + 2.0 + 2.5	1100	10.5	9.00	8.50	A+++	371	0.9 + 1.1 + 1.1 + 1.1 + 1.5
	1.6 + 2.0 + 2.0 + 2.0 + 3.5	1100	10.5	9.00	8.50	A+++	371	0.8 + 1.0 + 1.0 + 1.0 + 1.7
1.6 + 2.0 + 2.0 + 2.0 + 4.2	1105	10.6	9.00	8.50	A+++	371	0.8 + 1.0 + 1.0 + 1.0 + 1.8	
1.6 + 2.0 + 2.0 + 2.0 + 5.0	1080	10.3	9.00	8.50	A+++	371	0.7 + 0.9 + 0.9 + 0.9 + 2.1	
1.6 + 2.0 + 2.0 + 2.0 + 6.0	1080	10.3	9.00	8.50	A+++	371	0.7 + 0.8 + 0.8 + 0.8 + 2.3	
1.6 + 2.0 + 2.0 + 2.0 + 7.1	1085	10.4	9.00	8.50	A+++	371	0.7 + 0.8 + 0.8 + 0.8 + 2.4	
1.6 + 2.0 + 2.0 + 2.5 + 2.5	1100	10.5	9.00	8.50	A+++	371	0.9 + 1.1 + 1.1 + 1.4 + 1.4	
1.6 + 2.0 + 2.0 + 2.5 + 3.5	1100	10.5	9.00	8.50	A+++	371	0.8 + 1.0 + 1.0 + 1.3 + 1.6	
1.6 + 2.0 + 2.0 + 2.5 + 4.2	1105	10.6	9.00	8.50	A+++	371	0.7 + 0.9 + 0.9 + 1.2 + 1.7	
1.6 + 2.0 + 2.0 + 2.5 + 5.0	1080	10.3	9.00	8.50	A+++	371	0.7 + 0.9 + 0.9 + 1.1 + 2.0	
1.6 + 2.0 + 2.0 + 2.5 + 6.0	1080	10.3	9.00	8.50	A+++	371	0.7 + 0.8 + 0.8 + 1.0 + 2.2	
1.6 + 2.0 + 2.0 + 2.5 + 7.1	1085	10.4	9.00	8.50	A+++	371	0.7 + 0.7 + 0.7 + 0.9 + 2.4	
1.6 + 2.0 + 2.0 + 3.5 + 3.5	1105	10.6	9.00	8.50	A+++	371	0.7 + 0.9 + 0.9 + 1.5 + 1.5	
1.6 + 2.0 + 2.0 + 3.5 + 4.2	1105	10.6	9.00	8.50	A+++	371	0.7 + 0.9 + 0.9 + 1.5 + 1.7	
1.6 + 2.0 + 2.0 + 3.5 + 5.0	1085	10.4	9.00	8.50	A+++	371	0.7 + 0.8 + 0.8 + 1.5 + 1.8	
1.6 + 2.0 + 2.0 + 3.5 + 6.0	1085	10.4	9.00	8.50	A+++	371	0.7 + 0.7 + 0.7 + 1.4 + 2.1	
1.6 + 2.0 + 2.0 + 3.5 + 7.1	1090	10.4	9.00	8.50	A+++	371	0.7 + 0.7 + 0.7 + 1.3 + 2.3	
1.6 + 2.0 + 2.0 + 4.2 + 4.2	1105	10.6	9.00	8.50	A+++	371	0.7 + 0.8 + 0.8 + 1.6 + 1.6	

Indoor unit capacity Cooling		Total	Cooling Capacity (kW)						Input Power (W)		EER		
			Room A	Room B	Room C	Room D	Room E	Total	min ~ max	Rating	min ~ max	WW	CLASS
5 Room	1.6 + 2.0 + 2.0 + 4.2 + 5.0	14.8	0.97	1.22	1.22	2.55	3.04	9.00	2.9 ~ 11.5	2170	570 ~ 3280	4.15	A
	1.6 + 2.0 + 2.0 + 4.2 + 6.0	15.8	0.91	1.14	1.14	2.39	3.42	9.00	2.9 ~ 11.5	2170	570 ~ 3280	4.15	A
	1.6 + 2.0 + 2.0 + 4.2 + 7.1	16.9	0.85	1.07	1.07	2.24	3.77	9.00	2.9 ~ 11.5	2180	580 ~ 3290	4.13	A
	1.6 + 2.0 + 2.0 + 5.0 + 5.0	15.6	0.94	1.15	1.15	2.88	2.88	9.00	2.9 ~ 11.5	2260	630 ~ 3230	3.98	A
	1.6 + 2.0 + 2.0 + 5.0 + 6.0	16.6	0.87	1.08	1.08	2.71	3.26	9.00	2.9 ~ 11.5	2260	630 ~ 3230	3.98	A
	1.6 + 2.0 + 2.0 + 5.0 + 7.1	17.7	0.81	1.02	1.02	2.54	3.61	9.00	2.9 ~ 11.5	2270	670 ~ 3240	3.96	A
	1.6 + 2.0 + 2.0 + 6.0 + 6.0	17.6	0.82	1.02	1.02	3.07	3.07	9.00	2.9 ~ 11.5	2260	630 ~ 3230	3.98	A
	1.6 + 2.0 + 2.5 + 2.5 + 2.5	11.1	1.29	1.62	2.03	2.03	2.03	9.00	2.9 ~ 11.5	2200	450 ~ 3490	4.09	A
	1.6 + 2.0 + 2.5 + 2.5 + 3.5	12.1	1.19	1.49	1.86	1.86	2.60	9.00	2.9 ~ 11.5	2200	480 ~ 3410	4.09	A
	1.6 + 2.0 + 2.5 + 2.5 + 4.2	12.8	1.13	1.41	1.76	1.76	2.94	9.00	2.9 ~ 11.5	2210	480 ~ 3410	4.07	A
	1.6 + 2.0 + 2.5 + 2.5 + 5.0	13.6	1.06	1.32	1.65	1.65	3.32	9.00	2.9 ~ 11.5	2160	540 ~ 3280	4.17	A
	1.6 + 2.0 + 2.5 + 2.5 + 6.0	14.6	0.99	1.23	1.54	1.54	3.70	9.00	2.9 ~ 11.5	2160	540 ~ 3280	4.17	A
	1.6 + 2.0 + 2.5 + 2.5 + 7.1	15.7	0.92	1.15	1.43	1.43	4.07	9.00	2.9 ~ 11.5	2170	570 ~ 3280	4.15	A
	1.6 + 2.0 + 2.5 + 3.5 + 3.5	13.1	1.10	1.37	1.73	2.40	2.40	9.00	2.9 ~ 11.5	2210	490 ~ 3410	4.07	A
	1.6 + 2.0 + 2.5 + 3.5 + 4.2	13.8	1.04	1.30	1.63	2.28	2.75	9.00	2.9 ~ 11.5	2210	490 ~ 3420	4.07	A
	1.6 + 2.0 + 2.5 + 3.5 + 5.0	14.6	0.99	1.23	1.54	2.16	3.08	9.00	2.9 ~ 11.5	2170	570 ~ 3280	4.15	A
	1.6 + 2.0 + 2.5 + 3.5 + 6.0	15.6	0.92	1.15	1.44	2.02	3.47	9.00	2.9 ~ 11.5	2170	570 ~ 3280	4.15	A
	1.6 + 2.0 + 2.5 + 3.5 + 7.1	16.7	0.86	1.08	1.35	1.89	3.82	9.00	2.9 ~ 11.5	2180	580 ~ 3290	4.13	A
	1.6 + 2.0 + 2.5 + 4.2 + 4.2	14.5	0.99	1.24	1.55	2.61	2.61	9.00	2.9 ~ 11.5	2210	490 ~ 3420	4.07	A
	1.6 + 2.0 + 2.5 + 4.2 + 5.0	15.3	0.94	1.18	1.47	2.47	2.94	9.00	2.9 ~ 11.5	2170	570 ~ 3280	4.15	A
	1.6 + 2.0 + 2.5 + 4.2 + 6.0	16.3	0.88	1.10	1.38	2.32	3.32	9.00	2.9 ~ 11.5	2170	570 ~ 3280	4.15	A
	1.6 + 2.0 + 2.5 + 4.2 + 7.1	17.4	0.83	1.03	1.29	2.17	3.68	9.00	2.9 ~ 11.5	2180	580 ~ 3290	4.13	A
	1.6 + 2.0 + 2.5 + 5.0 + 5.0	16.1	0.89	1.12	1.39	2.80	2.80	9.00	2.9 ~ 11.5	2260	630 ~ 3230	3.98	A
	1.6 + 2.0 + 2.5 + 5.0 + 6.0	17.1	0.84	1.05	1.32	2.63	3.16	9.00	2.9 ~ 11.5	2260	630 ~ 3230	3.98	A
	1.6 + 2.0 + 2.5 + 5.0 + 7.1	18.2	0.79	0.99	1.24	2.47	3.51	9.00	2.9 ~ 11.5	2270	670 ~ 3240	3.96	A
	1.6 + 2.0 + 2.5 + 6.0 + 6.0	18.1	0.80	0.99	1.25	2.98	2.98	9.00	2.9 ~ 11.5	2260	630 ~ 3230	3.98	A
	1.6 + 2.0 + 3.5 + 3.5 + 3.5	14.1	1.02	1.29	2.23	2.23	2.23	9.00	2.9 ~ 11.5	2210	490 ~ 3340	4.07	A
	1.6 + 2.0 + 3.5 + 3.5 + 4.2	14.8	0.97	1.22	2.13	2.13	2.55	9.00	2.9 ~ 11.5	2150	490 ~ 3340	4.19	A
	1.6 + 2.0 + 3.5 + 3.5 + 5.0	15.6	0.92	1.15	2.02	2.02	2.89	9.00	2.9 ~ 11.5	2170	570 ~ 3290	4.15	A
	1.6 + 2.0 + 3.5 + 3.5 + 6.0	16.6	0.87	1.08	1.90	1.90	3.25	9.00	2.9 ~ 11.5	2170	570 ~ 3290	4.15	A
	1.6 + 2.0 + 3.5 + 3.5 + 7.1	17.7	0.81	1.02	1.78	1.78	3.61	9.00	2.9 ~ 11.5	2180	580 ~ 3290	4.13	A
	1.6 + 2.0 + 3.5 + 4.2 + 4.2	15.5	0.93	1.16	2.03	2.44	2.44	9.00	2.9 ~ 11.5	2150	490 ~ 3340	4.19	A
	1.6 + 2.0 + 3.5 + 4.2 + 5.0	16.3	0.88	1.10	1.93	2.32	2.77	9.00	2.9 ~ 11.5	2180	580 ~ 3290	4.13	A
	1.6 + 2.0 + 3.5 + 4.2 + 6.0	17.3	0.83	1.04	1.82	2.18	3.13	9.00	2.9 ~ 11.5	2180	580 ~ 3290	4.13	A
	1.6 + 2.0 + 3.5 + 5.0 + 5.0	17.1	0.84	1.05	1.85	2.63	2.63	9.00	2.9 ~ 11.5	2270	660 ~ 3240	3.96	A
	1.6 + 2.0 + 3.5 + 5.0 + 6.0	18.1	0.80	0.99	1.74	2.49	2.98	9.00	2.9 ~ 11.5	2270	660 ~ 3240	3.96	A
	1.6 + 2.0 + 4.2 + 4.2 + 4.2	16.2	0.89	1.12	2.33	2.33	2.33	9.00	2.9 ~ 11.5	2150	520 ~ 3340	4.19	A
	1.6 + 2.0 + 4.2 + 4.2 + 5.0	17.0	0.85	1.06	2.22	2.22	2.65	9.00	2.9 ~ 11.5	2180	580 ~ 3290	4.13	A
	1.6 + 2.0 + 4.2 + 4.2 + 6.0	18.0	0.80	1.00	2.10	2.10	3.00	9.00	2.9 ~ 11.5	2180	580 ~ 3290	4.13	A
	1.6 + 2.0 + 4.2 + 5.0 + 5.0	17.8	0.81	1.01	2.12	2.53	2.53	9.00	2.9 ~ 11.5	2270	670 ~ 3240	3.96	A
1.6 + 2.5 + 2.5 + 2.5 + 2.5	11.6	1.24	1.94	1.94	1.94	1.94	9.00	2.9 ~ 11.5	2200	450 ~ 3490	4.09	A	
1.6 + 2.5 + 2.5 + 2.5 + 3.5	12.6	1.14	1.79	1.79	1.79	2.49	9.00	2.9 ~ 11.5	2200	480 ~ 3410	4.09	A	
1.6 + 2.5 + 2.5 + 2.5 + 4.2	13.3	1.08	1.69	1.69	1.69	2.85	9.00	2.9 ~ 11.5	2210	480 ~ 3410	4.07	A	
1.6 + 2.5 + 2.5 + 2.5 + 5.0	14.1	1.02	1.60	1.60	1.60	3.18	9.00	2.9 ~ 11.5	2160	540 ~ 3280	4.17	A	
1.6 + 2.5 + 2.5 + 2.5 + 6.0	15.1	0.95	1.49	1.49	1.49	3.58	9.00	2.9 ~ 11.5	2160	540 ~ 3280	4.17	A	
1.6 + 2.5 + 2.5 + 2.5 + 7.1	16.2	0.89	1.39	1.39	1.39	3.94	9.00	2.9 ~ 11.5	2170	570 ~ 3280	4.15	A	
1.6 + 2.5 + 2.5 + 3.5 + 3.5	13.6	1.06	1.65	1.65	2.32	2.32	9.00	2.9 ~ 11.5	2210	490 ~ 3410	4.07	A	
1.6 + 2.5 + 2.5 + 3.5 + 4.2	14.3	1.01	1.57	1.57	2.20	2.65	9.00	2.9 ~ 11.5	2210	490 ~ 3420	4.07	A	
1.6 + 2.5 + 2.5 + 3.5 + 5.0	15.1	0.95	1.49	1.49	2.09	2.98	9.00	2.9 ~ 11.5	2170	570 ~ 3280	4.15	A	
1.6 + 2.5 + 2.5 + 3.5 + 6.0	16.1	0.89	1.40	1.40	1.96	3.35	9.00	2.9 ~ 11.5	2170	570 ~ 3280	4.15	A	
1.6 + 2.5 + 2.5 + 3.5 + 7.1	17.2	0.84	1.31	1.31	1.83	3.71	9.00	2.9 ~ 11.5	2180	580 ~ 3290	4.13	A	
1.6 + 2.5 + 2.5 + 4.2 + 4.2	15.0	0.96	1.50	1.50	2.52	2.52	9.00	2.9 ~ 11.5	2210	490 ~ 3420	4.07	A	
1.6 + 2.5 + 2.5 + 4.2 + 5.0	15.8	0.91	1.42	1.42	2.39	2.86	9.00	2.9 ~ 11.5	2170	570 ~ 3280	4.15	A	
1.6 + 2.5 + 2.5 + 4.2 + 6.0	16.8	0.86	1.34	1.34	2.25	3.21	9.00	2.9 ~ 11.5	2170	570 ~ 3280	4.15	A	
1.6 + 2.5 + 2.5 + 4.2 + 7.1	17.9	0.80	1.26	1.26	2.11	3.57	9.00	2.9 ~ 11.5	2180	580 ~ 3290	4.13	A	
1.6 + 2.5 + 2.5 + 5.0 + 5.0	16.6	0.86	1.36	1.36	2.71	2.71	9.00	2.9 ~ 11.5	2260	630 ~ 3230	3.98	A	
1.6 + 2.5 + 2.5 + 5.0 + 6.0	17.6	0.82	1.28	1.28	2.56	3.06	9.00	2.9 ~ 11.5	2260	630 ~ 3230	3.98	A	
1.6 + 2.5 + 3.5 + 3.5 + 3.5	14.6	0.99	1.53	2.16	2.16	2.16	9.00	2.9 ~ 11.5	2210	490 ~ 3340	4.07	A	



	Indoor unit capacity Cooling	Annual Energy Consumption (kWh)	Current 230V (A)	ERP			Moisture Removal Volume l/h	
				Pdesign (kW)	SEER			Annual Consumption (kWh)
					W/W	CLASS		
5 Room	1.6 + 2.0 + 2.0 + 4.2 + 5.0	1085	10.4	9.00	8.50	A+++	371	0.7 + 0.8 + 0.8 + 1.6 + 1.7
	1.6 + 2.0 + 2.0 + 4.2 + 6.0	1085	10.4	9.00	8.50	A+++	371	0.7 + 0.7 + 0.7 + 1.5 + 2.0
	1.6 + 2.0 + 2.0 + 4.2 + 7.1	1090	10.4	9.00	8.50	A+++	371	0.7 + 0.7 + 0.7 + 1.5 + 2.2
	1.6 + 2.0 + 2.0 + 5.0 + 5.0	1130	10.8	9.00	8.50	A+++	371	0.7 + 0.7 + 0.7 + 1.7 + 1.7
	1.6 + 2.0 + 2.0 + 5.0 + 6.0	1130	10.8	9.00	8.50	A+++	371	0.7 + 0.7 + 0.7 + 1.6 + 1.9
	1.6 + 2.0 + 2.0 + 5.0 + 7.1	1135	10.9	9.00	8.50	A+++	371	0.7 + 0.7 + 0.7 + 1.6 + 2.1
	1.6 + 2.0 + 2.0 + 6.0 + 6.0	1130	10.8	9.00	8.50	A+++	371	0.7 + 0.7 + 0.7 + 1.7 + 1.7
	1.6 + 2.0 + 2.5 + 2.5 + 2.5	1100	10.5	9.00	8.50	A+++	371	0.8 + 1.0 + 1.3 + 1.3 + 1.3
	1.6 + 2.0 + 2.5 + 2.5 + 3.5	1100	10.5	9.00	8.50	A+++	371	0.7 + 0.9 + 1.2 + 1.2 + 1.6
	1.6 + 2.0 + 2.5 + 2.5 + 4.2	1105	10.6	9.00	8.50	A+++	371	0.7 + 0.9 + 1.1 + 1.1 + 1.7
	1.6 + 2.0 + 2.5 + 2.5 + 5.0	1080	10.3	9.00	8.50	A+++	371	0.7 + 0.8 + 1.1 + 1.1 + 1.9
	1.6 + 2.0 + 2.5 + 2.5 + 6.0	1080	10.3	9.00	8.50	A+++	371	0.7 + 0.8 + 1.0 + 1.0 + 2.2
	1.6 + 2.0 + 2.5 + 2.5 + 7.1	1085	10.4	9.00	8.50	A+++	371	0.7 + 0.7 + 0.9 + 0.9 + 2.3
	1.6 + 2.0 + 2.5 + 3.5 + 3.5	1105	10.6	9.00	8.50	A+++	371	0.7 + 0.9 + 1.1 + 1.5 + 1.5
	1.6 + 2.0 + 2.5 + 3.5 + 4.2	1105	10.6	9.00	8.50	A+++	371	0.7 + 0.8 + 1.0 + 1.5 + 1.6
	1.6 + 2.0 + 2.5 + 3.5 + 5.0	1085	10.4	9.00	8.50	A+++	371	0.7 + 0.8 + 1.0 + 1.4 + 1.7
	1.6 + 2.0 + 2.5 + 3.5 + 6.0	1085	10.4	9.00	8.50	A+++	371	0.7 + 0.7 + 0.9 + 1.3 + 2.0
	1.6 + 2.0 + 2.5 + 3.5 + 7.1	1090	10.4	9.00	8.50	A+++	371	0.7 + 0.7 + 0.9 + 1.2 + 2.2
	1.6 + 2.0 + 2.5 + 4.2 + 4.2	1105	10.6	9.00	8.50	A+++	371	0.7 + 0.8 + 1.0 + 1.6 + 1.6
	1.6 + 2.0 + 2.5 + 4.2 + 5.0	1085	10.4	9.00	8.50	A+++	371	0.7 + 0.7 + 0.9 + 1.5 + 1.7
	1.6 + 2.0 + 2.5 + 4.2 + 6.0	1085	10.4	9.00	8.50	A+++	371	0.7 + 0.7 + 0.9 + 1.5 + 1.9
	1.6 + 2.0 + 2.5 + 4.2 + 7.1	1090	10.4	9.00	8.50	A+++	371	0.7 + 0.7 + 0.8 + 1.4 + 2.1
	1.6 + 2.0 + 2.5 + 5.0 + 5.0	1130	10.8	9.00	8.50	A+++	371	0.7 + 0.7 + 0.9 + 1.6 + 1.6
	1.6 + 2.0 + 2.5 + 5.0 + 6.0	1130	10.8	9.00	8.50	A+++	371	0.7 + 0.7 + 0.8 + 1.6 + 1.8
	1.6 + 2.0 + 2.5 + 5.0 + 7.1	1135	10.9	9.00	8.50	A+++	371	0.7 + 0.7 + 0.8 + 1.5 + 2.0
	1.6 + 2.0 + 2.5 + 6.0 + 6.0	1130	10.8	9.00	8.50	A+++	371	0.7 + 0.7 + 0.8 + 1.7 + 1.7
	1.6 + 2.0 + 3.5 + 3.5 + 3.5	1105	10.6	9.00	8.50	A+++	371	0.7 + 0.8 + 1.5 + 1.5 + 1.5
	1.6 + 2.0 + 3.5 + 3.5 + 4.2	1075	10.3	9.00	8.50	A+++	371	0.7 + 0.8 + 1.4 + 1.4 + 1.6
	1.6 + 2.0 + 3.5 + 3.5 + 5.0	1085	10.4	9.00	8.50	A+++	371	0.7 + 0.7 + 1.3 + 1.3 + 1.7
	1.6 + 2.0 + 3.5 + 3.5 + 6.0	1085	10.4	9.00	8.50	A+++	371	0.7 + 0.7 + 1.2 + 1.2 + 1.8
	1.6 + 2.0 + 3.5 + 3.5 + 7.1	1090	10.4	9.00	8.50	A+++	371	0.7 + 0.7 + 1.1 + 1.1 + 2.1
	1.6 + 2.0 + 3.5 + 4.2 + 4.2	1075	10.3	9.00	8.50	A+++	371	0.7 + 0.7 + 1.3 + 1.5 + 1.5
	1.6 + 2.0 + 3.5 + 4.2 + 5.0	1090	10.4	9.00	8.50	A+++	371	0.7 + 0.7 + 1.2 + 1.5 + 1.6
	1.6 + 2.0 + 3.5 + 4.2 + 6.0	1090	10.4	9.00	8.50	A+++	371	0.7 + 0.7 + 1.2 + 1.4 + 1.8
	1.6 + 2.0 + 3.5 + 5.0 + 5.0	1135	10.9	9.00	8.50	A+++	371	0.7 + 0.7 + 1.2 + 1.6 + 1.6
	1.6 + 2.0 + 3.5 + 5.0 + 6.0	1135	10.9	9.00	8.50	A+++	371	0.7 + 0.7 + 1.1 + 1.5 + 1.7
	1.6 + 2.0 + 4.2 + 4.2 + 4.2	1075	10.3	9.00	8.50	A+++	371	0.7 + 0.7 + 1.5 + 1.5 + 1.5
	1.6 + 2.0 + 4.2 + 4.2 + 5.0	1090	10.4	9.00	8.50	A+++	371	0.7 + 0.7 + 1.4 + 1.4 + 1.6
	1.6 + 2.0 + 4.2 + 4.2 + 6.0	1090	10.4	9.00	8.50	A+++	371	0.7 + 0.7 + 1.4 + 1.4 + 1.7
	1.6 + 2.0 + 4.2 + 5.0 + 5.0	1135	10.9	9.00	8.50	A+++	371	0.7 + 0.7 + 1.4 + 1.6 + 1.6
1.6 + 2.5 + 2.5 + 2.5 + 2.5	1100	10.5	9.00	8.50	A+++	371	0.8 + 1.3 + 1.3 + 1.3 + 1.3	
1.6 + 2.5 + 2.5 + 2.5 + 3.5	1100	10.5	9.00	8.50	A+++	371	0.7 + 1.2 + 1.2 + 1.2 + 1.5	
1.6 + 2.5 + 2.5 + 2.5 + 4.2	1105	10.6	9.00	8.50	A+++	371	0.7 + 1.1 + 1.1 + 1.1 + 1.7	
1.6 + 2.5 + 2.5 + 2.5 + 5.0	1080	10.3	9.00	8.50	A+++	371	0.7 + 1.0 + 1.0 + 1.0 + 1.8	
1.6 + 2.5 + 2.5 + 2.5 + 6.0	1080	10.3	9.00	8.50	A+++	371	0.7 + 0.9 + 0.9 + 0.9 + 2.1	
1.6 + 2.5 + 2.5 + 2.5 + 7.1	1085	10.4	9.00	8.50	A+++	371	0.7 + 0.9 + 0.9 + 0.9 + 2.3	
1.6 + 2.5 + 2.5 + 3.5 + 3.5	1105	10.6	9.00	8.50	A+++	371	0.7 + 1.1 + 1.1 + 1.5 + 1.5	
1.6 + 2.5 + 2.5 + 3.5 + 4.2	1105	10.6	9.00	8.50	A+++	371	0.7 + 1.0 + 1.0 + 1.4 + 1.6	
1.6 + 2.5 + 2.5 + 3.5 + 5.0	1085	10.4	9.00	8.50	A+++	371	0.7 + 0.9 + 0.9 + 1.4 + 1.7	
1.6 + 2.5 + 2.5 + 3.5 + 6.0	1085	10.4	9.00	8.50	A+++	371	0.7 + 0.9 + 0.9 + 1.3 + 1.9	
1.6 + 2.5 + 2.5 + 3.5 + 7.1	1090	10.4	9.00	8.50	A+++	371	0.7 + 0.8 + 0.8 + 1.2 + 2.2	
1.6 + 2.5 + 2.5 + 4.2 + 4.2	1105	10.6	9.00	8.50	A+++	371	0.7 + 1.0 + 1.0 + 1.5 + 1.5	
1.6 + 2.5 + 2.5 + 4.2 + 5.0	1085	10.4	9.00	8.50	A+++	371	0.7 + 0.9 + 0.9 + 1.5 + 1.7	
1.6 + 2.5 + 2.5 + 4.2 + 6.0	1085	10.4	9.00	8.50	A+++	371	0.7 + 0.8 + 0.8 + 1.5 + 1.8	
1.6 + 2.5 + 2.5 + 4.2 + 7.1	1090	10.4	9.00	8.50	A+++	371	0.7 + 0.8 + 0.8 + 1.4 + 2.1	
1.6 + 2.5 + 2.5 + 5.0 + 5.0	1130	10.8	9.00	8.50	A+++	371	0.7 + 0.9 + 0.9 + 1.6 + 1.6	
1.6 + 2.5 + 2.5 + 5.0 + 6.0	1130	10.8	9.00	8.50	A+++	371	0.7 + 0.8 + 0.8 + 1.6 + 1.7	
1.6 + 2.5 + 3.5 + 3.5 + 3.5	1105	10.6	9.00	8.50	A+++	371	0.7 + 1.0 + 1.4 + 1.4 + 1.4	

Indoor unit capacity Cooling		Total	Cooling Capacity (kW)							Input Power (W)		EER	
			Room A	Room B	Room C	Room D	Room E	Total	min ~ max	Rating	min ~ max	WW	CLASS
5 Room	1.6 + 2.5 + 3.5 + 3.5 + 4.2	15.3	0.94	1.47	2.06	2.06	2.47	9.00	2.9 ~ 11.5	2150	490 ~ 3340	4.19	A
	1.6 + 2.5 + 3.5 + 3.5 + 5.0	16.1	0.89	1.40	1.96	1.96	2.79	9.00	2.9 ~ 11.5	2170	570 ~ 3290	4.15	A
	1.6 + 2.5 + 3.5 + 3.5 + 6.0	17.1	0.84	1.32	1.84	1.84	3.16	9.00	2.9 ~ 11.5	2170	570 ~ 3290	4.15	A
	1.6 + 2.5 + 3.5 + 3.5 + 7.1	18.2	0.79	1.24	1.73	1.73	3.51	9.00	2.9 ~ 11.5	2180	580 ~ 3290	4.13	A
	1.6 + 2.5 + 3.5 + 4.2 + 4.2	16.0	0.90	1.41	1.97	2.36	2.36	9.00	2.9 ~ 11.5	2150	490 ~ 3340	4.19	A
	1.6 + 2.5 + 3.5 + 4.2 + 5.0	16.8	0.86	1.34	1.88	2.25	2.67	9.00	2.9 ~ 11.5	2180	580 ~ 3290	4.13	A
	1.6 + 2.5 + 3.5 + 4.2 + 6.0	17.8	0.81	1.26	1.77	2.12	3.04	9.00	2.9 ~ 11.5	2180	580 ~ 3290	4.13	A
	1.6 + 2.5 + 3.5 + 5.0 + 5.0	17.6	0.82	1.28	1.78	2.56	2.56	9.00	2.9 ~ 11.5	2270	660 ~ 3240	3.96	A
	1.6 + 2.5 + 4.2 + 4.2 + 4.2	16.7	0.86	1.36	2.26	2.26	2.26	9.00	2.9 ~ 11.5	2150	520 ~ 3340	4.19	A
	1.6 + 2.5 + 4.2 + 4.2 + 5.0	17.5	0.82	1.29	2.16	2.16	2.57	9.00	2.9 ~ 11.5	2180	580 ~ 3290	4.13	A
	1.6 + 2.5 + 4.2 + 5.0 + 5.0	18.3	0.79	1.23	2.06	2.46	2.46	9.00	2.9 ~ 11.5	2270	670 ~ 3240	3.96	A
	1.6 + 3.5 + 3.5 + 3.5 + 3.5	15.6	0.92	2.02	2.02	2.02	2.02	9.00	2.9 ~ 11.5	2150	520 ~ 3350	4.19	A
	1.6 + 3.5 + 3.5 + 3.5 + 4.2	16.3	0.88	1.93	1.93	1.93	2.33	9.00	2.9 ~ 11.5	2160	520 ~ 3350	4.17	A
	1.6 + 3.5 + 3.5 + 3.5 + 5.0	17.1	0.84	1.84	1.84	1.84	2.64	9.00	2.9 ~ 11.5	2180	580 ~ 3290	4.13	A
	1.6 + 3.5 + 3.5 + 3.5 + 6.0	18.1	0.80	1.74	1.74	1.74	2.98	9.00	2.9 ~ 11.5	2180	580 ~ 3290	4.13	A
	1.6 + 3.5 + 3.5 + 4.2 + 4.2	17.0	0.86	1.85	1.85	2.22	2.22	9.00	2.9 ~ 11.5	2160	530 ~ 3350	4.17	A
	1.6 + 3.5 + 3.5 + 4.2 + 5.0	17.8	0.81	1.77	1.77	2.12	2.53	9.00	2.9 ~ 11.5	2180	580 ~ 3290	4.13	A
	1.6 + 3.5 + 4.2 + 4.2 + 4.2	17.7	0.81	1.77	2.14	2.14	2.14	9.00	2.9 ~ 11.5	2160	530 ~ 3350	4.17	A
	2.0 + 2.0 + 2.0 + 2.0 + 2.0	10.0	1.80	1.80	1.80	1.80	1.80	9.00	2.9 ~ 11.5	2200	480 ~ 3490	4.09	A
	2.0 + 2.0 + 2.0 + 2.0 + 2.5	10.5	1.71	1.71	1.71	1.71	2.16	9.00	2.9 ~ 11.5	2200	480 ~ 3490	4.09	A
	2.0 + 2.0 + 2.0 + 2.0 + 3.5	11.5	1.57	1.57	1.57	1.57	2.72	9.00	2.9 ~ 11.5	2210	480 ~ 3410	4.07	A
	2.0 + 2.0 + 2.0 + 2.0 + 4.2	12.2	1.48	1.48	1.48	1.48	3.08	9.00	2.9 ~ 11.5	2210	490 ~ 3410	4.07	A
	2.0 + 2.0 + 2.0 + 2.0 + 5.0	13.0	1.38	1.38	1.38	1.38	3.48	9.00	2.9 ~ 11.5	2170	540 ~ 3280	4.15	A
	2.0 + 2.0 + 2.0 + 2.0 + 6.0	14.0	1.29	1.29	1.29	1.29	3.84	9.00	2.9 ~ 11.5	2170	540 ~ 3280	4.15	A
	2.0 + 2.0 + 2.0 + 2.0 + 7.1	15.1	1.19	1.19	1.19	1.19	4.24	9.00	2.9 ~ 11.5	2170	570 ~ 3280	4.15	A
	2.0 + 2.0 + 2.0 + 2.5 + 2.5	11.0	1.64	1.64	1.64	2.04	2.04	9.00	2.9 ~ 11.5	2200	480 ~ 3490	4.09	A
	2.0 + 2.0 + 2.0 + 2.5 + 3.5	12.0	1.50	1.50	1.50	1.88	2.62	9.00	2.9 ~ 11.5	2210	480 ~ 3410	4.07	A
	2.0 + 2.0 + 2.0 + 2.5 + 4.2	12.7	1.42	1.42	1.42	1.77	2.97	9.00	2.9 ~ 11.5	2210	490 ~ 3410	4.07	A
	2.0 + 2.0 + 2.0 + 2.5 + 5.0	13.5	1.33	1.33	1.33	1.67	3.34	9.00	2.9 ~ 11.5	2170	540 ~ 3280	4.15	A
	2.0 + 2.0 + 2.0 + 2.5 + 6.0	14.5	1.24	1.24	1.24	1.55	3.73	9.00	2.9 ~ 11.5	2170	540 ~ 3280	4.15	A
	2.0 + 2.0 + 2.0 + 2.5 + 7.1	15.6	1.15	1.15	1.15	1.44	4.11	9.00	2.9 ~ 11.5	2170	570 ~ 3280	4.15	A
	2.0 + 2.0 + 2.0 + 3.5 + 3.5	13.0	1.38	1.38	1.38	2.43	2.43	9.00	2.9 ~ 11.5	2210	490 ~ 3420	4.07	A
	2.0 + 2.0 + 2.0 + 3.5 + 4.2	13.7	1.31	1.31	1.31	2.30	2.77	9.00	2.9 ~ 11.5	2210	490 ~ 3420	4.07	A
	2.0 + 2.0 + 2.0 + 3.5 + 5.0	14.5	1.24	1.24	1.24	2.17	3.11	9.00	2.9 ~ 11.5	2170	570 ~ 3280	4.15	A
	2.0 + 2.0 + 2.0 + 3.5 + 6.0	15.5	1.16	1.16	1.16	2.03	3.49	9.00	2.9 ~ 11.5	2170	570 ~ 3280	4.15	A
	2.0 + 2.0 + 2.0 + 3.5 + 7.1	16.6	1.08	1.08	1.08	1.90	3.86	9.00	2.9 ~ 11.5	2180	580 ~ 3290	4.13	A
	2.0 + 2.0 + 2.0 + 4.2 + 4.2	14.4	1.25	1.25	1.25	2.62	2.62	8.99	2.9 ~ 11.5	2150	490 ~ 3420	4.18	A
	2.0 + 2.0 + 2.0 + 4.2 + 5.0	15.2	1.18	1.18	1.18	2.49	2.97	9.00	2.9 ~ 11.5	2170	570 ~ 3280	4.15	A
	2.0 + 2.0 + 2.0 + 4.2 + 6.0	16.2	1.11	1.11	1.11	2.33	3.34	9.00	2.9 ~ 11.5	2170	570 ~ 3280	4.15	A
	2.0 + 2.0 + 2.0 + 4.2 + 7.1	17.3	1.04	1.04	1.04	2.18	3.70	9.00	2.9 ~ 11.5	2180	580 ~ 3290	4.13	A
	2.0 + 2.0 + 2.0 + 5.0 + 5.0	16.0	1.13	1.13	1.13	2.80	2.80	8.99	2.9 ~ 11.5	2260	660 ~ 3230	3.98	A
	2.0 + 2.0 + 2.0 + 5.0 + 6.0	17.0	1.06	1.06	1.06	2.65	3.17	9.00	2.9 ~ 11.5	2260	660 ~ 3230	3.98	A
	2.0 + 2.0 + 2.0 + 5.0 + 7.1	18.1	0.99	0.99	0.99	2.49	3.54	9.00	2.9 ~ 11.5	2270	670 ~ 3240	3.96	A
	2.0 + 2.0 + 2.0 + 6.0 + 6.0	18.0	1.00	1.00	1.00	3.00	3.00	9.00	2.9 ~ 11.5	2260	660 ~ 3230	3.98	A
	2.0 + 2.0 + 2.5 + 2.5 + 2.5	11.5	1.56	1.56	1.96	1.96	1.96	9.00	2.9 ~ 11.5	2200	480 ~ 3490	4.09	A
2.0 + 2.0 + 2.5 + 2.5 + 3.5	12.5	1.44	1.44	1.80	1.80	2.52	9.00	2.9 ~ 11.5	2210	480 ~ 3410	4.07	A	
2.0 + 2.0 + 2.5 + 2.5 + 4.2	13.2	1.36	1.36	1.70	1.70	2.88	9.00	2.9 ~ 11.5	2210	490 ~ 3410	4.07	A	
2.0 + 2.0 + 2.5 + 2.5 + 5.0	14.0	1.29	1.29	1.61	1.61	3.20	9.00	2.9 ~ 11.5	2170	540 ~ 3280	4.15	A	
2.0 + 2.0 + 2.5 + 2.5 + 6.0	15.0	1.20	1.20	1.50	1.50	3.60	9.00	2.9 ~ 11.5	2170	540 ~ 3280	4.15	A	
2.0 + 2.0 + 2.5 + 2.5 + 7.1	16.1	1.12	1.12	1.40	1.40	3.96	9.00	2.9 ~ 11.5	2170	570 ~ 3280	4.15	A	
2.0 + 2.0 + 2.5 + 3.5 + 3.5	13.5	1.33	1.33	1.68	2.33	2.33	9.00	2.9 ~ 11.5	2210	490 ~ 3420	4.07	A	
2.0 + 2.0 + 2.5 + 3.5 + 4.2	14.2	1.27	1.27	1.58	2.22	2.66	9.00	2.9 ~ 11.5	2210	490 ~ 3420	4.07	A	
2.0 + 2.0 + 2.5 + 3.5 + 5.0	15.0	1.20	1.20	1.50	2.10	3.00	9.00	2.9 ~ 11.5	2170	570 ~ 3280	4.15	A	
2.0 + 2.0 + 2.5 + 3.5 + 6.0	16.0	1.13	1.13	1.41	1.97	3.36	9.00	2.9 ~ 11.5	2170	570 ~ 3280	4.15	A	
2.0 + 2.0 + 2.5 + 3.5 + 7.1	17.1	1.05	1.05	1.32	1.84	3.74	9.00	2.9 ~ 11.5	2180	580 ~ 3290	4.13	A	
2.0 + 2.0 + 2.5 + 4.2 + 4.2	14.9	1.21	1.21	1.50	2.54	2.54	9.00	2.9 ~ 11.5	2210	490 ~ 3420	4.07	A	
2.0 + 2.0 + 2.5 + 4.2 + 5.0	15.7	1.15	1.15	1.43	2.41	2.86	9.00	2.9 ~ 11.5	2170	570 ~ 3280	4.15	A	
2.0 + 2.0 + 2.5 + 4.2 + 6.0	16.7	1.08	1.08	1.35	2.26	3.23	9.00	2.9 ~ 11.5	2170	570 ~ 3280	4.15	A	

	Indoor unit capacity Cooling	Annual Energy Consumption (kWh)	Current 230V (A)	ERP			Moisture Removal Volume l/h	
				Pdesign (kW)	SEER			Annual Consumption (kWh)
					W/W	CLASS		
5 Room	1.6 + 2.5 + 3.5 + 3.5 + 4.2	1075	10.3	9.00	8.50	A+++	371	0.7 + 0.9 + 1.3 + 1.3 + 1.5
	1.6 + 2.5 + 3.5 + 3.5 + 5.0	1085	10.4	9.00	8.50	A+++	371	0.7 + 0.9 + 1.3 + 1.3 + 1.6
	1.6 + 2.5 + 3.5 + 3.5 + 6.0	1085	10.4	9.00	8.50	A+++	371	0.7 + 0.8 + 1.2 + 1.2 + 1.8
	1.6 + 2.5 + 3.5 + 3.5 + 7.1	1090	10.4	9.00	8.50	A+++	371	0.7 + 0.8 + 1.1 + 1.1 + 2.0
	1.6 + 2.5 + 3.5 + 4.2 + 4.2	1075	10.3	9.00	8.50	A+++	371	0.7 + 0.9 + 1.3 + 1.5 + 1.5
	1.6 + 2.5 + 3.5 + 4.2 + 5.0	1090	10.4	9.00	8.50	A+++	371	0.7 + 0.8 + 1.2 + 1.5 + 1.6
	1.6 + 2.5 + 3.5 + 4.2 + 6.0	1090	10.4	9.00	8.50	A+++	371	0.7 + 0.8 + 1.1 + 1.4 + 1.7
	1.6 + 2.5 + 3.5 + 5.0 + 5.0	1135	10.9	9.00	8.50	A+++	371	0.7 + 0.8 + 1.1 + 1.6 + 1.6
	1.6 + 2.5 + 4.2 + 4.2 + 4.2	1075	10.3	9.00	8.50	A+++	371	0.7 + 0.9 + 1.5 + 1.5 + 1.5
	1.6 + 2.5 + 4.2 + 4.2 + 5.0	1090	10.4	9.00	8.50	A+++	371	0.7 + 0.8 + 1.4 + 1.4 + 1.6
	1.6 + 2.5 + 4.2 + 5.0 + 5.0	1135	10.9	9.00	8.50	A+++	371	0.7 + 0.8 + 1.3 + 1.5 + 1.5
	1.6 + 3.5 + 3.5 + 3.5 + 3.5	1075	10.3	9.00	8.50	A+++	371	0.7 + 1.3 + 1.3 + 1.3 + 1.3
	1.6 + 3.5 + 3.5 + 3.5 + 4.2	1080	10.3	9.00	8.50	A+++	371	0.7 + 1.2 + 1.2 + 1.2 + 1.5
	1.6 + 3.5 + 3.5 + 3.5 + 5.0	1090	10.4	9.00	8.50	A+++	371	0.7 + 1.2 + 1.2 + 1.2 + 1.6
	1.6 + 3.5 + 3.5 + 3.5 + 6.0	1090	10.4	9.00	8.50	A+++	371	0.7 + 1.1 + 1.1 + 1.1 + 1.7
	1.6 + 3.5 + 3.5 + 4.2 + 4.2	1080	10.3	9.00	8.50	A+++	371	0.7 + 1.2 + 1.2 + 1.4 + 1.4
	1.6 + 3.5 + 3.5 + 4.2 + 5.0	1090	10.4	9.00	8.50	A+++	371	0.7 + 1.1 + 1.1 + 1.4 + 1.6
	1.6 + 3.5 + 4.2 + 4.2 + 4.2	1080	10.3	9.00	8.50	A+++	371	0.7 + 1.1 + 1.4 + 1.4 + 1.4
	2.0 + 2.0 + 2.0 + 2.0 + 2.0	1100	10.5	9.00	8.50	A+++	371	1.2 + 1.2 + 1.2 + 1.2 + 1.2
	2.0 + 2.0 + 2.0 + 2.0 + 2.5	1100	10.5	9.00	8.50	A+++	371	1.1 + 1.1 + 1.1 + 1.1 + 1.4
	2.0 + 2.0 + 2.0 + 2.0 + 3.5	1105	10.6	9.00	8.50	A+++	371	1.0 + 1.0 + 1.0 + 1.0 + 1.6
	2.0 + 2.0 + 2.0 + 2.0 + 4.2	1105	10.6	9.00	8.50	A+++	371	0.9 + 0.9 + 0.9 + 0.9 + 1.7
	2.0 + 2.0 + 2.0 + 2.0 + 5.0	1085	10.4	9.00	8.50	A+++	371	0.9 + 0.9 + 0.9 + 0.9 + 2.0
	2.0 + 2.0 + 2.0 + 2.0 + 6.0	1085	10.4	9.00	8.50	A+++	371	0.8 + 0.8 + 0.8 + 0.8 + 2.2
	2.0 + 2.0 + 2.0 + 2.0 + 7.1	1085	10.4	9.00	8.50	A+++	371	0.7 + 0.7 + 0.7 + 0.7 + 2.4
	2.0 + 2.0 + 2.0 + 2.5 + 2.5	1100	10.5	9.00	8.50	A+++	371	1.0 + 1.0 + 1.0 + 1.3 + 1.3
	2.0 + 2.0 + 2.0 + 2.5 + 3.5	1105	10.6	9.00	8.50	A+++	371	1.0 + 1.0 + 1.0 + 1.2 + 1.6
	2.0 + 2.0 + 2.0 + 2.5 + 4.2	1105	10.6	9.00	8.50	A+++	371	0.9 + 0.9 + 0.9 + 1.1 + 1.7
	2.0 + 2.0 + 2.0 + 2.5 + 5.0	1085	10.4	9.00	8.50	A+++	371	0.8 + 0.8 + 0.8 + 1.1 + 1.9
	2.0 + 2.0 + 2.0 + 2.5 + 6.0	1085	10.4	9.00	8.50	A+++	371	0.8 + 0.8 + 0.8 + 1.0 + 2.2
	2.0 + 2.0 + 2.0 + 2.5 + 7.1	1085	10.4	9.00	8.50	A+++	371	0.7 + 0.7 + 0.7 + 0.9 + 2.3
	2.0 + 2.0 + 2.0 + 3.5 + 3.5	1105	10.6	9.00	8.50	A+++	371	0.9 + 0.9 + 0.9 + 1.5 + 1.5
	2.0 + 2.0 + 2.0 + 3.5 + 4.2	1105	10.6	9.00	8.50	A+++	371	0.8 + 0.8 + 0.8 + 1.5 + 1.6
	2.0 + 2.0 + 2.0 + 3.5 + 5.0	1085	10.4	9.00	8.50	A+++	371	0.8 + 0.8 + 0.8 + 1.4 + 1.8
	2.0 + 2.0 + 2.0 + 3.5 + 6.0	1085	10.4	9.00	8.50	A+++	371	0.7 + 0.7 + 0.7 + 1.3 + 2.0
	2.0 + 2.0 + 2.0 + 3.5 + 7.1	1090	10.4	9.00	8.50	A+++	371	0.7 + 0.7 + 0.7 + 1.2 + 2.3
	2.0 + 2.0 + 2.0 + 4.2 + 4.2	1075	10.3	8.99	8.50	A+++	370	0.8 + 0.8 + 0.8 + 1.6 + 1.6
	2.0 + 2.0 + 2.0 + 4.2 + 5.0	1085	10.4	9.00	8.50	A+++	371	0.7 + 0.7 + 0.7 + 1.5 + 1.7
	2.0 + 2.0 + 2.0 + 4.2 + 6.0	1085	10.4	9.00	8.50	A+++	371	0.7 + 0.7 + 0.7 + 1.5 + 1.9
	2.0 + 2.0 + 2.0 + 4.2 + 7.1	1090	10.4	9.00	8.50	A+++	371	0.7 + 0.7 + 0.7 + 1.4 + 2.2
	2.0 + 2.0 + 2.0 + 5.0 + 5.0	1130	10.8	8.99	8.50	A+++	370	0.7 + 0.7 + 0.7 + 1.6 + 1.6
	2.0 + 2.0 + 2.0 + 5.0 + 6.0	1130	10.8	9.00	8.50	A+++	371	0.7 + 0.7 + 0.7 + 1.6 + 1.8
	2.0 + 2.0 + 2.0 + 5.0 + 7.1	1135	10.9	9.00	8.50	A+++	371	0.7 + 0.7 + 0.7 + 1.5 + 2.0
	2.0 + 2.0 + 2.0 + 6.0 + 6.0	1130	10.8	9.00	8.50	A+++	371	0.7 + 0.7 + 0.7 + 1.7 + 1.7
	2.0 + 2.0 + 2.5 + 2.5 + 2.5	1100	10.5	9.00	8.50	A+++	371	1.0 + 1.0 + 1.3 + 1.3 + 1.3
	2.0 + 2.0 + 2.5 + 2.5 + 3.5	1105	10.6	9.00	8.50	A+++	371	0.9 + 0.9 + 1.2 + 1.2 + 1.5
	2.0 + 2.0 + 2.5 + 2.5 + 4.2	1105	10.6	9.00	8.50	A+++	371	0.9 + 0.9 + 1.1 + 1.1 + 1.7
	2.0 + 2.0 + 2.5 + 2.5 + 5.0	1085	10.4	9.00	8.50	A+++	371	0.8 + 0.8 + 1.0 + 1.0 + 1.8
	2.0 + 2.0 + 2.5 + 2.5 + 6.0	1085	10.4	9.00	8.50	A+++	371	0.7 + 0.7 + 1.0 + 1.0 + 2.1
	2.0 + 2.0 + 2.5 + 2.5 + 7.1	1085	10.4	9.00	8.50	A+++	371	0.7 + 0.7 + 0.9 + 0.9 + 2.3
2.0 + 2.0 + 2.5 + 3.5 + 3.5	1105	10.6	9.00	8.50	A+++	371	0.8 + 0.8 + 1.1 + 1.5 + 1.5	
2.0 + 2.0 + 2.5 + 3.5 + 4.2	1105	10.6	9.00	8.50	A+++	371	0.8 + 0.8 + 1.0 + 1.4 + 1.6	
2.0 + 2.0 + 2.5 + 3.5 + 5.0	1085	10.4	9.00	8.50	A+++	371	0.7 + 0.7 + 1.0 + 1.4 + 1.7	
2.0 + 2.0 + 2.5 + 3.5 + 6.0	1085	10.4	9.00	8.50	A+++	371	0.7 + 0.7 + 0.9 + 1.3 + 1.9	
2.0 + 2.0 + 2.5 + 3.5 + 7.1	1090	10.4	9.00	8.50	A+++	371	0.7 + 0.7 + 0.8 + 1.2 + 2.2	
2.0 + 2.0 + 2.5 + 4.2 + 4.2	1105	10.6	9.00	8.50	A+++	371	0.8 + 0.8 + 1.0 + 1.6 + 1.6	
2.0 + 2.0 + 2.5 + 4.2 + 5.0	1085	10.4	9.00	8.50	A+++	371	0.7 + 0.7 + 0.9 + 1.5 + 1.7	
2.0 + 2.0 + 2.5 + 4.2 + 6.0	1085	10.4	9.00	8.50	A+++	371	0.7 + 0.7 + 0.9 + 1.5 + 1.8	

Indoor unit capacity Cooling	Total	Cooling Capacity (kW)							Input Power (W)		EER	
		Room A	Room B	Room C	Room D	Room E	Total	min ~ max	Rating	min ~ max	WW	CLASS
2.0 + 2.0 + 2.5 + 4.2 + 7.1	17.8	1.01	1.01	1.26	2.12	3.60	9.00	2.9 ~ 11.5	2180	580 ~ 3290	4.13	A
2.0 + 2.0 + 2.5 + 5.0 + 5.0	16.5	1.09	1.09	1.36	2.73	2.73	9.00	2.9 ~ 11.5	2260	660 ~ 3230	3.98	A
2.0 + 2.0 + 2.5 + 5.0 + 6.0	17.5	1.03	1.03	1.29	2.57	3.08	9.00	2.9 ~ 11.5	2260	660 ~ 3230	3.98	A
2.0 + 2.0 + 3.5 + 3.5 + 3.5	14.5	1.24	1.24	2.17	2.17	2.17	8.99	2.9 ~ 11.5	2150	490 ~ 3340	4.18	A
2.0 + 2.0 + 3.5 + 3.5 + 4.2	15.2	1.18	1.18	2.07	2.07	2.50	9.00	2.9 ~ 11.5	2150	500 ~ 3340	4.19	A
2.0 + 2.0 + 3.5 + 3.5 + 5.0	16.0	1.13	1.13	1.97	1.97	2.80	9.00	2.9 ~ 11.5	2180	580 ~ 3290	4.13	A
2.0 + 2.0 + 3.5 + 3.5 + 6.0	17.0	1.06	1.06	1.85	1.85	3.18	9.00	2.9 ~ 11.5	2180	580 ~ 3290	4.13	A
2.0 + 2.0 + 3.5 + 3.5 + 7.1	18.1	0.99	0.99	1.74	1.74	3.54	9.00	2.9 ~ 11.5	2180	610 ~ 3290	4.13	A
2.0 + 2.0 + 3.5 + 4.2 + 4.2	15.9	1.13	1.13	1.98	2.38	2.38	9.00	2.9 ~ 11.5	2150	520 ~ 3350	4.19	A
2.0 + 2.0 + 3.5 + 4.2 + 5.0	16.7	1.08	1.08	1.89	2.26	2.69	9.00	2.9 ~ 11.5	2180	580 ~ 3290	4.13	A
2.0 + 2.0 + 3.5 + 4.2 + 6.0	17.7	1.02	1.02	1.78	2.14	3.04	9.00	2.9 ~ 11.5	2180	580 ~ 3290	4.13	A
2.0 + 2.0 + 3.5 + 5.0 + 5.0	17.5	1.03	1.03	1.80	2.57	2.57	9.00	2.9 ~ 11.5	2270	670 ~ 3240	3.96	A
2.0 + 2.0 + 4.2 + 4.2 + 4.2	16.6	1.08	1.08	2.28	2.28	2.28	9.00	2.9 ~ 11.5	2150	520 ~ 3350	4.19	A
2.0 + 2.0 + 4.2 + 4.2 + 5.0	17.4	1.03	1.03	2.17	2.17	2.60	9.00	2.9 ~ 11.5	2180	580 ~ 3290	4.13	A
2.0 + 2.0 + 4.2 + 5.0 + 5.0	18.2	0.99	0.99	2.08	2.47	2.47	9.00	2.9 ~ 11.5	2270	670 ~ 3240	3.96	A
2.0 + 2.5 + 2.5 + 2.5 + 2.5	12.0	1.48	1.88	1.88	1.88	1.88	9.00	2.9 ~ 11.5	2200	480 ~ 3490	4.09	A
2.0 + 2.5 + 2.5 + 2.5 + 3.5	13.0	1.38	1.73	1.73	1.73	2.43	9.00	2.9 ~ 11.5	2210	480 ~ 3410	4.07	A
2.0 + 2.5 + 2.5 + 2.5 + 4.2	13.7	1.31	1.64	1.64	1.64	2.77	9.00	2.9 ~ 11.5	2210	490 ~ 3410	4.07	A
2.0 + 2.5 + 2.5 + 2.5 + 5.0	14.5	1.24	1.55	1.55	1.55	3.11	9.00	2.9 ~ 11.5	2170	540 ~ 3280	4.15	A
2.0 + 2.5 + 2.5 + 2.5 + 6.0	15.5	1.16	1.45	1.45	1.45	3.49	9.00	2.9 ~ 11.5	2170	540 ~ 3280	4.15	A
2.0 + 2.5 + 2.5 + 2.5 + 7.1	16.6	1.08	1.36	1.36	1.36	3.84	9.00	2.9 ~ 11.5	2170	570 ~ 3280	4.15	A
2.0 + 2.5 + 2.5 + 3.5 + 3.5	14.0	1.28	1.61	1.61	2.25	2.25	9.00	2.9 ~ 11.5	2210	490 ~ 3420	4.07	A
2.0 + 2.5 + 2.5 + 3.5 + 4.2	14.7	1.22	1.53	1.53	2.14	2.58	9.00	2.9 ~ 11.5	2210	490 ~ 3420	4.07	A
2.0 + 2.5 + 2.5 + 3.5 + 5.0	15.5	1.16	1.45	1.45	2.03	2.91	9.00	2.9 ~ 11.5	2170	570 ~ 3280	4.15	A
2.0 + 2.5 + 2.5 + 3.5 + 6.0	16.5	1.09	1.36	1.36	1.91	3.28	9.00	2.9 ~ 11.5	2170	570 ~ 3280	4.15	A
2.0 + 2.5 + 2.5 + 3.5 + 7.1	17.6	1.02	1.28	1.28	1.79	3.63	9.00	2.9 ~ 11.5	2180	580 ~ 3290	4.13	A
2.0 + 2.5 + 2.5 + 4.2 + 4.2	15.4	1.18	1.46	1.46	2.45	2.45	9.00	2.9 ~ 11.5	2210	490 ~ 3420	4.07	A
2.0 + 2.5 + 2.5 + 4.2 + 5.0	16.2	1.11	1.39	1.39	2.33	2.78	9.00	2.9 ~ 11.5	2170	570 ~ 3280	4.15	A
2.0 + 2.5 + 2.5 + 4.2 + 6.0	17.2	1.05	1.31	1.31	2.20	3.13	9.00	2.9 ~ 11.5	2170	570 ~ 3280	4.15	A
2.0 + 2.5 + 2.5 + 4.2 + 7.1	18.3	0.98	1.23	1.23	2.07	3.49	9.00	2.9 ~ 11.5	2180	580 ~ 3290	4.13	A
2.0 + 2.5 + 2.5 + 5.0 + 5.0	17.0	1.06	1.32	1.32	2.65	2.65	9.00	2.9 ~ 11.5	2260	660 ~ 3230	3.98	A
2.0 + 2.5 + 2.5 + 5.0 + 6.0	18.0	1.00	1.25	1.25	2.50	3.00	9.00	2.9 ~ 11.5	2260	660 ~ 3230	3.98	A
2.0 + 2.5 + 3.5 + 3.5 + 3.5	15.0	1.20	1.50	2.10	2.10	2.10	9.00	2.9 ~ 11.5	2150	490 ~ 3340	4.19	A
2.0 + 2.5 + 3.5 + 3.5 + 4.2	15.7	1.15	1.43	2.01	2.01	2.40	9.00	2.9 ~ 11.5	2150	500 ~ 3340	4.19	A
2.0 + 2.5 + 3.5 + 3.5 + 5.0	16.5	1.09	1.36	1.91	1.91	2.73	9.00	2.9 ~ 11.5	2180	580 ~ 3290	4.13	A
2.0 + 2.5 + 3.5 + 3.5 + 6.0	17.5	1.03	1.29	1.80	1.80	3.08	9.00	2.9 ~ 11.5	2180	580 ~ 3290	4.13	A
2.0 + 2.5 + 3.5 + 4.2 + 4.2	16.4	1.10	1.37	1.93	2.30	2.30	9.00	2.9 ~ 11.5	2150	520 ~ 3350	4.19	A
2.0 + 2.5 + 3.5 + 4.2 + 5.0	17.2	1.05	1.31	1.83	2.20	2.61	9.00	2.9 ~ 11.5	2180	580 ~ 3290	4.13	A
2.0 + 2.5 + 3.5 + 4.2 + 6.0	18.2	0.99	1.24	1.73	2.08	2.96	9.00	2.9 ~ 11.5	2180	580 ~ 3290	4.13	A
2.0 + 2.5 + 3.5 + 5.0 + 5.0	18.0	1.00	1.25	1.75	2.50	2.50	9.00	2.9 ~ 11.5	2270	670 ~ 3240	3.96	A
2.0 + 2.5 + 4.2 + 4.2 + 4.2	17.1	1.05	1.32	2.21	2.21	2.21	9.00	2.9 ~ 11.5	2150	520 ~ 3350	4.19	A
2.0 + 2.5 + 4.2 + 4.2 + 5.0	17.9	1.01	1.26	2.11	2.11	2.51	9.00	2.9 ~ 11.5	2180	580 ~ 3290	4.13	A
2.0 + 3.5 + 3.5 + 3.5 + 3.5	16.0	1.12	1.97	1.97	1.97	1.97	9.00	2.9 ~ 11.5	2160	530 ~ 3350	4.17	A
2.0 + 3.5 + 3.5 + 3.5 + 4.2	16.7	1.08	1.89	1.89	1.89	2.25	9.00	2.9 ~ 11.5	2160	530 ~ 3350	4.17	A
2.0 + 3.5 + 3.5 + 3.5 + 5.0	17.5	1.03	1.80	1.80	1.80	2.57	9.00	2.9 ~ 11.5	2180	580 ~ 3290	4.13	A
2.0 + 3.5 + 3.5 + 4.2 + 4.2	17.4	1.04	1.81	1.81	2.17	2.17	9.00	2.9 ~ 11.5	2160	530 ~ 3350	4.17	A
2.0 + 3.5 + 3.5 + 4.2 + 5.0	18.2	0.99	1.73	1.73	2.08	2.47	9.00	2.9 ~ 11.5	2180	580 ~ 3290	4.13	A
2.0 + 3.5 + 4.2 + 4.2 + 4.2	18.1	0.99	1.74	2.09	2.09	2.09	9.00	2.9 ~ 11.5	2160	530 ~ 3350	4.17	A
2.5 + 2.5 + 2.5 + 2.5 + 2.5	12.5	1.80	1.80	1.80	1.80	1.80	9.00	2.9 ~ 11.5	2200	480 ~ 3490	4.09	A
2.5 + 2.5 + 2.5 + 2.5 + 3.5	13.5	1.67	1.67	1.67	1.67	2.32	9.00	2.9 ~ 11.5	2210	480 ~ 3410	4.07	A
2.5 + 2.5 + 2.5 + 2.5 + 4.2	14.2	1.58	1.58	1.58	1.58	2.68	9.00	2.9 ~ 11.5	2210	490 ~ 3410	4.07	A
2.5 + 2.5 + 2.5 + 2.5 + 5.0	15.0	1.50	1.50	1.50	1.50	3.00	9.00	2.9 ~ 11.5	2170	540 ~ 3280	4.15	A
2.5 + 2.5 + 2.5 + 2.5 + 6.0	16.0	1.41	1.41	1.41	1.41	3.36	9.00	2.9 ~ 11.5	2170	540 ~ 3280	4.15	A
2.5 + 2.5 + 2.5 + 2.5 + 7.1	17.1	1.32	1.32	1.32	1.32	3.72	9.00	2.9 ~ 11.5	2170	570 ~ 3280	4.15	A
2.5 + 2.5 + 2.5 + 3.5 + 3.5	14.5	1.55	1.55	1.55	2.17	2.17	8.99	2.9 ~ 11.5	2210	490 ~ 3420	4.07	A
2.5 + 2.5 + 2.5 + 3.5 + 4.2	15.2	1.48	1.48	1.48	2.07	2.49	9.00	2.9 ~ 11.5	2210	490 ~ 3420	4.07	A
2.5 + 2.5 + 2.5 + 3.5 + 5.0	16.0	1.41	1.41	1.41	1.97	2.80	9.00	2.9 ~ 11.5	2170	570 ~ 3280	4.15	A
2.5 + 2.5 + 2.5 + 3.5 + 6.0	17.0	1.32	1.32	1.32	1.85	3.19	9.00	2.9 ~ 11.5	2170	570 ~ 3280	4.15	A

5 Room

	Indoor unit capacity Cooling	Annual Energy Consumption (kWh)	Current 230V (A)	ERP			Moisture Removal Volume l/h	
				Pdesign (kW)	SEER			Annual Consumption (kWh)
					W/W	CLASS		
5 Room	2.0 + 2.0 + 2.5 + 4.2 + 7.1	1090	10.4	9.00	8.50	A+++	371	0.7 + 0.7 + 0.8 + 1.4 + 2.1
	2.0 + 2.0 + 2.5 + 5.0 + 5.0	1130	10.8	9.00	8.50	A+++	371	0.7 + 0.7 + 0.9 + 1.6 + 1.6
	2.0 + 2.0 + 2.5 + 5.0 + 6.0	1130	10.8	9.00	8.50	A+++	371	0.7 + 0.7 + 0.8 + 1.6 + 1.7
	2.0 + 2.0 + 3.5 + 3.5 + 3.5	1075	10.3	8.99	8.50	A+++	370	0.8 + 0.8 + 1.4 + 1.4 + 1.4
	2.0 + 2.0 + 3.5 + 3.5 + 4.2	1075	10.3	9.00	8.50	A+++	371	0.7 + 0.7 + 1.3 + 1.3 + 1.5
	2.0 + 2.0 + 3.5 + 3.5 + 5.0	1090	10.4	9.00	8.50	A+++	371	0.7 + 0.7 + 1.3 + 1.3 + 1.6
	2.0 + 2.0 + 3.5 + 3.5 + 6.0	1090	10.4	9.00	8.50	A+++	371	0.7 + 0.7 + 1.2 + 1.2 + 1.8
	2.0 + 2.0 + 3.5 + 3.5 + 7.1	1090	10.4	9.00	8.50	A+++	371	0.7 + 0.7 + 1.1 + 1.1 + 2.0
	2.0 + 2.0 + 3.5 + 4.2 + 4.2	1075	10.3	9.00	8.50	A+++	371	0.7 + 0.7 + 1.3 + 1.5 + 1.5
	2.0 + 2.0 + 3.5 + 4.2 + 5.0	1090	10.4	9.00	8.50	A+++	371	0.7 + 0.7 + 1.2 + 1.5 + 1.6
	2.0 + 2.0 + 3.5 + 4.2 + 6.0	1090	10.4	9.00	8.50	A+++	371	0.7 + 0.7 + 1.1 + 1.4 + 1.7
	2.0 + 2.0 + 3.5 + 5.0 + 5.0	1135	10.9	9.00	8.50	A+++	371	0.7 + 0.7 + 1.2 + 1.6 + 1.6
	2.0 + 2.0 + 4.2 + 4.2 + 4.2	1075	10.3	9.00	8.50	A+++	371	0.7 + 0.7 + 1.5 + 1.5 + 1.5
	2.0 + 2.0 + 4.2 + 4.2 + 5.0	1090	10.4	9.00	8.50	A+++	371	0.7 + 0.7 + 1.4 + 1.4 + 1.6
	2.0 + 2.0 + 4.2 + 5.0 + 5.0	1135	10.9	9.00	8.50	A+++	371	0.7 + 0.7 + 1.3 + 1.5 + 1.5
	2.0 + 2.5 + 2.5 + 2.5 + 2.5	1100	10.5	9.00	8.50	A+++	371	0.9 + 1.2 + 1.2 + 1.2 + 1.2
	2.0 + 2.5 + 2.5 + 2.5 + 3.5	1105	10.6	9.00	8.50	A+++	371	0.9 + 1.1 + 1.1 + 1.1 + 1.5
	2.0 + 2.5 + 2.5 + 2.5 + 4.2	1105	10.6	9.00	8.50	A+++	371	0.8 + 1.0 + 1.0 + 1.0 + 1.6
	2.0 + 2.5 + 2.5 + 2.5 + 5.0	1085	10.4	9.00	8.50	A+++	371	0.8 + 1.0 + 1.0 + 1.0 + 1.8
	2.0 + 2.5 + 2.5 + 2.5 + 6.0	1085	10.4	9.00	8.50	A+++	371	0.7 + 0.9 + 0.9 + 0.9 + 2.0
	2.0 + 2.5 + 2.5 + 2.5 + 7.1	1085	10.4	9.00	8.50	A+++	371	0.7 + 0.9 + 0.9 + 0.9 + 2.2
	2.0 + 2.5 + 2.5 + 3.5 + 3.5	1105	10.6	9.00	8.50	A+++	371	0.8 + 1.0 + 1.0 + 1.5 + 1.5
	2.0 + 2.5 + 2.5 + 3.5 + 4.2	1105	10.6	9.00	8.50	A+++	371	0.8 + 1.0 + 1.0 + 1.4 + 1.6
	2.0 + 2.5 + 2.5 + 3.5 + 5.0	1085	10.4	9.00	8.50	A+++	371	0.7 + 0.9 + 0.9 + 1.3 + 1.7
	2.0 + 2.5 + 2.5 + 3.5 + 6.0	1085	10.4	9.00	8.50	A+++	371	0.7 + 0.9 + 0.9 + 1.2 + 1.9
	2.0 + 2.5 + 2.5 + 3.5 + 7.1	1090	10.4	9.00	8.50	A+++	371	0.7 + 0.8 + 0.8 + 1.2 + 2.1
	2.0 + 2.5 + 2.5 + 4.2 + 4.2	1105	10.6	9.00	8.50	A+++	371	0.7 + 0.9 + 0.9 + 1.5 + 1.5
	2.0 + 2.5 + 2.5 + 4.2 + 5.0	1085	10.4	9.00	8.50	A+++	371	0.7 + 0.9 + 0.9 + 1.5 + 1.6
	2.0 + 2.5 + 2.5 + 4.2 + 6.0	1085	10.4	9.00	8.50	A+++	371	0.7 + 0.8 + 0.8 + 1.4 + 1.8
	2.0 + 2.5 + 2.5 + 4.2 + 7.1	1090	10.4	9.00	8.50	A+++	371	0.7 + 0.8 + 0.8 + 1.3 + 2.0
	2.0 + 2.5 + 2.5 + 5.0 + 5.0	1130	10.8	9.00	8.50	A+++	371	0.7 + 0.8 + 0.8 + 1.6 + 1.6
	2.0 + 2.5 + 2.5 + 5.0 + 6.0	1130	10.8	9.00	8.50	A+++	371	0.7 + 0.8 + 0.8 + 1.5 + 1.7
	2.0 + 2.5 + 3.5 + 3.5 + 3.5	1075	10.3	9.00	8.50	A+++	371	0.7 + 1.0 + 1.4 + 1.4 + 1.4
	2.0 + 2.5 + 3.5 + 3.5 + 4.2	1075	10.3	9.00	8.50	A+++	371	0.7 + 0.9 + 1.3 + 1.3 + 1.5
	2.0 + 2.5 + 3.5 + 3.5 + 5.0	1090	10.4	9.00	8.50	A+++	371	0.7 + 0.9 + 1.2 + 1.2 + 1.6
	2.0 + 2.5 + 3.5 + 3.5 + 6.0	1090	10.4	9.00	8.50	A+++	371	0.7 + 0.8 + 1.2 + 1.2 + 1.7
	2.0 + 2.5 + 3.5 + 4.2 + 4.2	1075	10.3	9.00	8.50	A+++	371	0.7 + 0.9 + 1.2 + 1.5 + 1.5
	2.0 + 2.5 + 3.5 + 4.2 + 5.0	1090	10.4	9.00	8.50	A+++	371	0.7 + 0.8 + 1.2 + 1.4 + 1.6
	2.0 + 2.5 + 3.5 + 4.2 + 6.0	1090	10.4	9.00	8.50	A+++	371	0.7 + 0.8 + 1.1 + 1.3 + 1.7
	2.0 + 2.5 + 3.5 + 5.0 + 5.0	1135	10.9	9.00	8.50	A+++	371	0.7 + 0.8 + 1.1 + 1.5 + 1.5
2.0 + 2.5 + 4.2 + 4.2 + 4.2	1075	10.3	9.00	8.50	A+++	371	0.7 + 0.8 + 1.4 + 1.4 + 1.4	
2.0 + 2.5 + 4.2 + 4.2 + 5.0	1090	10.4	9.00	8.50	A+++	371	0.7 + 0.8 + 1.4 + 1.4 + 1.5	
2.0 + 3.5 + 3.5 + 3.5 + 3.5	1080	10.3	9.00	8.50	A+++	371	0.7 + 1.3 + 1.3 + 1.3 + 1.3	
2.0 + 3.5 + 3.5 + 3.5 + 4.2	1080	10.3	9.00	8.50	A+++	371	0.7 + 1.2 + 1.2 + 1.2 + 1.5	
2.0 + 3.5 + 3.5 + 3.5 + 5.0	1090	10.4	9.00	8.50	A+++	371	0.7 + 1.2 + 1.2 + 1.2 + 1.6	
2.0 + 3.5 + 3.5 + 4.2 + 4.2	1080	10.3	9.00	8.50	A+++	371	0.7 + 1.2 + 1.2 + 1.4 + 1.4	
2.0 + 3.5 + 3.5 + 4.2 + 5.0	1090	10.4	9.00	8.50	A+++	371	0.7 + 1.1 + 1.1 + 1.3 + 1.5	
2.0 + 3.5 + 4.2 + 4.2 + 4.2	1080	10.3	9.00	8.50	A+++	371	0.7 + 1.1 + 1.4 + 1.4 + 1.4	
2.5 + 2.5 + 2.5 + 2.5 + 2.5	1100	10.5	9.00	8.50	A+++	371	1.2 + 1.2 + 1.2 + 1.2 + 1.2	
2.5 + 2.5 + 2.5 + 2.5 + 3.5	1105	10.6	9.00	8.50	A+++	371	1.1 + 1.1 + 1.1 + 1.1 + 1.5	
2.5 + 2.5 + 2.5 + 2.5 + 4.2	1105	10.6	9.00	8.50	A+++	371	1.0 + 1.0 + 1.0 + 1.0 + 1.6	
2.5 + 2.5 + 2.5 + 2.5 + 5.0	1085	10.4	9.00	8.50	A+++	371	1.0 + 1.0 + 1.0 + 1.0 + 1.7	
2.5 + 2.5 + 2.5 + 2.5 + 6.0	1085	10.4	9.00	8.50	A+++	371	0.9 + 0.9 + 0.9 + 0.9 + 1.9	
2.5 + 2.5 + 2.5 + 2.5 + 7.1	1085	10.4	9.00	8.50	A+++	371	0.8 + 0.8 + 0.8 + 0.8 + 2.2	
2.5 + 2.5 + 2.5 + 3.5 + 3.5	1105	10.6	8.99	8.50	A+++	370	1.0 + 1.0 + 1.0 + 1.4 + 1.4	
2.5 + 2.5 + 2.5 + 3.5 + 4.2	1105	10.6	9.00	8.50	A+++	371	0.9 + 0.9 + 0.9 + 1.3 + 1.5	
2.5 + 2.5 + 2.5 + 3.5 + 5.0	1085	10.4	9.00	8.50	A+++	371	0.9 + 0.9 + 0.9 + 1.3 + 1.6	
2.5 + 2.5 + 2.5 + 3.5 + 6.0	1085	10.4	9.00	8.50	A+++	371	0.8 + 0.8 + 0.8 + 1.2 + 1.8	

Indoor unit capacity Cooling		Total	Cooling Capacity (kW)							Input Power (W)		EER	
			Room A	Room B	Room C	Room D	Room E	Total	min ~ max	Rating	min ~ max	WW	CLASS
5 Room	2.5 + 2.5 + 2.5 + 3.5 + 7.1	18.1	1.24	1.24	1.24	1.74	3.54	9.00	2.9 ~ 11.5	2180	580 ~ 3290	4.13	A
	2.5 + 2.5 + 2.5 + 4.2 + 4.2	15.9	1.42	1.42	1.42	2.37	2.37	9.00	2.9 ~ 11.5	2210	490 ~ 3420	4.07	A
	2.5 + 2.5 + 2.5 + 4.2 + 5.0	16.7	1.35	1.35	1.35	2.26	2.69	9.00	2.9 ~ 11.5	2170	570 ~ 3280	4.15	A
	2.5 + 2.5 + 2.5 + 4.2 + 6.0	17.7	1.27	1.27	1.27	2.14	3.05	9.00	2.9 ~ 11.5	2170	570 ~ 3280	4.15	A
	2.5 + 2.5 + 2.5 + 5.0 + 5.0	17.5	1.29	1.29	1.29	2.56	2.56	8.99	2.9 ~ 11.5	2260	660 ~ 3230	3.98	A
	2.5 + 2.5 + 3.5 + 3.5 + 3.5	15.5	1.45	1.45	2.03	2.03	2.03	8.99	2.9 ~ 11.5	2150	490 ~ 3340	4.18	A
	2.5 + 2.5 + 3.5 + 3.5 + 4.2	16.2	1.39	1.39	1.94	1.94	2.34	9.00	2.9 ~ 11.5	2150	500 ~ 3340	4.19	A
	2.5 + 2.5 + 3.5 + 3.5 + 5.0	17.0	1.32	1.32	1.85	1.85	2.66	9.00	2.9 ~ 11.5	2180	580 ~ 3290	4.13	A
	2.5 + 2.5 + 3.5 + 3.5 + 6.0	18.0	1.25	1.25	1.75	1.75	3.00	9.00	2.9 ~ 11.5	2180	580 ~ 3290	4.13	A
	2.5 + 2.5 + 3.5 + 4.2 + 4.2	16.9	1.33	1.33	1.86	2.24	2.24	9.00	2.9 ~ 11.5	2150	520 ~ 3350	4.19	A
	2.5 + 2.5 + 3.5 + 4.2 + 5.0	17.7	1.27	1.27	1.78	2.14	2.54	9.00	2.9 ~ 11.5	2180	580 ~ 3290	4.13	A
	2.5 + 2.5 + 4.2 + 4.2 + 4.2	17.6	1.27	1.27	2.15	2.15	2.15	8.99	2.9 ~ 11.5	2150	520 ~ 3350	4.18	A
	2.5 + 3.5 + 3.5 + 3.5 + 3.5	16.5	1.36	1.91	1.91	1.91	1.91	9.00	2.9 ~ 11.5	2160	530 ~ 3350	4.17	A
	2.5 + 3.5 + 3.5 + 3.5 + 4.2	17.2	1.31	1.83	1.83	1.83	2.20	9.00	2.9 ~ 11.5	2160	530 ~ 3350	4.17	A
	2.5 + 3.5 + 3.5 + 3.5 + 5.0	18.0	1.25	1.75	1.75	1.75	2.50	9.00	2.9 ~ 11.5	2180	580 ~ 3290	4.13	A
	2.5 + 3.5 + 3.5 + 4.2 + 4.2	17.9	1.26	1.76	1.76	2.11	2.11	9.00	2.9 ~ 11.5	2160	530 ~ 3350	4.17	A
	3.5 + 3.5 + 3.5 + 3.5 + 3.5	17.5	1.80	1.80	1.80	1.80	1.80	9.00	2.9 ~ 11.5	2160	530 ~ 3350	4.17	A
3.5 + 3.5 + 3.5 + 3.5 + 4.2	18.2	1.73	1.73	1.73	1.73	2.08	9.00	2.9 ~ 11.5	2160	530 ~ 3350	4.17	A	

	Indoor unit capacity Cooling	Annual Energy Consumption (kWh)	Current 230V (A)	ERP				Moisture Removal Volume l/h
				Pdesign (kW)	SEER		Annual Consumption (kWh)	
					W/W	CLASS		
5 Room	2.5 + 2.5 + 2.5 + 3.5 + 7.1	1090	10.4	9.00	8.50	A+++	371	0.8 + 0.8 + 0.8 + 1.1 + 2.0
	2.5 + 2.5 + 2.5 + 4.2 + 4.2	1105	10.6	9.00	8.50	A+++	371	0.9 + 0.9 + 0.9 + 1.5 + 1.5
	2.5 + 2.5 + 2.5 + 4.2 + 5.0	1085	10.4	9.00	8.50	A+++	371	0.9 + 0.9 + 0.9 + 1.5 + 1.6
	2.5 + 2.5 + 2.5 + 4.2 + 6.0	1085	10.4	9.00	8.50	A+++	371	0.8 + 0.8 + 0.8 + 1.4 + 1.7
	2.5 + 2.5 + 2.5 + 5.0 + 5.0	1130	10.8	8.99	8.50	A+++	370	0.8 + 0.8 + 0.8 + 1.6 + 1.6
	2.5 + 2.5 + 3.5 + 3.5 + 3.5	1075	10.3	8.99	8.50	A+++	370	0.9 + 0.9 + 1.3 + 1.3 + 1.3
	2.5 + 2.5 + 3.5 + 3.5 + 4.2	1075	10.3	9.00	8.50	A+++	371	0.9 + 0.9 + 1.3 + 1.3 + 1.5
	2.5 + 2.5 + 3.5 + 3.5 + 5.0	1090	10.4	9.00	8.50	A+++	371	0.8 + 0.8 + 1.2 + 1.2 + 1.6
	2.5 + 2.5 + 3.5 + 3.5 + 6.0	1090	10.4	9.00	8.50	A+++	371	0.8 + 0.8 + 1.1 + 1.1 + 1.7
	2.5 + 2.5 + 3.5 + 4.2 + 4.2	1075	10.3	9.00	8.50	A+++	371	0.8 + 0.8 + 1.2 + 1.5 + 1.5
	2.5 + 2.5 + 3.5 + 4.2 + 5.0	1090	10.4	9.00	8.50	A+++	371	0.8 + 0.8 + 1.1 + 1.4 + 1.6
	2.5 + 2.5 + 4.2 + 4.2 + 4.2	1075	10.3	8.99	8.50	A+++	370	0.8 + 0.8 + 1.4 + 1.4 + 1.4
	2.5 + 3.5 + 3.5 + 3.5 + 3.5	1080	10.3	9.00	8.50	A+++	371	0.9 + 1.2 + 1.2 + 1.2 + 1.2
	2.5 + 3.5 + 3.5 + 3.5 + 4.2	1080	10.3	9.00	8.50	A+++	371	0.8 + 1.2 + 1.2 + 1.2 + 1.4
	2.5 + 3.5 + 3.5 + 3.5 + 5.0	1090	10.4	9.00	8.50	A+++	371	0.8 + 1.1 + 1.1 + 1.1 + 1.5
	2.5 + 3.5 + 3.5 + 4.2 + 4.2	1080	10.3	9.00	8.50	A+++	371	0.8 + 1.1 + 1.1 + 1.4 + 1.4
3.5 + 3.5 + 3.5 + 3.5 + 3.5	1080	10.3	9.00	8.50	A+++	371	1.2 + 1.2 + 1.2 + 1.2 + 1.2	
3.5 + 3.5 + 3.5 + 3.5 + 4.2	1080	10.3	9.00	8.50	A+++	371	1.1 + 1.1 + 1.1 + 1.1 + 1.3	

- Indoor Unit : CS-MZ / Z / XZ wall mount series
- Outdoor Unit : CU-5Z90TBE

Indoor unit capacity Heating	Total	Heating Capacity (kW)							Input Power (W)		COP		
		Room A	Room B	Room C	Room D	Room E	Total	min ~ max	Rating	min ~ max	W/W	CLASS	
1 Room	1.6	1.6	2.60					2.60	1.2 ~ 3.2	600	300 ~ 960	4.33	A
	2.0	2.0	3.20					3.20	1.2 ~ 4.1	740	300 ~ 1230	4.32	A
	2.5	2.5	3.60					3.60	1.2 ~ 4.3	940	300 ~ 1230	3.83	A
	3.5	3.5	4.50					4.50	1.2 ~ 5.8	1230	300 ~ 2100	3.66	A
	4.2	4.2	5.60					5.60	1.2 ~ 6.8	1720	300 ~ 2930	3.26	C
	5.0	5.0	6.80					6.80	1.2 ~ 6.9	2100	300 ~ 2520	3.24	C
	6.0	6.0	8.50					8.50	1.3 ~ 9.0	2400	620 ~ 2550	3.54	B
	7.1	7.1	8.70					8.70	1.4 ~ 9.2	2550	680 ~ 2720	3.41	B
2 Room	1.6 + 1.6	3.2	2.35	2.35				4.70	2.0 ~ 8.2	1210	220 ~ 2410	3.88	A
	1.6 + 2.0	3.6	2.31	2.89				5.20	2.0 ~ 8.2	1370	220 ~ 2400	3.80	A
	1.6 + 2.5	4.1	2.19	3.41				5.60	2.0 ~ 8.2	1500	220 ~ 2400	3.73	A
	1.6 + 3.5	5.1	2.01	4.39				6.40	2.0 ~ 8.6	1690	210 ~ 2480	3.79	A
	1.6 + 4.2	5.8	2.04	5.36				7.40	2.0 ~ 10.1	1990	210 ~ 3030	3.72	A
	1.6 + 5.0	6.6	2.06	6.44				8.50	2.0 ~ 11.0	2200	160 ~ 3040	3.86	A
	1.6 + 6.0	7.6	2.11	7.89				10.00	2.0 ~ 11.0	2670	160 ~ 3040	3.75	A
	1.6 + 7.1	8.7	1.88	8.32				10.20	2.0 ~ 13.0	2670	160 ~ 3830	3.82	A
	2.0 + 2.0	4.0	2.90	2.90				5.80	2.0 ~ 8.2	1530	220 ~ 2390	3.79	A
	2.0 + 2.5	4.5	2.71	3.39				6.10	2.0 ~ 8.2	1620	220 ~ 2390	3.77	A
	2.0 + 3.5	5.5	2.51	4.39				6.90	2.0 ~ 8.6	1810	210 ~ 2420	3.81	A
	2.0 + 4.2	6.2	2.55	5.35				7.90	2.0 ~ 11.0	2160	200 ~ 3230	3.66	A
	2.0 + 5.0	7.0	2.57	6.43				9.00	2.0 ~ 11.0	2260	160 ~ 2980	3.98	A
	2.0 + 6.0	8.0	2.60	7.80				10.40	2.0 ~ 11.9	2680	160 ~ 3330	3.88	A
	2.0 + 7.1	9.1	2.29	8.11				10.40	2.0 ~ 13.0	2620	160 ~ 3820	3.97	A
	2.5 + 2.5	5.0	3.25	3.25				6.50	2.0 ~ 8.6	1700	220 ~ 2500	3.82	A
	2.5 + 3.5	6.0	3.04	4.26				7.30	2.0 ~ 10.1	1940	210 ~ 3030	3.76	A
	2.5 + 4.2	6.7	3.10	5.20				8.30	2.0 ~ 11.0	2300	200 ~ 3230	3.61	A
	2.5 + 5.0	7.5	3.13	6.27				9.40	2.0 ~ 11.0	2450	160 ~ 2980	3.84	A
	2.5 + 6.0	8.5	3.06	7.34				10.40	2.0 ~ 13.0	2680	160 ~ 3830	3.88	A
	2.5 + 7.1	9.6	2.71	7.69				10.40	2.0 ~ 13.0	2620	160 ~ 3820	3.97	A
	3.5 + 3.5	7.0	4.05	4.05				8.10	2.0 ~ 11.0	2190	200 ~ 3220	3.70	A
	3.5 + 4.2	7.7	4.14	4.96				9.10	2.0 ~ 11.0	2490	200 ~ 3160	3.65	A
	3.5 + 5.0	8.5	4.20	6.00				10.20	2.0 ~ 13.0	2590	160 ~ 3810	3.94	A
	3.5 + 6.0	9.5	3.83	6.57				10.40	2.0 ~ 13.0	2610	160 ~ 3810	3.98	A
	3.5 + 7.1	10.6	3.43	6.97				10.40	2.0 ~ 13.8	2590	160 ~ 4140	4.02	A
	4.2 + 4.2	8.4	5.05	5.05				10.10	2.0 ~ 13.0	2790	190 ~ 3990	3.62	A
4.2 + 5.0	9.2	4.75	5.65				10.40	2.0 ~ 13.0	2600	160 ~ 3740	4.00	A	
4.2 + 6.0	10.2	4.28	6.12				10.40	2.0 ~ 13.8	2600	160 ~ 4150	4.00	A	
4.2 + 7.1	11.3	3.87	6.53				10.40	2.0 ~ 13.8	2580	160 ~ 4130	4.03	A	
5.0 + 5.0	10.0	5.20	5.20				10.40	2.0 ~ 13.8	2430	170 ~ 3900	4.28	A	
5.0 + 6.0	11.0	4.73	5.67				10.40	2.0 ~ 13.8	2430	170 ~ 3900	4.28	A	
5.0 + 7.1	12.1	4.30	6.10				10.40	2.0 ~ 13.8	2410	170 ~ 3890	4.32	A	
6.0 + 6.0	12.0	5.20	5.20				10.40	2.0 ~ 13.8	2430	170 ~ 3900	4.28	A	
6.0 + 7.1	13.1	4.76	5.64				10.40	2.0 ~ 13.8	2410	170 ~ 3890	4.32	A	
7.1 + 7.1	14.2	5.20	5.20				10.40	2.0 ~ 13.8	2350	180 ~ 3870	4.43	A	



	Indoor unit capacity Heating	Annual Energy Consumption (kWh)	Current 230V (A)	ERP				Moisture Removal Volume l/h
				Pdesign (kW)	SCOP		Annual Consumption (kWh)	
					W/W	CLASS		
1 Room	1.6	300	3.0	-	-	-	-	
	2.0	370	3.7	-	-	-	-	
	2.5	470	4.7	-	-	-	-	
	3.5	615	6.0	-	-	-	-	
	4.2	860	8.0	-	-	-	-	
	5.0	1050	9.7	-	-	-	-	
	6.0	1200	11.1	-	-	-	-	
	7.1	1275	11.8	-	-	-	-	
2 Room	1.6 + 1.6	605	5.8	4.50	3.80	A	1658	
	1.6 + 2.0	685	6.5	4.50	3.80	A	1658	
	1.6 + 2.5	750	7.1	4.50	3.80	A	1658	
	1.6 + 3.5	845	8.0	5.50	3.80	A	2026	
	1.6 + 4.2	995	9.4	5.50	3.80	A	2026	
	1.6 + 5.0	1100	10.3	6.50	4.00	A+	2275	
	1.6 + 6.0	1335	12.5	6.50	4.00	A+	2275	
	1.6 + 7.1	1335	12.5	6.50	4.00	A+	2275	
	2.0 + 2.0	765	7.3	4.50	3.80	A	1658	
	2.0 + 2.5	810	7.7	4.50	3.80	A	1658	
	2.0 + 3.5	905	8.5	5.50	3.80	A	2026	
	2.0 + 4.2	1080	10.2	5.50	3.80	A	2026	
	2.0 + 5.0	1130	10.6	6.50	4.00	A+	2275	
	2.0 + 6.0	1340	12.6	6.50	4.00	A+	2275	
	2.0 + 7.1	1310	12.3	6.50	4.00	A+	2275	
	2.5 + 2.5	850	8.1	4.50	3.80	A	1658	
	2.5 + 3.5	970	9.1	5.50	3.80	A	2026	
	2.5 + 4.2	1150	10.8	5.50	3.80	A	2026	
	2.5 + 5.0	1225	11.5	6.50	4.00	A+	2275	
	2.5 + 6.0	1340	12.6	6.50	4.00	A+	2275	
	2.5 + 7.1	1310	12.3	6.50	4.00	A+	2275	
	3.5 + 3.5	1095	10.3	5.50	3.80	A	2026	
	3.5 + 4.2	1245	11.7	5.50	3.80	A	2026	
	3.5 + 5.0	1295	12.2	6.50	4.00	A+	2275	
	3.5 + 6.0	1305	12.3	6.50	4.00	A+	2275	
	3.5 + 7.1	1295	12.2	6.50	4.00	A+	2275	
	4.2 + 4.2	1395	13.1	5.50	3.80	A	2026	
4.2 + 5.0	1300	12.2	6.50	4.00	A+	2275		
4.2 + 6.0	1300	12.2	6.50	4.00	A+	2275		
4.2 + 7.1	1290	12.1	6.50	4.00	A+	2275		
5.0 + 5.0	1215	11.4	8.50	4.00	A+	2975		
5.0 + 6.0	1215	11.4	8.50	4.00	A+	2975		
5.0 + 7.1	1205	11.3	8.50	4.00	A+	2975		
6.0 + 6.0	1215	11.4	8.50	4.00	A+	2975		
6.0 + 7.1	1205	11.3	8.50	4.00	A+	2975		
7.1 + 7.1	1175	11.0	8.50	4.00	A+	2975		

	Indoor unit capacity Heating	Total	Heating Capacity (kW)						Input Power (W)		COP		
			Room A	Room B	Room C	Room D	Room E	Total	min ~ max	Rating	min ~ max	WW	CLASS
3 Room	1.6 + 1.6 + 1.6	4.8	2.33	2.33	2.33			6.99	2.7 ~ 12.3	1540	230 ~ 3380	4.54	A
	1.6 + 1.6 + 2.0	5.2	2.34	2.34	2.92			7.60	2.7 ~ 12.3	1740	230 ~ 3370	4.37	A
	1.6 + 1.6 + 2.5	5.7	2.22	2.22	3.46			7.90	2.7 ~ 12.3	1830	230 ~ 3370	4.32	A
	1.6 + 1.6 + 3.5	6.7	2.08	2.08	4.54			8.70	2.7 ~ 12.3	2020	230 ~ 3280	4.31	A
	1.6 + 1.6 + 4.2	7.4	2.10	2.10	5.50			9.70	2.7 ~ 12.3	2390	230 ~ 3270	4.06	A
	1.6 + 1.6 + 5.0	8.2	2.03	2.03	6.34			10.40	2.7 ~ 12.9	2310	250 ~ 3360	4.50	A
	1.6 + 1.6 + 6.0	9.2	1.81	1.81	6.78			10.40	2.7 ~ 13.6	2310	250 ~ 3700	4.50	A
	1.6 + 1.6 + 7.1	10.3	1.62	1.62	7.16			10.40	2.7 ~ 13.6	2300	250 ~ 3620	4.52	A
	1.6 + 2.0 + 2.0	5.6	2.32	2.89	2.89			8.10	2.7 ~ 12.3	1870	230 ~ 3360	4.33	A
	1.6 + 2.0 + 2.5	6.1	2.23	2.79	3.48			8.50	2.7 ~ 12.3	2050	230 ~ 3360	4.15	A
	1.6 + 2.0 + 3.5	7.1	2.10	2.62	4.58			9.30	2.7 ~ 12.3	2200	230 ~ 3270	4.23	A
	1.6 + 2.0 + 4.2	7.8	2.11	2.64	5.55			10.30	2.7 ~ 12.9	2420	230 ~ 3540	4.26	A
	1.6 + 2.0 + 5.0	8.6	1.93	2.42	6.05			10.40	2.7 ~ 13.6	2300	250 ~ 3630	4.52	A
	1.6 + 2.0 + 6.0	9.6	1.73	2.17	6.50			10.40	2.7 ~ 13.6	2300	250 ~ 3630	4.52	A
	1.6 + 2.0 + 7.1	10.7	1.56	1.94	6.90			10.40	2.7 ~ 13.8	2290	250 ~ 3730	4.54	A
	1.6 + 2.5 + 2.5	6.6	2.14	3.33	3.33			8.80	2.7 ~ 12.3	2080	230 ~ 3360	4.23	A
	1.6 + 2.5 + 3.5	7.6	2.02	3.16	4.42			9.60	2.7 ~ 12.3	2340	230 ~ 3270	4.10	A
	1.6 + 2.5 + 4.2	8.3	2.00	3.13	5.27			10.40	2.7 ~ 12.9	2460	230 ~ 3540	4.23	A
	1.6 + 2.5 + 5.0	9.1	1.83	2.86	5.71			10.40	2.7 ~ 13.6	2300	250 ~ 3630	4.52	A
	1.6 + 2.5 + 6.0	10.1	1.65	2.57	6.18			10.40	2.7 ~ 13.6	2300	250 ~ 3630	4.52	A
	1.6 + 2.5 + 7.1	11.2	1.49	2.32	6.59			10.40	2.7 ~ 13.8	2290	250 ~ 3730	4.54	A
	1.6 + 3.5 + 3.5	8.6	1.94	4.23	4.23			10.40	2.7 ~ 13.6	2450	230 ~ 3860	4.24	A
	1.6 + 3.5 + 4.2	9.3	1.79	3.91	4.70			10.40	2.7 ~ 13.6	2430	240 ~ 3850	4.28	A
	1.6 + 3.5 + 5.0	10.1	1.65	3.60	5.15			10.40	2.7 ~ 13.6	2270	250 ~ 3590	4.58	A
	1.6 + 3.5 + 6.0	11.1	1.50	3.28	5.62			10.40	2.7 ~ 13.8	2270	250 ~ 3710	4.58	A
	1.6 + 3.5 + 7.1	12.2	1.36	2.98	6.06			10.40	2.7 ~ 13.8	2260	270 ~ 3690	4.60	A
	1.6 + 4.2 + 4.2	10.0	1.66	4.37	4.37			10.40	2.7 ~ 13.6	2420	240 ~ 3780	4.30	A
	1.6 + 4.2 + 5.0	10.8	1.54	4.04	4.82			10.40	2.7 ~ 13.8	2260	270 ~ 3700	4.60	A
	1.6 + 4.2 + 6.0	11.8	1.41	3.70	5.29			10.40	2.7 ~ 13.8	2260	270 ~ 3700	4.60	A
	1.6 + 4.2 + 7.1	12.9	1.29	3.39	5.72			10.40	2.7 ~ 14.1	2250	270 ~ 3800	4.62	A
	1.6 + 5.0 + 5.0	11.6	1.44	4.48	4.48			10.40	2.7 ~ 13.8	2170	300 ~ 3500	4.79	A
	1.6 + 5.0 + 6.0	12.6	1.32	4.13	4.95			10.40	2.7 ~ 13.8	2170	300 ~ 3500	4.79	A
	1.6 + 5.0 + 7.1	13.7	1.21	3.80	5.39			10.40	2.7 ~ 14.1	2160	310 ~ 3650	4.81	A
	1.6 + 6.0 + 6.0	13.6	1.22	4.59	4.59			10.40	2.7 ~ 14.1	2170	300 ~ 3670	4.79	A
	1.6 + 6.0 + 7.1	14.7	1.13	4.24	5.03			10.40	2.7 ~ 14.1	2160	310 ~ 3650	4.81	A
	1.6 + 7.1 + 7.1	15.8	1.06	4.67	4.67			10.40	2.7 ~ 14.4	2190	320 ~ 3750	4.75	A
	2.0 + 2.0 + 2.0	6.0	2.86	2.86	2.86			8.58	2.7 ~ 12.3	1980	230 ~ 3350	4.33	A
	2.0 + 2.0 + 2.5	6.5	2.77	2.77	3.46			9.00	2.7 ~ 12.3	2120	230 ~ 3350	4.25	A
	2.0 + 2.0 + 3.5	7.5	2.61	2.61	4.58			9.80	2.7 ~ 12.3	2380	230 ~ 3260	4.12	A
	2.0 + 2.0 + 4.2	8.2	2.54	2.54	5.32			10.40	2.7 ~ 12.9	2450	230 ~ 3530	4.24	A
	2.0 + 2.0 + 5.0	9.0	2.31	2.31	5.78			10.40	2.7 ~ 13.6	2290	250 ~ 3620	4.54	A
	2.0 + 2.0 + 6.0	10.0	2.08	2.08	6.24			10.40	2.7 ~ 13.6	2290	250 ~ 3620	4.54	A
2.0 + 2.0 + 7.1	11.1	1.87	1.87	6.66			10.40	2.7 ~ 13.8	2280	250 ~ 3710	4.56	A	
2.0 + 2.5 + 2.5	7.0	2.68	3.36	3.36			9.40	2.7 ~ 12.3	2260	230 ~ 3350	4.16	A	
2.0 + 2.5 + 3.5	8.0	2.55	3.19	4.46			10.20	2.7 ~ 12.9	2450	230 ~ 3540	4.16	A	
2.0 + 2.5 + 4.2	8.7	2.39	2.99	5.02			10.40	2.7 ~ 13.6	2450	230 ~ 3870	4.24	A	
2.0 + 2.5 + 5.0	9.5	2.19	2.74	5.47			10.40	2.7 ~ 13.6	2290	250 ~ 3620	4.54	A	
2.0 + 2.5 + 6.0	10.5	1.98	2.48	5.94			10.40	2.7 ~ 13.8	2290	250 ~ 3730	4.54	A	
2.0 + 2.5 + 7.1	11.6	1.79	2.24	6.37			10.40	2.7 ~ 13.8	2280	250 ~ 3710	4.56	A	
2.0 + 3.5 + 3.5	9.0	2.32	4.04	4.04			10.40	2.7 ~ 13.6	2430	240 ~ 3850	4.28	A	
2.0 + 3.5 + 4.2	9.7	2.14	3.75	4.51			10.40	2.7 ~ 13.6	2420	240 ~ 3780	4.30	A	
2.0 + 3.5 + 5.0	10.5	1.98	3.47	4.95			10.40	2.7 ~ 13.8	2260	270 ~ 3700	4.60	A	
2.0 + 3.5 + 6.0	11.5	1.81	3.17	5.42			10.40	2.7 ~ 13.8	2260	270 ~ 3700	4.60	A	
2.0 + 3.5 + 7.1	12.6	1.65	2.89	5.86			10.40	2.7 ~ 13.8	2250	270 ~ 3680	4.62	A	
2.0 + 4.2 + 4.2	10.4	2.00	4.20	4.20			10.40	2.7 ~ 13.6	2410	240 ~ 3770	4.32	A	
2.0 + 4.2 + 5.0	11.2	1.86	3.90	4.64			10.40	2.7 ~ 13.8	2260	270 ~ 3680	4.60	A	
2.0 + 4.2 + 6.0	12.2	1.70	3.58	5.12			10.40	2.7 ~ 13.8	2260	270 ~ 3680	4.60	A	
2.0 + 4.2 + 7.1	13.3	1.56	3.28	5.56			10.40	2.7 ~ 14.1	2240	270 ~ 3780	4.64	A	

	Indoor unit capacity Heating	Annual Energy Consumption (kWh)	Current 230V (A)	ERP				Moisture Removal Volume l/h
				Pdesign (kW)	SCOP		Annual Consumption (kWh)	
					WW	CLASS		
3 Room	1.6 + 1.6 + 1.6	770	7.3	6.50	4.00	A+	2275	
	1.6 + 1.6 + 2.0	870	8.3	6.50	4.00	A+	2275	
	1.6 + 1.6 + 2.5	915	8.6	6.50	4.00	A+	2275	
	1.6 + 1.6 + 3.5	1010	9.5	7.50	4.10	A+	2561	
	1.6 + 1.6 + 4.2	1195	11.2	7.50	4.10	A+	2561	
	1.6 + 1.6 + 5.0	1155	10.9	7.50	4.10	A+	2561	
	1.6 + 1.6 + 6.0	1155	10.9	8.50	4.20	A+	2833	
	1.6 + 1.6 + 7.1	1150	10.8	8.50	4.20	A+	2833	
	1.6 + 2.0 + 2.0	935	8.8	6.50	4.00	A+	2275	
	1.6 + 2.0 + 2.5	1025	9.6	7.50	4.10	A+	2561	
	1.6 + 2.0 + 3.5	1100	10.3	7.50	4.10	A+	2561	
	1.6 + 2.0 + 4.2	1210	11.4	7.50	4.10	A+	2561	
	1.6 + 2.0 + 5.0	1150	10.8	8.50	4.20	A+	2833	
	1.6 + 2.0 + 6.0	1150	10.8	8.50	4.20	A+	2833	
	1.6 + 2.0 + 7.1	1145	10.8	8.50	4.20	A+	2833	
	1.6 + 2.5 + 2.5	1040	9.8	7.50	4.10	A+	2561	
	1.6 + 2.5 + 3.5	1170	11.0	7.50	4.10	A+	2561	
	1.6 + 2.5 + 4.2	1230	11.6	7.50	4.10	A+	2561	
	1.6 + 2.5 + 5.0	1150	10.8	8.50	4.20	A+	2833	
	1.6 + 2.5 + 6.0	1150	10.8	8.50	4.20	A+	2833	
	1.6 + 2.5 + 7.1	1145	10.8	8.50	4.20	A+	2833	
	1.6 + 3.5 + 3.5	1225	11.5	8.50	4.20	A+	2833	
	1.6 + 3.5 + 4.2	1215	11.4	8.50	4.20	A+	2833	
	1.6 + 3.5 + 5.0	1135	10.7	8.50	4.20	A+	2833	
	1.6 + 3.5 + 6.0	1135	10.7	8.50	4.20	A+	2833	
	1.6 + 3.5 + 7.1	1130	10.6	8.50	4.20	A+	2833	
	1.6 + 4.2 + 4.2	1210	11.4	8.50	4.20	A+	2833	
	1.6 + 4.2 + 5.0	1130	10.6	8.50	4.20	A+	2833	
	1.6 + 4.2 + 6.0	1130	10.6	8.50	4.20	A+	2833	
	1.6 + 4.2 + 7.1	1125	10.6	8.50	4.20	A+	2833	
	1.6 + 5.0 + 5.0	1085	10.2	8.50	4.20	A+	2833	
	1.6 + 5.0 + 6.0	1085	10.2	8.50	4.20	A+	2833	
	1.6 + 5.0 + 7.1	1080	10.2	8.50	4.20	A+	2833	
	1.6 + 6.0 + 6.0	1085	10.2	8.50	4.20	A+	2833	
	1.6 + 6.0 + 7.1	1080	10.2	8.50	4.20	A+	2833	
	1.6 + 7.1 + 7.1	1095	10.3	8.50	4.20	A+	2833	
	2.0 + 2.0 + 2.0	990	9.3	7.50	4.10	A+	2561	
	2.0 + 2.0 + 2.5	1060	10.0	7.50	4.10	A+	2561	
	2.0 + 2.0 + 3.5	1190	11.2	7.50	4.10	A+	2561	
	2.0 + 2.0 + 4.2	1225	11.5	7.50	4.10	A+	2561	
2.0 + 2.0 + 5.0	1145	10.8	8.50	4.20	A+	2833		
2.0 + 2.0 + 6.0	1145	10.8	8.50	4.20	A+	2833		
2.0 + 2.0 + 7.1	1140	10.7	8.50	4.20	A+	2833		
2.0 + 2.5 + 2.5	1130	10.6	7.50	4.10	A+	2561		
2.0 + 2.5 + 3.5	1225	11.5	7.50	4.10	A+	2561		
2.0 + 2.5 + 4.2	1225	11.5	8.50	4.20	A+	2833		
2.0 + 2.5 + 5.0	1145	10.8	8.50	4.20	A+	2833		
2.0 + 2.5 + 6.0	1145	10.8	8.50	4.20	A+	2833		
2.0 + 2.5 + 7.1	1140	10.7	8.50	4.20	A+	2833		
2.0 + 3.5 + 3.5	1215	11.4	8.50	4.20	A+	2833		
2.0 + 3.5 + 4.2	1210	11.4	8.50	4.20	A+	2833		
2.0 + 3.5 + 5.0	1130	10.6	8.50	4.20	A+	2833		
2.0 + 3.5 + 6.0	1130	10.6	8.50	4.20	A+	2833		
2.0 + 3.5 + 7.1	1125	10.6	8.50	4.20	A+	2833		
2.0 + 4.2 + 4.2	1205	11.3	8.50	4.20	A+	2833		
2.0 + 4.2 + 5.0	1130	10.6	8.50	4.20	A+	2833		
2.0 + 4.2 + 6.0	1130	10.6	8.50	4.20	A+	2833		
2.0 + 4.2 + 7.1	1120	10.5	8.50	4.20	A+	2833		

Indoor unit capacity Heating	Total	Heating Capacity (kW)							Input Power (W)		COP	
		Room A	Room B	Room C	Room D	Room E	Total	min ~ max	Rating	min ~ max	WW	CLASS
2.0 + 5.0 + 5.0	12.0	1.74	4.33	4.33			10.40	2.7 ~ 13.8	2160	310 ~ 3480	4.81	A
2.0 + 5.0 + 6.0	13.0	1.60	4.00	4.80			10.40	2.7 ~ 14.1	2160	310 ~ 3650	4.81	A
2.0 + 5.0 + 7.1	14.1	1.48	3.69	5.23			10.40	2.7 ~ 14.1	2190	320 ~ 3640	4.75	A
2.0 + 6.0 + 6.0	14.0	1.48	4.46	4.46			10.40	2.7 ~ 14.1	2160	310 ~ 3650	4.81	A
2.0 + 6.0 + 7.1	15.1	1.38	4.13	4.89			10.40	2.7 ~ 14.4	2190	320 ~ 3750	4.75	A
2.0 + 7.1 + 7.1	16.2	1.28	4.56	4.56			10.40	2.7 ~ 14.4	2180	330 ~ 3740	4.77	A
2.5 + 2.5 + 2.5	7.5	3.23	3.23	3.23			9.69	2.7 ~ 12.3	2410	230 ~ 3350	4.02	A
2.5 + 2.5 + 3.5	8.5	3.06	3.06	4.28			10.40	2.7 ~ 13.6	2460	230 ~ 3890	4.23	A
2.5 + 2.5 + 4.2	9.2	2.83	2.83	4.74			10.40	2.7 ~ 13.6	2450	230 ~ 3870	4.24	A
2.5 + 2.5 + 5.0	10.0	2.60	2.60	5.20			10.40	2.7 ~ 13.6	2290	250 ~ 3620	4.54	A
2.5 + 2.5 + 6.0	11.0	2.36	2.36	5.68			10.40	2.7 ~ 13.8	2290	250 ~ 3730	4.54	A
2.5 + 2.5 + 7.1	12.1	2.15	2.15	6.10			10.40	2.7 ~ 13.8	2280	250 ~ 3710	4.56	A
2.5 + 3.5 + 3.5	9.5	2.74	3.83	3.83			10.40	2.7 ~ 13.6	2430	240 ~ 3850	4.28	A
2.5 + 3.5 + 4.2	10.2	2.55	3.57	4.28			10.40	2.7 ~ 13.6	2420	240 ~ 3780	4.30	A
2.5 + 3.5 + 5.0	11.0	2.36	3.31	4.73			10.40	2.7 ~ 13.8	2260	270 ~ 3700	4.60	A
2.5 + 3.5 + 6.0	12.0	2.17	3.03	5.20			10.40	2.7 ~ 13.8	2260	270 ~ 3700	4.60	A
2.5 + 3.5 + 7.1	13.1	1.98	2.78	5.64			10.40	2.7 ~ 14.1	2250	270 ~ 3800	4.62	A
2.5 + 4.2 + 4.2	10.9	2.38	4.01	4.01			10.40	2.7 ~ 13.8	2410	240 ~ 3890	4.32	A
2.5 + 4.2 + 5.0	11.7	2.22	3.73	4.45			10.40	2.7 ~ 13.8	2260	270 ~ 3680	4.60	A
2.5 + 4.2 + 6.0	12.7	2.05	3.44	4.91			10.40	2.7 ~ 14.1	2260	270 ~ 3800	4.60	A
2.5 + 4.2 + 7.1	13.8	1.88	3.17	5.35			10.40	2.7 ~ 14.1	2240	270 ~ 3780	4.64	A
2.5 + 5.0 + 5.0	12.5	2.08	4.16	4.16			10.40	2.7 ~ 13.8	2160	310 ~ 3480	4.81	A
2.5 + 5.0 + 6.0	13.5	1.93	3.85	4.62			10.40	2.7 ~ 14.1	2160	310 ~ 3650	4.81	A
2.5 + 5.0 + 7.1	14.6	1.78	3.56	5.06			10.40	2.7 ~ 14.1	2190	320 ~ 3640	4.75	A
2.5 + 6.0 + 6.0	14.5	1.80	4.30	4.30			10.40	2.7 ~ 14.1	2160	310 ~ 3650	4.81	A
2.5 + 6.0 + 7.1	15.6	1.67	4.00	4.73			10.40	2.7 ~ 14.4	2190	320 ~ 3750	4.75	A
2.5 + 7.1 + 7.1	16.7	1.56	4.42	4.42			10.40	2.7 ~ 14.4	2180	330 ~ 3740	4.77	A
3.5 + 3.5 + 3.5	10.5	3.46	3.46	3.46			10.38	2.7 ~ 13.8	2360	240 ~ 3880	4.40	A
3.5 + 3.5 + 4.2	11.2	3.25	3.25	3.90			10.40	2.7 ~ 13.8	2350	240 ~ 3870	4.43	A
3.5 + 3.5 + 5.0	12.0	3.03	3.03	4.34			10.40	2.7 ~ 13.8	2240	270 ~ 3660	4.64	A
3.5 + 3.5 + 6.0	13.0	2.80	2.80	4.80			10.40	2.7 ~ 14.1	2240	270 ~ 3780	4.64	A
3.5 + 3.5 + 7.1	14.1	2.58	2.58	5.24			10.40	2.7 ~ 14.1	2230	270 ~ 3760	4.66	A
3.5 + 4.2 + 4.2	11.9	3.06	3.67	3.67			10.40	2.7 ~ 13.8	2340	250 ~ 3850	4.44	A
3.5 + 4.2 + 5.0	12.7	2.87	3.44	4.09			10.40	2.7 ~ 14.1	2230	270 ~ 3770	4.66	A
3.5 + 4.2 + 6.0	13.7	2.66	3.19	4.55			10.40	2.7 ~ 14.1	2230	270 ~ 3770	4.66	A
3.5 + 4.2 + 7.1	14.8	2.46	2.95	4.99			10.40	2.7 ~ 14.1	2220	280 ~ 3750	4.68	A
3.5 + 5.0 + 5.0	13.5	2.70	3.85	3.85			10.40	2.7 ~ 14.1	2180	330 ~ 3620	4.77	A
3.5 + 5.0 + 6.0	14.5	2.51	3.59	4.30			10.40	2.7 ~ 14.1	2180	330 ~ 3620	4.77	A
3.5 + 5.0 + 7.1	15.6	2.33	3.33	4.74			10.40	2.7 ~ 14.4	2170	330 ~ 3720	4.79	A
3.5 + 6.0 + 6.0	15.5	2.34	4.03	4.03			10.40	2.7 ~ 14.4	2180	330 ~ 3740	4.77	A
3.5 + 6.0 + 7.1	16.6	2.19	3.76	4.45			10.40	2.7 ~ 14.4	2170	330 ~ 3720	4.79	A
3.5 + 7.1 + 7.1	17.7	2.06	4.17	4.17			10.40	2.7 ~ 14.4	2160	340 ~ 3700	4.81	A
4.2 + 4.2 + 4.2	12.6	3.46	3.46	3.46			10.38	2.7 ~ 13.8	2330	250 ~ 3780	4.45	A
4.2 + 4.2 + 5.0	13.4	3.26	3.26	3.88			10.40	2.7 ~ 14.1	2220	280 ~ 3750	4.68	A
4.2 + 4.2 + 6.0	14.4	3.03	3.03	4.34			10.40	2.7 ~ 14.1	2220	280 ~ 3750	4.68	A
4.2 + 4.2 + 7.1	15.5	2.82	2.82	4.76			10.40	2.7 ~ 14.4	2210	280 ~ 3850	4.71	A
4.2 + 5.0 + 5.0	14.2	3.08	3.66	3.66			10.40	2.7 ~ 14.1	2180	330 ~ 3610	4.77	A
4.2 + 5.0 + 6.0	15.2	2.87	3.42	4.11			10.40	2.7 ~ 14.4	2180	330 ~ 3720	4.77	A
4.2 + 5.0 + 7.1	16.3	2.68	3.19	4.53			10.40	2.7 ~ 14.4	2170	340 ~ 3710	4.79	A
4.2 + 6.0 + 6.0	16.2	2.70	3.85	3.85			10.40	2.7 ~ 14.4	2180	330 ~ 3720	4.77	A
4.2 + 6.0 + 7.1	17.3	2.52	3.61	4.27			10.40	2.7 ~ 14.4	2170	340 ~ 3710	4.79	A
5.0 + 5.0 + 5.0	15.0	3.46	3.46	3.46			10.38	2.7 ~ 14.4	2150	400 ~ 3640	4.83	A
5.0 + 5.0 + 6.0	16.0	3.25	3.25	3.90			10.40	2.7 ~ 14.4	2150	400 ~ 3640	4.84	A
5.0 + 5.0 + 7.1	17.1	3.04	3.04	4.32			10.40	2.7 ~ 14.4	2140	410 ~ 3630	4.86	A
5.0 + 6.0 + 6.0	17.0	3.06	3.67	3.67			10.40	2.7 ~ 14.4	2150	400 ~ 3640	4.84	A
5.0 + 6.0 + 7.1	18.1	2.87	3.45	4.08			10.40	2.7 ~ 14.4	2140	410 ~ 3630	4.86	A
6.0 + 6.0 + 6.0	18.0	3.46	3.46	3.46			10.38	2.7 ~ 14.4	2150	400 ~ 3640	4.83	A

3  
Room

	Indoor unit capacity Heating	Annual Energy Consumption (kWh)	Current 230V (A)	ERP			Moisture Removal Volume l/h	
				Pdesign (kW)	SCOP			Annual Consumption (kWh)
					WW	CLASS		
3 Room	2.0 + 5.0 + 5.0	1080	10.2	8.50	4.20	A+	2833	
	2.0 + 5.0 + 6.0	1080	10.2	8.50	4.20	A+	2833	
	2.0 + 5.0 + 7.1	1095	10.3	8.50	4.20	A+	2833	
	2.0 + 6.0 + 6.0	1080	10.2	8.50	4.20	A+	2833	
	2.0 + 6.0 + 7.1	1095	10.3	8.50	4.20	A+	2833	
	2.0 + 7.1 + 7.1	1090	10.2	8.50	4.20	A+	2833	
	2.5 + 2.5 + 2.5	1205	11.3	7.50	4.10	A+	2561	
	2.5 + 2.5 + 3.5	1230	11.6	8.50	4.20	A+	2833	
	2.5 + 2.5 + 4.2	1225	11.5	8.50	4.20	A+	2833	
	2.5 + 2.5 + 5.0	1145	10.8	8.50	4.20	A+	2833	
	2.5 + 2.5 + 6.0	1145	10.8	8.50	4.20	A+	2833	
	2.5 + 2.5 + 7.1	1140	10.7	8.50	4.20	A+	2833	
	2.5 + 3.5 + 3.5	1215	11.4	8.50	4.20	A+	2833	
	2.5 + 3.5 + 4.2	1210	11.4	8.50	4.20	A+	2833	
	2.5 + 3.5 + 5.0	1130	10.6	8.50	4.20	A+	2833	
	2.5 + 3.5 + 6.0	1130	10.6	8.50	4.20	A+	2833	
	2.5 + 3.5 + 7.1	1125	10.6	8.50	4.20	A+	2833	
	2.5 + 4.2 + 4.2	1205	11.3	8.50	4.20	A+	2833	
	2.5 + 4.2 + 5.0	1130	10.6	8.50	4.20	A+	2833	
	2.5 + 4.2 + 6.0	1130	10.6	8.50	4.20	A+	2833	
	2.5 + 4.2 + 7.1	1120	10.5	8.50	4.20	A+	2833	
	2.5 + 5.0 + 5.0	1080	10.2	8.50	4.20	A+	2833	
	2.5 + 5.0 + 6.0	1080	10.2	8.50	4.20	A+	2833	
	2.5 + 5.0 + 7.1	1095	10.3	8.50	4.20	A+	2833	
	2.5 + 6.0 + 6.0	1080	10.2	8.50	4.20	A+	2833	
	2.5 + 6.0 + 7.1	1095	10.3	8.50	4.20	A+	2833	
	2.5 + 7.1 + 7.1	1090	10.2	8.50	4.20	A+	2833	
	3.5 + 3.5 + 3.5	1180	11.1	8.50	4.20	A+	2833	
	3.5 + 3.5 + 4.2	1175	11.0	8.50	4.20	A+	2833	
	3.5 + 3.5 + 5.0	1120	10.5	8.50	4.20	A+	2833	
	3.5 + 3.5 + 6.0	1120	10.5	8.50	4.20	A+	2833	
	3.5 + 3.5 + 7.1	1115	10.5	8.50	4.20	A+	2833	
	3.5 + 4.2 + 4.2	1170	11.0	8.50	4.20	A+	2833	
	3.5 + 4.2 + 5.0	1115	10.5	8.50	4.20	A+	2833	
	3.5 + 4.2 + 6.0	1115	10.5	8.50	4.20	A+	2833	
	3.5 + 4.2 + 7.1	1110	10.4	8.50	4.20	A+	2833	
	3.5 + 5.0 + 5.0	1090	10.2	8.50	4.20	A+	2833	
	3.5 + 5.0 + 6.0	1090	10.2	8.50	4.20	A+	2833	
	3.5 + 5.0 + 7.1	1085	10.2	8.50	4.20	A+	2833	
	3.5 + 6.0 + 6.0	1090	10.2	8.50	4.20	A+	2833	
3.5 + 6.0 + 7.1	1085	10.2	8.50	4.20	A+	2833		
3.5 + 7.1 + 7.1	1080	10.2	8.50	4.20	A+	2833		
4.2 + 4.2 + 4.2	1165	10.9	8.50	4.20	A+	2833		
4.2 + 4.2 + 5.0	1110	10.4	8.50	4.20	A+	2833		
4.2 + 4.2 + 6.0	1110	10.4	8.50	4.20	A+	2833		
4.2 + 4.2 + 7.1	1105	10.4	8.50	4.20	A+	2833		
4.2 + 5.0 + 5.0	1090	10.2	8.50	4.20	A+	2833		
4.2 + 5.0 + 6.0	1090	10.2	8.50	4.20	A+	2833		
4.2 + 5.0 + 7.1	1085	10.2	8.50	4.20	A+	2833		
4.2 + 6.0 + 6.0	1090	10.2	8.50	4.20	A+	2833		
4.2 + 6.0 + 7.1	1085	10.2	8.50	4.20	A+	2833		
5.0 + 5.0 + 5.0	1075	10.1	8.50	4.20	A+	2833		
5.0 + 5.0 + 6.0	1075	10.1	8.50	4.20	A+	2833		
5.0 + 5.0 + 7.1	1070	10.1	8.50	4.20	A+	2833		
5.0 + 6.0 + 6.0	1075	10.1	8.50	4.20	A+	2833		
5.0 + 6.0 + 7.1	1070	10.1	8.50	4.20	A+	2833		
6.0 + 6.0 + 6.0	1075	10.1	8.50	4.20	A+	2833		

	Indoor unit capacity Heating	Total	Heating Capacity (kW)						Input Power (W)		COP		
			Room A	Room B	Room C	Room D	Room E	Total	min ~ max	Rating	min ~ max	WW	CLASS
4 Room	1.6 + 1.6 + 1.6 + 1.6	6.4	2.35	2.35	2.35	2.35		9.40	3.4 ~ 14.2	2070	340 ~ 3840	4.54	A
	1.6 + 1.6 + 1.6 + 2.0	6.8	2.33	2.33	2.33	2.91		9.90	3.4 ~ 14.2	2200	340 ~ 3830	4.50	A
	1.6 + 1.6 + 1.6 + 2.5	7.3	2.26	2.26	2.26	3.52		10.30	3.4 ~ 14.2	2190	340 ~ 3830	4.70	A
	1.6 + 1.6 + 1.6 + 3.5	8.3	2.00	2.00	2.00	4.40		10.40	3.4 ~ 14.2	2210	340 ~ 3800	4.71	A
	1.6 + 1.6 + 1.6 + 4.2	9.0	1.85	1.85	1.85	4.85		10.40	3.4 ~ 14.2	2200	340 ~ 3780	4.73	A
	1.6 + 1.6 + 1.6 + 5.0	9.8	1.70	1.70	1.70	5.30		10.40	3.4 ~ 14.2	2160	390 ~ 3640	4.81	A
	1.6 + 1.6 + 1.6 + 6.0	10.8	1.54	1.54	1.54	5.78		10.40	3.4 ~ 14.2	2160	390 ~ 3640	4.81	A
	1.6 + 1.6 + 1.6 + 7.1	11.9	1.40	1.40	1.40	6.20		10.40	3.4 ~ 14.2	2150	400 ~ 3620	4.84	A
	1.6 + 1.6 + 2.0 + 2.0	7.2	2.31	2.31	2.89	2.89		10.40	3.4 ~ 14.2	2230	340 ~ 3820	4.66	A
	1.6 + 1.6 + 2.0 + 2.5	7.7	2.16	2.16	2.70	3.38		10.40	3.4 ~ 14.2	2230	340 ~ 3820	4.66	A
	1.6 + 1.6 + 2.0 + 3.5	8.7	1.91	1.91	2.39	4.19		10.40	3.4 ~ 14.2	2200	340 ~ 3780	4.73	A
	1.6 + 1.6 + 2.0 + 4.2	9.4	1.77	1.77	2.21	4.65		10.40	3.4 ~ 14.2	2200	340 ~ 3770	4.73	A
	1.6 + 1.6 + 2.0 + 5.0	10.2	1.63	1.63	2.04	5.10		10.40	3.4 ~ 14.2	2150	400 ~ 3630	4.84	A
	1.6 + 1.6 + 2.0 + 6.0	11.2	1.49	1.49	1.86	5.56		10.40	3.4 ~ 14.2	2150	400 ~ 3630	4.84	A
	1.6 + 1.6 + 2.0 + 7.1	12.3	1.35	1.35	1.69	6.01		10.40	3.4 ~ 14.2	2150	400 ~ 3610	4.84	A
	1.6 + 1.6 + 2.5 + 2.5	8.2	2.03	2.03	3.17	3.17		10.40	3.4 ~ 14.2	2230	340 ~ 3820	4.66	A
	1.6 + 1.6 + 2.5 + 3.5	9.2	1.81	1.81	2.83	3.95		10.40	3.4 ~ 14.2	2200	340 ~ 3780	4.73	A
	1.6 + 1.6 + 2.5 + 4.2	9.9	1.68	1.68	2.63	4.41		10.40	3.4 ~ 14.2	2200	340 ~ 3770	4.73	A
	1.6 + 1.6 + 2.5 + 5.0	10.7	1.56	1.56	2.43	4.85		10.40	3.4 ~ 14.2	2150	400 ~ 3630	4.84	A
	1.6 + 1.6 + 2.5 + 6.0	11.7	1.42	1.42	2.22	5.34		10.40	3.4 ~ 14.2	2150	400 ~ 3630	4.84	A
	1.6 + 1.6 + 2.5 + 7.1	12.8	1.30	1.30	2.03	5.77		10.40	3.4 ~ 14.4	2150	400 ~ 3670	4.84	A
	1.6 + 1.6 + 3.5 + 3.5	10.2	1.63	1.63	3.57	3.57		10.40	3.4 ~ 14.2	2180	360 ~ 3750	4.77	A
	1.6 + 1.6 + 3.5 + 4.2	10.9	1.53	1.53	3.34	4.00		10.40	3.4 ~ 14.2	2170	360 ~ 3680	4.79	A
	1.6 + 1.6 + 3.5 + 5.0	11.7	1.42	1.42	3.11	4.45		10.40	3.4 ~ 14.2	2140	420 ~ 3590	4.86	A
	1.6 + 1.6 + 3.5 + 6.0	12.7	1.31	1.31	2.87	4.91		10.40	3.4 ~ 14.2	2140	420 ~ 3590	4.86	A
	1.6 + 1.6 + 3.5 + 7.1	13.8	1.21	1.21	2.64	5.34		10.40	3.4 ~ 14.4	2130	420 ~ 3640	4.88	A
	1.6 + 1.6 + 4.2 + 4.2	11.6	1.43	1.43	3.77	3.77		10.40	3.4 ~ 14.2	2170	370 ~ 3660	4.79	A
	1.6 + 1.6 + 4.2 + 5.0	12.4	1.34	1.34	3.52	4.20		10.40	3.4 ~ 14.2	2130	420 ~ 3580	4.88	A
	1.6 + 1.6 + 4.2 + 6.0	13.4	1.24	1.24	3.26	4.66		10.40	3.4 ~ 14.4	2130	420 ~ 3640	4.88	A
	1.6 + 1.6 + 4.2 + 7.1	14.5	1.15	1.15	3.01	5.09		10.40	3.4 ~ 14.4	2160	430 ~ 3620	4.81	A
	1.6 + 1.6 + 5.0 + 5.0	13.2	1.26	1.26	3.94	3.94		10.40	3.4 ~ 14.4	2160	490 ~ 3570	4.81	A
	1.6 + 1.6 + 5.0 + 6.0	14.2	1.17	1.17	3.66	4.40		10.40	3.4 ~ 14.4	2160	490 ~ 3570	4.81	A
	1.6 + 1.6 + 5.0 + 7.1	15.3	1.09	1.09	3.40	4.82		10.40	3.4 ~ 14.4	2150	510 ~ 3550	4.84	A
	1.6 + 1.6 + 6.0 + 6.0	15.2	1.09	1.09	4.11	4.11		10.40	3.4 ~ 14.4	2160	490 ~ 3570	4.81	A
	1.6 + 1.6 + 6.0 + 7.1	16.3	1.02	1.02	3.83	4.53		10.40	3.4 ~ 14.4	2150	510 ~ 3550	4.84	A
	1.6 + 1.6 + 7.1 + 7.1	17.4	0.96	0.96	4.24	4.24		10.40	3.4 ~ 14.4	2140	510 ~ 3600	4.86	A
	1.6 + 2.0 + 2.0 + 2.0	7.6	2.18	2.74	2.74	2.74		10.40	3.4 ~ 14.2	2220	340 ~ 3810	4.68	A
	1.6 + 2.0 + 2.0 + 2.5	8.1	2.05	2.57	2.57	3.21		10.40	3.4 ~ 14.2	2220	340 ~ 3810	4.68	A
	1.6 + 2.0 + 2.0 + 3.5	9.1	1.83	2.29	2.29	3.99		10.40	3.4 ~ 14.2	2200	340 ~ 3770	4.73	A
	1.6 + 2.0 + 2.0 + 4.2	9.8	1.70	2.12	2.12	4.46		10.40	3.4 ~ 14.2	2190	350 ~ 3760	4.75	A
1.6 + 2.0 + 2.0 + 5.0	10.6	1.57	1.96	1.96	4.91		10.40	3.4 ~ 14.2	2150	400 ~ 3620	4.84	A	
1.6 + 2.0 + 2.0 + 6.0	11.6	1.43	1.79	1.79	5.39		10.40	3.4 ~ 14.2	2150	400 ~ 3620	4.84	A	
1.6 + 2.0 + 2.0 + 7.1	12.7	1.31	1.64	1.64	5.81		10.40	3.4 ~ 14.2	2140	420 ~ 3600	4.86	A	
1.6 + 2.0 + 2.5 + 2.5	8.6	1.93	2.43	3.02	3.02		10.40	3.4 ~ 14.2	2220	340 ~ 3810	4.68	A	
1.6 + 2.0 + 2.5 + 3.5	9.6	1.73	2.17	2.71	3.79		10.40	3.4 ~ 14.2	2200	340 ~ 3770	4.73	A	
1.6 + 2.0 + 2.5 + 4.2	10.3	1.62	2.02	2.52	4.24		10.40	3.4 ~ 14.2	2190	350 ~ 3760	4.75	A	
1.6 + 2.0 + 2.5 + 5.0	11.1	1.50	1.87	2.34	4.69		10.40	3.4 ~ 14.2	2150	400 ~ 3620	4.84	A	
1.6 + 2.0 + 2.5 + 6.0	12.1	1.38	1.72	2.15	5.15		10.40	3.4 ~ 14.2	2150	400 ~ 3620	4.84	A	
1.6 + 2.0 + 2.5 + 7.1	13.2	1.26	1.58	1.97	5.59		10.40	3.4 ~ 14.4	2140	420 ~ 3660	4.86	A	
1.6 + 2.0 + 3.5 + 3.5	10.6	1.57	1.97	3.43	3.43		10.40	3.4 ~ 14.2	2170	360 ~ 3680	4.79	A	
1.6 + 2.0 + 3.5 + 4.2	11.3	1.47	1.84	3.22	3.87		10.40	3.4 ~ 14.2	2170	370 ~ 3660	4.79	A	
1.6 + 2.0 + 3.5 + 5.0	12.1	1.38	1.72	3.01	4.29		10.40	3.4 ~ 14.2	2130	420 ~ 3580	4.88	A	
1.6 + 2.0 + 3.5 + 6.0	13.1	1.27	1.59	2.78	4.76		10.40	3.4 ~ 14.4	2130	420 ~ 3640	4.88	A	
1.6 + 2.0 + 3.5 + 7.1	14.2	1.17	1.46	2.56	5.21		10.40	3.4 ~ 14.4	2160	430 ~ 3620	4.81	A	
1.6 + 2.0 + 4.2 + 4.2	12.0	1.39	1.73	3.64	3.64		10.40	3.4 ~ 14.2	2160	370 ~ 3650	4.81	A	
1.6 + 2.0 + 4.2 + 5.0	12.8	1.30	1.63	3.41	4.06		10.40	3.4 ~ 14.4	2120	420 ~ 3630	4.91	A	
1.6 + 2.0 + 4.2 + 6.0	13.8	1.21	1.51	3.17	4.51		10.40	3.4 ~ 14.4	2120	420 ~ 3630	4.91	A	
1.6 + 2.0 + 4.2 + 7.1	14.9	1.12	1.40	2.93	4.95		10.40	3.4 ~ 14.4	2160	430 ~ 3610	4.81	A	

	Indoor unit capacity Heating	Annual Energy Consumption (kWh)	Current 230V (A)	ERP				Moisture Removal Volume l/h
				Pdesign (kW)	SCOP		Annual Consumption (kWh)	
					WW	CLASS		
4 Room	1.6 + 1.6 + 1.6 + 1.6	1035	9.7	8.50	4.10	A+	2902	
	1.6 + 1.6 + 1.6 + 2.0	1100	10.3	8.50	4.10	A+	2902	
	1.6 + 1.6 + 1.6 + 2.5	1095	10.3	8.50	4.20	A+	2833	
	1.6 + 1.6 + 1.6 + 3.5	1105	10.4	8.50	4.20	A+	2833	
	1.6 + 1.6 + 1.6 + 4.2	1100	10.3	8.50	4.40	A+	2705	
	1.6 + 1.6 + 1.6 + 5.0	1080	10.2	8.50	4.40	A+	2705	
	1.6 + 1.6 + 1.6 + 6.0	1080	10.2	8.50	4.40	A+	2705	
	1.6 + 1.6 + 1.6 + 7.1	1075	10.1	8.50	4.40	A+	2705	
	1.6 + 1.6 + 2.0 + 2.0	1115	10.5	8.50	4.20	A+	2833	
	1.6 + 1.6 + 2.0 + 2.5	1115	10.5	8.50	4.20	A+	2833	
	1.6 + 1.6 + 2.0 + 3.5	1100	10.3	8.50	4.20	A+	2833	
	1.6 + 1.6 + 2.0 + 4.2	1100	10.3	8.50	4.40	A+	2705	
	1.6 + 1.6 + 2.0 + 5.0	1075	10.1	8.50	4.40	A+	2705	
	1.6 + 1.6 + 2.0 + 6.0	1075	10.1	8.50	4.40	A+	2705	
	1.6 + 1.6 + 2.0 + 7.1	1075	10.1	8.50	4.40	A+	2705	
	1.6 + 1.6 + 2.5 + 2.5	1115	10.5	8.50	4.20	A+	2833	
	1.6 + 1.6 + 2.5 + 3.5	1100	10.3	8.50	4.40	A+	2705	
	1.6 + 1.6 + 2.5 + 4.2	1100	10.3	8.50	4.40	A+	2705	
	1.6 + 1.6 + 2.5 + 5.0	1075	10.1	8.50	4.40	A+	2705	
	1.6 + 1.6 + 2.5 + 6.0	1075	10.1	8.50	4.40	A+	2705	
	1.6 + 1.6 + 2.5 + 7.1	1075	10.1	8.50	4.40	A+	2705	
	1.6 + 1.6 + 3.5 + 3.5	1090	10.2	8.50	4.40	A+	2705	
	1.6 + 1.6 + 3.5 + 4.2	1085	10.2	8.50	4.40	A+	2705	
	1.6 + 1.6 + 3.5 + 5.0	1070	10.1	8.50	4.40	A+	2705	
	1.6 + 1.6 + 3.5 + 6.0	1070	10.1	8.50	4.40	A+	2705	
	1.6 + 1.6 + 3.5 + 7.1	1065	10.0	8.50	4.40	A+	2705	
	1.6 + 1.6 + 4.2 + 4.2	1085	10.2	8.50	4.40	A+	2705	
	1.6 + 1.6 + 4.2 + 5.0	1065	10.0	8.50	4.40	A+	2705	
	1.6 + 1.6 + 4.2 + 6.0	1065	10.0	8.50	4.40	A+	2705	
	1.6 + 1.6 + 4.2 + 7.1	1080	10.2	8.50	4.40	A+	2705	
	1.6 + 1.6 + 5.0 + 5.0	1080	10.2	8.50	4.40	A+	2705	
	1.6 + 1.6 + 5.0 + 6.0	1080	10.2	8.50	4.40	A+	2705	
	1.6 + 1.6 + 5.0 + 7.1	1075	10.1	8.50	4.40	A+	2705	
	1.6 + 1.6 + 6.0 + 6.0	1080	10.2	8.50	4.40	A+	2705	
	1.6 + 1.6 + 6.0 + 7.1	1075	10.1	8.50	4.40	A+	2705	
	1.6 + 1.6 + 7.1 + 7.1	1070	10.1	8.50	4.40	A+	2705	
	1.6 + 2.0 + 2.0 + 2.0	1110	10.4	8.50	4.20	A+	2833	
	1.6 + 2.0 + 2.0 + 2.5	1110	10.4	8.50	4.20	A+	2833	
	1.6 + 2.0 + 2.0 + 3.5	1100	10.3	8.50	4.40	A+	2705	
	1.6 + 2.0 + 2.0 + 4.2	1095	10.3	8.50	4.40	A+	2705	
1.6 + 2.0 + 2.0 + 5.0	1075	10.1	8.50	4.40	A+	2705		
1.6 + 2.0 + 2.0 + 6.0	1075	10.1	8.50	4.40	A+	2705		
1.6 + 2.0 + 2.0 + 7.1	1070	10.1	8.50	4.40	A+	2705		
1.6 + 2.0 + 2.5 + 2.5	1110	10.4	8.50	4.20	A+	2833		
1.6 + 2.0 + 2.5 + 3.5	1100	10.3	8.50	4.40	A+	2705		
1.6 + 2.0 + 2.5 + 4.2	1095	10.3	8.50	4.40	A+	2705		
1.6 + 2.0 + 2.5 + 5.0	1075	10.1	8.50	4.40	A+	2705		
1.6 + 2.0 + 2.5 + 6.0	1075	10.1	8.50	4.40	A+	2705		
1.6 + 2.0 + 2.5 + 7.1	1070	10.1	8.50	4.40	A+	2705		
1.6 + 2.0 + 3.5 + 3.5	1085	10.2	8.50	4.40	A+	2705		
1.6 + 2.0 + 3.5 + 4.2	1085	10.2	8.50	4.40	A+	2705		
1.6 + 2.0 + 3.5 + 5.0	1065	10.0	8.50	4.40	A+	2705		
1.6 + 2.0 + 3.5 + 6.0	1065	10.0	8.50	4.40	A+	2705		
1.6 + 2.0 + 3.5 + 7.1	1080	10.2	8.50	4.40	A+	2705		
1.6 + 2.0 + 4.2 + 4.2	1080	10.2	8.50	4.40	A+	2705		
1.6 + 2.0 + 4.2 + 5.0	1060	10.0	8.50	4.40	A+	2705		
1.6 + 2.0 + 4.2 + 6.0	1060	10.0	8.50	4.40	A+	2705		
1.6 + 2.0 + 4.2 + 7.1	1080	10.2	8.50	4.40	A+	2705		

	Indoor unit capacity Heating	Total	Heating Capacity (kW)							Input Power (W)		COP	
			Room A	Room B	Room C	Room D	Room E	Total	min ~ max	Rating	min ~ max	WW	CLASS
4 Room	1.6 + 2.0 + 5.0 + 5.0	13.6	1.22	1.54	3.82	3.82		10.40	3.4 ~ 14.4	2150	500 ~ 3560	4.84	A
	1.6 + 2.0 + 5.0 + 6.0	14.6	1.14	1.42	3.56	4.28		10.40	3.4 ~ 14.4	2150	500 ~ 3560	4.84	A
	1.6 + 2.0 + 5.0 + 7.1	15.7	1.06	1.32	3.31	4.71		10.40	3.4 ~ 14.4	2150	510 ~ 3600	4.84	A
	1.6 + 2.0 + 6.0 + 6.0	15.6	1.07	1.33	4.00	4.00		10.40	3.4 ~ 14.4	2150	500 ~ 3560	4.84	A
	1.6 + 2.0 + 6.0 + 7.1	16.7	1.00	1.25	3.74	4.41		10.40	3.4 ~ 14.4	2150	510 ~ 3600	4.84	A
	1.6 + 2.0 + 7.1 + 7.1	17.8	0.93	1.17	4.15	4.15		10.40	3.4 ~ 14.4	2180	520 ~ 3590	4.77	A
	1.6 + 2.5 + 2.5 + 2.5	9.1	1.82	2.86	2.86	2.86		10.40	3.4 ~ 14.2	2220	340 ~ 3810	4.68	A
	1.6 + 2.5 + 2.5 + 3.5	10.1	1.65	2.57	2.57	3.61		10.40	3.4 ~ 14.2	2200	340 ~ 3770	4.73	A
	1.6 + 2.5 + 2.5 + 4.2	10.8	1.54	2.41	2.41	4.04		10.40	3.4 ~ 14.2	2190	350 ~ 3760	4.75	A
	1.6 + 2.5 + 2.5 + 5.0	11.6	1.43	2.24	2.24	4.49		10.40	3.4 ~ 14.2	2150	400 ~ 3620	4.84	A
	1.6 + 2.5 + 2.5 + 6.0	12.6	1.32	2.06	2.06	4.96		10.40	3.4 ~ 14.2	2150	400 ~ 3620	4.84	A
	1.6 + 2.5 + 2.5 + 7.1	13.7	1.21	1.90	1.90	5.39		10.40	3.4 ~ 14.4	2140	420 ~ 3660	4.86	A
	1.6 + 2.5 + 3.5 + 3.5	11.1	1.50	2.34	3.28	3.28		10.40	3.4 ~ 14.2	2170	360 ~ 3680	4.79	A
	1.6 + 2.5 + 3.5 + 4.2	11.8	1.41	2.20	3.08	3.71		10.40	3.4 ~ 14.2	2170	370 ~ 3660	4.79	A
	1.6 + 2.5 + 3.5 + 5.0	12.6	1.32	2.06	2.89	4.13		10.40	3.4 ~ 14.2	2130	420 ~ 3580	4.88	A
	1.6 + 2.5 + 3.5 + 6.0	13.6	1.22	1.91	2.68	4.59		10.40	3.4 ~ 14.4	2130	420 ~ 3640	4.88	A
	1.6 + 2.5 + 3.5 + 7.1	14.7	1.13	1.77	2.48	5.02		10.40	3.4 ~ 14.4	2160	430 ~ 3620	4.81	A
	1.6 + 2.5 + 4.2 + 4.2	12.5	1.33	2.09	3.49	3.49		10.40	3.4 ~ 14.2	2160	370 ~ 3650	4.81	A
	1.6 + 2.5 + 4.2 + 5.0	13.3	1.25	1.95	3.28	3.92		10.40	3.4 ~ 14.4	2120	420 ~ 3630	4.91	A
	1.6 + 2.5 + 4.2 + 6.0	14.3	1.16	1.82	3.05	4.37		10.40	3.4 ~ 14.4	2120	420 ~ 3630	4.91	A
	1.6 + 2.5 + 4.2 + 7.1	15.4	1.08	1.69	2.84	4.79		10.40	3.4 ~ 14.4	2160	430 ~ 3610	4.81	A
	1.6 + 2.5 + 5.0 + 5.0	14.1	1.18	1.84	3.69	3.69		10.40	3.4 ~ 14.4	2150	500 ~ 3560	4.84	A
	1.6 + 2.5 + 5.0 + 6.0	15.1	1.10	1.72	3.44	4.14		10.40	3.4 ~ 14.4	2150	500 ~ 3560	4.84	A
	1.6 + 2.5 + 5.0 + 7.1	16.2	1.03	1.60	3.21	4.56		10.40	3.4 ~ 14.4	2150	510 ~ 3600	4.84	A
	1.6 + 2.5 + 6.0 + 6.0	16.1	1.03	1.61	3.88	3.88		10.40	3.4 ~ 14.4	2150	500 ~ 3560	4.84	A
	1.6 + 2.5 + 6.0 + 7.1	17.2	0.97	1.51	3.63	4.29		10.40	3.4 ~ 14.4	2150	510 ~ 3600	4.84	A
	1.6 + 2.5 + 7.1 + 7.1	18.3	0.91	1.43	4.03	4.03		10.40	3.4 ~ 14.4	2180	520 ~ 3590	4.77	A
	1.6 + 3.5 + 3.5 + 3.5	12.1	1.37	3.01	3.01	3.01		10.40	3.4 ~ 14.2	2150	370 ~ 3640	4.84	A
	1.6 + 3.5 + 3.5 + 4.2	12.8	1.30	2.84	2.84	3.42		10.40	3.4 ~ 14.4	2190	370 ~ 3750	4.75	A
	1.6 + 3.5 + 3.5 + 5.0	13.6	1.22	2.68	2.68	3.82		10.40	3.4 ~ 14.4	2160	430 ~ 3610	4.81	A
	1.6 + 3.5 + 3.5 + 6.0	14.6	1.14	2.49	2.49	4.28		10.40	3.4 ~ 14.4	2160	430 ~ 3610	4.81	A
	1.6 + 3.5 + 3.5 + 7.1	15.7	1.06	2.32	2.32	4.70		10.40	3.4 ~ 14.4	2150	450 ~ 3650	4.84	A
	1.6 + 3.5 + 4.2 + 4.2	13.5	1.22	2.70	3.24	3.24		10.40	3.4 ~ 14.4	2180	370 ~ 3730	4.77	A
	1.6 + 3.5 + 4.2 + 5.0	14.3	1.16	2.55	3.05	3.64		10.40	3.4 ~ 14.4	2150	450 ~ 3650	4.84	A
	1.6 + 3.5 + 4.2 + 6.0	15.3	1.09	2.38	2.85	4.08		10.40	3.4 ~ 14.4	2150	450 ~ 3650	4.84	A
	1.6 + 3.5 + 4.2 + 7.1	16.4	1.01	2.22	2.66	4.51		10.40	3.4 ~ 14.4	2140	450 ~ 3640	4.86	A
	1.6 + 3.5 + 5.0 + 5.0	15.1	1.10	2.42	3.44	3.44		10.40	3.4 ~ 14.4	2180	520 ~ 3590	4.77	A
	1.6 + 3.5 + 5.0 + 6.0	16.1	1.03	2.26	3.23	3.88		10.40	3.4 ~ 14.4	2180	520 ~ 3590	4.77	A
	1.6 + 3.5 + 5.0 + 7.1	17.2	0.97	2.12	3.02	4.29		10.40	3.4 ~ 14.4	2180	540 ~ 3570	4.77	A
	1.6 + 3.5 + 6.0 + 6.0	17.1	0.97	2.13	3.65	3.65		10.40	3.4 ~ 14.4	2180	520 ~ 3590	4.77	A
	1.6 + 3.5 + 6.0 + 7.1	18.2	0.91	2.00	3.43	4.06		10.40	3.4 ~ 14.4	2180	540 ~ 3570	4.77	A
	1.6 + 4.2 + 4.2 + 4.2	14.2	1.16	3.08	3.08	3.08		10.40	3.4 ~ 14.4	2170	390 ~ 3720	4.79	A
	1.6 + 4.2 + 4.2 + 5.0	15.0	1.11	2.91	2.91	3.47		10.40	3.4 ~ 14.4	2150	450 ~ 3640	4.84	A
1.6 + 4.2 + 4.2 + 6.0	16.0	1.04	2.73	2.73	3.90		10.40	3.4 ~ 14.4	2150	450 ~ 3640	4.84	A	
1.6 + 4.2 + 4.2 + 7.1	17.1	0.97	2.55	2.55	4.33		10.40	3.4 ~ 14.4	2140	460 ~ 3630	4.86	A	
1.6 + 4.2 + 5.0 + 5.0	15.8	1.05	2.77	3.29	3.29		10.40	3.4 ~ 14.4	2180	530 ~ 3580	4.77	A	
1.6 + 4.2 + 5.0 + 6.0	16.8	0.99	2.60	3.10	3.71		10.40	3.4 ~ 14.4	2180	530 ~ 3580	4.77	A	
1.6 + 4.2 + 5.0 + 7.1	17.9	0.93	2.44	2.91	4.12		10.40	3.4 ~ 14.4	2170	540 ~ 3560	4.79	A	
1.6 + 4.2 + 6.0 + 6.0	17.8	0.93	2.45	3.51	3.51		10.40	3.4 ~ 14.4	2180	530 ~ 3580	4.77	A	
1.6 + 5.0 + 5.0 + 5.0	16.6	1.01	3.13	3.13	3.13		10.40	3.4 ~ 14.4	2230	630 ~ 3580	4.66	A	
1.6 + 5.0 + 5.0 + 6.0	17.6	0.95	2.95	2.95	3.55		10.40	3.4 ~ 14.4	2230	630 ~ 3580	4.66	A	
2.0 + 2.0 + 2.0 + 2.0	8.0	2.60	2.60	2.60	2.60		10.40	3.4 ~ 14.2	2210	340 ~ 3790	4.71	A	
2.0 + 2.0 + 2.0 + 2.5	8.5	2.45	2.45	2.45	3.05		10.40	3.4 ~ 14.2	2210	340 ~ 3790	4.71	A	
2.0 + 2.0 + 2.0 + 3.5	9.5	2.19	2.19	2.19	3.83		10.40	3.4 ~ 14.2	2190	350 ~ 3760	4.75	A	
2.0 + 2.0 + 2.0 + 4.2	10.2	2.04	2.04	2.04	4.28		10.40	3.4 ~ 14.2	2180	360 ~ 3740	4.77	A	
2.0 + 2.0 + 2.0 + 5.0	11.0	1.89	1.89	1.89	4.73		10.40	3.4 ~ 14.2	2140	420 ~ 3600	4.86	A	
2.0 + 2.0 + 2.0 + 6.0	12.0	1.73	1.73	1.73	5.21		10.40	3.4 ~ 14.2	2140	420 ~ 3600	4.86	A	
2.0 + 2.0 + 2.0 + 7.1	13.1	1.59	1.59	1.59	5.63		10.40	3.4 ~ 14.4	2130	420 ~ 3640	4.88	A	



	Indoor unit capacity Heating	Annual Energy Consumption (kWh)	Current 230V (A)	ERP			Moisture Removal Volume l/h	
				Pdesign (kW)	SCOP			Annual Consumption (kWh)
					WW	CLASS		
4 Room	1.6 + 2.0 + 5.0 + 5.0	1075	10.1	8.50	4.40	A+	2705	
	1.6 + 2.0 + 5.0 + 6.0	1075	10.1	8.50	4.40	A+	2705	
	1.6 + 2.0 + 5.0 + 7.1	1075	10.1	8.50	4.40	A+	2705	
	1.6 + 2.0 + 6.0 + 6.0	1075	10.1	8.50	4.40	A+	2705	
	1.6 + 2.0 + 6.0 + 7.1	1075	10.1	8.50	4.40	A+	2705	
	1.6 + 2.0 + 7.1 + 7.1	1090	10.2	8.50	4.40	A+	2705	
	1.6 + 2.5 + 2.5 + 2.5	1110	10.4	8.50	4.40	A+	2705	
	1.6 + 2.5 + 2.5 + 3.5	1100	10.3	8.50	4.40	A+	2705	
	1.6 + 2.5 + 2.5 + 4.2	1095	10.3	8.50	4.40	A+	2705	
	1.6 + 2.5 + 2.5 + 5.0	1075	10.1	8.50	4.40	A+	2705	
	1.6 + 2.5 + 2.5 + 6.0	1075	10.1	8.50	4.40	A+	2705	
	1.6 + 2.5 + 2.5 + 7.1	1070	10.1	8.50	4.40	A+	2705	
	1.6 + 2.5 + 3.5 + 3.5	1085	10.2	8.50	4.40	A+	2705	
	1.6 + 2.5 + 3.5 + 4.2	1085	10.2	8.50	4.40	A+	2705	
	1.6 + 2.5 + 3.5 + 5.0	1065	10.0	8.50	4.40	A+	2705	
	1.6 + 2.5 + 3.5 + 6.0	1065	10.0	8.50	4.40	A+	2705	
	1.6 + 2.5 + 3.5 + 7.1	1080	10.2	8.50	4.40	A+	2705	
	1.6 + 2.5 + 4.2 + 4.2	1080	10.2	8.50	4.40	A+	2705	
	1.6 + 2.5 + 4.2 + 5.0	1060	10.0	8.50	4.40	A+	2705	
	1.6 + 2.5 + 4.2 + 6.0	1060	10.0	8.50	4.40	A+	2705	
	1.6 + 2.5 + 4.2 + 7.1	1080	10.2	8.50	4.40	A+	2705	
	1.6 + 2.5 + 5.0 + 5.0	1075	10.1	8.50	4.40	A+	2705	
	1.6 + 2.5 + 5.0 + 6.0	1075	10.1	8.50	4.40	A+	2705	
	1.6 + 2.5 + 5.0 + 7.1	1075	10.1	8.50	4.40	A+	2705	
	1.6 + 2.5 + 6.0 + 6.0	1075	10.1	8.50	4.40	A+	2705	
	1.6 + 2.5 + 6.0 + 7.1	1075	10.1	8.50	4.40	A+	2705	
	1.6 + 2.5 + 7.1 + 7.1	1090	10.2	8.50	4.40	A+	2705	
	1.6 + 3.5 + 3.5 + 3.5	1075	10.1	8.50	4.40	A+	2705	
	1.6 + 3.5 + 3.5 + 4.2	1095	10.3	8.50	4.40	A+	2705	
	1.6 + 3.5 + 3.5 + 5.0	1080	10.2	8.50	4.40	A+	2705	
	1.6 + 3.5 + 3.5 + 6.0	1080	10.2	8.50	4.40	A+	2705	
	1.6 + 3.5 + 3.5 + 7.1	1075	10.1	8.50	4.40	A+	2705	
	1.6 + 3.5 + 4.2 + 4.2	1090	10.2	8.50	4.40	A+	2705	
	1.6 + 3.5 + 4.2 + 5.0	1075	10.1	8.50	4.40	A+	2705	
	1.6 + 3.5 + 4.2 + 6.0	1075	10.1	8.50	4.40	A+	2705	
	1.6 + 3.5 + 4.2 + 7.1	1070	10.1	8.50	4.40	A+	2705	
	1.6 + 3.5 + 5.0 + 5.0	1090	10.2	8.50	4.40	A+	2705	
	1.6 + 3.5 + 5.0 + 6.0	1090	10.2	8.50	4.40	A+	2705	
	1.6 + 3.5 + 5.0 + 7.1	1090	10.2	8.50	4.40	A+	2705	
	1.6 + 3.5 + 6.0 + 6.0	1090	10.2	8.50	4.40	A+	2705	
1.6 + 3.5 + 6.0 + 7.1	1090	10.2	8.50	4.40	A+	2705		
1.6 + 4.2 + 4.2 + 4.2	1085	10.2	8.50	4.40	A+	2705		
1.6 + 4.2 + 4.2 + 5.0	1075	10.1	8.50	4.40	A+	2705		
1.6 + 4.2 + 4.2 + 6.0	1075	10.1	8.50	4.40	A+	2705		
1.6 + 4.2 + 4.2 + 7.1	1070	10.1	8.50	4.40	A+	2705		
1.6 + 4.2 + 5.0 + 5.0	1090	10.2	8.50	4.40	A+	2705		
1.6 + 4.2 + 5.0 + 6.0	1090	10.2	8.50	4.40	A+	2705		
1.6 + 4.2 + 5.0 + 7.1	1085	10.2	8.50	4.40	A+	2705		
1.6 + 4.2 + 6.0 + 6.0	1090	10.2	8.50	4.40	A+	2705		
1.6 + 5.0 + 5.0 + 5.0	1115	10.5	8.50	4.40	A+	2705		
1.6 + 5.0 + 5.0 + 6.0	1115	10.5	8.50	4.40	A+	2705		
2.0 + 2.0 + 2.0 + 2.0	1105	10.4	8.50	4.20	A+	2833		
2.0 + 2.0 + 2.0 + 2.5	1105	10.4	8.50	4.20	A+	2833		
2.0 + 2.0 + 2.0 + 3.5	1095	10.3	8.50	4.40	A+	2705		
2.0 + 2.0 + 2.0 + 4.2	1090	10.2	8.50	4.40	A+	2705		
2.0 + 2.0 + 2.0 + 5.0	1070	10.1	8.50	4.40	A+	2705		
2.0 + 2.0 + 2.0 + 6.0	1070	10.1	8.50	4.40	A+	2705		
2.0 + 2.0 + 2.0 + 7.1	1065	10.0	8.50	4.40	A+	2705		

Indoor unit capacity Heating	Total	Heating Capacity (kW)							Input Power (W)		COP	
		Room A	Room B	Room C	Room D	Room E	Total	min ~ max	Rating	min ~ max	WW	CLASS
2.0 + 2.0 + 2.5 + 2.5	9.0	2.31	2.31	2.89	2.89		10.40	3.4 ~ 14.2	2210	340 ~ 3790	4.71	A
2.0 + 2.0 + 2.5 + 3.5	10.0	2.08	2.08	2.60	3.64		10.40	3.4 ~ 14.2	2190	350 ~ 3760	4.75	A
2.0 + 2.0 + 2.5 + 4.2	10.7	1.94	1.94	2.43	4.09		10.40	3.4 ~ 14.2	2180	360 ~ 3740	4.77	A
2.0 + 2.0 + 2.5 + 5.0	11.5	1.81	1.81	2.26	4.52		10.40	3.4 ~ 14.2	2140	420 ~ 3600	4.86	A
2.0 + 2.0 + 2.5 + 6.0	12.5	1.66	1.66	2.08	5.00		10.40	3.4 ~ 14.2	2140	420 ~ 3600	4.86	A
2.0 + 2.0 + 2.5 + 7.1	13.6	1.53	1.53	1.91	5.43		10.40	3.4 ~ 14.4	2130	420 ~ 3640	4.88	A
2.0 + 2.0 + 3.5 + 3.5	11.0	1.89	1.89	3.31	3.31		10.40	3.4 ~ 14.2	2170	370 ~ 3660	4.79	A
2.0 + 2.0 + 3.5 + 4.2	11.7	1.78	1.78	3.11	3.73		10.40	3.4 ~ 14.2	2160	370 ~ 3650	4.81	A
2.0 + 2.0 + 3.5 + 5.0	12.5	1.66	1.66	2.91	4.17		10.40	3.4 ~ 14.2	2120	420 ~ 3570	4.91	A
2.0 + 2.0 + 3.5 + 6.0	13.5	1.54	1.54	2.70	4.62		10.40	3.4 ~ 14.4	2120	420 ~ 3630	4.91	A
2.0 + 2.0 + 3.5 + 7.1	14.6	1.42	1.42	2.49	5.07		10.40	3.4 ~ 14.4	2160	430 ~ 3610	4.81	A
2.0 + 2.0 + 4.2 + 4.2	12.4	1.68	1.68	3.52	3.52		10.40	3.4 ~ 14.2	2190	370 ~ 3640	4.75	A
2.0 + 2.0 + 4.2 + 5.0	13.2	1.58	1.58	3.31	3.93		10.40	3.4 ~ 14.4	2160	430 ~ 3620	4.81	A
2.0 + 2.0 + 4.2 + 6.0	14.2	1.46	1.46	3.08	4.40		10.40	3.4 ~ 14.4	2160	430 ~ 3620	4.81	A
2.0 + 2.0 + 4.2 + 7.1	15.3	1.36	1.36	2.85	4.83		10.40	3.4 ~ 14.4	2150	440 ~ 3660	4.84	A
2.0 + 2.0 + 5.0 + 5.0	14.0	1.49	1.49	3.71	3.71		10.40	3.4 ~ 14.4	2150	510 ~ 3600	4.84	A
2.0 + 2.0 + 5.0 + 6.0	15.0	1.39	1.39	3.47	4.15		10.40	3.4 ~ 14.4	2150	510 ~ 3600	4.84	A
2.0 + 2.0 + 5.0 + 7.1	16.1	1.29	1.29	3.23	4.59		10.40	3.4 ~ 14.4	2180	520 ~ 3590	4.77	A
2.0 + 2.0 + 6.0 + 6.0	16.0	1.30	1.30	3.90	3.90		10.40	3.4 ~ 14.4	2150	510 ~ 3600	4.84	A
2.0 + 2.0 + 6.0 + 7.1	17.1	1.22	1.22	3.65	4.31		10.40	3.4 ~ 14.4	2180	520 ~ 3590	4.77	A
2.0 + 2.0 + 7.1 + 7.1	18.2	1.14	1.14	4.06	4.06		10.40	3.4 ~ 14.4	2180	530 ~ 3580	4.77	A
2.0 + 2.5 + 2.5 + 2.5	9.5	2.18	2.74	2.74	2.74		10.40	3.4 ~ 14.2	2210	340 ~ 3790	4.71	A
2.0 + 2.5 + 2.5 + 3.5	10.5	1.98	2.48	2.48	3.46		10.40	3.4 ~ 14.2	2190	350 ~ 3760	4.75	A
2.0 + 2.5 + 2.5 + 4.2	11.2	1.86	2.32	2.32	3.90		10.40	3.4 ~ 14.2	2180	360 ~ 3740	4.77	A
2.0 + 2.5 + 2.5 + 5.0	12.0	1.73	2.17	2.17	4.33		10.40	3.4 ~ 14.2	2140	420 ~ 3600	4.86	A
2.0 + 2.5 + 2.5 + 6.0	13.0	1.60	2.00	2.00	4.80		10.40	3.4 ~ 14.4	2140	420 ~ 3660	4.86	A
2.0 + 2.5 + 2.5 + 7.1	14.1	1.48	1.84	1.84	5.24		10.40	3.4 ~ 14.4	2130	420 ~ 3640	4.88	A
2.0 + 2.5 + 3.5 + 3.5	11.5	1.80	2.26	3.17	3.17		10.40	3.4 ~ 14.2	2170	370 ~ 3660	4.79	A
2.0 + 2.5 + 3.5 + 4.2	12.2	1.70	2.13	2.98	3.59		10.40	3.4 ~ 14.2	2160	370 ~ 3650	4.81	A
2.0 + 2.5 + 3.5 + 5.0	13.0	1.60	2.00	2.80	4.00		10.40	3.4 ~ 14.4	2120	420 ~ 3630	4.91	A
2.0 + 2.5 + 3.5 + 6.0	14.0	1.49	1.86	2.60	4.45		10.40	3.4 ~ 14.4	2120	420 ~ 3630	4.91	A
2.0 + 2.5 + 3.5 + 7.1	15.1	1.38	1.72	2.41	4.89		10.40	3.4 ~ 14.4	2160	430 ~ 3610	4.81	A
2.0 + 2.5 + 4.2 + 4.2	12.9	1.60	2.02	3.39	3.39		10.40	3.4 ~ 14.4	2190	370 ~ 3760	4.75	A
2.0 + 2.5 + 4.2 + 5.0	13.7	1.52	1.90	3.19	3.79		10.40	3.4 ~ 14.4	2160	430 ~ 3620	4.81	A
2.0 + 2.5 + 4.2 + 6.0	14.7	1.41	1.77	2.97	4.25		10.40	3.4 ~ 14.4	2160	430 ~ 3620	4.81	A
2.0 + 2.5 + 4.2 + 7.1	15.8	1.32	1.65	2.76	4.67		10.40	3.4 ~ 14.4	2150	440 ~ 3660	4.84	A
2.0 + 2.5 + 5.0 + 5.0	14.5	1.43	1.79	3.59	3.59		10.40	3.4 ~ 14.4	2150	510 ~ 3600	4.84	A
2.0 + 2.5 + 5.0 + 6.0	15.5	1.34	1.68	3.35	4.03		10.40	3.4 ~ 14.4	2150	510 ~ 3600	4.84	A
2.0 + 2.5 + 5.0 + 7.1	16.6	1.25	1.57	3.13	4.45		10.40	3.4 ~ 14.4	2180	520 ~ 3590	4.77	A
2.0 + 2.5 + 6.0 + 6.0	16.5	1.26	1.58	3.78	3.78		10.40	3.4 ~ 14.4	2150	510 ~ 3600	4.84	A
2.0 + 2.5 + 6.0 + 7.1	17.6	1.18	1.48	3.55	4.19		10.40	3.4 ~ 14.4	2180	520 ~ 3590	4.77	A
2.0 + 3.5 + 3.5 + 3.5	12.5	1.67	2.91	2.91	2.91		10.40	3.4 ~ 14.2	2190	370 ~ 3630	4.75	A
2.0 + 3.5 + 3.5 + 4.2	13.2	1.58	2.76	2.76	3.30		10.40	3.4 ~ 14.4	2180	370 ~ 3730	4.77	A
2.0 + 3.5 + 3.5 + 5.0	14.0	1.49	2.60	2.60	3.71		10.40	3.4 ~ 14.4	2150	450 ~ 3650	4.84	A
2.0 + 3.5 + 3.5 + 6.0	15.0	1.39	2.43	2.43	4.15		10.40	3.4 ~ 14.4	2150	450 ~ 3650	4.84	A
2.0 + 3.5 + 3.5 + 7.1	16.1	1.29	2.26	2.26	4.59		10.40	3.4 ~ 14.4	2140	450 ~ 3640	4.86	A
2.0 + 3.5 + 4.2 + 4.2	13.9	1.50	2.62	3.14	3.14		10.40	3.4 ~ 14.4	2170	390 ~ 3720	4.79	A
2.0 + 3.5 + 4.2 + 5.0	14.7	1.41	2.48	2.97	3.54		10.40	3.4 ~ 14.4	2150	450 ~ 3640	4.84	A
2.0 + 3.5 + 4.2 + 6.0	15.7	1.32	2.32	2.78	3.98		10.40	3.4 ~ 14.4	2150	450 ~ 3640	4.84	A
2.0 + 3.5 + 4.2 + 7.1	16.8	1.24	2.17	2.60	4.39		10.40	3.4 ~ 14.4	2140	460 ~ 3630	4.86	A
2.0 + 3.5 + 5.0 + 5.0	15.5	1.34	2.36	3.35	3.35		10.40	3.4 ~ 14.4	2180	530 ~ 3580	4.77	A
2.0 + 3.5 + 5.0 + 6.0	16.5	1.26	2.21	3.15	3.78		10.40	3.4 ~ 14.4	2180	530 ~ 3580	4.77	A
2.0 + 3.5 + 5.0 + 7.1	17.6	1.18	2.07	2.95	4.20		10.40	3.4 ~ 14.4	2170	540 ~ 3560	4.79	A
2.0 + 3.5 + 6.0 + 6.0	17.5	1.19	2.07	3.57	3.57		10.40	3.4 ~ 14.4	2180	530 ~ 3580	4.77	A
2.0 + 4.2 + 4.2 + 4.2	14.6	1.43	2.99	2.99	2.99		10.40	3.4 ~ 14.4	2170	390 ~ 3710	4.79	A
2.0 + 4.2 + 4.2 + 5.0	15.4	1.35	2.84	2.84	3.37		10.40	3.4 ~ 14.4	2140	450 ~ 3630	4.86	A
2.0 + 4.2 + 4.2 + 6.0	16.4	1.27	2.66	2.66	3.81		10.40	3.4 ~ 14.4	2140	450 ~ 3630	4.86	A
2.0 + 4.2 + 4.2 + 7.1	17.5	1.19	2.50	2.50	4.21		10.40	3.4 ~ 14.4	2130	460 ~ 3610	4.88	A

	Indoor unit capacity Heating	Annual Energy Consumption (kWh)	Current 230V (A)	ERP				Moisture Removal Volume l/h
				Pdesign (kW)	SCOP		Annual Consumption (kWh)	
					WW	CLASS		
4 Room	2.0 + 2.0 + 2.5 + 2.5	1105	10.4	8.50	4.40	A+	2705	
	2.0 + 2.0 + 2.5 + 3.5	1095	10.3	8.50	4.40	A+	2705	
	2.0 + 2.0 + 2.5 + 4.2	1090	10.2	8.50	4.40	A+	2705	
	2.0 + 2.0 + 2.5 + 5.0	1070	10.1	8.50	4.40	A+	2705	
	2.0 + 2.0 + 2.5 + 6.0	1070	10.1	8.50	4.40	A+	2705	
	2.0 + 2.0 + 2.5 + 7.1	1065	10.0	8.50	4.40	A+	2705	
	2.0 + 2.0 + 3.5 + 3.5	1085	10.2	8.50	4.40	A+	2705	
	2.0 + 2.0 + 3.5 + 4.2	1080	10.2	8.50	4.40	A+	2705	
	2.0 + 2.0 + 3.5 + 5.0	1060	10.0	8.50	4.40	A+	2705	
	2.0 + 2.0 + 3.5 + 6.0	1060	10.0	8.50	4.40	A+	2705	
	2.0 + 2.0 + 3.5 + 7.1	1080	10.2	8.50	4.40	A+	2705	
	2.0 + 2.0 + 4.2 + 4.2	1095	10.3	8.50	4.40	A+	2705	
	2.0 + 2.0 + 4.2 + 5.0	1080	10.2	8.50	4.40	A+	2705	
	2.0 + 2.0 + 4.2 + 6.0	1080	10.2	8.50	4.40	A+	2705	
	2.0 + 2.0 + 4.2 + 7.1	1075	10.1	8.50	4.40	A+	2705	
	2.0 + 2.0 + 5.0 + 5.0	1075	10.1	8.50	4.40	A+	2705	
	2.0 + 2.0 + 5.0 + 6.0	1075	10.1	8.50	4.40	A+	2705	
	2.0 + 2.0 + 5.0 + 7.1	1090	10.2	8.50	4.40	A+	2705	
	2.0 + 2.0 + 6.0 + 6.0	1075	10.1	8.50	4.40	A+	2705	
	2.0 + 2.0 + 6.0 + 7.1	1090	10.2	8.50	4.40	A+	2705	
	2.0 + 2.0 + 7.1 + 7.1	1090	10.2	8.50	4.40	A+	2705	
	2.0 + 2.5 + 2.5 + 2.5	1105	10.4	8.50	4.40	A+	2705	
	2.0 + 2.5 + 2.5 + 3.5	1095	10.3	8.50	4.40	A+	2705	
	2.0 + 2.5 + 2.5 + 4.2	1090	10.2	8.50	4.40	A+	2705	
	2.0 + 2.5 + 2.5 + 5.0	1070	10.1	8.50	4.40	A+	2705	
	2.0 + 2.5 + 2.5 + 6.0	1070	10.1	8.50	4.40	A+	2705	
	2.0 + 2.5 + 2.5 + 7.1	1065	10.0	8.50	4.40	A+	2705	
	2.0 + 2.5 + 3.5 + 3.5	1085	10.2	8.50	4.40	A+	2705	
	2.0 + 2.5 + 3.5 + 4.2	1080	10.2	8.50	4.40	A+	2705	
	2.0 + 2.5 + 3.5 + 5.0	1060	10.0	8.50	4.40	A+	2705	
	2.0 + 2.5 + 3.5 + 6.0	1060	10.0	8.50	4.40	A+	2705	
	2.0 + 2.5 + 3.5 + 7.1	1080	10.2	8.50	4.40	A+	2705	
	2.0 + 2.5 + 4.2 + 4.2	1095	10.3	8.50	4.40	A+	2705	
	2.0 + 2.5 + 4.2 + 5.0	1080	10.2	8.50	4.40	A+	2705	
	2.0 + 2.5 + 4.2 + 6.0	1080	10.2	8.50	4.40	A+	2705	
	2.0 + 2.5 + 4.2 + 7.1	1075	10.1	8.50	4.40	A+	2705	
	2.0 + 2.5 + 5.0 + 5.0	1075	10.1	8.50	4.40	A+	2705	
	2.0 + 2.5 + 5.0 + 6.0	1075	10.1	8.50	4.40	A+	2705	
	2.0 + 2.5 + 5.0 + 7.1	1090	10.2	8.50	4.40	A+	2705	
	2.0 + 2.5 + 6.0 + 6.0	1075	10.1	8.50	4.40	A+	2705	
	2.0 + 2.5 + 6.0 + 7.1	1090	10.2	8.50	4.40	A+	2705	
	2.0 + 3.5 + 3.5 + 3.5	1095	10.3	8.50	4.40	A+	2705	
2.0 + 3.5 + 3.5 + 4.2	1090	10.2	8.50	4.40	A+	2705		
2.0 + 3.5 + 3.5 + 5.0	1075	10.1	8.50	4.40	A+	2705		
2.0 + 3.5 + 3.5 + 6.0	1075	10.1	8.50	4.40	A+	2705		
2.0 + 3.5 + 3.5 + 7.1	1070	10.1	8.50	4.40	A+	2705		
2.0 + 3.5 + 4.2 + 4.2	1085	10.2	8.50	4.40	A+	2705		
2.0 + 3.5 + 4.2 + 5.0	1075	10.1	8.50	4.40	A+	2705		
2.0 + 3.5 + 4.2 + 6.0	1075	10.1	8.50	4.40	A+	2705		
2.0 + 3.5 + 4.2 + 7.1	1070	10.1	8.50	4.40	A+	2705		
2.0 + 3.5 + 5.0 + 5.0	1090	10.2	8.50	4.40	A+	2705		
2.0 + 3.5 + 5.0 + 6.0	1090	10.2	8.50	4.40	A+	2705		
2.0 + 3.5 + 5.0 + 7.1	1085	10.2	8.50	4.40	A+	2705		
2.0 + 3.5 + 6.0 + 6.0	1090	10.2	8.50	4.40	A+	2705		
2.0 + 4.2 + 4.2 + 4.2	1085	10.2	8.50	4.40	A+	2705		
2.0 + 4.2 + 4.2 + 5.0	1070	10.1	8.50	4.40	A+	2705		
2.0 + 4.2 + 4.2 + 6.0	1070	10.1	8.50	4.40	A+	2705		
2.0 + 4.2 + 4.2 + 7.1	1065	10.0	8.50	4.40	A+	2705		

Indoor unit capacity Heating	Total	Heating Capacity (kW)							Input Power (W)		COP	
		Room A	Room B	Room C	Room D	Room E	Total	min ~ max	Rating	min ~ max	WW	CLASS
2.0 + 4.2 + 5.0 + 5.0	16.2	1.28	2.70	3.21	3.21		10.40	3.4 ~ 14.4	2170	540 ~ 3570	4.79	A
2.0 + 4.2 + 5.0 + 6.0	17.2	1.21	2.54	3.02	3.63		10.40	3.4 ~ 14.4	2170	540 ~ 3570	4.79	A
2.0 + 4.2 + 5.0 + 7.1	18.3	1.14	2.39	2.84	4.03		10.40	3.4 ~ 14.4	2170	550 ~ 3550	4.79	A
2.0 + 4.2 + 6.0 + 6.0	18.2	1.14	2.40	3.43	3.43		10.40	3.4 ~ 14.4	2170	540 ~ 3570	4.79	A
2.0 + 5.0 + 5.0 + 5.0	17.0	1.22	3.06	3.06	3.06		10.40	3.4 ~ 14.4	2260	630 ~ 3570	4.60	A
2.0 + 5.0 + 5.0 + 6.0	18.0	1.16	2.89	2.89	3.46		10.40	3.4 ~ 14.4	2260	630 ~ 3570	4.60	A
2.5 + 2.5 + 2.5 + 2.5	10.0	2.60	2.60	2.60	2.60		10.40	3.4 ~ 14.2	2210	340 ~ 3790	4.71	A
2.5 + 2.5 + 2.5 + 3.5	11.0	2.36	2.36	2.36	3.32		10.40	3.4 ~ 14.2	2190	350 ~ 3760	4.75	A
2.5 + 2.5 + 2.5 + 4.2	11.7	2.22	2.22	2.22	3.74		10.40	3.4 ~ 14.2	2180	360 ~ 3740	4.77	A
2.5 + 2.5 + 2.5 + 5.0	12.5	2.08	2.08	2.08	4.16		10.40	3.4 ~ 14.2	2140	420 ~ 3600	4.86	A
2.5 + 2.5 + 2.5 + 6.0	13.5	1.93	1.93	1.93	4.61		10.40	3.4 ~ 14.4	2140	420 ~ 3660	4.86	A
2.5 + 2.5 + 2.5 + 7.1	14.6	1.78	1.78	1.78	5.06		10.40	3.4 ~ 14.4	2130	420 ~ 3640	4.88	A
2.5 + 2.5 + 3.5 + 3.5	12.0	2.17	2.17	3.03	3.03		10.40	3.4 ~ 14.2	2170	370 ~ 3660	4.79	A
2.5 + 2.5 + 3.5 + 4.2	12.7	2.05	2.05	2.87	3.43		10.40	3.4 ~ 14.2	2160	370 ~ 3650	4.81	A
2.5 + 2.5 + 3.5 + 5.0	13.5	1.93	1.93	2.70	3.84		10.40	3.4 ~ 14.4	2120	420 ~ 3630	4.91	A
2.5 + 2.5 + 3.5 + 6.0	14.5	1.79	1.79	2.51	4.31		10.40	3.4 ~ 14.4	2120	420 ~ 3630	4.91	A
2.5 + 2.5 + 3.5 + 7.1	15.6	1.67	1.67	2.33	4.73		10.40	3.4 ~ 14.4	2160	430 ~ 3610	4.81	A
2.5 + 2.5 + 4.2 + 4.2	13.4	1.94	1.94	3.26	3.26		10.40	3.4 ~ 14.4	2190	370 ~ 3760	4.75	A
2.5 + 2.5 + 4.2 + 5.0	14.2	1.83	1.83	3.08	3.66		10.40	3.4 ~ 14.4	2160	430 ~ 3620	4.81	A
2.5 + 2.5 + 4.2 + 6.0	15.2	1.71	1.71	2.87	4.11		10.40	3.4 ~ 14.4	2160	430 ~ 3620	4.81	A
2.5 + 2.5 + 4.2 + 7.1	16.3	1.60	1.60	2.68	4.52		10.40	3.4 ~ 14.4	2150	440 ~ 3660	4.84	A
2.5 + 2.5 + 5.0 + 5.0	15.0	1.73	1.73	3.47	3.47		10.40	3.4 ~ 14.4	2150	510 ~ 3600	4.84	A
2.5 + 2.5 + 5.0 + 6.0	16.0	1.63	1.63	3.25	3.89		10.40	3.4 ~ 14.4	2150	510 ~ 3600	4.84	A
2.5 + 2.5 + 5.0 + 7.1	17.1	1.52	1.52	3.04	4.32		10.40	3.4 ~ 14.4	2180	520 ~ 3590	4.77	A
2.5 + 2.5 + 6.0 + 6.0	17.0	1.53	1.53	3.67	3.67		10.40	3.4 ~ 14.4	2150	510 ~ 3600	4.84	A
2.5 + 2.5 + 6.0 + 7.1	18.1	1.44	1.44	3.45	4.07		10.40	3.4 ~ 14.4	2180	520 ~ 3590	4.77	A
2.5 + 3.5 + 3.5 + 3.5	13.0	2.00	2.80	2.80	2.80		10.40	3.4 ~ 14.4	2190	370 ~ 3750	4.75	A
2.5 + 3.5 + 3.5 + 4.2	13.7	1.90	2.66	2.66	3.18		10.40	3.4 ~ 14.4	2180	370 ~ 3730	4.77	A
2.5 + 3.5 + 3.5 + 5.0	14.5	1.79	2.51	2.51	3.59		10.40	3.4 ~ 14.4	2150	450 ~ 3650	4.84	A
2.5 + 3.5 + 3.5 + 6.0	15.5	1.68	2.35	2.35	4.02		10.40	3.4 ~ 14.4	2150	450 ~ 3650	4.84	A
2.5 + 3.5 + 3.5 + 7.1	16.6	1.57	2.19	2.19	4.45		10.40	3.4 ~ 14.4	2140	450 ~ 3640	4.86	A
2.5 + 3.5 + 4.2 + 4.2	14.4	1.81	2.53	3.03	3.03		10.40	3.4 ~ 14.4	2170	390 ~ 3720	4.79	A
2.5 + 3.5 + 4.2 + 5.0	15.2	1.71	2.39	2.87	3.43		10.40	3.4 ~ 14.4	2150	450 ~ 3640	4.84	A
2.5 + 3.5 + 4.2 + 6.0	16.2	1.60	2.25	2.70	3.85		10.40	3.4 ~ 14.4	2150	450 ~ 3640	4.84	A
2.5 + 3.5 + 4.2 + 7.1	17.3	1.50	2.10	2.52	4.28		10.40	3.4 ~ 14.4	2140	460 ~ 3630	4.86	A
2.5 + 3.5 + 5.0 + 5.0	16.0	1.62	2.28	3.25	3.25		10.40	3.4 ~ 14.4	2180	530 ~ 3580	4.77	A
2.5 + 3.5 + 5.0 + 6.0	17.0	1.53	2.14	3.06	3.67		10.40	3.4 ~ 14.4	2180	530 ~ 3580	4.77	A
2.5 + 3.5 + 5.0 + 7.1	18.1	1.44	2.01	2.87	4.08		10.40	3.4 ~ 14.4	2170	540 ~ 3560	4.79	A
2.5 + 3.5 + 6.0 + 6.0	18.0	1.44	2.02	3.47	3.47		10.40	3.4 ~ 14.4	2180	530 ~ 3580	4.77	A
2.5 + 4.2 + 4.2 + 4.2	15.1	1.73	2.89	2.89	2.89		10.40	3.4 ~ 14.4	2170	390 ~ 3710	4.79	A
2.5 + 4.2 + 4.2 + 5.0	15.9	1.64	2.75	2.75	3.26		10.40	3.4 ~ 14.4	2140	450 ~ 3630	4.86	A
2.5 + 4.2 + 4.2 + 6.0	16.9	1.54	2.58	2.58	3.70		10.40	3.4 ~ 14.4	2140	450 ~ 3630	4.86	A
2.5 + 4.2 + 4.2 + 7.1	18.0	1.44	2.43	2.43	4.10		10.40	3.4 ~ 14.4	2130	460 ~ 3610	4.88	A
2.5 + 4.2 + 5.0 + 5.0	16.7	1.56	2.62	3.11	3.11		10.40	3.4 ~ 14.4	2170	540 ~ 3570	4.79	A
2.5 + 4.2 + 5.0 + 6.0	17.7	1.47	2.47	2.94	3.52		10.40	3.4 ~ 14.4	2170	540 ~ 3570	4.79	A
2.5 + 5.0 + 5.0 + 5.0	17.5	1.49	2.97	2.97	2.97		10.40	3.4 ~ 14.4	2260	630 ~ 3570	4.60	A
3.5 + 3.5 + 3.5 + 3.5	14.0	2.60	2.60	2.60	2.60		10.40	3.4 ~ 14.4	2170	390 ~ 3710	4.79	A
3.5 + 3.5 + 3.5 + 4.2	14.7	2.48	2.48	2.48	2.96		10.40	3.4 ~ 14.4	2160	390 ~ 3700	4.81	A
3.5 + 3.5 + 3.5 + 5.0	15.5	2.35	2.35	2.35	3.35		10.40	3.4 ~ 14.4	2140	460 ~ 3620	4.86	A
3.5 + 3.5 + 3.5 + 6.0	16.5	2.21	2.21	2.21	3.77		10.40	3.4 ~ 14.4	2140	460 ~ 3620	4.86	A
3.5 + 3.5 + 3.5 + 7.1	17.6	2.07	2.07	2.07	4.19		10.40	3.4 ~ 14.4	2130	470 ~ 3610	4.88	A
3.5 + 3.5 + 4.2 + 4.2	15.4	2.36	2.36	2.84	2.84		10.40	3.4 ~ 14.4	2160	400 ~ 3690	4.81	A
3.5 + 3.5 + 4.2 + 5.0	16.2	2.25	2.25	2.70	3.20		10.40	3.4 ~ 14.4	2130	470 ~ 3610	4.88	A
3.5 + 3.5 + 4.2 + 6.0	17.2	2.12	2.12	2.54	3.62		10.40	3.4 ~ 14.4	2130	470 ~ 3610	4.88	A
3.5 + 3.5 + 4.2 + 7.1	18.3	1.99	1.99	2.39	4.03		10.40	3.4 ~ 14.4	2170	480 ~ 3600	4.79	A
3.5 + 3.5 + 5.0 + 5.0	17.0	2.14	2.14	3.06	3.06		10.40	3.4 ~ 14.4	2170	550 ~ 3550	4.79	A
3.5 + 3.5 + 5.0 + 6.0	18.0	2.02	2.02	2.89	3.47		10.40	3.4 ~ 14.4	2170	550 ~ 3550	4.79	A
3.5 + 4.2 + 4.2 + 4.2	16.1	2.27	2.71	2.71	2.71		10.40	3.4 ~ 14.4	2150	400 ~ 3670	4.84	A

	Indoor unit capacity Heating	Annual Energy Consumption (kWh)	Current 230V (A)	ERP			Moisture Removal Volume l/h	
				Pdesign (kW)	SCOP			Annual Consumption (kWh)
					WW	CLASS		
4 Room	2.0 + 4.2 + 5.0 + 5.0	1085	10.2	8.50	4.40	A+	2705	
	2.0 + 4.2 + 5.0 + 6.0	1085	10.2	8.50	4.40	A+	2705	
	2.0 + 4.2 + 5.0 + 7.1	1085	10.2	8.50	4.40	A+	2705	
	2.0 + 4.2 + 6.0 + 6.0	1085	10.2	8.50	4.40	A+	2705	
	2.0 + 5.0 + 5.0 + 5.0	1130	10.6	8.50	4.40	A+	2705	
	2.0 + 5.0 + 5.0 + 6.0	1130	10.6	8.50	4.40	A+	2705	
	2.5 + 2.5 + 2.5 + 2.5	1105	10.4	8.50	4.40	A+	2705	
	2.5 + 2.5 + 2.5 + 3.5	1095	10.3	8.50	4.40	A+	2705	
	2.5 + 2.5 + 2.5 + 4.2	1090	10.2	8.50	4.40	A+	2705	
	2.5 + 2.5 + 2.5 + 5.0	1070	10.1	8.50	4.40	A+	2705	
	2.5 + 2.5 + 2.5 + 6.0	1070	10.1	8.50	4.40	A+	2705	
	2.5 + 2.5 + 2.5 + 7.1	1065	10.0	8.50	4.40	A+	2705	
	2.5 + 2.5 + 3.5 + 3.5	1085	10.2	8.50	4.40	A+	2705	
	2.5 + 2.5 + 3.5 + 4.2	1080	10.2	8.50	4.40	A+	2705	
	2.5 + 2.5 + 3.5 + 5.0	1060	10.0	8.50	4.40	A+	2705	
	2.5 + 2.5 + 3.5 + 6.0	1060	10.0	8.50	4.40	A+	2705	
	2.5 + 2.5 + 3.5 + 7.1	1080	10.2	8.50	4.40	A+	2705	
	2.5 + 2.5 + 4.2 + 4.2	1095	10.3	8.50	4.40	A+	2705	
	2.5 + 2.5 + 4.2 + 5.0	1080	10.2	8.50	4.40	A+	2705	
	2.5 + 2.5 + 4.2 + 6.0	1080	10.2	8.50	4.40	A+	2705	
	2.5 + 2.5 + 4.2 + 7.1	1075	10.1	8.50	4.40	A+	2705	
	2.5 + 2.5 + 5.0 + 5.0	1075	10.1	8.50	4.40	A+	2705	
	2.5 + 2.5 + 5.0 + 6.0	1075	10.1	8.50	4.40	A+	2705	
	2.5 + 2.5 + 5.0 + 7.1	1090	10.2	8.50	4.40	A+	2705	
	2.5 + 2.5 + 6.0 + 6.0	1075	10.1	8.50	4.40	A+	2705	
	2.5 + 2.5 + 6.0 + 7.1	1090	10.2	8.50	4.40	A+	2705	
	2.5 + 3.5 + 3.5 + 3.5	1095	10.3	8.50	4.40	A+	2705	
	2.5 + 3.5 + 3.5 + 4.2	1090	10.2	8.50	4.40	A+	2705	
	2.5 + 3.5 + 3.5 + 5.0	1075	10.1	8.50	4.40	A+	2705	
	2.5 + 3.5 + 3.5 + 6.0	1075	10.1	8.50	4.40	A+	2705	
	2.5 + 3.5 + 3.5 + 7.1	1070	10.1	8.50	4.40	A+	2705	
	2.5 + 3.5 + 4.2 + 4.2	1085	10.2	8.50	4.40	A+	2705	
	2.5 + 3.5 + 4.2 + 5.0	1075	10.1	8.50	4.40	A+	2705	
	2.5 + 3.5 + 4.2 + 6.0	1075	10.1	8.50	4.40	A+	2705	
	2.5 + 3.5 + 4.2 + 7.1	1070	10.1	8.50	4.40	A+	2705	
	2.5 + 3.5 + 5.0 + 5.0	1090	10.2	8.50	4.40	A+	2705	
	2.5 + 3.5 + 5.0 + 6.0	1090	10.2	8.50	4.40	A+	2705	
	2.5 + 3.5 + 5.0 + 7.1	1085	10.2	8.50	4.40	A+	2705	
	2.5 + 3.5 + 6.0 + 6.0	1090	10.2	8.50	4.40	A+	2705	
	2.5 + 4.2 + 4.2 + 4.2	1085	10.2	8.50	4.40	A+	2705	
2.5 + 4.2 + 4.2 + 5.0	1070	10.1	8.50	4.40	A+	2705		
2.5 + 4.2 + 4.2 + 6.0	1070	10.1	8.50	4.40	A+	2705		
2.5 + 4.2 + 4.2 + 7.1	1065	10.0	8.50	4.40	A+	2705		
2.5 + 4.2 + 5.0 + 5.0	1085	10.2	8.50	4.40	A+	2705		
2.5 + 4.2 + 5.0 + 6.0	1085	10.2	8.50	4.40	A+	2705		
2.5 + 5.0 + 5.0 + 5.0	1130	10.6	8.50	4.40	A+	2705		
3.5 + 3.5 + 3.5 + 3.5	1085	10.2	8.50	4.40	A+	2705		
3.5 + 3.5 + 3.5 + 4.2	1080	10.2	8.50	4.40	A+	2705		
3.5 + 3.5 + 3.5 + 5.0	1070	10.1	8.50	4.40	A+	2705		
3.5 + 3.5 + 3.5 + 6.0	1070	10.1	8.50	4.40	A+	2705		
3.5 + 3.5 + 3.5 + 7.1	1065	10.0	8.50	4.40	A+	2705		
3.5 + 3.5 + 4.2 + 4.2	1080	10.2	8.50	4.40	A+	2705		
3.5 + 3.5 + 4.2 + 5.0	1065	10.0	8.50	4.40	A+	2705		
3.5 + 3.5 + 4.2 + 6.0	1065	10.0	8.50	4.40	A+	2705		
3.5 + 3.5 + 4.2 + 7.1	1085	10.2	8.50	4.40	A+	2705		
3.5 + 3.5 + 5.0 + 5.0	1085	10.2	8.50	4.40	A+	2705		
3.5 + 3.5 + 5.0 + 6.0	1085	10.2	8.50	4.40	A+	2705		
3.5 + 4.2 + 4.2 + 4.2	1075	10.1	8.50	4.40	A+	2705		

Indoor unit capacity Heating		Total	Heating Capacity (kW)							Input Power (W)		COP	
			Room A	Room B	Room C	Room D	Room E	Total	min ~ max	Rating	min ~ max	WW	CLASS
4 Room	3.5 + 4.2 + 4.2 + 5.0	16.9	2.15	2.58	2.58	3.09		10.40	3.4 ~ 14.4	2170	480 ~ 3600	4.79	A
	3.5 + 4.2 + 4.2 + 6.0	17.9	2.03	2.44	2.44	3.49		10.40	3.4 ~ 14.4	2170	480 ~ 3600	4.79	A
	3.5 + 4.2 + 5.0 + 5.0	17.7	2.05	2.47	2.94	2.94		10.40	3.4 ~ 14.4	2200	560 ~ 3540	4.73	A
	4.2 + 4.2 + 4.2 + 4.2	16.8	2.60	2.60	2.60	2.60		10.40	3.4 ~ 14.4	2140	400 ~ 3660	4.86	A
	4.2 + 4.2 + 4.2 + 5.0	17.6	2.48	2.48	2.48	2.96		10.40	3.4 ~ 14.4	2160	480 ~ 3590	4.81	A

Indoor unit capacity Heating		Annual Energy Consumption (kWh)	Current 230V (A)	ERP				Moisture Removal Volume l/h
				Pdesign (kW)	SCOP		Annual Consumption (kWh)	
					WW	CLASS		
4 Room	3.5 + 4.2 + 4.2 + 5.0	1085	10.2	8.50	4.40	A+	2705	
	3.5 + 4.2 + 4.2 + 6.0	1085	10.2	8.50	4.40	A+	2705	
	3.5 + 4.2 + 5.0 + 5.0	1100	10.3	8.50	4.40	A+	2705	
	4.2 + 4.2 + 4.2 + 4.2	1070	10.1	8.50	4.40	A+	2705	
	4.2 + 4.2 + 4.2 + 5.0	1080	10.2	8.50	4.40	A+	2705	

Indoor unit capacity Heating	Total	Heating Capacity (kW)							Input Power (W)		COP	
		Room A	Room B	Room C	Room D	Room E	Total	min ~ max	Rating	min ~ max	WW	CLASS
1.6 + 1.6 + 1.6 + 1.6 + 1.6	8.0	2.08	2.08	2.08	2.08	2.08	10.40	3.4 ~ 14.5	2160	430 ~ 3670	4.81	A
1.6 + 1.6 + 1.6 + 1.6 + 2.0	8.4	1.98	1.98	1.98	1.98	2.48	10.40	3.4 ~ 14.5	2150	440 ~ 3660	4.84	A
1.6 + 1.6 + 1.6 + 1.6 + 2.5	8.9	1.87	1.87	1.87	1.87	2.92	10.40	3.4 ~ 14.5	2150	440 ~ 3660	4.84	A
1.6 + 1.6 + 1.6 + 1.6 + 3.5	9.9	1.68	1.68	1.68	1.68	3.68	10.40	3.4 ~ 14.5	2140	450 ~ 3630	4.86	A
1.6 + 1.6 + 1.6 + 1.6 + 4.2	10.6	1.57	1.57	1.57	1.57	4.12	10.40	3.4 ~ 14.5	2140	460 ~ 3670	4.86	A
1.6 + 1.6 + 1.6 + 1.6 + 5.0	11.4	1.46	1.46	1.46	1.46	4.56	10.40	3.4 ~ 14.5	2170	540 ~ 3610	4.79	A
1.6 + 1.6 + 1.6 + 1.6 + 6.0	12.4	1.34	1.34	1.34	1.34	5.04	10.40	3.4 ~ 14.5	2170	540 ~ 3610	4.79	A
1.6 + 1.6 + 1.6 + 1.6 + 7.1	13.5	1.23	1.23	1.23	1.23	5.48	10.40	3.4 ~ 14.5	2210	560 ~ 3600	4.71	A
1.6 + 1.6 + 1.6 + 2.0 + 2.0	8.8	1.89	1.89	1.89	2.36	2.36	10.39	3.4 ~ 14.5	2150	450 ~ 3650	4.83	A
1.6 + 1.6 + 1.6 + 2.0 + 2.5	9.3	1.79	1.79	1.79	2.24	2.79	10.40	3.4 ~ 14.5	2150	450 ~ 3650	4.84	A
1.6 + 1.6 + 1.6 + 2.0 + 3.5	10.3	1.62	1.62	1.62	2.02	3.52	10.40	3.4 ~ 14.5	2140	460 ~ 3670	4.86	A
1.6 + 1.6 + 1.6 + 2.0 + 4.2	11.0	1.51	1.51	1.51	1.89	3.98	10.40	3.4 ~ 14.5	2130	470 ~ 3660	4.88	A
1.6 + 1.6 + 1.6 + 2.0 + 5.0	11.8	1.41	1.41	1.41	1.76	4.41	10.40	3.4 ~ 14.5	2170	560 ~ 3600	4.79	A
1.6 + 1.6 + 1.6 + 2.0 + 6.0	12.8	1.30	1.30	1.30	1.63	4.87	10.40	3.4 ~ 14.5	2170	560 ~ 3600	4.79	A
1.6 + 1.6 + 1.6 + 2.0 + 7.1	13.9	1.20	1.20	1.20	1.50	5.30	10.40	3.4 ~ 14.5	2200	570 ~ 3590	4.73	A
1.6 + 1.6 + 1.6 + 2.5 + 2.5	9.8	1.70	1.70	1.70	2.65	2.65	10.40	3.4 ~ 14.5	2150	450 ~ 3650	4.84	A
1.6 + 1.6 + 1.6 + 2.5 + 3.5	10.8	1.54	1.54	1.54	2.41	3.37	10.40	3.4 ~ 14.5	2140	460 ~ 3670	4.86	A
1.6 + 1.6 + 1.6 + 2.5 + 4.2	11.5	1.45	1.45	1.45	2.26	3.79	10.40	3.4 ~ 14.5	2130	470 ~ 3660	4.88	A
1.6 + 1.6 + 1.6 + 2.5 + 5.0	12.3	1.35	1.35	1.35	2.11	4.24	10.40	3.4 ~ 14.5	2170	560 ~ 3600	4.79	A
1.6 + 1.6 + 1.6 + 2.5 + 6.0	13.3	1.25	1.25	1.25	1.95	4.70	10.40	3.4 ~ 14.5	2170	560 ~ 3600	4.79	A
1.6 + 1.6 + 1.6 + 2.5 + 7.1	14.4	1.16	1.16	1.16	1.81	5.11	10.40	3.4 ~ 14.5	2200	570 ~ 3590	4.73	A
1.6 + 1.6 + 1.6 + 3.5 + 3.5	11.8	1.41	1.41	1.41	3.08	3.08	10.39	3.4 ~ 14.5	2160	480 ~ 3640	4.81	A
1.6 + 1.6 + 1.6 + 3.5 + 4.2	12.5	1.33	1.33	1.33	2.91	3.50	10.40	3.4 ~ 14.5	2160	490 ~ 3630	4.81	A
1.6 + 1.6 + 1.6 + 3.5 + 5.0	13.3	1.25	1.25	1.25	2.74	3.91	10.40	3.4 ~ 14.5	2200	570 ~ 3630	4.73	A
1.6 + 1.6 + 1.6 + 3.5 + 6.0	14.3	1.16	1.16	1.16	2.55	4.37	10.40	3.4 ~ 14.5	2200	570 ~ 3630	4.73	A
1.6 + 1.6 + 1.6 + 3.5 + 7.1	15.4	1.08	1.08	1.08	2.36	4.80	10.40	3.4 ~ 14.5	2200	590 ~ 3620	4.73	A
1.6 + 1.6 + 1.6 + 4.2 + 4.2	13.2	1.26	1.26	1.26	3.31	3.31	10.40	3.4 ~ 14.5	2150	500 ~ 3620	4.84	A
1.6 + 1.6 + 1.6 + 4.2 + 5.0	14.0	1.19	1.19	1.19	3.12	3.71	10.40	3.4 ~ 14.5	2200	590 ~ 3620	4.73	A
1.6 + 1.6 + 1.6 + 4.2 + 6.0	15.0	1.11	1.11	1.11	2.91	4.16	10.40	3.4 ~ 14.5	2200	590 ~ 3620	4.73	A
1.6 + 1.6 + 1.6 + 4.2 + 7.1	16.1	1.03	1.03	1.03	2.71	4.60	10.40	3.4 ~ 14.5	2230	600 ~ 3610	4.66	A
1.6 + 1.6 + 1.6 + 5.0 + 5.0	14.8	1.12	1.12	1.12	3.52	3.52	10.40	3.4 ~ 14.5	2290	690 ~ 3630	4.54	A
1.6 + 1.6 + 1.6 + 5.0 + 6.0	15.8	1.05	1.05	1.05	3.29	3.96	10.40	3.4 ~ 14.5	2290	690 ~ 3630	4.54	A
1.6 + 1.6 + 1.6 + 5.0 + 7.1	16.9	0.98	0.98	0.98	3.08	4.38	10.40	3.4 ~ 14.5	2290	710 ~ 3620	4.54	A
1.6 + 1.6 + 1.6 + 6.0 + 6.0	16.8	0.99	0.99	0.99	3.71	3.71	10.39	3.4 ~ 14.5	2290	690 ~ 3630	4.54	A
1.6 + 1.6 + 1.6 + 6.0 + 7.1	17.9	0.93	0.93	0.93	3.49	4.12	10.40	3.4 ~ 14.5	2290	710 ~ 3620	4.54	A
1.6 + 1.6 + 2.0 + 2.0 + 2.0	9.2	1.81	1.81	2.26	2.26	2.26	10.40	3.4 ~ 14.5	2140	450 ~ 3640	4.86	A
1.6 + 1.6 + 2.0 + 2.0 + 2.5	9.7	1.72	1.72	2.14	2.14	2.68	10.40	3.4 ~ 14.5	2140	450 ~ 3640	4.86	A
1.6 + 1.6 + 2.0 + 2.0 + 3.5	10.7	1.56	1.56	1.94	1.94	3.40	10.40	3.4 ~ 14.5	2130	470 ~ 3660	4.88	A
1.6 + 1.6 + 2.0 + 2.0 + 4.2	11.4	1.46	1.46	1.82	1.82	3.84	10.40	3.4 ~ 14.5	2170	480 ~ 3650	4.79	A
1.6 + 1.6 + 2.0 + 2.0 + 5.0	12.2	1.36	1.36	1.70	1.70	4.28	10.40	3.4 ~ 14.5	2200	560 ~ 3590	4.73	A
1.6 + 1.6 + 2.0 + 2.0 + 6.0	13.2	1.26	1.26	1.58	1.58	4.72	10.40	3.4 ~ 14.5	2200	560 ~ 3590	4.73	A
1.6 + 1.6 + 2.0 + 2.0 + 7.1	14.3	1.16	1.16	1.45	1.45	5.18	10.40	3.4 ~ 14.5	2200	570 ~ 3580	4.73	A
1.6 + 1.6 + 2.0 + 2.5 + 2.5	10.2	1.63	1.63	2.04	2.55	2.55	10.40	3.4 ~ 14.5	2140	450 ~ 3640	4.86	A
1.6 + 1.6 + 2.0 + 2.5 + 3.5	11.2	1.49	1.49	1.86	2.32	3.24	10.40	3.4 ~ 14.5	2130	470 ~ 3660	4.88	A
1.6 + 1.6 + 2.0 + 2.5 + 4.2	11.9	1.40	1.40	1.75	2.18	3.67	10.40	3.4 ~ 14.5	2170	480 ~ 3650	4.79	A
1.6 + 1.6 + 2.0 + 2.5 + 5.0	12.7	1.31	1.31	1.64	2.05	4.09	10.40	3.4 ~ 14.5	2200	560 ~ 3590	4.73	A
1.6 + 1.6 + 2.0 + 2.5 + 6.0	13.7	1.21	1.21	1.52	1.90	4.56	10.40	3.4 ~ 14.5	2200	560 ~ 3590	4.73	A
1.6 + 1.6 + 2.0 + 2.5 + 7.1	14.8	1.12	1.12	1.41	1.76	4.99	10.40	3.4 ~ 14.5	2200	570 ~ 3580	4.73	A
1.6 + 1.6 + 2.0 + 3.5 + 3.5	12.2	1.36	1.36	1.72	2.98	2.98	10.40	3.4 ~ 14.5	2160	490 ~ 3630	4.81	A
1.6 + 1.6 + 2.0 + 3.5 + 4.2	12.9	1.29	1.29	1.61	2.82	3.39	10.40	3.4 ~ 14.5	2150	500 ~ 3620	4.84	A
1.6 + 1.6 + 2.0 + 3.5 + 5.0	13.7	1.21	1.21	1.52	2.66	3.80	10.40	3.4 ~ 14.5	2200	590 ~ 3620	4.73	A
1.6 + 1.6 + 2.0 + 3.5 + 6.0	14.7	1.13	1.13	1.41	2.48	4.25	10.40	3.4 ~ 14.5	2200	590 ~ 3620	4.73	A
1.6 + 1.6 + 2.0 + 3.5 + 7.1	15.8	1.05	1.05	1.32	2.30	4.68	10.40	3.4 ~ 14.5	2230	600 ~ 3610	4.66	A
1.6 + 1.6 + 2.0 + 4.2 + 4.2	13.6	1.22	1.22	1.54	3.21	3.21	10.40	3.4 ~ 14.5	2150	510 ~ 3610	4.84	A
1.6 + 1.6 + 2.0 + 4.2 + 5.0	14.4	1.16	1.16	1.44	3.03	3.61	10.40	3.4 ~ 14.5	2190	600 ~ 3610	4.75	A
1.6 + 1.6 + 2.0 + 4.2 + 6.0	15.4	1.08	1.08	1.35	2.84	4.05	10.40	3.4 ~ 14.5	2190	600 ~ 3610	4.75	A
1.6 + 1.6 + 2.0 + 4.2 + 7.1	16.5	1.01	1.01	1.26	2.65	4.47	10.40	3.4 ~ 14.5	2230	600 ~ 3600	4.66	A
1.6 + 1.6 + 2.0 + 5.0 + 5.0	15.2	1.09	1.09	1.38	3.42	3.42	10.40	3.4 ~ 14.5	2290	700 ~ 3620	4.54	A

5 Room



	Indoor unit capacity Heating	Annual Energy Consumption (kWh)	Current 230V (A)	ERP				Moisture Removal Volume l/h
				Pdesign (kW)	SCOP		Annual Consumption (KWh)	
					W/W	CLASS		
5 Room	1.6 + 1.6 + 1.6 + 1.6 + 1.6	1080	10.2	8.50	4.40	A+	2705	
	1.6 + 1.6 + 1.6 + 1.6 + 2.0	1075	10.1	8.50	4.50	A+	2644	
	1.6 + 1.6 + 1.6 + 1.6 + 2.5	1075	10.1	8.50	4.68	A++	2543	
	1.6 + 1.6 + 1.6 + 1.6 + 3.5	1070	10.1	8.50	4.68	A++	2543	
	1.6 + 1.6 + 1.6 + 1.6 + 4.2	1070	10.1	8.50	4.68	A++	2543	
	1.6 + 1.6 + 1.6 + 1.6 + 5.0	1085	10.2	8.50	4.68	A++	2543	
	1.6 + 1.6 + 1.6 + 1.6 + 6.0	1085	10.2	8.50	4.68	A++	2543	
	1.6 + 1.6 + 1.6 + 1.6 + 7.1	1105	10.4	8.50	4.68	A++	2543	
	1.6 + 1.6 + 1.6 + 2.0 + 2.0	1075	10.1	8.50	4.60	A++	2587	
	1.6 + 1.6 + 1.6 + 2.0 + 2.5	1075	10.1	8.50	4.68	A++	2543	
	1.6 + 1.6 + 1.6 + 2.0 + 3.5	1070	10.1	8.50	4.68	A++	2543	
	1.6 + 1.6 + 1.6 + 2.0 + 4.2	1065	10.0	8.50	4.68	A++	2543	
	1.6 + 1.6 + 1.6 + 2.0 + 5.0	1085	10.2	8.50	4.68	A++	2543	
	1.6 + 1.6 + 1.6 + 2.0 + 6.0	1085	10.2	8.50	4.68	A++	2543	
	1.6 + 1.6 + 1.6 + 2.0 + 7.1	1100	10.3	8.50	4.68	A++	2543	
	1.6 + 1.6 + 1.6 + 2.5 + 2.5	1075	10.1	8.50	4.68	A++	2543	
	1.6 + 1.6 + 1.6 + 2.5 + 3.5	1070	10.1	8.50	4.68	A++	2543	
	1.6 + 1.6 + 1.6 + 2.5 + 4.2	1065	10.0	8.50	4.68	A++	2543	
	1.6 + 1.6 + 1.6 + 2.5 + 5.0	1085	10.2	8.50	4.68	A++	2543	
	1.6 + 1.6 + 1.6 + 2.5 + 6.0	1085	10.2	8.50	4.68	A++	2543	
	1.6 + 1.6 + 1.6 + 2.5 + 7.1	1100	10.3	8.50	4.68	A++	2543	
	1.6 + 1.6 + 1.6 + 3.5 + 3.5	1080	10.2	8.50	4.68	A++	2543	
	1.6 + 1.6 + 1.6 + 3.5 + 4.2	1080	10.2	8.50	4.68	A++	2543	
	1.6 + 1.6 + 1.6 + 3.5 + 5.0	1100	10.3	8.50	4.68	A++	2543	
	1.6 + 1.6 + 1.6 + 3.5 + 6.0	1100	10.3	8.50	4.68	A++	2543	
	1.6 + 1.6 + 1.6 + 3.5 + 7.1	1100	10.3	8.50	4.68	A++	2543	
	1.6 + 1.6 + 1.6 + 4.2 + 4.2	1075	10.1	8.50	4.68	A++	2543	
	1.6 + 1.6 + 1.6 + 4.2 + 5.0	1100	10.3	8.50	4.68	A++	2543	
	1.6 + 1.6 + 1.6 + 4.2 + 6.0	1100	10.3	8.50	4.68	A++	2543	
	1.6 + 1.6 + 1.6 + 4.2 + 7.1	1115	10.5	8.50	4.68	A++	2543	
	1.6 + 1.6 + 1.6 + 5.0 + 5.0	1145	10.8	8.50	4.68	A++	2543	
	1.6 + 1.6 + 1.6 + 5.0 + 6.0	1145	10.8	8.50	4.68	A++	2543	
	1.6 + 1.6 + 1.6 + 5.0 + 7.1	1145	10.8	8.50	4.68	A++	2543	
	1.6 + 1.6 + 1.6 + 6.0 + 6.0	1145	10.8	8.50	4.68	A++	2543	
	1.6 + 1.6 + 1.6 + 6.0 + 7.1	1145	10.8	8.50	4.68	A++	2543	
	1.6 + 1.6 + 2.0 + 2.0 + 2.0	1070	10.1	8.50	4.68	A++	2543	
	1.6 + 1.6 + 2.0 + 2.0 + 2.5	1070	10.1	8.50	4.68	A++	2543	
	1.6 + 1.6 + 2.0 + 2.0 + 3.5	1065	10.0	8.50	4.68	A++	2543	
	1.6 + 1.6 + 2.0 + 2.0 + 4.2	1085	10.2	8.50	4.68	A++	2543	
	1.6 + 1.6 + 2.0 + 2.0 + 5.0	1100	10.3	8.50	4.68	A++	2543	
1.6 + 1.6 + 2.0 + 2.0 + 6.0	1100	10.3	8.50	4.68	A++	2543		
1.6 + 1.6 + 2.0 + 2.0 + 7.1	1100	10.3	8.50	4.68	A++	2543		
1.6 + 1.6 + 2.0 + 2.5 + 2.5	1070	10.1	8.50	4.68	A++	2543		
1.6 + 1.6 + 2.0 + 2.5 + 3.5	1065	10.0	8.50	4.68	A++	2543		
1.6 + 1.6 + 2.0 + 2.5 + 4.2	1085	10.2	8.50	4.68	A++	2543		
1.6 + 1.6 + 2.0 + 2.5 + 5.0	1100	10.3	8.50	4.68	A++	2543		
1.6 + 1.6 + 2.0 + 2.5 + 6.0	1100	10.3	8.50	4.68	A++	2543		
1.6 + 1.6 + 2.0 + 2.5 + 7.1	1100	10.3	8.50	4.68	A++	2543		
1.6 + 1.6 + 2.0 + 3.5 + 3.5	1080	10.2	8.50	4.68	A++	2543		
1.6 + 1.6 + 2.0 + 3.5 + 4.2	1075	10.1	8.50	4.68	A++	2543		
1.6 + 1.6 + 2.0 + 3.5 + 5.0	1100	10.3	8.50	4.68	A++	2543		
1.6 + 1.6 + 2.0 + 3.5 + 6.0	1100	10.3	8.50	4.68	A++	2543		
1.6 + 1.6 + 2.0 + 3.5 + 7.1	1115	10.5	8.50	4.68	A++	2543		
1.6 + 1.6 + 2.0 + 4.2 + 4.2	1075	10.1	8.50	4.68	A++	2543		
1.6 + 1.6 + 2.0 + 4.2 + 5.0	1095	10.3	8.50	4.68	A++	2543		
1.6 + 1.6 + 2.0 + 4.2 + 6.0	1095	10.3	8.50	4.68	A++	2543		
1.6 + 1.6 + 2.0 + 4.2 + 7.1	1115	10.5	8.50	4.68	A++	2543		
1.6 + 1.6 + 2.0 + 5.0 + 5.0	1145	10.8	8.50	4.68	A++	2543		

Indoor unit capacity Heating	Total	Heating Capacity (kW)							Input Power (W)		COP	
		Room A	Room B	Room C	Room D	Room E	Total	min ~ max	Rating	min ~ max	WW	CLASS
1.6 + 1.6 + 2.0 + 5.0 + 6.0	16.2	1.03	1.03	1.28	3.21	3.85	10.40	3.4 ~ 14.5	2290	700 ~ 3620	4.54	A
1.6 + 1.6 + 2.0 + 5.0 + 7.1	17.3	0.96	0.96	1.20	3.01	4.27	10.40	3.4 ~ 14.5	2330	710 ~ 3660	4.46	A
1.6 + 1.6 + 2.0 + 6.0 + 6.0	17.2	0.97	0.97	1.20	3.63	3.63	10.40	3.4 ~ 14.5	2290	700 ~ 3620	4.54	A
1.6 + 1.6 + 2.0 + 6.0 + 7.1	18.3	0.91	0.91	1.14	3.41	4.03	10.40	3.4 ~ 14.5	2330	710 ~ 3660	4.46	A
1.6 + 1.6 + 2.5 + 2.5 + 2.5	10.7	1.55	1.55	2.43	2.43	2.43	10.39	3.4 ~ 14.5	2140	450 ~ 3640	4.86	A
1.6 + 1.6 + 2.5 + 2.5 + 3.5	11.7	1.42	1.42	2.22	2.22	3.12	10.40	3.4 ~ 14.5	2130	470 ~ 3660	4.88	A
1.6 + 1.6 + 2.5 + 2.5 + 4.2	12.4	1.34	1.34	2.10	2.10	3.52	10.40	3.4 ~ 14.5	2170	480 ~ 3650	4.79	A
1.6 + 1.6 + 2.5 + 2.5 + 5.0	13.2	1.26	1.26	1.97	1.97	3.94	10.40	3.4 ~ 14.5	2200	560 ~ 3590	4.73	A
1.6 + 1.6 + 2.5 + 2.5 + 6.0	14.2	1.17	1.17	1.83	1.83	4.40	10.40	3.4 ~ 14.5	2200	560 ~ 3590	4.73	A
1.6 + 1.6 + 2.5 + 2.5 + 7.1	15.3	1.09	1.09	1.70	1.70	4.82	10.40	3.4 ~ 14.5	2200	570 ~ 3580	4.73	A
1.6 + 1.6 + 2.5 + 3.5 + 3.5	12.7	1.31	1.31	2.04	2.87	2.87	10.40	3.4 ~ 14.5	2160	490 ~ 3630	4.81	A
1.6 + 1.6 + 2.5 + 3.5 + 4.2	13.4	1.24	1.24	1.94	2.72	3.26	10.40	3.4 ~ 14.5	2150	500 ~ 3620	4.84	A
1.6 + 1.6 + 2.5 + 3.5 + 5.0	14.2	1.17	1.17	1.83	2.56	3.67	10.40	3.4 ~ 14.5	2200	590 ~ 3620	4.73	A
1.6 + 1.6 + 2.5 + 3.5 + 6.0	15.2	1.09	1.09	1.71	2.39	4.12	10.40	3.4 ~ 14.5	2200	590 ~ 3620	4.73	A
1.6 + 1.6 + 2.5 + 3.5 + 7.1	16.3	1.02	1.02	1.60	2.23	4.53	10.40	3.4 ~ 14.5	2230	600 ~ 3610	4.66	A
1.6 + 1.6 + 2.5 + 4.2 + 4.2	14.1	1.18	1.18	1.84	3.10	3.10	10.40	3.4 ~ 14.5	2150	510 ~ 3610	4.84	A
1.6 + 1.6 + 2.5 + 4.2 + 5.0	14.9	1.12	1.12	1.74	2.93	3.49	10.40	3.4 ~ 14.5	2190	600 ~ 3610	4.75	A
1.6 + 1.6 + 2.5 + 4.2 + 6.0	15.9	1.05	1.05	1.64	2.75	3.91	10.40	3.4 ~ 14.5	2190	600 ~ 3610	4.75	A
1.6 + 1.6 + 2.5 + 4.2 + 7.1	17.0	0.98	0.98	1.53	2.57	4.34	10.40	3.4 ~ 14.5	2230	600 ~ 3600	4.66	A
1.6 + 1.6 + 2.5 + 5.0 + 5.0	15.7	1.06	1.06	1.66	3.31	3.31	10.40	3.4 ~ 14.5	2290	700 ~ 3620	4.54	A
1.6 + 1.6 + 2.5 + 5.0 + 6.0	16.7	1.00	1.00	1.56	3.11	3.73	10.40	3.4 ~ 14.5	2290	700 ~ 3620	4.54	A
1.6 + 1.6 + 2.5 + 5.0 + 7.1	17.8	0.93	0.93	1.46	2.92	4.16	10.40	3.4 ~ 14.5	2330	710 ~ 3660	4.46	A
1.6 + 1.6 + 2.5 + 6.0 + 6.0	17.7	0.94	0.94	1.46	3.53	3.53	10.40	3.4 ~ 14.5	2290	700 ~ 3620	4.54	A
1.6 + 1.6 + 3.5 + 3.5 + 3.5	13.7	1.21	1.21	2.66	2.66	2.66	10.40	3.4 ~ 14.5	2150	510 ~ 3600	4.84	A
1.6 + 1.6 + 3.5 + 3.5 + 4.2	14.4	1.16	1.16	2.53	2.53	3.02	10.40	3.4 ~ 14.5	2180	510 ~ 3590	4.77	A
1.6 + 1.6 + 3.5 + 3.5 + 5.0	15.2	1.09	1.09	2.39	2.39	3.44	10.40	3.4 ~ 14.5	2230	610 ~ 3590	4.66	A
1.6 + 1.6 + 3.5 + 3.5 + 6.0	16.2	1.03	1.03	2.25	2.25	3.84	10.40	3.4 ~ 14.5	2230	610 ~ 3590	4.66	A
1.6 + 1.6 + 3.5 + 3.5 + 7.1	17.3	0.96	0.96	2.10	2.10	4.28	10.40	3.4 ~ 14.5	2230	620 ~ 3580	4.66	A
1.6 + 1.6 + 3.5 + 4.2 + 4.2	15.1	1.10	1.10	2.42	2.89	2.89	10.40	3.4 ~ 14.5	2180	520 ~ 3640	4.77	A
1.6 + 1.6 + 3.5 + 4.2 + 5.0	15.9	1.05	1.05	2.29	2.75	3.26	10.40	3.4 ~ 14.5	2230	620 ~ 3590	4.66	A
1.6 + 1.6 + 3.5 + 4.2 + 6.0	16.9	0.98	0.98	2.15	2.58	3.71	10.40	3.4 ~ 14.5	2230	620 ~ 3590	4.66	A
1.6 + 1.6 + 3.5 + 4.2 + 7.1	18.0	0.92	0.92	2.02	2.43	4.11	10.40	3.4 ~ 14.5	2220	630 ~ 3630	4.68	A
1.6 + 1.6 + 3.5 + 5.0 + 5.0	16.7	1.00	1.00	2.18	3.11	3.11	10.40	3.4 ~ 14.5	2330	720 ~ 3650	4.46	A
1.6 + 1.6 + 3.5 + 5.0 + 6.0	17.7	0.94	0.94	2.06	2.94	3.52	10.40	3.4 ~ 14.5	2330	720 ~ 3650	4.46	A
1.6 + 1.6 + 4.2 + 4.2 + 4.2	15.8	1.06	1.06	2.76	2.76	2.76	10.40	3.4 ~ 14.5	2180	530 ~ 3630	4.77	A
1.6 + 1.6 + 4.2 + 4.2 + 5.0	16.6	1.00	1.00	2.63	2.63	3.14	10.40	3.4 ~ 14.5	2230	630 ~ 3630	4.66	A
1.6 + 1.6 + 4.2 + 4.2 + 6.0	17.6	0.95	0.95	2.48	2.48	3.54	10.40	3.4 ~ 14.5	2230	630 ~ 3630	4.66	A
1.6 + 1.6 + 4.2 + 5.0 + 5.0	17.4	0.96	0.96	2.50	2.99	2.99	10.40	3.4 ~ 14.5	2330	740 ~ 3650	4.46	A
1.6 + 1.6 + 5.0 + 5.0 + 5.0	18.2	0.91	0.91	2.86	2.86	2.86	10.40	3.4 ~ 14.5	2480	860 ~ 3730	4.19	A
1.6 + 2.0 + 2.0 + 2.0 + 2.0	9.6	1.72	2.17	2.17	2.17	2.17	10.40	3.4 ~ 14.5	2140	460 ~ 3680	4.86	A
1.6 + 2.0 + 2.0 + 2.0 + 2.5	10.1	1.65	2.06	2.06	2.06	2.57	10.40	3.4 ~ 14.5	2140	460 ~ 3680	4.86	A
1.6 + 2.0 + 2.0 + 2.0 + 3.5	11.1	1.50	1.87	1.87	1.87	3.29	10.40	3.4 ~ 14.5	2170	480 ~ 3650	4.79	A
1.6 + 2.0 + 2.0 + 2.0 + 4.2	11.8	1.41	1.76	1.76	1.76	3.71	10.40	3.4 ~ 14.5	2160	480 ~ 3640	4.81	A
1.6 + 2.0 + 2.0 + 2.0 + 5.0	12.6	1.32	1.65	1.65	1.65	4.13	10.40	3.4 ~ 14.5	2200	570 ~ 3580	4.73	A
1.6 + 2.0 + 2.0 + 2.0 + 6.0	13.6	1.22	1.53	1.53	1.53	4.59	10.40	3.4 ~ 14.5	2200	570 ~ 3580	4.73	A
1.6 + 2.0 + 2.0 + 2.0 + 7.1	14.7	1.13	1.41	1.41	1.41	5.04	10.40	3.4 ~ 14.5	2200	580 ~ 3620	4.73	A
1.6 + 2.0 + 2.0 + 2.5 + 2.5	10.6	1.58	1.96	1.96	2.45	2.45	10.40	3.4 ~ 14.5	2140	460 ~ 3680	4.86	A
1.6 + 2.0 + 2.0 + 2.5 + 3.5	11.6	1.43	1.79	1.79	2.24	3.15	10.40	3.4 ~ 14.5	2170	480 ~ 3650	4.79	A
1.6 + 2.0 + 2.0 + 2.5 + 4.2	12.3	1.35	1.69	1.69	2.11	3.56	10.40	3.4 ~ 14.5	2160	480 ~ 3640	4.81	A
1.6 + 2.0 + 2.0 + 2.5 + 5.0	13.1	1.27	1.59	1.59	1.98	3.97	10.40	3.4 ~ 14.5	2200	570 ~ 3580	4.73	A
1.6 + 2.0 + 2.0 + 2.5 + 6.0	14.1	1.18	1.48	1.48	1.84	4.42	10.40	3.4 ~ 14.5	2200	570 ~ 3580	4.73	A
1.6 + 2.0 + 2.0 + 2.5 + 7.1	15.2	1.09	1.37	1.37	1.71	4.86	10.40	3.4 ~ 14.5	2200	580 ~ 3620	4.73	A
1.6 + 2.0 + 2.0 + 3.5 + 3.5	12.6	1.32	1.65	1.65	2.89	2.89	10.40	3.4 ~ 14.5	2150	500 ~ 3620	4.84	A
1.6 + 2.0 + 2.0 + 3.5 + 4.2	13.3	1.25	1.56	1.56	2.74	3.29	10.40	3.4 ~ 14.5	2150	510 ~ 3610	4.84	A
1.6 + 2.0 + 2.0 + 3.5 + 5.0	14.1	1.18	1.48	1.48	2.58	3.68	10.40	3.4 ~ 14.5	2190	600 ~ 3610	4.75	A
1.6 + 2.0 + 2.0 + 3.5 + 6.0	15.1	1.10	1.38	1.38	2.41	4.13	10.40	3.4 ~ 14.5	2190	600 ~ 3610	4.75	A
1.6 + 2.0 + 2.0 + 3.5 + 7.1	16.2	1.03	1.28	1.28	2.25	4.56	10.40	3.4 ~ 14.5	2230	600 ~ 3600	4.66	A
1.6 + 2.0 + 2.0 + 4.2 + 4.2	14.0	1.18	1.49	1.49	3.12	3.12	10.40	3.4 ~ 14.5	2150	510 ~ 3600	4.84	A

5 Room

	Indoor unit capacity Heating	Annual Energy Consumption (kWh)	Current 230V (A)	ERP				Moisture Removal Volume l/h
				Pdesign (kW)	SCOP		Annual Consumption (kWh)	
					W/W	CLASS		
5 Room	1.6 + 1.6 + 2.0 + 5.0 + 6.0	1145	10.8	8.50	4.68	A++	2543	
	1.6 + 1.6 + 2.0 + 5.0 + 7.1	1165	10.9	8.50	4.68	A++	2543	
	1.6 + 1.6 + 2.0 + 6.0 + 6.0	1145	10.8	8.50	4.68	A++	2543	
	1.6 + 1.6 + 2.0 + 6.0 + 7.1	1165	10.9	8.50	4.68	A++	2543	
	1.6 + 1.6 + 2.5 + 2.5 + 2.5	1070	10.1	8.50	4.68	A++	2543	
	1.6 + 1.6 + 2.5 + 2.5 + 3.5	1065	10.0	8.50	4.68	A++	2543	
	1.6 + 1.6 + 2.5 + 2.5 + 4.2	1085	10.2	8.50	4.68	A++	2543	
	1.6 + 1.6 + 2.5 + 2.5 + 5.0	1100	10.3	8.50	4.68	A++	2543	
	1.6 + 1.6 + 2.5 + 2.5 + 6.0	1100	10.3	8.50	4.68	A++	2543	
	1.6 + 1.6 + 2.5 + 2.5 + 7.1	1100	10.3	8.50	4.68	A++	2543	
	1.6 + 1.6 + 2.5 + 3.5 + 3.5	1080	10.2	8.50	4.68	A++	2543	
	1.6 + 1.6 + 2.5 + 3.5 + 4.2	1075	10.1	8.50	4.68	A++	2543	
	1.6 + 1.6 + 2.5 + 3.5 + 5.0	1100	10.3	8.50	4.68	A++	2543	
	1.6 + 1.6 + 2.5 + 3.5 + 6.0	1100	10.3	8.50	4.68	A++	2543	
	1.6 + 1.6 + 2.5 + 3.5 + 7.1	1115	10.5	8.50	4.68	A++	2543	
	1.6 + 1.6 + 2.5 + 4.2 + 4.2	1075	10.1	8.50	4.68	A++	2543	
	1.6 + 1.6 + 2.5 + 4.2 + 5.0	1095	10.3	8.50	4.68	A++	2543	
	1.6 + 1.6 + 2.5 + 4.2 + 6.0	1095	10.3	8.50	4.68	A++	2543	
	1.6 + 1.6 + 2.5 + 4.2 + 7.1	1115	10.5	8.50	4.68	A++	2543	
	1.6 + 1.6 + 2.5 + 5.0 + 5.0	1145	10.8	8.50	4.68	A++	2543	
	1.6 + 1.6 + 2.5 + 5.0 + 6.0	1145	10.8	8.50	4.68	A++	2543	
	1.6 + 1.6 + 2.5 + 5.0 + 7.1	1165	10.9	8.50	4.68	A++	2543	
	1.6 + 1.6 + 2.5 + 6.0 + 6.0	1145	10.8	8.50	4.68	A++	2543	
	1.6 + 1.6 + 3.5 + 3.5 + 3.5	1075	10.1	8.50	4.68	A++	2543	
	1.6 + 1.6 + 3.5 + 3.5 + 4.2	1090	10.2	8.50	4.68	A++	2543	
	1.6 + 1.6 + 3.5 + 3.5 + 5.0	1115	10.5	8.50	4.68	A++	2543	
	1.6 + 1.6 + 3.5 + 3.5 + 6.0	1115	10.5	8.50	4.68	A++	2543	
	1.6 + 1.6 + 3.5 + 3.5 + 7.1	1115	10.5	8.50	4.68	A++	2543	
	1.6 + 1.6 + 3.5 + 4.2 + 4.2	1090	10.2	8.50	4.68	A++	2543	
	1.6 + 1.6 + 3.5 + 4.2 + 5.0	1115	10.5	8.50	4.68	A++	2543	
	1.6 + 1.6 + 3.5 + 4.2 + 6.0	1115	10.5	8.50	4.68	A++	2543	
	1.6 + 1.6 + 3.5 + 4.2 + 7.1	1110	10.4	8.50	4.68	A++	2543	
	1.6 + 1.6 + 3.5 + 5.0 + 5.0	1165	10.9	8.50	4.68	A++	2543	
	1.6 + 1.6 + 3.5 + 5.0 + 6.0	1165	10.9	8.50	4.68	A++	2543	
	1.6 + 1.6 + 4.2 + 4.2 + 4.2	1090	10.2	8.50	4.68	A++	2543	
	1.6 + 1.6 + 4.2 + 4.2 + 5.0	1115	10.5	8.50	4.68	A++	2543	
	1.6 + 1.6 + 4.2 + 4.2 + 6.0	1115	10.5	8.50	4.68	A++	2543	
	1.6 + 1.6 + 4.2 + 5.0 + 5.0	1165	10.9	8.50	4.68	A++	2543	
	1.6 + 1.6 + 5.0 + 5.0 + 5.0	1240	11.7	8.50	4.68	A++	2543	
	1.6 + 2.0 + 2.0 + 2.0 + 2.0	1070	10.1	8.50	4.68	A++	2543	
1.6 + 2.0 + 2.0 + 2.0 + 2.5	1070	10.1	8.50	4.68	A++	2543		
1.6 + 2.0 + 2.0 + 2.0 + 3.5	1085	10.2	8.50	4.68	A++	2543		
1.6 + 2.0 + 2.0 + 2.0 + 4.2	1080	10.2	8.50	4.68	A++	2543		
1.6 + 2.0 + 2.0 + 2.0 + 5.0	1100	10.3	8.50	4.68	A++	2543		
1.6 + 2.0 + 2.0 + 2.0 + 6.0	1100	10.3	8.50	4.68	A++	2543		
1.6 + 2.0 + 2.0 + 2.0 + 7.1	1100	10.3	8.50	4.68	A++	2543		
1.6 + 2.0 + 2.0 + 2.5 + 2.5	1070	10.1	8.50	4.68	A++	2543		
1.6 + 2.0 + 2.0 + 2.5 + 3.5	1085	10.2	8.50	4.68	A++	2543		
1.6 + 2.0 + 2.0 + 2.5 + 4.2	1080	10.2	8.50	4.68	A++	2543		
1.6 + 2.0 + 2.0 + 2.5 + 5.0	1100	10.3	8.50	4.68	A++	2543		
1.6 + 2.0 + 2.0 + 2.5 + 6.0	1100	10.3	8.50	4.68	A++	2543		
1.6 + 2.0 + 2.0 + 2.5 + 7.1	1100	10.3	8.50	4.68	A++	2543		
1.6 + 2.0 + 2.0 + 3.5 + 3.5	1075	10.1	8.50	4.68	A++	2543		
1.6 + 2.0 + 2.0 + 3.5 + 4.2	1075	10.1	8.50	4.68	A++	2543		
1.6 + 2.0 + 2.0 + 3.5 + 5.0	1095	10.3	8.50	4.68	A++	2543		
1.6 + 2.0 + 2.0 + 3.5 + 6.0	1095	10.3	8.50	4.68	A++	2543		
1.6 + 2.0 + 2.0 + 3.5 + 7.1	1115	10.5	8.50	4.68	A++	2543		
1.6 + 2.0 + 2.0 + 4.2 + 4.2	1075	10.1	8.50	4.68	A++	2543		

Indoor unit capacity Heating	Total	Heating Capacity (kW)							Input Power (W)		COP	
		Room A	Room B	Room C	Room D	Room E	Total	min ~ max	Rating	min ~ max	WW	CLASS
1.6 + 2.0 + 2.0 + 4.2 + 5.0	14.8	1.12	1.41	1.41	2.95	3.51	10.40	3.4 ~ 14.5	2230	600 ~ 3600	4.66	A
1.6 + 2.0 + 2.0 + 4.2 + 6.0	15.8	1.05	1.32	1.32	2.76	3.95	10.40	3.4 ~ 14.5	2230	600 ~ 3600	4.66	A
1.6 + 2.0 + 2.0 + 4.2 + 7.1	16.9	0.98	1.23	1.23	2.58	4.38	10.40	3.4 ~ 14.5	2230	620 ~ 3590	4.66	A
1.6 + 2.0 + 2.0 + 5.0 + 5.0	15.6	1.08	1.33	1.33	3.33	3.33	10.40	3.4 ~ 14.5	2330	710 ~ 3610	4.46	A
1.6 + 2.0 + 2.0 + 5.0 + 6.0	16.6	1.00	1.25	1.25	3.13	3.77	10.40	3.4 ~ 14.5	2330	710 ~ 3610	4.46	A
1.6 + 2.0 + 2.0 + 5.0 + 7.1	17.7	0.94	1.18	1.18	2.94	4.16	10.40	3.4 ~ 14.5	2330	720 ~ 3660	4.46	A
1.6 + 2.0 + 2.0 + 6.0 + 6.0	17.6	0.94	1.18	1.18	3.55	3.55	10.40	3.4 ~ 14.5	2330	710 ~ 3610	4.46	A
1.6 + 2.0 + 2.5 + 2.5 + 2.5	11.1	1.50	1.88	2.34	2.34	2.34	10.40	3.4 ~ 14.5	2140	460 ~ 3680	4.86	A
1.6 + 2.0 + 2.5 + 2.5 + 3.5	12.1	1.38	1.72	2.15	2.15	3.00	10.40	3.4 ~ 14.5	2170	480 ~ 3650	4.79	A
1.6 + 2.0 + 2.5 + 2.5 + 4.2	12.8	1.30	1.63	2.03	2.03	3.41	10.40	3.4 ~ 14.5	2160	480 ~ 3640	4.81	A
1.6 + 2.0 + 2.5 + 2.5 + 5.0	13.6	1.22	1.53	1.91	1.91	3.83	10.40	3.4 ~ 14.5	2200	570 ~ 3580	4.73	A
1.6 + 2.0 + 2.5 + 2.5 + 6.0	14.6	1.14	1.42	1.78	1.78	4.28	10.40	3.4 ~ 14.5	2200	570 ~ 3580	4.73	A
1.6 + 2.0 + 2.5 + 2.5 + 7.1	15.7	1.06	1.32	1.66	1.66	4.70	10.40	3.4 ~ 14.5	2200	580 ~ 3620	4.73	A
1.6 + 2.0 + 2.5 + 3.5 + 3.5	13.1	1.27	1.59	1.98	2.78	2.78	10.40	3.4 ~ 14.5	2150	500 ~ 3620	4.84	A
1.6 + 2.0 + 2.5 + 3.5 + 4.2	13.8	1.21	1.51	1.88	2.64	3.16	10.40	3.4 ~ 14.5	2150	510 ~ 3610	4.84	A
1.6 + 2.0 + 2.5 + 3.5 + 5.0	14.6	1.14	1.42	1.78	2.49	3.57	10.40	3.4 ~ 14.5	2190	600 ~ 3610	4.75	A
1.6 + 2.0 + 2.5 + 3.5 + 6.0	15.6	1.07	1.33	1.67	2.33	4.00	10.40	3.4 ~ 14.5	2190	600 ~ 3610	4.75	A
1.6 + 2.0 + 2.5 + 3.5 + 7.1	16.7	1.00	1.25	1.56	2.18	4.41	10.40	3.4 ~ 14.5	2230	600 ~ 3600	4.66	A
1.6 + 2.0 + 2.5 + 4.2 + 4.2	14.5	1.15	1.43	1.80	3.01	3.01	10.40	3.4 ~ 14.5	2150	510 ~ 3600	4.84	A
1.6 + 2.0 + 2.5 + 4.2 + 5.0	15.3	1.09	1.36	1.70	2.85	3.40	10.40	3.4 ~ 14.5	2230	600 ~ 3600	4.66	A
1.6 + 2.0 + 2.5 + 4.2 + 6.0	16.3	1.02	1.28	1.60	2.68	3.82	10.40	3.4 ~ 14.5	2230	600 ~ 3600	4.66	A
1.6 + 2.0 + 2.5 + 4.2 + 7.1	17.4	0.96	1.20	1.49	2.51	4.24	10.40	3.4 ~ 14.5	2230	620 ~ 3590	4.66	A
1.6 + 2.0 + 2.5 + 5.0 + 5.0	16.1	1.03	1.29	1.62	3.23	3.23	10.40	3.4 ~ 14.5	2330	710 ~ 3610	4.46	A
1.6 + 2.0 + 2.5 + 5.0 + 6.0	17.1	0.97	1.22	1.52	3.04	3.65	10.40	3.4 ~ 14.5	2330	710 ~ 3610	4.46	A
1.6 + 2.0 + 2.5 + 5.0 + 7.1	18.2	0.91	1.14	1.43	2.86	4.06	10.40	3.4 ~ 14.5	2330	720 ~ 3660	4.46	A
1.6 + 2.0 + 2.5 + 6.0 + 6.0	18.1	0.91	1.15	1.44	3.45	3.45	10.40	3.4 ~ 14.5	2330	710 ~ 3610	4.46	A
1.6 + 2.0 + 3.5 + 3.5 + 3.5	14.1	1.18	1.48	2.58	2.58	2.58	10.40	3.4 ~ 14.5	2180	510 ~ 3590	4.77	A
1.6 + 2.0 + 3.5 + 3.5 + 4.2	14.8	1.12	1.41	2.46	2.46	2.95	10.40	3.4 ~ 14.5	2180	520 ~ 3640	4.77	A
1.6 + 2.0 + 3.5 + 3.5 + 5.0	15.6	1.07	1.33	2.33	2.33	3.34	10.40	3.4 ~ 14.5	2230	620 ~ 3590	4.66	A
1.6 + 2.0 + 3.5 + 3.5 + 6.0	16.6	1.00	1.25	2.19	2.19	3.77	10.40	3.4 ~ 14.5	2230	620 ~ 3590	4.66	A
1.6 + 2.0 + 3.5 + 3.5 + 7.1	17.7	0.94	1.18	2.06	2.06	4.16	10.40	3.4 ~ 14.5	2220	630 ~ 3630	4.68	A
1.6 + 2.0 + 3.5 + 4.2 + 4.2	15.5	1.07	1.34	2.35	2.82	2.82	10.40	3.4 ~ 14.5	2180	530 ~ 3630	4.77	A
1.6 + 2.0 + 3.5 + 4.2 + 5.0	16.3	1.02	1.28	2.23	2.68	3.19	10.40	3.4 ~ 14.5	2230	630 ~ 3630	4.66	A
1.6 + 2.0 + 3.5 + 4.2 + 6.0	17.3	0.96	1.20	2.10	2.52	3.62	10.40	3.4 ~ 14.5	2230	630 ~ 3630	4.66	A
1.6 + 2.0 + 3.5 + 5.0 + 5.0	17.1	0.97	1.22	2.13	3.04	3.04	10.40	3.4 ~ 14.5	2330	740 ~ 3650	4.46	A
1.6 + 2.0 + 3.5 + 5.0 + 6.0	18.1	0.92	1.15	2.01	2.87	3.45	10.40	3.4 ~ 14.5	2330	740 ~ 3650	4.46	A
1.6 + 2.0 + 4.2 + 4.2 + 4.2	16.2	1.02	1.28	2.70	2.70	2.70	10.40	3.4 ~ 14.5	2170	540 ~ 3620	4.79	A
1.6 + 2.0 + 4.2 + 4.2 + 5.0	17.0	0.98	1.22	2.57	2.57	3.06	10.40	3.4 ~ 14.5	2260	630 ~ 3620	4.60	A
1.6 + 2.0 + 4.2 + 4.2 + 6.0	18.0	0.92	1.16	2.43	2.43	3.46	10.40	3.4 ~ 14.5	2260	630 ~ 3620	4.60	A
1.6 + 2.0 + 4.2 + 5.0 + 5.0	17.8	0.93	1.17	2.46	2.92	2.92	10.40	3.4 ~ 14.5	2360	750 ~ 3640	4.41	A
1.6 + 2.5 + 2.5 + 2.5 + 2.5	11.6	1.44	2.24	2.24	2.24	2.24	10.40	3.4 ~ 14.5	2140	460 ~ 3680	4.86	A
1.6 + 2.5 + 2.5 + 2.5 + 3.5	12.6	1.32	2.06	2.06	2.06	2.90	10.40	3.4 ~ 14.5	2170	480 ~ 3650	4.79	A
1.6 + 2.5 + 2.5 + 2.5 + 4.2	13.3	1.25	1.95	1.95	1.95	3.30	10.40	3.4 ~ 14.5	2160	480 ~ 3640	4.81	A
1.6 + 2.5 + 2.5 + 2.5 + 5.0	14.1	1.18	1.84	1.84	1.84	3.70	10.40	3.4 ~ 14.5	2200	570 ~ 3580	4.73	A
1.6 + 2.5 + 2.5 + 2.5 + 6.0	15.1	1.10	1.72	1.72	1.72	4.14	10.40	3.4 ~ 14.5	2200	570 ~ 3580	4.73	A
1.6 + 2.5 + 2.5 + 2.5 + 7.1	16.2	1.03	1.60	1.60	1.60	4.57	10.40	3.4 ~ 14.5	2200	580 ~ 3620	4.73	A
1.6 + 2.5 + 2.5 + 3.5 + 3.5	13.6	1.22	1.91	1.91	2.68	2.68	10.40	3.4 ~ 14.5	2150	500 ~ 3620	4.84	A
1.6 + 2.5 + 2.5 + 3.5 + 4.2	14.3	1.16	1.82	1.82	2.55	3.05	10.40	3.4 ~ 14.5	2150	510 ~ 3610	4.84	A
1.6 + 2.5 + 2.5 + 3.5 + 5.0	15.1	1.10	1.72	1.72	2.41	3.45	10.40	3.4 ~ 14.5	2190	600 ~ 3610	4.75	A
1.6 + 2.5 + 2.5 + 3.5 + 6.0	16.1	1.03	1.61	1.61	2.26	3.89	10.40	3.4 ~ 14.5	2190	600 ~ 3610	4.75	A
1.6 + 2.5 + 2.5 + 3.5 + 7.1	17.2	0.97	1.51	1.51	2.12	4.29	10.40	3.4 ~ 14.5	2230	600 ~ 3600	4.66	A
1.6 + 2.5 + 2.5 + 4.2 + 4.2	15.0	1.12	1.73	1.73	2.91	2.91	10.40	3.4 ~ 14.5	2150	510 ~ 3600	4.84	A
1.6 + 2.5 + 2.5 + 4.2 + 5.0	15.8	1.05	1.65	1.65	2.76	3.29	10.40	3.4 ~ 14.5	2230	600 ~ 3600	4.66	A
1.6 + 2.5 + 2.5 + 4.2 + 6.0	16.8	0.99	1.55	1.55	2.60	3.71	10.40	3.4 ~ 14.5	2230	600 ~ 3600	4.66	A
1.6 + 2.5 + 2.5 + 4.2 + 7.1	17.9	0.93	1.45	1.45	2.44	4.13	10.40	3.4 ~ 14.5	2230	620 ~ 3590	4.66	A
1.6 + 2.5 + 2.5 + 5.0 + 5.0	16.6	1.00	1.57	1.57	3.13	3.13	10.40	3.4 ~ 14.5	2330	710 ~ 3610	4.46	A
1.6 + 2.5 + 2.5 + 5.0 + 6.0	17.6	0.95	1.48	1.48	2.95	3.54	10.40	3.4 ~ 14.5	2330	710 ~ 3610	4.46	A
1.6 + 2.5 + 3.5 + 3.5 + 3.5	14.6	1.14	1.79	2.49	2.49	2.49	10.40	3.4 ~ 14.5	2180	510 ~ 3590	4.77	A

5 Room

	Indoor unit capacity Heating	Annual Energy Consumption (kWh)	Current 230V (A)	ERP				Moisture Removal Volume l/h
				Pdesign (kW)	SCOP		Annual Consumption (kWh)	
					W/W	CLASS		
5 Room	1.6 + 2.0 + 2.0 + 4.2 + 5.0	1115	10.5	8.50	4.68	A++	2543	
	1.6 + 2.0 + 2.0 + 4.2 + 6.0	1115	10.5	8.50	4.68	A++	2543	
	1.6 + 2.0 + 2.0 + 4.2 + 7.1	1115	10.5	8.50	4.68	A++	2543	
	1.6 + 2.0 + 2.0 + 5.0 + 5.0	1165	10.9	8.50	4.68	A++	2543	
	1.6 + 2.0 + 2.0 + 5.0 + 6.0	1165	10.9	8.50	4.68	A++	2543	
	1.6 + 2.0 + 2.0 + 5.0 + 7.1	1165	10.9	8.50	4.68	A++	2543	
	1.6 + 2.0 + 2.0 + 6.0 + 6.0	1165	10.9	8.50	4.68	A++	2543	
	1.6 + 2.0 + 2.5 + 2.5 + 2.5	1070	10.1	8.50	4.68	A++	2543	
	1.6 + 2.0 + 2.5 + 2.5 + 3.5	1085	10.2	8.50	4.68	A++	2543	
	1.6 + 2.0 + 2.5 + 2.5 + 4.2	1080	10.2	8.50	4.68	A++	2543	
	1.6 + 2.0 + 2.5 + 2.5 + 5.0	1100	10.3	8.50	4.68	A++	2543	
	1.6 + 2.0 + 2.5 + 2.5 + 6.0	1100	10.3	8.50	4.68	A++	2543	
	1.6 + 2.0 + 2.5 + 2.5 + 7.1	1100	10.3	8.50	4.68	A++	2543	
	1.6 + 2.0 + 2.5 + 3.5 + 3.5	1075	10.1	8.50	4.68	A++	2543	
	1.6 + 2.0 + 2.5 + 3.5 + 4.2	1075	10.1	8.50	4.68	A++	2543	
	1.6 + 2.0 + 2.5 + 3.5 + 5.0	1095	10.3	8.50	4.68	A++	2543	
	1.6 + 2.0 + 2.5 + 3.5 + 6.0	1095	10.3	8.50	4.68	A++	2543	
	1.6 + 2.0 + 2.5 + 3.5 + 7.1	1115	10.5	8.50	4.68	A++	2543	
	1.6 + 2.0 + 2.5 + 4.2 + 4.2	1075	10.1	8.50	4.68	A++	2543	
	1.6 + 2.0 + 2.5 + 4.2 + 5.0	1115	10.5	8.50	4.68	A++	2543	
	1.6 + 2.0 + 2.5 + 4.2 + 6.0	1115	10.5	8.50	4.68	A++	2543	
	1.6 + 2.0 + 2.5 + 4.2 + 7.1	1115	10.5	8.50	4.68	A++	2543	
	1.6 + 2.0 + 2.5 + 5.0 + 5.0	1165	10.9	8.50	4.68	A++	2543	
	1.6 + 2.0 + 2.5 + 5.0 + 6.0	1165	10.9	8.50	4.68	A++	2543	
	1.6 + 2.0 + 2.5 + 5.0 + 7.1	1165	10.9	8.50	4.68	A++	2543	
	1.6 + 2.0 + 2.5 + 6.0 + 6.0	1165	10.9	8.50	4.68	A++	2543	
	1.6 + 2.0 + 3.5 + 3.5 + 3.5	1090	10.2	8.50	4.68	A++	2543	
	1.6 + 2.0 + 3.5 + 3.5 + 4.2	1090	10.2	8.50	4.68	A++	2543	
	1.6 + 2.0 + 3.5 + 3.5 + 5.0	1115	10.5	8.50	4.68	A++	2543	
	1.6 + 2.0 + 3.5 + 3.5 + 6.0	1115	10.5	8.50	4.68	A++	2543	
	1.6 + 2.0 + 3.5 + 3.5 + 7.1	1110	10.4	8.50	4.68	A++	2543	
	1.6 + 2.0 + 3.5 + 4.2 + 4.2	1090	10.2	8.50	4.68	A++	2543	
	1.6 + 2.0 + 3.5 + 4.2 + 5.0	1115	10.5	8.50	4.68	A++	2543	
	1.6 + 2.0 + 3.5 + 4.2 + 6.0	1115	10.5	8.50	4.68	A++	2543	
	1.6 + 2.0 + 3.5 + 5.0 + 5.0	1165	10.9	8.50	4.68	A++	2543	
	1.6 + 2.0 + 3.5 + 5.0 + 6.0	1165	10.9	8.50	4.68	A++	2543	
	1.6 + 2.0 + 4.2 + 4.2 + 4.2	1085	10.2	8.50	4.68	A++	2543	
	1.6 + 2.0 + 4.2 + 4.2 + 5.0	1130	10.6	8.50	4.68	A++	2543	
	1.6 + 2.0 + 4.2 + 4.2 + 6.0	1130	10.6	8.50	4.68	A++	2543	
	1.6 + 2.0 + 4.2 + 5.0 + 5.0	1180	11.1	8.50	4.68	A++	2543	
1.6 + 2.5 + 2.5 + 2.5 + 2.5	1070	10.1	8.50	4.68	A++	2543		
1.6 + 2.5 + 2.5 + 2.5 + 3.5	1085	10.2	8.50	4.68	A++	2543		
1.6 + 2.5 + 2.5 + 2.5 + 4.2	1080	10.2	8.50	4.68	A++	2543		
1.6 + 2.5 + 2.5 + 2.5 + 5.0	1100	10.3	8.50	4.68	A++	2543		
1.6 + 2.5 + 2.5 + 2.5 + 6.0	1100	10.3	8.50	4.68	A++	2543		
1.6 + 2.5 + 2.5 + 2.5 + 7.1	1100	10.3	8.50	4.68	A++	2543		
1.6 + 2.5 + 2.5 + 3.5 + 3.5	1075	10.1	8.50	4.68	A++	2543		
1.6 + 2.5 + 2.5 + 3.5 + 4.2	1075	10.1	8.50	4.68	A++	2543		
1.6 + 2.5 + 2.5 + 3.5 + 5.0	1095	10.3	8.50	4.68	A++	2543		
1.6 + 2.5 + 2.5 + 3.5 + 6.0	1095	10.3	8.50	4.68	A++	2543		
1.6 + 2.5 + 2.5 + 3.5 + 7.1	1115	10.5	8.50	4.68	A++	2543		
1.6 + 2.5 + 2.5 + 4.2 + 4.2	1075	10.1	8.50	4.68	A++	2543		
1.6 + 2.5 + 2.5 + 4.2 + 5.0	1115	10.5	8.50	4.68	A++	2543		
1.6 + 2.5 + 2.5 + 4.2 + 6.0	1115	10.5	8.50	4.68	A++	2543		
1.6 + 2.5 + 2.5 + 4.2 + 7.1	1115	10.5	8.50	4.68	A++	2543		
1.6 + 2.5 + 2.5 + 5.0 + 5.0	1165	10.9	8.50	4.68	A++	2543		
1.6 + 2.5 + 2.5 + 5.0 + 6.0	1165	10.9	8.50	4.68	A++	2543		
1.6 + 2.5 + 3.5 + 3.5 + 3.5	1090	10.2	8.50	4.68	A++	2543		

Indoor unit capacity Heating	Total	Heating Capacity (kW)							Input Power (W)		COP	
		Room A	Room B	Room C	Room D	Room E	Total	min ~ max	Rating	min ~ max	WW	CLASS
1.6 + 2.5 + 3.5 + 3.5 + 4.2	15.3	1.09	1.70	2.38	2.38	2.85	10.40	3.4 ~ 14.5	2180	520 ~ 3640	4.77	A
1.6 + 2.5 + 3.5 + 3.5 + 5.0	16.1	1.03	1.61	2.26	2.26	3.24	10.40	3.4 ~ 14.5	2230	620 ~ 3590	4.66	A
1.6 + 2.5 + 3.5 + 3.5 + 6.0	17.1	0.97	1.52	2.13	2.13	3.65	10.40	3.4 ~ 14.5	2230	620 ~ 3590	4.66	A
1.6 + 2.5 + 3.5 + 3.5 + 7.1	18.2	0.91	1.43	2.00	2.00	4.06	10.40	3.4 ~ 14.5	2220	630 ~ 3630	4.68	A
1.6 + 2.5 + 3.5 + 4.2 + 4.2	16.0	1.03	1.63	2.28	2.73	2.73	10.40	3.4 ~ 14.5	2180	530 ~ 3630	4.77	A
1.6 + 2.5 + 3.5 + 4.2 + 5.0	16.8	0.99	1.55	2.17	2.60	3.09	10.40	3.4 ~ 14.5	2230	630 ~ 3630	4.66	A
1.6 + 2.5 + 3.5 + 4.2 + 6.0	17.8	0.93	1.46	2.04	2.45	3.52	10.40	3.4 ~ 14.5	2230	630 ~ 3630	4.66	A
1.6 + 2.5 + 3.5 + 5.0 + 5.0	17.6	0.95	1.48	2.07	2.95	2.95	10.40	3.4 ~ 14.5	2330	740 ~ 3650	4.46	A
1.6 + 2.5 + 4.2 + 4.2 + 4.2	16.7	0.98	1.56	2.62	2.62	2.62	10.40	3.4 ~ 14.5	2170	540 ~ 3620	4.79	A
1.6 + 2.5 + 4.2 + 4.2 + 5.0	17.5	0.95	1.49	2.50	2.50	2.96	10.40	3.4 ~ 14.5	2260	630 ~ 3620	4.60	A
1.6 + 2.5 + 4.2 + 5.0 + 5.0	18.3	0.91	1.42	2.39	2.84	2.84	10.40	3.4 ~ 14.5	2360	750 ~ 3640	4.41	A
1.6 + 3.5 + 3.5 + 3.5 + 3.5	15.6	1.08	2.33	2.33	2.33	2.33	10.40	3.4 ~ 14.5	2170	540 ~ 3620	4.79	A
1.6 + 3.5 + 3.5 + 3.5 + 4.2	16.3	1.02	2.23	2.23	2.23	2.69	10.40	3.4 ~ 14.5	2170	540 ~ 3610	4.79	A
1.6 + 3.5 + 3.5 + 3.5 + 5.0	17.1	0.97	2.13	2.13	2.13	3.04	10.40	3.4 ~ 14.5	2260	650 ~ 3620	4.60	A
1.6 + 3.5 + 3.5 + 3.5 + 6.0	18.1	0.92	2.01	2.01	2.01	3.45	10.40	3.4 ~ 14.5	2260	650 ~ 3620	4.60	A
1.6 + 3.5 + 3.5 + 4.2 + 4.2	17.0	0.98	2.14	2.14	2.57	2.57	10.40	3.4 ~ 14.5	2170	550 ~ 3600	4.79	A
1.6 + 3.5 + 3.5 + 4.2 + 5.0	17.8	0.93	2.04	2.04	2.45	2.94	10.40	3.4 ~ 14.5	2260	650 ~ 3610	4.60	A
1.6 + 3.5 + 4.2 + 4.2 + 4.2	17.7	0.93	2.06	2.47	2.47	2.47	10.40	3.4 ~ 14.5	2200	560 ~ 3590	4.73	A
2.0 + 2.0 + 2.0 + 2.0 + 2.0	10.0	2.08	2.08	2.08	2.08	2.08	10.40	3.4 ~ 14.5	2130	460 ~ 3670	4.88	A
2.0 + 2.0 + 2.0 + 2.0 + 2.5	10.5	1.98	1.98	1.98	1.98	2.48	10.40	3.4 ~ 14.5	2130	460 ~ 3670	4.88	A
2.0 + 2.0 + 2.0 + 2.0 + 3.5	11.5	1.81	1.81	1.81	1.81	3.16	10.40	3.4 ~ 14.5	2160	480 ~ 3640	4.81	A
2.0 + 2.0 + 2.0 + 2.0 + 4.2	12.2	1.70	1.70	1.70	1.70	3.60	10.40	3.4 ~ 14.5	2160	490 ~ 3630	4.81	A
2.0 + 2.0 + 2.0 + 2.0 + 5.0	13.0	1.60	1.60	1.60	1.60	4.00	10.40	3.4 ~ 14.5	2200	580 ~ 3630	4.73	A
2.0 + 2.0 + 2.0 + 2.0 + 6.0	14.0	1.49	1.49	1.49	1.49	4.44	10.40	3.4 ~ 14.5	2200	580 ~ 3630	4.73	A
2.0 + 2.0 + 2.0 + 2.0 + 7.1	15.1	1.38	1.38	1.38	1.38	4.88	10.40	3.4 ~ 14.5	2190	590 ~ 3610	4.75	A
2.0 + 2.0 + 2.0 + 2.5 + 2.5	11.0	1.89	1.89	1.89	2.36	2.36	10.39	3.4 ~ 14.5	2130	460 ~ 3670	4.88	A
2.0 + 2.0 + 2.0 + 2.5 + 3.5	12.0	1.73	1.73	1.73	2.17	3.04	10.40	3.4 ~ 14.5	2160	480 ~ 3640	4.81	A
2.0 + 2.0 + 2.0 + 2.5 + 4.2	12.7	1.64	1.64	1.64	2.05	3.43	10.40	3.4 ~ 14.5	2160	490 ~ 3630	4.81	A
2.0 + 2.0 + 2.0 + 2.5 + 5.0	13.5	1.54	1.54	1.54	1.93	3.85	10.40	3.4 ~ 14.5	2200	580 ~ 3630	4.73	A
2.0 + 2.0 + 2.0 + 2.5 + 6.0	14.5	1.43	1.43	1.43	1.79	4.32	10.40	3.4 ~ 14.5	2200	580 ~ 3630	4.73	A
2.0 + 2.0 + 2.0 + 2.5 + 7.1	15.6	1.33	1.33	1.33	1.67	4.74	10.40	3.4 ~ 14.5	2190	590 ~ 3610	4.75	A
2.0 + 2.0 + 2.0 + 3.5 + 3.5	13.0	1.60	1.60	1.60	2.80	2.80	10.40	3.4 ~ 14.5	2150	510 ~ 3610	4.84	A
2.0 + 2.0 + 2.0 + 3.5 + 4.2	13.7	1.52	1.52	1.52	2.66	3.18	10.40	3.4 ~ 14.5	2150	510 ~ 3600	4.84	A
2.0 + 2.0 + 2.0 + 3.5 + 5.0	14.5	1.43	1.43	1.43	2.51	3.60	10.40	3.4 ~ 14.5	2230	600 ~ 3600	4.66	A
2.0 + 2.0 + 2.0 + 3.5 + 6.0	15.5	1.34	1.34	1.34	2.35	4.03	10.40	3.4 ~ 14.5	2230	600 ~ 3600	4.66	A
2.0 + 2.0 + 2.0 + 3.5 + 7.1	16.6	1.25	1.25	1.25	2.19	4.46	10.40	3.4 ~ 14.5	2230	620 ~ 3590	4.66	A
2.0 + 2.0 + 2.0 + 4.2 + 4.2	14.4	1.44	1.44	1.44	3.04	3.04	10.40	3.4 ~ 14.5	2180	520 ~ 3590	4.77	A
2.0 + 2.0 + 2.0 + 4.2 + 5.0	15.2	1.37	1.37	1.37	2.87	3.42	10.40	3.4 ~ 14.5	2230	610 ~ 3590	4.66	A
2.0 + 2.0 + 2.0 + 4.2 + 6.0	16.2	1.28	1.28	1.28	2.70	3.86	10.40	3.4 ~ 14.5	2230	610 ~ 3590	4.66	A
2.0 + 2.0 + 2.0 + 4.2 + 7.1	17.3	1.20	1.20	1.20	2.52	4.28	10.40	3.4 ~ 14.5	2230	630 ~ 3630	4.66	A
2.0 + 2.0 + 2.0 + 5.0 + 5.0	16.0	1.30	1.30	1.30	3.25	3.25	10.40	3.4 ~ 14.5	2330	720 ~ 3660	4.46	A
2.0 + 2.0 + 2.0 + 5.0 + 6.0	17.0	1.22	1.22	1.22	3.06	3.68	10.40	3.4 ~ 14.5	2330	720 ~ 3660	4.46	A
2.0 + 2.0 + 2.0 + 5.0 + 7.1	18.1	1.15	1.15	1.15	2.87	4.08	10.40	3.4 ~ 14.5	2330	740 ~ 3650	4.46	A
2.0 + 2.0 + 2.0 + 6.0 + 6.0	18.0	1.16	1.16	1.16	3.46	3.46	10.40	3.4 ~ 14.5	2330	720 ~ 3660	4.46	A
2.0 + 2.0 + 2.5 + 2.5 + 2.5	11.5	1.81	1.81	2.26	2.26	2.26	10.40	3.4 ~ 14.5	2130	460 ~ 3670	4.88	A
2.0 + 2.0 + 2.5 + 2.5 + 3.5	12.5	1.66	1.66	2.08	2.08	2.92	10.40	3.4 ~ 14.5	2160	480 ~ 3640	4.81	A
2.0 + 2.0 + 2.5 + 2.5 + 4.2	13.2	1.58	1.58	1.97	1.97	3.30	10.40	3.4 ~ 14.5	2160	490 ~ 3630	4.81	A
2.0 + 2.0 + 2.5 + 2.5 + 5.0	14.0	1.49	1.49	1.86	1.86	3.70	10.40	3.4 ~ 14.5	2200	580 ~ 3630	4.73	A
2.0 + 2.0 + 2.5 + 2.5 + 6.0	15.0	1.39	1.39	1.73	1.73	4.16	10.40	3.4 ~ 14.5	2200	580 ~ 3630	4.73	A
2.0 + 2.0 + 2.5 + 2.5 + 7.1	16.1	1.29	1.29	1.61	1.61	4.60	10.40	3.4 ~ 14.5	2190	590 ~ 3610	4.75	A
2.0 + 2.0 + 2.5 + 3.5 + 3.5	13.5	1.54	1.54	1.92	2.70	2.70	10.40	3.4 ~ 14.5	2150	510 ~ 3610	4.84	A
2.0 + 2.0 + 2.5 + 3.5 + 4.2	14.2	1.46	1.46	1.83	2.56	3.09	10.40	3.4 ~ 14.5	2150	510 ~ 3600	4.84	A
2.0 + 2.0 + 2.5 + 3.5 + 5.0	15.0	1.39	1.39	1.73	2.43	3.46	10.40	3.4 ~ 14.5	2230	600 ~ 3600	4.66	A
2.0 + 2.0 + 2.5 + 3.5 + 6.0	16.0	1.30	1.30	1.63	2.28	3.89	10.40	3.4 ~ 14.5	2230	600 ~ 3600	4.66	A
2.0 + 2.0 + 2.5 + 3.5 + 7.1	17.1	1.22	1.22	1.52	2.13	4.31	10.40	3.4 ~ 14.5	2230	620 ~ 3590	4.66	A
2.0 + 2.0 + 2.5 + 4.2 + 4.2	14.9	1.40	1.40	1.74	2.93	2.93	10.40	3.4 ~ 14.5	2180	520 ~ 3590	4.77	A
2.0 + 2.0 + 2.5 + 4.2 + 5.0	15.7	1.32	1.32	1.66	2.78	3.32	10.40	3.4 ~ 14.5	2230	610 ~ 3590	4.66	A
2.0 + 2.0 + 2.5 + 4.2 + 6.0	16.7	1.25	1.25	1.56	2.62	3.72	10.40	3.4 ~ 14.5	2230	610 ~ 3590	4.66	A

5 Room



Indoor unit capacity Heating	Total	Heating Capacity (kW)							Input Power (W)		COP	
		Room A	Room B	Room C	Room D	Room E	Total	min ~ max	Rating	min ~ max	WW	CLASS
2.0 + 2.0 + 2.5 + 4.2 + 7.1	17.8	1.17	1.17	1.46	2.45	4.15	10.40	3.4 ~ 14.5	2230	630 ~ 3630	4.66	A
2.0 + 2.0 + 2.5 + 5.0 + 5.0	16.5	1.26	1.26	1.58	3.15	3.15	10.40	3.4 ~ 14.5	2330	720 ~ 3660	4.46	A
2.0 + 2.0 + 2.5 + 5.0 + 6.0	17.5	1.19	1.19	1.49	2.97	3.56	10.40	3.4 ~ 14.5	2330	720 ~ 3660	4.46	A
2.0 + 2.0 + 3.5 + 3.5 + 3.5	14.5	1.43	1.43	2.51	2.51	2.51	10.39	3.4 ~ 14.5	2180	520 ~ 3640	4.77	A
2.0 + 2.0 + 3.5 + 3.5 + 4.2	15.2	1.37	1.37	2.39	2.39	2.88	10.40	3.4 ~ 14.5	2180	530 ~ 3630	4.77	A
2.0 + 2.0 + 3.5 + 3.5 + 5.0	16.0	1.30	1.30	2.28	2.28	3.24	10.40	3.4 ~ 14.5	2230	630 ~ 3630	4.66	A
2.0 + 2.0 + 3.5 + 3.5 + 6.0	17.0	1.22	1.22	2.14	2.14	3.68	10.40	3.4 ~ 14.5	2230	630 ~ 3630	4.66	A
2.0 + 2.0 + 3.5 + 3.5 + 7.1	18.1	1.15	1.15	2.01	2.01	4.08	10.40	3.4 ~ 14.5	2260	640 ~ 3620	4.60	A
2.0 + 2.0 + 3.5 + 4.2 + 4.2	15.9	1.31	1.31	2.28	2.75	2.75	10.40	3.4 ~ 14.5	2170	540 ~ 3620	4.79	A
2.0 + 2.0 + 3.5 + 4.2 + 5.0	16.7	1.25	1.25	2.18	2.62	3.10	10.40	3.4 ~ 14.5	2260	630 ~ 3620	4.60	A
2.0 + 2.0 + 3.5 + 4.2 + 6.0	17.7	1.18	1.18	2.06	2.47	3.51	10.40	3.4 ~ 14.5	2260	630 ~ 3620	4.60	A
2.0 + 2.0 + 3.5 + 5.0 + 5.0	17.5	1.19	1.19	2.08	2.97	2.97	10.40	3.4 ~ 14.5	2360	750 ~ 3640	4.41	A
2.0 + 2.0 + 4.2 + 4.2 + 4.2	16.6	1.25	1.25	2.63	2.63	2.63	10.39	3.4 ~ 14.5	2170	540 ~ 3610	4.79	A
2.0 + 2.0 + 4.2 + 4.2 + 5.0	17.4	1.20	1.20	2.51	2.51	2.98	10.40	3.4 ~ 14.5	2260	650 ~ 3610	4.60	A
2.0 + 2.0 + 4.2 + 5.0 + 5.0	18.2	1.14	1.14	2.40	2.86	2.86	10.40	3.4 ~ 14.5	2370	750 ~ 3690	4.39	A
2.0 + 2.5 + 2.5 + 2.5 + 2.5	12.0	1.72	2.17	2.17	2.17	2.17	10.40	3.4 ~ 14.5	2130	460 ~ 3670	4.88	A
2.0 + 2.5 + 2.5 + 2.5 + 3.5	13.0	1.60	2.00	2.00	2.00	2.80	10.40	3.4 ~ 14.5	2160	480 ~ 3640	4.81	A
2.0 + 2.5 + 2.5 + 2.5 + 4.2	13.7	1.52	1.90	1.90	1.90	3.18	10.40	3.4 ~ 14.5	2160	490 ~ 3630	4.81	A
2.0 + 2.5 + 2.5 + 2.5 + 5.0	14.5	1.43	1.79	1.79	1.79	3.60	10.40	3.4 ~ 14.5	2200	580 ~ 3630	4.73	A
2.0 + 2.5 + 2.5 + 2.5 + 6.0	15.5	1.34	1.68	1.68	1.68	4.02	10.40	3.4 ~ 14.5	2200	580 ~ 3630	4.73	A
2.0 + 2.5 + 2.5 + 2.5 + 7.1	16.6	1.25	1.57	1.57	1.57	4.44	10.40	3.4 ~ 14.5	2190	590 ~ 3610	4.75	A
2.0 + 2.5 + 2.5 + 3.5 + 3.5	14.0	1.48	1.86	1.86	2.60	2.60	10.40	3.4 ~ 14.5	2150	510 ~ 3610	4.84	A
2.0 + 2.5 + 2.5 + 3.5 + 4.2	14.7	1.41	1.77	1.77	2.48	2.97	10.40	3.4 ~ 14.5	2150	510 ~ 3600	4.84	A
2.0 + 2.5 + 2.5 + 3.5 + 5.0	15.5	1.34	1.68	1.68	2.35	3.35	10.40	3.4 ~ 14.5	2230	600 ~ 3600	4.66	A
2.0 + 2.5 + 2.5 + 3.5 + 6.0	16.5	1.26	1.58	1.58	2.21	3.77	10.40	3.4 ~ 14.5	2230	600 ~ 3600	4.66	A
2.0 + 2.5 + 2.5 + 3.5 + 7.1	17.6	1.18	1.48	1.48	2.07	4.19	10.40	3.4 ~ 14.5	2230	620 ~ 3590	4.66	A
2.0 + 2.5 + 2.5 + 4.2 + 4.2	15.4	1.34	1.69	1.69	2.84	2.84	10.40	3.4 ~ 14.5	2180	520 ~ 3590	4.77	A
2.0 + 2.5 + 2.5 + 4.2 + 5.0	16.2	1.28	1.60	1.60	2.70	3.22	10.40	3.4 ~ 14.5	2230	610 ~ 3590	4.66	A
2.0 + 2.5 + 2.5 + 4.2 + 6.0	17.2	1.21	1.51	1.51	2.54	3.63	10.40	3.4 ~ 14.5	2230	610 ~ 3590	4.66	A
2.0 + 2.5 + 2.5 + 4.2 + 7.1	18.3	1.14	1.42	1.42	2.39	4.03	10.40	3.4 ~ 14.5	2230	630 ~ 3630	4.66	A
2.0 + 2.5 + 2.5 + 5.0 + 5.0	17.0	1.22	1.53	1.53	3.06	3.06	10.40	3.4 ~ 14.5	2330	720 ~ 3660	4.46	A
2.0 + 2.5 + 2.5 + 5.0 + 6.0	18.0	1.16	1.44	1.44	2.89	3.47	10.40	3.4 ~ 14.5	2330	720 ~ 3660	4.46	A
2.0 + 2.5 + 3.5 + 3.5 + 3.5	15.0	1.38	1.73	2.43	2.43	2.43	10.40	3.4 ~ 14.5	2180	520 ~ 3640	4.77	A
2.0 + 2.5 + 3.5 + 3.5 + 4.2	15.7	1.32	1.66	2.32	2.32	2.78	10.40	3.4 ~ 14.5	2180	530 ~ 3630	4.77	A
2.0 + 2.5 + 3.5 + 3.5 + 5.0	16.5	1.26	1.58	2.21	2.21	3.14	10.40	3.4 ~ 14.5	2230	630 ~ 3630	4.66	A
2.0 + 2.5 + 3.5 + 3.5 + 6.0	17.5	1.19	1.49	2.08	2.08	3.56	10.40	3.4 ~ 14.5	2230	630 ~ 3630	4.66	A
2.0 + 2.5 + 3.5 + 4.2 + 4.2	16.4	1.27	1.59	2.22	2.66	2.66	10.40	3.4 ~ 14.5	2170	540 ~ 3620	4.79	A
2.0 + 2.5 + 3.5 + 4.2 + 5.0	17.2	1.21	1.51	2.12	2.54	3.02	10.40	3.4 ~ 14.5	2260	630 ~ 3620	4.60	A
2.0 + 2.5 + 3.5 + 4.2 + 6.0	18.2	1.14	1.43	2.00	2.40	3.43	10.40	3.4 ~ 14.5	2260	630 ~ 3620	4.60	A
2.0 + 2.5 + 3.5 + 5.0 + 5.0	18.0	1.16	1.44	2.02	2.89	2.89	10.40	3.4 ~ 14.5	2360	750 ~ 3640	4.41	A
2.0 + 2.5 + 4.2 + 4.2 + 4.2	17.1	1.23	1.52	2.55	2.55	2.55	10.40	3.4 ~ 14.5	2170	540 ~ 3610	4.79	A
2.0 + 2.5 + 4.2 + 4.2 + 5.0	17.9	1.16	1.45	2.44	2.44	2.91	10.40	3.4 ~ 14.5	2260	650 ~ 3610	4.60	A
2.0 + 3.5 + 3.5 + 3.5 + 3.5	16.0	1.28	2.28	2.28	2.28	2.28	10.40	3.4 ~ 14.5	2170	540 ~ 3610	4.79	A
2.0 + 3.5 + 3.5 + 3.5 + 4.2	16.7	1.25	2.18	2.18	2.18	2.61	10.40	3.4 ~ 14.5	2170	550 ~ 3600	4.79	A
2.0 + 3.5 + 3.5 + 3.5 + 5.0	17.5	1.19	2.08	2.08	2.08	2.97	10.40	3.4 ~ 14.5	2260	650 ~ 3610	4.60	A
2.0 + 3.5 + 3.5 + 4.2 + 4.2	17.4	1.20	2.09	2.09	2.51	2.51	10.40	3.4 ~ 14.5	2200	560 ~ 3590	4.73	A
2.0 + 3.5 + 3.5 + 4.2 + 5.0	18.2	1.14	2.00	2.00	2.40	2.86	10.40	3.4 ~ 14.5	2260	660 ~ 3600	4.60	A
2.0 + 3.5 + 4.2 + 4.2 + 4.2	18.1	1.15	2.02	2.41	2.41	2.41	10.40	3.4 ~ 14.5	2200	570 ~ 3580	4.73	A
2.5 + 2.5 + 2.5 + 2.5 + 2.5	12.5	2.08	2.08	2.08	2.08	2.08	10.40	3.4 ~ 14.5	2130	460 ~ 3670	4.88	A
2.5 + 2.5 + 2.5 + 2.5 + 3.5	13.5	1.93	1.93	1.93	1.93	2.68	10.40	3.4 ~ 14.5	2160	480 ~ 3640	4.81	A
2.5 + 2.5 + 2.5 + 2.5 + 4.2	14.2	1.83	1.83	1.83	1.83	3.08	10.40	3.4 ~ 14.5	2160	490 ~ 3630	4.81	A
2.5 + 2.5 + 2.5 + 2.5 + 5.0	15.0	1.73	1.73	1.73	1.73	3.48	10.40	3.4 ~ 14.5	2200	580 ~ 3630	4.73	A
2.5 + 2.5 + 2.5 + 2.5 + 6.0	16.0	1.63	1.63	1.63	1.63	3.88	10.40	3.4 ~ 14.5	2200	580 ~ 3630	4.73	A
2.5 + 2.5 + 2.5 + 2.5 + 7.1	17.1	1.52	1.52	1.52	1.52	4.32	10.40	3.4 ~ 14.5	2190	590 ~ 3610	4.75	A
2.5 + 2.5 + 2.5 + 3.5 + 3.5	14.5	1.79	1.79	1.79	2.51	2.51	10.39	3.4 ~ 14.5	2150	510 ~ 3610	4.83	A
2.5 + 2.5 + 2.5 + 3.5 + 4.2	15.2	1.71	1.71	1.71	2.39	2.88	10.40	3.4 ~ 14.5	2150	510 ~ 3600	4.84	A
2.5 + 2.5 + 2.5 + 3.5 + 5.0	16.0	1.63	1.63	1.63	2.28	3.23	10.40	3.4 ~ 14.5	2230	600 ~ 3600	4.66	A
2.5 + 2.5 + 2.5 + 3.5 + 6.0	17.0	1.53	1.53	1.53	2.14	3.67	10.40	3.4 ~ 14.5	2230	600 ~ 3600	4.66	A

5 Room



	Indoor unit capacity Heating	Annual Energy Consumption (kWh)	Current 230V (A)	ERP				Moisture Removal Volume l/h
				Pdesign (kW)	SCOP		Annual Consumption (kWh)	
					W/W	CLASS		
5 Room	2.0 + 2.0 + 2.5 + 4.2 + 7.1	1115	10.5	8.50	4.68	A++	2543	
	2.0 + 2.0 + 2.5 + 5.0 + 5.0	1165	10.9	8.50	4.68	A++	2543	
	2.0 + 2.0 + 2.5 + 5.0 + 6.0	1165	10.9	8.50	4.68	A++	2543	
	2.0 + 2.0 + 3.5 + 3.5 + 3.5	1090	10.2	8.50	4.68	A++	2543	
	2.0 + 2.0 + 3.5 + 3.5 + 4.2	1090	10.2	8.50	4.68	A++	2543	
	2.0 + 2.0 + 3.5 + 3.5 + 5.0	1115	10.5	8.50	4.68	A++	2543	
	2.0 + 2.0 + 3.5 + 3.5 + 6.0	1115	10.5	8.50	4.68	A++	2543	
	2.0 + 2.0 + 3.5 + 3.5 + 7.1	1130	10.6	8.50	4.68	A++	2543	
	2.0 + 2.0 + 3.5 + 4.2 + 4.2	1085	10.2	8.50	4.68	A++	2543	
	2.0 + 2.0 + 3.5 + 4.2 + 5.0	1130	10.6	8.50	4.68	A++	2543	
	2.0 + 2.0 + 3.5 + 4.2 + 6.0	1130	10.6	8.50	4.68	A++	2543	
	2.0 + 2.0 + 3.5 + 5.0 + 5.0	1180	11.1	8.50	4.68	A++	2543	
	2.0 + 2.0 + 4.2 + 4.2 + 4.2	1085	10.2	8.50	4.68	A++	2543	
	2.0 + 2.0 + 4.2 + 4.2 + 5.0	1130	10.6	8.50	4.68	A++	2543	
	2.0 + 2.0 + 4.2 + 5.0 + 5.0	1185	11.1	8.50	4.68	A++	2543	
	2.0 + 2.5 + 2.5 + 2.5 + 2.5	1065	10.0	8.50	4.68	A++	2543	
	2.0 + 2.5 + 2.5 + 2.5 + 3.5	1080	10.2	8.50	4.68	A++	2543	
	2.0 + 2.5 + 2.5 + 2.5 + 4.2	1080	10.2	8.50	4.68	A++	2543	
	2.0 + 2.5 + 2.5 + 2.5 + 5.0	1100	10.3	8.50	4.68	A++	2543	
	2.0 + 2.5 + 2.5 + 2.5 + 6.0	1100	10.3	8.50	4.68	A++	2543	
	2.0 + 2.5 + 2.5 + 2.5 + 7.1	1095	10.3	8.50	4.68	A++	2543	
	2.0 + 2.5 + 2.5 + 3.5 + 3.5	1075	10.1	8.50	4.68	A++	2543	
	2.0 + 2.5 + 2.5 + 3.5 + 4.2	1075	10.1	8.50	4.68	A++	2543	
	2.0 + 2.5 + 2.5 + 3.5 + 5.0	1115	10.5	8.50	4.68	A++	2543	
	2.0 + 2.5 + 2.5 + 3.5 + 6.0	1115	10.5	8.50	4.68	A++	2543	
	2.0 + 2.5 + 2.5 + 3.5 + 7.1	1115	10.5	8.50	4.68	A++	2543	
	2.0 + 2.5 + 2.5 + 4.2 + 4.2	1090	10.2	8.50	4.68	A++	2543	
	2.0 + 2.5 + 2.5 + 4.2 + 5.0	1115	10.5	8.50	4.68	A++	2543	
	2.0 + 2.5 + 2.5 + 4.2 + 6.0	1115	10.5	8.50	4.68	A++	2543	
	2.0 + 2.5 + 2.5 + 4.2 + 7.1	1115	10.5	8.50	4.68	A++	2543	
	2.0 + 2.5 + 2.5 + 5.0 + 5.0	1165	10.9	8.50	4.68	A++	2543	
	2.0 + 2.5 + 2.5 + 5.0 + 6.0	1165	10.9	8.50	4.68	A++	2543	
	2.0 + 2.5 + 3.5 + 3.5 + 3.5	1090	10.2	8.50	4.68	A++	2543	
	2.0 + 2.5 + 3.5 + 3.5 + 4.2	1090	10.2	8.50	4.68	A++	2543	
	2.0 + 2.5 + 3.5 + 3.5 + 5.0	1115	10.5	8.50	4.68	A++	2543	
	2.0 + 2.5 + 3.5 + 3.5 + 6.0	1115	10.5	8.50	4.68	A++	2543	
	2.0 + 2.5 + 3.5 + 4.2 + 4.2	1085	10.2	8.50	4.68	A++	2543	
	2.0 + 2.5 + 3.5 + 4.2 + 5.0	1130	10.6	8.50	4.68	A++	2543	
	2.0 + 2.5 + 3.5 + 4.2 + 6.0	1130	10.6	8.50	4.68	A++	2543	
	2.0 + 2.5 + 3.5 + 5.0 + 5.0	1180	11.1	8.50	4.68	A++	2543	
	2.0 + 2.5 + 4.2 + 4.2 + 4.2	1085	10.2	8.50	4.68	A++	2543	
	2.0 + 2.5 + 4.2 + 4.2 + 5.0	1130	10.6	8.50	4.68	A++	2543	
	2.0 + 3.5 + 3.5 + 3.5 + 3.5	1085	10.2	8.50	4.68	A++	2543	
	2.0 + 3.5 + 3.5 + 3.5 + 4.2	1085	10.2	8.50	4.68	A++	2543	
	2.0 + 3.5 + 3.5 + 3.5 + 5.0	1130	10.6	8.50	4.68	A++	2543	
	2.0 + 3.5 + 3.5 + 4.2 + 4.2	1100	10.3	8.50	4.68	A++	2543	
	2.0 + 3.5 + 3.5 + 4.2 + 5.0	1130	10.6	8.50	4.68	A++	2543	
	2.0 + 3.5 + 4.2 + 4.2 + 4.2	1100	10.3	8.50	4.68	A++	2543	
	2.5 + 2.5 + 2.5 + 2.5 + 2.5	1065	10.0	8.50	4.68	A++	2543	
	2.5 + 2.5 + 2.5 + 2.5 + 3.5	1080	10.2	8.50	4.68	A++	2543	
2.5 + 2.5 + 2.5 + 2.5 + 4.2	1080	10.2	8.50	4.68	A++	2543		
2.5 + 2.5 + 2.5 + 2.5 + 5.0	1100	10.3	8.50	4.68	A++	2543		
2.5 + 2.5 + 2.5 + 2.5 + 6.0	1100	10.3	8.50	4.68	A++	2543		
2.5 + 2.5 + 2.5 + 2.5 + 7.1	1095	10.3	8.50	4.68	A++	2543		
2.5 + 2.5 + 2.5 + 3.5 + 3.5	1075	10.1	8.50	4.68	A++	2543		
2.5 + 2.5 + 2.5 + 3.5 + 4.2	1075	10.1	8.50	4.68	A++	2543		
2.5 + 2.5 + 2.5 + 3.5 + 5.0	1115	10.5	8.50	4.68	A++	2543		
2.5 + 2.5 + 2.5 + 3.5 + 6.0	1115	10.5	8.50	4.68	A++	2543		

Indoor unit capacity Heating		Total	Heating Capacity (kW)							Input Power (W)		COP	
			Room A	Room B	Room C	Room D	Room E	Total	min ~ max	Rating	min ~ max	WW	CLASS
5 Room	2.5 + 2.5 + 2.5 + 3.5 + 7.1	18.1	1.44	1.44	1.44	2.01	4.07	10.40	3.4 ~ 14.5	2230	620 ~ 3590	4.66	A
	2.5 + 2.5 + 2.5 + 4.2 + 4.2	15.9	1.64	1.64	1.64	2.74	2.74	10.40	3.4 ~ 14.5	2180	520 ~ 3590	4.77	A
	2.5 + 2.5 + 2.5 + 4.2 + 5.0	16.7	1.56	1.56	1.56	2.62	3.10	10.40	3.4 ~ 14.5	2230	610 ~ 3590	4.66	A
	2.5 + 2.5 + 2.5 + 4.2 + 6.0	17.7	1.47	1.47	1.47	2.47	3.52	10.40	3.4 ~ 14.5	2230	610 ~ 3590	4.66	A
	2.5 + 2.5 + 2.5 + 5.0 + 5.0	17.5	1.49	1.49	1.49	2.96	2.96	10.39	3.4 ~ 14.5	2330	720 ~ 3660	4.46	A
	2.5 + 2.5 + 3.5 + 3.5 + 3.5	15.5	1.67	1.67	2.35	2.35	2.35	10.39	3.4 ~ 14.5	2180	520 ~ 3640	4.77	A
	2.5 + 2.5 + 3.5 + 3.5 + 4.2	16.2	1.60	1.60	2.25	2.25	2.70	10.40	3.4 ~ 14.5	2180	530 ~ 3630	4.77	A
	2.5 + 2.5 + 3.5 + 3.5 + 5.0	17.0	1.53	1.53	2.14	2.14	3.06	10.40	3.4 ~ 14.5	2230	630 ~ 3630	4.66	A
	2.5 + 2.5 + 3.5 + 3.5 + 6.0	18.0	1.44	1.44	2.02	2.02	3.48	10.40	3.4 ~ 14.5	2230	630 ~ 3630	4.66	A
	2.5 + 2.5 + 3.5 + 4.2 + 4.2	16.9	1.54	1.54	2.16	2.58	2.58	10.40	3.4 ~ 14.5	2170	540 ~ 3620	4.79	A
	2.5 + 2.5 + 3.5 + 4.2 + 5.0	17.7	1.47	1.47	2.06	2.47	2.93	10.40	3.4 ~ 14.5	2260	630 ~ 3620	4.60	A
	2.5 + 2.5 + 4.2 + 4.2 + 4.2	17.6	1.48	1.48	2.48	2.48	2.48	10.40	3.4 ~ 14.5	2170	540 ~ 3610	4.79	A
	2.5 + 3.5 + 3.5 + 3.5 + 3.5	16.5	1.56	2.21	2.21	2.21	2.21	10.40	3.4 ~ 14.5	2170	540 ~ 3610	4.79	A
	2.5 + 3.5 + 3.5 + 3.5 + 4.2	17.2	1.51	2.12	2.12	2.12	2.53	10.40	3.4 ~ 14.5	2170	550 ~ 3600	4.79	A
	2.5 + 3.5 + 3.5 + 3.5 + 5.0	18.0	1.44	2.02	2.02	2.02	2.90	10.40	3.4 ~ 14.5	2260	650 ~ 3610	4.60	A
2.5 + 3.5 + 3.5 + 4.2 + 4.2	17.9	1.46	2.03	2.03	2.44	2.44	10.40	3.4 ~ 14.5	2200	560 ~ 3590	4.73	A	
3.5 + 3.5 + 3.5 + 3.5 + 3.5	17.5	2.08	2.08	2.08	2.08	2.08	10.40	3.4 ~ 14.5	2200	570 ~ 3580	4.73	A	
3.5 + 3.5 + 3.5 + 3.5 + 4.2	18.2	2.00	2.00	2.00	2.00	2.40	10.40	3.4 ~ 14.5	2200	570 ~ 3630	4.73	A	

	Indoor unit capacity Heating	Annual Energy Consumption (kWh)	Current 230V (A)	ERP				Moisture Removal Volume l/h
				Pdesign (kW)	SCOP		Annual Consumption (kWh)	
					W/W	CLASS		
5 Room	2.5 + 2.5 + 2.5 + 3.5 + 7.1	1115	10.5	8.50	4.68	A++	2543	
	2.5 + 2.5 + 2.5 + 4.2 + 4.2	1090	10.2	8.50	4.68	A++	2543	
	2.5 + 2.5 + 2.5 + 4.2 + 5.0	1115	10.5	8.50	4.68	A++	2543	
	2.5 + 2.5 + 2.5 + 4.2 + 6.0	1115	10.5	8.50	4.68	A++	2543	
	2.5 + 2.5 + 2.5 + 5.0 + 5.0	1165	10.9	8.50	4.68	A++	2543	
	2.5 + 2.5 + 3.5 + 3.5 + 3.5	1090	10.2	8.50	4.68	A++	2543	
	2.5 + 2.5 + 3.5 + 3.5 + 4.2	1090	10.2	8.50	4.68	A++	2543	
	2.5 + 2.5 + 3.5 + 3.5 + 5.0	1115	10.5	8.50	4.68	A++	2543	
	2.5 + 2.5 + 3.5 + 3.5 + 6.0	1115	10.5	8.50	4.68	A++	2543	
	2.5 + 2.5 + 3.5 + 4.2 + 4.2	1085	10.2	8.50	4.68	A++	2543	
	2.5 + 2.5 + 3.5 + 4.2 + 5.0	1130	10.6	8.50	4.68	A++	2543	
	2.5 + 2.5 + 4.2 + 4.2 + 4.2	1085	10.2	8.50	4.68	A++	2543	
	2.5 + 3.5 + 3.5 + 3.5 + 3.5	1085	10.2	8.50	4.68	A++	2543	
	2.5 + 3.5 + 3.5 + 3.5 + 4.2	1085	10.2	8.50	4.68	A++	2543	
	2.5 + 3.5 + 3.5 + 3.5 + 5.0	1130	10.6	8.50	4.68	A++	2543	
	2.5 + 3.5 + 3.5 + 4.2 + 4.2	1100	10.3	8.50	4.68	A++	2543	
3.5 + 3.5 + 3.5 + 3.5 + 3.5	1100	10.3	8.50	4.68	A++	2543		
3.5 + 3.5 + 3.5 + 3.5 + 4.2	1100	10.3	8.50	4.68	A++	2543		

- Indoor Unit : Combination of all wall mount series (CS-MZ / Z / XZ / MTZ / TZ / TE)
- Outdoor Unit : CU-5Z90TBE

Indoor unit capacity Cooling	Total	Cooling Capacity (kW)							Input Power (W)		EER		
		Room A	Room B	Room C	Room D	Room E	Total	min ~ max	Rating	min ~ max	WW	CLASS	
1 Room	1.6	1.6	1.60					1.60	1.3 ~ 2.3	420	250 ~ 660	3.81	A
	2.0	2.0	2.00					2.00	1.8 ~ 2.9	520	340 ~ 830	3.85	A
	2.5	2.5	2.50					2.50	1.8 ~ 2.9	650	340 ~ 830	3.85	A
	3.5	3.5	3.50					3.50	1.8 ~ 4.1	960	340 ~ 1380	3.65	A
	4.2	4.2	4.20					4.20	1.8 ~ 4.5	1390	340 ~ 2010	3.02	B
	5.0	5.0	5.00					5.00	1.9 ~ 5.7	1570	340 ~ 2150	3.18	B
	6.0	6.0	6.00					6.00	1.9 ~ 6.2	2050	340 ~ 2350	2.93	C
	7.1	7.1	7.10					7.10	2.0 ~ 7.2	2550	370 ~ 2790	2.78	D
2 Room	1.6 + 1.6	3.2	1.60	1.60				3.20	2.4 ~ 5.8	700	270 ~ 1780	4.57	A
	1.6 + 2.0	3.6	1.60	2.00				3.60	2.4 ~ 5.8	830	270 ~ 1780	4.34	A
	1.6 + 2.5	4.1	1.60	2.50				4.10	2.4 ~ 5.8	1000	270 ~ 1780	4.10	A
	1.6 + 3.5	5.1	1.60	3.50				5.10	2.4 ~ 5.8	1360	260 ~ 1720	3.75	A
	1.6 + 4.2	5.8	1.60	4.20				5.80	2.4 ~ 6.7	1670	260 ~ 2170	3.47	A
	1.6 + 5.0	6.6	1.60	5.00				6.60	2.4 ~ 7.2	1880	250 ~ 2170	3.51	A
	1.6 + 6.0	7.6	1.60	6.00				7.60	2.4 ~ 8.6	2410	250 ~ 3120	3.15	B
	1.6 + 7.1	8.7	1.60	7.10				8.70	2.5 ~ 9.1	2960	270 ~ 3200	2.94	C
	2.0 + 2.0	4.0	2.00	2.00				4.00	2.4 ~ 5.8	960	260 ~ 1720	4.17	A
	2.0 + 2.5	4.5	2.00	2.50				4.50	2.4 ~ 5.8	1160	260 ~ 1720	3.88	A
	2.0 + 3.5	5.5	2.00	3.50				5.50	2.4 ~ 5.8	1510	260 ~ 1670	3.64	A
	2.0 + 4.2	6.2	2.00	4.20				6.20	2.4 ~ 7.2	1880	260 ~ 2530	3.30	A
	2.0 + 5.0	7.0	2.00	5.00				7.00	2.4 ~ 8.1	1990	250 ~ 2650	3.52	A
	2.0 + 6.0	8.0	2.00	6.00				8.00	2.4 ~ 8.6	2590	250 ~ 3050	3.09	B
	2.0 + 7.1	9.1	1.98	7.02				9.00	2.5 ~ 10.0	3160	270 ~ 4070	2.85	C
	2.5 + 2.5	5.0	2.50	2.50				5.00	2.4 ~ 5.8	1310	260 ~ 1720	3.82	A
	2.5 + 3.5	6.0	2.50	3.50				6.00	2.4 ~ 6.7	1770	260 ~ 2170	3.39	A
	2.5 + 4.2	6.7	2.50	4.20				6.70	2.4 ~ 7.2	2170	260 ~ 2530	3.09	B
	2.5 + 5.0	7.5	2.50	5.00				7.50	2.4 ~ 8.6	2290	250 ~ 3050	3.28	A
	2.5 + 6.0	8.5	2.50	6.00				8.50	2.5 ~ 9.1	2980	270 ~ 3330	2.85	C
	2.5 + 7.1	9.6	2.34	6.66				9.00	2.5 ~ 10.1	3160	270 ~ 4220	2.85	C
	3.5 + 3.5	7.0	3.50	3.50				7.00	2.4 ~ 8.1	2290	260 ~ 3100	3.06	B
	3.5 + 4.2	7.7	3.50	4.20				7.70	2.4 ~ 8.6	2710	260 ~ 3590	2.84	C
	3.5 + 5.0	8.5	3.50	5.00				8.50	2.5 ~ 9.1	2850	270 ~ 3200	2.98	C
	3.5 + 6.0	9.5	3.32	5.68				9.00	2.5 ~ 10.1	3230	270 ~ 4220	2.79	D
	3.5 + 7.1	10.6	2.97	6.03				9.00	2.5 ~ 10.4	3030	270 ~ 4380	2.97	C
	4.2 + 4.2	8.4	4.20	4.20				8.40	2.5 ~ 9.1	3380	280 ~ 4000	2.49	E
4.2 + 5.0	9.2	4.11	4.89				9.00	2.5 ~ 10.0	3160	270 ~ 4070	2.85	C	
4.2 + 6.0	10.2	3.71	5.29				9.00	2.5 ~ 10.4	3160	270 ~ 4370	2.85	C	
4.2 + 7.1	11.3	3.35	5.65				9.00	2.5 ~ 10.4	3030	270 ~ 4380	2.97	C	
5.0 + 5.0	10.0	4.50	4.50				9.00	2.5 ~ 10.4	2700	260 ~ 3650	3.33	A	
5.0 + 6.0	11.0	4.09	4.91				9.00	2.5 ~ 10.4	2700	260 ~ 3650	3.33	A	
5.0 + 7.1	12.1	3.72	5.28				9.00	2.5 ~ 10.4	2640	260 ~ 3520	3.41	A	
6.0 + 6.0	12.0	4.50	4.50				9.00	2.5 ~ 10.4	2700	260 ~ 3650	3.33	A	
6.0 + 7.1	13.1	4.12	4.88				9.00	2.5 ~ 10.4	2640	260 ~ 3520	3.41	A	
7.1 + 7.1	14.2	4.50	4.50				9.00	2.5 ~ 10.4	2510	290 ~ 3380	3.59	A	

	Indoor unit capacity Cooling	Annual Energy Consumption (kWh)	Current 230V (A)	ERP				Moisture Removal Volume l/h
				Pdesign (kW)	SEER		Annual Consumption (kWh)	
					W/W	CLASS		
1 Room	1.6	210	2.1	-	-	-	-	1.0
	2.0	260	2.6	-	-	-	-	1.3
	2.5	325	3.2	-	-	-	-	1.5
	3.5	480	4.6	-	-	-	-	2.0
	4.2	695	6.5	-	-	-	-	2.4
	5.0	785	7.3	-	-	-	-	2.7
	6.0	1025	9.3	-	-	-	-	3.3
	7.1	1275	11.5	-	-	-	-	4.1
2 Room	1.6 + 1.6	350	3.6	3.20	5.60	A+	200	1.0 + 1.0
	1.6 + 2.0	415	4.1	3.60	5.60	A+	225	1.0 + 1.3
	1.6 + 2.5	500	4.9	4.10	5.60	A+	256	1.0 + 1.5
	1.6 + 3.5	680	6.6	5.10	5.60	A+	319	1.0 + 2.0
	1.6 + 4.2	835	8.1	5.80	5.60	A+	363	1.0 + 2.4
	1.6 + 5.0	940	9.0	6.60	6.10	A++	379	1.0 + 2.7
	1.6 + 6.0	1205	11.5	7.60	6.10	A++	436	1.0 + 3.3
	1.6 + 7.1	1480	14.2	8.70	6.10	A++	499	1.0 + 4.1
	2.0 + 2.0	480	4.7	4.00	5.60	A+	250	1.3 + 1.3
	2.0 + 2.5	580	5.7	4.50	5.60	A+	281	1.3 + 1.5
	2.0 + 3.5	755	7.3	5.50	5.60	A+	344	1.3 + 2.0
	2.0 + 4.2	940	9.0	6.20	5.60	A+	388	1.3 + 2.4
	2.0 + 5.0	995	9.5	7.00	6.10	A++	402	1.3 + 2.7
	2.0 + 6.0	1295	12.4	8.00	6.10	A++	459	1.3 + 3.3
	2.0 + 7.1	1580	15.1	9.00	6.10	A++	516	1.3 + 4.0
	2.5 + 2.5	655	6.3	5.00	5.60	A+	313	1.5 + 1.5
	2.5 + 3.5	885	8.5	6.00	5.60	A+	375	1.5 + 2.0
	2.5 + 4.2	1085	10.4	6.70	5.60	A+	419	1.5 + 2.4
	2.5 + 5.0	1145	11.0	7.50	6.10	A++	430	1.5 + 2.7
	2.5 + 6.0	1490	14.3	8.50	6.10	A++	488	1.5 + 3.3
	2.5 + 7.1	1580	15.1	9.00	6.10	A++	516	1.5 + 3.8
	3.5 + 3.5	1145	11.0	7.00	5.60	A+	438	2.0 + 2.0
	3.5 + 4.2	1355	13.0	7.70	5.60	A+	481	2.0 + 2.4
	3.5 + 5.0	1425	13.6	8.50	6.10	A++	488	2.0 + 2.7
	3.5 + 6.0	1615	15.5	9.00	6.10	A++	516	1.9 + 3.1
	3.5 + 7.1	1515	14.5	9.00	6.10	A++	516	1.7 + 3.3
	4.2 + 4.2	1690	16.2	8.40	5.60	A+	525	2.4 + 2.4
4.2 + 5.0	1580	15.1	9.00	6.10	A++	516	2.3 + 2.7	
4.2 + 6.0	1580	15.1	9.00	6.10	A++	516	2.2 + 2.9	
4.2 + 7.1	1515	14.5	9.00	6.10	A++	516	1.9 + 3.1	
5.0 + 5.0	1350	12.9	9.00	6.10	A++	516	2.5 + 2.5	
5.0 + 6.0	1350	12.9	9.00	6.10	A++	516	2.3 + 2.7	
5.0 + 7.1	1320	12.6	9.00	6.10	A++	516	2.2 + 2.9	
6.0 + 6.0	1350	12.9	9.00	6.10	A++	516	2.5 + 2.5	
6.0 + 7.1	1320	12.6	9.00	6.10	A++	516	2.3 + 2.7	
7.1 + 7.1	1255	12.0	9.00	6.10	A++	516	2.5 + 2.5	

	Indoor unit capacity Cooling	Total	Cooling Capacity (kW)						Input Power (W)		EER		
			Room A	Room B	Room C	Room D	Room E	Total	min ~ max	Rating	min ~ max	WW	CLASS
3 Room	1.6 + 1.6 + 1.6	4.8	1.60	1.60	1.60			4.80	2.9 ~ 8.5	1050	320 ~ 2680	4.57	A
	1.6 + 1.6 + 2.0	5.2	1.60	1.60	2.00			5.20	2.9 ~ 8.5	1160	320 ~ 2680	4.48	A
	1.6 + 1.6 + 2.5	5.7	1.60	1.60	2.50			5.70	2.9 ~ 8.5	1350	320 ~ 2680	4.22	A
	1.6 + 1.6 + 3.5	6.7	1.60	1.60	3.50			6.70	2.9 ~ 8.5	1670	310 ~ 2610	4.01	A
	1.6 + 1.6 + 4.2	7.4	1.60	1.60	4.20			7.40	2.9 ~ 8.5	2010	340 ~ 2550	3.68	A
	1.6 + 1.6 + 5.0	8.2	1.60	1.60	5.00			8.20	2.9 ~ 8.7	2170	340 ~ 2350	3.78	A
	1.6 + 1.6 + 6.0	9.2	1.57	1.57	5.86			9.00	2.9 ~ 10.1	2530	340 ~ 3060	3.56	A
	1.6 + 1.6 + 7.1	10.3	1.40	1.40	6.20			9.00	2.9 ~ 10.7	2470	340 ~ 3400	3.64	A
	1.6 + 2.0 + 2.0	5.6	1.60	2.00	2.00			5.60	2.9 ~ 8.5	1300	310 ~ 2610	4.31	A
	1.6 + 2.0 + 2.5	6.1	1.60	2.00	2.50			6.10	2.9 ~ 8.5	1510	310 ~ 2610	4.04	A
	1.6 + 2.0 + 3.5	7.1	1.60	2.00	3.50			7.10	2.9 ~ 8.5	1840	340 ~ 2550	3.86	A
	1.6 + 2.0 + 4.2	7.8	1.60	2.00	4.20			7.80	2.9 ~ 8.5	2120	340 ~ 2550	3.68	A
	1.6 + 2.0 + 5.0	8.6	1.60	2.00	5.00			8.60	2.9 ~ 9.6	2360	340 ~ 2680	3.64	A
	1.6 + 2.0 + 6.0	9.6	1.49	1.88	5.63			9.00	2.9 ~ 10.1	2470	340 ~ 3000	3.64	A
	1.6 + 2.0 + 7.1	10.7	1.35	1.68	5.97			9.00	2.9 ~ 10.7	2410	340 ~ 3400	3.73	A
	1.6 + 2.5 + 2.5	6.6	1.60	2.50	2.50			6.60	2.9 ~ 8.5	1720	310 ~ 2610	3.84	A
	1.6 + 2.5 + 3.5	7.6	1.60	2.50	3.50			7.60	2.9 ~ 8.5	2120	340 ~ 2550	3.58	A
	1.6 + 2.5 + 4.2	8.3	1.60	2.50	4.20			8.30	2.9 ~ 8.7	2420	340 ~ 2600	3.43	A
	1.6 + 2.5 + 5.0	9.1	1.58	2.47	4.95			9.00	2.9 ~ 10.1	2470	340 ~ 3000	3.64	A
	1.6 + 2.5 + 6.0	10.1	1.42	2.23	5.35			9.00	2.9 ~ 10.7	2470	340 ~ 3540	3.64	A
	1.6 + 2.5 + 7.1	11.2	1.28	2.01	5.71			9.00	2.9 ~ 10.7	2410	340 ~ 3400	3.73	A
	1.6 + 3.5 + 3.5	8.6	1.60	3.50	3.50			8.60	2.9 ~ 9.6	2550	340 ~ 2990	3.37	A
	1.6 + 3.5 + 4.2	9.3	1.55	3.39	4.06			9.00	2.9 ~ 10.1	2720	340 ~ 3390	3.31	A
	1.6 + 3.5 + 5.0	10.1	1.42	3.12	4.46			9.00	2.9 ~ 10.7	2470	340 ~ 3400	3.64	A
	1.6 + 3.5 + 6.0	11.1	1.30	2.84	4.86			9.00	2.9 ~ 10.7	2470	340 ~ 3400	3.64	A
	1.6 + 3.5 + 7.1	12.2	1.18	2.58	5.24			9.00	2.9 ~ 10.7	2410	340 ~ 3260	3.73	A
	1.6 + 4.2 + 4.2	10.0	1.44	3.78	3.78			9.00	2.9 ~ 10.7	2720	340 ~ 3970	3.31	A
	1.6 + 4.2 + 5.0	10.8	1.33	3.50	4.17			9.00	2.9 ~ 10.7	2410	340 ~ 3400	3.73	A
	1.6 + 4.2 + 6.0	11.8	1.22	3.20	4.58			9.00	2.9 ~ 10.7	2410	340 ~ 3400	3.73	A
	1.6 + 4.2 + 7.1	12.9	1.12	2.93	4.95			9.00	2.9 ~ 10.7	2340	370 ~ 3260	3.85	A
	1.6 + 5.0 + 5.0	11.6	1.24	3.88	3.88			9.00	2.9 ~ 10.7	2220	370 ~ 3000	4.05	A
	1.6 + 5.0 + 6.0	12.6	1.14	3.57	4.29			9.00	2.9 ~ 10.7	2220	370 ~ 3000	4.05	A
	1.6 + 5.0 + 7.1	13.7	1.05	3.28	4.67			9.00	3.0 ~ 10.7	2230	400 ~ 2930	4.04	A
	1.6 + 6.0 + 6.0	13.6	1.06	3.97	3.97			9.00	3.0 ~ 10.7	2220	400 ~ 3000	4.05	A
	1.6 + 6.0 + 7.1	14.7	0.98	3.67	4.35			9.00	3.0 ~ 10.7	2230	400 ~ 2930	4.04	A
	1.6 + 7.1 + 7.1	15.8	0.92	4.04	4.04			9.00	3.0 ~ 10.7	2170	400 ~ 2870	4.15	A
	2.0 + 2.0 + 2.0	6.0	2.00	2.00	2.00			6.00	2.9 ~ 8.5	1450	310 ~ 2610	4.14	A
	2.0 + 2.0 + 2.5	6.5	2.00	2.00	2.50			6.50	2.9 ~ 8.5	1660	310 ~ 2610	3.92	A
	2.0 + 2.0 + 3.5	7.5	2.00	2.00	3.50			7.50	2.9 ~ 8.5	2010	340 ~ 2550	3.73	A
	2.0 + 2.0 + 4.2	8.2	2.00	2.00	4.20			8.20	2.9 ~ 8.7	2360	340 ~ 2600	3.47	A
	2.0 + 2.0 + 5.0	9.0	2.00	2.00	5.00			9.00	2.9 ~ 9.6	2470	340 ~ 2680	3.64	A
	2.0 + 2.0 + 6.0	10.0	1.80	1.80	5.40			9.00	2.9 ~ 10.7	2470	340 ~ 3470	3.64	A
2.0 + 2.0 + 7.1	11.1	1.62	1.62	5.76			9.00	2.9 ~ 10.7	2410	340 ~ 3330	3.73	A	
2.0 + 2.5 + 2.5	7.0	2.00	2.50	2.50			7.00	2.9 ~ 8.5	1840	310 ~ 2610	3.80	A	
2.0 + 2.5 + 3.5	8.0	2.00	2.50	3.50			8.00	2.9 ~ 8.5	2240	340 ~ 2550	3.57	A	
2.0 + 2.5 + 4.2	8.7	2.00	2.50	4.20			8.70	2.9 ~ 9.6	2600	340 ~ 3060	3.35	A	
2.0 + 2.5 + 5.0	9.5	1.89	2.37	4.74			9.00	2.9 ~ 10.1	2470	340 ~ 3000	3.64	A	
2.0 + 2.5 + 6.0	10.5	1.71	2.14	5.15			9.00	2.9 ~ 10.7	2470	340 ~ 3470	3.64	A	
2.0 + 2.5 + 7.1	11.6	1.55	1.94	5.51			9.00	2.9 ~ 10.7	2410	340 ~ 3330	3.73	A	
2.0 + 3.5 + 3.5	9.0	2.00	3.50	3.50			9.00	2.9 ~ 9.6	2720	340 ~ 2990	3.31	A	
2.0 + 3.5 + 4.2	9.7	1.85	3.25	3.90			9.00	2.9 ~ 10.7	2720	340 ~ 3970	3.31	A	
2.0 + 3.5 + 5.0	10.5	1.71	3.00	4.29			9.00	2.9 ~ 10.7	2410	340 ~ 3400	3.73	A	
2.0 + 3.5 + 6.0	11.5	1.56	2.74	4.70			9.00	2.9 ~ 10.7	2410	340 ~ 3400	3.73	A	
2.0 + 3.5 + 7.1	12.6	1.43	2.50	5.07			9.00	2.9 ~ 10.7	2340	370 ~ 3260	3.85	A	
2.0 + 4.2 + 4.2	10.4	1.74	3.63	3.63			9.00	2.9 ~ 10.7	2660	340 ~ 3970	3.38	A	
2.0 + 4.2 + 5.0	11.2	1.60	3.38	4.02			9.00	2.9 ~ 10.7	2410	340 ~ 3330	3.73	A	
2.0 + 4.2 + 6.0	12.2	1.47	3.10	4.43			9.00	2.9 ~ 10.7	2410	340 ~ 3330	3.73	A	
2.0 + 4.2 + 7.1	13.3	1.35	2.84	4.81			9.00	2.9 ~ 10.7	2340	370 ~ 3260	3.85	A	

	Indoor unit capacity Cooling	Annual Energy Consumption (kWh)	Current 230V (A)	ERP				Moisture Removal Volume l/h
				Pdesign (kW)	SEER		Annual Consumption (kWh)	
					WW	CLASS		
3 Room	1.6 + 1.6 + 1.6	525	5.1	4.80	7.20	A++	233	1.0 + 1.0 + 1.0
	1.6 + 1.6 + 2.0	580	5.7	5.20	7.20	A++	253	1.0 + 1.0 + 1.3
	1.6 + 1.6 + 2.5	675	6.5	5.70	7.20	A++	277	1.0 + 1.0 + 1.5
	1.6 + 1.6 + 3.5	835	8.1	6.70	7.20	A++	326	1.0 + 1.0 + 2.0
	1.6 + 1.6 + 4.2	1005	9.6	7.40	7.20	A++	360	1.0 + 1.0 + 2.4
	1.6 + 1.6 + 5.0	1085	10.4	8.20	7.20	A++	399	1.0 + 1.0 + 2.7
	1.6 + 1.6 + 6.0	1265	12.1	9.00	7.20	A++	438	1.0 + 1.0 + 3.2
	1.6 + 1.6 + 7.1	1235	11.8	9.00	7.20	A++	438	0.9 + 0.9 + 3.5
	1.6 + 2.0 + 2.0	650	6.3	5.60	7.20	A++	272	1.0 + 1.3 + 1.3
	1.6 + 2.0 + 2.5	755	7.3	6.10	7.20	A++	297	1.0 + 1.3 + 1.5
	1.6 + 2.0 + 3.5	920	8.8	7.10	7.20	A++	345	1.0 + 1.3 + 2.0
	1.6 + 2.0 + 4.2	1060	10.1	7.80	7.20	A++	379	1.0 + 1.3 + 2.4
	1.6 + 2.0 + 5.0	1180	11.3	8.60	7.20	A++	418	1.0 + 1.3 + 2.7
	1.6 + 2.0 + 6.0	1235	11.8	9.00	7.20	A++	438	0.9 + 1.2 + 3.1
	1.6 + 2.0 + 7.1	1205	11.5	9.00	7.20	A++	438	0.9 + 1.1 + 3.3
	1.6 + 2.5 + 2.5	860	8.3	6.60	7.20	A++	321	1.0 + 1.5 + 1.5
	1.6 + 2.5 + 3.5	1060	10.1	7.60	7.20	A++	369	1.0 + 1.5 + 2.0
	1.6 + 2.5 + 4.2	1210	11.6	8.30	7.20	A++	403	1.0 + 1.5 + 2.4
	1.6 + 2.5 + 5.0	1235	11.8	9.00	7.20	A++	438	1.0 + 1.5 + 2.7
	1.6 + 2.5 + 6.0	1235	11.8	9.00	7.20	A++	438	0.9 + 1.5 + 2.9
	1.6 + 2.5 + 7.1	1205	11.5	9.00	7.20	A++	438	0.8 + 1.3 + 3.1
	1.6 + 3.5 + 3.5	1275	12.2	8.60	7.20	A++	418	1.0 + 2.0 + 2.0
	1.6 + 3.5 + 4.2	1360	13.0	9.00	7.20	A++	438	1.0 + 1.9 + 2.3
	1.6 + 3.5 + 5.0	1235	11.8	9.00	7.20	A++	438	0.9 + 1.8 + 2.5
	1.6 + 3.5 + 6.0	1235	11.8	9.00	7.20	A++	438	0.8 + 1.7 + 2.6
	1.6 + 3.5 + 7.1	1205	11.5	9.00	7.20	A++	438	0.7 + 1.6 + 2.9
	1.6 + 4.2 + 4.2	1360	13.0	9.00	7.20	A++	438	0.9 + 2.2 + 2.2
	1.6 + 4.2 + 5.0	1205	11.5	9.00	7.20	A++	438	0.8 + 2.0 + 2.4
	1.6 + 4.2 + 6.0	1205	11.5	9.00	7.20	A++	438	0.8 + 1.8 + 2.5
	1.6 + 4.2 + 7.1	1170	11.2	9.00	7.20	A++	438	0.7 + 1.7 + 2.7
	1.6 + 5.0 + 5.0	1110	10.6	9.00	7.20	A++	438	0.8 + 2.3 + 2.3
	1.6 + 5.0 + 6.0	1110	10.6	9.00	7.20	A++	438	0.7 + 2.1 + 2.4
	1.6 + 5.0 + 7.1	1115	10.7	9.00	7.20	A++	438	0.7 + 1.9 + 2.5
	1.6 + 6.0 + 6.0	1110	10.6	9.00	7.20	A++	438	0.7 + 2.3 + 2.3
	1.6 + 6.0 + 7.1	1115	10.7	9.00	7.20	A++	438	0.7 + 2.1 + 2.4
	1.6 + 7.1 + 7.1	1085	10.4	9.00	7.20	A++	438	0.7 + 2.3 + 2.3
	2.0 + 2.0 + 2.0	725	7.0	6.00	7.20	A++	292	1.3 + 1.3 + 1.3
	2.0 + 2.0 + 2.5	830	8.0	6.50	7.20	A++	316	1.3 + 1.3 + 1.5
	2.0 + 2.0 + 3.5	1005	9.6	7.50	7.20	A++	365	1.3 + 1.3 + 2.0
	2.0 + 2.0 + 4.2	1180	11.3	8.20	7.20	A++	399	1.3 + 1.3 + 2.4
2.0 + 2.0 + 5.0	1235	11.8	9.00	7.20	A++	438	1.3 + 1.3 + 2.7	
2.0 + 2.0 + 6.0	1235	11.8	9.00	7.20	A++	438	1.2 + 1.2 + 2.9	
2.0 + 2.0 + 7.1	1205	11.5	9.00	7.20	A++	438	1.0 + 1.0 + 3.2	
2.0 + 2.5 + 2.5	920	8.8	7.00	7.20	A++	340	1.3 + 1.5 + 1.5	
2.0 + 2.5 + 3.5	1120	10.7	8.00	7.20	A++	389	1.3 + 1.5 + 2.0	
2.0 + 2.5 + 4.2	1300	12.4	8.70	7.20	A++	423	1.3 + 1.5 + 2.4	
2.0 + 2.5 + 5.0	1235	11.8	9.00	7.20	A++	438	1.2 + 1.5 + 2.6	
2.0 + 2.5 + 6.0	1235	11.8	9.00	7.20	A++	438	1.1 + 1.4 + 2.8	
2.0 + 2.5 + 7.1	1205	11.5	9.00	7.20	A++	438	1.0 + 1.3 + 3.0	
2.0 + 3.5 + 3.5	1360	13.0	9.00	7.20	A++	438	1.3 + 2.0 + 2.0	
2.0 + 3.5 + 4.2	1360	13.0	9.00	7.20	A++	438	1.2 + 1.8 + 2.3	
2.0 + 3.5 + 5.0	1205	11.5	9.00	7.20	A++	438	1.1 + 1.7 + 2.4	
2.0 + 3.5 + 6.0	1205	11.5	9.00	7.20	A++	438	1.0 + 1.6 + 2.5	
2.0 + 3.5 + 7.1	1170	11.2	9.00	7.20	A++	438	0.9 + 1.5 + 2.8	
2.0 + 4.2 + 4.2	1330	12.7	9.00	7.20	A++	438	1.1 + 2.1 + 2.1	
2.0 + 4.2 + 5.0	1205	11.5	9.00	7.20	A++	438	1.0 + 1.9 + 2.3	
2.0 + 4.2 + 6.0	1205	11.5	9.00	7.20	A++	438	0.9 + 1.7 + 2.5	
2.0 + 4.2 + 7.1	1170	11.2	9.00	7.20	A++	438	0.9 + 1.7 + 2.6	

Indoor unit capacity Cooling	Total	Cooling Capacity (kW)							Input Power (W)		EER	
		Room A	Room B	Room C	Room D	Room E	Total	min ~ max	Rating	min ~ max	WW	CLASS
2.0 + 5.0 + 5.0	12.0	1.50	3.75	3.75			9.00	2.9 ~ 10.7	2220	370 ~ 3000	4.05	A
2.0 + 5.0 + 6.0	13.0	1.38	3.46	4.16			9.00	2.9 ~ 10.7	2220	370 ~ 3000	4.05	A
2.0 + 5.0 + 7.1	14.1	1.28	3.19	4.53			9.00	3.0 ~ 10.7	2230	400 ~ 2930	4.04	A
2.0 + 6.0 + 6.0	14.0	1.28	3.86	3.86			9.00	3.0 ~ 10.7	2220	400 ~ 3000	4.05	A
2.0 + 6.0 + 7.1	15.1	1.19	3.58	4.23			9.00	3.0 ~ 10.7	2230	400 ~ 2930	4.04	A
2.0 + 7.1 + 7.1	16.2	1.12	3.94	3.94			9.00	3.0 ~ 10.7	2170	410 ~ 2870	4.15	A
2.5 + 2.5 + 2.5	7.5	2.50	2.50	2.50			7.50	2.9 ~ 8.5	2070	310 ~ 2610	3.62	A
2.5 + 2.5 + 3.5	8.5	2.50	2.50	3.50			8.50	2.9 ~ 9.6	2550	340 ~ 3060	3.33	A
2.5 + 2.5 + 4.2	9.2	2.45	2.45	4.10			9.00	2.9 ~ 10.1	2790	340 ~ 3460	3.23	A
2.5 + 2.5 + 5.0	10.0	2.25	2.25	4.50			9.00	2.9 ~ 10.7	2470	340 ~ 3470	3.64	A
2.5 + 2.5 + 6.0	11.0	2.05	2.05	4.90			9.00	2.9 ~ 10.7	2470	340 ~ 3470	3.64	A
2.5 + 2.5 + 7.1	12.1	1.86	1.86	5.28			9.00	2.9 ~ 10.7	2410	340 ~ 3330	3.73	A
2.5 + 3.5 + 3.5	9.5	2.36	3.32	3.32			9.00	2.9 ~ 10.1	2720	340 ~ 3390	3.31	A
2.5 + 3.5 + 4.2	10.2	2.20	3.09	3.71			9.00	2.9 ~ 10.7	2720	340 ~ 3970	3.31	A
2.5 + 3.5 + 5.0	11.0	2.05	2.86	4.09			9.00	2.9 ~ 10.7	2410	340 ~ 3400	3.73	A
2.5 + 3.5 + 6.0	12.0	1.87	2.63	4.50			9.00	2.9 ~ 10.7	2410	340 ~ 3400	3.73	A
2.5 + 3.5 + 7.1	13.1	1.72	2.40	4.88			9.00	2.9 ~ 10.7	2340	370 ~ 3260	3.85	A
2.5 + 4.2 + 4.2	10.9	2.06	3.47	3.47			9.00	2.9 ~ 10.7	2660	340 ~ 3970	3.38	A
2.5 + 4.2 + 5.0	11.7	1.92	3.23	3.85			9.00	2.9 ~ 10.7	2410	340 ~ 3330	3.73	A
2.5 + 4.2 + 6.0	12.7	1.77	2.98	4.25			9.00	2.9 ~ 10.7	2410	340 ~ 3330	3.73	A
2.5 + 4.2 + 7.1	13.8	1.63	2.74	4.63			9.00	3.0 ~ 10.7	2340	370 ~ 3260	3.85	A
2.5 + 5.0 + 5.0	12.5	1.80	3.60	3.60			9.00	2.9 ~ 10.7	2220	370 ~ 3000	4.05	A
2.5 + 5.0 + 6.0	13.5	1.67	3.33	4.00			9.00	3.0 ~ 10.7	2220	400 ~ 3000	4.05	A
2.5 + 5.0 + 7.1	14.6	1.54	3.08	4.38			9.00	3.0 ~ 10.7	2230	400 ~ 2930	4.04	A
2.5 + 6.0 + 6.0	14.5	1.56	3.72	3.72			9.00	3.0 ~ 10.7	2220	400 ~ 3000	4.05	A
2.5 + 6.0 + 7.1	15.6	1.44	3.46	4.10			9.00	3.0 ~ 10.7	2230	400 ~ 2930	4.04	A
2.5 + 7.1 + 7.1	16.7	1.34	3.83	3.83			9.00	3.0 ~ 10.7	2170	410 ~ 2870	4.15	A
3.5 + 3.5 + 3.5	10.5	3.00	3.00	3.00			9.00	2.9 ~ 10.7	2660	340 ~ 3890	3.38	A
3.5 + 3.5 + 4.2	11.2	2.81	2.81	3.38			9.00	2.9 ~ 10.7	2660	340 ~ 3820	3.38	A
3.5 + 3.5 + 5.0	12.0	2.63	2.63	3.74			9.00	2.9 ~ 10.7	2410	340 ~ 3260	3.73	A
3.5 + 3.5 + 6.0	13.0	2.42	2.42	4.16			9.00	2.9 ~ 10.7	2410	340 ~ 3260	3.73	A
3.5 + 3.5 + 7.1	14.1	2.23	2.23	4.54			9.00	3.0 ~ 10.7	2340	370 ~ 3200	3.85	A
3.5 + 4.2 + 4.2	11.9	2.64	3.18	3.18			9.00	2.9 ~ 10.7	2590	340 ~ 3820	3.47	A
3.5 + 4.2 + 5.0	12.7	2.48	2.98	3.54			9.00	2.9 ~ 10.7	2340	370 ~ 3260	3.85	A
3.5 + 4.2 + 6.0	13.7	2.30	2.76	3.94			9.00	3.0 ~ 10.7	2340	370 ~ 3260	3.85	A
3.5 + 4.2 + 7.1	14.8	2.13	2.55	4.32			9.00	3.0 ~ 10.7	2340	370 ~ 3200	3.85	A
3.5 + 5.0 + 5.0	13.5	2.34	3.33	3.33			9.00	3.0 ~ 10.7	2230	400 ~ 2930	4.04	A
3.5 + 5.0 + 6.0	14.5	2.17	3.10	3.73			9.00	3.0 ~ 10.7	2230	400 ~ 2930	4.04	A
3.5 + 5.0 + 7.1	15.6	2.02	2.88	4.10			9.00	3.0 ~ 10.7	2170	400 ~ 2870	4.15	A
3.5 + 6.0 + 6.0	15.5	2.04	3.48	3.48			9.00	3.0 ~ 10.7	2230	400 ~ 2930	4.04	A
3.5 + 6.0 + 7.1	16.6	1.90	3.25	3.85			9.00	3.0 ~ 10.7	2170	400 ~ 2870	4.15	A
3.5 + 7.1 + 7.1	17.7	1.78	3.61	3.61			9.00	3.0 ~ 10.7	2170	430 ~ 2870	4.15	A
4.2 + 4.2 + 4.2	12.6	3.00	3.00	3.00			9.00	2.9 ~ 10.7	2590	340 ~ 3750	3.47	A
4.2 + 4.2 + 5.0	13.4	2.82	2.82	3.36			9.00	2.9 ~ 10.7	2340	370 ~ 3260	3.85	A
4.2 + 4.2 + 6.0	14.4	2.63	2.63	3.74			9.00	3.0 ~ 10.7	2340	370 ~ 3260	3.85	A
4.2 + 4.2 + 7.1	15.5	2.44	2.44	4.12			9.00	3.0 ~ 10.7	2340	370 ~ 3130	3.85	A
4.2 + 5.0 + 5.0	14.2	2.66	3.17	3.17			9.00	3.0 ~ 10.7	2230	400 ~ 2930	4.04	A
4.2 + 5.0 + 6.0	15.2	2.49	2.96	3.55			9.00	3.0 ~ 10.7	2230	400 ~ 2930	4.04	A
4.2 + 5.0 + 7.1	16.3	2.32	2.76	3.92			9.00	3.0 ~ 10.7	2170	410 ~ 2870	4.15	A
4.2 + 6.0 + 6.0	16.2	2.34	3.33	3.33			9.00	3.0 ~ 10.7	2230	400 ~ 2930	4.04	A
4.2 + 6.0 + 7.1	17.3	2.18	3.12	3.70			9.00	3.0 ~ 10.7	2170	410 ~ 2870	4.15	A
5.0 + 5.0 + 5.0	15.0	3.00	3.00	3.00			9.00	3.0 ~ 10.7	2120	440 ~ 2740	4.25	A
5.0 + 5.0 + 6.0	16.0	2.81	2.81	3.38			9.00	3.0 ~ 10.7	2120	440 ~ 2740	4.25	A
5.0 + 5.0 + 7.1	17.1	2.63	2.63	3.74			9.00	3.0 ~ 10.7	2120	470 ~ 2750	4.25	A
5.0 + 6.0 + 6.0	17.0	2.64	3.18	3.18			9.00	3.0 ~ 10.7	2120	440 ~ 2740	4.25	A
5.0 + 6.0 + 7.1	18.1	2.49	2.98	3.53			9.00	3.0 ~ 10.7	2120	470 ~ 2750	4.25	A
6.0 + 6.0 + 6.0	18.0	3.00	3.00	3.00			9.00	3.0 ~ 10.7	2120	440 ~ 2740	4.25	A

3  
Room



	Indoor unit capacity Cooling	Annual Energy Consumption (kWh)	Current 230V (A)	ERP			Moisture Removal Volume l/h	
				Pdesign (kW)	SEER			Annual Consumption (kWh)
					WW	CLASS		
3 Room	2.0 + 5.0 + 5.0	1110	10.6	9.00	7.20	A++	438	1.0 + 2.2 + 2.2
	2.0 + 5.0 + 6.0	1110	10.6	9.00	7.20	A++	438	0.9 + 2.0 + 2.4
	2.0 + 5.0 + 7.1	1115	10.7	9.00	7.20	A++	438	0.8 + 1.8 + 2.5
	2.0 + 6.0 + 6.0	1110	10.6	9.00	7.20	A++	438	0.8 + 2.3 + 2.3
	2.0 + 6.0 + 7.1	1115	10.7	9.00	7.20	A++	438	0.7 + 2.1 + 2.4
	2.0 + 7.1 + 7.1	1085	10.4	9.00	7.20	A++	438	0.7 + 2.3 + 2.3
	2.5 + 2.5 + 2.5	1035	9.9	7.50	7.20	A++	365	1.5 + 1.5 + 1.5
	2.5 + 2.5 + 3.5	1275	12.2	8.50	7.20	A++	413	1.5 + 1.5 + 2.0
	2.5 + 2.5 + 4.2	1395	13.4	9.00	7.20	A++	438	1.5 + 1.5 + 2.3
	2.5 + 2.5 + 5.0	1235	11.8	9.00	7.20	A++	438	1.5 + 1.5 + 2.5
	2.5 + 2.5 + 6.0	1235	11.8	9.00	7.20	A++	438	1.3 + 1.3 + 2.7
	2.5 + 2.5 + 7.1	1205	11.5	9.00	7.20	A++	438	1.2 + 1.2 + 2.9
	2.5 + 3.5 + 3.5	1360	13.0	9.00	7.20	A++	438	1.5 + 1.9 + 1.9
	2.5 + 3.5 + 4.2	1360	13.0	9.00	7.20	A++	438	1.4 + 1.7 + 2.2
	2.5 + 3.5 + 5.0	1205	11.5	9.00	7.20	A++	438	1.3 + 1.7 + 2.3
	2.5 + 3.5 + 6.0	1205	11.5	9.00	7.20	A++	438	1.2 + 1.6 + 2.5
	2.5 + 3.5 + 7.1	1170	11.2	9.00	7.20	A++	438	1.1 + 1.5 + 2.7
	2.5 + 4.2 + 4.2	1330	12.7	9.00	7.20	A++	438	1.3 + 2.0 + 2.0
	2.5 + 4.2 + 5.0	1205	11.5	9.00	7.20	A++	438	1.2 + 1.8 + 2.3
	2.5 + 4.2 + 6.0	1205	11.5	9.00	7.20	A++	438	1.1 + 1.7 + 2.4
	2.5 + 4.2 + 7.1	1170	11.2	9.00	7.20	A++	438	1.0 + 1.6 + 2.5
	2.5 + 5.0 + 5.0	1110	10.6	9.00	7.20	A++	438	1.2 + 2.1 + 2.1
	2.5 + 5.0 + 6.0	1110	10.6	9.00	7.20	A++	438	1.1 + 1.9 + 2.3
	2.5 + 5.0 + 7.1	1115	10.7	9.00	7.20	A++	438	1.0 + 1.7 + 2.4
	2.5 + 6.0 + 6.0	1110	10.6	9.00	7.20	A++	438	1.0 + 2.2 + 2.2
	2.5 + 6.0 + 7.1	1115	10.7	9.00	7.20	A++	438	0.9 + 2.0 + 2.3
	2.5 + 7.1 + 7.1	1085	10.4	9.00	7.20	A++	438	0.8 + 2.2 + 2.2
	3.5 + 3.5 + 3.5	1330	12.7	9.00	7.20	A++	438	1.7 + 1.7 + 1.7
	3.5 + 3.5 + 4.2	1330	12.7	9.00	7.20	A++	438	1.6 + 1.6 + 1.9
	3.5 + 3.5 + 5.0	1205	11.5	9.00	7.20	A++	438	1.6 + 1.6 + 2.2
	3.5 + 3.5 + 6.0	1205	11.5	9.00	7.20	A++	438	1.5 + 1.5 + 2.4
	3.5 + 3.5 + 7.1	1170	11.2	9.00	7.20	A++	438	1.5 + 1.5 + 2.5
	3.5 + 4.2 + 4.2	1295	12.4	9.00	7.20	A++	438	1.6 + 1.8 + 1.8
	3.5 + 4.2 + 5.0	1170	11.2	9.00	7.20	A++	438	1.5 + 1.7 + 2.0
	3.5 + 4.2 + 6.0	1170	11.2	9.00	7.20	A++	438	1.5 + 1.6 + 2.3
	3.5 + 4.2 + 7.1	1170	11.2	9.00	7.20	A++	438	1.4 + 1.6 + 2.4
	3.5 + 5.0 + 5.0	1115	10.7	9.00	7.20	A++	438	1.5 + 1.9 + 1.9
	3.5 + 5.0 + 6.0	1115	10.7	9.00	7.20	A++	438	1.4 + 1.7 + 2.2
	3.5 + 5.0 + 7.1	1085	10.4	9.00	7.20	A++	438	1.3 + 1.7 + 2.3
	3.5 + 6.0 + 6.0	1115	10.7	9.00	7.20	A++	438	1.3 + 2.0 + 2.0
	3.5 + 6.0 + 7.1	1085	10.4	9.00	7.20	A++	438	1.2 + 1.8 + 2.3
	3.5 + 7.1 + 7.1	1085	10.4	9.00	7.20	A++	438	1.1 + 2.1 + 2.1
	4.2 + 4.2 + 4.2	1295	12.4	9.00	7.20	A++	438	1.7 + 1.7 + 1.7
	4.2 + 4.2 + 5.0	1170	11.2	9.00	7.20	A++	438	1.7 + 1.7 + 1.9
	4.2 + 4.2 + 6.0	1170	11.2	9.00	7.20	A++	438	1.6 + 1.6 + 2.2
	4.2 + 4.2 + 7.1	1170	11.2	9.00	7.20	A++	438	1.5 + 1.5 + 2.3
	4.2 + 5.0 + 5.0	1115	10.7	9.00	7.20	A++	438	1.6 + 1.8 + 1.8
	4.2 + 5.0 + 6.0	1115	10.7	9.00	7.20	A++	438	1.5 + 1.7 + 2.1
	4.2 + 5.0 + 7.1	1085	10.4	9.00	7.20	A++	438	1.5 + 1.6 + 2.3
	4.2 + 6.0 + 6.0	1115	10.7	9.00	7.20	A++	438	1.5 + 1.9 + 1.9
4.2 + 6.0 + 7.1	1085	10.4	9.00	7.20	A++	438	1.4 + 1.8 + 2.2	
5.0 + 5.0 + 5.0	1060	10.1	9.00	7.20	A++	438	1.7 + 1.7 + 1.7	
5.0 + 5.0 + 6.0	1060	10.1	9.00	7.20	A++	438	1.6 + 1.6 + 1.9	
5.0 + 5.0 + 7.1	1060	10.1	9.00	7.20	A++	438	1.6 + 1.6 + 2.2	
5.0 + 6.0 + 6.0	1060	10.1	9.00	7.20	A++	438	1.6 + 1.8 + 1.8	
5.0 + 6.0 + 7.1	1060	10.1	9.00	7.20	A++	438	1.5 + 1.7 + 2.0	
6.0 + 6.0 + 6.0	1060	10.1	9.00	7.20	A++	438	1.7 + 1.7 + 1.7	

	Indoor unit capacity Cooling	Total	Cooling Capacity (kW)						Input Power (W)		EER		
			Room A	Room B	Room C	Room D	Room E	Total	min ~ max	Rating	min ~ max	WW	CLASS
4 Room	1.6 + 1.6 + 1.6 + 1.6	6.4	1.60	1.60	1.60	1.60		6.40	2.9 ~ 10.6	1480	370 ~ 3560	4.32	A
	1.6 + 1.6 + 1.6 + 2.0	6.8	1.60	1.60	1.60	2.00		6.80	2.9 ~ 10.6	1620	370 ~ 3560	4.20	A
	1.6 + 1.6 + 1.6 + 2.5	7.3	1.60	1.60	1.60	2.50		7.30	2.9 ~ 10.6	1780	370 ~ 3560	4.10	A
	1.6 + 1.6 + 1.6 + 3.5	8.3	1.60	1.60	1.60	3.50		8.30	2.9 ~ 10.6	2170	370 ~ 3480	3.82	A
	1.6 + 1.6 + 1.6 + 4.2	9.0	1.60	1.60	1.60	4.20		9.00	2.9 ~ 10.6	2460	370 ~ 3480	3.66	A
	1.6 + 1.6 + 1.6 + 5.0	9.8	1.47	1.47	1.47	4.59		9.00	2.9 ~ 10.6	2330	410 ~ 3190	3.86	A
	1.6 + 1.6 + 1.6 + 6.0	10.8	1.33	1.33	1.33	5.01		9.00	2.9 ~ 10.6	2330	410 ~ 3190	3.86	A
	1.6 + 1.6 + 1.6 + 7.1	11.9	1.21	1.21	1.21	5.37		9.00	2.9 ~ 10.6	2340	410 ~ 3120	3.85	A
	1.6 + 1.6 + 2.0 + 2.0	7.2	1.60	1.60	2.00	2.00		7.20	2.9 ~ 10.6	1730	370 ~ 3480	4.16	A
	1.6 + 1.6 + 2.0 + 2.5	7.7	1.60	1.60	2.00	2.50		7.70	2.9 ~ 10.6	1930	370 ~ 3480	3.99	A
	1.6 + 1.6 + 2.0 + 3.5	8.7	1.60	1.60	2.00	3.50		8.70	2.9 ~ 10.6	2330	370 ~ 3410	3.73	A
	1.6 + 1.6 + 2.0 + 4.2	9.4	1.53	1.53	1.91	4.03		9.00	2.9 ~ 10.6	2460	370 ~ 3410	3.66	A
	1.6 + 1.6 + 2.0 + 5.0	10.2	1.41	1.41	1.76	4.42		9.00	2.9 ~ 10.6	2330	410 ~ 3190	3.86	A
	1.6 + 1.6 + 2.0 + 6.0	11.2	1.29	1.29	1.60	4.82		9.00	2.9 ~ 10.6	2330	410 ~ 3190	3.86	A
	1.6 + 1.6 + 2.0 + 7.1	12.3	1.17	1.17	1.46	5.20		9.00	2.9 ~ 10.8	2340	410 ~ 3260	3.85	A
	1.6 + 1.6 + 2.5 + 2.5	8.2	1.60	1.60	2.50	2.50		8.20	2.9 ~ 10.6	2110	370 ~ 3480	3.89	A
	1.6 + 1.6 + 2.5 + 3.5	9.2	1.57	1.57	2.44	3.42		9.00	2.9 ~ 10.6	2460	370 ~ 3410	3.66	A
	1.6 + 1.6 + 2.5 + 4.2	9.9	1.45	1.45	2.27	3.83		9.00	2.9 ~ 10.6	2460	370 ~ 3410	3.66	A
	1.6 + 1.6 + 2.5 + 5.0	10.7	1.35	1.35	2.09	4.21		9.00	2.9 ~ 10.6	2330	410 ~ 3190	3.86	A
	1.6 + 1.6 + 2.5 + 6.0	11.7	1.23	1.23	1.92	4.62		9.00	2.9 ~ 10.6	2330	410 ~ 3190	3.86	A
	1.6 + 1.6 + 2.5 + 7.1	12.8	1.13	1.13	1.75	4.99		9.00	2.9 ~ 10.8	2340	410 ~ 3260	3.85	A
	1.6 + 1.6 + 3.5 + 3.5	10.2	1.41	1.41	3.09	3.09		9.00	2.9 ~ 10.6	2460	370 ~ 3410	3.66	A
	1.6 + 1.6 + 3.5 + 4.2	10.9	1.32	1.32	2.89	3.47		9.00	2.9 ~ 10.6	2390	370 ~ 3330	3.77	A
	1.6 + 1.6 + 3.5 + 5.0	11.7	1.23	1.23	2.69	3.85		9.00	2.9 ~ 10.6	2340	410 ~ 3120	3.85	A
	1.6 + 1.6 + 3.5 + 6.0	12.7	1.13	1.13	2.48	4.26		9.00	2.9 ~ 10.8	2340	410 ~ 3260	3.85	A
	1.6 + 1.6 + 3.5 + 7.1	13.8	1.04	1.04	2.28	4.64		9.00	2.9 ~ 10.8	2280	440 ~ 3190	3.95	A
	1.6 + 1.6 + 4.2 + 4.2	11.6	1.24	1.24	3.26	3.26		9.00	2.9 ~ 10.6	2390	370 ~ 3330	3.77	A
	1.6 + 1.6 + 4.2 + 5.0	12.4	1.16	1.16	3.05	3.63		9.00	2.9 ~ 10.8	2340	410 ~ 3260	3.85	A
	1.6 + 1.6 + 4.2 + 6.0	13.4	1.07	1.07	2.82	4.04		9.00	2.9 ~ 10.8	2340	410 ~ 3260	3.85	A
	1.6 + 1.6 + 4.2 + 7.1	14.5	0.99	0.99	2.61	4.41		9.00	3.0 ~ 11.0	2280	440 ~ 3340	3.95	A
	1.6 + 1.6 + 5.0 + 5.0	13.2	1.09	1.09	3.41	3.41		9.00	2.9 ~ 10.8	2290	480 ~ 3060	3.93	A
	1.6 + 1.6 + 5.0 + 6.0	14.2	1.01	1.01	3.17	3.81		9.00	3.0 ~ 11.0	2290	480 ~ 3200	3.93	A
	1.6 + 1.6 + 5.0 + 7.1	15.3	0.94	0.94	2.94	4.18		9.00	3.0 ~ 11.0	2290	520 ~ 3200	3.93	A
	1.6 + 1.6 + 6.0 + 6.0	15.2	0.95	0.95	3.55	3.55		9.00	3.0 ~ 11.0	2290	480 ~ 3200	3.93	A
	1.6 + 1.6 + 6.0 + 7.1	16.3	0.88	0.88	3.31	3.93		9.00	3.0 ~ 11.2	2290	520 ~ 3280	3.93	A
	1.6 + 1.6 + 7.1 + 7.1	17.4	0.83	0.83	3.67	3.67		9.00	3.0 ~ 11.2	2230	520 ~ 3280	4.04	A
	1.6 + 2.0 + 2.0 + 2.0	7.6	1.60	2.00	2.00	2.00		7.60	2.9 ~ 10.6	1900	370 ~ 3480	4.00	A
	1.6 + 2.0 + 2.0 + 2.5	8.1	1.60	2.00	2.00	2.50		8.10	2.9 ~ 10.6	2050	370 ~ 3480	3.95	A
	1.6 + 2.0 + 2.0 + 3.5	9.1	1.58	1.98	1.98	3.46		9.00	2.9 ~ 10.6	2460	370 ~ 3410	3.66	A
	1.6 + 2.0 + 2.0 + 4.2	9.8	1.46	1.84	1.84	3.86		9.00	2.9 ~ 10.6	2460	370 ~ 3410	3.66	A
1.6 + 2.0 + 2.0 + 5.0	10.6	1.35	1.70	1.70	4.25		9.00	2.9 ~ 10.6	2330	410 ~ 3120	3.86	A	
1.6 + 2.0 + 2.0 + 6.0	11.6	1.24	1.55	1.55	4.66		9.00	2.9 ~ 10.6	2330	410 ~ 3120	3.86	A	
1.6 + 2.0 + 2.0 + 7.1	12.7	1.13	1.42	1.42	5.03		9.00	2.9 ~ 10.8	2340	440 ~ 3190	3.85	A	
1.6 + 2.0 + 2.5 + 2.5	8.6	1.60	2.00	2.50	2.50		8.60	2.9 ~ 10.6	2290	370 ~ 3480	3.76	A	
1.6 + 2.0 + 2.5 + 3.5	9.6	1.50	1.88	2.34	3.28		9.00	2.9 ~ 10.6	2460	370 ~ 3410	3.66	A	
1.6 + 2.0 + 2.5 + 4.2	10.3	1.40	1.75	2.18	3.67		9.00	2.9 ~ 10.6	2460	370 ~ 3410	3.66	A	
1.6 + 2.0 + 2.5 + 5.0	11.1	1.30	1.62	2.03	4.05		9.00	2.9 ~ 10.6	2330	410 ~ 3120	3.86	A	
1.6 + 2.0 + 2.5 + 6.0	12.1	1.19	1.49	1.86	4.46		9.00	2.9 ~ 10.8	2330	410 ~ 3260	3.86	A	
1.6 + 2.0 + 2.5 + 7.1	13.2	1.09	1.36	1.70	4.85		9.00	2.9 ~ 10.8	2340	440 ~ 3190	3.85	A	
1.6 + 2.0 + 3.5 + 3.5	10.6	1.36	1.70	2.97	2.97		9.00	2.9 ~ 10.6	2390	370 ~ 3330	3.77	A	
1.6 + 2.0 + 3.5 + 4.2	11.3	1.27	1.59	2.79	3.35		9.00	2.9 ~ 10.6	2390	370 ~ 3330	3.77	A	
1.6 + 2.0 + 3.5 + 5.0	12.1	1.19	1.49	2.60	3.72		9.00	2.9 ~ 10.8	2340	410 ~ 3260	3.85	A	
1.6 + 2.0 + 3.5 + 6.0	13.1	1.10	1.37	2.40	4.13		9.00	2.9 ~ 10.8	2340	410 ~ 3260	3.85	A	
1.6 + 2.0 + 3.5 + 7.1	14.2	1.01	1.27	2.22	4.50		9.00	3.0 ~ 11.0	2280	440 ~ 3340	3.95	A	
1.6 + 2.0 + 4.2 + 4.2	12.0	1.20	1.50	3.15	3.15		9.00	2.9 ~ 10.6	2390	370 ~ 3330	3.77	A	
1.6 + 2.0 + 4.2 + 5.0	12.8	1.12	1.41	2.95	3.52		9.00	2.9 ~ 10.8	2340	440 ~ 3190	3.85	A	
1.6 + 2.0 + 4.2 + 6.0	13.8	1.04	1.30	2.74	3.92		9.00	2.9 ~ 10.8	2340	440 ~ 3190	3.85	A	
1.6 + 2.0 + 4.2 + 7.1	14.9	0.96	1.21	2.54	4.29		9.00	3.0 ~ 11.0	2280	440 ~ 3270	3.95	A	

	Indoor unit capacity Cooling	Annual Energy Consumption (kWh)	Current 230V (A)	ERP				Moisture Removal Volume l/h
				Pdesign (kW)	SEER		Annual Consumption (kWh)	
					WW	CLASS		
4 Room	1.6 + 1.6 + 1.6 + 1.6	740	7.2	6.40	8.50	A+++	264	1.0 + 1.0 + 1.0 + 1.0
	1.6 + 1.6 + 1.6 + 2.0	810	7.8	6.80	8.50	A+++	280	1.0 + 1.0 + 1.0 + 1.3
	1.6 + 1.6 + 1.6 + 2.5	890	8.5	7.30	8.00	A++	319	1.0 + 1.0 + 1.0 + 1.5
	1.6 + 1.6 + 1.6 + 3.5	1085	10.4	8.30	8.00	A++	363	1.0 + 1.0 + 1.0 + 2.0
	1.6 + 1.6 + 1.6 + 4.2	1230	11.8	9.00	8.00	A++	394	1.0 + 1.0 + 1.0 + 2.4
	1.6 + 1.6 + 1.6 + 5.0	1165	11.2	9.00	8.00	A++	394	0.9 + 0.9 + 0.9 + 2.5
	1.6 + 1.6 + 1.6 + 6.0	1165	11.2	9.00	8.00	A++	394	0.8 + 0.8 + 0.8 + 2.7
	1.6 + 1.6 + 1.6 + 7.1	1170	11.2	9.00	8.00	A++	394	0.8 + 0.8 + 0.8 + 2.9
	1.6 + 1.6 + 2.0 + 2.0	865	8.4	7.20	8.00	A++	315	1.0 + 1.0 + 1.3 + 1.3
	1.6 + 1.6 + 2.0 + 2.5	965	9.2	7.70	8.00	A++	337	1.0 + 1.0 + 1.3 + 1.5
	1.6 + 1.6 + 2.0 + 3.5	1165	11.2	8.70	8.00	A++	381	1.0 + 1.0 + 1.3 + 2.0
	1.6 + 1.6 + 2.0 + 4.2	1230	11.8	9.00	8.00	A++	394	1.0 + 1.0 + 1.2 + 2.3
	1.6 + 1.6 + 2.0 + 5.0	1165	11.2	9.00	8.00	A++	394	0.9 + 0.9 + 1.1 + 2.4
	1.6 + 1.6 + 2.0 + 6.0	1165	11.2	9.00	8.00	A++	394	0.8 + 0.8 + 1.0 + 2.6
	1.6 + 1.6 + 2.0 + 7.1	1170	11.2	9.00	8.00	A++	394	0.7 + 0.7 + 0.9 + 2.9
	1.6 + 1.6 + 2.5 + 2.5	1055	10.1	8.20	8.00	A++	359	1.0 + 1.0 + 1.5 + 1.5
	1.6 + 1.6 + 2.5 + 3.5	1230	11.8	9.00	8.00	A++	394	1.0 + 1.0 + 1.5 + 2.0
	1.6 + 1.6 + 2.5 + 4.2	1230	11.8	9.00	8.00	A++	394	0.9 + 0.9 + 1.5 + 2.2
	1.6 + 1.6 + 2.5 + 5.0	1165	11.2	9.00	8.00	A++	394	0.9 + 0.9 + 1.4 + 2.4
	1.6 + 1.6 + 2.5 + 6.0	1165	11.2	9.00	8.00	A++	394	0.8 + 0.8 + 1.2 + 2.5
	1.6 + 1.6 + 2.5 + 7.1	1170	11.2	9.00	8.00	A++	394	0.7 + 0.7 + 1.1 + 2.7
	1.6 + 1.6 + 3.5 + 3.5	1230	11.8	9.00	8.00	A++	394	0.9 + 0.9 + 1.7 + 1.7
	1.6 + 1.6 + 3.5 + 4.2	1195	11.4	9.00	8.00	A++	394	0.8 + 0.8 + 1.7 + 2.0
	1.6 + 1.6 + 3.5 + 5.0	1170	11.2	9.00	8.00	A++	394	0.8 + 0.8 + 1.6 + 2.3
	1.6 + 1.6 + 3.5 + 6.0	1170	11.2	9.00	8.00	A++	394	0.7 + 0.7 + 1.5 + 2.4
	1.6 + 1.6 + 3.5 + 7.1	1140	10.9	9.00	8.00	A++	394	0.7 + 0.7 + 1.5 + 2.5
	1.6 + 1.6 + 4.2 + 4.2	1195	11.4	9.00	8.00	A++	394	0.8 + 0.8 + 1.9 + 1.9
	1.6 + 1.6 + 4.2 + 5.0	1170	11.2	9.00	8.00	A++	394	0.7 + 0.7 + 1.7 + 2.1
	1.6 + 1.6 + 4.2 + 6.0	1170	11.2	9.00	8.00	A++	394	0.7 + 0.7 + 1.7 + 2.3
	1.6 + 1.6 + 4.2 + 7.1	1140	10.9	9.00	8.00	A++	394	0.7 + 0.7 + 1.6 + 2.4
	1.6 + 1.6 + 5.0 + 5.0	1145	11.0	9.00	8.00	A++	394	0.7 + 0.7 + 2.0 + 2.0
	1.6 + 1.6 + 5.0 + 6.0	1145	11.0	9.00	8.00	A++	394	0.7 + 0.7 + 1.8 + 2.2
	1.6 + 1.6 + 5.0 + 7.1	1145	11.0	9.00	8.00	A++	394	0.7 + 0.7 + 1.7 + 2.4
	1.6 + 1.6 + 6.0 + 6.0	1145	11.0	9.00	8.00	A++	394	0.7 + 0.7 + 2.1 + 2.1
	1.6 + 1.6 + 6.0 + 7.1	1145	11.0	9.00	8.00	A++	394	0.7 + 0.7 + 1.9 + 2.3
	1.6 + 1.6 + 7.1 + 7.1	1115	10.7	9.00	8.00	A++	394	0.7 + 0.7 + 2.1 + 2.1
	1.6 + 2.0 + 2.0 + 2.0	950	9.1	7.60	8.00	A++	333	1.0 + 1.3 + 1.3 + 1.3
	1.6 + 2.0 + 2.0 + 2.5	1025	9.8	8.10	8.00	A++	354	1.0 + 1.3 + 1.3 + 1.5
	1.6 + 2.0 + 2.0 + 3.5	1230	11.8	9.00	8.00	A++	394	1.0 + 1.3 + 1.3 + 2.0
	1.6 + 2.0 + 2.0 + 4.2	1230	11.8	9.00	8.00	A++	394	0.9 + 1.2 + 1.2 + 2.3
	1.6 + 2.0 + 2.0 + 5.0	1165	11.2	9.00	8.00	A++	394	0.9 + 1.1 + 1.1 + 2.4
	1.6 + 2.0 + 2.0 + 6.0	1165	11.2	9.00	8.00	A++	394	0.8 + 1.0 + 1.0 + 2.5
	1.6 + 2.0 + 2.0 + 7.1	1170	11.2	9.00	8.00	A++	394	0.7 + 0.9 + 0.9 + 2.8
	1.6 + 2.0 + 2.5 + 2.5	1145	11.0	8.60	8.00	A++	376	1.0 + 1.3 + 1.5 + 1.5
	1.6 + 2.0 + 2.5 + 3.5	1230	11.8	9.00	8.00	A++	394	1.0 + 1.2 + 1.5 + 1.9
1.6 + 2.0 + 2.5 + 4.2	1230	11.8	9.00	8.00	A++	394	0.9 + 1.1 + 1.4 + 2.1	
1.6 + 2.0 + 2.5 + 5.0	1165	11.2	9.00	8.00	A++	394	0.8 + 1.0 + 1.3 + 2.3	
1.6 + 2.0 + 2.5 + 6.0	1165	11.2	9.00	8.00	A++	394	0.7 + 0.9 + 1.2 + 2.5	
1.6 + 2.0 + 2.5 + 7.1	1170	11.2	9.00	8.00	A++	394	0.7 + 0.9 + 1.1 + 2.6	
1.6 + 2.0 + 3.5 + 3.5	1195	11.4	9.00	8.00	A++	394	0.9 + 1.1 + 1.7 + 1.7	
1.6 + 2.0 + 3.5 + 4.2	1195	11.4	9.00	8.00	A++	394	0.8 + 1.0 + 1.6 + 1.9	
1.6 + 2.0 + 3.5 + 5.0	1170	11.2	9.00	8.00	A++	394	0.7 + 0.9 + 1.6 + 2.2	
1.6 + 2.0 + 3.5 + 6.0	1170	11.2	9.00	8.00	A++	394	0.7 + 0.9 + 1.5 + 2.3	
1.6 + 2.0 + 3.5 + 7.1	1140	10.9	9.00	8.00	A++	394	0.7 + 0.8 + 1.4 + 2.5	
1.6 + 2.0 + 4.2 + 4.2	1195	11.4	9.00	8.00	A++	394	0.7 + 1.0 + 1.8 + 1.8	
1.6 + 2.0 + 4.2 + 5.0	1170	11.2	9.00	8.00	A++	394	0.7 + 0.9 + 1.7 + 2.0	
1.6 + 2.0 + 4.2 + 6.0	1170	11.2	9.00	8.00	A++	394	0.7 + 0.8 + 1.6 + 2.3	
1.6 + 2.0 + 4.2 + 7.1	1140	10.9	9.00	8.00	A++	394	0.7 + 0.8 + 1.6 + 2.4	

Indoor unit capacity Cooling	Total	Cooling Capacity (kW)							Input Power (W)		EER	
		Room A	Room B	Room C	Room D	Room E	Total	min ~ max	Rating	min ~ max	WW	CLASS
1.6 + 2.0 + 5.0 + 5.0	13.6	1.06	1.32	3.31	3.31		9.00	2.9 ~ 10.8	2290	490 ~ 3060	3.93	A
1.6 + 2.0 + 5.0 + 6.0	14.6	0.99	1.23	3.08	3.70		9.00	3.0 ~ 11.0	2290	490 ~ 3200	3.93	A
1.6 + 2.0 + 5.0 + 7.1	15.7	0.91	1.15	2.87	4.07		9.00	3.0 ~ 11.0	2290	520 ~ 3130	3.93	A
1.6 + 2.0 + 6.0 + 6.0	15.6	0.92	1.16	3.46	3.46		9.00	3.0 ~ 11.0	2290	490 ~ 3200	3.93	A
1.6 + 2.0 + 6.0 + 7.1	16.7	0.86	1.08	3.23	3.83		9.00	3.0 ~ 11.2	2290	520 ~ 3280	3.93	A
1.6 + 2.0 + 7.1 + 7.1	17.8	0.81	1.01	3.59	3.59		9.00	3.0 ~ 11.2	2240	530 ~ 3280	4.02	A
1.6 + 2.5 + 2.5 + 2.5	9.1	1.59	2.47	2.47	2.47		9.00	2.9 ~ 10.6	2460	370 ~ 3480	3.66	A
1.6 + 2.5 + 2.5 + 3.5	10.1	1.42	2.23	2.23	3.12		9.00	2.9 ~ 10.6	2460	370 ~ 3410	3.66	A
1.6 + 2.5 + 2.5 + 4.2	10.8	1.33	2.08	2.08	3.51		9.00	2.9 ~ 10.6	2460	370 ~ 3410	3.66	A
1.6 + 2.5 + 2.5 + 5.0	11.6	1.24	1.94	1.94	3.88		9.00	2.9 ~ 10.6	2330	410 ~ 3120	3.86	A
1.6 + 2.5 + 2.5 + 6.0	12.6	1.13	1.79	1.79	4.29		9.00	2.9 ~ 10.8	2330	410 ~ 3260	3.86	A
1.6 + 2.5 + 2.5 + 7.1	13.7	1.05	1.64	1.64	4.67		9.00	2.9 ~ 10.8	2340	440 ~ 3190	3.85	A
1.6 + 2.5 + 3.5 + 3.5	11.1	1.29	2.03	2.84	2.84		9.00	2.9 ~ 10.6	2390	370 ~ 3330	3.77	A
1.6 + 2.5 + 3.5 + 4.2	11.8	1.22	1.91	2.67	3.20		9.00	2.9 ~ 10.6	2390	370 ~ 3330	3.77	A
1.6 + 2.5 + 3.5 + 5.0	12.6	1.14	1.79	2.50	3.57		9.00	2.9 ~ 10.8	2340	410 ~ 3260	3.85	A
1.6 + 2.5 + 3.5 + 6.0	13.6	1.06	1.65	2.32	3.97		9.00	2.9 ~ 10.8	2340	410 ~ 3260	3.85	A
1.6 + 2.5 + 3.5 + 7.1	14.7	0.98	1.53	2.14	4.35		9.00	3.0 ~ 11.0	2280	440 ~ 3340	3.95	A
1.6 + 2.5 + 4.2 + 4.2	12.5	1.15	1.81	3.02	3.02		9.00	2.9 ~ 10.8	2390	370 ~ 3480	3.77	A
1.6 + 2.5 + 4.2 + 5.0	13.3	1.08	1.69	2.84	3.39		9.00	2.9 ~ 10.8	2340	440 ~ 3190	3.85	A
1.6 + 2.5 + 4.2 + 6.0	14.3	1.01	1.57	2.64	3.78		9.00	3.0 ~ 11.0	2340	440 ~ 3340	3.85	A
1.6 + 2.5 + 4.2 + 7.1	15.4	0.94	1.46	2.45	4.15		9.00	3.0 ~ 11.0	2280	440 ~ 3270	3.95	A
1.6 + 2.5 + 5.0 + 5.0	14.1	1.02	1.60	3.19	3.19		9.00	2.9 ~ 10.8	2290	490 ~ 3060	3.93	A
1.6 + 2.5 + 5.0 + 6.0	15.1	0.95	1.49	2.98	3.58		9.00	3.0 ~ 11.0	2290	490 ~ 3200	3.93	A
1.6 + 2.5 + 5.0 + 7.1	16.2	0.89	1.39	2.78	3.94		9.00	3.0 ~ 11.2	2290	520 ~ 3280	3.93	A
1.6 + 2.5 + 6.0 + 6.0	16.1	0.89	1.41	3.35	3.35		9.00	3.0 ~ 11.2	2290	490 ~ 3270	3.93	A
1.6 + 2.5 + 6.0 + 7.1	17.2	0.83	1.31	3.14	3.72		9.00	3.0 ~ 11.2	2290	520 ~ 3280	3.93	A
1.6 + 2.5 + 7.1 + 7.1	18.3	0.79	1.23	3.49	3.49		9.00	3.0 ~ 11.2	2240	530 ~ 3280	4.02	A
1.6 + 3.5 + 3.5 + 3.5	12.1	1.20	2.60	2.60	2.60		9.00	2.9 ~ 10.8	2390	380 ~ 3410	3.77	A
1.6 + 3.5 + 3.5 + 4.2	12.8	1.13	2.46	2.46	2.95		9.00	2.9 ~ 10.8	2390	400 ~ 3410	3.77	A
1.6 + 3.5 + 3.5 + 5.0	13.6	1.05	2.32	2.32	3.31		9.00	2.9 ~ 10.8	2280	440 ~ 3190	3.95	A
1.6 + 3.5 + 3.5 + 6.0	14.6	0.98	2.16	2.16	3.70		9.00	3.0 ~ 11.0	2280	440 ~ 3340	3.95	A
1.6 + 3.5 + 3.5 + 7.1	15.7	0.91	2.01	2.01	4.07		9.00	3.0 ~ 11.0	2280	470 ~ 3270	3.95	A
1.6 + 3.5 + 4.2 + 4.2	13.5	1.07	2.33	2.80	2.80		9.00	2.9 ~ 10.8	2390	400 ~ 3410	3.77	A
1.6 + 3.5 + 4.2 + 5.0	14.3	1.01	2.20	2.64	3.15		9.00	3.0 ~ 11.0	2280	440 ~ 3340	3.95	A
1.6 + 3.5 + 4.2 + 6.0	15.3	0.94	2.06	2.47	3.53		9.00	3.0 ~ 11.0	2280	440 ~ 3340	3.95	A
1.6 + 3.5 + 4.2 + 7.1	16.4	0.88	1.92	2.30	3.90		9.00	3.0 ~ 11.2	2280	470 ~ 3410	3.95	A
1.6 + 3.5 + 5.0 + 5.0	15.1	0.95	2.09	2.98	2.98		9.00	3.0 ~ 11.0	2290	520 ~ 3130	3.93	A
1.6 + 3.5 + 5.0 + 6.0	16.1	0.89	1.96	2.80	3.35		9.00	3.0 ~ 11.2	2290	520 ~ 3280	3.93	A
1.6 + 3.5 + 5.0 + 7.1	17.2	0.83	1.83	2.62	3.72		9.00	3.0 ~ 11.2	2230	520 ~ 3280	4.04	A
1.6 + 3.5 + 6.0 + 6.0	17.1	0.84	1.84	3.16	3.16		9.00	3.0 ~ 11.2	2290	520 ~ 3280	3.93	A
1.6 + 3.5 + 6.0 + 7.1	18.2	0.79	1.73	2.97	3.51		9.00	3.0 ~ 11.2	2230	520 ~ 3280	4.04	A
1.6 + 4.2 + 4.2 + 4.2	14.2	1.02	2.66	2.66	2.66		9.00	3.0 ~ 11.0	2390	400 ~ 3560	3.77	A
1.6 + 4.2 + 4.2 + 5.0	15.0	0.96	2.52	2.52	3.00		9.00	3.0 ~ 11.0	2280	440 ~ 3270	3.95	A
1.6 + 4.2 + 4.2 + 6.0	16.0	0.90	2.36	2.36	3.38		9.00	3.0 ~ 11.2	2280	440 ~ 3410	3.95	A
1.6 + 4.2 + 4.2 + 7.1	17.1	0.84	2.21	2.21	3.74		9.00	3.0 ~ 11.2	2280	480 ~ 3420	3.95	A
1.6 + 4.2 + 5.0 + 5.0	15.8	0.91	2.39	2.85	2.85		9.00	3.0 ~ 11.2	2290	520 ~ 3280	3.93	A
1.6 + 4.2 + 5.0 + 6.0	16.8	0.86	2.25	2.68	3.21		9.00	3.0 ~ 11.2	2290	520 ~ 3280	3.93	A
1.6 + 4.2 + 5.0 + 7.1	17.9	0.80	2.11	2.51	3.58		9.00	3.0 ~ 11.2	2240	530 ~ 3280	4.02	A
1.6 + 4.2 + 6.0 + 6.0	17.8	0.81	2.13	3.03	3.03		9.00	3.0 ~ 11.2	2290	520 ~ 3280	3.93	A
1.6 + 5.0 + 5.0 + 5.0	16.6	0.87	2.71	2.71	2.71		9.00	3.0 ~ 11.2	2250	570 ~ 3220	4.00	A
1.6 + 5.0 + 5.0 + 6.0	17.6	0.81	2.56	2.56	3.07		9.00	3.0 ~ 11.2	2250	570 ~ 3220	4.00	A
2.0 + 2.0 + 2.0 + 2.0	8.0	2.00	2.00	2.00	2.00		8.00	2.9 ~ 10.6	2050	370 ~ 3480	3.90	A
2.0 + 2.0 + 2.0 + 2.5	8.5	2.00	2.00	2.00	2.50		8.50	2.9 ~ 10.6	2230	370 ~ 3480	3.81	A
2.0 + 2.0 + 2.0 + 3.5	9.5	1.89	1.89	1.89	3.33		9.00	2.9 ~ 10.6	2460	370 ~ 3410	3.66	A
2.0 + 2.0 + 2.0 + 4.2	10.2	1.76	1.76	1.76	3.72		9.00	2.9 ~ 10.6	2460	370 ~ 3410	3.66	A
2.0 + 2.0 + 2.0 + 5.0	11.0	1.64	1.64	1.64	4.08		9.00	2.9 ~ 10.6	2330	410 ~ 3120	3.86	A
2.0 + 2.0 + 2.0 + 6.0	12.0	1.50	1.50	1.50	4.50		9.00	2.9 ~ 10.6	2330	410 ~ 3120	3.86	A
2.0 + 2.0 + 2.0 + 7.1	13.1	1.37	1.37	1.37	4.89		9.00	2.9 ~ 10.8	2280	440 ~ 3190	3.95	A

4 Room

	Indoor unit capacity Cooling	Annual Energy Consumption (kWh)	Current 230V (A)	ERP				Moisture Removal Volume l/h
				Pdesign (kW)	SEER		Annual Consumption (kWh)	
					WW	CLASS		
4 Room	1.6 + 2.0 + 5.0 + 5.0	1145	11.0	9.00	8.00	A++	394	0.7 + 0.8 + 1.9 + 1.9
	1.6 + 2.0 + 5.0 + 6.0	1145	11.0	9.00	8.00	A++	394	0.7 + 0.8 + 1.7 + 2.2
	1.6 + 2.0 + 5.0 + 7.1	1145	11.0	9.00	8.00	A++	394	0.7 + 0.7 + 1.7 + 2.3
	1.6 + 2.0 + 6.0 + 6.0	1145	11.0	9.00	8.00	A++	394	0.7 + 0.7 + 2.0 + 2.0
	1.6 + 2.0 + 6.0 + 7.1	1145	11.0	9.00	8.00	A++	394	0.7 + 0.7 + 1.8 + 2.2
	1.6 + 2.0 + 7.1 + 7.1	1120	10.7	9.00	8.00	A++	394	0.7 + 0.7 + 2.1 + 2.1
	1.6 + 2.5 + 2.5 + 2.5	1230	11.8	9.00	8.00	A++	394	1.0 + 1.5 + 1.5 + 1.5
	1.6 + 2.5 + 2.5 + 3.5	1230	11.8	9.00	8.00	A++	394	0.9 + 1.5 + 1.5 + 1.8
	1.6 + 2.5 + 2.5 + 4.2	1230	11.8	9.00	8.00	A++	394	0.8 + 1.3 + 1.3 + 2.0
	1.6 + 2.5 + 2.5 + 5.0	1165	11.2	9.00	8.00	A++	394	0.8 + 1.3 + 1.3 + 2.3
	1.6 + 2.5 + 2.5 + 6.0	1165	11.2	9.00	8.00	A++	394	0.7 + 1.2 + 1.2 + 2.4
	1.6 + 2.5 + 2.5 + 7.1	1170	11.2	9.00	8.00	A++	394	0.7 + 1.0 + 1.0 + 2.5
	1.6 + 2.5 + 3.5 + 3.5	1195	11.4	9.00	8.00	A++	394	0.8 + 1.3 + 1.7 + 1.7
	1.6 + 2.5 + 3.5 + 4.2	1195	11.4	9.00	8.00	A++	394	0.8 + 1.2 + 1.6 + 1.8
	1.6 + 2.5 + 3.5 + 5.0	1170	11.2	9.00	8.00	A++	394	0.7 + 1.2 + 1.5 + 2.1
	1.6 + 2.5 + 3.5 + 6.0	1170	11.2	9.00	8.00	A++	394	0.7 + 1.1 + 1.5 + 2.3
	1.6 + 2.5 + 3.5 + 7.1	1140	10.9	9.00	8.00	A++	394	0.7 + 1.0 + 1.4 + 2.4
	1.6 + 2.5 + 4.2 + 4.2	1195	11.4	9.00	8.00	A++	394	0.7 + 1.2 + 1.7 + 1.7
	1.6 + 2.5 + 4.2 + 5.0	1170	11.2	9.00	8.00	A++	394	0.7 + 1.1 + 1.7 + 1.9
	1.6 + 2.5 + 4.2 + 6.0	1170	11.2	9.00	8.00	A++	394	0.7 + 1.0 + 1.6 + 2.2
	1.6 + 2.5 + 4.2 + 7.1	1140	10.9	9.00	8.00	A++	394	0.7 + 0.9 + 1.5 + 2.4
	1.6 + 2.5 + 5.0 + 5.0	1145	11.0	9.00	8.00	A++	394	0.7 + 1.0 + 1.8 + 1.8
	1.6 + 2.5 + 5.0 + 6.0	1145	11.0	9.00	8.00	A++	394	0.7 + 0.9 + 1.7 + 2.1
	1.6 + 2.5 + 5.0 + 7.1	1145	11.0	9.00	8.00	A++	394	0.7 + 0.9 + 1.6 + 2.3
	1.6 + 2.5 + 6.0 + 6.0	1145	11.0	9.00	8.00	A++	394	0.7 + 0.9 + 1.9 + 1.9
	1.6 + 2.5 + 6.0 + 7.1	1145	11.0	9.00	8.00	A++	394	0.7 + 0.8 + 1.8 + 2.2
	1.6 + 2.5 + 7.1 + 7.1	1120	10.7	9.00	8.00	A++	394	0.7 + 0.8 + 2.0 + 2.0
	1.6 + 3.5 + 3.5 + 3.5	1195	11.4	9.00	8.00	A++	394	0.7 + 1.6 + 1.6 + 1.6
	1.6 + 3.5 + 3.5 + 4.2	1195	11.4	9.00	8.00	A++	394	0.7 + 1.5 + 1.5 + 1.7
	1.6 + 3.5 + 3.5 + 5.0	1140	10.9	9.00	8.00	A++	394	0.7 + 1.5 + 1.5 + 1.9
	1.6 + 3.5 + 3.5 + 6.0	1140	10.9	9.00	8.00	A++	394	0.7 + 1.4 + 1.4 + 2.2
	1.6 + 3.5 + 3.5 + 7.1	1140	10.9	9.00	8.00	A++	394	0.7 + 1.3 + 1.3 + 2.3
	1.6 + 3.5 + 4.2 + 4.2	1195	11.4	9.00	8.00	A++	394	0.7 + 1.5 + 1.6 + 1.6
	1.6 + 3.5 + 4.2 + 5.0	1140	10.9	9.00	8.00	A++	394	0.7 + 1.4 + 1.6 + 1.8
	1.6 + 3.5 + 4.2 + 6.0	1140	10.9	9.00	8.00	A++	394	0.7 + 1.3 + 1.5 + 2.0
	1.6 + 3.5 + 4.2 + 7.1	1140	10.9	9.00	8.00	A++	394	0.7 + 1.2 + 1.5 + 2.3
	1.6 + 3.5 + 5.0 + 5.0	1145	11.0	9.00	8.00	A++	394	0.7 + 1.4 + 1.7 + 1.7
	1.6 + 3.5 + 5.0 + 6.0	1145	11.0	9.00	8.00	A++	394	0.7 + 1.3 + 1.6 + 1.9
	1.6 + 3.5 + 5.0 + 7.1	1115	10.7	9.00	8.00	A++	394	0.7 + 1.2 + 1.6 + 2.2
	1.6 + 3.5 + 6.0 + 6.0	1145	11.0	9.00	8.00	A++	394	0.7 + 1.2 + 1.8 + 1.8
1.6 + 3.5 + 6.0 + 7.1	1115	10.7	9.00	8.00	A++	394	0.7 + 1.1 + 1.7 + 2.0	
1.6 + 4.2 + 4.2 + 4.2	1195	11.4	9.00	8.00	A++	394	0.7 + 1.6 + 1.6 + 1.6	
1.6 + 4.2 + 4.2 + 5.0	1140	10.9	9.00	8.00	A++	394	0.7 + 1.5 + 1.5 + 1.7	
1.6 + 4.2 + 4.2 + 6.0	1140	10.9	9.00	8.00	A++	394	0.7 + 1.5 + 1.5 + 1.9	
1.6 + 4.2 + 4.2 + 7.1	1140	10.9	9.00	8.00	A++	394	0.7 + 1.4 + 1.4 + 2.2	
1.6 + 4.2 + 5.0 + 5.0	1145	11.0	9.00	8.00	A++	394	0.7 + 1.5 + 1.7 + 1.7	
1.6 + 4.2 + 5.0 + 6.0	1145	11.0	9.00	8.00	A++	394	0.7 + 1.5 + 1.6 + 1.8	
1.6 + 4.2 + 5.0 + 7.1	1120	10.7	9.00	8.00	A++	394	0.7 + 1.4 + 1.5 + 2.1	
1.6 + 4.2 + 6.0 + 6.0	1145	11.0	9.00	8.00	A++	394	0.7 + 1.4 + 1.7 + 1.7	
1.6 + 5.0 + 5.0 + 5.0	1125	10.8	9.00	8.00	A++	394	0.7 + 1.6 + 1.6 + 1.6	
1.6 + 5.0 + 5.0 + 6.0	1125	10.8	9.00	8.00	A++	394	0.7 + 1.6 + 1.6 + 1.7	
2.0 + 2.0 + 2.0 + 2.0	1025	9.8	8.00	8.00	A++	350	1.3 + 1.3 + 1.3 + 1.3	
2.0 + 2.0 + 2.0 + 2.5	1115	10.7	8.50	8.00	A++	372	1.3 + 1.3 + 1.3 + 1.5	
2.0 + 2.0 + 2.0 + 3.5	1230	11.8	9.00	8.00	A++	394	1.2 + 1.2 + 1.2 + 1.9	
2.0 + 2.0 + 2.0 + 4.2	1230	11.8	9.00	8.00	A++	394	1.1 + 1.1 + 1.1 + 2.2	
2.0 + 2.0 + 2.0 + 5.0	1165	11.2	9.00	8.00	A++	394	1.0 + 1.0 + 1.0 + 2.3	
2.0 + 2.0 + 2.0 + 6.0	1165	11.2	9.00	8.00	A++	394	1.0 + 1.0 + 1.0 + 2.5	
2.0 + 2.0 + 2.0 + 7.1	1140	10.9	9.00	8.00	A++	394	0.9 + 0.9 + 0.9 + 2.7	

Indoor unit capacity Cooling	Total	Cooling Capacity (kW)							Input Power (W)		EER	
		Room A	Room B	Room C	Room D	Room E	Total	min ~ max	Rating	min ~ max	WW	CLASS
2.0 + 2.0 + 2.5 + 2.5	9.0	2.00	2.00	2.50	2.50		9.00	2.9 ~ 10.6	2460	370 ~ 3480	3.66	A
2.0 + 2.0 + 2.5 + 3.5	10.0	1.80	1.80	2.25	3.15		9.00	2.9 ~ 10.6	2460	370 ~ 3410	3.66	A
2.0 + 2.0 + 2.5 + 4.2	10.7	1.68	1.68	2.10	3.54		9.00	2.9 ~ 10.6	2460	370 ~ 3410	3.66	A
2.0 + 2.0 + 2.5 + 5.0	11.5	1.57	1.57	1.95	3.91		9.00	2.9 ~ 10.6	2330	410 ~ 3120	3.86	A
2.0 + 2.0 + 2.5 + 6.0	12.5	1.44	1.44	1.80	4.32		9.00	2.9 ~ 10.8	2330	410 ~ 3260	3.86	A
2.0 + 2.0 + 2.5 + 7.1	13.6	1.32	1.32	1.65	4.71		9.00	2.9 ~ 10.8	2280	440 ~ 3190	3.95	A
2.0 + 2.0 + 3.5 + 3.5	11.0	1.64	1.64	2.86	2.86		9.00	2.9 ~ 10.6	2390	370 ~ 3330	3.77	A
2.0 + 2.0 + 3.5 + 4.2	11.7	1.54	1.54	2.69	3.23		9.00	2.9 ~ 10.6	2390	370 ~ 3330	3.77	A
2.0 + 2.0 + 3.5 + 5.0	12.5	1.44	1.44	2.52	3.60		9.00	2.9 ~ 10.8	2340	440 ~ 3190	3.85	A
2.0 + 2.0 + 3.5 + 6.0	13.5	1.33	1.33	2.33	4.01		9.00	2.9 ~ 10.8	2340	440 ~ 3190	3.85	A
2.0 + 2.0 + 3.5 + 7.1	14.6	1.23	1.23	2.16	4.38		9.00	3.0 ~ 11.0	2280	440 ~ 3270	3.95	A
2.0 + 2.0 + 4.2 + 4.2	12.4	1.45	1.45	3.05	3.05		9.00	2.9 ~ 10.8	2390	370 ~ 3480	3.77	A
2.0 + 2.0 + 4.2 + 5.0	13.2	1.36	1.36	2.86	3.42		9.00	2.9 ~ 10.8	2280	440 ~ 3190	3.95	A
2.0 + 2.0 + 4.2 + 6.0	14.2	1.27	1.27	2.66	3.80		9.00	3.0 ~ 11.0	2280	440 ~ 3340	3.95	A
2.0 + 2.0 + 4.2 + 7.1	15.3	1.18	1.18	2.46	4.18		9.00	3.0 ~ 11.0	2280	450 ~ 3270	3.95	A
2.0 + 2.0 + 5.0 + 5.0	14.0	1.29	1.29	3.21	3.21		9.00	2.9 ~ 10.8	2290	490 ~ 3060	3.93	A
2.0 + 2.0 + 5.0 + 6.0	15.0	1.20	1.20	3.00	3.60		9.00	3.0 ~ 11.0	2290	490 ~ 3200	3.93	A
2.0 + 2.0 + 5.0 + 7.1	16.1	1.12	1.12	2.79	3.97		9.00	3.0 ~ 11.2	2230	520 ~ 3280	4.04	A
2.0 + 2.0 + 6.0 + 6.0	16.0	1.12	1.12	3.38	3.38		9.00	3.0 ~ 11.2	2290	490 ~ 3270	3.93	A
2.0 + 2.0 + 6.0 + 7.1	17.1	1.05	1.05	3.16	3.74		9.00	3.0 ~ 11.2	2230	520 ~ 3280	4.04	A
2.0 + 2.0 + 7.1 + 7.1	18.2	0.99	0.99	3.51	3.51		9.00	3.0 ~ 11.2	2240	530 ~ 3210	4.02	A
2.0 + 2.5 + 2.5 + 2.5	9.5	1.89	2.37	2.37	2.37		9.00	2.9 ~ 10.6	2460	370 ~ 3480	3.66	A
2.0 + 2.5 + 2.5 + 3.5	10.5	1.71	2.14	2.14	3.01		9.00	2.9 ~ 10.6	2460	370 ~ 3410	3.66	A
2.0 + 2.5 + 2.5 + 4.2	11.2	1.60	2.01	2.01	3.38		9.00	2.9 ~ 10.6	2460	370 ~ 3410	3.66	A
2.0 + 2.5 + 2.5 + 5.0	12.0	1.49	1.88	1.88	3.75		9.00	2.9 ~ 10.6	2330	410 ~ 3120	3.86	A
2.0 + 2.5 + 2.5 + 6.0	13.0	1.38	1.73	1.73	4.16		9.00	2.9 ~ 10.8	2330	410 ~ 3260	3.86	A
2.0 + 2.5 + 2.5 + 7.1	14.1	1.27	1.60	1.60	4.53		9.00	2.9 ~ 10.8	2280	440 ~ 3190	3.95	A
2.0 + 2.5 + 3.5 + 3.5	11.5	1.56	1.96	2.74	2.74		9.00	2.9 ~ 10.6	2390	370 ~ 3330	3.77	A
2.0 + 2.5 + 3.5 + 4.2	12.2	1.48	1.84	2.58	3.10		9.00	2.9 ~ 10.8	2390	370 ~ 3480	3.77	A
2.0 + 2.5 + 3.5 + 5.0	13.0	1.38	1.73	2.42	3.47		9.00	2.9 ~ 10.8	2340	440 ~ 3190	3.85	A
2.0 + 2.5 + 3.5 + 6.0	14.0	1.28	1.61	2.25	3.86		9.00	2.9 ~ 10.8	2340	440 ~ 3190	3.85	A
2.0 + 2.5 + 3.5 + 7.1	15.1	1.19	1.49	2.09	4.23		9.00	3.0 ~ 11.0	2280	440 ~ 3270	3.95	A
2.0 + 2.5 + 4.2 + 4.2	12.9	1.40	1.74	2.93	2.93		9.00	2.9 ~ 10.8	2390	370 ~ 3480	3.77	A
2.0 + 2.5 + 4.2 + 5.0	13.7	1.31	1.64	2.76	3.29		9.00	2.9 ~ 10.8	2280	440 ~ 3190	3.95	A
2.0 + 2.5 + 4.2 + 6.0	14.7	1.22	1.53	2.57	3.68		9.00	3.0 ~ 11.0	2280	440 ~ 3340	3.95	A
2.0 + 2.5 + 4.2 + 7.1	15.8	1.14	1.42	2.39	4.05		9.00	3.0 ~ 11.2	2280	450 ~ 3410	3.95	A
2.0 + 2.5 + 5.0 + 5.0	14.5	1.24	1.55	3.10	3.11		9.00	3.0 ~ 11.0	2290	490 ~ 3200	3.93	A
2.0 + 2.5 + 5.0 + 6.0	15.5	1.16	1.45	2.90	3.49		9.00	3.0 ~ 11.0	2290	490 ~ 3200	3.93	A
2.0 + 2.5 + 5.0 + 7.1	16.6	1.08	1.36	2.71	3.85		9.00	3.0 ~ 11.2	2230	520 ~ 3280	4.04	A
2.0 + 2.5 + 6.0 + 6.0	16.5	1.09	1.37	3.27	3.27		9.00	3.0 ~ 11.2	2290	490 ~ 3270	3.93	A
2.0 + 2.5 + 6.0 + 7.1	17.6	1.02	1.28	3.07	3.63		9.00	3.0 ~ 11.2	2230	520 ~ 3280	4.04	A
2.0 + 3.5 + 3.5 + 3.5	12.5	1.44	2.52	2.52	2.52		9.00	2.9 ~ 10.8	2390	400 ~ 3410	3.77	A
2.0 + 3.5 + 3.5 + 4.2	13.2	1.36	2.39	2.39	2.86		9.00	2.9 ~ 10.8	2390	400 ~ 3410	3.77	A
2.0 + 3.5 + 3.5 + 5.0	14.0	1.29	2.25	2.25	3.21		9.00	2.9 ~ 10.8	2280	440 ~ 3190	3.95	A
2.0 + 3.5 + 3.5 + 6.0	15.0	1.20	2.10	2.10	3.60		9.00	3.0 ~ 11.0	2280	440 ~ 3340	3.95	A
2.0 + 3.5 + 3.5 + 7.1	16.1	1.11	1.96	1.96	3.97		9.00	3.0 ~ 11.2	2280	470 ~ 3410	3.95	A
2.0 + 3.5 + 4.2 + 4.2	13.9	1.29	2.27	2.72	2.72		9.00	2.9 ~ 10.8	2390	400 ~ 3410	3.77	A
2.0 + 3.5 + 4.2 + 5.0	14.7	1.22	2.14	2.57	3.07		9.00	3.0 ~ 11.0	2280	440 ~ 3270	3.95	A
2.0 + 3.5 + 4.2 + 6.0	15.7	1.14	2.01	2.41	3.44		9.00	3.0 ~ 11.0	2280	440 ~ 3270	3.95	A
2.0 + 3.5 + 4.2 + 7.1	16.8	1.07	1.88	2.25	3.80		9.00	3.0 ~ 11.2	2280	480 ~ 3420	3.95	A
2.0 + 3.5 + 5.0 + 5.0	15.5	1.16	2.04	2.90	2.90		9.00	3.0 ~ 11.0	2290	520 ~ 3130	3.93	A
2.0 + 3.5 + 5.0 + 6.0	16.5	1.09	1.91	2.73	3.27		9.00	3.0 ~ 11.2	2290	520 ~ 3280	3.93	A
2.0 + 3.5 + 5.0 + 7.1	17.6	1.02	1.79	2.56	3.63		9.00	3.0 ~ 11.2	2240	530 ~ 3280	4.02	A
2.0 + 3.5 + 6.0 + 6.0	17.5	1.02	1.80	3.09	3.09		9.00	3.0 ~ 11.2	2290	520 ~ 3280	3.93	A
2.0 + 4.2 + 4.2 + 4.2	14.6	1.23	2.59	2.59	2.59		9.00	3.0 ~ 11.0	2390	400 ~ 3480	3.77	A
2.0 + 4.2 + 4.2 + 5.0	15.4	1.17	2.45	2.45	2.93		9.00	3.0 ~ 11.0	2280	450 ~ 3270	3.95	A
2.0 + 4.2 + 4.2 + 6.0	16.4	1.10	2.30	2.30	3.30		9.00	3.0 ~ 11.2	2280	450 ~ 3410	3.95	A
2.0 + 4.2 + 4.2 + 7.1	17.5	1.03	2.16	2.16	3.65		9.00	3.0 ~ 11.2	2280	480 ~ 3340	3.95	A

4  
Room

	Indoor unit capacity Cooling	Annual Energy Consumption (kWh)	Current 230V (A)	ERP				Moisture Removal Volume l/h
				Pdesign (kW)	SEER		Annual Consumption (kWh)	
					WW	CLASS		
4 Room	2.0 + 2.0 + 2.5 + 2.5	1230	11.8	9.00	8.00	A++	394	1.3 + 1.3 + 1.5 + 1.5
	2.0 + 2.0 + 2.5 + 3.5	1230	11.8	9.00	8.00	A++	394	1.2 + 1.2 + 1.5 + 1.8
	2.0 + 2.0 + 2.5 + 4.2	1230	11.8	9.00	8.00	A++	394	1.1 + 1.1 + 1.4 + 2.0
	2.0 + 2.0 + 2.5 + 5.0	1165	11.2	9.00	8.00	A++	394	1.0 + 1.0 + 1.3 + 2.3
	2.0 + 2.0 + 2.5 + 6.0	1165	11.2	9.00	8.00	A++	394	0.9 + 0.9 + 1.2 + 2.4
	2.0 + 2.0 + 2.5 + 7.1	1140	10.9	9.00	8.00	A++	394	0.8 + 0.8 + 1.1 + 2.5
	2.0 + 2.0 + 3.5 + 3.5	1195	11.4	9.00	8.00	A++	394	1.0 + 1.0 + 1.7 + 1.7
	2.0 + 2.0 + 3.5 + 4.2	1195	11.4	9.00	8.00	A++	394	1.0 + 1.0 + 1.6 + 1.8
	2.0 + 2.0 + 3.5 + 5.0	1170	11.2	9.00	8.00	A++	394	0.9 + 0.9 + 1.5 + 2.1
	2.0 + 2.0 + 3.5 + 6.0	1170	11.2	9.00	8.00	A++	394	0.8 + 0.8 + 1.5 + 2.3
	2.0 + 2.0 + 3.5 + 7.1	1140	10.9	9.00	8.00	A++	394	0.8 + 0.8 + 1.4 + 2.4
	2.0 + 2.0 + 4.2 + 4.2	1195	11.4	9.00	8.00	A++	394	0.9 + 0.9 + 1.7 + 1.7
	2.0 + 2.0 + 4.2 + 5.0	1140	10.9	9.00	8.00	A++	394	0.9 + 0.9 + 1.7 + 2.0
	2.0 + 2.0 + 4.2 + 6.0	1140	10.9	9.00	8.00	A++	394	0.8 + 0.8 + 1.6 + 2.2
	2.0 + 2.0 + 4.2 + 7.1	1140	10.9	9.00	8.00	A++	394	0.7 + 0.7 + 1.5 + 2.4
	2.0 + 2.0 + 5.0 + 5.0	1145	11.0	9.00	8.00	A++	394	0.8 + 0.8 + 1.8 + 1.8
	2.0 + 2.0 + 5.0 + 6.0	1145	11.0	9.00	8.00	A++	394	0.7 + 0.7 + 1.7 + 2.1
	2.0 + 2.0 + 5.0 + 7.1	1115	10.7	9.00	8.00	A++	394	0.7 + 0.7 + 1.6 + 2.3
	2.0 + 2.0 + 6.0 + 6.0	1145	11.0	9.00	8.00	A++	394	0.7 + 0.7 + 1.9 + 1.9
	2.0 + 2.0 + 6.0 + 7.1	1115	10.7	9.00	8.00	A++	394	0.7 + 0.7 + 1.8 + 2.2
	2.0 + 2.0 + 7.1 + 7.1	1120	10.7	9.00	8.00	A++	394	0.7 + 0.7 + 2.0 + 2.0
	2.0 + 2.5 + 2.5 + 2.5	1230	11.8	9.00	8.00	A++	394	1.2 + 1.5 + 1.5 + 1.5
	2.0 + 2.5 + 2.5 + 3.5	1230	11.8	9.00	8.00	A++	394	1.1 + 1.4 + 1.4 + 1.7
	2.0 + 2.5 + 2.5 + 4.2	1230	11.8	9.00	8.00	A++	394	1.0 + 1.3 + 1.3 + 1.9
	2.0 + 2.5 + 2.5 + 5.0	1165	11.2	9.00	8.00	A++	394	0.9 + 1.2 + 1.2 + 2.2
	2.0 + 2.5 + 2.5 + 6.0	1165	11.2	9.00	8.00	A++	394	0.9 + 1.1 + 1.1 + 2.4
	2.0 + 2.5 + 2.5 + 7.1	1140	10.9	9.00	8.00	A++	394	0.8 + 1.0 + 1.0 + 2.5
	2.0 + 2.5 + 3.5 + 3.5	1195	11.4	9.00	8.00	A++	394	1.0 + 1.3 + 1.6 + 1.6
	2.0 + 2.5 + 3.5 + 4.2	1195	11.4	9.00	8.00	A++	394	0.9 + 1.2 + 1.6 + 1.7
	2.0 + 2.5 + 3.5 + 5.0	1170	11.2	9.00	8.00	A++	394	0.9 + 1.1 + 1.5 + 2.0
	2.0 + 2.5 + 3.5 + 6.0	1170	11.2	9.00	8.00	A++	394	0.8 + 1.0 + 1.5 + 2.3
	2.0 + 2.5 + 3.5 + 7.1	1140	10.9	9.00	8.00	A++	394	0.7 + 0.9 + 1.4 + 2.4
	2.0 + 2.5 + 4.2 + 4.2	1195	11.4	9.00	8.00	A++	394	0.9 + 1.1 + 1.7 + 1.7
	2.0 + 2.5 + 4.2 + 5.0	1140	10.9	9.00	8.00	A++	394	0.8 + 1.0 + 1.6 + 1.9
	2.0 + 2.5 + 4.2 + 6.0	1140	10.9	9.00	8.00	A++	394	0.8 + 1.0 + 1.6 + 2.1
	2.0 + 2.5 + 4.2 + 7.1	1140	10.9	9.00	8.00	A++	394	0.7 + 0.9 + 1.5 + 2.3
	2.0 + 2.5 + 5.0 + 5.0	1145	11.0	9.00	8.00	A++	394	0.8 + 1.0 + 1.7 + 1.8
	2.0 + 2.5 + 5.0 + 6.0	1145	11.0	9.00	8.00	A++	394	0.7 + 0.9 + 1.7 + 2.0
	2.0 + 2.5 + 5.0 + 7.1	1115	10.7	9.00	8.00	A++	394	0.7 + 0.9 + 1.6 + 2.3
	2.0 + 2.5 + 6.0 + 6.0	1145	11.0	9.00	8.00	A++	394	0.7 + 0.9 + 1.9 + 1.9
	2.0 + 2.5 + 6.0 + 7.1	1115	10.7	9.00	8.00	A++	394	0.7 + 0.8 + 1.7 + 2.1
	2.0 + 3.5 + 3.5 + 3.5	1195	11.4	9.00	8.00	A++	394	0.9 + 1.5 + 1.5 + 1.5
2.0 + 3.5 + 3.5 + 4.2	1195	11.4	9.00	8.00	A++	394	0.9 + 1.5 + 1.5 + 1.7	
2.0 + 3.5 + 3.5 + 5.0	1140	10.9	9.00	8.00	A++	394	0.8 + 1.5 + 1.5 + 1.8	
2.0 + 3.5 + 3.5 + 6.0	1140	10.9	9.00	8.00	A++	394	0.7 + 1.4 + 1.4 + 2.1	
2.0 + 3.5 + 3.5 + 7.1	1140	10.9	9.00	8.00	A++	394	0.7 + 1.3 + 1.3 + 2.3	
2.0 + 3.5 + 4.2 + 4.2	1195	11.4	9.00	8.00	A++	394	0.8 + 1.5 + 1.6 + 1.6	
2.0 + 3.5 + 4.2 + 5.0	1140	10.9	9.00	8.00	A++	394	0.8 + 1.4 + 1.6 + 1.7	
2.0 + 3.5 + 4.2 + 6.0	1140	10.9	9.00	8.00	A++	394	0.7 + 1.3 + 1.5 + 2.0	
2.0 + 3.5 + 4.2 + 7.1	1140	10.9	9.00	8.00	A++	394	0.7 + 1.2 + 1.5 + 2.2	
2.0 + 3.5 + 5.0 + 5.0	1145	11.0	9.00	8.00	A++	394	0.7 + 1.3 + 1.7 + 1.7	
2.0 + 3.5 + 5.0 + 6.0	1145	11.0	9.00	8.00	A++	394	0.7 + 1.2 + 1.6 + 1.9	
2.0 + 3.5 + 5.0 + 7.1	1120	10.7	9.00	8.00	A++	394	0.7 + 1.2 + 1.6 + 2.1	
2.0 + 3.5 + 6.0 + 6.0	1145	11.0	9.00	8.00	A++	394	0.7 + 1.2 + 1.7 + 1.7	
2.0 + 4.2 + 4.2 + 4.2	1195	11.4	9.00	8.00	A++	394	0.8 + 1.6 + 1.6 + 1.6	
2.0 + 4.2 + 4.2 + 5.0	1140	10.9	9.00	8.00	A++	394	0.7 + 1.5 + 1.5 + 1.7	
2.0 + 4.2 + 4.2 + 6.0	1140	10.9	9.00	8.00	A++	394	0.7 + 1.5 + 1.5 + 1.9	
2.0 + 4.2 + 4.2 + 7.1	1140	10.9	9.00	8.00	A++	394	0.7 + 1.4 + 1.4 + 2.1	

Indoor unit capacity Cooling	Total	Cooling Capacity (kW)							Input Power (W)		EER	
		Room A	Room B	Room C	Room D	Room E	Total	min ~ max	Rating	min ~ max	WW	CLASS
2.0 + 4.2 + 5.0 + 5.0	16.2	1.11	2.33	2.78	2.78		9.00	3.0 ~ 11.2	2230	520 ~ 3280	4.04	A
2.0 + 4.2 + 5.0 + 6.0	17.2	1.04	2.20	2.62	3.14		9.00	3.0 ~ 11.2	2230	520 ~ 3280	4.04	A
2.0 + 4.2 + 5.0 + 7.1	18.3	0.98	2.07	2.46	3.49		9.00	3.0 ~ 11.2	2240	530 ~ 3210	4.02	A
2.0 + 4.2 + 6.0 + 6.0	18.2	0.98	2.08	2.97	2.97		9.00	3.0 ~ 11.2	2230	520 ~ 3280	4.04	A
2.0 + 5.0 + 5.0 + 5.0	17.0	1.05	2.65	2.65	2.65		9.00	3.0 ~ 11.2	2250	580 ~ 3220	4.00	A
2.0 + 5.0 + 5.0 + 6.0	18.0	1.00	2.50	2.50	3.00		9.00	3.0 ~ 11.2	2250	580 ~ 3220	4.00	A
2.5 + 2.5 + 2.5 + 2.5	10.0	2.25	2.25	2.25	2.25		9.00	2.9 ~ 10.6	2460	370 ~ 3480	3.66	A
2.5 + 2.5 + 2.5 + 3.5	11.0	2.05	2.05	2.05	2.85		9.00	2.9 ~ 10.6	2460	370 ~ 3410	3.66	A
2.5 + 2.5 + 2.5 + 4.2	11.7	1.92	1.92	1.92	3.24		9.00	2.9 ~ 10.6	2460	370 ~ 3410	3.66	A
2.5 + 2.5 + 2.5 + 5.0	12.5	1.80	1.80	1.80	3.60		9.00	2.9 ~ 10.8	2330	410 ~ 3260	3.86	A
2.5 + 2.5 + 2.5 + 6.0	13.5	1.67	1.67	1.67	3.99		9.00	2.9 ~ 10.8	2330	410 ~ 3260	3.86	A
2.5 + 2.5 + 2.5 + 7.1	14.6	1.54	1.54	1.54	4.38		9.00	3.0 ~ 11.0	2280	440 ~ 3340	3.95	A
2.5 + 2.5 + 3.5 + 3.5	12.0	1.87	1.87	2.63	2.63		9.00	2.9 ~ 10.6	2390	370 ~ 3330	3.77	A
2.5 + 2.5 + 3.5 + 4.2	12.7	1.77	1.77	2.48	2.98		9.00	2.9 ~ 10.8	2390	370 ~ 3480	3.77	A
2.5 + 2.5 + 3.5 + 5.0	13.5	1.67	1.67	2.33	3.33		9.00	2.9 ~ 10.8	2340	440 ~ 3190	3.85	A
2.5 + 2.5 + 3.5 + 6.0	14.5	1.55	1.55	2.17	3.73		9.00	3.0 ~ 11.0	2340	440 ~ 3340	3.85	A
2.5 + 2.5 + 3.5 + 7.1	15.6	1.44	1.44	2.02	4.10		9.00	3.0 ~ 11.0	2280	440 ~ 3270	3.95	A
2.5 + 2.5 + 4.2 + 4.2	13.4	1.68	1.68	2.82	2.82		9.00	2.9 ~ 10.8	2390	370 ~ 3480	3.77	A
2.5 + 2.5 + 4.2 + 5.0	14.2	1.58	1.58	2.66	3.18		9.00	3.0 ~ 11.0	2280	440 ~ 3340	3.95	A
2.5 + 2.5 + 4.2 + 6.0	15.2	1.48	1.48	2.49	3.55		9.00	3.0 ~ 11.0	2280	440 ~ 3340	3.95	A
2.5 + 2.5 + 4.2 + 7.1	16.3	1.38	1.38	2.32	3.92		9.00	3.0 ~ 11.2	2280	450 ~ 3410	3.95	A
2.5 + 2.5 + 5.0 + 5.0	15.0	1.50	1.50	3.00	3.00		9.00	3.0 ~ 11.0	2290	490 ~ 3200	3.93	A
2.5 + 2.5 + 5.0 + 6.0	16.0	1.41	1.41	2.80	3.38		9.00	3.0 ~ 11.2	2290	490 ~ 3270	3.93	A
2.5 + 2.5 + 5.0 + 7.1	17.1	1.32	1.32	2.62	3.74		9.00	3.0 ~ 11.2	2230	520 ~ 3280	4.04	A
2.5 + 2.5 + 6.0 + 6.0	17.0	1.32	1.32	3.18	3.18		9.00	3.0 ~ 11.2	2290	490 ~ 3270	3.93	A
2.5 + 2.5 + 6.0 + 7.1	18.1	1.24	1.24	2.98	3.54		9.00	3.0 ~ 11.2	2230	520 ~ 3280	4.04	A
2.5 + 3.5 + 3.5 + 3.5	13.0	1.74	2.42	2.42	2.42		9.00	2.9 ~ 10.8	2390	400 ~ 3410	3.77	A
2.5 + 3.5 + 3.5 + 4.2	13.7	1.64	2.30	2.30	2.76		9.00	2.9 ~ 10.8	2390	400 ~ 3410	3.77	A
2.5 + 3.5 + 3.5 + 5.0	14.5	1.55	2.17	2.17	3.11		9.00	3.0 ~ 11.0	2280	440 ~ 3340	3.95	A
2.5 + 3.5 + 3.5 + 6.0	15.5	1.45	2.03	2.03	3.49		9.00	3.0 ~ 11.0	2280	440 ~ 3340	3.95	A
2.5 + 3.5 + 3.5 + 7.1	16.6	1.35	1.90	1.90	3.85		9.00	3.0 ~ 11.2	2280	470 ~ 3410	3.95	A
2.5 + 3.5 + 4.2 + 4.2	14.4	1.55	2.19	2.63	2.63		9.00	3.0 ~ 11.0	2390	400 ~ 3560	3.77	A
2.5 + 3.5 + 4.2 + 5.0	15.2	1.48	2.07	2.49	2.96		9.00	3.0 ~ 11.0	2280	440 ~ 3270	3.95	A
2.5 + 3.5 + 4.2 + 6.0	16.2	1.39	1.95	2.33	3.33		9.00	3.0 ~ 11.2	2280	440 ~ 3410	3.95	A
2.5 + 3.5 + 4.2 + 7.1	17.3	1.30	1.82	2.18	3.70		9.00	3.0 ~ 11.2	2280	480 ~ 3420	3.95	A
2.5 + 3.5 + 5.0 + 5.0	16.0	1.41	1.97	2.81	2.81		9.00	3.0 ~ 11.2	2290	520 ~ 3280	3.93	A
2.5 + 3.5 + 5.0 + 6.0	17.0	1.32	1.85	2.65	3.18		9.00	3.0 ~ 11.2	2290	520 ~ 3280	3.93	A
2.5 + 3.5 + 5.0 + 7.1	18.1	1.24	1.74	2.49	3.53		9.00	3.0 ~ 11.2	2240	530 ~ 3280	4.02	A
2.5 + 3.5 + 6.0 + 6.0	18.0	1.25	1.75	3.00	3.00		9.00	3.0 ~ 11.2	2290	520 ~ 3280	3.93	A
2.5 + 4.2 + 4.2 + 4.2	15.1	1.50	2.50	2.50	2.50		9.00	3.0 ~ 11.0	2390	400 ~ 3480	3.77	A
2.5 + 4.2 + 4.2 + 5.0	15.9	1.41	2.38	2.38	2.83		9.00	3.0 ~ 11.2	2280	450 ~ 3410	3.95	A
2.5 + 4.2 + 4.2 + 6.0	16.9	1.32	2.24	2.24	3.20		9.00	3.0 ~ 11.2	2280	450 ~ 3410	3.95	A
2.5 + 4.2 + 4.2 + 7.1	18.0	1.25	2.10	2.10	3.55		9.00	3.0 ~ 11.2	2280	480 ~ 3340	3.95	A
2.5 + 4.2 + 5.0 + 5.0	16.7	1.35	2.27	2.69	2.69		9.00	3.0 ~ 11.2	2230	520 ~ 3280	4.04	A
2.5 + 4.2 + 5.0 + 6.0	17.7	1.27	2.14	2.54	3.05		9.00	3.0 ~ 11.2	2230	520 ~ 3280	4.04	A
2.5 + 5.0 + 5.0 + 5.0	17.5	1.29	2.57	2.57	2.57		9.00	3.0 ~ 11.2	2250	580 ~ 3220	4.00	A
3.5 + 3.5 + 3.5 + 3.5	14.0	2.25	2.25	2.25	2.25		9.00	2.9 ~ 10.8	2330	400 ~ 3330	3.86	A
3.5 + 3.5 + 3.5 + 4.2	14.7	2.14	2.14	2.14	2.58		9.00	3.0 ~ 11.0	2330	410 ~ 3480	3.86	A
3.5 + 3.5 + 3.5 + 5.0	15.5	2.03	2.03	2.03	2.91		9.00	3.0 ~ 11.0	2280	470 ~ 3270	3.95	A
3.5 + 3.5 + 3.5 + 6.0	16.5	1.91	1.91	1.91	3.27		9.00	3.0 ~ 11.2	2280	470 ~ 3410	3.95	A
3.5 + 3.5 + 3.5 + 7.1	17.6	1.79	1.79	1.79	3.63		9.00	3.0 ~ 11.2	2280	480 ~ 3340	3.95	A
3.5 + 3.5 + 4.2 + 4.2	15.4	2.05	2.05	2.45	2.45		9.00	3.0 ~ 11.0	2330	410 ~ 3480	3.86	A
3.5 + 3.5 + 4.2 + 5.0	16.2	1.94	1.94	2.33	2.79		9.00	3.0 ~ 11.2	2280	470 ~ 3410	3.95	A
3.5 + 3.5 + 4.2 + 6.0	17.2	1.83	1.83	2.20	3.14		9.00	3.0 ~ 11.2	2280	470 ~ 3410	3.95	A
3.5 + 3.5 + 4.2 + 7.1	18.3	1.72	1.72	2.07	3.49		9.00	3.0 ~ 11.2	2280	480 ~ 3340	3.95	A
3.5 + 3.5 + 5.0 + 5.0	17.0	1.85	1.85	2.65	2.65		9.00	3.0 ~ 11.2	2240	520 ~ 3280	4.02	A
3.5 + 3.5 + 5.0 + 6.0	18.0	1.75	1.75	2.50	3.00		9.00	3.0 ~ 11.2	2240	520 ~ 3280	4.02	A
3.5 + 4.2 + 4.2 + 4.2	16.1	1.95	2.35	2.35	2.35		9.00	3.0 ~ 11.2	2330	410 ~ 3640	3.86	A



	Indoor unit capacity Cooling	Annual Energy Consumption (kWh)	Current 230V (A)	ERP				Moisture Removal Volume l/h
				Pdesign (kW)	SEER		Annual Consumption (kWh)	
					WW	CLASS		
4 Room	2.0 + 4.2 + 5.0 + 5.0	1115	10.7	9.00	8.00	A++	394	0.7 + 1.5 + 1.6 + 1.6
	2.0 + 4.2 + 5.0 + 6.0	1115	10.7	9.00	8.00	A++	394	0.7 + 1.4 + 1.6 + 1.8
	2.0 + 4.2 + 5.0 + 7.1	1120	10.7	9.00	8.00	A++	394	0.7 + 1.3 + 1.5 + 2.0
	2.0 + 4.2 + 6.0 + 6.0	1115	10.7	9.00	8.00	A++	394	0.7 + 1.3 + 1.7 + 1.7
	2.0 + 5.0 + 5.0 + 5.0	1125	10.8	9.00	8.00	A++	394	0.7 + 1.6 + 1.6 + 1.6
	2.0 + 5.0 + 5.0 + 6.0	1125	10.8	9.00	8.00	A++	394	0.7 + 1.5 + 1.5 + 1.7
	2.5 + 2.5 + 2.5 + 2.5	1230	11.8	9.00	8.00	A++	394	1.5 + 1.5 + 1.5 + 1.5
	2.5 + 2.5 + 2.5 + 3.5	1230	11.8	9.00	8.00	A++	394	1.3 + 1.3 + 1.3 + 1.7
	2.5 + 2.5 + 2.5 + 4.2	1230	11.8	9.00	8.00	A++	394	1.2 + 1.2 + 1.2 + 1.8
	2.5 + 2.5 + 2.5 + 5.0	1165	11.2	9.00	8.00	A++	394	1.2 + 1.2 + 1.2 + 2.1
	2.5 + 2.5 + 2.5 + 6.0	1165	11.2	9.00	8.00	A++	394	1.1 + 1.1 + 1.1 + 2.3
	2.5 + 2.5 + 2.5 + 7.1	1140	10.9	9.00	8.00	A++	394	1.0 + 1.0 + 1.0 + 2.4
	2.5 + 2.5 + 3.5 + 3.5	1195	11.4	9.00	8.00	A++	394	1.2 + 1.2 + 1.6 + 1.6
	2.5 + 2.5 + 3.5 + 4.2	1195	11.4	9.00	8.00	A++	394	1.1 + 1.1 + 1.5 + 1.7
	2.5 + 2.5 + 3.5 + 5.0	1170	11.2	9.00	8.00	A++	394	1.1 + 1.1 + 1.5 + 1.9
	2.5 + 2.5 + 3.5 + 6.0	1170	11.2	9.00	8.00	A++	394	1.0 + 1.0 + 1.4 + 2.2
	2.5 + 2.5 + 3.5 + 7.1	1140	10.9	9.00	8.00	A++	394	0.9 + 0.9 + 1.3 + 2.3
	2.5 + 2.5 + 4.2 + 4.2	1195	11.4	9.00	8.00	A++	394	1.1 + 1.1 + 1.7 + 1.7
	2.5 + 2.5 + 4.2 + 5.0	1140	10.9	9.00	8.00	A++	394	1.0 + 1.0 + 1.6 + 1.8
	2.5 + 2.5 + 4.2 + 6.0	1140	10.9	9.00	8.00	A++	394	0.9 + 0.9 + 1.5 + 2.1
	2.5 + 2.5 + 4.2 + 7.1	1140	10.9	9.00	8.00	A++	394	0.9 + 0.9 + 1.5 + 2.3
	2.5 + 2.5 + 5.0 + 5.0	1145	11.0	9.00	8.00	A++	394	1.0 + 1.0 + 1.7 + 1.7
	2.5 + 2.5 + 5.0 + 6.0	1145	11.0	9.00	8.00	A++	394	0.9 + 0.9 + 1.6 + 1.9
	2.5 + 2.5 + 5.0 + 7.1	1115	10.7	9.00	8.00	A++	394	0.8 + 0.8 + 1.6 + 2.2
	2.5 + 2.5 + 6.0 + 6.0	1145	11.0	9.00	8.00	A++	394	0.8 + 0.8 + 1.8 + 1.8
	2.5 + 2.5 + 6.0 + 7.1	1115	10.7	9.00	8.00	A++	394	0.8 + 0.8 + 1.7 + 2.0
	2.5 + 3.5 + 3.5 + 3.5	1195	11.4	9.00	8.00	A++	394	1.1 + 1.5 + 1.5 + 1.5
	2.5 + 3.5 + 3.5 + 4.2	1195	11.4	9.00	8.00	A++	394	1.0 + 1.5 + 1.5 + 1.6
	2.5 + 3.5 + 3.5 + 5.0	1140	10.9	9.00	8.00	A++	394	1.0 + 1.4 + 1.4 + 1.8
	2.5 + 3.5 + 3.5 + 6.0	1140	10.9	9.00	8.00	A++	394	0.9 + 1.3 + 1.3 + 2.0
	2.5 + 3.5 + 3.5 + 7.1	1140	10.9	9.00	8.00	A++	394	0.9 + 1.2 + 1.2 + 2.3
	2.5 + 3.5 + 4.2 + 4.2	1195	11.4	9.00	8.00	A++	394	1.0 + 1.4 + 1.6 + 1.6
	2.5 + 3.5 + 4.2 + 5.0	1140	10.9	9.00	8.00	A++	394	0.9 + 1.3 + 1.5 + 1.7
	2.5 + 3.5 + 4.2 + 6.0	1140	10.9	9.00	8.00	A++	394	0.9 + 1.3 + 1.5 + 1.9
	2.5 + 3.5 + 4.2 + 7.1	1140	10.9	9.00	8.00	A++	394	0.8 + 1.2 + 1.4 + 2.2
	2.5 + 3.5 + 5.0 + 5.0	1145	11.0	9.00	8.00	A++	394	0.9 + 1.3 + 1.6 + 1.6
	2.5 + 3.5 + 5.0 + 6.0	1145	11.0	9.00	8.00	A++	394	0.8 + 1.2 + 1.6 + 1.8
	2.5 + 3.5 + 5.0 + 7.1	1120	10.7	9.00	8.00	A++	394	0.8 + 1.1 + 1.5 + 2.0
	2.5 + 3.5 + 6.0 + 6.0	1145	11.0	9.00	8.00	A++	394	0.8 + 1.1 + 1.7 + 1.7
	2.5 + 4.2 + 4.2 + 4.2	1195	11.4	9.00	8.00	A++	394	1.0 + 1.5 + 1.5 + 1.5
2.5 + 4.2 + 4.2 + 5.0	1140	10.9	9.00	8.00	A++	394	0.9 + 1.5 + 1.5 + 1.7	
2.5 + 4.2 + 4.2 + 6.0	1140	10.9	9.00	8.00	A++	394	0.8 + 1.5 + 1.5 + 1.8	
2.5 + 4.2 + 4.2 + 7.1	1140	10.9	9.00	8.00	A++	394	0.8 + 1.4 + 1.4 + 2.1	
2.5 + 4.2 + 5.0 + 5.0	1115	10.7	9.00	8.00	A++	394	0.9 + 1.5 + 1.6 + 1.6	
2.5 + 4.2 + 5.0 + 6.0	1115	10.7	9.00	8.00	A++	394	0.8 + 1.4 + 1.6 + 1.7	
2.5 + 5.0 + 5.0 + 5.0	1125	10.8	9.00	8.00	A++	394	0.8 + 1.6 + 1.6 + 1.6	
3.5 + 3.5 + 3.5 + 3.5	1165	11.2	9.00	8.00	A++	394	1.5 + 1.5 + 1.5 + 1.5	
3.5 + 3.5 + 3.5 + 4.2	1165	11.2	9.00	8.00	A++	394	1.4 + 1.4 + 1.4 + 1.6	
3.5 + 3.5 + 3.5 + 5.0	1140	10.9	9.00	8.00	A++	394	1.3 + 1.3 + 1.3 + 1.7	
3.5 + 3.5 + 3.5 + 6.0	1140	10.9	9.00	8.00	A++	394	1.2 + 1.2 + 1.2 + 1.9	
3.5 + 3.5 + 3.5 + 7.1	1140	10.9	9.00	8.00	A++	394	1.2 + 1.2 + 1.2 + 2.1	
3.5 + 3.5 + 4.2 + 4.2	1165	11.2	9.00	8.00	A++	394	1.3 + 1.3 + 1.5 + 1.5	
3.5 + 3.5 + 4.2 + 5.0	1140	10.9	9.00	8.00	A++	394	1.3 + 1.3 + 1.5 + 1.6	
3.5 + 3.5 + 4.2 + 6.0	1140	10.9	9.00	8.00	A++	394	1.2 + 1.2 + 1.4 + 1.8	
3.5 + 3.5 + 4.2 + 7.1	1140	10.9	9.00	8.00	A++	394	1.1 + 1.1 + 1.3 + 2.0	
3.5 + 3.5 + 5.0 + 5.0	1120	10.7	9.00	8.00	A++	394	1.2 + 1.2 + 1.6 + 1.6	
3.5 + 3.5 + 5.0 + 6.0	1120	10.7	9.00	8.00	A++	394	1.1 + 1.1 + 1.5 + 1.7	
3.5 + 4.2 + 4.2 + 4.2	1165	11.2	9.00	8.00	A++	394	1.3 + 1.5 + 1.5 + 1.5	

Indoor unit capacity Cooling		Total	Cooling Capacity (kW)							Input Power (W)		EER	
			Room A	Room B	Room C	Room D	Room E	Total	min ~ max	Rating	min ~ max	WW	CLASS
4 Room	3.5 + 4.2 + 4.2 + 5.0	16.9	1.86	2.24	2.24	2.66		9.00	3.0 ~ 11.2	2280	480 ~ 3420	3.95	A
	3.5 + 4.2 + 4.2 + 6.0	17.9	1.76	2.11	2.11	3.02		9.00	3.0 ~ 11.2	2280	480 ~ 3420	3.95	A
	3.5 + 4.2 + 5.0 + 5.0	17.7	1.78	2.14	2.54	2.54		9.00	3.0 ~ 11.2	2240	530 ~ 3280	4.02	A
	4.2 + 4.2 + 4.2 + 4.2	16.8	2.25	2.25	2.25	2.25		9.00	3.0 ~ 11.2	2330	430 ~ 3560	3.86	A
	4.2 + 4.2 + 4.2 + 5.0	17.6	2.15	2.15	2.15	2.55		9.00	3.0 ~ 11.2	2280	480 ~ 3340	3.95	A

Indoor unit capacity Cooling		Annual Energy Consumption (kWh)	Current 230V (A)	ERP				Moisture Removal Volume l/h
				Pdesign (kW)	SEER		Annual Consumption (kWh)	
					WW	CLASS		
4 Room	3.5 + 4.2 + 4.2 + 5.0	1140	10.9	9.00	8.00	A++	394	1.2 + 1.5 + 1.5 + 1.6
	3.5 + 4.2 + 4.2 + 6.0	1140	10.9	9.00	8.00	A++	394	1.1 + 1.4 + 1.4 + 1.7
	3.5 + 4.2 + 5.0 + 5.0	1120	10.7	9.00	8.00	A++	394	1.1 + 1.4 + 1.6 + 1.6
	4.2 + 4.2 + 4.2 + 4.2	1165	11.2	9.00	8.00	A++	394	1.5 + 1.5 + 1.5 + 1.5
	4.2 + 4.2 + 4.2 + 5.0	1140	10.9	9.00	8.00	A++	394	1.4 + 1.4 + 1.4 + 1.6

Indoor unit capacity Cooling	Total	Cooling Capacity (kW)							Input Power (W)		EER	
		Room A	Room B	Room C	Room D	Room E	Total	min ~ max	Rating	min ~ max	WW	CLASS
1.6 + 1.6 + 1.6 + 1.6 + 1.6	8.0	1.60	1.60	1.60	1.60	1.60	8.00	2.9 ~ 11.5	1970	450 ~ 3660	4.06	A
1.6 + 1.6 + 1.6 + 1.6 + 2.0	8.4	1.60	1.60	1.60	1.60	2.00	8.40	2.9 ~ 11.5	2080	450 ~ 3660	4.04	A
1.6 + 1.6 + 1.6 + 1.6 + 2.5	8.9	1.62	1.62	1.62	1.62	2.52	9.00	2.9 ~ 11.5	2300	450 ~ 3660	3.91	A
1.6 + 1.6 + 1.6 + 1.6 + 3.5	9.9	1.45	1.45	1.45	1.45	3.20	9.00	2.9 ~ 11.5	2300	450 ~ 3590	3.91	A
1.6 + 1.6 + 1.6 + 1.6 + 4.2	10.6	1.36	1.36	1.36	1.36	3.56	9.00	2.9 ~ 11.5	2300	450 ~ 3590	3.91	A
1.6 + 1.6 + 1.6 + 1.6 + 5.0	11.4	1.26	1.26	1.26	1.26	3.96	9.00	2.9 ~ 11.5	2260	530 ~ 3450	3.98	A
1.6 + 1.6 + 1.6 + 1.6 + 6.0	12.4	1.16	1.16	1.16	1.16	4.36	9.00	2.9 ~ 11.5	2260	530 ~ 3450	3.98	A
1.6 + 1.6 + 1.6 + 1.6 + 7.1	13.5	1.07	1.07	1.07	1.07	4.72	9.00	2.9 ~ 11.5	2260	540 ~ 3380	3.98	A
1.6 + 1.6 + 1.6 + 2.0 + 2.0	8.8	1.60	1.60	1.60	2.00	2.00	8.80	2.9 ~ 11.5	2240	450 ~ 3580	3.93	A
1.6 + 1.6 + 1.6 + 2.0 + 2.5	9.3	1.55	1.55	1.55	1.94	2.41	9.00	2.9 ~ 11.5	2300	450 ~ 3580	3.91	A
1.6 + 1.6 + 1.6 + 2.0 + 3.5	10.3	1.40	1.40	1.40	1.75	3.05	9.00	2.9 ~ 11.5	2300	450 ~ 3590	3.91	A
1.6 + 1.6 + 1.6 + 2.0 + 4.2	11.0	1.31	1.31	1.31	1.64	3.43	9.00	2.9 ~ 11.5	2300	480 ~ 3590	3.91	A
1.6 + 1.6 + 1.6 + 2.0 + 5.0	11.8	1.22	1.22	1.22	1.53	3.81	9.00	2.9 ~ 11.5	2260	530 ~ 3450	3.98	A
1.6 + 1.6 + 1.6 + 2.0 + 6.0	12.8	1.13	1.13	1.13	1.41	4.20	9.00	2.9 ~ 11.5	2260	530 ~ 3450	3.98	A
1.6 + 1.6 + 1.6 + 2.0 + 7.1	13.9	1.04	1.04	1.04	1.29	4.59	9.00	2.9 ~ 11.5	2270	540 ~ 3380	3.96	A
1.6 + 1.6 + 1.6 + 2.5 + 2.5	9.8	1.47	1.47	1.47	2.29	2.29	8.99	2.9 ~ 11.5	2300	450 ~ 3580	3.91	A
1.6 + 1.6 + 1.6 + 2.5 + 3.5	10.8	1.33	1.33	1.33	2.08	2.93	9.00	2.9 ~ 11.5	2300	450 ~ 3590	3.91	A
1.6 + 1.6 + 1.6 + 2.5 + 4.2	11.5	1.25	1.25	1.25	1.96	3.29	9.00	2.9 ~ 11.5	2300	480 ~ 3590	3.91	A
1.6 + 1.6 + 1.6 + 2.5 + 5.0	12.3	1.17	1.17	1.17	1.83	3.66	9.00	2.9 ~ 11.5	2260	530 ~ 3450	3.98	A
1.6 + 1.6 + 1.6 + 2.5 + 6.0	13.3	1.08	1.08	1.08	1.69	4.07	9.00	2.9 ~ 11.5	2260	530 ~ 3450	3.98	A
1.6 + 1.6 + 1.6 + 2.5 + 7.1	14.4	1.00	1.00	1.00	1.56	4.44	9.00	2.9 ~ 11.5	2270	540 ~ 3380	3.96	A
1.6 + 1.6 + 1.6 + 3.5 + 3.5	11.8	1.22	1.22	1.22	2.67	2.67	9.00	2.9 ~ 11.5	2310	480 ~ 3510	3.90	A
1.6 + 1.6 + 1.6 + 3.5 + 4.2	12.5	1.15	1.15	1.15	2.52	3.03	9.00	2.9 ~ 11.5	2310	480 ~ 3510	3.90	A
1.6 + 1.6 + 1.6 + 3.5 + 5.0	13.3	1.08	1.08	1.08	2.37	3.39	9.00	2.9 ~ 11.5	2270	540 ~ 3380	3.96	A
1.6 + 1.6 + 1.6 + 3.5 + 6.0	14.3	1.01	1.01	1.01	2.20	3.77	9.00	2.9 ~ 11.5	2270	540 ~ 3380	3.96	A
1.6 + 1.6 + 1.6 + 3.5 + 7.1	15.4	0.94	0.94	0.94	2.05	4.13	9.00	2.9 ~ 11.5	2270	570 ~ 3380	3.96	A
1.6 + 1.6 + 1.6 + 4.2 + 4.2	13.2	1.09	1.09	1.09	2.86	2.86	8.99	2.9 ~ 11.5	2310	490 ~ 3510	3.89	A
1.6 + 1.6 + 1.6 + 4.2 + 5.0	14.0	1.03	1.03	1.03	2.70	3.21	9.00	2.9 ~ 11.5	2270	540 ~ 3380	3.96	A
1.6 + 1.6 + 1.6 + 4.2 + 6.0	15.0	0.96	0.96	0.96	2.52	3.60	9.00	2.9 ~ 11.5	2270	540 ~ 3380	3.96	A
1.6 + 1.6 + 1.6 + 4.2 + 7.1	16.1	0.89	0.89	0.89	2.35	3.98	9.00	2.9 ~ 11.5	2270	570 ~ 3390	3.96	A
1.6 + 1.6 + 1.6 + 5.0 + 5.0	14.8	0.97	0.97	0.97	3.04	3.05	9.00	2.9 ~ 11.5	2290	620 ~ 3330	3.93	A
1.6 + 1.6 + 1.6 + 5.0 + 6.0	15.8	0.91	0.91	0.91	2.85	3.42	9.00	2.9 ~ 11.5	2290	620 ~ 3330	3.93	A
1.6 + 1.6 + 1.6 + 5.0 + 7.1	16.9	0.85	0.85	0.85	2.66	3.79	9.00	2.9 ~ 11.5	2360	660 ~ 3340	3.81	A
1.6 + 1.6 + 1.6 + 6.0 + 6.0	16.8	0.86	0.86	0.86	3.21	3.21	9.00	2.9 ~ 11.5	2290	620 ~ 3330	3.93	A
1.6 + 1.6 + 1.6 + 6.0 + 7.1	17.9	0.80	0.80	0.80	3.02	3.58	9.00	2.9 ~ 11.5	2360	660 ~ 3340	3.81	A
1.6 + 1.6 + 2.0 + 2.0 + 2.0	9.2	1.56	1.56	1.96	1.96	1.96	9.00	2.9 ~ 11.5	2300	450 ~ 3590	3.91	A
1.6 + 1.6 + 2.0 + 2.0 + 2.5	9.7	1.48	1.48	1.86	1.86	2.32	9.00	2.9 ~ 11.5	2300	450 ~ 3590	3.91	A
1.6 + 1.6 + 2.0 + 2.0 + 3.5	10.7	1.35	1.35	1.68	1.68	2.94	9.00	2.9 ~ 11.5	2300	480 ~ 3590	3.91	A
1.6 + 1.6 + 2.0 + 2.0 + 4.2	11.4	1.26	1.26	1.58	1.58	3.32	9.00	2.9 ~ 11.5	2300	480 ~ 3510	3.91	A
1.6 + 1.6 + 2.0 + 2.0 + 5.0	12.2	1.18	1.18	1.48	1.48	3.68	9.00	2.9 ~ 11.5	2260	530 ~ 3380	3.98	A
1.6 + 1.6 + 2.0 + 2.0 + 6.0	13.2	1.09	1.09	1.36	1.36	4.10	9.00	2.9 ~ 11.5	2260	530 ~ 3380	3.98	A
1.6 + 1.6 + 2.0 + 2.0 + 7.1	14.3	1.01	1.01	1.26	1.26	4.46	9.00	2.9 ~ 11.5	2270	570 ~ 3380	3.96	A
1.6 + 1.6 + 2.0 + 2.5 + 2.5	10.2	1.41	1.41	1.76	2.21	2.21	9.00	2.9 ~ 11.5	2300	450 ~ 3590	3.91	A
1.6 + 1.6 + 2.0 + 2.5 + 3.5	11.2	1.29	1.29	1.61	2.01	2.80	9.00	2.9 ~ 11.5	2300	480 ~ 3590	3.91	A
1.6 + 1.6 + 2.0 + 2.5 + 4.2	11.9	1.21	1.21	1.51	1.89	3.18	9.00	2.9 ~ 11.5	2300	480 ~ 3510	3.91	A
1.6 + 1.6 + 2.0 + 2.5 + 5.0	12.7	1.13	1.13	1.42	1.77	3.55	9.00	2.9 ~ 11.5	2260	530 ~ 3380	3.98	A
1.6 + 1.6 + 2.0 + 2.5 + 6.0	13.7	1.05	1.05	1.31	1.64	3.95	9.00	2.9 ~ 11.5	2260	530 ~ 3380	3.98	A
1.6 + 1.6 + 2.0 + 2.5 + 7.1	14.8	0.97	0.97	1.22	1.52	4.32	9.00	2.9 ~ 11.5	2270	570 ~ 3380	3.96	A
1.6 + 1.6 + 2.0 + 3.5 + 3.5	12.2	1.18	1.18	1.48	2.58	2.58	9.00	2.9 ~ 11.5	2310	490 ~ 3510	3.90	A
1.6 + 1.6 + 2.0 + 3.5 + 4.2	12.9	1.12	1.12	1.40	2.44	2.92	9.00	2.9 ~ 11.5	2310	490 ~ 3510	3.90	A
1.6 + 1.6 + 2.0 + 3.5 + 5.0	13.7	1.05	1.05	1.31	2.30	3.29	9.00	2.9 ~ 11.5	2270	540 ~ 3380	3.96	A
1.6 + 1.6 + 2.0 + 3.5 + 6.0	14.7	0.98	0.98	1.22	2.14	3.68	9.00	2.9 ~ 11.5	2270	540 ~ 3380	3.96	A
1.6 + 1.6 + 2.0 + 3.5 + 7.1	15.8	0.91	0.91	1.14	1.99	4.05	9.00	2.9 ~ 11.5	2270	570 ~ 3390	3.96	A
1.6 + 1.6 + 2.0 + 4.2 + 4.2	13.6	1.06	1.06	1.32	2.78	2.78	9.00	2.9 ~ 11.5	2310	490 ~ 3520	3.90	A
1.6 + 1.6 + 2.0 + 4.2 + 5.0	14.4	1.00	1.00	1.25	2.63	3.12	9.00	2.9 ~ 11.5	2270	570 ~ 3380	3.96	A
1.6 + 1.6 + 2.0 + 4.2 + 6.0	15.4	0.94	0.94	1.17	2.45	3.50	9.00	2.9 ~ 11.5	2270	570 ~ 3380	3.96	A
1.6 + 1.6 + 2.0 + 4.2 + 7.1	16.5	0.87	0.87	1.09	2.29	3.88	9.00	2.9 ~ 11.5	2270	580 ~ 3390	3.96	A
1.6 + 1.6 + 2.0 + 5.0 + 5.0	15.2	0.95	0.95	1.18	2.96	2.96	9.00	2.9 ~ 11.5	2360	630 ~ 3330	3.81	A

5 Room

	Indoor unit capacity Cooling	Annual Energy Consumption (kWh)	Current 230V (A)	ERP				Moisture Removal Volume l/h
				Pdesign (kW)	SEER		Annual Consumption (kWh)	
					W/W	CLASS		
5 Room	1.6 + 1.6 + 1.6 + 1.6 + 1.6	985	9.4	8.00	8.50	A+++	329	1.0 + 1.0 + 1.0 + 1.0 + 1.0
	1.6 + 1.6 + 1.6 + 1.6 + 2.0	1040	10.0	8.40	8.50	A+++	346	1.0 + 1.0 + 1.0 + 1.0 + 1.3
	1.6 + 1.6 + 1.6 + 1.6 + 2.5	1150	11.0	9.00	8.50	A+++	371	1.0 + 1.0 + 1.0 + 1.0 + 1.5
	1.6 + 1.6 + 1.6 + 1.6 + 3.5	1150	11.0	9.00	8.50	A+++	371	0.9 + 0.9 + 0.9 + 0.9 + 1.8
	1.6 + 1.6 + 1.6 + 1.6 + 4.2	1150	11.0	9.00	8.50	A+++	371	0.9 + 0.9 + 0.9 + 0.9 + 2.1
	1.6 + 1.6 + 1.6 + 1.6 + 5.0	1130	10.8	9.00	8.50	A+++	371	0.8 + 0.8 + 0.8 + 0.8 + 2.3
	1.6 + 1.6 + 1.6 + 1.6 + 6.0	1130	10.8	9.00	8.50	A+++	371	0.7 + 0.7 + 0.7 + 0.7 + 2.4
	1.6 + 1.6 + 1.6 + 1.6 + 7.1	1130	10.8	9.00	8.50	A+++	371	0.7 + 0.7 + 0.7 + 0.7 + 2.5
	1.6 + 1.6 + 1.6 + 2.0 + 2.0	1120	10.7	8.80	8.50	A+++	362	1.0 + 1.0 + 1.0 + 1.3 + 1.3
	1.6 + 1.6 + 1.6 + 2.0 + 2.5	1150	11.0	9.00	8.50	A+++	371	1.0 + 1.0 + 1.0 + 1.3 + 1.5
	1.6 + 1.6 + 1.6 + 2.0 + 3.5	1150	11.0	9.00	8.50	A+++	371	0.9 + 0.9 + 0.9 + 1.1 + 1.7
	1.6 + 1.6 + 1.6 + 2.0 + 4.2	1150	11.0	9.00	8.50	A+++	371	0.8 + 0.8 + 0.8 + 1.0 + 2.0
	1.6 + 1.6 + 1.6 + 2.0 + 5.0	1130	10.8	9.00	8.50	A+++	371	0.8 + 0.8 + 0.8 + 1.0 + 2.2
	1.6 + 1.6 + 1.6 + 2.0 + 6.0	1130	10.8	9.00	8.50	A+++	371	0.7 + 0.7 + 0.7 + 0.9 + 2.4
	1.6 + 1.6 + 1.6 + 2.0 + 7.1	1135	10.9	9.00	8.50	A+++	371	0.7 + 0.7 + 0.7 + 0.8 + 2.5
	1.6 + 1.6 + 1.6 + 2.5 + 2.5	1150	11.0	8.99	8.50	A+++	370	0.9 + 0.9 + 0.9 + 1.5 + 1.5
	1.6 + 1.6 + 1.6 + 2.5 + 3.5	1150	11.0	9.00	8.50	A+++	371	0.8 + 0.8 + 0.8 + 1.3 + 1.7
	1.6 + 1.6 + 1.6 + 2.5 + 4.2	1150	11.0	9.00	8.50	A+++	371	0.8 + 0.8 + 0.8 + 1.3 + 1.9
	1.6 + 1.6 + 1.6 + 2.5 + 5.0	1130	10.8	9.00	8.50	A+++	371	0.7 + 0.7 + 0.7 + 1.2 + 2.1
	1.6 + 1.6 + 1.6 + 2.5 + 6.0	1130	10.8	9.00	8.50	A+++	371	0.7 + 0.7 + 0.7 + 1.1 + 2.3
	1.6 + 1.6 + 1.6 + 2.5 + 7.1	1135	10.9	9.00	8.50	A+++	371	0.7 + 0.7 + 0.7 + 1.0 + 2.5
	1.6 + 1.6 + 1.6 + 3.5 + 3.5	1155	11.1	9.00	8.50	A+++	371	0.8 + 0.8 + 0.8 + 1.6 + 1.6
	1.6 + 1.6 + 1.6 + 3.5 + 4.2	1155	11.1	9.00	8.50	A+++	371	0.7 + 0.7 + 0.7 + 1.5 + 1.7
	1.6 + 1.6 + 1.6 + 3.5 + 5.0	1135	10.9	9.00	8.50	A+++	371	0.7 + 0.7 + 0.7 + 1.5 + 1.9
	1.6 + 1.6 + 1.6 + 3.5 + 6.0	1135	10.9	9.00	8.50	A+++	371	0.7 + 0.7 + 0.7 + 1.4 + 2.2
	1.6 + 1.6 + 1.6 + 3.5 + 7.1	1135	10.9	9.00	8.50	A+++	371	0.7 + 0.7 + 0.7 + 1.3 + 2.3
	1.6 + 1.6 + 1.6 + 4.2 + 4.2	1155	11.1	8.99	8.50	A+++	370	0.7 + 0.7 + 0.7 + 1.7 + 1.7
	1.6 + 1.6 + 1.6 + 4.2 + 5.0	1135	10.9	9.00	8.50	A+++	371	0.7 + 0.7 + 0.7 + 1.6 + 1.8
	1.6 + 1.6 + 1.6 + 4.2 + 6.0	1135	10.9	9.00	8.50	A+++	371	0.7 + 0.7 + 0.7 + 1.5 + 2.1
	1.6 + 1.6 + 1.6 + 4.2 + 7.1	1135	10.9	9.00	8.50	A+++	371	0.7 + 0.7 + 0.7 + 1.5 + 2.3
	1.6 + 1.6 + 1.6 + 5.0 + 5.0	1145	11.0	9.00	8.50	A+++	371	0.7 + 0.7 + 0.7 + 1.7 + 1.7
	1.6 + 1.6 + 1.6 + 5.0 + 6.0	1145	11.0	9.00	8.50	A+++	371	0.7 + 0.7 + 0.7 + 1.7 + 2.0
	1.6 + 1.6 + 1.6 + 5.0 + 7.1	1180	11.3	9.00	8.50	A+++	371	0.7 + 0.7 + 0.7 + 1.6 + 2.2
	1.6 + 1.6 + 1.6 + 6.0 + 6.0	1145	11.0	9.00	8.50	A+++	371	0.7 + 0.7 + 0.7 + 1.8 + 1.8
	1.6 + 1.6 + 1.6 + 6.0 + 7.1	1180	11.3	9.00	8.50	A+++	371	0.7 + 0.7 + 0.7 + 1.7 + 2.1
	1.6 + 1.6 + 2.0 + 2.0 + 2.0	1150	11.0	9.00	8.50	A+++	371	1.0 + 1.0 + 1.3 + 1.3 + 1.3
	1.6 + 1.6 + 2.0 + 2.0 + 2.5	1150	11.0	9.00	8.50	A+++	371	0.9 + 0.9 + 1.2 + 1.2 + 1.5
	1.6 + 1.6 + 2.0 + 2.0 + 3.5	1150	11.0	9.00	8.50	A+++	371	0.9 + 0.9 + 1.1 + 1.1 + 1.7
	1.6 + 1.6 + 2.0 + 2.0 + 4.2	1150	11.0	9.00	8.50	A+++	371	0.8 + 0.8 + 1.0 + 1.0 + 1.9
	1.6 + 1.6 + 2.0 + 2.0 + 5.0	1130	10.8	9.00	8.50	A+++	371	0.7 + 0.7 + 0.9 + 0.9 + 2.1
1.6 + 1.6 + 2.0 + 2.0 + 6.0	1130	10.8	9.00	8.50	A+++	371	0.7 + 0.7 + 0.9 + 0.9 + 2.3	
1.6 + 1.6 + 2.0 + 2.0 + 7.1	1135	10.9	9.00	8.50	A+++	371	0.7 + 0.7 + 0.8 + 0.8 + 2.5	
1.6 + 1.6 + 2.0 + 2.5 + 2.5	1150	11.0	9.00	8.50	A+++	371	0.9 + 0.9 + 1.1 + 1.4 + 1.4	
1.6 + 1.6 + 2.0 + 2.5 + 3.5	1150	11.0	9.00	8.50	A+++	371	0.8 + 0.8 + 1.0 + 1.3 + 1.6	
1.6 + 1.6 + 2.0 + 2.5 + 4.2	1150	11.0	9.00	8.50	A+++	371	0.8 + 0.8 + 1.0 + 1.2 + 1.8	
1.6 + 1.6 + 2.0 + 2.5 + 5.0	1130	10.8	9.00	8.50	A+++	371	0.7 + 0.7 + 0.9 + 1.1 + 2.1	
1.6 + 1.6 + 2.0 + 2.5 + 6.0	1130	10.8	9.00	8.50	A+++	371	0.7 + 0.7 + 0.8 + 1.0 + 2.3	
1.6 + 1.6 + 2.0 + 2.5 + 7.1	1135	10.9	9.00	8.50	A+++	371	0.7 + 0.7 + 0.8 + 1.0 + 2.4	
1.6 + 1.6 + 2.0 + 3.5 + 3.5	1155	11.1	9.00	8.50	A+++	371	0.7 + 0.7 + 0.9 + 1.6 + 1.6	
1.6 + 1.6 + 2.0 + 3.5 + 4.2	1155	11.1	9.00	8.50	A+++	371	0.7 + 0.7 + 0.9 + 1.5 + 1.7	
1.6 + 1.6 + 2.0 + 3.5 + 5.0	1135	10.9	9.00	8.50	A+++	371	0.7 + 0.7 + 0.8 + 1.5 + 1.9	
1.6 + 1.6 + 2.0 + 3.5 + 6.0	1135	10.9	9.00	8.50	A+++	371	0.7 + 0.7 + 0.8 + 1.4 + 2.1	
1.6 + 1.6 + 2.0 + 3.5 + 7.1	1135	10.9	9.00	8.50	A+++	371	0.7 + 0.7 + 0.7 + 1.3 + 2.3	
1.6 + 1.6 + 2.0 + 4.2 + 4.2	1155	11.1	9.00	8.50	A+++	371	0.7 + 0.7 + 0.8 + 1.6 + 1.6	
1.6 + 1.6 + 2.0 + 4.2 + 5.0	1135	10.9	9.00	8.50	A+++	371	0.7 + 0.7 + 0.8 + 1.6 + 1.8	
1.6 + 1.6 + 2.0 + 4.2 + 6.0	1135	10.9	9.00	8.50	A+++	371	0.7 + 0.7 + 0.7 + 1.5 + 2.0	
1.6 + 1.6 + 2.0 + 4.2 + 7.1	1135	10.9	9.00	8.50	A+++	371	0.7 + 0.7 + 0.7 + 1.5 + 2.3	
1.6 + 1.6 + 2.0 + 5.0 + 5.0	1180	11.3	9.00	8.50	A+++	371	0.7 + 0.7 + 0.7 + 1.7 + 1.7	

Indoor unit capacity Cooling	Total	Cooling Capacity (kW)							Input Power (W)		EER	
		Room A	Room B	Room C	Room D	Room E	Total	min ~ max	Rating	min ~ max	WW	CLASS
1.6 + 1.6 + 2.0 + 5.0 + 6.0	16.2	0.89	0.89	1.11	2.78	3.33	9.00	2.9 ~ 11.5	2360	630 ~ 3330	3.81	A
1.6 + 1.6 + 2.0 + 5.0 + 7.1	17.3	0.83	0.83	1.04	2.60	3.70	9.00	2.9 ~ 11.5	2370	660 ~ 3340	3.80	A
1.6 + 1.6 + 2.0 + 6.0 + 6.0	17.2	0.84	0.84	1.04	3.14	3.14	9.00	2.9 ~ 11.5	2360	630 ~ 3330	3.81	A
1.6 + 1.6 + 2.0 + 6.0 + 7.1	18.3	0.79	0.79	0.98	2.95	3.49	9.00	2.9 ~ 11.5	2370	660 ~ 3340	3.80	A
1.6 + 1.6 + 2.5 + 2.5 + 2.5	10.7	1.35	1.35	2.10	2.10	2.10	9.00	2.9 ~ 11.5	2300	450 ~ 3590	3.91	A
1.6 + 1.6 + 2.5 + 2.5 + 3.5	11.7	1.23	1.23	1.92	1.92	2.70	9.00	2.9 ~ 11.5	2300	480 ~ 3590	3.91	A
1.6 + 1.6 + 2.5 + 2.5 + 4.2	12.4	1.16	1.16	1.81	1.81	3.06	9.00	2.9 ~ 11.5	2300	480 ~ 3510	3.91	A
1.6 + 1.6 + 2.5 + 2.5 + 5.0	13.2	1.09	1.09	1.70	1.70	3.42	9.00	2.9 ~ 11.5	2260	530 ~ 3380	3.98	A
1.6 + 1.6 + 2.5 + 2.5 + 6.0	14.2	1.01	1.01	1.58	1.58	3.82	9.00	2.9 ~ 11.5	2260	530 ~ 3380	3.98	A
1.6 + 1.6 + 2.5 + 2.5 + 7.1	15.3	0.94	0.94	1.47	1.47	4.18	9.00	2.9 ~ 11.5	2270	570 ~ 3380	3.96	A
1.6 + 1.6 + 2.5 + 3.5 + 3.5	12.7	1.13	1.13	1.78	2.48	2.48	9.00	2.9 ~ 11.5	2310	490 ~ 3510	3.90	A
1.6 + 1.6 + 2.5 + 3.5 + 4.2	13.4	1.07	1.07	1.68	2.35	2.83	9.00	2.9 ~ 11.5	2310	490 ~ 3510	3.90	A
1.6 + 1.6 + 2.5 + 3.5 + 5.0	14.2	1.01	1.01	1.58	2.22	3.18	9.00	2.9 ~ 11.5	2270	540 ~ 3380	3.96	A
1.6 + 1.6 + 2.5 + 3.5 + 6.0	15.2	0.95	0.95	1.48	2.07	3.55	9.00	2.9 ~ 11.5	2270	540 ~ 3380	3.96	A
1.6 + 1.6 + 2.5 + 3.5 + 7.1	16.3	0.88	0.88	1.38	1.93	3.93	9.00	2.9 ~ 11.5	2270	570 ~ 3390	3.96	A
1.6 + 1.6 + 2.5 + 4.2 + 4.2	14.1	1.02	1.02	1.60	2.68	2.68	9.00	2.9 ~ 11.5	2310	490 ~ 3520	3.90	A
1.6 + 1.6 + 2.5 + 4.2 + 5.0	14.9	0.97	0.97	1.51	2.54	3.01	9.00	2.9 ~ 11.5	2270	570 ~ 3380	3.96	A
1.6 + 1.6 + 2.5 + 4.2 + 6.0	15.9	0.91	0.91	1.42	2.38	3.38	9.00	2.9 ~ 11.5	2270	570 ~ 3380	3.96	A
1.6 + 1.6 + 2.5 + 4.2 + 7.1	17.0	0.85	0.85	1.32	2.22	3.76	9.00	2.9 ~ 11.5	2270	580 ~ 3390	3.96	A
1.6 + 1.6 + 2.5 + 5.0 + 5.0	15.7	0.92	0.92	1.42	2.87	2.87	9.00	2.9 ~ 11.5	2360	630 ~ 3330	3.81	A
1.6 + 1.6 + 2.5 + 5.0 + 6.0	16.7	0.86	0.86	1.35	2.69	3.24	9.00	2.9 ~ 11.5	2360	630 ~ 3330	3.81	A
1.6 + 1.6 + 2.5 + 5.0 + 7.1	17.8	0.81	0.81	1.26	2.53	3.59	9.00	2.9 ~ 11.5	2370	660 ~ 3340	3.80	A
1.6 + 1.6 + 2.5 + 6.0 + 6.0	17.7	0.81	0.81	1.28	3.05	3.05	9.00	2.9 ~ 11.5	2360	630 ~ 3330	3.81	A
1.6 + 1.6 + 3.5 + 3.5 + 3.5	13.7	1.05	1.05	2.30	2.30	2.30	9.00	2.9 ~ 11.5	2310	490 ~ 3520	3.90	A
1.6 + 1.6 + 3.5 + 3.5 + 4.2	14.4	1.00	1.00	2.19	2.19	2.62	9.00	2.9 ~ 11.5	2310	490 ~ 3520	3.90	A
1.6 + 1.6 + 3.5 + 3.5 + 5.0	15.2	0.95	0.95	2.07	2.07	2.96	9.00	2.9 ~ 11.5	2270	570 ~ 3380	3.96	A
1.6 + 1.6 + 3.5 + 3.5 + 6.0	16.2	0.89	0.89	1.94	1.94	3.34	9.00	2.9 ~ 11.5	2270	570 ~ 3380	3.96	A
1.6 + 1.6 + 3.5 + 3.5 + 7.1	17.3	0.83	0.83	1.82	1.82	3.70	9.00	2.9 ~ 11.5	2280	580 ~ 3390	3.95	A
1.6 + 1.6 + 3.5 + 4.2 + 4.2	15.1	0.95	0.95	2.10	2.50	2.50	9.00	2.9 ~ 11.5	2310	490 ~ 3440	3.90	A
1.6 + 1.6 + 3.5 + 4.2 + 5.0	15.9	0.91	0.91	1.98	2.38	2.82	9.00	2.9 ~ 11.5	2270	570 ~ 3390	3.96	A
1.6 + 1.6 + 3.5 + 4.2 + 6.0	16.9	0.85	0.85	1.86	2.24	3.20	9.00	2.9 ~ 11.5	2270	570 ~ 3390	3.96	A
1.6 + 1.6 + 3.5 + 4.2 + 7.1	18.0	0.80	0.80	1.75	2.10	3.55	9.00	2.9 ~ 11.5	2280	580 ~ 3390	3.95	A
1.6 + 1.6 + 3.5 + 5.0 + 5.0	16.7	0.86	0.86	1.90	2.69	2.69	9.00	2.9 ~ 11.5	2360	660 ~ 3340	3.81	A
1.6 + 1.6 + 3.5 + 5.0 + 6.0	17.7	0.81	0.81	1.78	2.54	3.06	9.00	2.9 ~ 11.5	2360	660 ~ 3340	3.81	A
1.6 + 1.6 + 4.2 + 4.2 + 4.2	15.8	0.91	0.91	2.39	2.39	2.39	8.99	2.9 ~ 11.5	2250	490 ~ 3440	4.00	A
1.6 + 1.6 + 4.2 + 4.2 + 5.0	16.6	0.87	0.87	2.28	2.28	2.70	9.00	2.9 ~ 11.5	2270	570 ~ 3390	3.96	A
1.6 + 1.6 + 4.2 + 4.2 + 6.0	17.6	0.82	0.82	2.15	2.15	3.06	9.00	2.9 ~ 11.5	2270	570 ~ 3390	3.96	A
1.6 + 1.6 + 4.2 + 5.0 + 5.0	17.4	0.83	0.83	2.16	2.59	2.59	9.00	2.9 ~ 11.5	2370	660 ~ 3340	3.80	A
1.6 + 1.6 + 5.0 + 5.0 + 5.0	18.2	0.79	0.79	2.47	2.47	2.47	8.99	2.9 ~ 11.5	2400	760 ~ 3370	3.75	A
1.6 + 2.0 + 2.0 + 2.0 + 2.0	9.6	1.48	1.88	1.88	1.88	1.88	9.00	2.9 ~ 11.5	2300	450 ~ 3590	3.91	A
1.6 + 2.0 + 2.0 + 2.0 + 2.5	10.1	1.43	1.78	1.78	1.78	2.23	9.00	2.9 ~ 11.5	2300	450 ~ 3590	3.91	A
1.6 + 2.0 + 2.0 + 2.0 + 3.5	11.1	1.30	1.62	1.62	1.62	2.84	9.00	2.9 ~ 11.5	2300	480 ~ 3510	3.91	A
1.6 + 2.0 + 2.0 + 2.0 + 4.2	11.8	1.22	1.53	1.53	1.53	3.19	9.00	2.9 ~ 11.5	2310	480 ~ 3510	3.90	A
1.6 + 2.0 + 2.0 + 2.0 + 5.0	12.6	1.14	1.43	1.43	1.43	3.57	9.00	2.9 ~ 11.5	2260	540 ~ 3380	3.98	A
1.6 + 2.0 + 2.0 + 2.0 + 6.0	13.6	1.06	1.32	1.32	1.32	3.98	9.00	2.9 ~ 11.5	2260	540 ~ 3380	3.98	A
1.6 + 2.0 + 2.0 + 2.0 + 7.1	14.7	0.98	1.22	1.22	1.22	4.36	9.00	2.9 ~ 11.5	2270	570 ~ 3380	3.96	A
1.6 + 2.0 + 2.0 + 2.5 + 2.5	10.6	1.36	1.70	1.70	2.12	2.12	9.00	2.9 ~ 11.5	2300	450 ~ 3590	3.91	A
1.6 + 2.0 + 2.0 + 2.5 + 3.5	11.6	1.24	1.55	1.55	1.94	2.72	9.00	2.9 ~ 11.5	2300	480 ~ 3510	3.91	A
1.6 + 2.0 + 2.0 + 2.5 + 4.2	12.3	1.17	1.46	1.46	1.83	3.08	9.00	2.9 ~ 11.5	2310	480 ~ 3510	3.90	A
1.6 + 2.0 + 2.0 + 2.5 + 5.0	13.1	1.10	1.37	1.37	1.72	3.44	9.00	2.9 ~ 11.5	2260	540 ~ 3380	3.98	A
1.6 + 2.0 + 2.0 + 2.5 + 6.0	14.1	1.02	1.28	1.28	1.60	3.82	9.00	2.9 ~ 11.5	2260	540 ~ 3380	3.98	A
1.6 + 2.0 + 2.0 + 2.5 + 7.1	15.2	0.95	1.18	1.18	1.48	4.21	9.00	2.9 ~ 11.5	2270	570 ~ 3380	3.96	A
1.6 + 2.0 + 2.0 + 3.5 + 3.5	12.6	1.14	1.43	1.43	2.50	2.50	9.00	2.9 ~ 11.5	2310	490 ~ 3510	3.90	A
1.6 + 2.0 + 2.0 + 3.5 + 4.2	13.3	1.08	1.35	1.35	2.37	2.85	9.00	2.9 ~ 11.5	2310	490 ~ 3520	3.90	A
1.6 + 2.0 + 2.0 + 3.5 + 5.0	14.1	1.02	1.28	1.28	2.23	3.19	9.00	2.9 ~ 11.5	2270	570 ~ 3380	3.96	A
1.6 + 2.0 + 2.0 + 3.5 + 6.0	15.1	0.95	1.19	1.19	2.09	3.58	9.00	2.9 ~ 11.5	2270	570 ~ 3380	3.96	A
1.6 + 2.0 + 2.0 + 3.5 + 7.1	16.2	0.89	1.11	1.11	1.94	3.95	9.00	2.9 ~ 11.5	2280	580 ~ 3390	3.95	A
1.6 + 2.0 + 2.0 + 4.2 + 4.2	14.0	1.02	1.29	1.29	2.70	2.70	9.00	2.9 ~ 11.5	2310	490 ~ 3520	3.90	A

5 Room

	Indoor unit capacity Cooling	Annual Energy Consumption (kWh)	Current 230V (A)	ERP			Moisture Removal Volume l/h	
				Pdesign (kW)	SEER			Annual Consumption (kWh)
					W/W	CLASS		
5 Room	1.6 + 1.6 + 2.0 + 5.0 + 6.0	1180	11.3	9.00	8.50	A+++	371	0.7 + 0.7 + 0.7 + 1.6 + 1.9
	1.6 + 1.6 + 2.0 + 5.0 + 7.1	1185	11.3	9.00	8.50	A+++	371	0.7 + 0.7 + 0.7 + 1.6 + 2.2
	1.6 + 1.6 + 2.0 + 6.0 + 6.0	1180	11.3	9.00	8.50	A+++	371	0.7 + 0.7 + 0.7 + 1.8 + 1.8
	1.6 + 1.6 + 2.0 + 6.0 + 7.1	1185	11.3	9.00	8.50	A+++	371	0.7 + 0.7 + 0.7 + 1.7 + 2.0
	1.6 + 1.6 + 2.5 + 2.5 + 2.5	1150	11.0	9.00	8.50	A+++	371	0.9 + 0.9 + 1.4 + 1.4 + 1.4
	1.6 + 1.6 + 2.5 + 2.5 + 3.5	1150	11.0	9.00	8.50	A+++	371	0.8 + 0.8 + 1.2 + 1.2 + 1.6
	1.6 + 1.6 + 2.5 + 2.5 + 4.2	1150	11.0	9.00	8.50	A+++	371	0.7 + 0.7 + 1.2 + 1.2 + 1.7
	1.6 + 1.6 + 2.5 + 2.5 + 5.0	1130	10.8	9.00	8.50	A+++	371	0.7 + 0.7 + 1.1 + 1.1 + 2.0
	1.6 + 1.6 + 2.5 + 2.5 + 6.0	1130	10.8	9.00	8.50	A+++	371	0.7 + 0.7 + 1.0 + 1.0 + 2.2
	1.6 + 1.6 + 2.5 + 2.5 + 7.1	1135	10.9	9.00	8.50	A+++	371	0.7 + 0.7 + 0.9 + 0.9 + 2.4
	1.6 + 1.6 + 2.5 + 3.5 + 3.5	1155	11.1	9.00	8.50	A+++	371	0.7 + 0.7 + 1.1 + 1.5 + 1.5
	1.6 + 1.6 + 2.5 + 3.5 + 4.2	1155	11.1	9.00	8.50	A+++	371	0.7 + 0.7 + 1.1 + 1.5 + 1.7
	1.6 + 1.6 + 2.5 + 3.5 + 5.0	1135	10.9	9.00	8.50	A+++	371	0.7 + 0.7 + 1.0 + 1.4 + 1.8
	1.6 + 1.6 + 2.5 + 3.5 + 6.0	1135	10.9	9.00	8.50	A+++	371	0.7 + 0.7 + 0.9 + 1.3 + 2.1
	1.6 + 1.6 + 2.5 + 3.5 + 7.1	1135	10.9	9.00	8.50	A+++	371	0.7 + 0.7 + 0.9 + 1.2 + 2.3
	1.6 + 1.6 + 2.5 + 4.2 + 4.2	1155	11.1	9.00	8.50	A+++	371	0.7 + 0.7 + 1.0 + 1.6 + 1.6
	1.6 + 1.6 + 2.5 + 4.2 + 5.0	1135	10.9	9.00	8.50	A+++	371	0.7 + 0.7 + 1.0 + 1.6 + 1.7
	1.6 + 1.6 + 2.5 + 4.2 + 6.0	1135	10.9	9.00	8.50	A+++	371	0.7 + 0.7 + 0.9 + 1.5 + 1.9
	1.6 + 1.6 + 2.5 + 4.2 + 7.1	1135	10.9	9.00	8.50	A+++	371	0.7 + 0.7 + 0.8 + 1.4 + 2.2
	1.6 + 1.6 + 2.5 + 5.0 + 5.0	1180	11.3	9.00	8.50	A+++	371	0.7 + 0.7 + 0.9 + 1.7 + 1.7
	1.6 + 1.6 + 2.5 + 5.0 + 6.0	1180	11.3	9.00	8.50	A+++	371	0.7 + 0.7 + 0.9 + 1.6 + 1.8
	1.6 + 1.6 + 2.5 + 5.0 + 7.1	1185	11.3	9.00	8.50	A+++	371	0.7 + 0.7 + 0.8 + 1.6 + 2.1
	1.6 + 1.6 + 2.5 + 6.0 + 6.0	1180	11.3	9.00	8.50	A+++	371	0.7 + 0.7 + 0.8 + 1.7 + 1.7
	1.6 + 1.6 + 3.5 + 3.5 + 3.5	1155	11.1	9.00	8.50	A+++	371	0.7 + 0.7 + 1.5 + 1.5 + 1.5
	1.6 + 1.6 + 3.5 + 3.5 + 4.2	1155	11.1	9.00	8.50	A+++	371	0.7 + 0.7 + 1.4 + 1.4 + 1.6
	1.6 + 1.6 + 3.5 + 3.5 + 5.0	1135	10.9	9.00	8.50	A+++	371	0.7 + 0.7 + 1.3 + 1.3 + 1.7
	1.6 + 1.6 + 3.5 + 3.5 + 6.0	1135	10.9	9.00	8.50	A+++	371	0.7 + 0.7 + 1.3 + 1.3 + 1.9
	1.6 + 1.6 + 3.5 + 3.5 + 7.1	1140	10.9	9.00	8.50	A+++	371	0.7 + 0.7 + 1.2 + 1.2 + 2.2
	1.6 + 1.6 + 3.5 + 4.2 + 4.2	1155	11.1	9.00	8.50	A+++	371	0.7 + 0.7 + 1.4 + 1.5 + 1.5
	1.6 + 1.6 + 3.5 + 4.2 + 5.0	1135	10.9	9.00	8.50	A+++	371	0.7 + 0.7 + 1.3 + 1.5 + 1.7
	1.6 + 1.6 + 3.5 + 4.2 + 6.0	1135	10.9	9.00	8.50	A+++	371	0.7 + 0.7 + 1.2 + 1.5 + 1.8
	1.6 + 1.6 + 3.5 + 4.2 + 7.1	1140	10.9	9.00	8.50	A+++	371	0.7 + 0.7 + 1.1 + 1.4 + 2.1
	1.6 + 1.6 + 3.5 + 5.0 + 5.0	1180	11.3	9.00	8.50	A+++	371	0.7 + 0.7 + 1.2 + 1.6 + 1.6
	1.6 + 1.6 + 3.5 + 5.0 + 6.0	1180	11.3	9.00	8.50	A+++	371	0.7 + 0.7 + 1.1 + 1.6 + 1.7
	1.6 + 1.6 + 4.2 + 4.2 + 4.2	1125	10.8	8.99	8.50	A+++	370	0.7 + 0.7 + 1.5 + 1.5 + 1.5
	1.6 + 1.6 + 4.2 + 4.2 + 5.0	1135	10.9	9.00	8.50	A+++	371	0.7 + 0.7 + 1.5 + 1.5 + 1.6
	1.6 + 1.6 + 4.2 + 4.2 + 6.0	1135	10.9	9.00	8.50	A+++	371	0.7 + 0.7 + 1.4 + 1.4 + 1.7
	1.6 + 1.6 + 4.2 + 5.0 + 5.0	1185	11.3	9.00	8.50	A+++	371	0.7 + 0.7 + 1.4 + 1.6 + 1.6
	1.6 + 1.6 + 5.0 + 5.0 + 5.0	1200	11.5	8.99	8.50	A+++	370	0.7 + 0.7 + 1.5 + 1.5 + 1.5
	1.6 + 2.0 + 2.0 + 2.0 + 2.0	1150	11.0	9.00	8.50	A+++	371	0.9 + 1.2 + 1.2 + 1.2 + 1.2
1.6 + 2.0 + 2.0 + 2.0 + 2.5	1150	11.0	9.00	8.50	A+++	371	0.9 + 1.1 + 1.1 + 1.1 + 1.5	
1.6 + 2.0 + 2.0 + 2.0 + 3.5	1150	11.0	9.00	8.50	A+++	371	0.8 + 1.0 + 1.0 + 1.0 + 1.7	
1.6 + 2.0 + 2.0 + 2.0 + 4.2	1155	11.1	9.00	8.50	A+++	371	0.8 + 1.0 + 1.0 + 1.0 + 1.8	
1.6 + 2.0 + 2.0 + 2.0 + 5.0	1130	10.8	9.00	8.50	A+++	371	0.7 + 0.9 + 0.9 + 0.9 + 2.1	
1.6 + 2.0 + 2.0 + 2.0 + 6.0	1130	10.8	9.00	8.50	A+++	371	0.7 + 0.8 + 0.8 + 0.8 + 2.3	
1.6 + 2.0 + 2.0 + 2.0 + 7.1	1135	10.9	9.00	8.50	A+++	371	0.7 + 0.8 + 0.8 + 0.8 + 2.4	
1.6 + 2.0 + 2.0 + 2.5 + 2.5	1150	11.0	9.00	8.50	A+++	371	0.9 + 1.1 + 1.1 + 1.4 + 1.4	
1.6 + 2.0 + 2.0 + 2.5 + 3.5	1150	11.0	9.00	8.50	A+++	371	0.8 + 1.0 + 1.0 + 1.3 + 1.6	
1.6 + 2.0 + 2.0 + 2.5 + 4.2	1155	11.1	9.00	8.50	A+++	371	0.7 + 0.9 + 0.9 + 1.2 + 1.7	
1.6 + 2.0 + 2.0 + 2.5 + 5.0	1130	10.8	9.00	8.50	A+++	371	0.7 + 0.9 + 0.9 + 1.1 + 2.0	
1.6 + 2.0 + 2.0 + 2.5 + 6.0	1130	10.8	9.00	8.50	A+++	371	0.7 + 0.8 + 0.8 + 1.0 + 2.2	
1.6 + 2.0 + 2.0 + 2.5 + 7.1	1135	10.9	9.00	8.50	A+++	371	0.7 + 0.7 + 0.7 + 0.9 + 2.4	
1.6 + 2.0 + 2.0 + 3.5 + 3.5	1155	11.1	9.00	8.50	A+++	371	0.7 + 0.9 + 0.9 + 1.5 + 1.5	
1.6 + 2.0 + 2.0 + 3.5 + 4.2	1155	11.1	9.00	8.50	A+++	371	0.7 + 0.9 + 0.9 + 1.5 + 1.7	
1.6 + 2.0 + 2.0 + 3.5 + 5.0	1135	10.9	9.00	8.50	A+++	371	0.7 + 0.8 + 0.8 + 1.5 + 1.8	
1.6 + 2.0 + 2.0 + 3.5 + 6.0	1135	10.9	9.00	8.50	A+++	371	0.7 + 0.7 + 0.7 + 1.4 + 2.1	
1.6 + 2.0 + 2.0 + 3.5 + 7.1	1140	10.9	9.00	8.50	A+++	371	0.7 + 0.7 + 0.7 + 1.3 + 2.3	
1.6 + 2.0 + 2.0 + 4.2 + 4.2	1155	11.1	9.00	8.50	A+++	371	0.7 + 0.8 + 0.8 + 1.6 + 1.6	

	Indoor unit capacity Cooling	Total	Cooling Capacity (kW)						Input Power (W)		EER		
			Room A	Room B	Room C	Room D	Room E	Total	min ~ max	Rating	min ~ max	WW	CLASS
5 Room	1.6 + 2.0 + 2.0 + 4.2 + 5.0	14.8	0.97	1.22	1.22	2.55	3.04	9.00	2.9 ~ 11.5	2270	570 ~ 3380	3.96	A
	1.6 + 2.0 + 2.0 + 4.2 + 6.0	15.8	0.91	1.14	1.14	2.39	3.42	9.00	2.9 ~ 11.5	2270	570 ~ 3380	3.96	A
	1.6 + 2.0 + 2.0 + 4.2 + 7.1	16.9	0.85	1.07	1.07	2.24	3.77	9.00	2.9 ~ 11.5	2280	580 ~ 3390	3.95	A
	1.6 + 2.0 + 2.0 + 5.0 + 5.0	15.6	0.94	1.15	1.15	2.88	2.88	9.00	2.9 ~ 11.5	2360	630 ~ 3330	3.81	A
	1.6 + 2.0 + 2.0 + 5.0 + 6.0	16.6	0.87	1.08	1.08	2.71	3.26	9.00	2.9 ~ 11.5	2360	630 ~ 3330	3.81	A
	1.6 + 2.0 + 2.0 + 5.0 + 7.1	17.7	0.81	1.02	1.02	2.54	3.61	9.00	2.9 ~ 11.5	2370	670 ~ 3340	3.80	A
	1.6 + 2.0 + 2.0 + 6.0 + 6.0	17.6	0.82	1.02	1.02	3.07	3.07	9.00	2.9 ~ 11.5	2360	630 ~ 3330	3.81	A
	1.6 + 2.0 + 2.5 + 2.5 + 2.5	11.1	1.29	1.62	2.03	2.03	2.03	9.00	2.9 ~ 11.5	2300	450 ~ 3590	3.91	A
	1.6 + 2.0 + 2.5 + 2.5 + 3.5	12.1	1.19	1.49	1.86	1.86	2.60	9.00	2.9 ~ 11.5	2300	480 ~ 3510	3.91	A
	1.6 + 2.0 + 2.5 + 2.5 + 4.2	12.8	1.13	1.41	1.76	1.76	2.94	9.00	2.9 ~ 11.5	2310	480 ~ 3510	3.90	A
	1.6 + 2.0 + 2.5 + 2.5 + 5.0	13.6	1.06	1.32	1.65	1.65	3.32	9.00	2.9 ~ 11.5	2260	540 ~ 3380	3.98	A
	1.6 + 2.0 + 2.5 + 2.5 + 6.0	14.6	0.99	1.23	1.54	1.54	3.70	9.00	2.9 ~ 11.5	2260	540 ~ 3380	3.98	A
	1.6 + 2.0 + 2.5 + 2.5 + 7.1	15.7	0.92	1.15	1.43	1.43	4.07	9.00	2.9 ~ 11.5	2270	570 ~ 3380	3.96	A
	1.6 + 2.0 + 2.5 + 3.5 + 3.5	13.1	1.10	1.37	1.73	2.40	2.40	9.00	2.9 ~ 11.5	2310	490 ~ 3510	3.90	A
	1.6 + 2.0 + 2.5 + 3.5 + 4.2	13.8	1.04	1.30	1.63	2.28	2.75	9.00	2.9 ~ 11.5	2310	490 ~ 3520	3.90	A
	1.6 + 2.0 + 2.5 + 3.5 + 5.0	14.6	0.99	1.23	1.54	2.16	3.08	9.00	2.9 ~ 11.5	2270	570 ~ 3380	3.96	A
	1.6 + 2.0 + 2.5 + 3.5 + 6.0	15.6	0.92	1.15	1.44	2.02	3.47	9.00	2.9 ~ 11.5	2270	570 ~ 3380	3.96	A
	1.6 + 2.0 + 2.5 + 3.5 + 7.1	16.7	0.86	1.08	1.35	1.89	3.82	9.00	2.9 ~ 11.5	2280	580 ~ 3390	3.95	A
	1.6 + 2.0 + 2.5 + 4.2 + 4.2	14.5	0.99	1.24	1.55	2.61	2.61	9.00	2.9 ~ 11.5	2310	490 ~ 3520	3.90	A
	1.6 + 2.0 + 2.5 + 4.2 + 5.0	15.3	0.94	1.18	1.47	2.47	2.94	9.00	2.9 ~ 11.5	2270	570 ~ 3380	3.96	A
	1.6 + 2.0 + 2.5 + 4.2 + 6.0	16.3	0.88	1.10	1.38	2.32	3.32	9.00	2.9 ~ 11.5	2270	570 ~ 3380	3.96	A
	1.6 + 2.0 + 2.5 + 4.2 + 7.1	17.4	0.83	1.03	1.29	2.17	3.68	9.00	2.9 ~ 11.5	2280	580 ~ 3390	3.95	A
	1.6 + 2.0 + 2.5 + 5.0 + 5.0	16.1	0.89	1.12	1.39	2.80	2.80	9.00	2.9 ~ 11.5	2360	630 ~ 3330	3.81	A
	1.6 + 2.0 + 2.5 + 5.0 + 6.0	17.1	0.84	1.05	1.32	2.63	3.16	9.00	2.9 ~ 11.5	2360	630 ~ 3330	3.81	A
	1.6 + 2.0 + 2.5 + 5.0 + 7.1	18.2	0.79	0.99	1.24	2.47	3.51	9.00	2.9 ~ 11.5	2370	670 ~ 3340	3.80	A
	1.6 + 2.0 + 2.5 + 6.0 + 6.0	18.1	0.80	0.99	1.25	2.98	2.98	9.00	2.9 ~ 11.5	2360	630 ~ 3330	3.81	A
	1.6 + 2.0 + 3.5 + 3.5 + 3.5	14.1	1.02	1.29	2.23	2.23	2.23	9.00	2.9 ~ 11.5	2310	490 ~ 3440	3.90	A
	1.6 + 2.0 + 3.5 + 3.5 + 4.2	14.8	0.97	1.22	2.13	2.13	2.55	9.00	2.9 ~ 11.5	2250	490 ~ 3440	4.00	A
	1.6 + 2.0 + 3.5 + 3.5 + 5.0	15.6	0.92	1.15	2.02	2.02	2.89	9.00	2.9 ~ 11.5	2270	570 ~ 3390	3.96	A
	1.6 + 2.0 + 3.5 + 3.5 + 6.0	16.6	0.87	1.08	1.90	1.90	3.25	9.00	2.9 ~ 11.5	2270	570 ~ 3390	3.96	A
	1.6 + 2.0 + 3.5 + 3.5 + 7.1	17.7	0.81	1.02	1.78	1.78	3.61	9.00	2.9 ~ 11.5	2280	580 ~ 3390	3.95	A
	1.6 + 2.0 + 3.5 + 4.2 + 4.2	15.5	0.93	1.16	2.03	2.44	2.44	9.00	2.9 ~ 11.5	2250	490 ~ 3440	4.00	A
	1.6 + 2.0 + 3.5 + 4.2 + 5.0	16.3	0.88	1.10	1.93	2.32	2.77	9.00	2.9 ~ 11.5	2280	580 ~ 3390	3.95	A
	1.6 + 2.0 + 3.5 + 4.2 + 6.0	17.3	0.83	1.04	1.82	2.18	3.13	9.00	2.9 ~ 11.5	2280	580 ~ 3390	3.95	A
	1.6 + 2.0 + 3.5 + 5.0 + 5.0	17.1	0.84	1.05	1.85	2.63	2.63	9.00	2.9 ~ 11.5	2370	660 ~ 3340	3.80	A
	1.6 + 2.0 + 3.5 + 5.0 + 6.0	18.1	0.80	0.99	1.74	2.49	2.98	9.00	2.9 ~ 11.5	2370	660 ~ 3340	3.80	A
	1.6 + 2.0 + 4.2 + 4.2 + 4.2	16.2	0.89	1.12	2.33	2.33	2.33	9.00	2.9 ~ 11.5	2250	520 ~ 3440	4.00	A
	1.6 + 2.0 + 4.2 + 4.2 + 5.0	17.0	0.85	1.06	2.22	2.22	2.65	9.00	2.9 ~ 11.5	2280	580 ~ 3390	3.95	A
	1.6 + 2.0 + 4.2 + 4.2 + 6.0	18.0	0.80	1.00	2.10	2.10	3.00	9.00	2.9 ~ 11.5	2280	580 ~ 3390	3.95	A
	1.6 + 2.0 + 4.2 + 5.0 + 5.0	17.8	0.81	1.01	2.12	2.53	2.53	9.00	2.9 ~ 11.5	2370	670 ~ 3340	3.80	A
1.6 + 2.5 + 2.5 + 2.5 + 2.5	11.6	1.24	1.94	1.94	1.94	1.94	9.00	2.9 ~ 11.5	2300	450 ~ 3590	3.91	A	
1.6 + 2.5 + 2.5 + 2.5 + 3.5	12.6	1.14	1.79	1.79	1.79	2.49	9.00	2.9 ~ 11.5	2300	480 ~ 3510	3.91	A	
1.6 + 2.5 + 2.5 + 2.5 + 4.2	13.3	1.08	1.69	1.69	1.69	2.85	9.00	2.9 ~ 11.5	2310	480 ~ 3510	3.90	A	
1.6 + 2.5 + 2.5 + 2.5 + 5.0	14.1	1.02	1.60	1.60	1.60	3.18	9.00	2.9 ~ 11.5	2260	540 ~ 3380	3.98	A	
1.6 + 2.5 + 2.5 + 2.5 + 6.0	15.1	0.95	1.49	1.49	1.49	3.58	9.00	2.9 ~ 11.5	2260	540 ~ 3380	3.98	A	
1.6 + 2.5 + 2.5 + 2.5 + 7.1	16.2	0.89	1.39	1.39	1.39	3.94	9.00	2.9 ~ 11.5	2270	570 ~ 3380	3.96	A	
1.6 + 2.5 + 2.5 + 3.5 + 3.5	13.6	1.06	1.65	1.65	2.32	2.32	9.00	2.9 ~ 11.5	2310	490 ~ 3510	3.90	A	
1.6 + 2.5 + 2.5 + 3.5 + 4.2	14.3	1.01	1.57	1.57	2.20	2.65	9.00	2.9 ~ 11.5	2310	490 ~ 3520	3.90	A	
1.6 + 2.5 + 2.5 + 3.5 + 5.0	15.1	0.95	1.49	1.49	2.09	2.98	9.00	2.9 ~ 11.5	2270	570 ~ 3380	3.96	A	
1.6 + 2.5 + 2.5 + 3.5 + 6.0	16.1	0.89	1.40	1.40	1.96	3.35	9.00	2.9 ~ 11.5	2270	570 ~ 3380	3.96	A	
1.6 + 2.5 + 2.5 + 3.5 + 7.1	17.2	0.84	1.31	1.31	1.83	3.71	9.00	2.9 ~ 11.5	2280	580 ~ 3390	3.95	A	
1.6 + 2.5 + 2.5 + 4.2 + 4.2	15.0	0.96	1.50	1.50	2.52	2.52	9.00	2.9 ~ 11.5	2310	490 ~ 3520	3.90	A	
1.6 + 2.5 + 2.5 + 4.2 + 5.0	15.8	0.91	1.42	1.42	2.39	2.86	9.00	2.9 ~ 11.5	2270	570 ~ 3380	3.96	A	
1.6 + 2.5 + 2.5 + 4.2 + 6.0	16.8	0.86	1.34	1.34	2.25	3.21	9.00	2.9 ~ 11.5	2270	570 ~ 3380	3.96	A	
1.6 + 2.5 + 2.5 + 4.2 + 7.1	17.9	0.80	1.26	1.26	2.11	3.57	9.00	2.9 ~ 11.5	2280	580 ~ 3390	3.95	A	
1.6 + 2.5 + 2.5 + 5.0 + 5.0	16.6	0.86	1.36	1.36	2.71	2.71	9.00	2.9 ~ 11.5	2360	630 ~ 3330	3.81	A	
1.6 + 2.5 + 2.5 + 5.0 + 6.0	17.6	0.82	1.28	1.28	2.56	3.06	9.00	2.9 ~ 11.5	2360	630 ~ 3330	3.81	A	
1.6 + 2.5 + 3.5 + 3.5 + 3.5	14.6	0.99	1.53	2.16	2.16	2.16	9.00	2.9 ~ 11.5	2310	490 ~ 3440	3.90	A	



	Indoor unit capacity Cooling	Annual Energy Consumption (kWh)	Current 230V (A)	ERP			Moisture Removal Volume l/h	
				Pdesign (kW)	SEER			Annual Consumption (kWh)
					W/W	CLASS		
5 Room	1.6 + 2.0 + 2.0 + 4.2 + 5.0	1135	10.9	9.00	8.50	A+++	371	0.7 + 0.8 + 0.8 + 1.6 + 1.7
	1.6 + 2.0 + 2.0 + 4.2 + 6.0	1135	10.9	9.00	8.50	A+++	371	0.7 + 0.7 + 0.7 + 1.5 + 2.0
	1.6 + 2.0 + 2.0 + 4.2 + 7.1	1140	10.9	9.00	8.50	A+++	371	0.7 + 0.7 + 0.7 + 1.5 + 2.2
	1.6 + 2.0 + 2.0 + 5.0 + 5.0	1180	11.3	9.00	8.50	A+++	371	0.7 + 0.7 + 0.7 + 1.7 + 1.7
	1.6 + 2.0 + 2.0 + 5.0 + 6.0	1180	11.3	9.00	8.50	A+++	371	0.7 + 0.7 + 0.7 + 1.6 + 1.9
	1.6 + 2.0 + 2.0 + 5.0 + 7.1	1185	11.3	9.00	8.50	A+++	371	0.7 + 0.7 + 0.7 + 1.6 + 2.1
	1.6 + 2.0 + 2.0 + 6.0 + 6.0	1180	11.3	9.00	8.50	A+++	371	0.7 + 0.7 + 0.7 + 1.7 + 1.7
	1.6 + 2.0 + 2.5 + 2.5 + 2.5	1150	11.0	9.00	8.50	A+++	371	0.8 + 1.0 + 1.3 + 1.3 + 1.3
	1.6 + 2.0 + 2.5 + 2.5 + 3.5	1150	11.0	9.00	8.50	A+++	371	0.7 + 0.9 + 1.2 + 1.2 + 1.6
	1.6 + 2.0 + 2.5 + 2.5 + 4.2	1155	11.1	9.00	8.50	A+++	371	0.7 + 0.9 + 1.1 + 1.1 + 1.7
	1.6 + 2.0 + 2.5 + 2.5 + 5.0	1130	10.8	9.00	8.50	A+++	371	0.7 + 0.8 + 1.1 + 1.1 + 1.9
	1.6 + 2.0 + 2.5 + 2.5 + 6.0	1130	10.8	9.00	8.50	A+++	371	0.7 + 0.8 + 1.0 + 1.0 + 2.2
	1.6 + 2.0 + 2.5 + 2.5 + 7.1	1135	10.9	9.00	8.50	A+++	371	0.7 + 0.7 + 0.9 + 0.9 + 2.3
	1.6 + 2.0 + 2.5 + 3.5 + 3.5	1155	11.1	9.00	8.50	A+++	371	0.7 + 0.9 + 1.1 + 1.5 + 1.5
	1.6 + 2.0 + 2.5 + 3.5 + 4.2	1155	11.1	9.00	8.50	A+++	371	0.7 + 0.8 + 1.0 + 1.5 + 1.6
	1.6 + 2.0 + 2.5 + 3.5 + 5.0	1135	10.9	9.00	8.50	A+++	371	0.7 + 0.8 + 1.0 + 1.4 + 1.7
	1.6 + 2.0 + 2.5 + 3.5 + 6.0	1135	10.9	9.00	8.50	A+++	371	0.7 + 0.7 + 0.9 + 1.3 + 2.0
	1.6 + 2.0 + 2.5 + 3.5 + 7.1	1140	10.9	9.00	8.50	A+++	371	0.7 + 0.7 + 0.9 + 1.2 + 2.2
	1.6 + 2.0 + 2.5 + 4.2 + 4.2	1155	11.1	9.00	8.50	A+++	371	0.7 + 0.8 + 1.0 + 1.6 + 1.6
	1.6 + 2.0 + 2.5 + 4.2 + 5.0	1135	10.9	9.00	8.50	A+++	371	0.7 + 0.7 + 0.9 + 1.5 + 1.7
	1.6 + 2.0 + 2.5 + 4.2 + 6.0	1135	10.9	9.00	8.50	A+++	371	0.7 + 0.7 + 0.9 + 1.5 + 1.9
	1.6 + 2.0 + 2.5 + 4.2 + 7.1	1140	10.9	9.00	8.50	A+++	371	0.7 + 0.7 + 0.8 + 1.4 + 2.1
	1.6 + 2.0 + 2.5 + 5.0 + 5.0	1180	11.3	9.00	8.50	A+++	371	0.7 + 0.7 + 0.9 + 1.6 + 1.6
	1.6 + 2.0 + 2.5 + 5.0 + 6.0	1180	11.3	9.00	8.50	A+++	371	0.7 + 0.7 + 0.8 + 1.6 + 1.8
	1.6 + 2.0 + 2.5 + 5.0 + 7.1	1185	11.3	9.00	8.50	A+++	371	0.7 + 0.7 + 0.8 + 1.5 + 2.0
	1.6 + 2.0 + 2.5 + 6.0 + 6.0	1180	11.3	9.00	8.50	A+++	371	0.7 + 0.7 + 0.8 + 1.7 + 1.7
	1.6 + 2.0 + 3.5 + 3.5 + 3.5	1155	11.1	9.00	8.50	A+++	371	0.7 + 0.8 + 1.5 + 1.5 + 1.5
	1.6 + 2.0 + 3.5 + 3.5 + 4.2	1125	10.8	9.00	8.50	A+++	371	0.7 + 0.8 + 1.4 + 1.4 + 1.6
	1.6 + 2.0 + 3.5 + 3.5 + 5.0	1135	10.9	9.00	8.50	A+++	371	0.7 + 0.7 + 1.3 + 1.3 + 1.7
	1.6 + 2.0 + 3.5 + 3.5 + 6.0	1135	10.9	9.00	8.50	A+++	371	0.7 + 0.7 + 1.2 + 1.2 + 1.8
	1.6 + 2.0 + 3.5 + 3.5 + 7.1	1140	10.9	9.00	8.50	A+++	371	0.7 + 0.7 + 1.1 + 1.1 + 2.1
	1.6 + 2.0 + 3.5 + 4.2 + 4.2	1125	10.8	9.00	8.50	A+++	371	0.7 + 0.7 + 1.3 + 1.5 + 1.5
	1.6 + 2.0 + 3.5 + 4.2 + 5.0	1140	10.9	9.00	8.50	A+++	371	0.7 + 0.7 + 1.2 + 1.5 + 1.6
	1.6 + 2.0 + 3.5 + 4.2 + 6.0	1140	10.9	9.00	8.50	A+++	371	0.7 + 0.7 + 1.2 + 1.4 + 1.8
	1.6 + 2.0 + 3.5 + 5.0 + 5.0	1185	11.3	9.00	8.50	A+++	371	0.7 + 0.7 + 1.2 + 1.6 + 1.6
	1.6 + 2.0 + 3.5 + 5.0 + 6.0	1185	11.3	9.00	8.50	A+++	371	0.7 + 0.7 + 1.1 + 1.5 + 1.7
	1.6 + 2.0 + 4.2 + 4.2 + 4.2	1125	10.8	9.00	8.50	A+++	371	0.7 + 0.7 + 1.5 + 1.5 + 1.5
	1.6 + 2.0 + 4.2 + 4.2 + 5.0	1140	10.9	9.00	8.50	A+++	371	0.7 + 0.7 + 1.4 + 1.4 + 1.6
	1.6 + 2.0 + 4.2 + 4.2 + 6.0	1140	10.9	9.00	8.50	A+++	371	0.7 + 0.7 + 1.4 + 1.4 + 1.7
	1.6 + 2.0 + 4.2 + 5.0 + 5.0	1185	11.3	9.00	8.50	A+++	371	0.7 + 0.7 + 1.4 + 1.6 + 1.6
	1.6 + 2.5 + 2.5 + 2.5 + 2.5	1150	11.0	9.00	8.50	A+++	371	0.8 + 1.3 + 1.3 + 1.3 + 1.3
	1.6 + 2.5 + 2.5 + 2.5 + 3.5	1150	11.0	9.00	8.50	A+++	371	0.7 + 1.2 + 1.2 + 1.2 + 1.5
	1.6 + 2.5 + 2.5 + 2.5 + 4.2	1155	11.1	9.00	8.50	A+++	371	0.7 + 1.1 + 1.1 + 1.1 + 1.7
	1.6 + 2.5 + 2.5 + 2.5 + 5.0	1130	10.8	9.00	8.50	A+++	371	0.7 + 1.0 + 1.0 + 1.0 + 1.8
	1.6 + 2.5 + 2.5 + 2.5 + 6.0	1130	10.8	9.00	8.50	A+++	371	0.7 + 0.9 + 0.9 + 0.9 + 2.1
	1.6 + 2.5 + 2.5 + 2.5 + 7.1	1135	10.9	9.00	8.50	A+++	371	0.7 + 0.9 + 0.9 + 0.9 + 2.3
	1.6 + 2.5 + 2.5 + 3.5 + 3.5	1155	11.1	9.00	8.50	A+++	371	0.7 + 1.1 + 1.1 + 1.5 + 1.5
	1.6 + 2.5 + 2.5 + 3.5 + 4.2	1155	11.1	9.00	8.50	A+++	371	0.7 + 1.0 + 1.0 + 1.4 + 1.6
	1.6 + 2.5 + 2.5 + 3.5 + 5.0	1135	10.9	9.00	8.50	A+++	371	0.7 + 0.9 + 0.9 + 1.4 + 1.7
	1.6 + 2.5 + 2.5 + 3.5 + 6.0	1135	10.9	9.00	8.50	A+++	371	0.7 + 0.9 + 0.9 + 1.3 + 1.9
1.6 + 2.5 + 2.5 + 3.5 + 7.1	1140	10.9	9.00	8.50	A+++	371	0.7 + 0.8 + 0.8 + 1.2 + 2.2	
1.6 + 2.5 + 2.5 + 4.2 + 4.2	1155	11.1	9.00	8.50	A+++	371	0.7 + 1.0 + 1.0 + 1.5 + 1.5	
1.6 + 2.5 + 2.5 + 4.2 + 5.0	1135	10.9	9.00	8.50	A+++	371	0.7 + 0.9 + 0.9 + 1.5 + 1.7	
1.6 + 2.5 + 2.5 + 4.2 + 6.0	1135	10.9	9.00	8.50	A+++	371	0.7 + 0.8 + 0.8 + 1.5 + 1.8	
1.6 + 2.5 + 2.5 + 4.2 + 7.1	1140	10.9	9.00	8.50	A+++	371	0.7 + 0.8 + 0.8 + 1.4 + 2.1	
1.6 + 2.5 + 2.5 + 5.0 + 5.0	1180	11.3	9.00	8.50	A+++	371	0.7 + 0.9 + 0.9 + 1.6 + 1.6	
1.6 + 2.5 + 2.5 + 5.0 + 6.0	1180	11.3	9.00	8.50	A+++	371	0.7 + 0.8 + 0.8 + 1.6 + 1.7	
1.6 + 2.5 + 3.5 + 3.5 + 3.5	1155	11.1	9.00	8.50	A+++	371	0.7 + 1.0 + 1.4 + 1.4 + 1.4	

Indoor unit capacity Cooling	Total	Cooling Capacity (kW)							Input Power (W)		EER	
		Room A	Room B	Room C	Room D	Room E	Total	min ~ max	Rating	min ~ max	WW	CLASS
1.6 + 2.5 + 3.5 + 3.5 + 4.2	15.3	0.94	1.47	2.06	2.06	2.47	9.00	2.9 ~ 11.5	2250	490 ~ 3440	4.00	A
1.6 + 2.5 + 3.5 + 3.5 + 5.0	16.1	0.89	1.40	1.96	1.96	2.79	9.00	2.9 ~ 11.5	2270	570 ~ 3390	3.96	A
1.6 + 2.5 + 3.5 + 3.5 + 6.0	17.1	0.84	1.32	1.84	1.84	3.16	9.00	2.9 ~ 11.5	2270	570 ~ 3390	3.96	A
1.6 + 2.5 + 3.5 + 3.5 + 7.1	18.2	0.79	1.24	1.73	1.73	3.51	9.00	2.9 ~ 11.5	2280	580 ~ 3390	3.95	A
1.6 + 2.5 + 3.5 + 4.2 + 4.2	16.0	0.90	1.41	1.97	2.36	2.36	9.00	2.9 ~ 11.5	2250	490 ~ 3440	4.00	A
1.6 + 2.5 + 3.5 + 4.2 + 5.0	16.8	0.86	1.34	1.88	2.25	2.67	9.00	2.9 ~ 11.5	2280	580 ~ 3390	3.95	A
1.6 + 2.5 + 3.5 + 4.2 + 6.0	17.8	0.81	1.26	1.77	2.12	3.04	9.00	2.9 ~ 11.5	2280	580 ~ 3390	3.95	A
1.6 + 2.5 + 3.5 + 5.0 + 5.0	17.6	0.82	1.28	1.78	2.56	2.56	9.00	2.9 ~ 11.5	2370	660 ~ 3340	3.80	A
1.6 + 2.5 + 4.2 + 4.2 + 4.2	16.7	0.86	1.36	2.26	2.26	2.26	9.00	2.9 ~ 11.5	2250	520 ~ 3440	4.00	A
1.6 + 2.5 + 4.2 + 4.2 + 5.0	17.5	0.82	1.29	2.16	2.16	2.57	9.00	2.9 ~ 11.5	2280	580 ~ 3390	3.95	A
1.6 + 2.5 + 4.2 + 5.0 + 5.0	18.3	0.79	1.23	2.06	2.46	2.46	9.00	2.9 ~ 11.5	2370	670 ~ 3340	3.80	A
1.6 + 3.5 + 3.5 + 3.5 + 3.5	15.6	0.92	2.02	2.02	2.02	2.02	9.00	2.9 ~ 11.5	2250	520 ~ 3450	4.00	A
1.6 + 3.5 + 3.5 + 3.5 + 4.2	16.3	0.88	1.93	1.93	1.93	2.33	9.00	2.9 ~ 11.5	2260	520 ~ 3450	3.98	A
1.6 + 3.5 + 3.5 + 3.5 + 5.0	17.1	0.84	1.84	1.84	1.84	2.64	9.00	2.9 ~ 11.5	2280	580 ~ 3390	3.95	A
1.6 + 3.5 + 3.5 + 3.5 + 6.0	18.1	0.80	1.74	1.74	1.74	2.98	9.00	2.9 ~ 11.5	2280	580 ~ 3390	3.95	A
1.6 + 3.5 + 3.5 + 4.2 + 4.2	17.0	0.86	1.85	1.85	2.22	2.22	9.00	2.9 ~ 11.5	2260	530 ~ 3450	3.98	A
1.6 + 3.5 + 3.5 + 4.2 + 5.0	17.8	0.81	1.77	1.77	2.12	2.53	9.00	2.9 ~ 11.5	2280	580 ~ 3390	3.95	A
1.6 + 3.5 + 4.2 + 4.2 + 4.2	17.7	0.81	1.77	2.14	2.14	2.14	9.00	2.9 ~ 11.5	2260	530 ~ 3450	3.98	A
2.0 + 2.0 + 2.0 + 2.0 + 2.0	10.0	1.80	1.80	1.80	1.80	1.80	9.00	2.9 ~ 11.5	2300	480 ~ 3590	3.91	A
2.0 + 2.0 + 2.0 + 2.0 + 2.5	10.5	1.71	1.71	1.71	1.71	2.16	9.00	2.9 ~ 11.5	2300	480 ~ 3590	3.91	A
2.0 + 2.0 + 2.0 + 2.0 + 3.5	11.5	1.57	1.57	1.57	1.57	2.72	9.00	2.9 ~ 11.5	2310	480 ~ 3510	3.90	A
2.0 + 2.0 + 2.0 + 2.0 + 4.2	12.2	1.48	1.48	1.48	1.48	3.08	9.00	2.9 ~ 11.5	2310	490 ~ 3510	3.90	A
2.0 + 2.0 + 2.0 + 2.0 + 5.0	13.0	1.38	1.38	1.38	1.38	3.48	9.00	2.9 ~ 11.5	2270	540 ~ 3380	3.96	A
2.0 + 2.0 + 2.0 + 2.0 + 6.0	14.0	1.29	1.29	1.29	1.29	3.84	9.00	2.9 ~ 11.5	2270	540 ~ 3380	3.96	A
2.0 + 2.0 + 2.0 + 2.0 + 7.1	15.1	1.19	1.19	1.19	1.19	4.24	9.00	2.9 ~ 11.5	2270	570 ~ 3380	3.96	A
2.0 + 2.0 + 2.0 + 2.5 + 2.5	11.0	1.64	1.64	1.64	2.04	2.04	9.00	2.9 ~ 11.5	2300	480 ~ 3590	3.91	A
2.0 + 2.0 + 2.0 + 2.5 + 3.5	12.0	1.50	1.50	1.50	1.88	2.62	9.00	2.9 ~ 11.5	2310	480 ~ 3510	3.90	A
2.0 + 2.0 + 2.0 + 2.5 + 4.2	12.7	1.42	1.42	1.42	1.77	2.97	9.00	2.9 ~ 11.5	2310	490 ~ 3510	3.90	A
2.0 + 2.0 + 2.0 + 2.5 + 5.0	13.5	1.33	1.33	1.33	1.67	3.34	9.00	2.9 ~ 11.5	2270	540 ~ 3380	3.96	A
2.0 + 2.0 + 2.0 + 2.5 + 6.0	14.5	1.24	1.24	1.24	1.55	3.73	9.00	2.9 ~ 11.5	2270	540 ~ 3380	3.96	A
2.0 + 2.0 + 2.0 + 2.5 + 7.1	15.6	1.15	1.15	1.15	1.44	4.11	9.00	2.9 ~ 11.5	2270	570 ~ 3380	3.96	A
2.0 + 2.0 + 2.0 + 3.5 + 3.5	13.0	1.38	1.38	1.38	2.43	2.43	9.00	2.9 ~ 11.5	2310	490 ~ 3520	3.90	A
2.0 + 2.0 + 2.0 + 3.5 + 4.2	13.7	1.31	1.31	1.31	2.30	2.77	9.00	2.9 ~ 11.5	2310	490 ~ 3520	3.90	A
2.0 + 2.0 + 2.0 + 3.5 + 5.0	14.5	1.24	1.24	1.24	2.17	3.11	9.00	2.9 ~ 11.5	2270	570 ~ 3380	3.96	A
2.0 + 2.0 + 2.0 + 3.5 + 6.0	15.5	1.16	1.16	1.16	2.03	3.49	9.00	2.9 ~ 11.5	2270	570 ~ 3380	3.96	A
2.0 + 2.0 + 2.0 + 3.5 + 7.1	16.6	1.08	1.08	1.08	1.90	3.86	9.00	2.9 ~ 11.5	2280	580 ~ 3390	3.95	A
2.0 + 2.0 + 2.0 + 4.2 + 4.2	14.4	1.25	1.25	1.25	2.62	2.62	8.99	2.9 ~ 11.5	2250	490 ~ 3520	4.00	A
2.0 + 2.0 + 2.0 + 4.2 + 5.0	15.2	1.18	1.18	1.18	2.49	2.97	9.00	2.9 ~ 11.5	2270	570 ~ 3380	3.96	A
2.0 + 2.0 + 2.0 + 4.2 + 6.0	16.2	1.11	1.11	1.11	2.33	3.34	9.00	2.9 ~ 11.5	2270	570 ~ 3380	3.96	A
2.0 + 2.0 + 2.0 + 4.2 + 7.1	17.3	1.04	1.04	1.04	2.18	3.70	9.00	2.9 ~ 11.5	2280	580 ~ 3390	3.95	A
2.0 + 2.0 + 2.0 + 5.0 + 5.0	16.0	1.13	1.13	1.13	2.80	2.80	8.99	2.9 ~ 11.5	2360	660 ~ 3330	3.81	A
2.0 + 2.0 + 2.0 + 5.0 + 6.0	17.0	1.06	1.06	1.06	2.65	3.17	9.00	2.9 ~ 11.5	2360	660 ~ 3330	3.81	A
2.0 + 2.0 + 2.0 + 5.0 + 7.1	18.1	0.99	0.99	0.99	2.49	3.54	9.00	2.9 ~ 11.5	2370	670 ~ 3340	3.80	A
2.0 + 2.0 + 2.0 + 6.0 + 6.0	18.0	1.00	1.00	1.00	3.00	3.00	9.00	2.9 ~ 11.5	2360	660 ~ 3330	3.81	A
2.0 + 2.0 + 2.5 + 2.5 + 2.5	11.5	1.56	1.56	1.96	1.96	1.96	9.00	2.9 ~ 11.5	2300	480 ~ 3590	3.91	A
2.0 + 2.0 + 2.5 + 2.5 + 3.5	12.5	1.44	1.44	1.80	1.80	2.52	9.00	2.9 ~ 11.5	2310	480 ~ 3510	3.90	A
2.0 + 2.0 + 2.5 + 2.5 + 4.2	13.2	1.36	1.36	1.70	1.70	2.88	9.00	2.9 ~ 11.5	2310	490 ~ 3510	3.90	A
2.0 + 2.0 + 2.5 + 2.5 + 5.0	14.0	1.29	1.29	1.61	1.61	3.20	9.00	2.9 ~ 11.5	2270	540 ~ 3380	3.96	A
2.0 + 2.0 + 2.5 + 2.5 + 6.0	15.0	1.20	1.20	1.50	1.50	3.60	9.00	2.9 ~ 11.5	2270	540 ~ 3380	3.96	A
2.0 + 2.0 + 2.5 + 2.5 + 7.1	16.1	1.12	1.12	1.40	1.40	3.96	9.00	2.9 ~ 11.5	2270	570 ~ 3380	3.96	A
2.0 + 2.0 + 2.5 + 3.5 + 3.5	13.5	1.33	1.33	1.68	2.33	2.33	9.00	2.9 ~ 11.5	2310	490 ~ 3520	3.90	A
2.0 + 2.0 + 2.5 + 3.5 + 4.2	14.2	1.27	1.27	1.58	2.22	2.66	9.00	2.9 ~ 11.5	2310	490 ~ 3520	3.90	A
2.0 + 2.0 + 2.5 + 3.5 + 5.0	15.0	1.20	1.20	1.50	2.10	3.00	9.00	2.9 ~ 11.5	2270	570 ~ 3380	3.96	A
2.0 + 2.0 + 2.5 + 3.5 + 6.0	16.0	1.13	1.13	1.41	1.97	3.36	9.00	2.9 ~ 11.5	2270	570 ~ 3380	3.96	A
2.0 + 2.0 + 2.5 + 3.5 + 7.1	17.1	1.05	1.05	1.32	1.84	3.74	9.00	2.9 ~ 11.5	2280	580 ~ 3390	3.95	A
2.0 + 2.0 + 2.5 + 4.2 + 4.2	14.9	1.21	1.21	1.50	2.54	2.54	9.00	2.9 ~ 11.5	2310	490 ~ 3520	3.90	A
2.0 + 2.0 + 2.5 + 4.2 + 5.0	15.7	1.15	1.15	1.43	2.41	2.86	9.00	2.9 ~ 11.5	2270	570 ~ 3380	3.96	A
2.0 + 2.0 + 2.5 + 4.2 + 6.0	16.7	1.08	1.08	1.35	2.26	3.23	9.00	2.9 ~ 11.5	2270	570 ~ 3380	3.96	A

5 Room

	Indoor unit capacity Cooling	Annual Energy Consumption (kWh)	Current 230V (A)	ERP				Moisture Removal Volume l/h
				Pdesign (kW)	SEER		Annual Consumption (kWh)	
					W/W	CLASS		
5 Room	1.6 + 2.5 + 3.5 + 3.5 + 4.2	1125	10.8	9.00	8.50	A+++	371	0.7 + 0.9 + 1.3 + 1.3 + 1.5
	1.6 + 2.5 + 3.5 + 3.5 + 5.0	1135	10.9	9.00	8.50	A+++	371	0.7 + 0.9 + 1.3 + 1.3 + 1.6
	1.6 + 2.5 + 3.5 + 3.5 + 6.0	1135	10.9	9.00	8.50	A+++	371	0.7 + 0.8 + 1.2 + 1.2 + 1.8
	1.6 + 2.5 + 3.5 + 3.5 + 7.1	1140	10.9	9.00	8.50	A+++	371	0.7 + 0.8 + 1.1 + 1.1 + 2.0
	1.6 + 2.5 + 3.5 + 4.2 + 4.2	1125	10.8	9.00	8.50	A+++	371	0.7 + 0.9 + 1.3 + 1.5 + 1.5
	1.6 + 2.5 + 3.5 + 4.2 + 5.0	1140	10.9	9.00	8.50	A+++	371	0.7 + 0.8 + 1.2 + 1.5 + 1.6
	1.6 + 2.5 + 3.5 + 4.2 + 6.0	1140	10.9	9.00	8.50	A+++	371	0.7 + 0.8 + 1.1 + 1.4 + 1.7
	1.6 + 2.5 + 3.5 + 5.0 + 5.0	1185	11.3	9.00	8.50	A+++	371	0.7 + 0.8 + 1.1 + 1.6 + 1.6
	1.6 + 2.5 + 4.2 + 4.2 + 4.2	1125	10.8	9.00	8.50	A+++	371	0.7 + 0.9 + 1.5 + 1.5 + 1.5
	1.6 + 2.5 + 4.2 + 4.2 + 5.0	1140	10.9	9.00	8.50	A+++	371	0.7 + 0.8 + 1.4 + 1.4 + 1.6
	1.6 + 2.5 + 4.2 + 5.0 + 5.0	1185	11.3	9.00	8.50	A+++	371	0.7 + 0.8 + 1.3 + 1.5 + 1.5
	1.6 + 3.5 + 3.5 + 3.5 + 3.5	1125	10.8	9.00	8.50	A+++	371	0.7 + 1.3 + 1.3 + 1.3 + 1.3
	1.6 + 3.5 + 3.5 + 3.5 + 4.2	1130	10.8	9.00	8.50	A+++	371	0.7 + 1.2 + 1.2 + 1.2 + 1.5
	1.6 + 3.5 + 3.5 + 3.5 + 5.0	1140	10.9	9.00	8.50	A+++	371	0.7 + 1.2 + 1.2 + 1.2 + 1.6
	1.6 + 3.5 + 3.5 + 3.5 + 6.0	1140	10.9	9.00	8.50	A+++	371	0.7 + 1.1 + 1.1 + 1.1 + 1.7
	1.6 + 3.5 + 3.5 + 4.2 + 4.2	1130	10.8	9.00	8.50	A+++	371	0.7 + 1.2 + 1.2 + 1.4 + 1.4
	1.6 + 3.5 + 3.5 + 4.2 + 5.0	1140	10.9	9.00	8.50	A+++	371	0.7 + 1.1 + 1.1 + 1.4 + 1.6
	1.6 + 3.5 + 4.2 + 4.2 + 4.2	1130	10.8	9.00	8.50	A+++	371	0.7 + 1.1 + 1.4 + 1.4 + 1.4
	2.0 + 2.0 + 2.0 + 2.0 + 2.0	1150	11.0	9.00	8.50	A+++	371	1.2 + 1.2 + 1.2 + 1.2 + 1.2
	2.0 + 2.0 + 2.0 + 2.0 + 2.5	1150	11.0	9.00	8.50	A+++	371	1.1 + 1.1 + 1.1 + 1.1 + 1.4
	2.0 + 2.0 + 2.0 + 2.0 + 3.5	1155	11.1	9.00	8.50	A+++	371	1.0 + 1.0 + 1.0 + 1.0 + 1.6
	2.0 + 2.0 + 2.0 + 2.0 + 4.2	1155	11.1	9.00	8.50	A+++	371	0.9 + 0.9 + 0.9 + 0.9 + 1.7
	2.0 + 2.0 + 2.0 + 2.0 + 5.0	1135	10.9	9.00	8.50	A+++	371	0.9 + 0.9 + 0.9 + 0.9 + 2.0
	2.0 + 2.0 + 2.0 + 2.0 + 6.0	1135	10.9	9.00	8.50	A+++	371	0.8 + 0.8 + 0.8 + 0.8 + 2.2
	2.0 + 2.0 + 2.0 + 2.0 + 7.1	1135	10.9	9.00	8.50	A+++	371	0.7 + 0.7 + 0.7 + 0.7 + 2.4
	2.0 + 2.0 + 2.0 + 2.5 + 2.5	1150	11.0	9.00	8.50	A+++	371	1.0 + 1.0 + 1.0 + 1.3 + 1.3
	2.0 + 2.0 + 2.0 + 2.5 + 3.5	1155	11.1	9.00	8.50	A+++	371	1.0 + 1.0 + 1.0 + 1.2 + 1.6
	2.0 + 2.0 + 2.0 + 2.5 + 4.2	1155	11.1	9.00	8.50	A+++	371	0.9 + 0.9 + 0.9 + 1.1 + 1.7
	2.0 + 2.0 + 2.0 + 2.5 + 5.0	1135	10.9	9.00	8.50	A+++	371	0.8 + 0.8 + 0.8 + 1.1 + 1.9
	2.0 + 2.0 + 2.0 + 2.5 + 6.0	1135	10.9	9.00	8.50	A+++	371	0.8 + 0.8 + 0.8 + 1.0 + 2.2
	2.0 + 2.0 + 2.0 + 2.5 + 7.1	1135	10.9	9.00	8.50	A+++	371	0.7 + 0.7 + 0.7 + 0.9 + 2.3
	2.0 + 2.0 + 2.0 + 3.5 + 3.5	1155	11.1	9.00	8.50	A+++	371	0.9 + 0.9 + 0.9 + 1.5 + 1.5
	2.0 + 2.0 + 2.0 + 3.5 + 4.2	1155	11.1	9.00	8.50	A+++	371	0.8 + 0.8 + 0.8 + 1.5 + 1.6
	2.0 + 2.0 + 2.0 + 3.5 + 5.0	1135	10.9	9.00	8.50	A+++	371	0.8 + 0.8 + 0.8 + 1.4 + 1.8
	2.0 + 2.0 + 2.0 + 3.5 + 6.0	1135	10.9	9.00	8.50	A+++	371	0.7 + 0.7 + 0.7 + 1.3 + 2.0
	2.0 + 2.0 + 2.0 + 3.5 + 7.1	1140	10.9	9.00	8.50	A+++	371	0.7 + 0.7 + 0.7 + 1.2 + 2.3
	2.0 + 2.0 + 2.0 + 4.2 + 4.2	1125	10.8	8.99	8.50	A+++	370	0.8 + 0.8 + 0.8 + 1.6 + 1.6
	2.0 + 2.0 + 2.0 + 4.2 + 5.0	1135	10.9	9.00	8.50	A+++	371	0.7 + 0.7 + 0.7 + 1.5 + 1.7
	2.0 + 2.0 + 2.0 + 4.2 + 6.0	1135	10.9	9.00	8.50	A+++	371	0.7 + 0.7 + 0.7 + 1.5 + 1.9
	2.0 + 2.0 + 2.0 + 4.2 + 7.1	1140	10.9	9.00	8.50	A+++	371	0.7 + 0.7 + 0.7 + 1.4 + 2.2
	2.0 + 2.0 + 2.0 + 5.0 + 5.0	1180	11.3	8.99	8.50	A+++	370	0.7 + 0.7 + 0.7 + 1.6 + 1.6
	2.0 + 2.0 + 2.0 + 5.0 + 6.0	1180	11.3	9.00	8.50	A+++	371	0.7 + 0.7 + 0.7 + 1.6 + 1.8
	2.0 + 2.0 + 2.0 + 5.0 + 7.1	1185	11.3	9.00	8.50	A+++	371	0.7 + 0.7 + 0.7 + 1.5 + 2.0
	2.0 + 2.0 + 2.0 + 6.0 + 6.0	1180	11.3	9.00	8.50	A+++	371	0.7 + 0.7 + 0.7 + 1.7 + 1.7
	2.0 + 2.0 + 2.5 + 2.5 + 2.5	1150	11.0	9.00	8.50	A+++	371	1.0 + 1.0 + 1.3 + 1.3 + 1.3
	2.0 + 2.0 + 2.5 + 2.5 + 3.5	1155	11.1	9.00	8.50	A+++	371	0.9 + 0.9 + 1.2 + 1.2 + 1.5
	2.0 + 2.0 + 2.5 + 2.5 + 4.2	1155	11.1	9.00	8.50	A+++	371	0.9 + 0.9 + 1.1 + 1.1 + 1.7
	2.0 + 2.0 + 2.5 + 2.5 + 5.0	1135	10.9	9.00	8.50	A+++	371	0.8 + 0.8 + 1.0 + 1.0 + 1.8
	2.0 + 2.0 + 2.5 + 2.5 + 6.0	1135	10.9	9.00	8.50	A+++	371	0.7 + 0.7 + 1.0 + 1.0 + 2.1
	2.0 + 2.0 + 2.5 + 2.5 + 7.1	1135	10.9	9.00	8.50	A+++	371	0.7 + 0.7 + 0.9 + 0.9 + 2.3
2.0 + 2.0 + 2.5 + 3.5 + 3.5	1155	11.1	9.00	8.50	A+++	371	0.8 + 0.8 + 1.1 + 1.5 + 1.5	
2.0 + 2.0 + 2.5 + 3.5 + 4.2	1155	11.1	9.00	8.50	A+++	371	0.8 + 0.8 + 1.0 + 1.4 + 1.6	
2.0 + 2.0 + 2.5 + 3.5 + 5.0	1135	10.9	9.00	8.50	A+++	371	0.7 + 0.7 + 1.0 + 1.4 + 1.7	
2.0 + 2.0 + 2.5 + 3.5 + 6.0	1135	10.9	9.00	8.50	A+++	371	0.7 + 0.7 + 0.9 + 1.3 + 1.9	
2.0 + 2.0 + 2.5 + 3.5 + 7.1	1140	10.9	9.00	8.50	A+++	371	0.7 + 0.7 + 0.8 + 1.2 + 2.2	
2.0 + 2.0 + 2.5 + 4.2 + 4.2	1155	11.1	9.00	8.50	A+++	371	0.8 + 0.8 + 1.0 + 1.6 + 1.6	
2.0 + 2.0 + 2.5 + 4.2 + 5.0	1135	10.9	9.00	8.50	A+++	371	0.7 + 0.7 + 0.9 + 1.5 + 1.7	
2.0 + 2.0 + 2.5 + 4.2 + 6.0	1135	10.9	9.00	8.50	A+++	371	0.7 + 0.7 + 0.9 + 1.5 + 1.8	

Indoor unit capacity Cooling		Total	Cooling Capacity (kW)							Input Power (W)		EER	
			Room A	Room B	Room C	Room D	Room E	Total	min ~ max	Rating	min ~ max	WW	CLASS
5 Room	2.0 + 2.0 + 2.5 + 4.2 + 7.1	17.8	1.01	1.01	1.26	2.12	3.60	9.00	2.9 ~ 11.5	2280	580 ~ 3390	3.95	A
	2.0 + 2.0 + 2.5 + 5.0 + 5.0	16.5	1.09	1.09	1.36	2.73	2.73	9.00	2.9 ~ 11.5	2360	660 ~ 3330	3.81	A
	2.0 + 2.0 + 2.5 + 5.0 + 6.0	17.5	1.03	1.03	1.29	2.57	3.08	9.00	2.9 ~ 11.5	2360	660 ~ 3330	3.81	A
	2.0 + 2.0 + 3.5 + 3.5 + 3.5	14.5	1.24	1.24	2.17	2.17	2.17	8.99	2.9 ~ 11.5	2250	490 ~ 3440	4.00	A
	2.0 + 2.0 + 3.5 + 3.5 + 4.2	15.2	1.18	1.18	2.07	2.07	2.50	9.00	2.9 ~ 11.5	2250	500 ~ 3440	4.00	A
	2.0 + 2.0 + 3.5 + 3.5 + 5.0	16.0	1.13	1.13	1.97	1.97	2.80	9.00	2.9 ~ 11.5	2280	580 ~ 3390	3.95	A
	2.0 + 2.0 + 3.5 + 3.5 + 6.0	17.0	1.06	1.06	1.85	1.85	3.18	9.00	2.9 ~ 11.5	2280	580 ~ 3390	3.95	A
	2.0 + 2.0 + 3.5 + 3.5 + 7.1	18.1	0.99	0.99	1.74	1.74	3.54	9.00	2.9 ~ 11.5	2280	610 ~ 3390	3.95	A
	2.0 + 2.0 + 3.5 + 4.2 + 4.2	15.9	1.13	1.13	1.98	2.38	2.38	9.00	2.9 ~ 11.5	2250	520 ~ 3450	4.00	A
	2.0 + 2.0 + 3.5 + 4.2 + 5.0	16.7	1.08	1.08	1.89	2.26	2.69	9.00	2.9 ~ 11.5	2280	580 ~ 3390	3.95	A
	2.0 + 2.0 + 3.5 + 4.2 + 6.0	17.7	1.02	1.02	1.78	2.14	3.04	9.00	2.9 ~ 11.5	2280	580 ~ 3390	3.95	A
	2.0 + 2.0 + 3.5 + 5.0 + 5.0	17.5	1.03	1.03	1.80	2.57	2.57	9.00	2.9 ~ 11.5	2370	670 ~ 3340	3.80	A
	2.0 + 2.0 + 4.2 + 4.2 + 4.2	16.6	1.08	1.08	2.28	2.28	2.28	9.00	2.9 ~ 11.5	2250	520 ~ 3450	4.00	A
	2.0 + 2.0 + 4.2 + 4.2 + 5.0	17.4	1.03	1.03	2.17	2.17	2.60	9.00	2.9 ~ 11.5	2280	580 ~ 3390	3.95	A
	2.0 + 2.0 + 4.2 + 5.0 + 5.0	18.2	0.99	0.99	2.08	2.47	2.47	9.00	2.9 ~ 11.5	2370	670 ~ 3340	3.80	A
	2.0 + 2.5 + 2.5 + 2.5 + 2.5	12.0	1.48	1.88	1.88	1.88	1.88	9.00	2.9 ~ 11.5	2300	480 ~ 3590	3.91	A
	2.0 + 2.5 + 2.5 + 2.5 + 3.5	13.0	1.38	1.73	1.73	1.73	2.43	9.00	2.9 ~ 11.5	2310	480 ~ 3510	3.90	A
	2.0 + 2.5 + 2.5 + 2.5 + 4.2	13.7	1.31	1.64	1.64	1.64	2.77	9.00	2.9 ~ 11.5	2310	490 ~ 3510	3.90	A
	2.0 + 2.5 + 2.5 + 2.5 + 5.0	14.5	1.24	1.55	1.55	1.55	3.11	9.00	2.9 ~ 11.5	2270	540 ~ 3380	3.96	A
	2.0 + 2.5 + 2.5 + 2.5 + 6.0	15.5	1.16	1.45	1.45	1.45	3.49	9.00	2.9 ~ 11.5	2270	540 ~ 3380	3.96	A
	2.0 + 2.5 + 2.5 + 2.5 + 7.1	16.6	1.08	1.36	1.36	1.36	3.84	9.00	2.9 ~ 11.5	2270	570 ~ 3380	3.96	A
	2.0 + 2.5 + 2.5 + 3.5 + 3.5	14.0	1.28	1.61	1.61	2.25	2.25	9.00	2.9 ~ 11.5	2310	490 ~ 3520	3.90	A
	2.0 + 2.5 + 2.5 + 3.5 + 4.2	14.7	1.22	1.53	1.53	2.14	2.58	9.00	2.9 ~ 11.5	2310	490 ~ 3520	3.90	A
	2.0 + 2.5 + 2.5 + 3.5 + 5.0	15.5	1.16	1.45	1.45	2.03	2.91	9.00	2.9 ~ 11.5	2270	570 ~ 3380	3.96	A
	2.0 + 2.5 + 2.5 + 3.5 + 6.0	16.5	1.09	1.36	1.36	1.91	3.28	9.00	2.9 ~ 11.5	2270	570 ~ 3380	3.96	A
	2.0 + 2.5 + 2.5 + 3.5 + 7.1	17.6	1.02	1.28	1.28	1.79	3.63	9.00	2.9 ~ 11.5	2280	580 ~ 3390	3.95	A
	2.0 + 2.5 + 2.5 + 4.2 + 4.2	15.4	1.18	1.46	1.46	2.45	2.45	9.00	2.9 ~ 11.5	2310	490 ~ 3520	3.90	A
	2.0 + 2.5 + 2.5 + 4.2 + 5.0	16.2	1.11	1.39	1.39	2.33	2.78	9.00	2.9 ~ 11.5	2270	570 ~ 3380	3.96	A
	2.0 + 2.5 + 2.5 + 4.2 + 6.0	17.2	1.05	1.31	1.31	2.20	3.13	9.00	2.9 ~ 11.5	2270	570 ~ 3380	3.96	A
	2.0 + 2.5 + 2.5 + 4.2 + 7.1	18.3	0.98	1.23	1.23	2.07	3.49	9.00	2.9 ~ 11.5	2280	580 ~ 3390	3.95	A
	2.0 + 2.5 + 2.5 + 5.0 + 5.0	17.0	1.06	1.32	1.32	2.65	2.65	9.00	2.9 ~ 11.5	2360	660 ~ 3330	3.81	A
	2.0 + 2.5 + 2.5 + 5.0 + 6.0	18.0	1.00	1.25	1.25	2.50	3.00	9.00	2.9 ~ 11.5	2360	660 ~ 3330	3.81	A
	2.0 + 2.5 + 3.5 + 3.5 + 3.5	15.0	1.20	1.50	2.10	2.10	2.10	9.00	2.9 ~ 11.5	2250	490 ~ 3440	4.00	A
	2.0 + 2.5 + 3.5 + 3.5 + 4.2	15.7	1.15	1.43	2.01	2.01	2.40	9.00	2.9 ~ 11.5	2250	500 ~ 3440	4.00	A
	2.0 + 2.5 + 3.5 + 3.5 + 5.0	16.5	1.09	1.36	1.91	1.91	2.73	9.00	2.9 ~ 11.5	2280	580 ~ 3390	3.95	A
	2.0 + 2.5 + 3.5 + 3.5 + 6.0	17.5	1.03	1.29	1.80	1.80	3.08	9.00	2.9 ~ 11.5	2280	580 ~ 3390	3.95	A
	2.0 + 2.5 + 3.5 + 4.2 + 4.2	16.4	1.10	1.37	1.93	2.30	2.30	9.00	2.9 ~ 11.5	2250	520 ~ 3450	4.00	A
	2.0 + 2.5 + 3.5 + 4.2 + 5.0	17.2	1.05	1.31	1.83	2.20	2.61	9.00	2.9 ~ 11.5	2280	580 ~ 3390	3.95	A
	2.0 + 2.5 + 3.5 + 4.2 + 6.0	18.2	0.99	1.24	1.73	2.08	2.96	9.00	2.9 ~ 11.5	2280	580 ~ 3390	3.95	A
	2.0 + 2.5 + 3.5 + 5.0 + 5.0	18.0	1.00	1.25	1.75	2.50	2.50	9.00	2.9 ~ 11.5	2370	670 ~ 3340	3.80	A
	2.0 + 2.5 + 4.2 + 4.2 + 4.2	17.1	1.05	1.32	2.21	2.21	2.21	9.00	2.9 ~ 11.5	2250	520 ~ 3450	4.00	A
	2.0 + 2.5 + 4.2 + 4.2 + 5.0	17.9	1.01	1.26	2.11	2.11	2.51	9.00	2.9 ~ 11.5	2280	580 ~ 3390	3.95	A
	2.0 + 3.5 + 3.5 + 3.5 + 3.5	16.0	1.12	1.97	1.97	1.97	1.97	9.00	2.9 ~ 11.5	2260	530 ~ 3450	3.98	A
	2.0 + 3.5 + 3.5 + 3.5 + 4.2	16.7	1.08	1.89	1.89	1.89	2.25	9.00	2.9 ~ 11.5	2260	530 ~ 3450	3.98	A
	2.0 + 3.5 + 3.5 + 3.5 + 5.0	17.5	1.03	1.80	1.80	1.80	2.57	9.00	2.9 ~ 11.5	2280	580 ~ 3390	3.95	A
2.0 + 3.5 + 3.5 + 4.2 + 4.2	17.4	1.04	1.81	1.81	2.17	2.17	9.00	2.9 ~ 11.5	2260	530 ~ 3450	3.98	A	
2.0 + 3.5 + 3.5 + 4.2 + 5.0	18.2	0.99	1.73	1.73	2.08	2.47	9.00	2.9 ~ 11.5	2280	580 ~ 3390	3.95	A	
2.0 + 3.5 + 4.2 + 4.2 + 4.2	18.1	0.99	1.74	2.09	2.09	2.09	9.00	2.9 ~ 11.5	2260	530 ~ 3450	3.98	A	
2.5 + 2.5 + 2.5 + 2.5 + 2.5	12.5	1.80	1.80	1.80	1.80	1.80	9.00	2.9 ~ 11.5	2300	480 ~ 3590	3.91	A	
2.5 + 2.5 + 2.5 + 2.5 + 3.5	13.5	1.67	1.67	1.67	1.67	2.32	9.00	2.9 ~ 11.5	2310	480 ~ 3510	3.90	A	
2.5 + 2.5 + 2.5 + 2.5 + 4.2	14.2	1.58	1.58	1.58	1.58	2.68	9.00	2.9 ~ 11.5	2310	490 ~ 3510	3.90	A	
2.5 + 2.5 + 2.5 + 2.5 + 5.0	15.0	1.50	1.50	1.50	1.50	3.00	9.00	2.9 ~ 11.5	2270	540 ~ 3380	3.96	A	
2.5 + 2.5 + 2.5 + 2.5 + 6.0	16.0	1.41	1.41	1.41	1.41	3.36	9.00	2.9 ~ 11.5	2270	540 ~ 3380	3.96	A	
2.5 + 2.5 + 2.5 + 2.5 + 7.1	17.1	1.32	1.32	1.32	1.32	3.72	9.00	2.9 ~ 11.5	2270	570 ~ 3380	3.96	A	
2.5 + 2.5 + 2.5 + 3.5 + 3.5	14.5	1.55	1.55	1.55	2.17	2.17	8.99	2.9 ~ 11.5	2310	490 ~ 3520	3.89	A	
2.5 + 2.5 + 2.5 + 3.5 + 4.2	15.2	1.48	1.48	1.48	2.07	2.49	9.00	2.9 ~ 11.5	2310	490 ~ 3520	3.90	A	
2.5 + 2.5 + 2.5 + 3.5 + 5.0	16.0	1.41	1.41	1.41	1.97	2.80	9.00	2.9 ~ 11.5	2270	570 ~ 3380	3.96	A	
2.5 + 2.5 + 2.5 + 3.5 + 6.0	17.0	1.32	1.32	1.32	1.85	3.19	9.00	2.9 ~ 11.5	2270	570 ~ 3380	3.96	A	

	Indoor unit capacity Cooling	Annual Energy Consumption (kWh)	Current 230V (A)	ERP			Moisture Removal Volume l/h	
				Pdesign (kW)	SEER			Annual Consumption (kWh)
					W/W	CLASS		
5 Room	2.0+2.0+2.5+4.2+7.1	1140	10.9	9.00	8.50	A+++	371	0.7+0.7+0.8+1.4+2.1
	2.0+2.0+2.5+5.0+5.0	1180	11.3	9.00	8.50	A+++	371	0.7+0.7+0.9+1.6+1.6
	2.0+2.0+2.5+5.0+6.0	1180	11.3	9.00	8.50	A+++	371	0.7+0.7+0.8+1.6+1.7
	2.0+2.0+3.5+3.5+3.5	1125	10.8	8.99	8.50	A+++	370	0.8+0.8+1.4+1.4+1.4
	2.0+2.0+3.5+3.5+4.2	1125	10.8	9.00	8.50	A+++	371	0.7+0.7+1.3+1.3+1.5
	2.0+2.0+3.5+3.5+5.0	1140	10.9	9.00	8.50	A+++	371	0.7+0.7+1.3+1.3+1.6
	2.0+2.0+3.5+3.5+6.0	1140	10.9	9.00	8.50	A+++	371	0.7+0.7+1.2+1.2+1.8
	2.0+2.0+3.5+3.5+7.1	1140	10.9	9.00	8.50	A+++	371	0.7+0.7+1.1+1.1+2.0
	2.0+2.0+3.5+4.2+4.2	1125	10.8	9.00	8.50	A+++	371	0.7+0.7+1.3+1.5+1.5
	2.0+2.0+3.5+4.2+5.0	1140	10.9	9.00	8.50	A+++	371	0.7+0.7+1.2+1.5+1.6
	2.0+2.0+3.5+4.2+6.0	1140	10.9	9.00	8.50	A+++	371	0.7+0.7+1.1+1.4+1.7
	2.0+2.0+3.5+5.0+5.0	1185	11.3	9.00	8.50	A+++	371	0.7+0.7+1.2+1.6+1.6
	2.0+2.0+4.2+4.2+4.2	1125	10.8	9.00	8.50	A+++	371	0.7+0.7+1.5+1.5+1.5
	2.0+2.0+4.2+4.2+5.0	1140	10.9	9.00	8.50	A+++	371	0.7+0.7+1.4+1.4+1.6
	2.0+2.0+4.2+5.0+5.0	1185	11.3	9.00	8.50	A+++	371	0.7+0.7+1.3+1.5+1.5
	2.0+2.5+2.5+2.5+2.5	1150	11.0	9.00	8.50	A+++	371	0.9+1.2+1.2+1.2+1.2
	2.0+2.5+2.5+2.5+3.5	1155	11.1	9.00	8.50	A+++	371	0.9+1.1+1.1+1.1+1.5
	2.0+2.5+2.5+2.5+4.2	1155	11.1	9.00	8.50	A+++	371	0.8+1.0+1.0+1.0+1.6
	2.0+2.5+2.5+2.5+5.0	1135	10.9	9.00	8.50	A+++	371	0.8+1.0+1.0+1.0+1.8
	2.0+2.5+2.5+2.5+6.0	1135	10.9	9.00	8.50	A+++	371	0.7+0.9+0.9+0.9+2.0
	2.0+2.5+2.5+2.5+7.1	1135	10.9	9.00	8.50	A+++	371	0.7+0.9+0.9+0.9+2.2
	2.0+2.5+2.5+3.5+3.5	1155	11.1	9.00	8.50	A+++	371	0.8+1.0+1.0+1.5+1.5
	2.0+2.5+2.5+3.5+4.2	1155	11.1	9.00	8.50	A+++	371	0.8+1.0+1.0+1.4+1.6
	2.0+2.5+2.5+3.5+5.0	1135	10.9	9.00	8.50	A+++	371	0.7+0.9+0.9+1.3+1.7
	2.0+2.5+2.5+3.5+6.0	1135	10.9	9.00	8.50	A+++	371	0.7+0.9+0.9+1.2+1.9
	2.0+2.5+2.5+3.5+7.1	1140	10.9	9.00	8.50	A+++	371	0.7+0.8+0.8+1.2+2.1
	2.0+2.5+2.5+4.2+4.2	1155	11.1	9.00	8.50	A+++	371	0.7+0.9+0.9+1.5+1.5
	2.0+2.5+2.5+4.2+5.0	1135	10.9	9.00	8.50	A+++	371	0.7+0.9+0.9+1.5+1.6
	2.0+2.5+2.5+4.2+6.0	1135	10.9	9.00	8.50	A+++	371	0.7+0.8+0.8+1.4+1.8
	2.0+2.5+2.5+4.2+7.1	1140	10.9	9.00	8.50	A+++	371	0.7+0.8+0.8+1.3+2.0
	2.0+2.5+2.5+5.0+5.0	1180	11.3	9.00	8.50	A+++	371	0.7+0.8+0.8+1.6+1.6
	2.0+2.5+2.5+5.0+6.0	1180	11.3	9.00	8.50	A+++	371	0.7+0.8+0.8+1.5+1.7
	2.0+2.5+3.5+3.5+3.5	1125	10.8	9.00	8.50	A+++	371	0.7+1.0+1.4+1.4+1.4
	2.0+2.5+3.5+3.5+4.2	1125	10.8	9.00	8.50	A+++	371	0.7+0.9+1.3+1.3+1.5
	2.0+2.5+3.5+3.5+5.0	1140	10.9	9.00	8.50	A+++	371	0.7+0.9+1.2+1.2+1.6
	2.0+2.5+3.5+3.5+6.0	1140	10.9	9.00	8.50	A+++	371	0.7+0.8+1.2+1.2+1.7
	2.0+2.5+3.5+4.2+4.2	1125	10.8	9.00	8.50	A+++	371	0.7+0.9+1.2+1.5+1.5
	2.0+2.5+3.5+4.2+5.0	1140	10.9	9.00	8.50	A+++	371	0.7+0.8+1.2+1.4+1.6
	2.0+2.5+3.5+4.2+6.0	1140	10.9	9.00	8.50	A+++	371	0.7+0.8+1.1+1.3+1.7
	2.0+2.5+3.5+5.0+5.0	1185	11.3	9.00	8.50	A+++	371	0.7+0.8+1.1+1.5+1.5
	2.0+2.5+4.2+4.2+4.2	1125	10.8	9.00	8.50	A+++	371	0.7+0.8+1.4+1.4+1.4
	2.0+2.5+4.2+4.2+5.0	1140	10.9	9.00	8.50	A+++	371	0.7+0.8+1.4+1.4+1.5
	2.0+3.5+3.5+3.5+3.5	1130	10.8	9.00	8.50	A+++	371	0.7+1.3+1.3+1.3+1.3
	2.0+3.5+3.5+3.5+4.2	1130	10.8	9.00	8.50	A+++	371	0.7+1.2+1.2+1.2+1.5
	2.0+3.5+3.5+3.5+5.0	1140	10.9	9.00	8.50	A+++	371	0.7+1.2+1.2+1.2+1.6
	2.0+3.5+3.5+4.2+4.2	1130	10.8	9.00	8.50	A+++	371	0.7+1.2+1.2+1.4+1.4
	2.0+3.5+3.5+4.2+5.0	1140	10.9	9.00	8.50	A+++	371	0.7+1.1+1.1+1.3+1.5
	2.0+3.5+4.2+4.2+4.2	1130	10.8	9.00	8.50	A+++	371	0.7+1.1+1.4+1.4+1.4
	2.5+2.5+2.5+2.5+2.5	1150	11.0	9.00	8.50	A+++	371	1.2+1.2+1.2+1.2+1.2
	2.5+2.5+2.5+2.5+3.5	1155	11.1	9.00	8.50	A+++	371	1.1+1.1+1.1+1.1+1.5
2.5+2.5+2.5+2.5+4.2	1155	11.1	9.00	8.50	A+++	371	1.0+1.0+1.0+1.0+1.6	
2.5+2.5+2.5+2.5+5.0	1135	10.9	9.00	8.50	A+++	371	1.0+1.0+1.0+1.0+1.7	
2.5+2.5+2.5+2.5+6.0	1135	10.9	9.00	8.50	A+++	371	0.9+0.9+0.9+0.9+1.9	
2.5+2.5+2.5+2.5+7.1	1135	10.9	9.00	8.50	A+++	371	0.8+0.8+0.8+0.8+2.2	
2.5+2.5+2.5+3.5+3.5	1155	11.1	8.99	8.50	A+++	370	1.0+1.0+1.0+1.4+1.4	
2.5+2.5+2.5+3.5+4.2	1155	11.1	9.00	8.50	A+++	371	0.9+0.9+0.9+1.3+1.5	
2.5+2.5+2.5+3.5+5.0	1135	10.9	9.00	8.50	A+++	371	0.9+0.9+0.9+1.3+1.6	
2.5+2.5+2.5+3.5+6.0	1135	10.9	9.00	8.50	A+++	371	0.8+0.8+0.8+1.2+1.8	

Indoor unit capacity Cooling		Total	Cooling Capacity (kW)							Input Power (W)		EER	
			Room A	Room B	Room C	Room D	Room E	Total	min ~ max	Rating	min ~ max	WW	CLASS
5 Room	2.5 + 2.5 + 2.5 + 3.5 + 7.1	18.1	1.24	1.24	1.24	1.74	3.54	9.00	2.9 ~ 11.5	2280	580 ~ 3390	3.95	A
	2.5 + 2.5 + 2.5 + 4.2 + 4.2	15.9	1.42	1.42	1.42	2.37	2.37	9.00	2.9 ~ 11.5	2310	490 ~ 3520	3.90	A
	2.5 + 2.5 + 2.5 + 4.2 + 5.0	16.7	1.35	1.35	1.35	2.26	2.69	9.00	2.9 ~ 11.5	2270	570 ~ 3380	3.96	A
	2.5 + 2.5 + 2.5 + 4.2 + 6.0	17.7	1.27	1.27	1.27	2.14	3.05	9.00	2.9 ~ 11.5	2270	570 ~ 3380	3.96	A
	2.5 + 2.5 + 2.5 + 5.0 + 5.0	17.5	1.29	1.29	1.29	2.56	2.56	8.99	2.9 ~ 11.5	2360	660 ~ 3330	3.81	A
	2.5 + 2.5 + 3.5 + 3.5 + 3.5	15.5	1.45	1.45	2.03	2.03	2.03	8.99	2.9 ~ 11.5	2250	490 ~ 3440	4.00	A
	2.5 + 2.5 + 3.5 + 3.5 + 4.2	16.2	1.39	1.39	1.94	1.94	2.34	9.00	2.9 ~ 11.5	2250	500 ~ 3440	4.00	A
	2.5 + 2.5 + 3.5 + 3.5 + 5.0	17.0	1.32	1.32	1.85	1.85	2.66	9.00	2.9 ~ 11.5	2280	580 ~ 3390	3.95	A
	2.5 + 2.5 + 3.5 + 3.5 + 6.0	18.0	1.25	1.25	1.75	1.75	3.00	9.00	2.9 ~ 11.5	2280	580 ~ 3390	3.95	A
	2.5 + 2.5 + 3.5 + 4.2 + 4.2	16.9	1.33	1.33	1.86	2.24	2.24	9.00	2.9 ~ 11.5	2250	520 ~ 3450	4.00	A
	2.5 + 2.5 + 3.5 + 4.2 + 5.0	17.7	1.27	1.27	1.78	2.14	2.54	9.00	2.9 ~ 11.5	2280	580 ~ 3390	3.95	A
	2.5 + 2.5 + 4.2 + 4.2 + 4.2	17.6	1.27	1.27	2.15	2.15	2.15	8.99	2.9 ~ 11.5	2250	520 ~ 3450	4.00	A
	2.5 + 3.5 + 3.5 + 3.5 + 3.5	16.5	1.36	1.91	1.91	1.91	1.91	9.00	2.9 ~ 11.5	2260	530 ~ 3450	3.98	A
	2.5 + 3.5 + 3.5 + 3.5 + 4.2	17.2	1.31	1.83	1.83	1.83	2.20	9.00	2.9 ~ 11.5	2260	530 ~ 3450	3.98	A
	2.5 + 3.5 + 3.5 + 3.5 + 5.0	18.0	1.25	1.75	1.75	1.75	2.50	9.00	2.9 ~ 11.5	2280	580 ~ 3390	3.95	A
	2.5 + 3.5 + 3.5 + 4.2 + 4.2	17.9	1.26	1.76	1.76	2.11	2.11	9.00	2.9 ~ 11.5	2260	530 ~ 3450	3.98	A
	3.5 + 3.5 + 3.5 + 3.5 + 3.5	17.5	1.80	1.80	1.80	1.80	1.80	9.00	2.9 ~ 11.5	2260	530 ~ 3450	3.98	A
3.5 + 3.5 + 3.5 + 3.5 + 4.2	18.2	1.73	1.73	1.73	1.73	2.08	9.00	2.9 ~ 11.5	2260	530 ~ 3450	3.98	A	

	Indoor unit capacity Cooling	Annual Energy Consumption (kWh)	Current 230V (A)	ERP				Moisture Removal Volume l/h
				Pdesign (kW)	SEER		Annual Consumption (kWh)	
					W/W	CLASS		
5 Room	2.5 + 2.5 + 2.5 + 3.5 + 7.1	1140	10.9	9.00	8.50	A+++	371	0.8 + 0.8 + 0.8 + 1.1 + 2.0
	2.5 + 2.5 + 2.5 + 4.2 + 4.2	1155	11.1	9.00	8.50	A+++	371	0.9 + 0.9 + 0.9 + 1.5 + 1.5
	2.5 + 2.5 + 2.5 + 4.2 + 5.0	1135	10.9	9.00	8.50	A+++	371	0.9 + 0.9 + 0.9 + 1.5 + 1.6
	2.5 + 2.5 + 2.5 + 4.2 + 6.0	1135	10.9	9.00	8.50	A+++	371	0.8 + 0.8 + 0.8 + 1.4 + 1.7
	2.5 + 2.5 + 2.5 + 5.0 + 5.0	1180	11.3	8.99	8.50	A+++	370	0.8 + 0.8 + 0.8 + 1.6 + 1.6
	2.5 + 2.5 + 3.5 + 3.5 + 3.5	1125	10.8	8.99	8.50	A+++	370	0.9 + 0.9 + 1.3 + 1.3 + 1.3
	2.5 + 2.5 + 3.5 + 3.5 + 4.2	1125	10.8	9.00	8.50	A+++	371	0.9 + 0.9 + 1.3 + 1.3 + 1.5
	2.5 + 2.5 + 3.5 + 3.5 + 5.0	1140	10.9	9.00	8.50	A+++	371	0.8 + 0.8 + 1.2 + 1.2 + 1.6
	2.5 + 2.5 + 3.5 + 3.5 + 6.0	1140	10.9	9.00	8.50	A+++	371	0.8 + 0.8 + 1.1 + 1.1 + 1.7
	2.5 + 2.5 + 3.5 + 4.2 + 4.2	1125	10.8	9.00	8.50	A+++	371	0.8 + 0.8 + 1.2 + 1.5 + 1.5
	2.5 + 2.5 + 3.5 + 4.2 + 5.0	1140	10.9	9.00	8.50	A+++	371	0.8 + 0.8 + 1.1 + 1.4 + 1.6
	2.5 + 2.5 + 4.2 + 4.2 + 4.2	1125	10.8	8.99	8.50	A+++	370	0.8 + 0.8 + 1.4 + 1.4 + 1.4
	2.5 + 3.5 + 3.5 + 3.5 + 3.5	1130	10.8	9.00	8.50	A+++	371	0.9 + 1.2 + 1.2 + 1.2 + 1.2
	2.5 + 3.5 + 3.5 + 3.5 + 4.2	1130	10.8	9.00	8.50	A+++	371	0.8 + 1.2 + 1.2 + 1.2 + 1.4
	2.5 + 3.5 + 3.5 + 3.5 + 5.0	1140	10.9	9.00	8.50	A+++	371	0.8 + 1.1 + 1.1 + 1.1 + 1.5
	2.5 + 3.5 + 3.5 + 4.2 + 4.2	1130	10.8	9.00	8.50	A+++	371	0.8 + 1.1 + 1.1 + 1.4 + 1.4
	3.5 + 3.5 + 3.5 + 3.5 + 3.5	1130	10.8	9.00	8.50	A+++	371	1.2 + 1.2 + 1.2 + 1.2 + 1.2
	3.5 + 3.5 + 3.5 + 3.5 + 4.2	1130	10.8	9.00	8.50	A+++	371	1.1 + 1.1 + 1.1 + 1.1 + 1.3

- Indoor Unit : Combination of all wall mount series (CS-MZ / Z / XZ / MTZ / TZ / TE)
- Outdoor Unit : CU-5Z90TBE

	Indoor unit capacity Heating	Total	Heating Capacity (kW)						Input Power (W)		COP		
			Room A	Room B	Room C	Room D	Room E	Total	min ~ max	Rating	min ~ max	W/W	CLASS
1 Room	1.6	1.6	2.60					2.60	1.2 ~ 3.2	680	300 ~ 1000	3.82	A
	2.0	2.0	3.20					3.20	1.2 ~ 4.1	780	300 ~ 1270	4.10	A
	2.5	2.5	3.60					3.60	1.2 ~ 4.3	980	300 ~ 1270	3.67	A
	3.5	3.5	4.50					4.50	1.2 ~ 5.8	1270	300 ~ 2140	3.54	B
	4.2	4.2	5.60					5.60	1.2 ~ 6.8	1760	300 ~ 2970	3.18	D
	5.0	5.0	6.80					6.80	1.2 ~ 6.9	2140	300 ~ 2560	3.18	D
	6.0	6.0	8.50					8.50	1.3 ~ 9.0	2440	620 ~ 2590	3.48	B
	7.1	7.1	8.70					8.70	1.4 ~ 9.2	2590	680 ~ 2760	3.36	C
2 Room	1.6 + 1.6	3.2	2.35	2.35				4.70	2.0 ~ 8.2	1290	220 ~ 2490	3.64	A
	1.6 + 2.0	3.6	2.31	2.89				5.20	2.0 ~ 8.2	1450	220 ~ 2480	3.59	B
	1.6 + 2.5	4.1	2.19	3.41				5.60	2.0 ~ 8.2	1580	220 ~ 2480	3.54	B
	1.6 + 3.5	5.1	2.01	4.39				6.40	2.0 ~ 8.6	1770	210 ~ 2560	3.62	A
	1.6 + 4.2	5.8	2.04	5.36				7.40	2.0 ~ 10.1	2070	210 ~ 3110	3.57	B
	1.6 + 5.0	6.6	2.06	6.44				8.50	2.0 ~ 11.0	2280	160 ~ 3120	3.73	A
	1.6 + 6.0	7.6	2.11	7.89				10.00	2.0 ~ 11.0	2750	160 ~ 3120	3.64	A
	1.6 + 7.1	8.7	1.88	8.32				10.20	2.0 ~ 13.0	2750	160 ~ 3910	3.71	A
	2.0 + 2.0	4.0	2.90	2.90				5.80	2.0 ~ 8.2	1610	220 ~ 2470	3.60	A
	2.0 + 2.5	4.5	2.71	3.39				6.10	2.0 ~ 8.2	1700	220 ~ 2470	3.59	B
	2.0 + 3.5	5.5	2.51	4.39				6.90	2.0 ~ 8.6	1890	210 ~ 2500	3.65	A
	2.0 + 4.2	6.2	2.55	5.35				7.90	2.0 ~ 11.0	2240	200 ~ 3310	3.53	B
	2.0 + 5.0	7.0	2.57	6.43				9.00	2.0 ~ 11.0	2340	160 ~ 3060	3.85	A
	2.0 + 6.0	8.0	2.60	7.80				10.40	2.0 ~ 11.9	2760	160 ~ 3410	3.77	A
	2.0 + 7.1	9.1	2.29	8.11				10.40	2.0 ~ 13.0	2700	160 ~ 3900	3.85	A
	2.5 + 2.5	5.0	3.25	3.25				6.50	2.0 ~ 8.6	1780	220 ~ 2580	3.65	A
	2.5 + 3.5	6.0	3.04	4.26				7.30	2.0 ~ 10.1	2020	210 ~ 3110	3.61	A
	2.5 + 4.2	6.7	3.10	5.20				8.30	2.0 ~ 11.0	2380	200 ~ 3310	3.49	B
	2.5 + 5.0	7.5	3.13	6.27				9.40	2.0 ~ 11.0	2530	160 ~ 3060	3.72	A
	2.5 + 6.0	8.5	3.06	7.34				10.40	2.0 ~ 13.0	2760	160 ~ 3910	3.77	A
	2.5 + 7.1	9.6	2.71	7.69				10.40	2.0 ~ 13.0	2700	160 ~ 3900	3.85	A
	3.5 + 3.5	7.0	4.05	4.05				8.10	2.0 ~ 11.0	2270	200 ~ 3300	3.57	B
	3.5 + 4.2	7.7	4.14	4.96				9.10	2.0 ~ 11.0	2570	200 ~ 3240	3.54	B
	3.5 + 5.0	8.5	4.20	6.00				10.20	2.0 ~ 13.0	2670	160 ~ 3890	3.82	A
	3.5 + 6.0	9.5	3.83	6.57				10.40	2.0 ~ 13.0	2690	160 ~ 3890	3.87	A
	3.5 + 7.1	10.6	3.43	6.97				10.40	2.0 ~ 13.8	2670	160 ~ 4220	3.90	A
	4.2 + 4.2	8.4	5.05	5.05				10.10	2.0 ~ 13.0	2870	190 ~ 4070	3.52	B
4.2 + 5.0	9.2	4.75	5.65				10.40	2.0 ~ 13.0	2680	160 ~ 3820	3.88	A	
4.2 + 6.0	10.2	4.28	6.12				10.40	2.0 ~ 13.8	2680	160 ~ 4230	3.88	A	
4.2 + 7.1	11.3	3.87	6.53				10.40	2.0 ~ 13.8	2660	160 ~ 4210	3.91	A	
5.0 + 5.0	10.0	5.20	5.20				10.40	2.0 ~ 13.8	2510	170 ~ 3980	4.14	A	
5.0 + 6.0	11.0	4.73	5.67				10.40	2.0 ~ 13.8	2510	170 ~ 3980	4.14	A	
5.0 + 7.1	12.1	4.30	6.10				10.40	2.0 ~ 13.8	2490	170 ~ 3970	4.18	A	
6.0 + 6.0	12.0	5.20	5.20				10.40	2.0 ~ 13.8	2510	170 ~ 3980	4.14	A	
6.0 + 7.1	13.1	4.76	5.64				10.40	2.0 ~ 13.8	2490	170 ~ 3970	4.18	A	
7.1 + 7.1	14.2	5.20	5.20				10.40	2.0 ~ 13.8	2430	180 ~ 3950	4.28	A	



	Indoor unit capacity Heating	Annual Energy Consumption (kWh)	Current 230V (A)	ERP				Moisture Removal Volume l/h
				Pdesign (kW)	SCOP		Annual Consumption (kWh)	
					W/W	CLASS		
1 Room	1.6	340	3.3	-	-	-	-	
	2.0	390	3.8	-	-	-	-	
	2.5	490	4.9	-	-	-	-	
	3.5	635	6.2	-	-	-	-	
	4.2	880	8.1	-	-	-	-	
	5.0	1070	9.9	-	-	-	-	
	6.0	1220	11.3	-	-	-	-	
	7.1	1295	11.9	-	-	-	-	
2 Room	1.6 + 1.6	645	6.1	4.50	3.80	A	1658	
	1.6 + 2.0	725	6.9	4.50	3.80	A	1658	
	1.6 + 2.5	790	7.5	4.50	3.80	A	1658	
	1.6 + 3.5	885	8.3	5.50	3.80	A	2026	
	1.6 + 4.2	1035	9.7	5.50	3.80	A	2026	
	1.6 + 5.0	1140	10.7	6.50	4.00	A+	2275	
	1.6 + 6.0	1375	12.9	6.50	4.00	A+	2275	
	1.6 + 7.1	1375	12.9	6.50	4.00	A+	2275	
	2.0 + 2.0	805	7.6	4.50	3.80	A	1658	
	2.0 + 2.5	850	8.1	4.50	3.80	A	1658	
	2.0 + 3.5	945	8.9	5.50	3.80	A	2026	
	2.0 + 4.2	1120	10.5	5.50	3.80	A	2026	
	2.0 + 5.0	1170	11.0	6.50	4.00	A+	2275	
	2.0 + 6.0	1380	13.0	6.50	4.00	A+	2275	
	2.0 + 7.1	1350	12.7	6.50	4.00	A+	2275	
	2.5 + 2.5	890	8.4	4.50	3.80	A	1658	
	2.5 + 3.5	1010	9.5	5.50	3.80	A	2026	
	2.5 + 4.2	1190	11.2	5.50	3.80	A	2026	
	2.5 + 5.0	1265	11.9	6.50	4.00	A+	2275	
	2.5 + 6.0	1380	13.0	6.50	4.00	A+	2275	
	2.5 + 7.1	1350	12.7	6.50	4.00	A+	2275	
	3.5 + 3.5	1135	10.7	5.50	3.80	A	2026	
	3.5 + 4.2	1285	12.1	5.50	3.80	A	2026	
	3.5 + 5.0	1335	12.5	6.50	4.00	A+	2275	
	3.5 + 6.0	1345	12.6	6.50	4.00	A+	2275	
	3.5 + 7.1	1335	12.5	6.50	4.00	A+	2275	
	4.2 + 4.2	1435	13.5	5.50	3.80	A	2026	
4.2 + 5.0	1340	12.6	6.50	4.00	A+	2275		
4.2 + 6.0	1340	12.6	6.50	4.00	A+	2275		
4.2 + 7.1	1330	12.5	6.50	4.00	A+	2275		
5.0 + 5.0	1255	11.8	8.50	4.00	A+	2975		
5.0 + 6.0	1255	11.8	8.50	4.00	A+	2975		
5.0 + 7.1	1245	11.7	8.50	4.00	A+	2975		
6.0 + 6.0	1255	11.8	8.50	4.00	A+	2975		
6.0 + 7.1	1245	11.7	8.50	4.00	A+	2975		
7.1 + 7.1	1215	11.4	8.50	4.00	A+	2975		

	Indoor unit capacity Heating	Total	Heating Capacity (kW)						Input Power (W)		COP		
			Room A	Room B	Room C	Room D	Room E	Total	min ~ max	Rating	min ~ max	WW	CLASS
3 Room	1.6 + 1.6 + 1.6	4.8	2.33	2.33	2.33			6.99	2.7 ~ 12.3	1660	230 ~ 3500	4.21	A
	1.6 + 1.6 + 2.0	5.2	2.34	2.34	2.92			7.60	2.7 ~ 12.3	1860	230 ~ 3490	4.09	A
	1.6 + 1.6 + 2.5	5.7	2.22	2.22	3.46			7.90	2.7 ~ 12.3	1950	230 ~ 3490	4.05	A
	1.6 + 1.6 + 3.5	6.7	2.08	2.08	4.54			8.70	2.7 ~ 12.3	2140	230 ~ 3400	4.07	A
	1.6 + 1.6 + 4.2	7.4	2.10	2.10	5.50			9.70	2.7 ~ 12.3	2510	230 ~ 3390	3.86	A
	1.6 + 1.6 + 5.0	8.2	2.03	2.03	6.34			10.40	2.7 ~ 12.9	2430	250 ~ 3480	4.28	A
	1.6 + 1.6 + 6.0	9.2	1.81	1.81	6.78			10.40	2.7 ~ 13.6	2430	250 ~ 3820	4.28	A
	1.6 + 1.6 + 7.1	10.3	1.62	1.62	7.16			10.40	2.7 ~ 13.6	2420	250 ~ 3740	4.30	A
	1.6 + 2.0 + 2.0	5.6	2.32	2.89	2.89			8.10	2.7 ~ 12.3	1990	230 ~ 3480	4.07	A
	1.6 + 2.0 + 2.5	6.1	2.23	2.79	3.48			8.50	2.7 ~ 12.3	2170	230 ~ 3480	3.92	A
	1.6 + 2.0 + 3.5	7.1	2.10	2.62	4.58			9.30	2.7 ~ 12.3	2320	230 ~ 3390	4.01	A
	1.6 + 2.0 + 4.2	7.8	2.11	2.64	5.55			10.30	2.7 ~ 12.9	2540	230 ~ 3660	4.06	A
	1.6 + 2.0 + 5.0	8.6	1.93	2.42	6.05			10.40	2.7 ~ 13.6	2420	250 ~ 3750	4.30	A
	1.6 + 2.0 + 6.0	9.6	1.73	2.17	6.50			10.40	2.7 ~ 13.6	2420	250 ~ 3750	4.30	A
	1.6 + 2.0 + 7.1	10.7	1.56	1.94	6.90			10.40	2.7 ~ 13.8	2410	250 ~ 3850	4.32	A
	1.6 + 2.5 + 2.5	6.6	2.14	3.33	3.33			8.80	2.7 ~ 12.3	2200	230 ~ 3480	4.00	A
	1.6 + 2.5 + 3.5	7.6	2.02	3.16	4.42			9.60	2.7 ~ 12.3	2460	230 ~ 3390	3.90	A
	1.6 + 2.5 + 4.2	8.3	2.00	3.13	5.27			10.40	2.7 ~ 12.9	2580	230 ~ 3660	4.03	A
	1.6 + 2.5 + 5.0	9.1	1.83	2.86	5.71			10.40	2.7 ~ 13.6	2420	250 ~ 3750	4.30	A
	1.6 + 2.5 + 6.0	10.1	1.65	2.57	6.18			10.40	2.7 ~ 13.6	2420	250 ~ 3750	4.30	A
	1.6 + 2.5 + 7.1	11.2	1.49	2.32	6.59			10.40	2.7 ~ 13.8	2410	250 ~ 3850	4.32	A
	1.6 + 3.5 + 3.5	8.6	1.94	4.23	4.23			10.40	2.7 ~ 13.6	2570	230 ~ 3980	4.05	A
	1.6 + 3.5 + 4.2	9.3	1.79	3.91	4.70			10.40	2.7 ~ 13.6	2550	240 ~ 3970	4.08	A
	1.6 + 3.5 + 5.0	10.1	1.65	3.60	5.15			10.40	2.7 ~ 13.6	2390	250 ~ 3710	4.35	A
	1.6 + 3.5 + 6.0	11.1	1.50	3.28	5.62			10.40	2.7 ~ 13.8	2390	250 ~ 3830	4.35	A
	1.6 + 3.5 + 7.1	12.2	1.36	2.98	6.06			10.40	2.7 ~ 13.8	2380	270 ~ 3810	4.37	A
	1.6 + 4.2 + 4.2	10.0	1.66	4.37	4.37			10.40	2.7 ~ 13.6	2540	240 ~ 3900	4.09	A
	1.6 + 4.2 + 5.0	10.8	1.54	4.04	4.82			10.40	2.7 ~ 13.8	2380	270 ~ 3820	4.37	A
	1.6 + 4.2 + 6.0	11.8	1.41	3.70	5.29			10.40	2.7 ~ 13.8	2380	270 ~ 3820	4.37	A
	1.6 + 4.2 + 7.1	12.9	1.29	3.39	5.72			10.40	2.7 ~ 14.1	2370	270 ~ 3920	4.39	A
	1.6 + 5.0 + 5.0	11.6	1.44	4.48	4.48			10.40	2.7 ~ 13.8	2290	300 ~ 3620	4.54	A
	1.6 + 5.0 + 6.0	12.6	1.32	4.13	4.95			10.40	2.7 ~ 13.8	2290	300 ~ 3620	4.54	A
	1.6 + 5.0 + 7.1	13.7	1.21	3.80	5.39			10.40	2.7 ~ 14.1	2280	310 ~ 3770	4.56	A
	1.6 + 6.0 + 6.0	13.6	1.22	4.59	4.59			10.40	2.7 ~ 14.1	2290	300 ~ 3790	4.54	A
	1.6 + 6.0 + 7.1	14.7	1.13	4.24	5.03			10.40	2.7 ~ 14.1	2280	310 ~ 3770	4.56	A
	1.6 + 7.1 + 7.1	15.8	1.06	4.67	4.67			10.40	2.7 ~ 14.4	2310	320 ~ 3870	4.50	A
	2.0 + 2.0 + 2.0	6.0	2.86	2.86	2.86			8.58	2.7 ~ 12.3	2100	230 ~ 3470	4.09	A
	2.0 + 2.0 + 2.5	6.5	2.77	2.77	3.46			9.00	2.7 ~ 12.3	2240	230 ~ 3470	4.02	A
	2.0 + 2.0 + 3.5	7.5	2.61	2.61	4.58			9.80	2.7 ~ 12.3	2500	230 ~ 3380	3.92	A
	2.0 + 2.0 + 4.2	8.2	2.54	2.54	5.32			10.40	2.7 ~ 12.9	2570	230 ~ 3650	4.05	A
	2.0 + 2.0 + 5.0	9.0	2.31	2.31	5.78			10.40	2.7 ~ 13.6	2410	250 ~ 3740	4.32	A
	2.0 + 2.0 + 6.0	10.0	2.08	2.08	6.24			10.40	2.7 ~ 13.6	2410	250 ~ 3740	4.32	A
2.0 + 2.0 + 7.1	11.1	1.87	1.87	6.66			10.40	2.7 ~ 13.8	2400	250 ~ 3830	4.33	A	
2.0 + 2.5 + 2.5	7.0	2.68	3.36	3.36			9.40	2.7 ~ 12.3	2380	230 ~ 3470	3.95	A	
2.0 + 2.5 + 3.5	8.0	2.55	3.19	4.46			10.20	2.7 ~ 12.9	2570	230 ~ 3660	3.97	A	
2.0 + 2.5 + 4.2	8.7	2.39	2.99	5.02			10.40	2.7 ~ 13.6	2570	230 ~ 3990	4.05	A	
2.0 + 2.5 + 5.0	9.5	2.19	2.74	5.47			10.40	2.7 ~ 13.6	2410	250 ~ 3740	4.32	A	
2.0 + 2.5 + 6.0	10.5	1.98	2.48	5.94			10.40	2.7 ~ 13.8	2410	250 ~ 3850	4.32	A	
2.0 + 2.5 + 7.1	11.6	1.79	2.24	6.37			10.40	2.7 ~ 13.8	2400	250 ~ 3830	4.33	A	
2.0 + 3.5 + 3.5	9.0	2.32	4.04	4.04			10.40	2.7 ~ 13.6	2550	240 ~ 3970	4.08	A	
2.0 + 3.5 + 4.2	9.7	2.14	3.75	4.51			10.40	2.7 ~ 13.6	2540	240 ~ 3900	4.09	A	
2.0 + 3.5 + 5.0	10.5	1.98	3.47	4.95			10.40	2.7 ~ 13.8	2380	270 ~ 3820	4.37	A	
2.0 + 3.5 + 6.0	11.5	1.81	3.17	5.42			10.40	2.7 ~ 13.8	2380	270 ~ 3820	4.37	A	
2.0 + 3.5 + 7.1	12.6	1.65	2.89	5.86			10.40	2.7 ~ 13.8	2370	270 ~ 3800	4.39	A	
2.0 + 4.2 + 4.2	10.4	2.00	4.20	4.20			10.40	2.7 ~ 13.6	2530	240 ~ 3890	4.11	A	
2.0 + 4.2 + 5.0	11.2	1.86	3.90	4.64			10.40	2.7 ~ 13.8	2380	270 ~ 3800	4.37	A	
2.0 + 4.2 + 6.0	12.2	1.70	3.58	5.12			10.40	2.7 ~ 13.8	2380	270 ~ 3800	4.37	A	
2.0 + 4.2 + 7.1	13.3	1.56	3.28	5.56			10.40	2.7 ~ 14.1	2360	270 ~ 3900	4.41	A	

	Indoor unit capacity Heating	Annual Energy Consumption (kWh)	Current 230V (A)	ERP			Moisture Removal Volume l/h	
				Pdesign (kW)	SCOP			Annual Consumption (kWh)
					W/W	CLASS		
3 Room	1.6 + 1.6 + 1.6	830	7.9	6.50	4.00	A+	2275	
	1.6 + 1.6 + 2.0	930	8.7	6.50	4.00	A+	2275	
	1.6 + 1.6 + 2.5	975	9.2	6.50	4.00	A+	2275	
	1.6 + 1.6 + 3.5	1070	10.1	7.50	4.10	A+	2561	
	1.6 + 1.6 + 4.2	1255	11.8	7.50	4.10	A+	2561	
	1.6 + 1.6 + 5.0	1215	11.4	7.50	4.10	A+	2561	
	1.6 + 1.6 + 6.0	1215	11.4	8.50	4.20	A+	2833	
	1.6 + 1.6 + 7.1	1210	11.4	8.50	4.20	A+	2833	
	1.6 + 2.0 + 2.0	995	9.4	6.50	4.00	A+	2275	
	1.6 + 2.0 + 2.5	1085	10.2	7.50	4.10	A+	2561	
	1.6 + 2.0 + 3.5	1160	10.9	7.50	4.10	A+	2561	
	1.6 + 2.0 + 4.2	1270	11.9	7.50	4.10	A+	2561	
	1.6 + 2.0 + 5.0	1210	11.4	8.50	4.20	A+	2833	
	1.6 + 2.0 + 6.0	1210	11.4	8.50	4.20	A+	2833	
	1.6 + 2.0 + 7.1	1205	11.3	8.50	4.20	A+	2833	
	1.6 + 2.5 + 2.5	1100	10.3	7.50	4.10	A+	2561	
	1.6 + 2.5 + 3.5	1230	11.6	7.50	4.10	A+	2561	
	1.6 + 2.5 + 4.2	1290	12.1	7.50	4.10	A+	2561	
	1.6 + 2.5 + 5.0	1210	11.4	8.50	4.20	A+	2833	
	1.6 + 2.5 + 6.0	1210	11.4	8.50	4.20	A+	2833	
	1.6 + 2.5 + 7.1	1205	11.3	8.50	4.20	A+	2833	
	1.6 + 3.5 + 3.5	1285	12.1	8.50	4.20	A+	2833	
	1.6 + 3.5 + 4.2	1275	12.0	8.50	4.20	A+	2833	
	1.6 + 3.5 + 5.0	1195	11.2	8.50	4.20	A+	2833	
	1.6 + 3.5 + 6.0	1195	11.2	8.50	4.20	A+	2833	
	1.6 + 3.5 + 7.1	1190	11.2	8.50	4.20	A+	2833	
	1.6 + 4.2 + 4.2	1270	11.9	8.50	4.20	A+	2833	
	1.6 + 4.2 + 5.0	1190	11.2	8.50	4.20	A+	2833	
	1.6 + 4.2 + 6.0	1190	11.2	8.50	4.20	A+	2833	
	1.6 + 4.2 + 7.1	1185	11.1	8.50	4.20	A+	2833	
	1.6 + 5.0 + 5.0	1145	10.8	8.50	4.20	A+	2833	
	1.6 + 5.0 + 6.0	1145	10.8	8.50	4.20	A+	2833	
	1.6 + 5.0 + 7.1	1140	10.7	8.50	4.20	A+	2833	
	1.6 + 6.0 + 6.0	1145	10.8	8.50	4.20	A+	2833	
	1.6 + 6.0 + 7.1	1140	10.7	8.50	4.20	A+	2833	
	1.6 + 7.1 + 7.1	1155	10.9	8.50	4.20	A+	2833	
	2.0 + 2.0 + 2.0	1050	9.9	7.50	4.10	A+	2561	
	2.0 + 2.0 + 2.5	1120	10.5	7.50	4.10	A+	2561	
	2.0 + 2.0 + 3.5	1250	11.7	7.50	4.10	A+	2561	
	2.0 + 2.0 + 4.2	1285	12.1	7.50	4.10	A+	2561	
2.0 + 2.0 + 5.0	1205	11.3	8.50	4.20	A+	2833		
2.0 + 2.0 + 6.0	1205	11.3	8.50	4.20	A+	2833		
2.0 + 2.0 + 7.1	1200	11.3	8.50	4.20	A+	2833		
2.0 + 2.5 + 2.5	1190	11.2	7.50	4.10	A+	2561		
2.0 + 2.5 + 3.5	1285	12.1	7.50	4.10	A+	2561		
2.0 + 2.5 + 4.2	1285	12.1	8.50	4.20	A+	2833		
2.0 + 2.5 + 5.0	1205	11.3	8.50	4.20	A+	2833		
2.0 + 2.5 + 6.0	1205	11.3	8.50	4.20	A+	2833		
2.0 + 2.5 + 7.1	1200	11.3	8.50	4.20	A+	2833		
2.0 + 3.5 + 3.5	1275	12.0	8.50	4.20	A+	2833		
2.0 + 3.5 + 4.2	1270	11.9	8.50	4.20	A+	2833		
2.0 + 3.5 + 5.0	1190	11.2	8.50	4.20	A+	2833		
2.0 + 3.5 + 6.0	1190	11.2	8.50	4.20	A+	2833		
2.0 + 3.5 + 7.1	1185	11.1	8.50	4.20	A+	2833		
2.0 + 4.2 + 4.2	1265	11.9	8.50	4.20	A+	2833		
2.0 + 4.2 + 5.0	1190	11.2	8.50	4.20	A+	2833		
2.0 + 4.2 + 6.0	1190	11.2	8.50	4.20	A+	2833		
2.0 + 4.2 + 7.1	1180	11.1	8.50	4.20	A+	2833		

Indoor unit capacity Heating	Total	Heating Capacity (kW)							Input Power (W)		COP	
		Room A	Room B	Room C	Room D	Room E	Total	min ~ max	Rating	min ~ max	WW	CLASS
2.0 + 5.0 + 5.0	12.0	1.74	4.33	4.33			10.40	2.7 ~ 13.8	2280	310 ~ 3600	4.56	A
2.0 + 5.0 + 6.0	13.0	1.60	4.00	4.80			10.40	2.7 ~ 14.1	2280	310 ~ 3770	4.56	A
2.0 + 5.0 + 7.1	14.1	1.48	3.69	5.23			10.40	2.7 ~ 14.1	2310	320 ~ 3760	4.50	A
2.0 + 6.0 + 6.0	14.0	1.48	4.46	4.46			10.40	2.7 ~ 14.1	2280	310 ~ 3770	4.56	A
2.0 + 6.0 + 7.1	15.1	1.38	4.13	4.89			10.40	2.7 ~ 14.4	2310	320 ~ 3870	4.50	A
2.0 + 7.1 + 7.1	16.2	1.28	4.56	4.56			10.40	2.7 ~ 14.4	2300	330 ~ 3860	4.52	A
2.5 + 2.5 + 2.5	7.5	3.23	3.23	3.23			9.69	2.7 ~ 12.3	2530	230 ~ 3470	3.83	A
2.5 + 2.5 + 3.5	8.5	3.06	3.06	4.28			10.40	2.7 ~ 13.6	2580	230 ~ 4010	4.03	A
2.5 + 2.5 + 4.2	9.2	2.83	2.83	4.74			10.40	2.7 ~ 13.6	2570	230 ~ 3990	4.05	A
2.5 + 2.5 + 5.0	10.0	2.60	2.60	5.20			10.40	2.7 ~ 13.6	2410	250 ~ 3740	4.32	A
2.5 + 2.5 + 6.0	11.0	2.36	2.36	5.68			10.40	2.7 ~ 13.8	2410	250 ~ 3850	4.32	A
2.5 + 2.5 + 7.1	12.1	2.15	2.15	6.10			10.40	2.7 ~ 13.8	2400	250 ~ 3830	4.33	A
2.5 + 3.5 + 3.5	9.5	2.74	3.83	3.83			10.40	2.7 ~ 13.6	2550	240 ~ 3970	4.08	A
2.5 + 3.5 + 4.2	10.2	2.55	3.57	4.28			10.40	2.7 ~ 13.6	2540	240 ~ 3900	4.09	A
2.5 + 3.5 + 5.0	11.0	2.36	3.31	4.73			10.40	2.7 ~ 13.8	2380	270 ~ 3820	4.37	A
2.5 + 3.5 + 6.0	12.0	2.17	3.03	5.20			10.40	2.7 ~ 13.8	2380	270 ~ 3820	4.37	A
2.5 + 3.5 + 7.1	13.1	1.98	2.78	5.64			10.40	2.7 ~ 14.1	2370	270 ~ 3920	4.39	A
2.5 + 4.2 + 4.2	10.9	2.38	4.01	4.01			10.40	2.7 ~ 13.8	2530	240 ~ 4010	4.11	A
2.5 + 4.2 + 5.0	11.7	2.22	3.73	4.45			10.40	2.7 ~ 13.8	2380	270 ~ 3800	4.37	A
2.5 + 4.2 + 6.0	12.7	2.05	3.44	4.91			10.40	2.7 ~ 14.1	2380	270 ~ 3920	4.37	A
2.5 + 4.2 + 7.1	13.8	1.88	3.17	5.35			10.40	2.7 ~ 14.1	2360	270 ~ 3900	4.41	A
2.5 + 5.0 + 5.0	12.5	2.08	4.16	4.16			10.40	2.7 ~ 13.8	2280	310 ~ 3600	4.56	A
2.5 + 5.0 + 6.0	13.5	1.93	3.85	4.62			10.40	2.7 ~ 14.1	2280	310 ~ 3770	4.56	A
2.5 + 5.0 + 7.1	14.6	1.78	3.56	5.06			10.40	2.7 ~ 14.1	2310	320 ~ 3760	4.50	A
2.5 + 6.0 + 6.0	14.5	1.80	4.30	4.30			10.40	2.7 ~ 14.1	2280	310 ~ 3770	4.56	A
2.5 + 6.0 + 7.1	15.6	1.67	4.00	4.73			10.40	2.7 ~ 14.4	2310	320 ~ 3870	4.50	A
2.5 + 7.1 + 7.1	16.7	1.56	4.42	4.42			10.40	2.7 ~ 14.4	2300	330 ~ 3860	4.52	A
3.5 + 3.5 + 3.5	10.5	3.46	3.46	3.46			10.38	2.7 ~ 13.8	2480	240 ~ 4000	4.19	A
3.5 + 3.5 + 4.2	11.2	3.25	3.25	3.90			10.40	2.7 ~ 13.8	2470	240 ~ 3990	4.21	A
3.5 + 3.5 + 5.0	12.0	3.03	3.03	4.34			10.40	2.7 ~ 13.8	2360	270 ~ 3780	4.41	A
3.5 + 3.5 + 6.0	13.0	2.80	2.80	4.80			10.40	2.7 ~ 14.1	2360	270 ~ 3900	4.41	A
3.5 + 3.5 + 7.1	14.1	2.58	2.58	5.24			10.40	2.7 ~ 14.1	2350	270 ~ 3880	4.43	A
3.5 + 4.2 + 4.2	11.9	3.06	3.67	3.67			10.40	2.7 ~ 13.8	2460	250 ~ 3970	4.23	A
3.5 + 4.2 + 5.0	12.7	2.87	3.44	4.09			10.40	2.7 ~ 14.1	2350	270 ~ 3890	4.43	A
3.5 + 4.2 + 6.0	13.7	2.66	3.19	4.55			10.40	2.7 ~ 14.1	2350	270 ~ 3890	4.43	A
3.5 + 4.2 + 7.1	14.8	2.46	2.95	4.99			10.40	2.7 ~ 14.1	2340	280 ~ 3870	4.44	A
3.5 + 5.0 + 5.0	13.5	2.70	3.85	3.85			10.40	2.7 ~ 14.1	2300	330 ~ 3740	4.52	A
3.5 + 5.0 + 6.0	14.5	2.51	3.59	4.30			10.40	2.7 ~ 14.1	2300	330 ~ 3740	4.52	A
3.5 + 5.0 + 7.1	15.6	2.33	3.33	4.74			10.40	2.7 ~ 14.4	2290	330 ~ 3840	4.54	A
3.5 + 6.0 + 6.0	15.5	2.34	4.03	4.03			10.40	2.7 ~ 14.4	2300	330 ~ 3860	4.52	A
3.5 + 6.0 + 7.1	16.6	2.19	3.76	4.45			10.40	2.7 ~ 14.4	2290	330 ~ 3840	4.54	A
3.5 + 7.1 + 7.1	17.7	2.06	4.17	4.17			10.40	2.7 ~ 14.4	2280	340 ~ 3820	4.56	A
4.2 + 4.2 + 4.2	12.6	3.46	3.46	3.46			10.38	2.7 ~ 13.8	2450	250 ~ 3900	4.24	A
4.2 + 4.2 + 5.0	13.4	3.26	3.26	3.88			10.40	2.7 ~ 14.1	2340	280 ~ 3870	4.44	A
4.2 + 4.2 + 6.0	14.4	3.03	3.03	4.34			10.40	2.7 ~ 14.1	2340	280 ~ 3870	4.44	A
4.2 + 4.2 + 7.1	15.5	2.82	2.82	4.76			10.40	2.7 ~ 14.4	2330	280 ~ 3970	4.46	A
4.2 + 5.0 + 5.0	14.2	3.08	3.66	3.66			10.40	2.7 ~ 14.1	2300	330 ~ 3730	4.52	A
4.2 + 5.0 + 6.0	15.2	2.87	3.42	4.11			10.40	2.7 ~ 14.4	2300	330 ~ 3840	4.52	A
4.2 + 5.0 + 7.1	16.3	2.68	3.19	4.53			10.40	2.7 ~ 14.4	2290	340 ~ 3830	4.54	A
4.2 + 6.0 + 6.0	16.2	2.70	3.85	3.85			10.40	2.7 ~ 14.4	2300	330 ~ 3840	4.52	A
4.2 + 6.0 + 7.1	17.3	2.52	3.61	4.27			10.40	2.7 ~ 14.4	2290	340 ~ 3830	4.54	A
5.0 + 5.0 + 5.0	15.0	3.46	3.46	3.46			10.38	2.7 ~ 14.4	2270	400 ~ 3760	4.57	A
5.0 + 5.0 + 6.0	16.0	3.25	3.25	3.90			10.40	2.7 ~ 14.4	2270	400 ~ 3760	4.58	A
5.0 + 5.0 + 7.1	17.1	3.04	3.04	4.32			10.40	2.7 ~ 14.4	2260	410 ~ 3750	4.60	A
5.0 + 6.0 + 6.0	17.0	3.06	3.67	3.67			10.40	2.7 ~ 14.4	2270	400 ~ 3760	4.58	A
5.0 + 6.0 + 7.1	18.1	2.87	3.45	4.08			10.40	2.7 ~ 14.4	2260	410 ~ 3750	4.60	A
6.0 + 6.0 + 6.0	18.0	3.46	3.46	3.46			10.38	2.7 ~ 14.4	2270	400 ~ 3760	4.57	A

3  
Room

	Indoor unit capacity Heating	Annual Energy Consumption (kWh)	Current 230V (A)	ERP			Moisture Removal Volume l/h	
				Pdesign (kW)	SCOP			Annual Consumption (kWh)
					W/W	CLASS		
3 Room	2.0 + 5.0 + 5.0	1140	10.7	8.50	4.20	A+	2833	
	2.0 + 5.0 + 6.0	1140	10.7	8.50	4.20	A+	2833	
	2.0 + 5.0 + 7.1	1155	10.9	8.50	4.20	A+	2833	
	2.0 + 6.0 + 6.0	1140	10.7	8.50	4.20	A+	2833	
	2.0 + 6.0 + 7.1	1155	10.9	8.50	4.20	A+	2833	
	2.0 + 7.1 + 7.1	1150	10.8	8.50	4.20	A+	2833	
	2.5 + 2.5 + 2.5	1265	11.9	7.50	4.10	A+	2561	
	2.5 + 2.5 + 3.5	1290	12.1	8.50	4.20	A+	2833	
	2.5 + 2.5 + 4.2	1285	12.1	8.50	4.20	A+	2833	
	2.5 + 2.5 + 5.0	1205	11.3	8.50	4.20	A+	2833	
	2.5 + 2.5 + 6.0	1205	11.3	8.50	4.20	A+	2833	
	2.5 + 2.5 + 7.1	1200	11.3	8.50	4.20	A+	2833	
	2.5 + 3.5 + 3.5	1275	12.0	8.50	4.20	A+	2833	
	2.5 + 3.5 + 4.2	1270	11.9	8.50	4.20	A+	2833	
	2.5 + 3.5 + 5.0	1190	11.2	8.50	4.20	A+	2833	
	2.5 + 3.5 + 6.0	1190	11.2	8.50	4.20	A+	2833	
	2.5 + 3.5 + 7.1	1185	11.1	8.50	4.20	A+	2833	
	2.5 + 4.2 + 4.2	1265	11.9	8.50	4.20	A+	2833	
	2.5 + 4.2 + 5.0	1190	11.2	8.50	4.20	A+	2833	
	2.5 + 4.2 + 6.0	1190	11.2	8.50	4.20	A+	2833	
	2.5 + 4.2 + 7.1	1180	11.1	8.50	4.20	A+	2833	
	2.5 + 5.0 + 5.0	1140	10.7	8.50	4.20	A+	2833	
	2.5 + 5.0 + 6.0	1140	10.7	8.50	4.20	A+	2833	
	2.5 + 5.0 + 7.1	1155	10.9	8.50	4.20	A+	2833	
	2.5 + 6.0 + 6.0	1140	10.7	8.50	4.20	A+	2833	
	2.5 + 6.0 + 7.1	1155	10.9	8.50	4.20	A+	2833	
	2.5 + 7.1 + 7.1	1150	10.8	8.50	4.20	A+	2833	
	3.5 + 3.5 + 3.5	1240	11.7	8.50	4.20	A+	2833	
	3.5 + 3.5 + 4.2	1235	11.6	8.50	4.20	A+	2833	
	3.5 + 3.5 + 5.0	1180	11.1	8.50	4.20	A+	2833	
	3.5 + 3.5 + 6.0	1180	11.1	8.50	4.20	A+	2833	
	3.5 + 3.5 + 7.1	1175	11.0	8.50	4.20	A+	2833	
	3.5 + 4.2 + 4.2	1230	11.6	8.50	4.20	A+	2833	
	3.5 + 4.2 + 5.0	1175	11.0	8.50	4.20	A+	2833	
	3.5 + 4.2 + 6.0	1175	11.0	8.50	4.20	A+	2833	
	3.5 + 4.2 + 7.1	1170	11.0	8.50	4.20	A+	2833	
	3.5 + 5.0 + 5.0	1150	10.8	8.50	4.20	A+	2833	
	3.5 + 5.0 + 6.0	1150	10.8	8.50	4.20	A+	2833	
	3.5 + 5.0 + 7.1	1145	10.8	8.50	4.20	A+	2833	
	3.5 + 6.0 + 6.0	1150	10.8	8.50	4.20	A+	2833	
3.5 + 6.0 + 7.1	1145	10.8	8.50	4.20	A+	2833		
3.5 + 7.1 + 7.1	1140	10.7	8.50	4.20	A+	2833		
4.2 + 4.2 + 4.2	1225	11.5	8.50	4.20	A+	2833		
4.2 + 4.2 + 5.0	1170	11.0	8.50	4.20	A+	2833		
4.2 + 4.2 + 6.0	1170	11.0	8.50	4.20	A+	2833		
4.2 + 4.2 + 7.1	1165	10.9	8.50	4.20	A+	2833		
4.2 + 5.0 + 5.0	1150	10.8	8.50	4.20	A+	2833		
4.2 + 5.0 + 6.0	1150	10.8	8.50	4.20	A+	2833		
4.2 + 5.0 + 7.1	1145	10.8	8.50	4.20	A+	2833		
4.2 + 6.0 + 6.0	1150	10.8	8.50	4.20	A+	2833		
4.2 + 6.0 + 7.1	1145	10.8	8.50	4.20	A+	2833		
5.0 + 5.0 + 5.0	1135	10.7	8.50	4.20	A+	2833		
5.0 + 5.0 + 6.0	1135	10.7	8.50	4.20	A+	2833		
5.0 + 5.0 + 7.1	1130	10.6	8.50	4.20	A+	2833		
5.0 + 6.0 + 6.0	1135	10.7	8.50	4.20	A+	2833		
5.0 + 6.0 + 7.1	1130	10.6	8.50	4.20	A+	2833		
6.0 + 6.0 + 6.0	1135	10.7	8.50	4.20	A+	2833		

	Indoor unit capacity Heating	Total	Heating Capacity (kW)						Input Power (W)		COP		
			Room A	Room B	Room C	Room D	Room E	Total	min ~ max	Rating	min ~ max	WW	CLASS
4 Room	1.6 + 1.6 + 1.6 + 1.6	6.4	2.35	2.35	2.35	2.35		9.40	3.4 ~ 14.2	2230	340 ~ 4000	4.22	A
	1.6 + 1.6 + 1.6 + 2.0	6.8	2.33	2.33	2.33	2.91		9.90	3.4 ~ 14.2	2360	340 ~ 3990	4.19	A
	1.6 + 1.6 + 1.6 + 2.5	7.3	2.26	2.26	2.26	3.52		10.30	3.4 ~ 14.2	2350	340 ~ 3990	4.38	A
	1.6 + 1.6 + 1.6 + 3.5	8.3	2.00	2.00	2.00	4.40		10.40	3.4 ~ 14.2	2370	340 ~ 3960	4.39	A
	1.6 + 1.6 + 1.6 + 4.2	9.0	1.85	1.85	1.85	4.85		10.40	3.4 ~ 14.2	2360	340 ~ 3940	4.41	A
	1.6 + 1.6 + 1.6 + 5.0	9.8	1.70	1.70	1.70	5.30		10.40	3.4 ~ 14.2	2320	390 ~ 3800	4.48	A
	1.6 + 1.6 + 1.6 + 6.0	10.8	1.54	1.54	1.54	5.78		10.40	3.4 ~ 14.2	2320	390 ~ 3800	4.48	A
	1.6 + 1.6 + 1.6 + 7.1	11.9	1.40	1.40	1.40	6.20		10.40	3.4 ~ 14.2	2310	400 ~ 3780	4.50	A
	1.6 + 1.6 + 2.0 + 2.0	7.2	2.31	2.31	2.89	2.89		10.40	3.4 ~ 14.2	2390	340 ~ 3980	4.35	A
	1.6 + 1.6 + 2.0 + 2.5	7.7	2.16	2.16	2.70	3.38		10.40	3.4 ~ 14.2	2390	340 ~ 3980	4.35	A
	1.6 + 1.6 + 2.0 + 3.5	8.7	1.91	1.91	2.39	4.19		10.40	3.4 ~ 14.2	2360	340 ~ 3940	4.41	A
	1.6 + 1.6 + 2.0 + 4.2	9.4	1.77	1.77	2.21	4.65		10.40	3.4 ~ 14.2	2360	340 ~ 3930	4.41	A
	1.6 + 1.6 + 2.0 + 5.0	10.2	1.63	1.63	2.04	5.10		10.40	3.4 ~ 14.2	2310	400 ~ 3790	4.50	A
	1.6 + 1.6 + 2.0 + 6.0	11.2	1.49	1.49	1.86	5.56		10.40	3.4 ~ 14.2	2310	400 ~ 3790	4.50	A
	1.6 + 1.6 + 2.0 + 7.1	12.3	1.35	1.35	1.69	6.01		10.40	3.4 ~ 14.2	2310	400 ~ 3770	4.50	A
	1.6 + 1.6 + 2.5 + 2.5	8.2	2.03	2.03	3.17	3.17		10.40	3.4 ~ 14.2	2390	340 ~ 3980	4.35	A
	1.6 + 1.6 + 2.5 + 3.5	9.2	1.81	1.81	2.83	3.95		10.40	3.4 ~ 14.2	2360	340 ~ 3940	4.41	A
	1.6 + 1.6 + 2.5 + 4.2	9.9	1.68	1.68	2.63	4.41		10.40	3.4 ~ 14.2	2360	340 ~ 3930	4.41	A
	1.6 + 1.6 + 2.5 + 5.0	10.7	1.56	1.56	2.43	4.85		10.40	3.4 ~ 14.2	2310	400 ~ 3790	4.50	A
	1.6 + 1.6 + 2.5 + 6.0	11.7	1.42	1.42	2.22	5.34		10.40	3.4 ~ 14.2	2310	400 ~ 3790	4.50	A
	1.6 + 1.6 + 2.5 + 7.1	12.8	1.30	1.30	2.03	5.77		10.40	3.4 ~ 14.4	2310	400 ~ 3830	4.50	A
	1.6 + 1.6 + 3.5 + 3.5	10.2	1.63	1.63	3.57	3.57		10.40	3.4 ~ 14.2	2340	360 ~ 3910	4.44	A
	1.6 + 1.6 + 3.5 + 4.2	10.9	1.53	1.53	3.34	4.00		10.40	3.4 ~ 14.2	2330	360 ~ 3840	4.46	A
	1.6 + 1.6 + 3.5 + 5.0	11.7	1.42	1.42	3.11	4.45		10.40	3.4 ~ 14.2	2300	420 ~ 3750	4.52	A
	1.6 + 1.6 + 3.5 + 6.0	12.7	1.31	1.31	2.87	4.91		10.40	3.4 ~ 14.2	2300	420 ~ 3750	4.52	A
	1.6 + 1.6 + 3.5 + 7.1	13.8	1.21	1.21	2.64	5.34		10.40	3.4 ~ 14.4	2290	420 ~ 3800	4.54	A
	1.6 + 1.6 + 4.2 + 4.2	11.6	1.43	1.43	3.77	3.77		10.40	3.4 ~ 14.2	2330	370 ~ 3820	4.46	A
	1.6 + 1.6 + 4.2 + 5.0	12.4	1.34	1.34	3.52	4.20		10.40	3.4 ~ 14.2	2290	420 ~ 3740	4.54	A
	1.6 + 1.6 + 4.2 + 6.0	13.4	1.24	1.24	3.26	4.66		10.40	3.4 ~ 14.4	2290	420 ~ 3800	4.54	A
	1.6 + 1.6 + 4.2 + 7.1	14.5	1.15	1.15	3.01	5.09		10.40	3.4 ~ 14.4	2320	430 ~ 3780	4.48	A
	1.6 + 1.6 + 5.0 + 5.0	13.2	1.26	1.26	3.94	3.94		10.40	3.4 ~ 14.4	2320	490 ~ 3730	4.48	A
	1.6 + 1.6 + 5.0 + 6.0	14.2	1.17	1.17	3.66	4.40		10.40	3.4 ~ 14.4	2320	490 ~ 3730	4.48	A
	1.6 + 1.6 + 5.0 + 7.1	15.3	1.09	1.09	3.40	4.82		10.40	3.4 ~ 14.4	2310	510 ~ 3710	4.50	A
	1.6 + 1.6 + 6.0 + 6.0	15.2	1.09	1.09	4.11	4.11		10.40	3.4 ~ 14.4	2320	490 ~ 3730	4.48	A
	1.6 + 1.6 + 6.0 + 7.1	16.3	1.02	1.02	3.83	4.53		10.40	3.4 ~ 14.4	2310	510 ~ 3710	4.50	A
	1.6 + 1.6 + 7.1 + 7.1	17.4	0.96	0.96	4.24	4.24		10.40	3.4 ~ 14.4	2300	510 ~ 3760	4.52	A
	1.6 + 2.0 + 2.0 + 2.0	7.6	2.18	2.74	2.74	2.74		10.40	3.4 ~ 14.2	2380	340 ~ 3970	4.37	A
	1.6 + 2.0 + 2.0 + 2.5	8.1	2.05	2.57	2.57	3.21		10.40	3.4 ~ 14.2	2380	340 ~ 3970	4.37	A
	1.6 + 2.0 + 2.0 + 3.5	9.1	1.83	2.29	2.29	3.99		10.40	3.4 ~ 14.2	2360	340 ~ 3930	4.41	A
	1.6 + 2.0 + 2.0 + 4.2	9.8	1.70	2.12	2.12	4.46		10.40	3.4 ~ 14.2	2350	350 ~ 3920	4.43	A
1.6 + 2.0 + 2.0 + 5.0	10.6	1.57	1.96	1.96	4.91		10.40	3.4 ~ 14.2	2310	400 ~ 3780	4.50	A	
1.6 + 2.0 + 2.0 + 6.0	11.6	1.43	1.79	1.79	5.39		10.40	3.4 ~ 14.2	2310	400 ~ 3780	4.50	A	
1.6 + 2.0 + 2.0 + 7.1	12.7	1.31	1.64	1.64	5.81		10.40	3.4 ~ 14.2	2300	420 ~ 3760	4.52	A	
1.6 + 2.0 + 2.5 + 2.5	8.6	1.93	2.43	3.02	3.02		10.40	3.4 ~ 14.2	2380	340 ~ 3970	4.37	A	
1.6 + 2.0 + 2.5 + 3.5	9.6	1.73	2.17	2.71	3.79		10.40	3.4 ~ 14.2	2360	340 ~ 3930	4.41	A	
1.6 + 2.0 + 2.5 + 4.2	10.3	1.62	2.02	2.52	4.24		10.40	3.4 ~ 14.2	2350	350 ~ 3920	4.43	A	
1.6 + 2.0 + 2.5 + 5.0	11.1	1.50	1.87	2.34	4.69		10.40	3.4 ~ 14.2	2310	400 ~ 3780	4.50	A	
1.6 + 2.0 + 2.5 + 6.0	12.1	1.38	1.72	2.15	5.15		10.40	3.4 ~ 14.2	2310	400 ~ 3780	4.50	A	
1.6 + 2.0 + 2.5 + 7.1	13.2	1.26	1.58	1.97	5.59		10.40	3.4 ~ 14.4	2300	420 ~ 3820	4.52	A	
1.6 + 2.0 + 3.5 + 3.5	10.6	1.57	1.97	3.43	3.43		10.40	3.4 ~ 14.2	2330	360 ~ 3840	4.46	A	
1.6 + 2.0 + 3.5 + 4.2	11.3	1.47	1.84	3.22	3.87		10.40	3.4 ~ 14.2	2330	370 ~ 3820	4.46	A	
1.6 + 2.0 + 3.5 + 5.0	12.1	1.38	1.72	3.01	4.29		10.40	3.4 ~ 14.2	2290	420 ~ 3740	4.54	A	
1.6 + 2.0 + 3.5 + 6.0	13.1	1.27	1.59	2.78	4.76		10.40	3.4 ~ 14.4	2290	420 ~ 3800	4.54	A	
1.6 + 2.0 + 3.5 + 7.1	14.2	1.17	1.46	2.56	5.21		10.40	3.4 ~ 14.4	2320	430 ~ 3780	4.48	A	
1.6 + 2.0 + 4.2 + 4.2	12.0	1.39	1.73	3.64	3.64		10.40	3.4 ~ 14.2	2320	370 ~ 3810	4.48	A	
1.6 + 2.0 + 4.2 + 5.0	12.8	1.30	1.63	3.41	4.06		10.40	3.4 ~ 14.4	2280	420 ~ 3790	4.56	A	
1.6 + 2.0 + 4.2 + 6.0	13.8	1.21	1.51	3.17	4.51		10.40	3.4 ~ 14.4	2280	420 ~ 3790	4.56	A	
1.6 + 2.0 + 4.2 + 7.1	14.9	1.12	1.40	2.93	4.95		10.40	3.4 ~ 14.4	2320	430 ~ 3770	4.48	A	

	Indoor unit capacity Heating	Annual Energy Consumption (kWh)	Current 230V (A)	ERP			Moisture Removal Volume l/h	
				Pdesign (kW)	SCOP			Annual Consumption (kWh)
					W/W	CLASS		
4 Room	1.6 + 1.6 + 1.6 + 1.6	1115	10.5	8.50	4.10	A+	2902	
	1.6 + 1.6 + 1.6 + 2.0	1180	11.1	8.50	4.10	A+	2902	
	1.6 + 1.6 + 1.6 + 2.5	1175	11.0	8.50	4.20	A+	2833	
	1.6 + 1.6 + 1.6 + 3.5	1185	11.1	8.50	4.20	A+	2833	
	1.6 + 1.6 + 1.6 + 4.2	1180	11.1	8.50	4.40	A+	2705	
	1.6 + 1.6 + 1.6 + 5.0	1160	10.9	8.50	4.40	A+	2705	
	1.6 + 1.6 + 1.6 + 6.0	1160	10.9	8.50	4.40	A+	2705	
	1.6 + 1.6 + 1.6 + 7.1	1155	10.9	8.50	4.40	A+	2705	
	1.6 + 1.6 + 2.0 + 2.0	1195	11.2	8.50	4.20	A+	2833	
	1.6 + 1.6 + 2.0 + 2.5	1195	11.2	8.50	4.20	A+	2833	
	1.6 + 1.6 + 2.0 + 3.5	1180	11.1	8.50	4.20	A+	2833	
	1.6 + 1.6 + 2.0 + 4.2	1180	11.1	8.50	4.40	A+	2705	
	1.6 + 1.6 + 2.0 + 5.0	1155	10.9	8.50	4.40	A+	2705	
	1.6 + 1.6 + 2.0 + 6.0	1155	10.9	8.50	4.40	A+	2705	
	1.6 + 1.6 + 2.0 + 7.1	1155	10.9	8.50	4.40	A+	2705	
	1.6 + 1.6 + 2.5 + 2.5	1195	11.2	8.50	4.20	A+	2833	
	1.6 + 1.6 + 2.5 + 3.5	1180	11.1	8.50	4.40	A+	2705	
	1.6 + 1.6 + 2.5 + 4.2	1180	11.1	8.50	4.40	A+	2705	
	1.6 + 1.6 + 2.5 + 5.0	1155	10.9	8.50	4.40	A+	2705	
	1.6 + 1.6 + 2.5 + 6.0	1155	10.9	8.50	4.40	A+	2705	
	1.6 + 1.6 + 2.5 + 7.1	1155	10.9	8.50	4.40	A+	2705	
	1.6 + 1.6 + 3.5 + 3.5	1170	11.0	8.50	4.40	A+	2705	
	1.6 + 1.6 + 3.5 + 4.2	1165	10.9	8.50	4.40	A+	2705	
	1.6 + 1.6 + 3.5 + 5.0	1150	10.8	8.50	4.40	A+	2705	
	1.6 + 1.6 + 3.5 + 6.0	1150	10.8	8.50	4.40	A+	2705	
	1.6 + 1.6 + 3.5 + 7.1	1145	10.8	8.50	4.40	A+	2705	
	1.6 + 1.6 + 4.2 + 4.2	1165	10.9	8.50	4.40	A+	2705	
	1.6 + 1.6 + 4.2 + 5.0	1145	10.8	8.50	4.40	A+	2705	
	1.6 + 1.6 + 4.2 + 6.0	1145	10.8	8.50	4.40	A+	2705	
	1.6 + 1.6 + 4.2 + 7.1	1160	10.9	8.50	4.40	A+	2705	
	1.6 + 1.6 + 5.0 + 5.0	1160	10.9	8.50	4.40	A+	2705	
	1.6 + 1.6 + 5.0 + 6.0	1160	10.9	8.50	4.40	A+	2705	
	1.6 + 1.6 + 5.0 + 7.1	1155	10.9	8.50	4.40	A+	2705	
	1.6 + 1.6 + 6.0 + 6.0	1160	10.9	8.50	4.40	A+	2705	
	1.6 + 1.6 + 6.0 + 7.1	1155	10.9	8.50	4.40	A+	2705	
	1.6 + 1.6 + 7.1 + 7.1	1150	10.8	8.50	4.40	A+	2705	
	1.6 + 2.0 + 2.0 + 2.0	1190	11.2	8.50	4.20	A+	2833	
	1.6 + 2.0 + 2.0 + 2.5	1190	11.2	8.50	4.20	A+	2833	
	1.6 + 2.0 + 2.0 + 3.5	1180	11.1	8.50	4.40	A+	2705	
	1.6 + 2.0 + 2.0 + 4.2	1175	11.0	8.50	4.40	A+	2705	
1.6 + 2.0 + 2.0 + 5.0	1155	10.9	8.50	4.40	A+	2705		
1.6 + 2.0 + 2.0 + 6.0	1155	10.9	8.50	4.40	A+	2705		
1.6 + 2.0 + 2.0 + 7.1	1150	10.8	8.50	4.40	A+	2705		
1.6 + 2.0 + 2.5 + 2.5	1190	11.2	8.50	4.20	A+	2833		
1.6 + 2.0 + 2.5 + 3.5	1180	11.1	8.50	4.40	A+	2705		
1.6 + 2.0 + 2.5 + 4.2	1175	11.0	8.50	4.40	A+	2705		
1.6 + 2.0 + 2.5 + 5.0	1155	10.9	8.50	4.40	A+	2705		
1.6 + 2.0 + 2.5 + 6.0	1155	10.9	8.50	4.40	A+	2705		
1.6 + 2.0 + 2.5 + 7.1	1150	10.8	8.50	4.40	A+	2705		
1.6 + 2.0 + 3.5 + 3.5	1165	10.9	8.50	4.40	A+	2705		
1.6 + 2.0 + 3.5 + 4.2	1165	10.9	8.50	4.40	A+	2705		
1.6 + 2.0 + 3.5 + 5.0	1145	10.8	8.50	4.40	A+	2705		
1.6 + 2.0 + 3.5 + 6.0	1145	10.8	8.50	4.40	A+	2705		
1.6 + 2.0 + 3.5 + 7.1	1160	10.9	8.50	4.40	A+	2705		
1.6 + 2.0 + 4.2 + 4.2	1160	10.9	8.50	4.40	A+	2705		
1.6 + 2.0 + 4.2 + 5.0	1140	10.7	8.50	4.40	A+	2705		
1.6 + 2.0 + 4.2 + 6.0	1140	10.7	8.50	4.40	A+	2705		
1.6 + 2.0 + 4.2 + 7.1	1160	10.9	8.50	4.40	A+	2705		

Indoor unit capacity Heating	Total	Heating Capacity (kW)							Input Power (W)		COP	
		Room A	Room B	Room C	Room D	Room E	Total	min ~ max	Rating	min ~ max	WW	CLASS
1.6 + 2.0 + 5.0 + 5.0	13.6	1.22	1.54	3.82	3.82		10.40	3.4 ~ 14.4	2310	500 ~ 3720	4.50	A
1.6 + 2.0 + 5.0 + 6.0	14.6	1.14	1.42	3.56	4.28		10.40	3.4 ~ 14.4	2310	500 ~ 3720	4.50	A
1.6 + 2.0 + 5.0 + 7.1	15.7	1.06	1.32	3.31	4.71		10.40	3.4 ~ 14.4	2310	510 ~ 3760	4.50	A
1.6 + 2.0 + 6.0 + 6.0	15.6	1.07	1.33	4.00	4.00		10.40	3.4 ~ 14.4	2310	500 ~ 3720	4.50	A
1.6 + 2.0 + 6.0 + 7.1	16.7	1.00	1.25	3.74	4.41		10.40	3.4 ~ 14.4	2310	510 ~ 3760	4.50	A
1.6 + 2.0 + 7.1 + 7.1	17.8	0.93	1.17	4.15	4.15		10.40	3.4 ~ 14.4	2340	520 ~ 3750	4.44	A
1.6 + 2.5 + 2.5 + 2.5	9.1	1.82	2.86	2.86	2.86		10.40	3.4 ~ 14.2	2380	340 ~ 3970	4.37	A
1.6 + 2.5 + 2.5 + 3.5	10.1	1.65	2.57	2.57	3.61		10.40	3.4 ~ 14.2	2360	340 ~ 3930	4.41	A
1.6 + 2.5 + 2.5 + 4.2	10.8	1.54	2.41	2.41	4.04		10.40	3.4 ~ 14.2	2350	350 ~ 3920	4.43	A
1.6 + 2.5 + 2.5 + 5.0	11.6	1.43	2.24	2.24	4.49		10.40	3.4 ~ 14.2	2310	400 ~ 3780	4.50	A
1.6 + 2.5 + 2.5 + 6.0	12.6	1.32	2.06	2.06	4.96		10.40	3.4 ~ 14.2	2310	400 ~ 3780	4.50	A
1.6 + 2.5 + 2.5 + 7.1	13.7	1.21	1.90	1.90	5.39		10.40	3.4 ~ 14.4	2300	420 ~ 3820	4.52	A
1.6 + 2.5 + 3.5 + 3.5	11.1	1.50	2.34	3.28	3.28		10.40	3.4 ~ 14.2	2330	360 ~ 3840	4.46	A
1.6 + 2.5 + 3.5 + 4.2	11.8	1.41	2.20	3.08	3.71		10.40	3.4 ~ 14.2	2330	370 ~ 3820	4.46	A
1.6 + 2.5 + 3.5 + 5.0	12.6	1.32	2.06	2.89	4.13		10.40	3.4 ~ 14.2	2290	420 ~ 3740	4.54	A
1.6 + 2.5 + 3.5 + 6.0	13.6	1.22	1.91	2.68	4.59		10.40	3.4 ~ 14.4	2290	420 ~ 3800	4.54	A
1.6 + 2.5 + 3.5 + 7.1	14.7	1.13	1.77	2.48	5.02		10.40	3.4 ~ 14.4	2320	430 ~ 3780	4.48	A
1.6 + 2.5 + 4.2 + 4.2	12.5	1.33	2.09	3.49	3.49		10.40	3.4 ~ 14.2	2320	370 ~ 3810	4.48	A
1.6 + 2.5 + 4.2 + 5.0	13.3	1.25	1.95	3.28	3.92		10.40	3.4 ~ 14.4	2280	420 ~ 3790	4.56	A
1.6 + 2.5 + 4.2 + 6.0	14.3	1.16	1.82	3.05	4.37		10.40	3.4 ~ 14.4	2280	420 ~ 3790	4.56	A
1.6 + 2.5 + 4.2 + 7.1	15.4	1.08	1.69	2.84	4.79		10.40	3.4 ~ 14.4	2320	430 ~ 3770	4.48	A
1.6 + 2.5 + 5.0 + 5.0	14.1	1.18	1.84	3.69	3.69		10.40	3.4 ~ 14.4	2310	500 ~ 3720	4.50	A
1.6 + 2.5 + 5.0 + 6.0	15.1	1.10	1.72	3.44	4.14		10.40	3.4 ~ 14.4	2310	500 ~ 3720	4.50	A
1.6 + 2.5 + 5.0 + 7.1	16.2	1.03	1.60	3.21	4.56		10.40	3.4 ~ 14.4	2310	510 ~ 3760	4.50	A
1.6 + 2.5 + 6.0 + 6.0	16.1	1.03	1.61	3.88	3.88		10.40	3.4 ~ 14.4	2310	500 ~ 3720	4.50	A
1.6 + 2.5 + 6.0 + 7.1	17.2	0.97	1.51	3.63	4.29		10.40	3.4 ~ 14.4	2310	510 ~ 3760	4.50	A
1.6 + 2.5 + 7.1 + 7.1	18.3	0.91	1.43	4.03	4.03		10.40	3.4 ~ 14.4	2340	520 ~ 3750	4.44	A
1.6 + 3.5 + 3.5 + 3.5	12.1	1.37	3.01	3.01	3.01		10.40	3.4 ~ 14.2	2310	370 ~ 3800	4.50	A
1.6 + 3.5 + 3.5 + 4.2	12.8	1.30	2.84	2.84	3.42		10.40	3.4 ~ 14.4	2350	370 ~ 3910	4.43	A
1.6 + 3.5 + 3.5 + 5.0	13.6	1.22	2.68	2.68	3.82		10.40	3.4 ~ 14.4	2320	430 ~ 3770	4.48	A
1.6 + 3.5 + 3.5 + 6.0	14.6	1.14	2.49	2.49	4.28		10.40	3.4 ~ 14.4	2320	430 ~ 3770	4.48	A
1.6 + 3.5 + 3.5 + 7.1	15.7	1.06	2.32	2.32	4.70		10.40	3.4 ~ 14.4	2310	450 ~ 3810	4.50	A
1.6 + 3.5 + 4.2 + 4.2	13.5	1.22	2.70	3.24	3.24		10.40	3.4 ~ 14.4	2340	370 ~ 3890	4.44	A
1.6 + 3.5 + 4.2 + 5.0	14.3	1.16	2.55	3.05	3.64		10.40	3.4 ~ 14.4	2310	450 ~ 3810	4.50	A
1.6 + 3.5 + 4.2 + 6.0	15.3	1.09	2.38	2.85	4.08		10.40	3.4 ~ 14.4	2310	450 ~ 3810	4.50	A
1.6 + 3.5 + 4.2 + 7.1	16.4	1.01	2.22	2.66	4.51		10.40	3.4 ~ 14.4	2300	450 ~ 3800	4.52	A
1.6 + 3.5 + 5.0 + 5.0	15.1	1.10	2.42	3.44	3.44		10.40	3.4 ~ 14.4	2340	520 ~ 3750	4.44	A
1.6 + 3.5 + 5.0 + 6.0	16.1	1.03	2.26	3.23	3.88		10.40	3.4 ~ 14.4	2340	520 ~ 3750	4.44	A
1.6 + 3.5 + 5.0 + 7.1	17.2	0.97	2.12	3.02	4.29		10.40	3.4 ~ 14.4	2340	540 ~ 3730	4.44	A
1.6 + 3.5 + 6.0 + 6.0	17.1	0.97	2.13	3.65	3.65		10.40	3.4 ~ 14.4	2340	520 ~ 3750	4.44	A
1.6 + 3.5 + 6.0 + 7.1	18.2	0.91	2.00	3.43	4.06		10.40	3.4 ~ 14.4	2340	540 ~ 3730	4.44	A
1.6 + 4.2 + 4.2 + 4.2	14.2	1.16	3.08	3.08	3.08		10.40	3.4 ~ 14.4	2330	390 ~ 3880	4.46	A
1.6 + 4.2 + 4.2 + 5.0	15.0	1.11	2.91	2.91	3.47		10.40	3.4 ~ 14.4	2310	450 ~ 3800	4.50	A
1.6 + 4.2 + 4.2 + 6.0	16.0	1.04	2.73	2.73	3.90		10.40	3.4 ~ 14.4	2310	450 ~ 3800	4.50	A
1.6 + 4.2 + 4.2 + 7.1	17.1	0.97	2.55	2.55	4.33		10.40	3.4 ~ 14.4	2300	460 ~ 3790	4.52	A
1.6 + 4.2 + 5.0 + 5.0	15.8	1.05	2.77	3.29	3.29		10.40	3.4 ~ 14.4	2340	530 ~ 3740	4.44	A
1.6 + 4.2 + 5.0 + 6.0	16.8	0.99	2.60	3.10	3.71		10.40	3.4 ~ 14.4	2340	530 ~ 3740	4.44	A
1.6 + 4.2 + 5.0 + 7.1	17.9	0.93	2.44	2.91	4.12		10.40	3.4 ~ 14.4	2330	540 ~ 3720	4.46	A
1.6 + 4.2 + 6.0 + 6.0	17.8	0.93	2.45	3.51	3.51		10.40	3.4 ~ 14.4	2340	530 ~ 3740	4.44	A
1.6 + 5.0 + 5.0 + 5.0	16.6	1.01	3.13	3.13	3.13		10.40	3.4 ~ 14.4	2390	630 ~ 3740	4.35	A
1.6 + 5.0 + 5.0 + 6.0	17.6	0.95	2.95	2.95	3.55		10.40	3.4 ~ 14.4	2390	630 ~ 3740	4.35	A
2.0 + 2.0 + 2.0 + 2.0	8.0	2.60	2.60	2.60	2.60		10.40	3.4 ~ 14.2	2370	340 ~ 3950	4.39	A
2.0 + 2.0 + 2.0 + 2.5	8.5	2.45	2.45	2.45	3.05		10.40	3.4 ~ 14.2	2370	340 ~ 3950	4.39	A
2.0 + 2.0 + 2.0 + 3.5	9.5	2.19	2.19	2.19	3.83		10.40	3.4 ~ 14.2	2350	350 ~ 3920	4.43	A
2.0 + 2.0 + 2.0 + 4.2	10.2	2.04	2.04	2.04	4.28		10.40	3.4 ~ 14.2	2340	360 ~ 3900	4.44	A
2.0 + 2.0 + 2.0 + 5.0	11.0	1.89	1.89	1.89	4.73		10.40	3.4 ~ 14.2	2300	420 ~ 3760	4.52	A
2.0 + 2.0 + 2.0 + 6.0	12.0	1.73	1.73	1.73	5.21		10.40	3.4 ~ 14.2	2300	420 ~ 3760	4.52	A
2.0 + 2.0 + 2.0 + 7.1	13.1	1.59	1.59	1.59	5.63		10.40	3.4 ~ 14.4	2290	420 ~ 3800	4.54	A



	Indoor unit capacity Heating	Annual Energy Consumption (kWh)	Current 230V (A)	ERP			Moisture Removal Volume l/h	
				Pdesign (kW)	SCOP			Annual Consumption (kWh)
					W/W	CLASS		
4 Room	1.6 + 2.0 + 5.0 + 5.0	1155	10.9	8.50	4.40	A+	2705	
	1.6 + 2.0 + 5.0 + 6.0	1155	10.9	8.50	4.40	A+	2705	
	1.6 + 2.0 + 5.0 + 7.1	1155	10.9	8.50	4.40	A+	2705	
	1.6 + 2.0 + 6.0 + 6.0	1155	10.9	8.50	4.40	A+	2705	
	1.6 + 2.0 + 6.0 + 7.1	1155	10.9	8.50	4.40	A+	2705	
	1.6 + 2.0 + 7.1 + 7.1	1170	11.0	8.50	4.40	A+	2705	
	1.6 + 2.5 + 2.5 + 2.5	1190	11.2	8.50	4.40	A+	2705	
	1.6 + 2.5 + 2.5 + 3.5	1180	11.1	8.50	4.40	A+	2705	
	1.6 + 2.5 + 2.5 + 4.2	1175	11.0	8.50	4.40	A+	2705	
	1.6 + 2.5 + 2.5 + 5.0	1155	10.9	8.50	4.40	A+	2705	
	1.6 + 2.5 + 2.5 + 6.0	1155	10.9	8.50	4.40	A+	2705	
	1.6 + 2.5 + 2.5 + 7.1	1150	10.8	8.50	4.40	A+	2705	
	1.6 + 2.5 + 3.5 + 3.5	1165	10.9	8.50	4.40	A+	2705	
	1.6 + 2.5 + 3.5 + 4.2	1165	10.9	8.50	4.40	A+	2705	
	1.6 + 2.5 + 3.5 + 5.0	1145	10.8	8.50	4.40	A+	2705	
	1.6 + 2.5 + 3.5 + 6.0	1145	10.8	8.50	4.40	A+	2705	
	1.6 + 2.5 + 3.5 + 7.1	1160	10.9	8.50	4.40	A+	2705	
	1.6 + 2.5 + 4.2 + 4.2	1160	10.9	8.50	4.40	A+	2705	
	1.6 + 2.5 + 4.2 + 5.0	1140	10.7	8.50	4.40	A+	2705	
	1.6 + 2.5 + 4.2 + 6.0	1140	10.7	8.50	4.40	A+	2705	
	1.6 + 2.5 + 4.2 + 7.1	1160	10.9	8.50	4.40	A+	2705	
	1.6 + 2.5 + 5.0 + 5.0	1155	10.9	8.50	4.40	A+	2705	
	1.6 + 2.5 + 5.0 + 6.0	1155	10.9	8.50	4.40	A+	2705	
	1.6 + 2.5 + 5.0 + 7.1	1155	10.9	8.50	4.40	A+	2705	
	1.6 + 2.5 + 6.0 + 6.0	1155	10.9	8.50	4.40	A+	2705	
	1.6 + 2.5 + 6.0 + 7.1	1155	10.9	8.50	4.40	A+	2705	
	1.6 + 2.5 + 7.1 + 7.1	1170	11.0	8.50	4.40	A+	2705	
	1.6 + 3.5 + 3.5 + 3.5	1155	10.9	8.50	4.40	A+	2705	
	1.6 + 3.5 + 3.5 + 4.2	1175	11.0	8.50	4.40	A+	2705	
	1.6 + 3.5 + 3.5 + 5.0	1160	10.9	8.50	4.40	A+	2705	
	1.6 + 3.5 + 3.5 + 6.0	1160	10.9	8.50	4.40	A+	2705	
	1.6 + 3.5 + 3.5 + 7.1	1155	10.9	8.50	4.40	A+	2705	
	1.6 + 3.5 + 4.2 + 4.2	1170	11.0	8.50	4.40	A+	2705	
	1.6 + 3.5 + 4.2 + 5.0	1155	10.9	8.50	4.40	A+	2705	
	1.6 + 3.5 + 4.2 + 6.0	1155	10.9	8.50	4.40	A+	2705	
	1.6 + 3.5 + 4.2 + 7.1	1150	10.8	8.50	4.40	A+	2705	
	1.6 + 3.5 + 5.0 + 5.0	1170	11.0	8.50	4.40	A+	2705	
	1.6 + 3.5 + 5.0 + 6.0	1170	11.0	8.50	4.40	A+	2705	
	1.6 + 3.5 + 5.0 + 7.1	1170	11.0	8.50	4.40	A+	2705	
	1.6 + 3.5 + 6.0 + 6.0	1170	11.0	8.50	4.40	A+	2705	
1.6 + 3.5 + 6.0 + 7.1	1170	11.0	8.50	4.40	A+	2705		
1.6 + 4.2 + 4.2 + 4.2	1165	10.9	8.50	4.40	A+	2705		
1.6 + 4.2 + 4.2 + 5.0	1155	10.9	8.50	4.40	A+	2705		
1.6 + 4.2 + 4.2 + 6.0	1155	10.9	8.50	4.40	A+	2705		
1.6 + 4.2 + 4.2 + 7.1	1150	10.8	8.50	4.40	A+	2705		
1.6 + 4.2 + 5.0 + 5.0	1170	11.0	8.50	4.40	A+	2705		
1.6 + 4.2 + 5.0 + 6.0	1170	11.0	8.50	4.40	A+	2705		
1.6 + 4.2 + 5.0 + 7.1	1165	10.9	8.50	4.40	A+	2705		
1.6 + 4.2 + 6.0 + 6.0	1170	11.0	8.50	4.40	A+	2705		
1.6 + 5.0 + 5.0 + 5.0	1195	11.2	8.50	4.40	A+	2705		
1.6 + 5.0 + 5.0 + 6.0	1195	11.2	8.50	4.40	A+	2705		
2.0 + 2.0 + 2.0 + 2.0	1185	11.1	8.50	4.20	A+	2833		
2.0 + 2.0 + 2.0 + 2.5	1185	11.1	8.50	4.20	A+	2833		
2.0 + 2.0 + 2.0 + 3.5	1175	11.0	8.50	4.40	A+	2705		
2.0 + 2.0 + 2.0 + 4.2	1170	11.0	8.50	4.40	A+	2705		
2.0 + 2.0 + 2.0 + 5.0	1150	10.8	8.50	4.40	A+	2705		
2.0 + 2.0 + 2.0 + 6.0	1150	10.8	8.50	4.40	A+	2705		
2.0 + 2.0 + 2.0 + 7.1	1145	10.8	8.50	4.40	A+	2705		

Indoor unit capacity Heating		Total	Heating Capacity (kW)						Input Power (W)		COP		
			Room A	Room B	Room C	Room D	Room E	Total	min ~ max	Rating	min ~ max	WW	CLASS
4 Room	2.0 + 2.0 + 2.5 + 2.5	9.0	2.31	2.31	2.89	2.89		10.40	3.4 ~ 14.2	2370	340 ~ 3950	4.39	A
	2.0 + 2.0 + 2.5 + 3.5	10.0	2.08	2.08	2.60	3.64		10.40	3.4 ~ 14.2	2350	350 ~ 3920	4.43	A
	2.0 + 2.0 + 2.5 + 4.2	10.7	1.94	1.94	2.43	4.09		10.40	3.4 ~ 14.2	2340	360 ~ 3900	4.44	A
	2.0 + 2.0 + 2.5 + 5.0	11.5	1.81	1.81	2.26	4.52		10.40	3.4 ~ 14.2	2300	420 ~ 3760	4.52	A
	2.0 + 2.0 + 2.5 + 6.0	12.5	1.66	1.66	2.08	5.00		10.40	3.4 ~ 14.2	2300	420 ~ 3760	4.52	A
	2.0 + 2.0 + 2.5 + 7.1	13.6	1.53	1.53	1.91	5.43		10.40	3.4 ~ 14.4	2290	420 ~ 3800	4.54	A
	2.0 + 2.0 + 3.5 + 3.5	11.0	1.89	1.89	3.31	3.31		10.40	3.4 ~ 14.2	2330	370 ~ 3820	4.46	A
	2.0 + 2.0 + 3.5 + 4.2	11.7	1.78	1.78	3.11	3.73		10.40	3.4 ~ 14.2	2320	370 ~ 3810	4.48	A
	2.0 + 2.0 + 3.5 + 5.0	12.5	1.66	1.66	2.91	4.17		10.40	3.4 ~ 14.2	2280	420 ~ 3730	4.56	A
	2.0 + 2.0 + 3.5 + 6.0	13.5	1.54	1.54	2.70	4.62		10.40	3.4 ~ 14.4	2280	420 ~ 3790	4.56	A
	2.0 + 2.0 + 3.5 + 7.1	14.6	1.42	1.42	2.49	5.07		10.40	3.4 ~ 14.4	2320	430 ~ 3770	4.48	A
	2.0 + 2.0 + 4.2 + 4.2	12.4	1.68	1.68	3.52	3.52		10.40	3.4 ~ 14.2	2350	370 ~ 3800	4.43	A
	2.0 + 2.0 + 4.2 + 5.0	13.2	1.58	1.58	3.31	3.93		10.40	3.4 ~ 14.4	2320	430 ~ 3780	4.48	A
	2.0 + 2.0 + 4.2 + 6.0	14.2	1.46	1.46	3.08	4.40		10.40	3.4 ~ 14.4	2320	430 ~ 3780	4.48	A
	2.0 + 2.0 + 4.2 + 7.1	15.3	1.36	1.36	2.85	4.83		10.40	3.4 ~ 14.4	2310	440 ~ 3820	4.50	A
	2.0 + 2.0 + 5.0 + 5.0	14.0	1.49	1.49	3.71	3.71		10.40	3.4 ~ 14.4	2310	510 ~ 3760	4.50	A
	2.0 + 2.0 + 5.0 + 6.0	15.0	1.39	1.39	3.47	4.15		10.40	3.4 ~ 14.4	2310	510 ~ 3760	4.50	A
	2.0 + 2.0 + 5.0 + 7.1	16.1	1.29	1.29	3.23	4.59		10.40	3.4 ~ 14.4	2340	520 ~ 3750	4.44	A
	2.0 + 2.0 + 6.0 + 6.0	16.0	1.30	1.30	3.90	3.90		10.40	3.4 ~ 14.4	2310	510 ~ 3760	4.50	A
	2.0 + 2.0 + 6.0 + 7.1	17.1	1.22	1.22	3.65	4.31		10.40	3.4 ~ 14.4	2340	520 ~ 3750	4.44	A
	2.0 + 2.0 + 7.1 + 7.1	18.2	1.14	1.14	4.06	4.06		10.40	3.4 ~ 14.4	2340	530 ~ 3740	4.44	A
	2.0 + 2.5 + 2.5 + 2.5	9.5	2.18	2.74	2.74	2.74		10.40	3.4 ~ 14.2	2370	340 ~ 3950	4.39	A
	2.0 + 2.5 + 2.5 + 3.5	10.5	1.98	2.48	2.48	3.46		10.40	3.4 ~ 14.2	2350	350 ~ 3920	4.43	A
	2.0 + 2.5 + 2.5 + 4.2	11.2	1.86	2.32	2.32	3.90		10.40	3.4 ~ 14.2	2340	360 ~ 3900	4.44	A
	2.0 + 2.5 + 2.5 + 5.0	12.0	1.73	2.17	2.17	4.33		10.40	3.4 ~ 14.2	2300	420 ~ 3760	4.52	A
	2.0 + 2.5 + 2.5 + 6.0	13.0	1.60	2.00	2.00	4.80		10.40	3.4 ~ 14.4	2300	420 ~ 3820	4.52	A
	2.0 + 2.5 + 2.5 + 7.1	14.1	1.48	1.84	1.84	5.24		10.40	3.4 ~ 14.4	2290	420 ~ 3800	4.54	A
	2.0 + 2.5 + 3.5 + 3.5	11.5	1.80	2.26	3.17	3.17		10.40	3.4 ~ 14.2	2330	370 ~ 3820	4.46	A
	2.0 + 2.5 + 3.5 + 4.2	12.2	1.70	2.13	2.98	3.59		10.40	3.4 ~ 14.2	2320	370 ~ 3810	4.48	A
	2.0 + 2.5 + 3.5 + 5.0	13.0	1.60	2.00	2.80	4.00		10.40	3.4 ~ 14.4	2280	420 ~ 3790	4.56	A
	2.0 + 2.5 + 3.5 + 6.0	14.0	1.49	1.86	2.60	4.45		10.40	3.4 ~ 14.4	2280	420 ~ 3790	4.56	A
	2.0 + 2.5 + 3.5 + 7.1	15.1	1.38	1.72	2.41	4.89		10.40	3.4 ~ 14.4	2320	430 ~ 3770	4.48	A
	2.0 + 2.5 + 4.2 + 4.2	12.9	1.60	2.02	3.39	3.39		10.40	3.4 ~ 14.4	2350	370 ~ 3920	4.43	A
	2.0 + 2.5 + 4.2 + 5.0	13.7	1.52	1.90	3.19	3.79		10.40	3.4 ~ 14.4	2320	430 ~ 3780	4.48	A
	2.0 + 2.5 + 4.2 + 6.0	14.7	1.41	1.77	2.97	4.25		10.40	3.4 ~ 14.4	2320	430 ~ 3780	4.48	A
	2.0 + 2.5 + 4.2 + 7.1	15.8	1.32	1.65	2.76	4.67		10.40	3.4 ~ 14.4	2310	440 ~ 3820	4.50	A
	2.0 + 2.5 + 5.0 + 5.0	14.5	1.43	1.79	3.59	3.59		10.40	3.4 ~ 14.4	2310	510 ~ 3760	4.50	A
	2.0 + 2.5 + 5.0 + 6.0	15.5	1.34	1.68	3.35	4.03		10.40	3.4 ~ 14.4	2310	510 ~ 3760	4.50	A
	2.0 + 2.5 + 5.0 + 7.1	16.6	1.25	1.57	3.13	4.45		10.40	3.4 ~ 14.4	2340	520 ~ 3750	4.44	A
	2.0 + 2.5 + 6.0 + 6.0	16.5	1.26	1.58	3.78	3.78		10.40	3.4 ~ 14.4	2310	510 ~ 3760	4.50	A
2.0 + 2.5 + 6.0 + 7.1	17.6	1.18	1.48	3.55	4.19		10.40	3.4 ~ 14.4	2340	520 ~ 3750	4.44	A	
2.0 + 3.5 + 3.5 + 3.5	12.5	1.67	2.91	2.91	2.91		10.40	3.4 ~ 14.2	2350	370 ~ 3790	4.43	A	
2.0 + 3.5 + 3.5 + 4.2	13.2	1.58	2.76	2.76	3.30		10.40	3.4 ~ 14.4	2340	370 ~ 3890	4.44	A	
2.0 + 3.5 + 3.5 + 5.0	14.0	1.49	2.60	2.60	3.71		10.40	3.4 ~ 14.4	2310	450 ~ 3810	4.50	A	
2.0 + 3.5 + 3.5 + 6.0	15.0	1.39	2.43	2.43	4.15		10.40	3.4 ~ 14.4	2310	450 ~ 3810	4.50	A	
2.0 + 3.5 + 3.5 + 7.1	16.1	1.29	2.26	2.26	4.59		10.40	3.4 ~ 14.4	2300	450 ~ 3800	4.52	A	
2.0 + 3.5 + 4.2 + 4.2	13.9	1.50	2.62	3.14	3.14		10.40	3.4 ~ 14.4	2330	390 ~ 3880	4.46	A	
2.0 + 3.5 + 4.2 + 5.0	14.7	1.41	2.48	2.97	3.54		10.40	3.4 ~ 14.4	2310	450 ~ 3800	4.50	A	
2.0 + 3.5 + 4.2 + 6.0	15.7	1.32	2.32	2.78	3.98		10.40	3.4 ~ 14.4	2310	450 ~ 3800	4.50	A	
2.0 + 3.5 + 4.2 + 7.1	16.8	1.24	2.17	2.60	4.39		10.40	3.4 ~ 14.4	2300	460 ~ 3790	4.52	A	
2.0 + 3.5 + 5.0 + 5.0	15.5	1.34	2.36	3.35	3.35		10.40	3.4 ~ 14.4	2340	530 ~ 3740	4.44	A	
2.0 + 3.5 + 5.0 + 6.0	16.5	1.26	2.21	3.15	3.78		10.40	3.4 ~ 14.4	2340	530 ~ 3740	4.44	A	
2.0 + 3.5 + 5.0 + 7.1	17.6	1.18	2.07	2.95	4.20		10.40	3.4 ~ 14.4	2330	540 ~ 3720	4.46	A	
2.0 + 3.5 + 6.0 + 6.0	17.5	1.19	2.07	3.57	3.57		10.40	3.4 ~ 14.4	2340	530 ~ 3740	4.44	A	
2.0 + 4.2 + 4.2 + 4.2	14.6	1.43	2.99	2.99	2.99		10.40	3.4 ~ 14.4	2330	390 ~ 3870	4.46	A	
2.0 + 4.2 + 4.2 + 5.0	15.4	1.35	2.84	2.84	3.37		10.40	3.4 ~ 14.4	2300	450 ~ 3790	4.52	A	
2.0 + 4.2 + 4.2 + 6.0	16.4	1.27	2.66	2.66	3.81		10.40	3.4 ~ 14.4	2300	450 ~ 3790	4.52	A	
2.0 + 4.2 + 4.2 + 7.1	17.5	1.19	2.50	2.50	4.21		10.40	3.4 ~ 14.4	2290	460 ~ 3770	4.54	A	

	Indoor unit capacity Heating	Annual Energy Consumption (kWh)	Current 230V (A)	ERP				Moisture Removal Volume l/h
				Pdesign (kW)	SCOP		Annual Consumption (kWh)	
					W/W	CLASS		
4 Room	2.0 + 2.0 + 2.5 + 2.5	1185	11.1	8.50	4.40	A+	2705	
	2.0 + 2.0 + 2.5 + 3.5	1175	11.0	8.50	4.40	A+	2705	
	2.0 + 2.0 + 2.5 + 4.2	1170	11.0	8.50	4.40	A+	2705	
	2.0 + 2.0 + 2.5 + 5.0	1150	10.8	8.50	4.40	A+	2705	
	2.0 + 2.0 + 2.5 + 6.0	1150	10.8	8.50	4.40	A+	2705	
	2.0 + 2.0 + 2.5 + 7.1	1145	10.8	8.50	4.40	A+	2705	
	2.0 + 2.0 + 3.5 + 3.5	1165	10.9	8.50	4.40	A+	2705	
	2.0 + 2.0 + 3.5 + 4.2	1160	10.9	8.50	4.40	A+	2705	
	2.0 + 2.0 + 3.5 + 5.0	1140	10.7	8.50	4.40	A+	2705	
	2.0 + 2.0 + 3.5 + 6.0	1140	10.7	8.50	4.40	A+	2705	
	2.0 + 2.0 + 3.5 + 7.1	1160	10.9	8.50	4.40	A+	2705	
	2.0 + 2.0 + 4.2 + 4.2	1175	11.0	8.50	4.40	A+	2705	
	2.0 + 2.0 + 4.2 + 5.0	1160	10.9	8.50	4.40	A+	2705	
	2.0 + 2.0 + 4.2 + 6.0	1160	10.9	8.50	4.40	A+	2705	
	2.0 + 2.0 + 4.2 + 7.1	1155	10.9	8.50	4.40	A+	2705	
	2.0 + 2.0 + 5.0 + 5.0	1155	10.9	8.50	4.40	A+	2705	
	2.0 + 2.0 + 5.0 + 6.0	1155	10.9	8.50	4.40	A+	2705	
	2.0 + 2.0 + 5.0 + 7.1	1170	11.0	8.50	4.40	A+	2705	
	2.0 + 2.0 + 6.0 + 6.0	1155	10.9	8.50	4.40	A+	2705	
	2.0 + 2.0 + 6.0 + 7.1	1170	11.0	8.50	4.40	A+	2705	
	2.0 + 2.0 + 7.1 + 7.1	1170	11.0	8.50	4.40	A+	2705	
	2.0 + 2.5 + 2.5 + 2.5	1185	11.1	8.50	4.40	A+	2705	
	2.0 + 2.5 + 2.5 + 3.5	1175	11.0	8.50	4.40	A+	2705	
	2.0 + 2.5 + 2.5 + 4.2	1170	11.0	8.50	4.40	A+	2705	
	2.0 + 2.5 + 2.5 + 5.0	1150	10.8	8.50	4.40	A+	2705	
	2.0 + 2.5 + 2.5 + 6.0	1150	10.8	8.50	4.40	A+	2705	
	2.0 + 2.5 + 2.5 + 7.1	1145	10.8	8.50	4.40	A+	2705	
	2.0 + 2.5 + 3.5 + 3.5	1165	10.9	8.50	4.40	A+	2705	
	2.0 + 2.5 + 3.5 + 4.2	1160	10.9	8.50	4.40	A+	2705	
	2.0 + 2.5 + 3.5 + 5.0	1140	10.7	8.50	4.40	A+	2705	
	2.0 + 2.5 + 3.5 + 6.0	1140	10.7	8.50	4.40	A+	2705	
	2.0 + 2.5 + 3.5 + 7.1	1160	10.9	8.50	4.40	A+	2705	
	2.0 + 2.5 + 4.2 + 4.2	1175	11.0	8.50	4.40	A+	2705	
	2.0 + 2.5 + 4.2 + 5.0	1160	10.9	8.50	4.40	A+	2705	
	2.0 + 2.5 + 4.2 + 6.0	1160	10.9	8.50	4.40	A+	2705	
	2.0 + 2.5 + 4.2 + 7.1	1155	10.9	8.50	4.40	A+	2705	
	2.0 + 2.5 + 5.0 + 5.0	1155	10.9	8.50	4.40	A+	2705	
	2.0 + 2.5 + 5.0 + 6.0	1155	10.9	8.50	4.40	A+	2705	
	2.0 + 2.5 + 5.0 + 7.1	1170	11.0	8.50	4.40	A+	2705	
	2.0 + 2.5 + 6.0 + 6.0	1155	10.9	8.50	4.40	A+	2705	
	2.0 + 2.5 + 6.0 + 7.1	1170	11.0	8.50	4.40	A+	2705	
	2.0 + 3.5 + 3.5 + 3.5	1175	11.0	8.50	4.40	A+	2705	
2.0 + 3.5 + 3.5 + 4.2	1170	11.0	8.50	4.40	A+	2705		
2.0 + 3.5 + 3.5 + 5.0	1155	10.9	8.50	4.40	A+	2705		
2.0 + 3.5 + 3.5 + 6.0	1155	10.9	8.50	4.40	A+	2705		
2.0 + 3.5 + 3.5 + 7.1	1150	10.8	8.50	4.40	A+	2705		
2.0 + 3.5 + 4.2 + 4.2	1165	10.9	8.50	4.40	A+	2705		
2.0 + 3.5 + 4.2 + 5.0	1155	10.9	8.50	4.40	A+	2705		
2.0 + 3.5 + 4.2 + 6.0	1155	10.9	8.50	4.40	A+	2705		
2.0 + 3.5 + 4.2 + 7.1	1150	10.8	8.50	4.40	A+	2705		
2.0 + 3.5 + 5.0 + 5.0	1170	11.0	8.50	4.40	A+	2705		
2.0 + 3.5 + 5.0 + 6.0	1170	11.0	8.50	4.40	A+	2705		
2.0 + 3.5 + 5.0 + 7.1	1165	10.9	8.50	4.40	A+	2705		
2.0 + 3.5 + 6.0 + 6.0	1170	11.0	8.50	4.40	A+	2705		
2.0 + 4.2 + 4.2 + 4.2	1165	10.9	8.50	4.40	A+	2705		
2.0 + 4.2 + 4.2 + 5.0	1150	10.8	8.50	4.40	A+	2705		
2.0 + 4.2 + 4.2 + 6.0	1150	10.8	8.50	4.40	A+	2705		
2.0 + 4.2 + 4.2 + 7.1	1145	10.8	8.50	4.40	A+	2705		

Indoor unit capacity Heating	Total	Heating Capacity (kW)							Input Power (W)		COP	
		Room A	Room B	Room C	Room D	Room E	Total	min ~ max	Rating	min ~ max	WW	CLASS
2.0 + 4.2 + 5.0 + 5.0	16.2	1.28	2.70	3.21	3.21		10.40	3.4 ~ 14.4	2330	540 ~ 3730	4.46	A
2.0 + 4.2 + 5.0 + 6.0	17.2	1.21	2.54	3.02	3.63		10.40	3.4 ~ 14.4	2330	540 ~ 3730	4.46	A
2.0 + 4.2 + 5.0 + 7.1	18.3	1.14	2.39	2.84	4.03		10.40	3.4 ~ 14.4	2330	550 ~ 3710	4.46	A
2.0 + 4.2 + 6.0 + 6.0	18.2	1.14	2.40	3.43	3.43		10.40	3.4 ~ 14.4	2330	540 ~ 3730	4.46	A
2.0 + 5.0 + 5.0 + 5.0	17.0	1.22	3.06	3.06	3.06		10.40	3.4 ~ 14.4	2420	630 ~ 3730	4.30	A
2.0 + 5.0 + 5.0 + 6.0	18.0	1.16	2.89	2.89	3.46		10.40	3.4 ~ 14.4	2420	630 ~ 3730	4.30	A
2.5 + 2.5 + 2.5 + 2.5	10.0	2.60	2.60	2.60	2.60		10.40	3.4 ~ 14.2	2370	340 ~ 3950	4.39	A
2.5 + 2.5 + 2.5 + 3.5	11.0	2.36	2.36	2.36	3.32		10.40	3.4 ~ 14.2	2350	350 ~ 3920	4.43	A
2.5 + 2.5 + 2.5 + 4.2	11.7	2.22	2.22	2.22	3.74		10.40	3.4 ~ 14.2	2340	360 ~ 3900	4.44	A
2.5 + 2.5 + 2.5 + 5.0	12.5	2.08	2.08	2.08	4.16		10.40	3.4 ~ 14.2	2300	420 ~ 3760	4.52	A
2.5 + 2.5 + 2.5 + 6.0	13.5	1.93	1.93	1.93	4.61		10.40	3.4 ~ 14.4	2300	420 ~ 3820	4.52	A
2.5 + 2.5 + 2.5 + 7.1	14.6	1.78	1.78	1.78	5.06		10.40	3.4 ~ 14.4	2290	420 ~ 3800	4.54	A
2.5 + 2.5 + 3.5 + 3.5	12.0	2.17	2.17	3.03	3.03		10.40	3.4 ~ 14.2	2330	370 ~ 3820	4.46	A
2.5 + 2.5 + 3.5 + 4.2	12.7	2.05	2.05	2.87	3.43		10.40	3.4 ~ 14.2	2320	370 ~ 3810	4.48	A
2.5 + 2.5 + 3.5 + 5.0	13.5	1.93	1.93	2.70	3.84		10.40	3.4 ~ 14.4	2280	420 ~ 3790	4.56	A
2.5 + 2.5 + 3.5 + 6.0	14.5	1.79	1.79	2.51	4.31		10.40	3.4 ~ 14.4	2280	420 ~ 3790	4.56	A
2.5 + 2.5 + 3.5 + 7.1	15.6	1.67	1.67	2.33	4.73		10.40	3.4 ~ 14.4	2320	430 ~ 3770	4.48	A
2.5 + 2.5 + 4.2 + 4.2	13.4	1.94	1.94	3.26	3.26		10.40	3.4 ~ 14.4	2350	370 ~ 3920	4.43	A
2.5 + 2.5 + 4.2 + 5.0	14.2	1.83	1.83	3.08	3.66		10.40	3.4 ~ 14.4	2320	430 ~ 3780	4.48	A
2.5 + 2.5 + 4.2 + 6.0	15.2	1.71	1.71	2.87	4.11		10.40	3.4 ~ 14.4	2320	430 ~ 3780	4.48	A
2.5 + 2.5 + 4.2 + 7.1	16.3	1.60	1.60	2.68	4.52		10.40	3.4 ~ 14.4	2310	440 ~ 3820	4.50	A
2.5 + 2.5 + 5.0 + 5.0	15.0	1.73	1.73	3.47	3.47		10.40	3.4 ~ 14.4	2310	510 ~ 3760	4.50	A
2.5 + 2.5 + 5.0 + 6.0	16.0	1.63	1.63	3.25	3.89		10.40	3.4 ~ 14.4	2310	510 ~ 3760	4.50	A
2.5 + 2.5 + 5.0 + 7.1	17.1	1.52	1.52	3.04	4.32		10.40	3.4 ~ 14.4	2340	520 ~ 3750	4.44	A
2.5 + 2.5 + 6.0 + 6.0	17.0	1.53	1.53	3.67	3.67		10.40	3.4 ~ 14.4	2310	510 ~ 3760	4.50	A
2.5 + 2.5 + 6.0 + 7.1	18.1	1.44	1.44	3.45	4.07		10.40	3.4 ~ 14.4	2340	520 ~ 3750	4.44	A
2.5 + 3.5 + 3.5 + 3.5	13.0	2.00	2.80	2.80	2.80		10.40	3.4 ~ 14.4	2350	370 ~ 3910	4.43	A
2.5 + 3.5 + 3.5 + 4.2	13.7	1.90	2.66	2.66	3.18		10.40	3.4 ~ 14.4	2340	370 ~ 3890	4.44	A
2.5 + 3.5 + 3.5 + 5.0	14.5	1.79	2.51	2.51	3.59		10.40	3.4 ~ 14.4	2310	450 ~ 3810	4.50	A
2.5 + 3.5 + 3.5 + 6.0	15.5	1.68	2.35	2.35	4.02		10.40	3.4 ~ 14.4	2310	450 ~ 3810	4.50	A
2.5 + 3.5 + 3.5 + 7.1	16.6	1.57	2.19	2.19	4.45		10.40	3.4 ~ 14.4	2300	450 ~ 3800	4.52	A
2.5 + 3.5 + 4.2 + 4.2	14.4	1.81	2.53	3.03	3.03		10.40	3.4 ~ 14.4	2330	390 ~ 3880	4.46	A
2.5 + 3.5 + 4.2 + 5.0	15.2	1.71	2.39	2.87	3.43		10.40	3.4 ~ 14.4	2310	450 ~ 3800	4.50	A
2.5 + 3.5 + 4.2 + 6.0	16.2	1.60	2.25	2.70	3.85		10.40	3.4 ~ 14.4	2310	450 ~ 3800	4.50	A
2.5 + 3.5 + 4.2 + 7.1	17.3	1.50	2.10	2.52	4.28		10.40	3.4 ~ 14.4	2300	460 ~ 3790	4.52	A
2.5 + 3.5 + 5.0 + 5.0	16.0	1.62	2.28	3.25	3.25		10.40	3.4 ~ 14.4	2340	530 ~ 3740	4.44	A
2.5 + 3.5 + 5.0 + 6.0	17.0	1.53	2.14	3.06	3.67		10.40	3.4 ~ 14.4	2340	530 ~ 3740	4.44	A
2.5 + 3.5 + 5.0 + 7.1	18.1	1.44	2.01	2.87	4.08		10.40	3.4 ~ 14.4	2330	540 ~ 3720	4.46	A
2.5 + 3.5 + 6.0 + 6.0	18.0	1.44	2.02	3.47	3.47		10.40	3.4 ~ 14.4	2340	530 ~ 3740	4.44	A
2.5 + 4.2 + 4.2 + 4.2	15.1	1.73	2.89	2.89	2.89		10.40	3.4 ~ 14.4	2330	390 ~ 3870	4.46	A
2.5 + 4.2 + 4.2 + 5.0	15.9	1.64	2.75	2.75	3.26		10.40	3.4 ~ 14.4	2300	450 ~ 3790	4.52	A
2.5 + 4.2 + 4.2 + 6.0	16.9	1.54	2.58	2.58	3.70		10.40	3.4 ~ 14.4	2300	450 ~ 3790	4.52	A
2.5 + 4.2 + 4.2 + 7.1	18.0	1.44	2.43	2.43	4.10		10.40	3.4 ~ 14.4	2290	460 ~ 3770	4.54	A
2.5 + 4.2 + 5.0 + 5.0	16.7	1.56	2.62	3.11	3.11		10.40	3.4 ~ 14.4	2330	540 ~ 3730	4.46	A
2.5 + 4.2 + 5.0 + 6.0	17.7	1.47	2.47	2.94	3.52		10.40	3.4 ~ 14.4	2330	540 ~ 3730	4.46	A
2.5 + 5.0 + 5.0 + 5.0	17.5	1.49	2.97	2.97	2.97		10.40	3.4 ~ 14.4	2420	630 ~ 3730	4.30	A
3.5 + 3.5 + 3.5 + 3.5	14.0	2.60	2.60	2.60	2.60		10.40	3.4 ~ 14.4	2330	390 ~ 3870	4.46	A
3.5 + 3.5 + 3.5 + 4.2	14.7	2.48	2.48	2.48	2.96		10.40	3.4 ~ 14.4	2320	390 ~ 3860	4.48	A
3.5 + 3.5 + 3.5 + 5.0	15.5	2.35	2.35	2.35	3.35		10.40	3.4 ~ 14.4	2300	460 ~ 3780	4.52	A
3.5 + 3.5 + 3.5 + 6.0	16.5	2.21	2.21	2.21	3.77		10.40	3.4 ~ 14.4	2300	460 ~ 3780	4.52	A
3.5 + 3.5 + 3.5 + 7.1	17.6	2.07	2.07	2.07	4.19		10.40	3.4 ~ 14.4	2290	470 ~ 3770	4.54	A
3.5 + 3.5 + 4.2 + 4.2	15.4	2.36	2.36	2.84	2.84		10.40	3.4 ~ 14.4	2320	400 ~ 3850	4.48	A
3.5 + 3.5 + 4.2 + 5.0	16.2	2.25	2.25	2.70	3.20		10.40	3.4 ~ 14.4	2290	470 ~ 3770	4.54	A
3.5 + 3.5 + 4.2 + 6.0	17.2	2.12	2.12	2.54	3.62		10.40	3.4 ~ 14.4	2290	470 ~ 3770	4.54	A
3.5 + 3.5 + 4.2 + 7.1	18.3	1.99	1.99	2.39	4.03		10.40	3.4 ~ 14.4	2330	480 ~ 3760	4.46	A
3.5 + 3.5 + 5.0 + 5.0	17.0	2.14	2.14	3.06	3.06		10.40	3.4 ~ 14.4	2330	550 ~ 3710	4.46	A
3.5 + 3.5 + 5.0 + 6.0	18.0	2.02	2.02	2.89	3.47		10.40	3.4 ~ 14.4	2330	550 ~ 3710	4.46	A
3.5 + 4.2 + 4.2 + 4.2	16.1	2.27	2.71	2.71	2.71		10.40	3.4 ~ 14.4	2310	400 ~ 3830	4.50	A

	Indoor unit capacity Heating	Annual Energy Consumption (kWh)	Current 230V (A)	ERP			Moisture Removal Volume l/h	
				Pdesign (kW)	SCOP			Annual Consumption (kWh)
					W/W	CLASS		
4 Room	2.0 + 4.2 + 5.0 + 5.0	1165	10.9	8.50	4.40	A+	2705	
	2.0 + 4.2 + 5.0 + 6.0	1165	10.9	8.50	4.40	A+	2705	
	2.0 + 4.2 + 5.0 + 7.1	1165	10.9	8.50	4.40	A+	2705	
	2.0 + 4.2 + 6.0 + 6.0	1165	10.9	8.50	4.40	A+	2705	
	2.0 + 5.0 + 5.0 + 5.0	1210	11.4	8.50	4.40	A+	2705	
	2.0 + 5.0 + 5.0 + 6.0	1210	11.4	8.50	4.40	A+	2705	
	2.5 + 2.5 + 2.5 + 2.5	1185	11.1	8.50	4.40	A+	2705	
	2.5 + 2.5 + 2.5 + 3.5	1175	11.0	8.50	4.40	A+	2705	
	2.5 + 2.5 + 2.5 + 4.2	1170	11.0	8.50	4.40	A+	2705	
	2.5 + 2.5 + 2.5 + 5.0	1150	10.8	8.50	4.40	A+	2705	
	2.5 + 2.5 + 2.5 + 6.0	1150	10.8	8.50	4.40	A+	2705	
	2.5 + 2.5 + 2.5 + 7.1	1145	10.8	8.50	4.40	A+	2705	
	2.5 + 2.5 + 3.5 + 3.5	1165	10.9	8.50	4.40	A+	2705	
	2.5 + 2.5 + 3.5 + 4.2	1160	10.9	8.50	4.40	A+	2705	
	2.5 + 2.5 + 3.5 + 5.0	1140	10.7	8.50	4.40	A+	2705	
	2.5 + 2.5 + 3.5 + 6.0	1140	10.7	8.50	4.40	A+	2705	
	2.5 + 2.5 + 3.5 + 7.1	1160	10.9	8.50	4.40	A+	2705	
	2.5 + 2.5 + 4.2 + 4.2	1175	11.0	8.50	4.40	A+	2705	
	2.5 + 2.5 + 4.2 + 5.0	1160	10.9	8.50	4.40	A+	2705	
	2.5 + 2.5 + 4.2 + 6.0	1160	10.9	8.50	4.40	A+	2705	
	2.5 + 2.5 + 4.2 + 7.1	1155	10.9	8.50	4.40	A+	2705	
	2.5 + 2.5 + 5.0 + 5.0	1155	10.9	8.50	4.40	A+	2705	
	2.5 + 2.5 + 5.0 + 6.0	1155	10.9	8.50	4.40	A+	2705	
	2.5 + 2.5 + 5.0 + 7.1	1170	11.0	8.50	4.40	A+	2705	
	2.5 + 2.5 + 6.0 + 6.0	1155	10.9	8.50	4.40	A+	2705	
	2.5 + 2.5 + 6.0 + 7.1	1170	11.0	8.50	4.40	A+	2705	
	2.5 + 3.5 + 3.5 + 3.5	1175	11.0	8.50	4.40	A+	2705	
	2.5 + 3.5 + 3.5 + 4.2	1170	11.0	8.50	4.40	A+	2705	
	2.5 + 3.5 + 3.5 + 5.0	1155	10.9	8.50	4.40	A+	2705	
	2.5 + 3.5 + 3.5 + 6.0	1155	10.9	8.50	4.40	A+	2705	
	2.5 + 3.5 + 3.5 + 7.1	1150	10.8	8.50	4.40	A+	2705	
	2.5 + 3.5 + 4.2 + 4.2	1165	10.9	8.50	4.40	A+	2705	
	2.5 + 3.5 + 4.2 + 5.0	1155	10.9	8.50	4.40	A+	2705	
	2.5 + 3.5 + 4.2 + 6.0	1155	10.9	8.50	4.40	A+	2705	
	2.5 + 3.5 + 4.2 + 7.1	1150	10.8	8.50	4.40	A+	2705	
	2.5 + 3.5 + 5.0 + 5.0	1170	11.0	8.50	4.40	A+	2705	
	2.5 + 3.5 + 5.0 + 6.0	1170	11.0	8.50	4.40	A+	2705	
	2.5 + 3.5 + 5.0 + 7.1	1165	10.9	8.50	4.40	A+	2705	
	2.5 + 3.5 + 6.0 + 6.0	1170	11.0	8.50	4.40	A+	2705	
	2.5 + 4.2 + 4.2 + 4.2	1165	10.9	8.50	4.40	A+	2705	
	2.5 + 4.2 + 4.2 + 5.0	1150	10.8	8.50	4.40	A+	2705	
	2.5 + 4.2 + 4.2 + 6.0	1150	10.8	8.50	4.40	A+	2705	
2.5 + 4.2 + 4.2 + 7.1	1145	10.8	8.50	4.40	A+	2705		
2.5 + 4.2 + 5.0 + 5.0	1165	10.9	8.50	4.40	A+	2705		
2.5 + 4.2 + 5.0 + 6.0	1165	10.9	8.50	4.40	A+	2705		
2.5 + 5.0 + 5.0 + 5.0	1210	11.4	8.50	4.40	A+	2705		
3.5 + 3.5 + 3.5 + 3.5	1165	10.9	8.50	4.40	A+	2705		
3.5 + 3.5 + 3.5 + 4.2	1160	10.9	8.50	4.40	A+	2705		
3.5 + 3.5 + 3.5 + 5.0	1150	10.8	8.50	4.40	A+	2705		
3.5 + 3.5 + 3.5 + 6.0	1150	10.8	8.50	4.40	A+	2705		
3.5 + 3.5 + 3.5 + 7.1	1145	10.8	8.50	4.40	A+	2705		
3.5 + 3.5 + 4.2 + 4.2	1160	10.9	8.50	4.40	A+	2705		
3.5 + 3.5 + 4.2 + 5.0	1145	10.8	8.50	4.40	A+	2705		
3.5 + 3.5 + 4.2 + 6.0	1145	10.8	8.50	4.40	A+	2705		
3.5 + 3.5 + 4.2 + 7.1	1165	10.9	8.50	4.40	A+	2705		
3.5 + 3.5 + 5.0 + 5.0	1165	10.9	8.50	4.40	A+	2705		
3.5 + 3.5 + 5.0 + 6.0	1165	10.9	8.50	4.40	A+	2705		
3.5 + 4.2 + 4.2 + 4.2	1155	10.9	8.50	4.40	A+	2705		

Indoor unit capacity Heating		Total	Heating Capacity (kW)							Input Power (W)		COP	
			Room A	Room B	Room C	Room D	Room E	Total	min ~ max	Rating	min ~ max	WW	CLASS
4 Room	3.5 + 4.2 + 4.2 + 5.0	16.9	2.15	2.58	2.58	3.09		10.40	3.4 ~ 14.4	2330	480 ~ 3760	4.46	A
	3.5 + 4.2 + 4.2 + 6.0	17.9	2.03	2.44	2.44	3.49		10.40	3.4 ~ 14.4	2330	480 ~ 3760	4.46	A
	3.5 + 4.2 + 5.0 + 5.0	17.7	2.05	2.47	2.94	2.94		10.40	3.4 ~ 14.4	2360	560 ~ 3700	4.41	A
	4.2 + 4.2 + 4.2 + 4.2	16.8	2.60	2.60	2.60	2.60		10.40	3.4 ~ 14.4	2300	400 ~ 3820	4.52	A
	4.2 + 4.2 + 4.2 + 5.0	17.6	2.48	2.48	2.48	2.96		10.40	3.4 ~ 14.4	2320	480 ~ 3750	4.48	A

	Indoor unit capacity Heating	Annual Energy Consumption (kWh)	Current 230V (A)	ERP				Moisture Removal Volume l/h
				Pdesign (kW)	SCOP		Annual Consumption (kWh)	
					W/W	CLASS		
4 Room	3.5 + 4.2 + 4.2 + 5.0	1165	10.9	8.50	4.40	A+	2705	
	3.5 + 4.2 + 4.2 + 6.0	1165	10.9	8.50	4.40	A+	2705	
	3.5 + 4.2 + 5.0 + 5.0	1180	11.1	8.50	4.40	A+	2705	
	4.2 + 4.2 + 4.2 + 4.2	1150	10.8	8.50	4.40	A+	2705	
	4.2 + 4.2 + 4.2 + 5.0	1160	10.9	8.50	4.40	A+	2705	

Indoor unit capacity Heating		Total	Heating Capacity (kW)						Input Power (W)			COP	
			Room A	Room B	Room C	Room D	Room E	Total	min ~ max	Rating	min ~ max	WW	CLASS
5 Room	1.6 + 1.6 + 1.6 + 1.6 + 1.6	8.0	2.08	2.08	2.08	2.08	2.08	10.40	3.4 ~ 14.5	2360	430 ~ 3870	4.41	A
	1.6 + 1.6 + 1.6 + 1.6 + 2.0	8.4	1.98	1.98	1.98	1.98	2.48	10.40	3.4 ~ 14.5	2350	440 ~ 3860	4.43	A
	1.6 + 1.6 + 1.6 + 1.6 + 2.5	8.9	1.87	1.87	1.87	1.87	2.92	10.40	3.4 ~ 14.5	2350	440 ~ 3860	4.43	A
	1.6 + 1.6 + 1.6 + 1.6 + 3.5	9.9	1.68	1.68	1.68	1.68	3.68	10.40	3.4 ~ 14.5	2340	450 ~ 3830	4.44	A
	1.6 + 1.6 + 1.6 + 1.6 + 4.2	10.6	1.57	1.57	1.57	1.57	4.12	10.40	3.4 ~ 14.5	2340	460 ~ 3870	4.44	A
	1.6 + 1.6 + 1.6 + 1.6 + 5.0	11.4	1.46	1.46	1.46	1.46	4.56	10.40	3.4 ~ 14.5	2370	540 ~ 3810	4.39	A
	1.6 + 1.6 + 1.6 + 1.6 + 6.0	12.4	1.34	1.34	1.34	1.34	5.04	10.40	3.4 ~ 14.5	2370	540 ~ 3810	4.39	A
	1.6 + 1.6 + 1.6 + 1.6 + 7.1	13.5	1.23	1.23	1.23	1.23	5.48	10.40	3.4 ~ 14.5	2410	560 ~ 3800	4.32	A
	1.6 + 1.6 + 1.6 + 2.0 + 2.0	8.8	1.89	1.89	1.89	2.36	2.36	10.39	3.4 ~ 14.5	2350	450 ~ 3850	4.42	A
	1.6 + 1.6 + 1.6 + 2.0 + 2.5	9.3	1.79	1.79	1.79	2.24	2.79	10.40	3.4 ~ 14.5	2350	450 ~ 3850	4.43	A
	1.6 + 1.6 + 1.6 + 2.0 + 3.5	10.3	1.62	1.62	1.62	2.02	3.52	10.40	3.4 ~ 14.5	2340	460 ~ 3870	4.44	A
	1.6 + 1.6 + 1.6 + 2.0 + 4.2	11.0	1.51	1.51	1.51	1.89	3.98	10.40	3.4 ~ 14.5	2330	470 ~ 3860	4.46	A
	1.6 + 1.6 + 1.6 + 2.0 + 5.0	11.8	1.41	1.41	1.41	1.76	4.41	10.40	3.4 ~ 14.5	2370	560 ~ 3800	4.39	A
	1.6 + 1.6 + 1.6 + 2.0 + 6.0	12.8	1.30	1.30	1.30	1.63	4.87	10.40	3.4 ~ 14.5	2370	560 ~ 3800	4.39	A
	1.6 + 1.6 + 1.6 + 2.0 + 7.1	13.9	1.20	1.20	1.20	1.50	5.30	10.40	3.4 ~ 14.5	2400	570 ~ 3790	4.33	A
	1.6 + 1.6 + 1.6 + 2.5 + 2.5	9.8	1.70	1.70	1.70	2.65	2.65	10.40	3.4 ~ 14.5	2350	450 ~ 3850	4.43	A
	1.6 + 1.6 + 1.6 + 2.5 + 3.5	10.8	1.54	1.54	1.54	2.41	3.37	10.40	3.4 ~ 14.5	2340	460 ~ 3870	4.44	A
	1.6 + 1.6 + 1.6 + 2.5 + 4.2	11.5	1.45	1.45	1.45	2.26	3.79	10.40	3.4 ~ 14.5	2330	470 ~ 3860	4.46	A
	1.6 + 1.6 + 1.6 + 2.5 + 5.0	12.3	1.35	1.35	1.35	2.11	4.24	10.40	3.4 ~ 14.5	2370	560 ~ 3800	4.39	A
	1.6 + 1.6 + 1.6 + 2.5 + 6.0	13.3	1.25	1.25	1.25	1.95	4.70	10.40	3.4 ~ 14.5	2370	560 ~ 3800	4.39	A
	1.6 + 1.6 + 1.6 + 2.5 + 7.1	14.4	1.16	1.16	1.16	1.81	5.11	10.40	3.4 ~ 14.5	2400	570 ~ 3790	4.33	A
	1.6 + 1.6 + 1.6 + 3.5 + 3.5	11.8	1.41	1.41	1.41	3.08	3.08	10.39	3.4 ~ 14.5	2360	480 ~ 3840	4.40	A
	1.6 + 1.6 + 1.6 + 3.5 + 4.2	12.5	1.33	1.33	1.33	2.91	3.50	10.40	3.4 ~ 14.5	2360	490 ~ 3830	4.41	A
	1.6 + 1.6 + 1.6 + 3.5 + 5.0	13.3	1.25	1.25	1.25	2.74	3.91	10.40	3.4 ~ 14.5	2400	570 ~ 3830	4.33	A
	1.6 + 1.6 + 1.6 + 3.5 + 6.0	14.3	1.16	1.16	1.16	2.55	4.37	10.40	3.4 ~ 14.5	2400	570 ~ 3830	4.33	A
	1.6 + 1.6 + 1.6 + 3.5 + 7.1	15.4	1.08	1.08	1.08	2.36	4.80	10.40	3.4 ~ 14.5	2400	590 ~ 3820	4.33	A
	1.6 + 1.6 + 1.6 + 4.2 + 4.2	13.2	1.26	1.26	1.26	3.31	3.31	10.40	3.4 ~ 14.5	2350	500 ~ 3820	4.43	A
	1.6 + 1.6 + 1.6 + 4.2 + 5.0	14.0	1.19	1.19	1.19	3.12	3.71	10.40	3.4 ~ 14.5	2400	590 ~ 3820	4.33	A
	1.6 + 1.6 + 1.6 + 4.2 + 6.0	15.0	1.11	1.11	1.11	2.91	4.16	10.40	3.4 ~ 14.5	2400	590 ~ 3820	4.33	A
	1.6 + 1.6 + 1.6 + 4.2 + 7.1	16.1	1.03	1.03	1.03	2.71	4.60	10.40	3.4 ~ 14.5	2430	600 ~ 3810	4.28	A
	1.6 + 1.6 + 1.6 + 5.0 + 5.0	14.8	1.12	1.12	1.12	3.52	3.52	10.40	3.4 ~ 14.5	2490	690 ~ 3830	4.18	A
	1.6 + 1.6 + 1.6 + 5.0 + 6.0	15.8	1.05	1.05	1.05	3.29	3.96	10.40	3.4 ~ 14.5	2490	690 ~ 3830	4.18	A
	1.6 + 1.6 + 1.6 + 5.0 + 7.1	16.9	0.98	0.98	0.98	3.08	4.38	10.40	3.4 ~ 14.5	2490	710 ~ 3820	4.18	A
	1.6 + 1.6 + 1.6 + 6.0 + 6.0	16.8	0.99	0.99	0.99	3.71	3.71	10.39	3.4 ~ 14.5	2490	690 ~ 3830	4.17	A
	1.6 + 1.6 + 1.6 + 6.0 + 7.1	17.9	0.93	0.93	0.93	3.49	4.12	10.40	3.4 ~ 14.5	2490	710 ~ 3820	4.18	A
	1.6 + 1.6 + 2.0 + 2.0 + 2.0	9.2	1.81	1.81	2.26	2.26	2.26	10.40	3.4 ~ 14.5	2340	450 ~ 3840	4.44	A
	1.6 + 1.6 + 2.0 + 2.0 + 2.5	9.7	1.72	1.72	2.14	2.14	2.68	10.40	3.4 ~ 14.5	2340	450 ~ 3840	4.44	A
	1.6 + 1.6 + 2.0 + 2.0 + 3.5	10.7	1.56	1.56	1.94	1.94	3.40	10.40	3.4 ~ 14.5	2330	470 ~ 3860	4.46	A
	1.6 + 1.6 + 2.0 + 2.0 + 4.2	11.4	1.46	1.46	1.82	1.82	3.84	10.40	3.4 ~ 14.5	2370	480 ~ 3850	4.39	A
	1.6 + 1.6 + 2.0 + 2.0 + 5.0	12.2	1.36	1.36	1.70	1.70	4.28	10.40	3.4 ~ 14.5	2400	560 ~ 3790	4.33	A
1.6 + 1.6 + 2.0 + 2.0 + 6.0	13.2	1.26	1.26	1.58	1.58	4.72	10.40	3.4 ~ 14.5	2400	560 ~ 3790	4.33	A	
1.6 + 1.6 + 2.0 + 2.0 + 7.1	14.3	1.16	1.16	1.45	1.45	5.18	10.40	3.4 ~ 14.5	2400	570 ~ 3780	4.33	A	
1.6 + 1.6 + 2.0 + 2.5 + 2.5	10.2	1.63	1.63	2.04	2.55	2.55	10.40	3.4 ~ 14.5	2340	450 ~ 3840	4.44	A	
1.6 + 1.6 + 2.0 + 2.5 + 3.5	11.2	1.49	1.49	1.86	2.32	3.24	10.40	3.4 ~ 14.5	2330	470 ~ 3860	4.46	A	
1.6 + 1.6 + 2.0 + 2.5 + 4.2	11.9	1.40	1.40	1.75	2.18	3.67	10.40	3.4 ~ 14.5	2370	480 ~ 3850	4.39	A	
1.6 + 1.6 + 2.0 + 2.5 + 5.0	12.7	1.31	1.31	1.64	2.05	4.09	10.40	3.4 ~ 14.5	2400	560 ~ 3790	4.33	A	
1.6 + 1.6 + 2.0 + 2.5 + 6.0	13.7	1.21	1.21	1.52	1.90	4.56	10.40	3.4 ~ 14.5	2400	560 ~ 3790	4.33	A	
1.6 + 1.6 + 2.0 + 2.5 + 7.1	14.8	1.12	1.12	1.41	1.76	4.99	10.40	3.4 ~ 14.5	2400	570 ~ 3780	4.33	A	
1.6 + 1.6 + 2.0 + 3.5 + 3.5	12.2	1.36	1.36	1.72	2.98	2.98	10.40	3.4 ~ 14.5	2360	490 ~ 3830	4.41	A	
1.6 + 1.6 + 2.0 + 3.5 + 4.2	12.9	1.29	1.29	1.61	2.82	3.39	10.40	3.4 ~ 14.5	2350	500 ~ 3820	4.43	A	
1.6 + 1.6 + 2.0 + 3.5 + 5.0	13.7	1.21	1.21	1.52	2.66	3.80	10.40	3.4 ~ 14.5	2400	590 ~ 3820	4.33	A	
1.6 + 1.6 + 2.0 + 3.5 + 6.0	14.7	1.13	1.13	1.41	2.48	4.25	10.40	3.4 ~ 14.5	2400	590 ~ 3820	4.33	A	
1.6 + 1.6 + 2.0 + 3.5 + 7.1	15.8	1.05	1.05	1.32	2.30	4.68	10.40	3.4 ~ 14.5	2430	600 ~ 3810	4.28	A	
1.6 + 1.6 + 2.0 + 4.2 + 4.2	13.6	1.22	1.22	1.54	3.21	3.21	10.40	3.4 ~ 14.5	2350	510 ~ 3810	4.43	A	
1.6 + 1.6 + 2.0 + 4.2 + 5.0	14.4	1.16	1.16	1.44	3.03	3.61	10.40	3.4 ~ 14.5	2390	600 ~ 3810	4.35	A	
1.6 + 1.6 + 2.0 + 4.2 + 6.0	15.4	1.08	1.08	1.35	2.84	4.05	10.40	3.4 ~ 14.5	2390	600 ~ 3810	4.35	A	
1.6 + 1.6 + 2.0 + 4.2 + 7.1	16.5	1.01	1.01	1.26	2.65	4.47	10.40	3.4 ~ 14.5	2430	600 ~ 3800	4.28	A	
1.6 + 1.6 + 2.0 + 5.0 + 5.0	15.2	1.09	1.09	1.38	3.42	3.42	10.40	3.4 ~ 14.5	2490	700 ~ 3820	4.18	A	



	Indoor unit capacity Heating	Annual Energy Consumption (kWh)	Current 230V (A)	ERP				Moisture Removal Volume l/h
				Pdesign (kW)	SCOP		Annual Consumption (kWh)	
					W/W	CLASS		
5 Room	1.6 + 1.6 + 1.6 + 1.6 + 1.6	1180	11.1	8.50	4.40	A+	2705	
	1.6 + 1.6 + 1.6 + 1.6 + 2.0	1175	11.0	8.50	4.50	A+	2644	
	1.6 + 1.6 + 1.6 + 1.6 + 2.5	1175	11.0	8.50	4.68	A++	2543	
	1.6 + 1.6 + 1.6 + 1.6 + 3.5	1170	11.0	8.50	4.68	A++	2543	
	1.6 + 1.6 + 1.6 + 1.6 + 4.2	1170	11.0	8.50	4.68	A++	2543	
	1.6 + 1.6 + 1.6 + 1.6 + 5.0	1185	11.1	8.50	4.68	A++	2543	
	1.6 + 1.6 + 1.6 + 1.6 + 6.0	1185	11.1	8.50	4.68	A++	2543	
	1.6 + 1.6 + 1.6 + 1.6 + 7.1	1205	11.3	8.50	4.68	A++	2543	
	1.6 + 1.6 + 1.6 + 2.0 + 2.0	1175	11.0	8.50	4.60	A++	2587	
	1.6 + 1.6 + 1.6 + 2.0 + 2.5	1175	11.0	8.50	4.68	A++	2543	
	1.6 + 1.6 + 1.6 + 2.0 + 3.5	1170	11.0	8.50	4.68	A++	2543	
	1.6 + 1.6 + 1.6 + 2.0 + 4.2	1165	10.9	8.50	4.68	A++	2543	
	1.6 + 1.6 + 1.6 + 2.0 + 5.0	1185	11.1	8.50	4.68	A++	2543	
	1.6 + 1.6 + 1.6 + 2.0 + 6.0	1185	11.1	8.50	4.68	A++	2543	
	1.6 + 1.6 + 1.6 + 2.0 + 7.1	1200	11.3	8.50	4.68	A++	2543	
	1.6 + 1.6 + 1.6 + 2.5 + 2.5	1175	11.0	8.50	4.68	A++	2543	
	1.6 + 1.6 + 1.6 + 2.5 + 3.5	1170	11.0	8.50	4.68	A++	2543	
	1.6 + 1.6 + 1.6 + 2.5 + 4.2	1165	10.9	8.50	4.68	A++	2543	
	1.6 + 1.6 + 1.6 + 2.5 + 5.0	1185	11.1	8.50	4.68	A++	2543	
	1.6 + 1.6 + 1.6 + 2.5 + 6.0	1185	11.1	8.50	4.68	A++	2543	
	1.6 + 1.6 + 1.6 + 2.5 + 7.1	1200	11.3	8.50	4.68	A++	2543	
	1.6 + 1.6 + 1.6 + 3.5 + 3.5	1180	11.1	8.50	4.68	A++	2543	
	1.6 + 1.6 + 1.6 + 3.5 + 4.2	1180	11.1	8.50	4.68	A++	2543	
	1.6 + 1.6 + 1.6 + 3.5 + 5.0	1200	11.3	8.50	4.68	A++	2543	
	1.6 + 1.6 + 1.6 + 3.5 + 6.0	1200	11.3	8.50	4.68	A++	2543	
	1.6 + 1.6 + 1.6 + 3.5 + 7.1	1200	11.3	8.50	4.68	A++	2543	
	1.6 + 1.6 + 1.6 + 4.2 + 4.2	1175	11.0	8.50	4.68	A++	2543	
	1.6 + 1.6 + 1.6 + 4.2 + 5.0	1200	11.3	8.50	4.68	A++	2543	
	1.6 + 1.6 + 1.6 + 4.2 + 6.0	1200	11.3	8.50	4.68	A++	2543	
	1.6 + 1.6 + 1.6 + 4.2 + 7.1	1215	11.4	8.50	4.68	A++	2543	
	1.6 + 1.6 + 1.6 + 5.0 + 5.0	1245	11.7	8.50	4.68	A++	2543	
	1.6 + 1.6 + 1.6 + 5.0 + 6.0	1245	11.7	8.50	4.68	A++	2543	
	1.6 + 1.6 + 1.6 + 5.0 + 7.1	1245	11.7	8.50	4.68	A++	2543	
	1.6 + 1.6 + 1.6 + 6.0 + 6.0	1245	11.7	8.50	4.68	A++	2543	
	1.6 + 1.6 + 1.6 + 6.0 + 7.1	1245	11.7	8.50	4.68	A++	2543	
	1.6 + 1.6 + 2.0 + 2.0 + 2.0	1170	11.0	8.50	4.68	A++	2543	
	1.6 + 1.6 + 2.0 + 2.0 + 2.5	1170	11.0	8.50	4.68	A++	2543	
	1.6 + 1.6 + 2.0 + 2.0 + 3.5	1165	10.9	8.50	4.68	A++	2543	
	1.6 + 1.6 + 2.0 + 2.0 + 4.2	1185	11.1	8.50	4.68	A++	2543	
	1.6 + 1.6 + 2.0 + 2.0 + 5.0	1200	11.3	8.50	4.68	A++	2543	
1.6 + 1.6 + 2.0 + 2.0 + 6.0	1200	11.3	8.50	4.68	A++	2543		
1.6 + 1.6 + 2.0 + 2.0 + 7.1	1200	11.3	8.50	4.68	A++	2543		
1.6 + 1.6 + 2.0 + 2.5 + 2.5	1170	11.0	8.50	4.68	A++	2543		
1.6 + 1.6 + 2.0 + 2.5 + 3.5	1165	10.9	8.50	4.68	A++	2543		
1.6 + 1.6 + 2.0 + 2.5 + 4.2	1185	11.1	8.50	4.68	A++	2543		
1.6 + 1.6 + 2.0 + 2.5 + 5.0	1200	11.3	8.50	4.68	A++	2543		
1.6 + 1.6 + 2.0 + 2.5 + 6.0	1200	11.3	8.50	4.68	A++	2543		
1.6 + 1.6 + 2.0 + 2.5 + 7.1	1200	11.3	8.50	4.68	A++	2543		
1.6 + 1.6 + 2.0 + 3.5 + 3.5	1180	11.1	8.50	4.68	A++	2543		
1.6 + 1.6 + 2.0 + 3.5 + 4.2	1175	11.0	8.50	4.68	A++	2543		
1.6 + 1.6 + 2.0 + 3.5 + 5.0	1200	11.3	8.50	4.68	A++	2543		
1.6 + 1.6 + 2.0 + 3.5 + 6.0	1200	11.3	8.50	4.68	A++	2543		
1.6 + 1.6 + 2.0 + 3.5 + 7.1	1215	11.4	8.50	4.68	A++	2543		
1.6 + 1.6 + 2.0 + 4.2 + 4.2	1175	11.0	8.50	4.68	A++	2543		
1.6 + 1.6 + 2.0 + 4.2 + 5.0	1195	11.2	8.50	4.68	A++	2543		
1.6 + 1.6 + 2.0 + 4.2 + 6.0	1195	11.2	8.50	4.68	A++	2543		
1.6 + 1.6 + 2.0 + 4.2 + 7.1	1215	11.4	8.50	4.68	A++	2543		
1.6 + 1.6 + 2.0 + 5.0 + 5.0	1245	11.7	8.50	4.68	A++	2543		

Indoor unit capacity Heating	Total	Heating Capacity (kW)							Input Power (W)			COP	
		Room A	Room B	Room C	Room D	Room E	Total	min ~ max	Rating	min ~ max	WW	CLASS	
1.6 + 1.6 + 2.0 + 5.0 + 6.0	16.2	1.03	1.03	1.28	3.21	3.85	10.40	3.4 ~ 14.5	2490	700 ~ 3820	4.18	A	
1.6 + 1.6 + 2.0 + 5.0 + 7.1	17.3	0.96	0.96	1.20	3.01	4.27	10.40	3.4 ~ 14.5	2530	710 ~ 3860	4.11	A	
1.6 + 1.6 + 2.0 + 6.0 + 6.0	17.2	0.97	0.97	1.20	3.63	3.63	10.40	3.4 ~ 14.5	2490	700 ~ 3820	4.18	A	
1.6 + 1.6 + 2.0 + 6.0 + 7.1	18.3	0.91	0.91	1.14	3.41	4.03	10.40	3.4 ~ 14.5	2530	710 ~ 3860	4.11	A	
1.6 + 1.6 + 2.5 + 2.5 + 2.5	10.7	1.55	1.55	2.43	2.43	2.43	10.39	3.4 ~ 14.5	2340	450 ~ 3840	4.44	A	
1.6 + 1.6 + 2.5 + 2.5 + 3.5	11.7	1.42	1.42	2.22	2.22	3.12	10.40	3.4 ~ 14.5	2330	470 ~ 3860	4.46	A	
1.6 + 1.6 + 2.5 + 2.5 + 4.2	12.4	1.34	1.34	2.10	2.10	3.52	10.40	3.4 ~ 14.5	2370	480 ~ 3850	4.39	A	
1.6 + 1.6 + 2.5 + 2.5 + 5.0	13.2	1.26	1.26	1.97	1.97	3.94	10.40	3.4 ~ 14.5	2400	560 ~ 3790	4.33	A	
1.6 + 1.6 + 2.5 + 2.5 + 6.0	14.2	1.17	1.17	1.83	1.83	4.40	10.40	3.4 ~ 14.5	2400	560 ~ 3790	4.33	A	
1.6 + 1.6 + 2.5 + 2.5 + 7.1	15.3	1.09	1.09	1.70	1.70	4.82	10.40	3.4 ~ 14.5	2400	570 ~ 3780	4.33	A	
1.6 + 1.6 + 2.5 + 3.5 + 3.5	12.7	1.31	1.31	2.04	2.87	2.87	10.40	3.4 ~ 14.5	2360	490 ~ 3830	4.41	A	
1.6 + 1.6 + 2.5 + 3.5 + 4.2	13.4	1.24	1.24	1.94	2.72	3.26	10.40	3.4 ~ 14.5	2350	500 ~ 3820	4.43	A	
1.6 + 1.6 + 2.5 + 3.5 + 5.0	14.2	1.17	1.17	1.83	2.56	3.67	10.40	3.4 ~ 14.5	2400	590 ~ 3820	4.33	A	
1.6 + 1.6 + 2.5 + 3.5 + 6.0	15.2	1.09	1.09	1.71	2.39	4.12	10.40	3.4 ~ 14.5	2400	590 ~ 3820	4.33	A	
1.6 + 1.6 + 2.5 + 3.5 + 7.1	16.3	1.02	1.02	1.60	2.23	4.53	10.40	3.4 ~ 14.5	2430	600 ~ 3810	4.28	A	
1.6 + 1.6 + 2.5 + 4.2 + 4.2	14.1	1.18	1.18	1.84	3.10	3.10	10.40	3.4 ~ 14.5	2350	510 ~ 3810	4.43	A	
1.6 + 1.6 + 2.5 + 4.2 + 5.0	14.9	1.12	1.12	1.74	2.93	3.49	10.40	3.4 ~ 14.5	2390	600 ~ 3810	4.35	A	
1.6 + 1.6 + 2.5 + 4.2 + 6.0	15.9	1.05	1.05	1.64	2.75	3.91	10.40	3.4 ~ 14.5	2390	600 ~ 3810	4.35	A	
1.6 + 1.6 + 2.5 + 4.2 + 7.1	17.0	0.98	0.98	1.53	2.57	4.34	10.40	3.4 ~ 14.5	2430	600 ~ 3800	4.28	A	
1.6 + 1.6 + 2.5 + 5.0 + 5.0	15.7	1.06	1.06	1.66	3.31	3.31	10.40	3.4 ~ 14.5	2490	700 ~ 3820	4.18	A	
1.6 + 1.6 + 2.5 + 5.0 + 6.0	16.7	1.00	1.00	1.56	3.11	3.73	10.40	3.4 ~ 14.5	2490	700 ~ 3820	4.18	A	
1.6 + 1.6 + 2.5 + 5.0 + 7.1	17.8	0.93	0.93	1.46	2.92	4.16	10.40	3.4 ~ 14.5	2530	710 ~ 3860	4.11	A	
1.6 + 1.6 + 2.5 + 6.0 + 6.0	17.7	0.94	0.94	1.46	3.53	3.53	10.40	3.4 ~ 14.5	2490	700 ~ 3820	4.18	A	
1.6 + 1.6 + 3.5 + 3.5 + 3.5	13.7	1.21	1.21	2.66	2.66	2.66	10.40	3.4 ~ 14.5	2350	510 ~ 3800	4.43	A	
1.6 + 1.6 + 3.5 + 3.5 + 4.2	14.4	1.16	1.16	2.53	2.53	3.02	10.40	3.4 ~ 14.5	2380	510 ~ 3790	4.37	A	
1.6 + 1.6 + 3.5 + 3.5 + 5.0	15.2	1.09	1.09	2.39	2.39	3.44	10.40	3.4 ~ 14.5	2430	610 ~ 3790	4.28	A	
1.6 + 1.6 + 3.5 + 3.5 + 6.0	16.2	1.03	1.03	2.25	2.25	3.84	10.40	3.4 ~ 14.5	2430	610 ~ 3790	4.28	A	
1.6 + 1.6 + 3.5 + 3.5 + 7.1	17.3	0.96	0.96	2.10	2.10	4.28	10.40	3.4 ~ 14.5	2430	620 ~ 3780	4.28	A	
1.6 + 1.6 + 3.5 + 4.2 + 4.2	15.1	1.10	1.10	2.42	2.89	2.89	10.40	3.4 ~ 14.5	2380	520 ~ 3840	4.37	A	
1.6 + 1.6 + 3.5 + 4.2 + 5.0	15.9	1.05	1.05	2.29	2.75	3.26	10.40	3.4 ~ 14.5	2430	620 ~ 3790	4.28	A	
1.6 + 1.6 + 3.5 + 4.2 + 6.0	16.9	0.98	0.98	2.15	2.58	3.71	10.40	3.4 ~ 14.5	2430	620 ~ 3790	4.28	A	
1.6 + 1.6 + 3.5 + 4.2 + 7.1	18.0	0.92	0.92	2.02	2.43	4.11	10.40	3.4 ~ 14.5	2420	630 ~ 3830	4.30	A	
1.6 + 1.6 + 3.5 + 5.0 + 5.0	16.7	1.00	1.00	2.18	3.11	3.11	10.40	3.4 ~ 14.5	2530	720 ~ 3850	4.11	A	
1.6 + 1.6 + 3.5 + 5.0 + 6.0	17.7	0.94	0.94	2.06	2.94	3.52	10.40	3.4 ~ 14.5	2530	720 ~ 3850	4.11	A	
1.6 + 1.6 + 4.2 + 4.2 + 4.2	15.8	1.06	1.06	2.76	2.76	2.76	10.40	3.4 ~ 14.5	2380	530 ~ 3830	4.37	A	
1.6 + 1.6 + 4.2 + 4.2 + 5.0	16.6	1.00	1.00	2.63	2.63	3.14	10.40	3.4 ~ 14.5	2430	630 ~ 3830	4.28	A	
1.6 + 1.6 + 4.2 + 4.2 + 6.0	17.6	0.95	0.95	2.48	2.48	3.54	10.40	3.4 ~ 14.5	2430	630 ~ 3830	4.28	A	
1.6 + 1.6 + 4.2 + 5.0 + 5.0	17.4	0.96	0.96	2.50	2.99	2.99	10.40	3.4 ~ 14.5	2530	740 ~ 3850	4.11	A	
1.6 + 1.6 + 5.0 + 5.0 + 5.0	18.2	0.91	0.91	2.86	2.86	2.86	10.40	3.4 ~ 14.5	2680	860 ~ 3930	3.88	A	
1.6 + 2.0 + 2.0 + 2.0 + 2.0	9.6	1.72	2.17	2.17	2.17	2.17	10.40	3.4 ~ 14.5	2340	460 ~ 3880	4.44	A	
1.6 + 2.0 + 2.0 + 2.0 + 2.5	10.1	1.65	2.06	2.06	2.06	2.57	10.40	3.4 ~ 14.5	2340	460 ~ 3880	4.44	A	
1.6 + 2.0 + 2.0 + 2.0 + 3.5	11.1	1.50	1.87	1.87	1.87	3.29	10.40	3.4 ~ 14.5	2370	480 ~ 3850	4.39	A	
1.6 + 2.0 + 2.0 + 2.0 + 4.2	11.8	1.41	1.76	1.76	1.76	3.71	10.40	3.4 ~ 14.5	2360	480 ~ 3840	4.41	A	
1.6 + 2.0 + 2.0 + 2.0 + 5.0	12.6	1.32	1.65	1.65	1.65	4.13	10.40	3.4 ~ 14.5	2400	570 ~ 3780	4.33	A	
1.6 + 2.0 + 2.0 + 2.0 + 6.0	13.6	1.22	1.53	1.53	1.53	4.59	10.40	3.4 ~ 14.5	2400	570 ~ 3780	4.33	A	
1.6 + 2.0 + 2.0 + 2.0 + 7.1	14.7	1.13	1.41	1.41	1.41	5.04	10.40	3.4 ~ 14.5	2400	580 ~ 3820	4.33	A	
1.6 + 2.0 + 2.0 + 2.5 + 2.5	10.6	1.58	1.96	1.96	2.45	2.45	10.40	3.4 ~ 14.5	2340	460 ~ 3880	4.44	A	
1.6 + 2.0 + 2.0 + 2.5 + 3.5	11.6	1.43	1.79	1.79	2.24	3.15	10.40	3.4 ~ 14.5	2370	480 ~ 3850	4.39	A	
1.6 + 2.0 + 2.0 + 2.5 + 4.2	12.3	1.35	1.69	1.69	2.11	3.56	10.40	3.4 ~ 14.5	2360	480 ~ 3840	4.41	A	
1.6 + 2.0 + 2.0 + 2.5 + 5.0	13.1	1.27	1.59	1.59	1.98	3.97	10.40	3.4 ~ 14.5	2400	570 ~ 3780	4.33	A	
1.6 + 2.0 + 2.0 + 2.5 + 6.0	14.1	1.18	1.48	1.48	1.84	4.42	10.40	3.4 ~ 14.5	2400	570 ~ 3780	4.33	A	
1.6 + 2.0 + 2.0 + 2.5 + 7.1	15.2	1.09	1.37	1.37	1.71	4.86	10.40	3.4 ~ 14.5	2400	580 ~ 3820	4.33	A	
1.6 + 2.0 + 2.0 + 3.5 + 3.5	12.6	1.32	1.65	1.65	2.89	2.89	10.40	3.4 ~ 14.5	2350	500 ~ 3820	4.43	A	
1.6 + 2.0 + 2.0 + 3.5 + 4.2	13.3	1.25	1.56	1.56	2.74	3.29	10.40	3.4 ~ 14.5	2350	510 ~ 3810	4.43	A	
1.6 + 2.0 + 2.0 + 3.5 + 5.0	14.1	1.18	1.48	1.48	2.58	3.68	10.40	3.4 ~ 14.5	2390	600 ~ 3810	4.35	A	
1.6 + 2.0 + 2.0 + 3.5 + 6.0	15.1	1.10	1.38	1.38	2.41	4.13	10.40	3.4 ~ 14.5	2390	600 ~ 3810	4.35	A	
1.6 + 2.0 + 2.0 + 3.5 + 7.1	16.2	1.03	1.28	1.28	2.25	4.56	10.40	3.4 ~ 14.5	2430	600 ~ 3800	4.28	A	
1.6 + 2.0 + 2.0 + 4.2 + 4.2	14.0	1.18	1.49	1.49	3.12	3.12	10.40	3.4 ~ 14.5	2350	510 ~ 3800	4.43	A	

5 Room

	Indoor unit capacity Heating	Annual Energy Consumption (kWh)	Current 230V (A)	ERP			Moisture Removal Volume l/h	
				Pdesign (kW)	SCOP			Annual Consumption (kWh)
					W/W	CLASS		
5 Room	1.6 + 1.6 + 2.0 + 5.0 + 6.0	1245	11.7	8.50	4.68	A++	2543	
	1.6 + 1.6 + 2.0 + 5.0 + 7.1	1265	11.9	8.50	4.68	A++	2543	
	1.6 + 1.6 + 2.0 + 6.0 + 6.0	1245	11.7	8.50	4.68	A++	2543	
	1.6 + 1.6 + 2.0 + 6.0 + 7.1	1265	11.9	8.50	4.68	A++	2543	
	1.6 + 1.6 + 2.5 + 2.5 + 2.5	1170	11.0	8.50	4.68	A++	2543	
	1.6 + 1.6 + 2.5 + 2.5 + 3.5	1165	10.9	8.50	4.68	A++	2543	
	1.6 + 1.6 + 2.5 + 2.5 + 4.2	1185	11.1	8.50	4.68	A++	2543	
	1.6 + 1.6 + 2.5 + 2.5 + 5.0	1200	11.3	8.50	4.68	A++	2543	
	1.6 + 1.6 + 2.5 + 2.5 + 6.0	1200	11.3	8.50	4.68	A++	2543	
	1.6 + 1.6 + 2.5 + 2.5 + 7.1	1200	11.3	8.50	4.68	A++	2543	
	1.6 + 1.6 + 2.5 + 3.5 + 3.5	1180	11.1	8.50	4.68	A++	2543	
	1.6 + 1.6 + 2.5 + 3.5 + 4.2	1175	11.0	8.50	4.68	A++	2543	
	1.6 + 1.6 + 2.5 + 3.5 + 5.0	1200	11.3	8.50	4.68	A++	2543	
	1.6 + 1.6 + 2.5 + 3.5 + 6.0	1200	11.3	8.50	4.68	A++	2543	
	1.6 + 1.6 + 2.5 + 3.5 + 7.1	1215	11.4	8.50	4.68	A++	2543	
	1.6 + 1.6 + 2.5 + 4.2 + 4.2	1175	11.0	8.50	4.68	A++	2543	
	1.6 + 1.6 + 2.5 + 4.2 + 5.0	1195	11.2	8.50	4.68	A++	2543	
	1.6 + 1.6 + 2.5 + 4.2 + 6.0	1195	11.2	8.50	4.68	A++	2543	
	1.6 + 1.6 + 2.5 + 4.2 + 7.1	1215	11.4	8.50	4.68	A++	2543	
	1.6 + 1.6 + 2.5 + 5.0 + 5.0	1245	11.7	8.50	4.68	A++	2543	
	1.6 + 1.6 + 2.5 + 5.0 + 6.0	1245	11.7	8.50	4.68	A++	2543	
	1.6 + 1.6 + 2.5 + 5.0 + 7.1	1265	11.9	8.50	4.68	A++	2543	
	1.6 + 1.6 + 2.5 + 6.0 + 6.0	1245	11.7	8.50	4.68	A++	2543	
	1.6 + 1.6 + 3.5 + 3.5 + 3.5	1175	11.0	8.50	4.68	A++	2543	
	1.6 + 1.6 + 3.5 + 3.5 + 4.2	1190	11.2	8.50	4.68	A++	2543	
	1.6 + 1.6 + 3.5 + 3.5 + 5.0	1215	11.4	8.50	4.68	A++	2543	
	1.6 + 1.6 + 3.5 + 3.5 + 6.0	1215	11.4	8.50	4.68	A++	2543	
	1.6 + 1.6 + 3.5 + 3.5 + 7.1	1215	11.4	8.50	4.68	A++	2543	
	1.6 + 1.6 + 3.5 + 4.2 + 4.2	1190	11.2	8.50	4.68	A++	2543	
	1.6 + 1.6 + 3.5 + 4.2 + 5.0	1215	11.4	8.50	4.68	A++	2543	
	1.6 + 1.6 + 3.5 + 4.2 + 6.0	1215	11.4	8.50	4.68	A++	2543	
	1.6 + 1.6 + 3.5 + 4.2 + 7.1	1210	11.4	8.50	4.68	A++	2543	
	1.6 + 1.6 + 3.5 + 5.0 + 5.0	1265	11.9	8.50	4.68	A++	2543	
	1.6 + 1.6 + 3.5 + 5.0 + 6.0	1265	11.9	8.50	4.68	A++	2543	
	1.6 + 1.6 + 4.2 + 4.2 + 4.2	1190	11.2	8.50	4.68	A++	2543	
	1.6 + 1.6 + 4.2 + 4.2 + 5.0	1215	11.4	8.50	4.68	A++	2543	
	1.6 + 1.6 + 4.2 + 4.2 + 6.0	1215	11.4	8.50	4.68	A++	2543	
	1.6 + 1.6 + 4.2 + 5.0 + 5.0	1265	11.9	8.50	4.68	A++	2543	
	1.6 + 1.6 + 5.0 + 5.0 + 5.0	1340	12.6	8.50	4.68	A++	2543	
	1.6 + 2.0 + 2.0 + 2.0 + 2.0	1170	11.0	8.50	4.68	A++	2543	
1.6 + 2.0 + 2.0 + 2.0 + 2.5	1170	11.0	8.50	4.68	A++	2543		
1.6 + 2.0 + 2.0 + 2.0 + 3.5	1185	11.1	8.50	4.68	A++	2543		
1.6 + 2.0 + 2.0 + 2.0 + 4.2	1180	11.1	8.50	4.68	A++	2543		
1.6 + 2.0 + 2.0 + 2.0 + 5.0	1200	11.3	8.50	4.68	A++	2543		
1.6 + 2.0 + 2.0 + 2.0 + 6.0	1200	11.3	8.50	4.68	A++	2543		
1.6 + 2.0 + 2.0 + 2.0 + 7.1	1200	11.3	8.50	4.68	A++	2543		
1.6 + 2.0 + 2.0 + 2.5 + 2.5	1170	11.0	8.50	4.68	A++	2543		
1.6 + 2.0 + 2.0 + 2.5 + 3.5	1185	11.1	8.50	4.68	A++	2543		
1.6 + 2.0 + 2.0 + 2.5 + 4.2	1180	11.1	8.50	4.68	A++	2543		
1.6 + 2.0 + 2.0 + 2.5 + 5.0	1200	11.3	8.50	4.68	A++	2543		
1.6 + 2.0 + 2.0 + 2.5 + 6.0	1200	11.3	8.50	4.68	A++	2543		
1.6 + 2.0 + 2.0 + 2.5 + 7.1	1200	11.3	8.50	4.68	A++	2543		
1.6 + 2.0 + 2.0 + 3.5 + 3.5	1175	11.0	8.50	4.68	A++	2543		
1.6 + 2.0 + 2.0 + 3.5 + 4.2	1175	11.0	8.50	4.68	A++	2543		
1.6 + 2.0 + 2.0 + 3.5 + 5.0	1195	11.2	8.50	4.68	A++	2543		
1.6 + 2.0 + 2.0 + 3.5 + 6.0	1195	11.2	8.50	4.68	A++	2543		
1.6 + 2.0 + 2.0 + 3.5 + 7.1	1215	11.4	8.50	4.68	A++	2543		
1.6 + 2.0 + 2.0 + 4.2 + 4.2	1175	11.0	8.50	4.68	A++	2543		

Indoor unit capacity Heating	Total	Heating Capacity (kW)							Input Power (W)		COP	
		Room A	Room B	Room C	Room D	Room E	Total	min ~ max	Rating	min ~ max	WW	CLASS
1.6 + 2.0 + 2.0 + 4.2 + 5.0	14.8	1.12	1.41	1.41	2.95	3.51	10.40	3.4 ~ 14.5	2430	600 ~ 3800	4.28	A
1.6 + 2.0 + 2.0 + 4.2 + 6.0	15.8	1.05	1.32	1.32	2.76	3.95	10.40	3.4 ~ 14.5	2430	600 ~ 3800	4.28	A
1.6 + 2.0 + 2.0 + 4.2 + 7.1	16.9	0.98	1.23	1.23	2.58	4.38	10.40	3.4 ~ 14.5	2430	620 ~ 3790	4.28	A
1.6 + 2.0 + 2.0 + 5.0 + 5.0	15.6	1.08	1.33	1.33	3.33	3.33	10.40	3.4 ~ 14.5	2530	710 ~ 3810	4.11	A
1.6 + 2.0 + 2.0 + 5.0 + 6.0	16.6	1.00	1.25	1.25	3.13	3.77	10.40	3.4 ~ 14.5	2530	710 ~ 3810	4.11	A
1.6 + 2.0 + 2.0 + 5.0 + 7.1	17.7	0.94	1.18	1.18	2.94	4.16	10.40	3.4 ~ 14.5	2530	720 ~ 3860	4.11	A
1.6 + 2.0 + 2.0 + 6.0 + 6.0	17.6	0.94	1.18	1.18	3.55	3.55	10.40	3.4 ~ 14.5	2530	710 ~ 3810	4.11	A
1.6 + 2.0 + 2.5 + 2.5 + 2.5	11.1	1.50	1.88	2.34	2.34	2.34	10.40	3.4 ~ 14.5	2340	460 ~ 3880	4.44	A
1.6 + 2.0 + 2.5 + 2.5 + 3.5	12.1	1.38	1.72	2.15	2.15	3.00	10.40	3.4 ~ 14.5	2370	480 ~ 3850	4.39	A
1.6 + 2.0 + 2.5 + 2.5 + 4.2	12.8	1.30	1.63	2.03	2.03	3.41	10.40	3.4 ~ 14.5	2360	480 ~ 3840	4.41	A
1.6 + 2.0 + 2.5 + 2.5 + 5.0	13.6	1.22	1.53	1.91	1.91	3.83	10.40	3.4 ~ 14.5	2400	570 ~ 3780	4.33	A
1.6 + 2.0 + 2.5 + 2.5 + 6.0	14.6	1.14	1.42	1.78	1.78	4.28	10.40	3.4 ~ 14.5	2400	570 ~ 3780	4.33	A
1.6 + 2.0 + 2.5 + 2.5 + 7.1	15.7	1.06	1.32	1.66	1.66	4.70	10.40	3.4 ~ 14.5	2400	580 ~ 3820	4.33	A
1.6 + 2.0 + 2.5 + 3.5 + 3.5	13.1	1.27	1.59	1.98	2.78	2.78	10.40	3.4 ~ 14.5	2350	500 ~ 3820	4.43	A
1.6 + 2.0 + 2.5 + 3.5 + 4.2	13.8	1.21	1.51	1.88	2.64	3.16	10.40	3.4 ~ 14.5	2350	510 ~ 3810	4.43	A
1.6 + 2.0 + 2.5 + 3.5 + 5.0	14.6	1.14	1.42	1.78	2.49	3.57	10.40	3.4 ~ 14.5	2390	600 ~ 3810	4.35	A
1.6 + 2.0 + 2.5 + 3.5 + 6.0	15.6	1.07	1.33	1.67	2.33	4.00	10.40	3.4 ~ 14.5	2390	600 ~ 3810	4.35	A
1.6 + 2.0 + 2.5 + 3.5 + 7.1	16.7	1.00	1.25	1.56	2.18	4.41	10.40	3.4 ~ 14.5	2430	600 ~ 3800	4.28	A
1.6 + 2.0 + 2.5 + 4.2 + 4.2	14.5	1.15	1.43	1.80	3.01	3.01	10.40	3.4 ~ 14.5	2350	510 ~ 3800	4.43	A
1.6 + 2.0 + 2.5 + 4.2 + 5.0	15.3	1.09	1.36	1.70	2.85	3.40	10.40	3.4 ~ 14.5	2430	600 ~ 3800	4.28	A
1.6 + 2.0 + 2.5 + 4.2 + 6.0	16.3	1.02	1.28	1.60	2.68	3.82	10.40	3.4 ~ 14.5	2430	600 ~ 3800	4.28	A
1.6 + 2.0 + 2.5 + 4.2 + 7.1	17.4	0.96	1.20	1.49	2.51	4.24	10.40	3.4 ~ 14.5	2430	620 ~ 3790	4.28	A
1.6 + 2.0 + 2.5 + 5.0 + 5.0	16.1	1.03	1.29	1.62	3.23	3.23	10.40	3.4 ~ 14.5	2530	710 ~ 3810	4.11	A
1.6 + 2.0 + 2.5 + 5.0 + 6.0	17.1	0.97	1.22	1.52	3.04	3.65	10.40	3.4 ~ 14.5	2530	710 ~ 3810	4.11	A
1.6 + 2.0 + 2.5 + 5.0 + 7.1	18.2	0.91	1.14	1.43	2.86	4.06	10.40	3.4 ~ 14.5	2530	720 ~ 3860	4.11	A
1.6 + 2.0 + 2.5 + 6.0 + 6.0	18.1	0.91	1.15	1.44	3.45	3.45	10.40	3.4 ~ 14.5	2530	710 ~ 3810	4.11	A
1.6 + 2.0 + 3.5 + 3.5 + 3.5	14.1	1.18	1.48	2.58	2.58	2.58	10.40	3.4 ~ 14.5	2380	510 ~ 3790	4.37	A
1.6 + 2.0 + 3.5 + 3.5 + 4.2	14.8	1.12	1.41	2.46	2.46	2.95	10.40	3.4 ~ 14.5	2380	520 ~ 3840	4.37	A
1.6 + 2.0 + 3.5 + 3.5 + 5.0	15.6	1.07	1.33	2.33	2.33	3.34	10.40	3.4 ~ 14.5	2430	620 ~ 3790	4.28	A
1.6 + 2.0 + 3.5 + 3.5 + 6.0	16.6	1.00	1.25	2.19	2.19	3.77	10.40	3.4 ~ 14.5	2430	620 ~ 3790	4.28	A
1.6 + 2.0 + 3.5 + 3.5 + 7.1	17.7	0.94	1.18	2.06	2.06	4.16	10.40	3.4 ~ 14.5	2420	630 ~ 3830	4.30	A
1.6 + 2.0 + 3.5 + 4.2 + 4.2	15.5	1.07	1.34	2.35	2.82	2.82	10.40	3.4 ~ 14.5	2380	530 ~ 3830	4.37	A
1.6 + 2.0 + 3.5 + 4.2 + 5.0	16.3	1.02	1.28	2.23	2.68	3.19	10.40	3.4 ~ 14.5	2430	630 ~ 3830	4.28	A
1.6 + 2.0 + 3.5 + 4.2 + 6.0	17.3	0.96	1.20	2.10	2.52	3.62	10.40	3.4 ~ 14.5	2430	630 ~ 3830	4.28	A
1.6 + 2.0 + 3.5 + 5.0 + 5.0	17.1	0.97	1.22	2.13	3.04	3.04	10.40	3.4 ~ 14.5	2530	740 ~ 3850	4.11	A
1.6 + 2.0 + 3.5 + 5.0 + 6.0	18.1	0.92	1.15	2.01	2.87	3.45	10.40	3.4 ~ 14.5	2530	740 ~ 3850	4.11	A
1.6 + 2.0 + 4.2 + 4.2 + 4.2	16.2	1.02	1.28	2.70	2.70	2.70	10.40	3.4 ~ 14.5	2370	540 ~ 3820	4.39	A
1.6 + 2.0 + 4.2 + 4.2 + 5.0	17.0	0.98	1.22	2.57	2.57	3.06	10.40	3.4 ~ 14.5	2460	630 ~ 3820	4.23	A
1.6 + 2.0 + 4.2 + 4.2 + 6.0	18.0	0.92	1.16	2.43	2.43	3.46	10.40	3.4 ~ 14.5	2460	630 ~ 3820	4.23	A
1.6 + 2.0 + 4.2 + 5.0 + 5.0	17.8	0.93	1.17	2.46	2.92	2.92	10.40	3.4 ~ 14.5	2560	750 ~ 3840	4.06	A
1.6 + 2.5 + 2.5 + 2.5 + 2.5	11.6	1.44	2.24	2.24	2.24	2.24	10.40	3.4 ~ 14.5	2340	460 ~ 3880	4.44	A
1.6 + 2.5 + 2.5 + 2.5 + 3.5	12.6	1.32	2.06	2.06	2.06	2.90	10.40	3.4 ~ 14.5	2370	480 ~ 3850	4.39	A
1.6 + 2.5 + 2.5 + 2.5 + 4.2	13.3	1.25	1.95	1.95	1.95	3.30	10.40	3.4 ~ 14.5	2360	480 ~ 3840	4.41	A
1.6 + 2.5 + 2.5 + 2.5 + 5.0	14.1	1.18	1.84	1.84	1.84	3.70	10.40	3.4 ~ 14.5	2400	570 ~ 3780	4.33	A
1.6 + 2.5 + 2.5 + 2.5 + 6.0	15.1	1.10	1.72	1.72	1.72	4.14	10.40	3.4 ~ 14.5	2400	570 ~ 3780	4.33	A
1.6 + 2.5 + 2.5 + 2.5 + 7.1	16.2	1.03	1.60	1.60	1.60	4.57	10.40	3.4 ~ 14.5	2400	580 ~ 3820	4.33	A
1.6 + 2.5 + 2.5 + 3.5 + 3.5	13.6	1.22	1.91	1.91	2.68	2.68	10.40	3.4 ~ 14.5	2350	500 ~ 3820	4.43	A
1.6 + 2.5 + 2.5 + 3.5 + 4.2	14.3	1.16	1.82	1.82	2.55	3.05	10.40	3.4 ~ 14.5	2350	510 ~ 3810	4.43	A
1.6 + 2.5 + 2.5 + 3.5 + 5.0	15.1	1.10	1.72	1.72	2.41	3.45	10.40	3.4 ~ 14.5	2390	600 ~ 3810	4.35	A
1.6 + 2.5 + 2.5 + 3.5 + 6.0	16.1	1.03	1.61	1.61	2.26	3.89	10.40	3.4 ~ 14.5	2390	600 ~ 3810	4.35	A
1.6 + 2.5 + 2.5 + 3.5 + 7.1	17.2	0.97	1.51	1.51	2.12	4.29	10.40	3.4 ~ 14.5	2430	600 ~ 3800	4.28	A
1.6 + 2.5 + 2.5 + 4.2 + 4.2	15.0	1.12	1.73	1.73	2.91	2.91	10.40	3.4 ~ 14.5	2350	510 ~ 3800	4.43	A
1.6 + 2.5 + 2.5 + 4.2 + 5.0	15.8	1.05	1.65	1.65	2.76	3.29	10.40	3.4 ~ 14.5	2430	600 ~ 3800	4.28	A
1.6 + 2.5 + 2.5 + 4.2 + 6.0	16.8	0.99	1.55	1.55	2.60	3.71	10.40	3.4 ~ 14.5	2430	600 ~ 3800	4.28	A
1.6 + 2.5 + 2.5 + 4.2 + 7.1	17.9	0.93	1.45	1.45	2.44	4.13	10.40	3.4 ~ 14.5	2430	620 ~ 3790	4.28	A
1.6 + 2.5 + 2.5 + 5.0 + 5.0	16.6	1.00	1.57	1.57	3.13	3.13	10.40	3.4 ~ 14.5	2530	710 ~ 3810	4.11	A
1.6 + 2.5 + 2.5 + 5.0 + 6.0	17.6	0.95	1.48	1.48	2.95	3.54	10.40	3.4 ~ 14.5	2530	710 ~ 3810	4.11	A
1.6 + 2.5 + 3.5 + 3.5 + 3.5	14.6	1.14	1.79	2.49	2.49	2.49	10.40	3.4 ~ 14.5	2380	510 ~ 3790	4.37	A

5 Room

	Indoor unit capacity Heating	Annual Energy Consumption (kWh)	Current 230V (A)	ERP				Moisture Removal Volume l/h
				Pdesign (kW)	SCOP		Annual Consumption (kWh)	
					W/W	CLASS		
5 Room	1.6 + 2.0 + 2.0 + 4.2 + 5.0	1215	11.4	8.50	4.68	A++	2543	
	1.6 + 2.0 + 2.0 + 4.2 + 6.0	1215	11.4	8.50	4.68	A++	2543	
	1.6 + 2.0 + 2.0 + 4.2 + 7.1	1215	11.4	8.50	4.68	A++	2543	
	1.6 + 2.0 + 2.0 + 5.0 + 5.0	1265	11.9	8.50	4.68	A++	2543	
	1.6 + 2.0 + 2.0 + 5.0 + 6.0	1265	11.9	8.50	4.68	A++	2543	
	1.6 + 2.0 + 2.0 + 5.0 + 7.1	1265	11.9	8.50	4.68	A++	2543	
	1.6 + 2.0 + 2.0 + 6.0 + 6.0	1265	11.9	8.50	4.68	A++	2543	
	1.6 + 2.0 + 2.5 + 2.5 + 2.5	1170	11.0	8.50	4.68	A++	2543	
	1.6 + 2.0 + 2.5 + 2.5 + 3.5	1185	11.1	8.50	4.68	A++	2543	
	1.6 + 2.0 + 2.5 + 2.5 + 4.2	1180	11.1	8.50	4.68	A++	2543	
	1.6 + 2.0 + 2.5 + 2.5 + 5.0	1200	11.3	8.50	4.68	A++	2543	
	1.6 + 2.0 + 2.5 + 2.5 + 6.0	1200	11.3	8.50	4.68	A++	2543	
	1.6 + 2.0 + 2.5 + 2.5 + 7.1	1200	11.3	8.50	4.68	A++	2543	
	1.6 + 2.0 + 2.5 + 3.5 + 3.5	1175	11.0	8.50	4.68	A++	2543	
	1.6 + 2.0 + 2.5 + 3.5 + 4.2	1175	11.0	8.50	4.68	A++	2543	
	1.6 + 2.0 + 2.5 + 3.5 + 5.0	1195	11.2	8.50	4.68	A++	2543	
	1.6 + 2.0 + 2.5 + 3.5 + 6.0	1195	11.2	8.50	4.68	A++	2543	
	1.6 + 2.0 + 2.5 + 3.5 + 7.1	1215	11.4	8.50	4.68	A++	2543	
	1.6 + 2.0 + 2.5 + 4.2 + 4.2	1175	11.0	8.50	4.68	A++	2543	
	1.6 + 2.0 + 2.5 + 4.2 + 5.0	1215	11.4	8.50	4.68	A++	2543	
	1.6 + 2.0 + 2.5 + 4.2 + 6.0	1215	11.4	8.50	4.68	A++	2543	
	1.6 + 2.0 + 2.5 + 4.2 + 7.1	1215	11.4	8.50	4.68	A++	2543	
	1.6 + 2.0 + 2.5 + 5.0 + 5.0	1265	11.9	8.50	4.68	A++	2543	
	1.6 + 2.0 + 2.5 + 5.0 + 6.0	1265	11.9	8.50	4.68	A++	2543	
	1.6 + 2.0 + 2.5 + 5.0 + 7.1	1265	11.9	8.50	4.68	A++	2543	
	1.6 + 2.0 + 2.5 + 6.0 + 6.0	1265	11.9	8.50	4.68	A++	2543	
	1.6 + 2.0 + 3.5 + 3.5 + 3.5	1190	11.2	8.50	4.68	A++	2543	
	1.6 + 2.0 + 3.5 + 3.5 + 4.2	1190	11.2	8.50	4.68	A++	2543	
	1.6 + 2.0 + 3.5 + 3.5 + 5.0	1215	11.4	8.50	4.68	A++	2543	
	1.6 + 2.0 + 3.5 + 3.5 + 6.0	1215	11.4	8.50	4.68	A++	2543	
	1.6 + 2.0 + 3.5 + 3.5 + 7.1	1210	11.4	8.50	4.68	A++	2543	
	1.6 + 2.0 + 3.5 + 4.2 + 4.2	1190	11.2	8.50	4.68	A++	2543	
	1.6 + 2.0 + 3.5 + 4.2 + 5.0	1215	11.4	8.50	4.68	A++	2543	
	1.6 + 2.0 + 3.5 + 4.2 + 6.0	1215	11.4	8.50	4.68	A++	2543	
	1.6 + 2.0 + 3.5 + 5.0 + 5.0	1265	11.9	8.50	4.68	A++	2543	
	1.6 + 2.0 + 3.5 + 5.0 + 6.0	1265	11.9	8.50	4.68	A++	2543	
	1.6 + 2.0 + 4.2 + 4.2 + 4.2	1185	11.1	8.50	4.68	A++	2543	
	1.6 + 2.0 + 4.2 + 4.2 + 5.0	1230	11.6	8.50	4.68	A++	2543	
	1.6 + 2.0 + 4.2 + 4.2 + 6.0	1230	11.6	8.50	4.68	A++	2543	
	1.6 + 2.0 + 4.2 + 5.0 + 5.0	1280	12.0	8.50	4.68	A++	2543	
1.6 + 2.5 + 2.5 + 2.5 + 2.5	1170	11.0	8.50	4.68	A++	2543		
1.6 + 2.5 + 2.5 + 2.5 + 3.5	1185	11.1	8.50	4.68	A++	2543		
1.6 + 2.5 + 2.5 + 2.5 + 4.2	1180	11.1	8.50	4.68	A++	2543		
1.6 + 2.5 + 2.5 + 2.5 + 5.0	1200	11.3	8.50	4.68	A++	2543		
1.6 + 2.5 + 2.5 + 2.5 + 6.0	1200	11.3	8.50	4.68	A++	2543		
1.6 + 2.5 + 2.5 + 2.5 + 7.1	1200	11.3	8.50	4.68	A++	2543		
1.6 + 2.5 + 2.5 + 3.5 + 3.5	1175	11.0	8.50	4.68	A++	2543		
1.6 + 2.5 + 2.5 + 3.5 + 4.2	1175	11.0	8.50	4.68	A++	2543		
1.6 + 2.5 + 2.5 + 3.5 + 5.0	1195	11.2	8.50	4.68	A++	2543		
1.6 + 2.5 + 2.5 + 3.5 + 6.0	1195	11.2	8.50	4.68	A++	2543		
1.6 + 2.5 + 2.5 + 3.5 + 7.1	1215	11.4	8.50	4.68	A++	2543		
1.6 + 2.5 + 2.5 + 4.2 + 4.2	1175	11.0	8.50	4.68	A++	2543		
1.6 + 2.5 + 2.5 + 4.2 + 5.0	1215	11.4	8.50	4.68	A++	2543		
1.6 + 2.5 + 2.5 + 4.2 + 6.0	1215	11.4	8.50	4.68	A++	2543		
1.6 + 2.5 + 2.5 + 4.2 + 7.1	1215	11.4	8.50	4.68	A++	2543		
1.6 + 2.5 + 2.5 + 5.0 + 5.0	1265	11.9	8.50	4.68	A++	2543		
1.6 + 2.5 + 2.5 + 5.0 + 6.0	1265	11.9	8.50	4.68	A++	2543		
1.6 + 2.5 + 3.5 + 3.5 + 3.5	1190	11.2	8.50	4.68	A++	2543		

Indoor unit capacity Heating	Total	Heating Capacity (kW)							Input Power (W)			COP	
		Room A	Room B	Room C	Room D	Room E	Total	min ~ max	Rating	min ~ max	WW	CLASS	
1.6 + 2.5 + 3.5 + 3.5 + 4.2	15.3	1.09	1.70	2.38	2.38	2.85	10.40	3.4 ~ 14.5	2380	520 ~ 3840	4.37	A	
1.6 + 2.5 + 3.5 + 3.5 + 5.0	16.1	1.03	1.61	2.26	2.26	3.24	10.40	3.4 ~ 14.5	2430	620 ~ 3790	4.28	A	
1.6 + 2.5 + 3.5 + 3.5 + 6.0	17.1	0.97	1.52	2.13	2.13	3.65	10.40	3.4 ~ 14.5	2430	620 ~ 3790	4.28	A	
1.6 + 2.5 + 3.5 + 3.5 + 7.1	18.2	0.91	1.43	2.00	2.00	4.06	10.40	3.4 ~ 14.5	2420	630 ~ 3830	4.30	A	
1.6 + 2.5 + 3.5 + 4.2 + 4.2	16.0	1.03	1.63	2.28	2.73	2.73	10.40	3.4 ~ 14.5	2380	530 ~ 3830	4.37	A	
1.6 + 2.5 + 3.5 + 4.2 + 5.0	16.8	0.99	1.55	2.17	2.60	3.09	10.40	3.4 ~ 14.5	2430	630 ~ 3830	4.28	A	
1.6 + 2.5 + 3.5 + 4.2 + 6.0	17.8	0.93	1.46	2.04	2.45	3.52	10.40	3.4 ~ 14.5	2430	630 ~ 3830	4.28	A	
1.6 + 2.5 + 3.5 + 5.0 + 5.0	17.6	0.95	1.48	2.07	2.95	2.95	10.40	3.4 ~ 14.5	2530	740 ~ 3850	4.11	A	
1.6 + 2.5 + 4.2 + 4.2 + 4.2	16.7	0.98	1.56	2.62	2.62	2.62	10.40	3.4 ~ 14.5	2370	540 ~ 3820	4.39	A	
1.6 + 2.5 + 4.2 + 4.2 + 5.0	17.5	0.95	1.49	2.50	2.50	2.96	10.40	3.4 ~ 14.5	2460	630 ~ 3820	4.23	A	
1.6 + 2.5 + 4.2 + 5.0 + 5.0	18.3	0.91	1.42	2.39	2.84	2.84	10.40	3.4 ~ 14.5	2560	750 ~ 3840	4.06	A	
1.6 + 3.5 + 3.5 + 3.5 + 3.5	15.6	1.08	2.33	2.33	2.33	2.33	10.40	3.4 ~ 14.5	2370	540 ~ 3820	4.39	A	
1.6 + 3.5 + 3.5 + 3.5 + 4.2	16.3	1.02	2.23	2.23	2.23	2.69	10.40	3.4 ~ 14.5	2370	540 ~ 3810	4.39	A	
1.6 + 3.5 + 3.5 + 3.5 + 5.0	17.1	0.97	2.13	2.13	2.13	3.04	10.40	3.4 ~ 14.5	2460	650 ~ 3820	4.23	A	
1.6 + 3.5 + 3.5 + 3.5 + 6.0	18.1	0.92	2.01	2.01	2.01	3.45	10.40	3.4 ~ 14.5	2460	650 ~ 3820	4.23	A	
1.6 + 3.5 + 3.5 + 4.2 + 4.2	17.0	0.98	2.14	2.14	2.57	2.57	10.40	3.4 ~ 14.5	2370	550 ~ 3800	4.39	A	
1.6 + 3.5 + 3.5 + 4.2 + 5.0	17.8	0.93	2.04	2.04	2.45	2.94	10.40	3.4 ~ 14.5	2460	650 ~ 3810	4.23	A	
1.6 + 3.5 + 4.2 + 4.2 + 4.2	17.7	0.93	2.06	2.47	2.47	2.47	10.40	3.4 ~ 14.5	2400	560 ~ 3790	4.33	A	
2.0 + 2.0 + 2.0 + 2.0 + 2.0	10.0	2.08	2.08	2.08	2.08	2.08	10.40	3.4 ~ 14.5	2330	460 ~ 3870	4.46	A	
2.0 + 2.0 + 2.0 + 2.0 + 2.5	10.5	1.98	1.98	1.98	1.98	2.48	10.40	3.4 ~ 14.5	2330	460 ~ 3870	4.46	A	
2.0 + 2.0 + 2.0 + 2.0 + 3.5	11.5	1.81	1.81	1.81	1.81	3.16	10.40	3.4 ~ 14.5	2360	480 ~ 3840	4.41	A	
2.0 + 2.0 + 2.0 + 2.0 + 4.2	12.2	1.70	1.70	1.70	1.70	3.60	10.40	3.4 ~ 14.5	2360	490 ~ 3830	4.41	A	
2.0 + 2.0 + 2.0 + 2.0 + 5.0	13.0	1.60	1.60	1.60	1.60	4.00	10.40	3.4 ~ 14.5	2400	580 ~ 3830	4.33	A	
2.0 + 2.0 + 2.0 + 2.0 + 6.0	14.0	1.49	1.49	1.49	1.49	4.44	10.40	3.4 ~ 14.5	2400	580 ~ 3830	4.33	A	
2.0 + 2.0 + 2.0 + 2.0 + 7.1	15.1	1.38	1.38	1.38	1.38	4.88	10.40	3.4 ~ 14.5	2390	590 ~ 3810	4.35	A	
2.0 + 2.0 + 2.0 + 2.5 + 2.5	11.0	1.89	1.89	1.89	2.36	2.36	10.39	3.4 ~ 14.5	2330	460 ~ 3870	4.46	A	
2.0 + 2.0 + 2.0 + 2.5 + 3.5	12.0	1.73	1.73	1.73	2.17	3.04	10.40	3.4 ~ 14.5	2360	480 ~ 3840	4.41	A	
2.0 + 2.0 + 2.0 + 2.5 + 4.2	12.7	1.64	1.64	1.64	2.05	3.43	10.40	3.4 ~ 14.5	2360	490 ~ 3830	4.41	A	
2.0 + 2.0 + 2.0 + 2.5 + 5.0	13.5	1.54	1.54	1.54	1.93	3.85	10.40	3.4 ~ 14.5	2400	580 ~ 3830	4.33	A	
2.0 + 2.0 + 2.0 + 2.5 + 6.0	14.5	1.43	1.43	1.43	1.79	4.32	10.40	3.4 ~ 14.5	2400	580 ~ 3830	4.33	A	
2.0 + 2.0 + 2.0 + 2.5 + 7.1	15.6	1.33	1.33	1.33	1.67	4.74	10.40	3.4 ~ 14.5	2390	590 ~ 3810	4.35	A	
2.0 + 2.0 + 2.0 + 3.5 + 3.5	13.0	1.60	1.60	1.60	2.80	2.80	10.40	3.4 ~ 14.5	2350	510 ~ 3810	4.43	A	
2.0 + 2.0 + 2.0 + 3.5 + 4.2	13.7	1.52	1.52	1.52	2.66	3.18	10.40	3.4 ~ 14.5	2350	510 ~ 3800	4.43	A	
2.0 + 2.0 + 2.0 + 3.5 + 5.0	14.5	1.43	1.43	1.43	2.51	3.60	10.40	3.4 ~ 14.5	2430	600 ~ 3800	4.28	A	
2.0 + 2.0 + 2.0 + 3.5 + 6.0	15.5	1.34	1.34	1.34	2.35	4.03	10.40	3.4 ~ 14.5	2430	600 ~ 3800	4.28	A	
2.0 + 2.0 + 2.0 + 3.5 + 7.1	16.6	1.25	1.25	1.25	2.19	4.46	10.40	3.4 ~ 14.5	2430	620 ~ 3790	4.28	A	
2.0 + 2.0 + 2.0 + 4.2 + 4.2	14.4	1.44	1.44	1.44	3.04	3.04	10.40	3.4 ~ 14.5	2380	520 ~ 3790	4.37	A	
2.0 + 2.0 + 2.0 + 4.2 + 5.0	15.2	1.37	1.37	1.37	2.87	3.42	10.40	3.4 ~ 14.5	2430	610 ~ 3790	4.28	A	
2.0 + 2.0 + 2.0 + 4.2 + 6.0	16.2	1.28	1.28	1.28	2.70	3.86	10.40	3.4 ~ 14.5	2430	610 ~ 3790	4.28	A	
2.0 + 2.0 + 2.0 + 4.2 + 7.1	17.3	1.20	1.20	1.20	2.52	4.28	10.40	3.4 ~ 14.5	2430	630 ~ 3830	4.28	A	
2.0 + 2.0 + 2.0 + 5.0 + 5.0	16.0	1.30	1.30	1.30	3.25	3.25	10.40	3.4 ~ 14.5	2530	720 ~ 3860	4.11	A	
2.0 + 2.0 + 2.0 + 5.0 + 6.0	17.0	1.22	1.22	1.22	3.06	3.68	10.40	3.4 ~ 14.5	2530	720 ~ 3860	4.11	A	
2.0 + 2.0 + 2.0 + 5.0 + 7.1	18.1	1.15	1.15	1.15	2.87	4.08	10.40	3.4 ~ 14.5	2530	740 ~ 3850	4.11	A	
2.0 + 2.0 + 2.0 + 6.0 + 6.0	18.0	1.16	1.16	1.16	3.46	3.46	10.40	3.4 ~ 14.5	2530	720 ~ 3860	4.11	A	
2.0 + 2.0 + 2.5 + 2.5 + 2.5	11.5	1.81	1.81	2.26	2.26	2.26	10.40	3.4 ~ 14.5	2330	460 ~ 3870	4.46	A	
2.0 + 2.0 + 2.5 + 2.5 + 3.5	12.5	1.66	1.66	2.08	2.08	2.92	10.40	3.4 ~ 14.5	2360	480 ~ 3840	4.41	A	
2.0 + 2.0 + 2.5 + 2.5 + 4.2	13.2	1.58	1.58	1.97	1.97	3.30	10.40	3.4 ~ 14.5	2360	490 ~ 3830	4.41	A	
2.0 + 2.0 + 2.5 + 2.5 + 5.0	14.0	1.49	1.49	1.86	1.86	3.70	10.40	3.4 ~ 14.5	2400	580 ~ 3830	4.33	A	
2.0 + 2.0 + 2.5 + 2.5 + 6.0	15.0	1.39	1.39	1.73	1.73	4.16	10.40	3.4 ~ 14.5	2400	580 ~ 3830	4.33	A	
2.0 + 2.0 + 2.5 + 2.5 + 7.1	16.1	1.29	1.29	1.61	1.61	4.60	10.40	3.4 ~ 14.5	2390	590 ~ 3810	4.35	A	
2.0 + 2.0 + 2.5 + 3.5 + 3.5	13.5	1.54	1.54	1.92	2.70	2.70	10.40	3.4 ~ 14.5	2350	510 ~ 3810	4.43	A	
2.0 + 2.0 + 2.5 + 3.5 + 4.2	14.2	1.46	1.46	1.83	2.56	3.09	10.40	3.4 ~ 14.5	2350	510 ~ 3800	4.43	A	
2.0 + 2.0 + 2.5 + 3.5 + 5.0	15.0	1.39	1.39	1.73	2.43	3.46	10.40	3.4 ~ 14.5	2430	600 ~ 3800	4.28	A	
2.0 + 2.0 + 2.5 + 3.5 + 6.0	16.0	1.30	1.30	1.63	2.28	3.89	10.40	3.4 ~ 14.5	2430	600 ~ 3800	4.28	A	
2.0 + 2.0 + 2.5 + 3.5 + 7.1	17.1	1.22	1.22	1.52	2.13	4.31	10.40	3.4 ~ 14.5	2430	620 ~ 3790	4.28	A	
2.0 + 2.0 + 2.5 + 4.2 + 4.2	14.9	1.40	1.40	1.74	2.93	2.93	10.40	3.4 ~ 14.5	2380	520 ~ 3790	4.37	A	
2.0 + 2.0 + 2.5 + 4.2 + 5.0	15.7	1.32	1.32	1.66	2.78	3.32	10.40	3.4 ~ 14.5	2430	610 ~ 3790	4.28	A	
2.0 + 2.0 + 2.5 + 4.2 + 6.0	16.7	1.25	1.25	1.56	2.62	3.72	10.40	3.4 ~ 14.5	2430	610 ~ 3790	4.28	A	

5 Room

	Indoor unit capacity Heating	Annual Energy Consumption (kWh)	Current 230V (A)	ERP				Moisture Removal Volume l/h
				Pdesign (kW)	SCOP		Annual Consumption (kWh)	
					W/W	CLASS		
5 Room	1.6 + 2.5 + 3.5 + 3.5 + 4.2	1190	11.2	8.50	4.68	A++	2543	
	1.6 + 2.5 + 3.5 + 3.5 + 5.0	1215	11.4	8.50	4.68	A++	2543	
	1.6 + 2.5 + 3.5 + 3.5 + 6.0	1215	11.4	8.50	4.68	A++	2543	
	1.6 + 2.5 + 3.5 + 3.5 + 7.1	1210	11.4	8.50	4.68	A++	2543	
	1.6 + 2.5 + 3.5 + 4.2 + 4.2	1190	11.2	8.50	4.68	A++	2543	
	1.6 + 2.5 + 3.5 + 4.2 + 5.0	1215	11.4	8.50	4.68	A++	2543	
	1.6 + 2.5 + 3.5 + 4.2 + 6.0	1215	11.4	8.50	4.68	A++	2543	
	1.6 + 2.5 + 3.5 + 5.0 + 5.0	1265	11.9	8.50	4.68	A++	2543	
	1.6 + 2.5 + 4.2 + 4.2 + 4.2	1185	11.1	8.50	4.68	A++	2543	
	1.6 + 2.5 + 4.2 + 4.2 + 5.0	1230	11.6	8.50	4.68	A++	2543	
	1.6 + 2.5 + 4.2 + 5.0 + 5.0	1280	12.0	8.50	4.68	A++	2543	
	1.6 + 3.5 + 3.5 + 3.5 + 3.5	1185	11.1	8.50	4.68	A++	2543	
	1.6 + 3.5 + 3.5 + 3.5 + 4.2	1185	11.1	8.50	4.68	A++	2543	
	1.6 + 3.5 + 3.5 + 3.5 + 5.0	1230	11.6	8.50	4.68	A++	2543	
	1.6 + 3.5 + 3.5 + 3.5 + 6.0	1230	11.6	8.50	4.68	A++	2543	
	1.6 + 3.5 + 3.5 + 4.2 + 4.2	1185	11.1	8.50	4.68	A++	2543	
	1.6 + 3.5 + 3.5 + 4.2 + 5.0	1230	11.6	8.50	4.68	A++	2543	
	1.6 + 3.5 + 4.2 + 4.2 + 4.2	1200	11.3	8.50	4.68	A++	2543	
	2.0 + 2.0 + 2.0 + 2.0 + 2.0	1165	10.9	8.50	4.68	A++	2543	
	2.0 + 2.0 + 2.0 + 2.0 + 2.5	1165	10.9	8.50	4.68	A++	2543	
	2.0 + 2.0 + 2.0 + 2.0 + 3.5	1180	11.1	8.50	4.68	A++	2543	
	2.0 + 2.0 + 2.0 + 2.0 + 4.2	1180	11.1	8.50	4.68	A++	2543	
	2.0 + 2.0 + 2.0 + 2.0 + 5.0	1200	11.3	8.50	4.68	A++	2543	
	2.0 + 2.0 + 2.0 + 2.0 + 6.0	1200	11.3	8.50	4.68	A++	2543	
	2.0 + 2.0 + 2.0 + 2.0 + 7.1	1195	11.2	8.50	4.68	A++	2543	
	2.0 + 2.0 + 2.0 + 2.5 + 2.5	1165	10.9	8.50	4.68	A++	2543	
	2.0 + 2.0 + 2.0 + 2.5 + 3.5	1180	11.1	8.50	4.68	A++	2543	
	2.0 + 2.0 + 2.0 + 2.5 + 4.2	1180	11.1	8.50	4.68	A++	2543	
	2.0 + 2.0 + 2.0 + 2.5 + 5.0	1200	11.3	8.50	4.68	A++	2543	
	2.0 + 2.0 + 2.0 + 2.5 + 6.0	1200	11.3	8.50	4.68	A++	2543	
	2.0 + 2.0 + 2.0 + 2.5 + 7.1	1195	11.2	8.50	4.68	A++	2543	
	2.0 + 2.0 + 2.0 + 3.5 + 3.5	1175	11.0	8.50	4.68	A++	2543	
	2.0 + 2.0 + 2.0 + 3.5 + 4.2	1175	11.0	8.50	4.68	A++	2543	
	2.0 + 2.0 + 2.0 + 3.5 + 5.0	1215	11.4	8.50	4.68	A++	2543	
	2.0 + 2.0 + 2.0 + 3.5 + 6.0	1215	11.4	8.50	4.68	A++	2543	
	2.0 + 2.0 + 2.0 + 3.5 + 7.1	1215	11.4	8.50	4.68	A++	2543	
	2.0 + 2.0 + 2.0 + 4.2 + 4.2	1190	11.2	8.50	4.68	A++	2543	
	2.0 + 2.0 + 2.0 + 4.2 + 5.0	1215	11.4	8.50	4.68	A++	2543	
	2.0 + 2.0 + 2.0 + 4.2 + 6.0	1215	11.4	8.50	4.68	A++	2543	
	2.0 + 2.0 + 2.0 + 4.2 + 7.1	1215	11.4	8.50	4.68	A++	2543	
	2.0 + 2.0 + 2.0 + 5.0 + 5.0	1265	11.9	8.50	4.68	A++	2543	
	2.0 + 2.0 + 2.0 + 5.0 + 6.0	1265	11.9	8.50	4.68	A++	2543	
	2.0 + 2.0 + 2.0 + 5.0 + 7.1	1265	11.9	8.50	4.68	A++	2543	
	2.0 + 2.0 + 2.0 + 6.0 + 6.0	1265	11.9	8.50	4.68	A++	2543	
	2.0 + 2.0 + 2.5 + 2.5 + 2.5	1165	10.9	8.50	4.68	A++	2543	
	2.0 + 2.0 + 2.5 + 2.5 + 3.5	1180	11.1	8.50	4.68	A++	2543	
	2.0 + 2.0 + 2.5 + 2.5 + 4.2	1180	11.1	8.50	4.68	A++	2543	
	2.0 + 2.0 + 2.5 + 2.5 + 5.0	1200	11.3	8.50	4.68	A++	2543	
	2.0 + 2.0 + 2.5 + 2.5 + 6.0	1200	11.3	8.50	4.68	A++	2543	
	2.0 + 2.0 + 2.5 + 2.5 + 7.1	1195	11.2	8.50	4.68	A++	2543	
2.0 + 2.0 + 2.5 + 3.5 + 3.5	1175	11.0	8.50	4.68	A++	2543		
2.0 + 2.0 + 2.5 + 3.5 + 4.2	1175	11.0	8.50	4.68	A++	2543		
2.0 + 2.0 + 2.5 + 3.5 + 5.0	1215	11.4	8.50	4.68	A++	2543		
2.0 + 2.0 + 2.5 + 3.5 + 6.0	1215	11.4	8.50	4.68	A++	2543		
2.0 + 2.0 + 2.5 + 3.5 + 7.1	1215	11.4	8.50	4.68	A++	2543		
2.0 + 2.0 + 2.5 + 4.2 + 4.2	1190	11.2	8.50	4.68	A++	2543		
2.0 + 2.0 + 2.5 + 4.2 + 5.0	1215	11.4	8.50	4.68	A++	2543		
2.0 + 2.0 + 2.5 + 4.2 + 6.0	1215	11.4	8.50	4.68	A++	2543		

Indoor unit capacity Heating		Total	Heating Capacity (kW)						Input Power (W)			COP	
			Room A	Room B	Room C	Room D	Room E	Total	min ~ max	Rating	min ~ max	WW	CLASS
5 Room	2.0 + 2.0 + 2.5 + 4.2 + 7.1	17.8	1.17	1.17	1.46	2.45	4.15	10.40	3.4 ~ 14.5	2430	630 ~ 3830	4.28	A
	2.0 + 2.0 + 2.5 + 5.0 + 5.0	16.5	1.26	1.26	1.58	3.15	3.15	10.40	3.4 ~ 14.5	2530	720 ~ 3860	4.11	A
	2.0 + 2.0 + 2.5 + 5.0 + 6.0	17.5	1.19	1.19	1.49	2.97	3.56	10.40	3.4 ~ 14.5	2530	720 ~ 3860	4.11	A
	2.0 + 2.0 + 3.5 + 3.5 + 3.5	14.5	1.43	1.43	2.51	2.51	2.51	10.39	3.4 ~ 14.5	2380	520 ~ 3840	4.37	A
	2.0 + 2.0 + 3.5 + 3.5 + 4.2	15.2	1.37	1.37	2.39	2.39	2.88	10.40	3.4 ~ 14.5	2380	530 ~ 3830	4.37	A
	2.0 + 2.0 + 3.5 + 3.5 + 5.0	16.0	1.30	1.30	2.28	2.28	3.24	10.40	3.4 ~ 14.5	2430	630 ~ 3830	4.28	A
	2.0 + 2.0 + 3.5 + 3.5 + 6.0	17.0	1.22	1.22	2.14	2.14	3.68	10.40	3.4 ~ 14.5	2430	630 ~ 3830	4.28	A
	2.0 + 2.0 + 3.5 + 3.5 + 7.1	18.1	1.15	1.15	2.01	2.01	4.08	10.40	3.4 ~ 14.5	2460	640 ~ 3820	4.23	A
	2.0 + 2.0 + 3.5 + 4.2 + 4.2	15.9	1.31	1.31	2.28	2.75	2.75	10.40	3.4 ~ 14.5	2370	540 ~ 3820	4.39	A
	2.0 + 2.0 + 3.5 + 4.2 + 5.0	16.7	1.25	1.25	2.18	2.62	3.10	10.40	3.4 ~ 14.5	2460	630 ~ 3820	4.23	A
	2.0 + 2.0 + 3.5 + 4.2 + 6.0	17.7	1.18	1.18	2.06	2.47	3.51	10.40	3.4 ~ 14.5	2460	630 ~ 3820	4.23	A
	2.0 + 2.0 + 3.5 + 5.0 + 5.0	17.5	1.19	1.19	2.08	2.97	2.97	10.40	3.4 ~ 14.5	2560	750 ~ 3840	4.06	A
	2.0 + 2.0 + 4.2 + 4.2 + 4.2	16.6	1.25	1.25	2.63	2.63	2.63	10.39	3.4 ~ 14.5	2370	540 ~ 3810	4.38	A
	2.0 + 2.0 + 4.2 + 4.2 + 5.0	17.4	1.20	1.20	2.51	2.51	2.98	10.40	3.4 ~ 14.5	2460	650 ~ 3810	4.23	A
	2.0 + 2.0 + 4.2 + 5.0 + 5.0	18.2	1.14	1.14	2.40	2.86	2.86	10.40	3.4 ~ 14.5	2570	750 ~ 3890	4.05	A
	2.0 + 2.5 + 2.5 + 2.5 + 2.5	12.0	1.72	2.17	2.17	2.17	2.17	10.40	3.4 ~ 14.5	2330	460 ~ 3870	4.46	A
	2.0 + 2.5 + 2.5 + 2.5 + 3.5	13.0	1.60	2.00	2.00	2.00	2.80	10.40	3.4 ~ 14.5	2360	480 ~ 3840	4.41	A
	2.0 + 2.5 + 2.5 + 2.5 + 4.2	13.7	1.52	1.90	1.90	1.90	3.18	10.40	3.4 ~ 14.5	2360	490 ~ 3830	4.41	A
	2.0 + 2.5 + 2.5 + 2.5 + 5.0	14.5	1.43	1.79	1.79	1.79	3.60	10.40	3.4 ~ 14.5	2400	580 ~ 3830	4.33	A
	2.0 + 2.5 + 2.5 + 2.5 + 6.0	15.5	1.34	1.68	1.68	1.68	4.02	10.40	3.4 ~ 14.5	2400	580 ~ 3830	4.33	A
	2.0 + 2.5 + 2.5 + 2.5 + 7.1	16.6	1.25	1.57	1.57	1.57	4.44	10.40	3.4 ~ 14.5	2390	590 ~ 3810	4.35	A
	2.0 + 2.5 + 2.5 + 3.5 + 3.5	14.0	1.48	1.86	1.86	2.60	2.60	10.40	3.4 ~ 14.5	2350	510 ~ 3810	4.43	A
	2.0 + 2.5 + 2.5 + 3.5 + 4.2	14.7	1.41	1.77	1.77	2.48	2.97	10.40	3.4 ~ 14.5	2350	510 ~ 3800	4.43	A
	2.0 + 2.5 + 2.5 + 3.5 + 5.0	15.5	1.34	1.68	1.68	2.35	3.35	10.40	3.4 ~ 14.5	2430	600 ~ 3800	4.28	A
	2.0 + 2.5 + 2.5 + 3.5 + 6.0	16.5	1.26	1.58	1.58	2.21	3.77	10.40	3.4 ~ 14.5	2430	600 ~ 3800	4.28	A
	2.0 + 2.5 + 2.5 + 3.5 + 7.1	17.6	1.18	1.48	1.48	2.07	4.19	10.40	3.4 ~ 14.5	2430	620 ~ 3790	4.28	A
	2.0 + 2.5 + 2.5 + 4.2 + 4.2	15.4	1.34	1.69	1.69	2.84	2.84	10.40	3.4 ~ 14.5	2380	520 ~ 3790	4.37	A
	2.0 + 2.5 + 2.5 + 4.2 + 5.0	16.2	1.28	1.60	1.60	2.70	3.22	10.40	3.4 ~ 14.5	2430	610 ~ 3790	4.28	A
	2.0 + 2.5 + 2.5 + 4.2 + 6.0	17.2	1.21	1.51	1.51	2.54	3.63	10.40	3.4 ~ 14.5	2430	610 ~ 3790	4.28	A
	2.0 + 2.5 + 2.5 + 4.2 + 7.1	18.3	1.14	1.42	1.42	2.39	4.03	10.40	3.4 ~ 14.5	2430	630 ~ 3830	4.28	A
	2.0 + 2.5 + 2.5 + 5.0 + 5.0	17.0	1.22	1.53	1.53	3.06	3.06	10.40	3.4 ~ 14.5	2530	720 ~ 3860	4.11	A
	2.0 + 2.5 + 2.5 + 5.0 + 6.0	18.0	1.16	1.44	1.44	2.89	3.47	10.40	3.4 ~ 14.5	2530	720 ~ 3860	4.11	A
	2.0 + 2.5 + 3.5 + 3.5 + 3.5	15.0	1.38	1.73	2.43	2.43	2.43	10.40	3.4 ~ 14.5	2380	520 ~ 3840	4.37	A
	2.0 + 2.5 + 3.5 + 3.5 + 4.2	15.7	1.32	1.66	2.32	2.32	2.78	10.40	3.4 ~ 14.5	2380	530 ~ 3830	4.37	A
	2.0 + 2.5 + 3.5 + 3.5 + 5.0	16.5	1.26	1.58	2.21	2.21	3.14	10.40	3.4 ~ 14.5	2430	630 ~ 3830	4.28	A
	2.0 + 2.5 + 3.5 + 3.5 + 6.0	17.5	1.19	1.49	2.08	2.08	3.56	10.40	3.4 ~ 14.5	2430	630 ~ 3830	4.28	A
	2.0 + 2.5 + 3.5 + 4.2 + 4.2	16.4	1.27	1.59	2.22	2.66	2.66	10.40	3.4 ~ 14.5	2370	540 ~ 3820	4.39	A
	2.0 + 2.5 + 3.5 + 4.2 + 5.0	17.2	1.21	1.51	2.12	2.54	3.02	10.40	3.4 ~ 14.5	2460	630 ~ 3820	4.23	A
	2.0 + 2.5 + 3.5 + 4.2 + 6.0	18.2	1.14	1.43	2.00	2.40	3.43	10.40	3.4 ~ 14.5	2460	630 ~ 3820	4.23	A
	2.0 + 2.5 + 3.5 + 5.0 + 5.0	18.0	1.16	1.44	2.02	2.89	2.89	10.40	3.4 ~ 14.5	2560	750 ~ 3840	4.06	A
2.0 + 2.5 + 4.2 + 4.2 + 4.2	17.1	1.23	1.52	2.55	2.55	2.55	10.40	3.4 ~ 14.5	2370	540 ~ 3810	4.39	A	
2.0 + 2.5 + 4.2 + 4.2 + 5.0	17.9	1.16	1.45	2.44	2.44	2.91	10.40	3.4 ~ 14.5	2460	650 ~ 3810	4.23	A	
2.0 + 3.5 + 3.5 + 3.5 + 3.5	16.0	1.28	2.28	2.28	2.28	2.28	10.40	3.4 ~ 14.5	2370	540 ~ 3810	4.39	A	
2.0 + 3.5 + 3.5 + 3.5 + 4.2	16.7	1.25	2.18	2.18	2.18	2.61	10.40	3.4 ~ 14.5	2370	550 ~ 3800	4.39	A	
2.0 + 3.5 + 3.5 + 3.5 + 5.0	17.5	1.19	2.08	2.08	2.08	2.97	10.40	3.4 ~ 14.5	2460	650 ~ 3810	4.23	A	
2.0 + 3.5 + 3.5 + 4.2 + 4.2	17.4	1.20	2.09	2.09	2.51	2.51	10.40	3.4 ~ 14.5	2400	560 ~ 3790	4.33	A	
2.0 + 3.5 + 3.5 + 4.2 + 5.0	18.2	1.14	2.00	2.00	2.40	2.86	10.40	3.4 ~ 14.5	2460	660 ~ 3800	4.23	A	
2.0 + 3.5 + 4.2 + 4.2 + 4.2	18.1	1.15	2.02	2.41	2.41	2.41	10.40	3.4 ~ 14.5	2400	570 ~ 3780	4.33	A	
2.5 + 2.5 + 2.5 + 2.5 + 2.5	12.5	2.08	2.08	2.08	2.08	2.08	10.40	3.4 ~ 14.5	2330	460 ~ 3870	4.46	A	
2.5 + 2.5 + 2.5 + 2.5 + 3.5	13.5	1.93	1.93	1.93	1.93	2.68	10.40	3.4 ~ 14.5	2360	480 ~ 3840	4.41	A	
2.5 + 2.5 + 2.5 + 2.5 + 4.2	14.2	1.83	1.83	1.83	1.83	3.08	10.40	3.4 ~ 14.5	2360	490 ~ 3830	4.41	A	
2.5 + 2.5 + 2.5 + 2.5 + 5.0	15.0	1.73	1.73	1.73	1.73	3.48	10.40	3.4 ~ 14.5	2400	580 ~ 3830	4.33	A	
2.5 + 2.5 + 2.5 + 2.5 + 6.0	16.0	1.63	1.63	1.63	1.63	3.88	10.40	3.4 ~ 14.5	2400	580 ~ 3830	4.33	A	
2.5 + 2.5 + 2.5 + 2.5 + 7.1	17.1	1.52	1.52	1.52	1.52	4.32	10.40	3.4 ~ 14.5	2390	590 ~ 3810	4.35	A	
2.5 + 2.5 + 2.5 + 3.5 + 3.5	14.5	1.79	1.79	1.79	2.51	2.51	10.39	3.4 ~ 14.5	2350	510 ~ 3810	4.42	A	
2.5 + 2.5 + 2.5 + 3.5 + 4.2	15.2	1.71	1.71	1.71	2.39	2.88	10.40	3.4 ~ 14.5	2350	510 ~ 3800	4.43	A	
2.5 + 2.5 + 2.5 + 3.5 + 5.0	16.0	1.63	1.63	1.63	2.28	3.23	10.40	3.4 ~ 14.5	2430	600 ~ 3800	4.28	A	
2.5 + 2.5 + 2.5 + 3.5 + 6.0	17.0	1.53	1.53	1.53	2.14	3.67	10.40	3.4 ~ 14.5	2430	600 ~ 3800	4.28	A	



	Indoor unit capacity Heating	Annual Energy Consumption (kWh)	Current 230V (A)	ERP				Moisture Removal Volume l/h
				Pdesign (kW)	SCOP		Annual Consumption (kWh)	
					W/W	CLASS		
5 Room	2.0 + 2.0 + 2.5 + 4.2 + 7.1	1215	11.4	8.50	4.68	A++	2543	
	2.0 + 2.0 + 2.5 + 5.0 + 5.0	1265	11.9	8.50	4.68	A++	2543	
	2.0 + 2.0 + 2.5 + 5.0 + 6.0	1265	11.9	8.50	4.68	A++	2543	
	2.0 + 2.0 + 3.5 + 3.5 + 3.5	1190	11.2	8.50	4.68	A++	2543	
	2.0 + 2.0 + 3.5 + 3.5 + 4.2	1190	11.2	8.50	4.68	A++	2543	
	2.0 + 2.0 + 3.5 + 3.5 + 5.0	1215	11.4	8.50	4.68	A++	2543	
	2.0 + 2.0 + 3.5 + 3.5 + 6.0	1215	11.4	8.50	4.68	A++	2543	
	2.0 + 2.0 + 3.5 + 3.5 + 7.1	1230	11.6	8.50	4.68	A++	2543	
	2.0 + 2.0 + 3.5 + 4.2 + 4.2	1185	11.1	8.50	4.68	A++	2543	
	2.0 + 2.0 + 3.5 + 4.2 + 5.0	1230	11.6	8.50	4.68	A++	2543	
	2.0 + 2.0 + 3.5 + 4.2 + 6.0	1230	11.6	8.50	4.68	A++	2543	
	2.0 + 2.0 + 3.5 + 5.0 + 5.0	1280	12.0	8.50	4.68	A++	2543	
	2.0 + 2.0 + 4.2 + 4.2 + 4.2	1185	11.1	8.50	4.68	A++	2543	
	2.0 + 2.0 + 4.2 + 4.2 + 5.0	1230	11.6	8.50	4.68	A++	2543	
	2.0 + 2.0 + 4.2 + 5.0 + 5.0	1285	12.1	8.50	4.68	A++	2543	
	2.0 + 2.5 + 2.5 + 2.5 + 2.5	1165	10.9	8.50	4.68	A++	2543	
	2.0 + 2.5 + 2.5 + 2.5 + 3.5	1180	11.1	8.50	4.68	A++	2543	
	2.0 + 2.5 + 2.5 + 2.5 + 4.2	1180	11.1	8.50	4.68	A++	2543	
	2.0 + 2.5 + 2.5 + 2.5 + 5.0	1200	11.3	8.50	4.68	A++	2543	
	2.0 + 2.5 + 2.5 + 2.5 + 6.0	1200	11.3	8.50	4.68	A++	2543	
	2.0 + 2.5 + 2.5 + 2.5 + 7.1	1195	11.2	8.50	4.68	A++	2543	
	2.0 + 2.5 + 2.5 + 3.5 + 3.5	1175	11.0	8.50	4.68	A++	2543	
	2.0 + 2.5 + 2.5 + 3.5 + 4.2	1175	11.0	8.50	4.68	A++	2543	
	2.0 + 2.5 + 2.5 + 3.5 + 5.0	1215	11.4	8.50	4.68	A++	2543	
	2.0 + 2.5 + 2.5 + 3.5 + 6.0	1215	11.4	8.50	4.68	A++	2543	
	2.0 + 2.5 + 2.5 + 3.5 + 7.1	1215	11.4	8.50	4.68	A++	2543	
	2.0 + 2.5 + 2.5 + 4.2 + 4.2	1190	11.2	8.50	4.68	A++	2543	
	2.0 + 2.5 + 2.5 + 4.2 + 5.0	1215	11.4	8.50	4.68	A++	2543	
	2.0 + 2.5 + 2.5 + 4.2 + 6.0	1215	11.4	8.50	4.68	A++	2543	
	2.0 + 2.5 + 2.5 + 4.2 + 7.1	1215	11.4	8.50	4.68	A++	2543	
	2.0 + 2.5 + 2.5 + 5.0 + 5.0	1265	11.9	8.50	4.68	A++	2543	
	2.0 + 2.5 + 2.5 + 5.0 + 6.0	1265	11.9	8.50	4.68	A++	2543	
	2.0 + 2.5 + 3.5 + 3.5 + 3.5	1190	11.2	8.50	4.68	A++	2543	
	2.0 + 2.5 + 3.5 + 3.5 + 4.2	1190	11.2	8.50	4.68	A++	2543	
	2.0 + 2.5 + 3.5 + 3.5 + 5.0	1215	11.4	8.50	4.68	A++	2543	
	2.0 + 2.5 + 3.5 + 3.5 + 6.0	1215	11.4	8.50	4.68	A++	2543	
	2.0 + 2.5 + 3.5 + 4.2 + 4.2	1185	11.1	8.50	4.68	A++	2543	
	2.0 + 2.5 + 3.5 + 4.2 + 5.0	1230	11.6	8.50	4.68	A++	2543	
	2.0 + 2.5 + 3.5 + 4.2 + 6.0	1230	11.6	8.50	4.68	A++	2543	
	2.0 + 2.5 + 3.5 + 5.0 + 5.0	1280	12.0	8.50	4.68	A++	2543	
	2.0 + 2.5 + 4.2 + 4.2 + 4.2	1185	11.1	8.50	4.68	A++	2543	
	2.0 + 2.5 + 4.2 + 4.2 + 5.0	1230	11.6	8.50	4.68	A++	2543	
	2.0 + 3.5 + 3.5 + 3.5 + 3.5	1185	11.1	8.50	4.68	A++	2543	
	2.0 + 3.5 + 3.5 + 3.5 + 4.2	1185	11.1	8.50	4.68	A++	2543	
	2.0 + 3.5 + 3.5 + 3.5 + 5.0	1230	11.6	8.50	4.68	A++	2543	
	2.0 + 3.5 + 3.5 + 4.2 + 4.2	1200	11.3	8.50	4.68	A++	2543	
	2.0 + 3.5 + 3.5 + 4.2 + 5.0	1230	11.6	8.50	4.68	A++	2543	
	2.0 + 3.5 + 4.2 + 4.2 + 4.2	1200	11.3	8.50	4.68	A++	2543	
	2.5 + 2.5 + 2.5 + 2.5 + 2.5	1165	10.9	8.50	4.68	A++	2543	
	2.5 + 2.5 + 2.5 + 2.5 + 3.5	1180	11.1	8.50	4.68	A++	2543	
2.5 + 2.5 + 2.5 + 2.5 + 4.2	1180	11.1	8.50	4.68	A++	2543		
2.5 + 2.5 + 2.5 + 2.5 + 5.0	1200	11.3	8.50	4.68	A++	2543		
2.5 + 2.5 + 2.5 + 2.5 + 6.0	1200	11.3	8.50	4.68	A++	2543		
2.5 + 2.5 + 2.5 + 2.5 + 7.1	1195	11.2	8.50	4.68	A++	2543		
2.5 + 2.5 + 2.5 + 3.5 + 3.5	1175	11.0	8.50	4.68	A++	2543		
2.5 + 2.5 + 2.5 + 3.5 + 4.2	1175	11.0	8.50	4.68	A++	2543		
2.5 + 2.5 + 2.5 + 3.5 + 5.0	1215	11.4	8.50	4.68	A++	2543		
2.5 + 2.5 + 2.5 + 3.5 + 6.0	1215	11.4	8.50	4.68	A++	2543		

Indoor unit capacity Heating		Total	Heating Capacity (kW)							Input Power (W)		COP	
			Room A	Room B	Room C	Room D	Room E	Total	min ~ max	Rating	min ~ max	WW	CLASS
5 Room	2.5 + 2.5 + 2.5 + 3.5 + 7.1	18.1	1.44	1.44	1.44	2.01	4.07	10.40	3.4 ~ 14.5	2430	620 ~ 3790	4.28	A
	2.5 + 2.5 + 2.5 + 4.2 + 4.2	15.9	1.64	1.64	1.64	2.74	2.74	10.40	3.4 ~ 14.5	2380	520 ~ 3790	4.37	A
	2.5 + 2.5 + 2.5 + 4.2 + 5.0	16.7	1.56	1.56	1.56	2.62	3.10	10.40	3.4 ~ 14.5	2430	610 ~ 3790	4.28	A
	2.5 + 2.5 + 2.5 + 4.2 + 6.0	17.7	1.47	1.47	1.47	2.47	3.52	10.40	3.4 ~ 14.5	2430	610 ~ 3790	4.28	A
	2.5 + 2.5 + 2.5 + 5.0 + 5.0	17.5	1.49	1.49	1.49	2.96	2.96	10.39	3.4 ~ 14.5	2530	720 ~ 3860	4.11	A
	2.5 + 2.5 + 3.5 + 3.5 + 3.5	15.5	1.67	1.67	2.35	2.35	2.35	10.39	3.4 ~ 14.5	2380	520 ~ 3840	4.37	A
	2.5 + 2.5 + 3.5 + 3.5 + 4.2	16.2	1.60	1.60	2.25	2.25	2.70	10.40	3.4 ~ 14.5	2380	530 ~ 3830	4.37	A
	2.5 + 2.5 + 3.5 + 3.5 + 5.0	17.0	1.53	1.53	2.14	2.14	3.06	10.40	3.4 ~ 14.5	2430	630 ~ 3830	4.28	A
	2.5 + 2.5 + 3.5 + 3.5 + 6.0	18.0	1.44	1.44	2.02	2.02	3.48	10.40	3.4 ~ 14.5	2430	630 ~ 3830	4.28	A
	2.5 + 2.5 + 3.5 + 4.2 + 4.2	16.9	1.54	1.54	2.16	2.58	2.58	10.40	3.4 ~ 14.5	2370	540 ~ 3820	4.39	A
	2.5 + 2.5 + 3.5 + 4.2 + 5.0	17.7	1.47	1.47	2.06	2.47	2.93	10.40	3.4 ~ 14.5	2460	630 ~ 3820	4.23	A
	2.5 + 2.5 + 4.2 + 4.2 + 4.2	17.6	1.48	1.48	2.48	2.48	2.48	10.40	3.4 ~ 14.5	2370	540 ~ 3810	4.39	A
	2.5 + 3.5 + 3.5 + 3.5 + 3.5	16.5	1.56	2.21	2.21	2.21	2.21	10.40	3.4 ~ 14.5	2370	540 ~ 3810	4.39	A
	2.5 + 3.5 + 3.5 + 3.5 + 4.2	17.2	1.51	2.12	2.12	2.12	2.53	10.40	3.4 ~ 14.5	2370	550 ~ 3800	4.39	A
	2.5 + 3.5 + 3.5 + 3.5 + 5.0	18.0	1.44	2.02	2.02	2.02	2.90	10.40	3.4 ~ 14.5	2460	650 ~ 3810	4.23	A
	2.5 + 3.5 + 3.5 + 4.2 + 4.2	17.9	1.46	2.03	2.03	2.44	2.44	10.40	3.4 ~ 14.5	2400	560 ~ 3790	4.33	A
	3.5 + 3.5 + 3.5 + 3.5 + 3.5	17.5	2.08	2.08	2.08	2.08	2.08	10.40	3.4 ~ 14.5	2400	570 ~ 3780	4.33	A
3.5 + 3.5 + 3.5 + 3.5 + 4.2	18.2	2.00	2.00	2.00	2.00	2.40	10.40	3.4 ~ 14.5	2400	570 ~ 3830	4.33	A	

	Indoor unit capacity Heating	Annual Energy Consumption (kWh)	Current 230V (A)	ERP				Moisture Removal Volume l/h
				Pdesign (kW)	SCOP		Annual Consumption (kWh)	
					W/W	CLASS		
5 Room	2.5 + 2.5 + 2.5 + 3.5 + 7.1	1215	11.4	8.50	4.68	A++	2543	
	2.5 + 2.5 + 2.5 + 4.2 + 4.2	1190	11.2	8.50	4.68	A++	2543	
	2.5 + 2.5 + 2.5 + 4.2 + 5.0	1215	11.4	8.50	4.68	A++	2543	
	2.5 + 2.5 + 2.5 + 4.2 + 6.0	1215	11.4	8.50	4.68	A++	2543	
	2.5 + 2.5 + 2.5 + 5.0 + 5.0	1265	11.9	8.50	4.68	A++	2543	
	2.5 + 2.5 + 3.5 + 3.5 + 3.5	1190	11.2	8.50	4.68	A++	2543	
	2.5 + 2.5 + 3.5 + 3.5 + 4.2	1190	11.2	8.50	4.68	A++	2543	
	2.5 + 2.5 + 3.5 + 3.5 + 5.0	1215	11.4	8.50	4.68	A++	2543	
	2.5 + 2.5 + 3.5 + 3.5 + 6.0	1215	11.4	8.50	4.68	A++	2543	
	2.5 + 2.5 + 3.5 + 4.2 + 4.2	1185	11.1	8.50	4.68	A++	2543	
	2.5 + 2.5 + 3.5 + 4.2 + 5.0	1230	11.6	8.50	4.68	A++	2543	
	2.5 + 2.5 + 4.2 + 4.2 + 4.2	1185	11.1	8.50	4.68	A++	2543	
	2.5 + 3.5 + 3.5 + 3.5 + 3.5	1185	11.1	8.50	4.68	A++	2543	
	2.5 + 3.5 + 3.5 + 3.5 + 4.2	1185	11.1	8.50	4.68	A++	2543	
	2.5 + 3.5 + 3.5 + 3.5 + 5.0	1230	11.6	8.50	4.68	A++	2543	
	2.5 + 3.5 + 3.5 + 4.2 + 4.2	1200	11.3	8.50	4.68	A++	2543	
	3.5 + 3.5 + 3.5 + 3.5 + 3.5	1200	11.3	8.50	4.68	A++	2543	
	3.5 + 3.5 + 3.5 + 3.5 + 4.2	1200	11.3	8.50	4.68	A++	2543	

- Indoor Unit : Combination of all type of wall and non-wall series (CS-MZ / Z / XZ / MTZ / TZ / TE / E)
- Outdoor Unit : CU-5Z90TBE

Indoor unit capacity Cooling	Total	Cooling Capacity (kW)							Input Power (W)		EER		
		Room A	Room B	Room C	Room D	Room E	Total	min ~ max	Rating	min ~ max	WW	CLASS	
1 Room	1.6	1.6	1.60					1.60	1.3 ~ 2.3	450	250 ~ 690	3.56	A
	2.0	2.0	2.00					2.00	1.8 ~ 2.9	550	340 ~ 860	3.64	A
	2.5	2.5	2.50					2.50	1.8 ~ 2.9	680	340 ~ 860	3.68	A
	3.5	3.5	3.50					3.50	1.8 ~ 4.1	990	340 ~ 1410	3.54	A
	4.2	4.2	4.20					4.20	1.8 ~ 4.5	1420	340 ~ 2040	2.96	C
	5.0	5.0	5.00					5.00	1.9 ~ 5.7	1600	340 ~ 2180	3.13	B
	6.0	6.0	6.00					6.00	1.9 ~ 6.2	2080	340 ~ 2380	2.88	C
	7.1	7.1	7.10					7.10	2.0 ~ 7.2	2580	370 ~ 2820	2.75	D
2 Room	1.6 + 1.6	3.2	1.60	1.60				3.20	2.4 ~ 5.8	760	270 ~ 1840	4.21	A
	1.6 + 2.0	3.6	1.60	2.00				3.60	2.4 ~ 5.8	890	270 ~ 1840	4.04	A
	1.6 + 2.5	4.1	1.60	2.50				4.10	2.4 ~ 5.8	1060	270 ~ 1840	3.87	A
	1.6 + 3.5	5.1	1.60	3.50				5.10	2.4 ~ 5.8	1420	260 ~ 1780	3.59	A
	1.6 + 4.2	5.8	1.60	4.20				5.80	2.4 ~ 6.7	1730	260 ~ 2230	3.35	A
	1.6 + 5.0	6.6	1.60	5.00				6.60	2.4 ~ 7.2	1940	250 ~ 2230	3.40	A
	1.6 + 6.0	7.6	1.60	6.00				7.60	2.4 ~ 8.6	2470	250 ~ 3180	3.08	B
	1.6 + 7.1	8.7	1.60	7.10				8.70	2.5 ~ 9.1	3020	270 ~ 3260	2.88	C
	2.0 + 2.0	4.0	2.00	2.00				4.00	2.4 ~ 5.8	1020	260 ~ 1780	3.92	A
	2.0 + 2.5	4.5	2.00	2.50				4.50	2.4 ~ 5.8	1220	260 ~ 1780	3.69	A
	2.0 + 3.5	5.5	2.00	3.50				5.50	2.4 ~ 5.8	1570	260 ~ 1730	3.50	A
	2.0 + 4.2	6.2	2.00	4.20				6.20	2.4 ~ 7.2	1940	260 ~ 2590	3.20	B
	2.0 + 5.0	7.0	2.00	5.00				7.00	2.4 ~ 8.1	2050	250 ~ 2710	3.41	A
	2.0 + 6.0	8.0	2.00	6.00				8.00	2.4 ~ 8.6	2650	250 ~ 3110	3.02	B
	2.0 + 7.1	9.1	1.98	7.02				9.00	2.5 ~ 10.0	3220	270 ~ 4130	2.80	D
	2.5 + 2.5	5.0	2.50	2.50				5.00	2.4 ~ 5.8	1370	260 ~ 1780	3.65	A
	2.5 + 3.5	6.0	2.50	3.50				6.00	2.4 ~ 6.7	1830	260 ~ 2230	3.28	A
	2.5 + 4.2	6.7	2.50	4.20				6.70	2.4 ~ 7.2	2230	260 ~ 2590	3.00	B
	2.5 + 5.0	7.5	2.50	5.00				7.50	2.4 ~ 8.6	2350	250 ~ 3110	3.19	B
	2.5 + 6.0	8.5	2.50	6.00				8.50	2.5 ~ 9.1	3040	270 ~ 3390	2.80	D
	2.5 + 7.1	9.6	2.34	6.66				9.00	2.5 ~ 10.1	3220	270 ~ 4280	2.80	D
	3.5 + 3.5	7.0	3.50	3.50				7.00	2.4 ~ 8.1	2350	260 ~ 3160	2.98	C
	3.5 + 4.2	7.7	3.50	4.20				7.70	2.4 ~ 8.6	2770	260 ~ 3650	2.78	D
	3.5 + 5.0	8.5	3.50	5.00				8.50	2.5 ~ 9.1	2910	270 ~ 3260	2.92	C
	3.5 + 6.0	9.5	3.32	5.68				9.00	2.5 ~ 10.1	3290	270 ~ 4280	2.74	D
	3.5 + 7.1	10.6	2.97	6.03				9.00	2.5 ~ 10.4	3090	270 ~ 4440	2.91	C
	4.2 + 4.2	8.4	4.20	4.20				8.40	2.5 ~ 9.1	3440	280 ~ 4060	2.44	E
4.2 + 5.0	9.2	4.11	4.89				9.00	2.5 ~ 10.0	3220	270 ~ 4130	2.80	D	
4.2 + 6.0	10.2	3.71	5.29				9.00	2.5 ~ 10.4	3220	270 ~ 4430	2.80	D	
4.2 + 7.1	11.3	3.35	5.65				9.00	2.5 ~ 10.4	3090	270 ~ 4440	2.91	C	
5.0 + 5.0	10.0	4.50	4.50				9.00	2.5 ~ 10.4	2760	260 ~ 3710	3.26	A	
5.0 + 6.0	11.0	4.09	4.91				9.00	2.5 ~ 10.4	2760	260 ~ 3710	3.26	A	
5.0 + 7.1	12.1	3.72	5.28				9.00	2.5 ~ 10.4	2700	260 ~ 3580	3.33	A	
6.0 + 6.0	12.0	4.50	4.50				9.00	2.5 ~ 10.4	2760	260 ~ 3710	3.26	A	
6.0 + 7.1	13.1	4.12	4.88				9.00	2.5 ~ 10.4	2700	260 ~ 3580	3.33	A	
7.1 + 7.1	14.2	4.50	4.50				9.00	2.5 ~ 10.4	2570	290 ~ 3440	3.50	A	

	Indoor unit capacity Cooling	Annual Energy Consumption (kWh)	Current 230V (A)	ERP				Moisture Removal Volume l/h
				Pdesign (kW)	SEER		Annual Consumption (kWh)	
					W/W	CLASS		
1 Room	1.6	225	2.3	-	-	-	-	1.0
	2.0	275	2.7	-	-	-	-	1.3
	2.5	340	3.4	-	-	-	-	1.5
	3.5	495	4.8	-	-	-	-	2.0
	4.2	710	6.6	-	-	-	-	2.4
	5.0	800	7.5	-	-	-	-	2.7
	6.0	1040	9.4	-	-	-	-	3.3
	7.1	1290	11.7	-	-	-	-	4.1
2 Room	1.6 + 1.6	380	3.8	3.20	5.10	A	220	1.0 + 1.0
	1.6 + 2.0	445	4.4	3.60	5.10	A	247	1.0 + 1.3
	1.6 + 2.5	530	5.2	4.10	5.10	A	281	1.0 + 1.5
	1.6 + 3.5	710	6.9	5.10	5.10	A	350	1.0 + 2.0
	1.6 + 4.2	865	8.4	5.80	5.10	A	398	1.0 + 2.4
	1.6 + 5.0	970	9.3	6.60	5.10	A	453	1.0 + 2.7
	1.6 + 6.0	1235	11.8	7.60	5.10	A	522	1.0 + 3.3
	1.6 + 7.1	1510	14.5	8.70	5.10	A	597	1.0 + 4.1
	2.0 + 2.0	510	5.0	4.00	5.10	A	275	1.3 + 1.3
	2.0 + 2.5	610	6.0	4.50	5.10	A	309	1.3 + 1.5
	2.0 + 3.5	785	7.6	5.50	5.10	A	377	1.3 + 2.0
	2.0 + 4.2	970	9.3	6.20	5.10	A	425	1.3 + 2.4
	2.0 + 5.0	1025	9.8	7.00	5.10	A	480	1.3 + 2.7
	2.0 + 6.0	1325	12.7	8.00	5.10	A	549	1.3 + 3.3
	2.0 + 7.1	1610	15.4	9.00	5.10	A	618	1.3 + 4.0
	2.5 + 2.5	685	6.6	5.00	5.10	A	343	1.5 + 1.5
	2.5 + 3.5	915	8.8	6.00	5.10	A	412	1.5 + 2.0
	2.5 + 4.2	1115	10.7	6.70	5.10	A	460	1.5 + 2.4
	2.5 + 5.0	1175	11.2	7.50	5.10	A	515	1.5 + 2.7
	2.5 + 6.0	1520	14.6	8.50	5.10	A	583	1.5 + 3.3
	2.5 + 7.1	1610	15.4	9.00	5.10	A	618	1.5 + 3.8
	3.5 + 3.5	1175	11.2	7.00	5.10	A	480	2.0 + 2.0
	3.5 + 4.2	1385	13.3	7.70	5.10	A	528	2.0 + 2.4
	3.5 + 5.0	1455	13.9	8.50	5.10	A	583	2.0 + 2.7
	3.5 + 6.0	1645	15.7	9.00	5.10	A	618	1.9 + 3.1
	3.5 + 7.1	1545	14.8	9.00	5.10	A	618	1.7 + 3.3
	4.2 + 4.2	1720	16.5	8.40	5.10	A	576	2.4 + 2.4
4.2 + 5.0	1610	15.4	9.00	5.10	A	618	2.3 + 2.7	
4.2 + 6.0	1610	15.4	9.00	5.10	A	618	2.2 + 2.9	
4.2 + 7.1	1545	14.8	9.00	5.10	A	618	1.9 + 3.1	
5.0 + 5.0	1380	13.2	9.00	5.10	A	618	2.5 + 2.5	
5.0 + 6.0	1380	13.2	9.00	5.10	A	618	2.3 + 2.7	
5.0 + 7.1	1350	12.9	9.00	5.10	A	618	2.2 + 2.9	
6.0 + 6.0	1380	13.2	9.00	5.10	A	618	2.5 + 2.5	
6.0 + 7.1	1350	12.9	9.00	5.10	A	618	2.3 + 2.7	
7.1 + 7.1	1285	12.3	9.00	5.10	A	618	2.5 + 2.5	

	Indoor unit capacity Cooling	Total	Cooling Capacity (kW)						Input Power (W)		EER		
			Room A	Room B	Room C	Room D	Room E	Total	min ~ max	Rating	min ~ max	WW	CLASS
3 Room	1.6 + 1.6 + 1.6	4.8	1.60	1.60	1.60			4.80	2.9 ~ 8.5	1140	320 ~ 2770	4.21	A
	1.6 + 1.6 + 2.0	5.2	1.60	1.60	2.00			5.20	2.9 ~ 8.5	1250	320 ~ 2770	4.16	A
	1.6 + 1.6 + 2.5	5.7	1.60	1.60	2.50			5.70	2.9 ~ 8.5	1440	320 ~ 2770	3.96	A
	1.6 + 1.6 + 3.5	6.7	1.60	1.60	3.50			6.70	2.9 ~ 8.5	1760	310 ~ 2700	3.81	A
	1.6 + 1.6 + 4.2	7.4	1.60	1.60	4.20			7.40	2.9 ~ 8.5	2100	340 ~ 2640	3.52	A
	1.6 + 1.6 + 5.0	8.2	1.60	1.60	5.00			8.20	2.9 ~ 8.7	2260	340 ~ 2440	3.63	A
	1.6 + 1.6 + 6.0	9.2	1.57	1.57	5.86			9.00	2.9 ~ 10.1	2620	340 ~ 3150	3.44	A
	1.6 + 1.6 + 7.1	10.3	1.40	1.40	6.20			9.00	2.9 ~ 10.7	2560	340 ~ 3490	3.52	A
	1.6 + 2.0 + 2.0	5.6	1.60	2.00	2.00			5.60	2.9 ~ 8.5	1390	310 ~ 2700	4.03	A
	1.6 + 2.0 + 2.5	6.1	1.60	2.00	2.50			6.10	2.9 ~ 8.5	1600	310 ~ 2700	3.81	A
	1.6 + 2.0 + 3.5	7.1	1.60	2.00	3.50			7.10	2.9 ~ 8.5	1930	340 ~ 2640	3.68	A
	1.6 + 2.0 + 4.2	7.8	1.60	2.00	4.20			7.80	2.9 ~ 8.5	2210	340 ~ 2640	3.53	A
	1.6 + 2.0 + 5.0	8.6	1.60	2.00	5.00			8.60	2.9 ~ 9.6	2450	340 ~ 2770	3.51	A
	1.6 + 2.0 + 6.0	9.6	1.49	1.88	5.63			9.00	2.9 ~ 10.1	2560	340 ~ 3090	3.52	A
	1.6 + 2.0 + 7.1	10.7	1.35	1.68	5.97			9.00	2.9 ~ 10.7	2500	340 ~ 3490	3.60	A
	1.6 + 2.5 + 2.5	6.6	1.60	2.50	2.50			6.60	2.9 ~ 8.5	1810	310 ~ 2700	3.65	A
	1.6 + 2.5 + 3.5	7.6	1.60	2.50	3.50			7.60	2.9 ~ 8.5	2210	340 ~ 2640	3.44	A
	1.6 + 2.5 + 4.2	8.3	1.60	2.50	4.20			8.30	2.9 ~ 8.7	2510	340 ~ 2690	3.31	A
	1.6 + 2.5 + 5.0	9.1	1.58	2.47	4.95			9.00	2.9 ~ 10.1	2560	340 ~ 3090	3.52	A
	1.6 + 2.5 + 6.0	10.1	1.42	2.23	5.35			9.00	2.9 ~ 10.7	2560	340 ~ 3630	3.52	A
	1.6 + 2.5 + 7.1	11.2	1.28	2.01	5.71			9.00	2.9 ~ 10.7	2500	340 ~ 3490	3.60	A
	1.6 + 3.5 + 3.5	8.6	1.60	3.50	3.50			8.60	2.9 ~ 9.6	2640	340 ~ 3080	3.26	A
	1.6 + 3.5 + 4.2	9.3	1.55	3.39	4.06			9.00	2.9 ~ 10.1	2810	340 ~ 3480	3.20	A
	1.6 + 3.5 + 5.0	10.1	1.42	3.12	4.46			9.00	2.9 ~ 10.7	2560	340 ~ 3490	3.52	A
	1.6 + 3.5 + 6.0	11.1	1.30	2.84	4.86			9.00	2.9 ~ 10.7	2560	340 ~ 3490	3.52	A
	1.6 + 3.5 + 7.1	12.2	1.18	2.58	5.24			9.00	2.9 ~ 10.7	2500	340 ~ 3350	3.60	A
	1.6 + 4.2 + 4.2	10.0	1.44	3.78	3.78			9.00	2.9 ~ 10.7	2810	340 ~ 4060	3.20	A
	1.6 + 4.2 + 5.0	10.8	1.33	3.50	4.17			9.00	2.9 ~ 10.7	2500	340 ~ 3490	3.60	A
	1.6 + 4.2 + 6.0	11.8	1.22	3.20	4.58			9.00	2.9 ~ 10.7	2500	340 ~ 3490	3.60	A
	1.6 + 4.2 + 7.1	12.9	1.12	2.93	4.95			9.00	2.9 ~ 10.7	2430	370 ~ 3350	3.70	A
	1.6 + 5.0 + 5.0	11.6	1.24	3.88	3.88			9.00	2.9 ~ 10.7	2310	370 ~ 3090	3.90	A
	1.6 + 5.0 + 6.0	12.6	1.14	3.57	4.29			9.00	2.9 ~ 10.7	2310	370 ~ 3090	3.90	A
	1.6 + 5.0 + 7.1	13.7	1.05	3.28	4.67			9.00	3.0 ~ 10.7	2320	400 ~ 3020	3.88	A
	1.6 + 6.0 + 6.0	13.6	1.06	3.97	3.97			9.00	3.0 ~ 10.7	2310	400 ~ 3090	3.90	A
	1.6 + 6.0 + 7.1	14.7	0.98	3.67	4.35			9.00	3.0 ~ 10.7	2320	400 ~ 3020	3.88	A
	1.6 + 7.1 + 7.1	15.8	0.92	4.04	4.04			9.00	3.0 ~ 10.7	2260	400 ~ 2960	3.98	A
	2.0 + 2.0 + 2.0	6.0	2.00	2.00	2.00			6.00	2.9 ~ 8.5	1540	310 ~ 2700	3.90	A
	2.0 + 2.0 + 2.5	6.5	2.00	2.00	2.50			6.50	2.9 ~ 8.5	1750	310 ~ 2700	3.71	A
	2.0 + 2.0 + 3.5	7.5	2.00	2.00	3.50			7.50	2.9 ~ 8.5	2100	340 ~ 2640	3.57	A
	2.0 + 2.0 + 4.2	8.2	2.00	2.00	4.20			8.20	2.9 ~ 8.7	2450	340 ~ 2690	3.35	A
	2.0 + 2.0 + 5.0	9.0	2.00	2.00	5.00			9.00	2.9 ~ 9.6	2560	340 ~ 2770	3.52	A
	2.0 + 2.0 + 6.0	10.0	1.80	1.80	5.40			9.00	2.9 ~ 10.7	2560	340 ~ 3560	3.52	A
2.0 + 2.0 + 7.1	11.1	1.62	1.62	5.76			9.00	2.9 ~ 10.7	2500	340 ~ 3420	3.60	A	
2.0 + 2.5 + 2.5	7.0	2.00	2.50	2.50			7.00	2.9 ~ 8.5	1930	310 ~ 2700	3.63	A	
2.0 + 2.5 + 3.5	8.0	2.00	2.50	3.50			8.00	2.9 ~ 8.5	2330	340 ~ 2640	3.43	A	
2.0 + 2.5 + 4.2	8.7	2.00	2.50	4.20			8.70	2.9 ~ 9.6	2690	340 ~ 3150	3.23	A	
2.0 + 2.5 + 5.0	9.5	1.89	2.37	4.74			9.00	2.9 ~ 10.1	2560	340 ~ 3090	3.52	A	
2.0 + 2.5 + 6.0	10.5	1.71	2.14	5.15			9.00	2.9 ~ 10.7	2560	340 ~ 3560	3.52	A	
2.0 + 2.5 + 7.1	11.6	1.55	1.94	5.51			9.00	2.9 ~ 10.7	2500	340 ~ 3420	3.60	A	
2.0 + 3.5 + 3.5	9.0	2.00	3.50	3.50			9.00	2.9 ~ 9.6	2810	340 ~ 3080	3.20	A	
2.0 + 3.5 + 4.2	9.7	1.85	3.25	3.90			9.00	2.9 ~ 10.7	2810	340 ~ 4060	3.20	A	
2.0 + 3.5 + 5.0	10.5	1.71	3.00	4.29			9.00	2.9 ~ 10.7	2500	340 ~ 3490	3.60	A	
2.0 + 3.5 + 6.0	11.5	1.56	2.74	4.70			9.00	2.9 ~ 10.7	2500	340 ~ 3490	3.60	A	
2.0 + 3.5 + 7.1	12.6	1.43	2.50	5.07			9.00	2.9 ~ 10.7	2430	370 ~ 3350	3.70	A	
2.0 + 4.2 + 4.2	10.4	1.74	3.63	3.63			9.00	2.9 ~ 10.7	2750	340 ~ 4060	3.27	A	
2.0 + 4.2 + 5.0	11.2	1.60	3.38	4.02			9.00	2.9 ~ 10.7	2500	340 ~ 3420	3.60	A	
2.0 + 4.2 + 6.0	12.2	1.47	3.10	4.43			9.00	2.9 ~ 10.7	2500	340 ~ 3420	3.60	A	
2.0 + 4.2 + 7.1	13.3	1.35	2.84	4.81			9.00	2.9 ~ 10.7	2430	370 ~ 3350	3.70	A	

	Indoor unit capacity Cooling	Annual Energy Consumption (kWh)	Current 230V (A)	ERP				Moisture Removal Volume l/h
				Pdesign (kW)	SEER		Annual Consumption (kWh)	
					WW	CLASS		
3 Room	1.6 + 1.6 + 1.6	570	5.6	4.80	5.60	A+	300	1.0 + 1.0 + 1.0
	1.6 + 1.6 + 2.0	625	6.0	5.20	5.60	A+	325	1.0 + 1.0 + 1.3
	1.6 + 1.6 + 2.5	720	7.0	5.70	5.60	A+	356	1.0 + 1.0 + 1.5
	1.6 + 1.6 + 3.5	880	8.4	6.70	5.60	A+	419	1.0 + 1.0 + 2.0
	1.6 + 1.6 + 4.2	1050	10.1	7.40	5.60	A+	463	1.0 + 1.0 + 2.4
	1.6 + 1.6 + 5.0	1130	10.8	8.20	5.60	A+	513	1.0 + 1.0 + 2.7
	1.6 + 1.6 + 6.0	1310	12.5	9.00	5.60	A+	563	1.0 + 1.0 + 3.2
	1.6 + 1.6 + 7.1	1280	12.3	9.00	5.60	A+	563	0.9 + 0.9 + 3.5
	1.6 + 2.0 + 2.0	695	6.7	5.60	5.60	A+	350	1.0 + 1.3 + 1.3
	1.6 + 2.0 + 2.5	800	7.7	6.10	5.60	A+	381	1.0 + 1.3 + 1.5
	1.6 + 2.0 + 3.5	965	9.2	7.10	5.60	A+	444	1.0 + 1.3 + 2.0
	1.6 + 2.0 + 4.2	1105	10.6	7.80	5.60	A+	488	1.0 + 1.3 + 2.4
	1.6 + 2.0 + 5.0	1225	11.7	8.60	5.60	A+	538	1.0 + 1.3 + 2.7
	1.6 + 2.0 + 6.0	1280	12.3	9.00	5.60	A+	563	0.9 + 1.2 + 3.1
	1.6 + 2.0 + 7.1	1250	12.0	9.00	5.60	A+	563	0.9 + 1.1 + 3.3
	1.6 + 2.5 + 2.5	905	8.7	6.60	5.60	A+	413	1.0 + 1.5 + 1.5
	1.6 + 2.5 + 3.5	1105	10.6	7.60	5.60	A+	475	1.0 + 1.5 + 2.0
	1.6 + 2.5 + 4.2	1255	12.0	8.30	5.60	A+	519	1.0 + 1.5 + 2.4
	1.6 + 2.5 + 5.0	1280	12.3	9.00	5.60	A+	563	1.0 + 1.5 + 2.7
	1.6 + 2.5 + 6.0	1280	12.3	9.00	5.60	A+	563	0.9 + 1.5 + 2.9
	1.6 + 2.5 + 7.1	1250	12.0	9.00	5.60	A+	563	0.8 + 1.3 + 3.1
	1.6 + 3.5 + 3.5	1320	12.6	8.60	5.60	A+	538	1.0 + 2.0 + 2.0
	1.6 + 3.5 + 4.2	1405	13.5	9.00	5.60	A+	563	1.0 + 1.9 + 2.3
	1.6 + 3.5 + 5.0	1280	12.3	9.00	5.60	A+	563	0.9 + 1.8 + 2.5
	1.6 + 3.5 + 6.0	1280	12.3	9.00	5.60	A+	563	0.8 + 1.7 + 2.6
	1.6 + 3.5 + 7.1	1250	12.0	9.00	5.60	A+	563	0.7 + 1.6 + 2.9
	1.6 + 4.2 + 4.2	1405	13.5	9.00	5.60	A+	563	0.9 + 2.2 + 2.2
	1.6 + 4.2 + 5.0	1250	12.0	9.00	5.60	A+	563	0.8 + 2.0 + 2.4
	1.6 + 4.2 + 6.0	1250	12.0	9.00	5.60	A+	563	0.8 + 1.8 + 2.5
	1.6 + 4.2 + 7.1	1215	11.6	9.00	5.60	A+	563	0.7 + 1.7 + 2.7
	1.6 + 5.0 + 5.0	1155	11.1	9.00	5.60	A+	563	0.8 + 2.3 + 2.3
	1.6 + 5.0 + 6.0	1155	11.1	9.00	5.60	A+	563	0.7 + 2.1 + 2.4
	1.6 + 5.0 + 7.1	1160	11.1	9.00	5.60	A+	563	0.7 + 1.9 + 2.5
	1.6 + 6.0 + 6.0	1155	11.1	9.00	5.60	A+	563	0.7 + 2.3 + 2.3
	1.6 + 6.0 + 7.1	1160	11.1	9.00	5.60	A+	563	0.7 + 2.1 + 2.4
	1.6 + 7.1 + 7.1	1130	10.8	9.00	5.60	A+	563	0.7 + 2.3 + 2.3
	2.0 + 2.0 + 2.0	770	7.4	6.00	5.60	A+	375	1.3 + 1.3 + 1.3
	2.0 + 2.0 + 2.5	875	8.4	6.50	5.60	A+	406	1.3 + 1.3 + 1.5
	2.0 + 2.0 + 3.5	1050	10.1	7.50	5.60	A+	469	1.3 + 1.3 + 2.0
	2.0 + 2.0 + 4.2	1225	11.7	8.20	5.60	A+	513	1.3 + 1.3 + 2.4
	2.0 + 2.0 + 5.0	1280	12.3	9.00	5.60	A+	563	1.3 + 1.3 + 2.7
	2.0 + 2.0 + 6.0	1280	12.3	9.00	5.60	A+	563	1.2 + 1.2 + 2.9
2.0 + 2.0 + 7.1	1250	12.0	9.00	5.60	A+	563	1.0 + 1.0 + 3.2	
2.0 + 2.5 + 2.5	965	9.2	7.00	5.60	A+	438	1.3 + 1.5 + 1.5	
2.0 + 2.5 + 3.5	1165	11.2	8.00	5.60	A+	500	1.3 + 1.5 + 2.0	
2.0 + 2.5 + 4.2	1345	12.9	8.70	5.60	A+	544	1.3 + 1.5 + 2.4	
2.0 + 2.5 + 5.0	1280	12.3	9.00	5.60	A+	563	1.2 + 1.5 + 2.6	
2.0 + 2.5 + 6.0	1280	12.3	9.00	5.60	A+	563	1.1 + 1.4 + 2.8	
2.0 + 2.5 + 7.1	1250	12.0	9.00	5.60	A+	563	1.0 + 1.3 + 3.0	
2.0 + 3.5 + 3.5	1405	13.5	9.00	5.60	A+	563	1.3 + 2.0 + 2.0	
2.0 + 3.5 + 4.2	1405	13.5	9.00	5.60	A+	563	1.2 + 1.8 + 2.3	
2.0 + 3.5 + 5.0	1250	12.0	9.00	5.60	A+	563	1.1 + 1.7 + 2.4	
2.0 + 3.5 + 6.0	1250	12.0	9.00	5.60	A+	563	1.0 + 1.6 + 2.5	
2.0 + 3.5 + 7.1	1215	11.6	9.00	5.60	A+	563	0.9 + 1.5 + 2.8	
2.0 + 4.2 + 4.2	1375	13.2	9.00	5.60	A+	563	1.1 + 2.1 + 2.1	
2.0 + 4.2 + 5.0	1250	12.0	9.00	5.60	A+	563	1.0 + 1.9 + 2.3	
2.0 + 4.2 + 6.0	1250	12.0	9.00	5.60	A+	563	0.9 + 1.7 + 2.5	
2.0 + 4.2 + 7.1	1215	11.6	9.00	5.60	A+	563	0.9 + 1.7 + 2.6	

Indoor unit capacity Cooling	Total	Cooling Capacity (kW)							Input Power (W)		EER	
		Room A	Room B	Room C	Room D	Room E	Total	min ~ max	Rating	min ~ max	WW	CLASS
2.0 + 5.0 + 5.0	12.0	1.50	3.75	3.75			9.00	2.9 ~ 10.7	2310	370 ~ 3090	3.90	A
2.0 + 5.0 + 6.0	13.0	1.38	3.46	4.16			9.00	2.9 ~ 10.7	2310	370 ~ 3090	3.90	A
2.0 + 5.0 + 7.1	14.1	1.28	3.19	4.53			9.00	3.0 ~ 10.7	2320	400 ~ 3020	3.88	A
2.0 + 6.0 + 6.0	14.0	1.28	3.86	3.86			9.00	3.0 ~ 10.7	2310	400 ~ 3090	3.90	A
2.0 + 6.0 + 7.1	15.1	1.19	3.58	4.23			9.00	3.0 ~ 10.7	2320	400 ~ 3020	3.88	A
2.0 + 7.1 + 7.1	16.2	1.12	3.94	3.94			9.00	3.0 ~ 10.7	2260	410 ~ 2960	3.98	A
2.5 + 2.5 + 2.5	7.5	2.50	2.50	2.50			7.50	2.9 ~ 8.5	2160	310 ~ 2700	3.47	A
2.5 + 2.5 + 3.5	8.5	2.50	2.50	3.50			8.50	2.9 ~ 9.6	2640	340 ~ 3150	3.22	A
2.5 + 2.5 + 4.2	9.2	2.45	2.45	4.10			9.00	2.9 ~ 10.1	2880	340 ~ 3550	3.13	B
2.5 + 2.5 + 5.0	10.0	2.25	2.25	4.50			9.00	2.9 ~ 10.7	2560	340 ~ 3560	3.52	A
2.5 + 2.5 + 6.0	11.0	2.05	2.05	4.90			9.00	2.9 ~ 10.7	2560	340 ~ 3560	3.52	A
2.5 + 2.5 + 7.1	12.1	1.86	1.86	5.28			9.00	2.9 ~ 10.7	2500	340 ~ 3420	3.60	A
2.5 + 3.5 + 3.5	9.5	2.36	3.32	3.32			9.00	2.9 ~ 10.1	2810	340 ~ 3480	3.20	A
2.5 + 3.5 + 4.2	10.2	2.20	3.09	3.71			9.00	2.9 ~ 10.7	2810	340 ~ 4060	3.20	A
2.5 + 3.5 + 5.0	11.0	2.05	2.86	4.09			9.00	2.9 ~ 10.7	2500	340 ~ 3490	3.60	A
2.5 + 3.5 + 6.0	12.0	1.87	2.63	4.50			9.00	2.9 ~ 10.7	2500	340 ~ 3490	3.60	A
2.5 + 3.5 + 7.1	13.1	1.72	2.40	4.88			9.00	2.9 ~ 10.7	2430	370 ~ 3350	3.70	A
2.5 + 4.2 + 4.2	10.9	2.06	3.47	3.47			9.00	2.9 ~ 10.7	2750	340 ~ 4060	3.27	A
2.5 + 4.2 + 5.0	11.7	1.92	3.23	3.85			9.00	2.9 ~ 10.7	2500	340 ~ 3420	3.60	A
2.5 + 4.2 + 6.0	12.7	1.77	2.98	4.25			9.00	2.9 ~ 10.7	2500	340 ~ 3420	3.60	A
2.5 + 4.2 + 7.1	13.8	1.63	2.74	4.63			9.00	3.0 ~ 10.7	2430	370 ~ 3350	3.70	A
2.5 + 5.0 + 5.0	12.5	1.80	3.60	3.60			9.00	2.9 ~ 10.7	2310	370 ~ 3090	3.90	A
2.5 + 5.0 + 6.0	13.5	1.67	3.33	4.00			9.00	3.0 ~ 10.7	2310	400 ~ 3090	3.90	A
2.5 + 5.0 + 7.1	14.6	1.54	3.08	4.38			9.00	3.0 ~ 10.7	2320	400 ~ 3020	3.88	A
2.5 + 6.0 + 6.0	14.5	1.56	3.72	3.72			9.00	3.0 ~ 10.7	2310	400 ~ 3090	3.90	A
2.5 + 6.0 + 7.1	15.6	1.44	3.46	4.10			9.00	3.0 ~ 10.7	2320	400 ~ 3020	3.88	A
2.5 + 7.1 + 7.1	16.7	1.34	3.83	3.83			9.00	3.0 ~ 10.7	2260	410 ~ 2960	3.98	A
3.5 + 3.5 + 3.5	10.5	3.00	3.00	3.00			9.00	2.9 ~ 10.7	2750	340 ~ 3980	3.27	A
3.5 + 3.5 + 4.2	11.2	2.81	2.81	3.38			9.00	2.9 ~ 10.7	2750	340 ~ 3910	3.27	A
3.5 + 3.5 + 5.0	12.0	2.63	2.63	3.74			9.00	2.9 ~ 10.7	2500	340 ~ 3350	3.60	A
3.5 + 3.5 + 6.0	13.0	2.42	2.42	4.16			9.00	2.9 ~ 10.7	2500	340 ~ 3350	3.60	A
3.5 + 3.5 + 7.1	14.1	2.23	2.23	4.54			9.00	3.0 ~ 10.7	2430	370 ~ 3290	3.70	A
3.5 + 4.2 + 4.2	11.9	2.64	3.18	3.18			9.00	2.9 ~ 10.7	2680	340 ~ 3910	3.36	A
3.5 + 4.2 + 5.0	12.7	2.48	2.98	3.54			9.00	2.9 ~ 10.7	2430	370 ~ 3350	3.70	A
3.5 + 4.2 + 6.0	13.7	2.30	2.76	3.94			9.00	3.0 ~ 10.7	2430	370 ~ 3350	3.70	A
3.5 + 4.2 + 7.1	14.8	2.13	2.55	4.32			9.00	3.0 ~ 10.7	2430	370 ~ 3290	3.70	A
3.5 + 5.0 + 5.0	13.5	2.34	3.33	3.33			9.00	3.0 ~ 10.7	2320	400 ~ 3020	3.88	A
3.5 + 5.0 + 6.0	14.5	2.17	3.10	3.73			9.00	3.0 ~ 10.7	2320	400 ~ 3020	3.88	A
3.5 + 5.0 + 7.1	15.6	2.02	2.88	4.10			9.00	3.0 ~ 10.7	2260	400 ~ 2960	3.98	A
3.5 + 6.0 + 6.0	15.5	2.04	3.48	3.48			9.00	3.0 ~ 10.7	2320	400 ~ 3020	3.88	A
3.5 + 6.0 + 7.1	16.6	1.90	3.25	3.85			9.00	3.0 ~ 10.7	2260	400 ~ 2960	3.98	A
3.5 + 7.1 + 7.1	17.7	1.78	3.61	3.61			9.00	3.0 ~ 10.7	2260	430 ~ 2960	3.98	A
4.2 + 4.2 + 4.2	12.6	3.00	3.00	3.00			9.00	2.9 ~ 10.7	2680	340 ~ 3840	3.36	A
4.2 + 4.2 + 5.0	13.4	2.82	2.82	3.36			9.00	2.9 ~ 10.7	2430	370 ~ 3350	3.70	A
4.2 + 4.2 + 6.0	14.4	2.63	2.63	3.74			9.00	3.0 ~ 10.7	2430	370 ~ 3350	3.70	A
4.2 + 4.2 + 7.1	15.5	2.44	2.44	4.12			9.00	3.0 ~ 10.7	2430	370 ~ 3220	3.70	A
4.2 + 5.0 + 5.0	14.2	2.66	3.17	3.17			9.00	3.0 ~ 10.7	2320	400 ~ 3020	3.88	A
4.2 + 5.0 + 6.0	15.2	2.49	2.96	3.55			9.00	3.0 ~ 10.7	2320	400 ~ 3020	3.88	A
4.2 + 5.0 + 7.1	16.3	2.32	2.76	3.92			9.00	3.0 ~ 10.7	2260	410 ~ 2960	3.98	A
4.2 + 6.0 + 6.0	16.2	2.34	3.33	3.33			9.00	3.0 ~ 10.7	2320	400 ~ 3020	3.88	A
4.2 + 6.0 + 7.1	17.3	2.18	3.12	3.70			9.00	3.0 ~ 10.7	2260	410 ~ 2960	3.98	A
5.0 + 5.0 + 5.0	15.0	3.00	3.00	3.00			9.00	3.0 ~ 10.7	2210	440 ~ 2830	4.07	A
5.0 + 5.0 + 6.0	16.0	2.81	2.81	3.38			9.00	3.0 ~ 10.7	2210	440 ~ 2830	4.07	A
5.0 + 5.0 + 7.1	17.1	2.63	2.63	3.74			9.00	3.0 ~ 10.7	2210	470 ~ 2840	4.07	A
5.0 + 6.0 + 6.0	17.0	2.64	3.18	3.18			9.00	3.0 ~ 10.7	2210	440 ~ 2830	4.07	A
5.0 + 6.0 + 7.1	18.1	2.49	2.98	3.53			9.00	3.0 ~ 10.7	2210	470 ~ 2840	4.07	A
6.0 + 6.0 + 6.0	18.0	3.00	3.00	3.00			9.00	3.0 ~ 10.7	2210	440 ~ 2830	4.07	A

3  
Room



	Indoor unit capacity Cooling	Annual Energy Consumption (kWh)	Current 230V (A)	ERP				Moisture Removal Volume l/h
				Pdesign (kW)	SEER		Annual Consumption (kWh)	
					WW	CLASS		
3 Room	2.0 + 5.0 + 5.0	1155	11.1	9.00	5.60	A+	563	1.0 + 2.2 + 2.2
	2.0 + 5.0 + 6.0	1155	11.1	9.00	5.60	A+	563	0.9 + 2.0 + 2.4
	2.0 + 5.0 + 7.1	1160	11.1	9.00	5.60	A+	563	0.8 + 1.8 + 2.5
	2.0 + 6.0 + 6.0	1155	11.1	9.00	5.60	A+	563	0.8 + 2.3 + 2.3
	2.0 + 6.0 + 7.1	1160	11.1	9.00	5.60	A+	563	0.7 + 2.1 + 2.4
	2.0 + 7.1 + 7.1	1130	10.8	9.00	5.60	A+	563	0.7 + 2.3 + 2.3
	2.5 + 2.5 + 2.5	1080	10.3	7.50	5.60	A+	469	1.5 + 1.5 + 1.5
	2.5 + 2.5 + 3.5	1320	12.6	8.50	5.60	A+	531	1.5 + 1.5 + 2.0
	2.5 + 2.5 + 4.2	1440	13.8	9.00	5.60	A+	563	1.5 + 1.5 + 2.3
	2.5 + 2.5 + 5.0	1280	12.3	9.00	5.60	A+	563	1.5 + 1.5 + 2.5
	2.5 + 2.5 + 6.0	1280	12.3	9.00	5.60	A+	563	1.3 + 1.3 + 2.7
	2.5 + 2.5 + 7.1	1250	12.0	9.00	5.60	A+	563	1.2 + 1.2 + 2.9
	2.5 + 3.5 + 3.5	1405	13.5	9.00	5.60	A+	563	1.5 + 1.9 + 1.9
	2.5 + 3.5 + 4.2	1405	13.5	9.00	5.60	A+	563	1.4 + 1.7 + 2.2
	2.5 + 3.5 + 5.0	1250	12.0	9.00	5.60	A+	563	1.3 + 1.7 + 2.3
	2.5 + 3.5 + 6.0	1250	12.0	9.00	5.60	A+	563	1.2 + 1.6 + 2.5
	2.5 + 3.5 + 7.1	1215	11.6	9.00	5.60	A+	563	1.1 + 1.5 + 2.7
	2.5 + 4.2 + 4.2	1375	13.2	9.00	5.60	A+	563	1.3 + 2.0 + 2.0
	2.5 + 4.2 + 5.0	1250	12.0	9.00	5.60	A+	563	1.2 + 1.8 + 2.3
	2.5 + 4.2 + 6.0	1250	12.0	9.00	5.60	A+	563	1.1 + 1.7 + 2.4
	2.5 + 4.2 + 7.1	1215	11.6	9.00	5.60	A+	563	1.0 + 1.6 + 2.5
	2.5 + 5.0 + 5.0	1155	11.1	9.00	5.60	A+	563	1.2 + 2.1 + 2.1
	2.5 + 5.0 + 6.0	1155	11.1	9.00	5.60	A+	563	1.1 + 1.9 + 2.3
	2.5 + 5.0 + 7.1	1160	11.1	9.00	5.60	A+	563	1.0 + 1.7 + 2.4
	2.5 + 6.0 + 6.0	1155	11.1	9.00	5.60	A+	563	1.0 + 2.2 + 2.2
	2.5 + 6.0 + 7.1	1160	11.1	9.00	5.60	A+	563	0.9 + 2.0 + 2.3
	2.5 + 7.1 + 7.1	1130	10.8	9.00	5.60	A+	563	0.8 + 2.2 + 2.2
	3.5 + 3.5 + 3.5	1375	13.2	9.00	5.60	A+	563	1.7 + 1.7 + 1.7
	3.5 + 3.5 + 4.2	1375	13.2	9.00	5.60	A+	563	1.6 + 1.6 + 1.9
	3.5 + 3.5 + 5.0	1250	12.0	9.00	5.60	A+	563	1.6 + 1.6 + 2.2
	3.5 + 3.5 + 6.0	1250	12.0	9.00	5.60	A+	563	1.5 + 1.5 + 2.4
	3.5 + 3.5 + 7.1	1215	11.6	9.00	5.60	A+	563	1.5 + 1.5 + 2.5
	3.5 + 4.2 + 4.2	1340	12.8	9.00	5.60	A+	563	1.6 + 1.8 + 1.8
	3.5 + 4.2 + 5.0	1215	11.6	9.00	5.60	A+	563	1.5 + 1.7 + 2.0
	3.5 + 4.2 + 6.0	1215	11.6	9.00	5.60	A+	563	1.5 + 1.6 + 2.3
	3.5 + 4.2 + 7.1	1215	11.6	9.00	5.60	A+	563	1.4 + 1.6 + 2.4
	3.5 + 5.0 + 5.0	1160	11.1	9.00	5.60	A+	563	1.5 + 1.9 + 1.9
	3.5 + 5.0 + 6.0	1160	11.1	9.00	5.60	A+	563	1.4 + 1.7 + 2.2
	3.5 + 5.0 + 7.1	1130	10.8	9.00	5.60	A+	563	1.3 + 1.7 + 2.3
	3.5 + 6.0 + 6.0	1160	11.1	9.00	5.60	A+	563	1.3 + 2.0 + 2.0
	3.5 + 6.0 + 7.1	1130	10.8	9.00	5.60	A+	563	1.2 + 1.8 + 2.3
	3.5 + 7.1 + 7.1	1130	10.8	9.00	5.60	A+	563	1.1 + 2.1 + 2.1
	4.2 + 4.2 + 4.2	1340	12.8	9.00	5.60	A+	563	1.7 + 1.7 + 1.7
	4.2 + 4.2 + 5.0	1215	11.6	9.00	5.60	A+	563	1.7 + 1.7 + 1.9
	4.2 + 4.2 + 6.0	1215	11.6	9.00	5.60	A+	563	1.6 + 1.6 + 2.2
4.2 + 4.2 + 7.1	1215	11.6	9.00	5.60	A+	563	1.5 + 1.5 + 2.3	
4.2 + 5.0 + 5.0	1160	11.1	9.00	5.60	A+	563	1.6 + 1.8 + 1.8	
4.2 + 5.0 + 6.0	1160	11.1	9.00	5.60	A+	563	1.5 + 1.7 + 2.1	
4.2 + 5.0 + 7.1	1130	10.8	9.00	5.60	A+	563	1.5 + 1.6 + 2.3	
4.2 + 6.0 + 6.0	1160	11.1	9.00	5.60	A+	563	1.5 + 1.9 + 1.9	
4.2 + 6.0 + 7.1	1130	10.8	9.00	5.60	A+	563	1.4 + 1.8 + 2.2	
5.0 + 5.0 + 5.0	1105	10.6	9.00	5.60	A+	563	1.7 + 1.7 + 1.7	
5.0 + 5.0 + 6.0	1105	10.6	9.00	5.60	A+	563	1.6 + 1.6 + 1.9	
5.0 + 5.0 + 7.1	1105	10.6	9.00	5.60	A+	563	1.6 + 1.6 + 2.2	
5.0 + 6.0 + 6.0	1105	10.6	9.00	5.60	A+	563	1.6 + 1.8 + 1.8	
5.0 + 6.0 + 7.1	1105	10.6	9.00	5.60	A+	563	1.5 + 1.7 + 2.0	
6.0 + 6.0 + 6.0	1105	10.6	9.00	5.60	A+	563	1.7 + 1.7 + 1.7	

	Indoor unit capacity Cooling	Total	Cooling Capacity (kW)							Input Power (W)		EER	
			Room A	Room B	Room C	Room D	Room E	Total	min ~ max	Rating	min ~ max	WW	CLASS
4 Room	1.6 + 1.6 + 1.6 + 1.6	6.4	1.60	1.60	1.60	1.60		6.40	2.9 ~ 10.6	1600	370 ~ 3680	4.00	A
	1.6 + 1.6 + 1.6 + 2.0	6.8	1.60	1.60	1.60	2.00		6.80	2.9 ~ 10.6	1740	370 ~ 3680	3.91	A
	1.6 + 1.6 + 1.6 + 2.5	7.3	1.60	1.60	1.60	2.50		7.30	2.9 ~ 10.6	1900	370 ~ 3680	3.84	A
	1.6 + 1.6 + 1.6 + 3.5	8.3	1.60	1.60	1.60	3.50		8.30	2.9 ~ 10.6	2290	370 ~ 3600	3.62	A
	1.6 + 1.6 + 1.6 + 4.2	9.0	1.60	1.60	1.60	4.20		9.00	2.9 ~ 10.6	2580	370 ~ 3600	3.49	A
	1.6 + 1.6 + 1.6 + 5.0	9.8	1.47	1.47	1.47	4.59		9.00	2.9 ~ 10.6	2450	410 ~ 3310	3.67	A
	1.6 + 1.6 + 1.6 + 6.0	10.8	1.33	1.33	1.33	5.01		9.00	2.9 ~ 10.6	2450	410 ~ 3310	3.67	A
	1.6 + 1.6 + 1.6 + 7.1	11.9	1.21	1.21	1.21	5.37		9.00	2.9 ~ 10.6	2460	410 ~ 3240	3.66	A
	1.6 + 1.6 + 2.0 + 2.0	7.2	1.60	1.60	2.00	2.00		7.20	2.9 ~ 10.6	1850	370 ~ 3600	3.89	A
	1.6 + 1.6 + 2.0 + 2.5	7.7	1.60	1.60	2.00	2.50		7.70	2.9 ~ 10.6	2050	370 ~ 3600	3.76	A
	1.6 + 1.6 + 2.0 + 3.5	8.7	1.60	1.60	2.00	3.50		8.70	2.9 ~ 10.6	2450	370 ~ 3530	3.55	A
	1.6 + 1.6 + 2.0 + 4.2	9.4	1.53	1.53	1.91	4.03		9.00	2.9 ~ 10.6	2580	370 ~ 3530	3.49	A
	1.6 + 1.6 + 2.0 + 5.0	10.2	1.41	1.41	1.76	4.42		9.00	2.9 ~ 10.6	2450	410 ~ 3310	3.67	A
	1.6 + 1.6 + 2.0 + 6.0	11.2	1.29	1.29	1.60	4.82		9.00	2.9 ~ 10.6	2450	410 ~ 3310	3.67	A
	1.6 + 1.6 + 2.0 + 7.1	12.3	1.17	1.17	1.46	5.20		9.00	2.9 ~ 10.8	2460	410 ~ 3380	3.66	A
	1.6 + 1.6 + 2.5 + 2.5	8.2	1.60	1.60	2.50	2.50		8.20	2.9 ~ 10.6	2230	370 ~ 3600	3.68	A
	1.6 + 1.6 + 2.5 + 3.5	9.2	1.57	1.57	2.44	3.42		9.00	2.9 ~ 10.6	2580	370 ~ 3530	3.49	A
	1.6 + 1.6 + 2.5 + 4.2	9.9	1.45	1.45	2.27	3.83		9.00	2.9 ~ 10.6	2580	370 ~ 3530	3.49	A
	1.6 + 1.6 + 2.5 + 5.0	10.7	1.35	1.35	2.09	4.21		9.00	2.9 ~ 10.6	2450	410 ~ 3310	3.67	A
	1.6 + 1.6 + 2.5 + 6.0	11.7	1.23	1.23	1.92	4.62		9.00	2.9 ~ 10.6	2450	410 ~ 3310	3.67	A
	1.6 + 1.6 + 2.5 + 7.1	12.8	1.13	1.13	1.75	4.99		9.00	2.9 ~ 10.8	2460	410 ~ 3380	3.66	A
	1.6 + 1.6 + 3.5 + 3.5	10.2	1.41	1.41	3.09	3.09		9.00	2.9 ~ 10.6	2580	370 ~ 3530	3.49	A
	1.6 + 1.6 + 3.5 + 4.2	10.9	1.32	1.32	2.89	3.47		9.00	2.9 ~ 10.6	2510	370 ~ 3450	3.59	A
	1.6 + 1.6 + 3.5 + 5.0	11.7	1.23	1.23	2.69	3.85		9.00	2.9 ~ 10.6	2460	410 ~ 3240	3.66	A
	1.6 + 1.6 + 3.5 + 6.0	12.7	1.13	1.13	2.48	4.26		9.00	2.9 ~ 10.8	2460	410 ~ 3380	3.66	A
	1.6 + 1.6 + 3.5 + 7.1	13.8	1.04	1.04	2.28	4.64		9.00	2.9 ~ 10.8	2400	440 ~ 3310	3.75	A
	1.6 + 1.6 + 4.2 + 4.2	11.6	1.24	1.24	3.26	3.26		9.00	2.9 ~ 10.6	2510	370 ~ 3450	3.59	A
	1.6 + 1.6 + 4.2 + 5.0	12.4	1.16	1.16	3.05	3.63		9.00	2.9 ~ 10.8	2460	410 ~ 3380	3.66	A
	1.6 + 1.6 + 4.2 + 6.0	13.4	1.07	1.07	2.82	4.04		9.00	2.9 ~ 10.8	2460	410 ~ 3380	3.66	A
	1.6 + 1.6 + 4.2 + 7.1	14.5	0.99	0.99	2.61	4.41		9.00	3.0 ~ 11.0	2400	440 ~ 3460	3.75	A
	1.6 + 1.6 + 5.0 + 5.0	13.2	1.09	1.09	3.41	3.41		9.00	2.9 ~ 10.8	2410	480 ~ 3180	3.73	A
	1.6 + 1.6 + 5.0 + 6.0	14.2	1.01	1.01	3.17	3.81		9.00	3.0 ~ 11.0	2410	480 ~ 3320	3.73	A
	1.6 + 1.6 + 5.0 + 7.1	15.3	0.94	0.94	2.94	4.18		9.00	3.0 ~ 11.0	2410	520 ~ 3320	3.73	A
	1.6 + 1.6 + 6.0 + 6.0	15.2	0.95	0.95	3.55	3.55		9.00	3.0 ~ 11.0	2410	480 ~ 3320	3.73	A
	1.6 + 1.6 + 6.0 + 7.1	16.3	0.88	0.88	3.31	3.93		9.00	3.0 ~ 11.2	2410	520 ~ 3400	3.73	A
	1.6 + 1.6 + 7.1 + 7.1	17.4	0.83	0.83	3.67	3.67		9.00	3.0 ~ 11.2	2350	520 ~ 3400	3.83	A
	1.6 + 2.0 + 2.0 + 2.0	7.6	1.60	2.00	2.00	2.00		7.60	2.9 ~ 10.6	2020	370 ~ 3600	3.76	A
	1.6 + 2.0 + 2.0 + 2.5	8.1	1.60	2.00	2.00	2.50		8.10	2.9 ~ 10.6	2170	370 ~ 3600	3.73	A
	1.6 + 2.0 + 2.0 + 3.5	9.1	1.58	1.98	1.98	3.46		9.00	2.9 ~ 10.6	2580	370 ~ 3530	3.49	A
	1.6 + 2.0 + 2.0 + 4.2	9.8	1.46	1.84	1.84	3.86		9.00	2.9 ~ 10.6	2580	370 ~ 3530	3.49	A
	1.6 + 2.0 + 2.0 + 5.0	10.6	1.35	1.70	1.70	4.25		9.00	2.9 ~ 10.6	2450	410 ~ 3240	3.67	A
	1.6 + 2.0 + 2.0 + 6.0	11.6	1.24	1.55	1.55	4.66		9.00	2.9 ~ 10.6	2450	410 ~ 3240	3.67	A
1.6 + 2.0 + 2.0 + 7.1	12.7	1.13	1.42	1.42	5.03		9.00	2.9 ~ 10.8	2460	440 ~ 3310	3.66	A	
1.6 + 2.0 + 2.5 + 2.5	8.6	1.60	2.00	2.50	2.50		8.60	2.9 ~ 10.6	2410	370 ~ 3600	3.57	A	
1.6 + 2.0 + 2.5 + 3.5	9.6	1.50	1.88	2.34	3.28		9.00	2.9 ~ 10.6	2580	370 ~ 3530	3.49	A	
1.6 + 2.0 + 2.5 + 4.2	10.3	1.40	1.75	2.18	3.67		9.00	2.9 ~ 10.6	2580	370 ~ 3530	3.49	A	
1.6 + 2.0 + 2.5 + 5.0	11.1	1.30	1.62	2.03	4.05		9.00	2.9 ~ 10.6	2450	410 ~ 3240	3.67	A	
1.6 + 2.0 + 2.5 + 6.0	12.1	1.19	1.49	1.86	4.46		9.00	2.9 ~ 10.8	2450	410 ~ 3380	3.67	A	
1.6 + 2.0 + 2.5 + 7.1	13.2	1.09	1.36	1.70	4.85		9.00	2.9 ~ 10.8	2460	440 ~ 3310	3.66	A	
1.6 + 2.0 + 3.5 + 3.5	10.6	1.36	1.70	2.97	2.97		9.00	2.9 ~ 10.6	2510	370 ~ 3450	3.59	A	
1.6 + 2.0 + 3.5 + 4.2	11.3	1.27	1.59	2.79	3.35		9.00	2.9 ~ 10.6	2510	370 ~ 3450	3.59	A	
1.6 + 2.0 + 3.5 + 5.0	12.1	1.19	1.49	2.60	3.72		9.00	2.9 ~ 10.8	2460	410 ~ 3380	3.66	A	
1.6 + 2.0 + 3.5 + 6.0	13.1	1.10	1.37	2.40	4.13		9.00	2.9 ~ 10.8	2460	410 ~ 3380	3.66	A	
1.6 + 2.0 + 3.5 + 7.1	14.2	1.01	1.27	2.22	4.50		9.00	3.0 ~ 11.0	2400	440 ~ 3460	3.75	A	
1.6 + 2.0 + 4.2 + 4.2	12.0	1.20	1.50	3.15	3.15		9.00	2.9 ~ 10.6	2510	370 ~ 3450	3.59	A	
1.6 + 2.0 + 4.2 + 5.0	12.8	1.12	1.41	2.95	3.52		9.00	2.9 ~ 10.8	2460	440 ~ 3310	3.66	A	
1.6 + 2.0 + 4.2 + 6.0	13.8	1.04	1.30	2.74	3.92		9.00	2.9 ~ 10.8	2460	440 ~ 3310	3.66	A	
1.6 + 2.0 + 4.2 + 7.1	14.9	0.96	1.21	2.54	4.29		9.00	3.0 ~ 11.0	2400	440 ~ 3390	3.75	A	

	Indoor unit capacity Cooling	Annual Energy Consumption (kWh)	Current 230V (A)	ERP				Moisture Removal Volume l/h
				Pdesign (kW)	SEER		Annual Consumption (kWh)	
					WW	CLASS		
4 Room	1.6 + 1.6 + 1.6 + 1.6	800	7.7	6.40	6.00	A+	373	1.0 + 1.0 + 1.0 + 1.0
	1.6 + 1.6 + 1.6 + 2.0	870	8.4	6.80	6.00	A+	397	1.0 + 1.0 + 1.0 + 1.3
	1.6 + 1.6 + 1.6 + 2.5	950	9.1	7.30	6.00	A+	426	1.0 + 1.0 + 1.0 + 1.5
	1.6 + 1.6 + 1.6 + 3.5	1145	11.0	8.30	6.00	A+	484	1.0 + 1.0 + 1.0 + 2.0
	1.6 + 1.6 + 1.6 + 4.2	1290	12.4	9.00	6.00	A+	525	1.0 + 1.0 + 1.0 + 2.4
	1.6 + 1.6 + 1.6 + 5.0	1225	11.7	9.00	6.00	A+	525	0.9 + 0.9 + 0.9 + 2.5
	1.6 + 1.6 + 1.6 + 6.0	1225	11.7	9.00	6.00	A+	525	0.8 + 0.8 + 0.8 + 2.7
	1.6 + 1.6 + 1.6 + 7.1	1230	11.8	9.00	6.00	A+	525	0.8 + 0.8 + 0.8 + 2.9
	1.6 + 1.6 + 2.0 + 2.0	925	8.9	7.20	6.00	A+	420	1.0 + 1.0 + 1.3 + 1.3
	1.6 + 1.6 + 2.0 + 2.5	1025	9.8	7.70	6.00	A+	449	1.0 + 1.0 + 1.3 + 1.5
	1.6 + 1.6 + 2.0 + 3.5	1225	11.7	8.70	6.00	A+	508	1.0 + 1.0 + 1.3 + 2.0
	1.6 + 1.6 + 2.0 + 4.2	1290	12.4	9.00	6.00	A+	525	1.0 + 1.0 + 1.2 + 2.3
	1.6 + 1.6 + 2.0 + 5.0	1225	11.7	9.00	6.00	A+	525	0.9 + 0.9 + 1.1 + 2.4
	1.6 + 1.6 + 2.0 + 6.0	1225	11.7	9.00	6.00	A+	525	0.8 + 0.8 + 1.0 + 2.6
	1.6 + 1.6 + 2.0 + 7.1	1230	11.8	9.00	6.00	A+	525	0.7 + 0.7 + 0.9 + 2.9
	1.6 + 1.6 + 2.5 + 2.5	1115	10.7	8.20	6.00	A+	478	1.0 + 1.0 + 1.5 + 1.5
	1.6 + 1.6 + 2.5 + 3.5	1290	12.4	9.00	6.00	A+	525	1.0 + 1.0 + 1.5 + 2.0
	1.6 + 1.6 + 2.5 + 4.2	1290	12.4	9.00	6.00	A+	525	0.9 + 0.9 + 1.5 + 2.2
	1.6 + 1.6 + 2.5 + 5.0	1225	11.7	9.00	6.00	A+	525	0.9 + 0.9 + 1.4 + 2.4
	1.6 + 1.6 + 2.5 + 6.0	1225	11.7	9.00	6.00	A+	525	0.8 + 0.8 + 1.2 + 2.5
	1.6 + 1.6 + 2.5 + 7.1	1230	11.8	9.00	6.00	A+	525	0.7 + 0.7 + 1.1 + 2.7
	1.6 + 1.6 + 3.5 + 3.5	1290	12.4	9.00	6.00	A+	525	0.9 + 0.9 + 1.7 + 1.7
	1.6 + 1.6 + 3.5 + 4.2	1255	12.0	9.00	6.00	A+	525	0.8 + 0.8 + 1.7 + 2.0
	1.6 + 1.6 + 3.5 + 5.0	1230	11.8	9.00	6.00	A+	525	0.8 + 0.8 + 1.6 + 2.3
	1.6 + 1.6 + 3.5 + 6.0	1230	11.8	9.00	6.00	A+	525	0.7 + 0.7 + 1.5 + 2.4
	1.6 + 1.6 + 3.5 + 7.1	1200	11.5	9.00	6.00	A+	525	0.7 + 0.7 + 1.5 + 2.5
	1.6 + 1.6 + 4.2 + 4.2	1255	12.0	9.00	6.00	A+	525	0.8 + 0.8 + 1.9 + 1.9
	1.6 + 1.6 + 4.2 + 5.0	1230	11.8	9.00	6.00	A+	525	0.7 + 0.7 + 1.7 + 2.1
	1.6 + 1.6 + 4.2 + 6.0	1230	11.8	9.00	6.00	A+	525	0.7 + 0.7 + 1.7 + 2.3
	1.6 + 1.6 + 4.2 + 7.1	1200	11.5	9.00	6.00	A+	525	0.7 + 0.7 + 1.6 + 2.4
	1.6 + 1.6 + 5.0 + 5.0	1205	11.5	9.00	6.00	A+	525	0.7 + 0.7 + 2.0 + 2.0
	1.6 + 1.6 + 5.0 + 6.0	1205	11.5	9.00	6.00	A+	525	0.7 + 0.7 + 1.8 + 2.2
	1.6 + 1.6 + 5.0 + 7.1	1205	11.5	9.00	6.00	A+	525	0.7 + 0.7 + 1.7 + 2.4
	1.6 + 1.6 + 6.0 + 6.0	1205	11.5	9.00	6.00	A+	525	0.7 + 0.7 + 2.1 + 2.1
	1.6 + 1.6 + 6.0 + 7.1	1205	11.5	9.00	6.00	A+	525	0.7 + 0.7 + 1.9 + 2.3
	1.6 + 1.6 + 7.1 + 7.1	1175	11.2	9.00	6.00	A+	525	0.7 + 0.7 + 2.1 + 2.1
	1.6 + 2.0 + 2.0 + 2.0	1010	9.7	7.60	6.00	A+	443	1.0 + 1.3 + 1.3 + 1.3
	1.6 + 2.0 + 2.0 + 2.5	1085	10.4	8.10	6.00	A+	473	1.0 + 1.3 + 1.3 + 1.5
	1.6 + 2.0 + 2.0 + 3.5	1290	12.4	9.00	6.00	A+	525	1.0 + 1.3 + 1.3 + 2.0
	1.6 + 2.0 + 2.0 + 4.2	1290	12.4	9.00	6.00	A+	525	0.9 + 1.2 + 1.2 + 2.3
1.6 + 2.0 + 2.0 + 5.0	1225	11.7	9.00	6.00	A+	525	0.9 + 1.1 + 1.1 + 2.4	
1.6 + 2.0 + 2.0 + 6.0	1225	11.7	9.00	6.00	A+	525	0.8 + 1.0 + 1.0 + 2.5	
1.6 + 2.0 + 2.0 + 7.1	1230	11.8	9.00	6.00	A+	525	0.7 + 0.9 + 0.9 + 2.8	
1.6 + 2.0 + 2.5 + 2.5	1205	11.5	8.60	6.00	A+	502	1.0 + 1.3 + 1.5 + 1.5	
1.6 + 2.0 + 2.5 + 3.5	1290	12.4	9.00	6.00	A+	525	1.0 + 1.2 + 1.5 + 1.9	
1.6 + 2.0 + 2.5 + 4.2	1290	12.4	9.00	6.00	A+	525	0.9 + 1.1 + 1.4 + 2.1	
1.6 + 2.0 + 2.5 + 5.0	1225	11.7	9.00	6.00	A+	525	0.8 + 1.0 + 1.3 + 2.3	
1.6 + 2.0 + 2.5 + 6.0	1225	11.7	9.00	6.00	A+	525	0.7 + 0.9 + 1.2 + 2.5	
1.6 + 2.0 + 2.5 + 7.1	1230	11.8	9.00	6.00	A+	525	0.7 + 0.9 + 1.1 + 2.6	
1.6 + 2.0 + 3.5 + 3.5	1255	12.0	9.00	6.00	A+	525	0.9 + 1.1 + 1.7 + 1.7	
1.6 + 2.0 + 3.5 + 4.2	1255	12.0	9.00	6.00	A+	525	0.8 + 1.0 + 1.6 + 1.9	
1.6 + 2.0 + 3.5 + 5.0	1230	11.8	9.00	6.00	A+	525	0.7 + 0.9 + 1.6 + 2.2	
1.6 + 2.0 + 3.5 + 6.0	1230	11.8	9.00	6.00	A+	525	0.7 + 0.9 + 1.5 + 2.3	
1.6 + 2.0 + 3.5 + 7.1	1200	11.5	9.00	6.00	A+	525	0.7 + 0.8 + 1.4 + 2.5	
1.6 + 2.0 + 4.2 + 4.2	1255	12.0	9.00	6.00	A+	525	0.7 + 1.0 + 1.8 + 1.8	
1.6 + 2.0 + 4.2 + 5.0	1230	11.8	9.00	6.00	A+	525	0.7 + 0.9 + 1.7 + 2.0	
1.6 + 2.0 + 4.2 + 6.0	1230	11.8	9.00	6.00	A+	525	0.7 + 0.8 + 1.6 + 2.3	
1.6 + 2.0 + 4.2 + 7.1	1200	11.5	9.00	6.00	A+	525	0.7 + 0.8 + 1.6 + 2.4	

Indoor unit capacity Cooling	Total	Cooling Capacity (kW)						Input Power (W)			EER	
		Room A	Room B	Room C	Room D	Room E	Total	min ~ max	Rating	min ~ max	WW	CLASS
1.6 + 2.0 + 5.0 + 5.0	13.6	1.06	1.32	3.31	3.31		9.00	2.9 ~ 10.8	2410	490 ~ 3180	3.73	A
1.6 + 2.0 + 5.0 + 6.0	14.6	0.99	1.23	3.08	3.70		9.00	3.0 ~ 11.0	2410	490 ~ 3320	3.73	A
1.6 + 2.0 + 5.0 + 7.1	15.7	0.91	1.15	2.87	4.07		9.00	3.0 ~ 11.0	2410	520 ~ 3250	3.73	A
1.6 + 2.0 + 6.0 + 6.0	15.6	0.92	1.16	3.46	3.46		9.00	3.0 ~ 11.0	2410	490 ~ 3320	3.73	A
1.6 + 2.0 + 6.0 + 7.1	16.7	0.86	1.08	3.23	3.83		9.00	3.0 ~ 11.2	2410	520 ~ 3400	3.73	A
1.6 + 2.0 + 7.1 + 7.1	17.8	0.81	1.01	3.59	3.59		9.00	3.0 ~ 11.2	2360	530 ~ 3400	3.81	A
1.6 + 2.5 + 2.5 + 2.5	9.1	1.59	2.47	2.47	2.47		9.00	2.9 ~ 10.6	2580	370 ~ 3600	3.49	A
1.6 + 2.5 + 2.5 + 3.5	10.1	1.42	2.23	2.23	3.12		9.00	2.9 ~ 10.6	2580	370 ~ 3530	3.49	A
1.6 + 2.5 + 2.5 + 4.2	10.8	1.33	2.08	2.08	3.51		9.00	2.9 ~ 10.6	2580	370 ~ 3530	3.49	A
1.6 + 2.5 + 2.5 + 5.0	11.6	1.24	1.94	1.94	3.88		9.00	2.9 ~ 10.6	2450	410 ~ 3240	3.67	A
1.6 + 2.5 + 2.5 + 6.0	12.6	1.13	1.79	1.79	4.29		9.00	2.9 ~ 10.8	2450	410 ~ 3380	3.67	A
1.6 + 2.5 + 2.5 + 7.1	13.7	1.05	1.64	1.64	4.67		9.00	2.9 ~ 10.8	2460	440 ~ 3310	3.66	A
1.6 + 2.5 + 3.5 + 3.5	11.1	1.29	2.03	2.84	2.84		9.00	2.9 ~ 10.6	2510	370 ~ 3450	3.59	A
1.6 + 2.5 + 3.5 + 4.2	11.8	1.22	1.91	2.67	3.20		9.00	2.9 ~ 10.6	2510	370 ~ 3450	3.59	A
1.6 + 2.5 + 3.5 + 5.0	12.6	1.14	1.79	2.50	3.57		9.00	2.9 ~ 10.8	2460	410 ~ 3380	3.66	A
1.6 + 2.5 + 3.5 + 6.0	13.6	1.06	1.65	2.32	3.97		9.00	2.9 ~ 10.8	2460	410 ~ 3380	3.66	A
1.6 + 2.5 + 3.5 + 7.1	14.7	0.98	1.53	2.14	4.35		9.00	3.0 ~ 11.0	2400	440 ~ 3460	3.75	A
1.6 + 2.5 + 4.2 + 4.2	12.5	1.15	1.81	3.02	3.02		9.00	2.9 ~ 10.8	2510	370 ~ 3600	3.59	A
1.6 + 2.5 + 4.2 + 5.0	13.3	1.08	1.69	2.84	3.39		9.00	2.9 ~ 10.8	2460	440 ~ 3310	3.66	A
1.6 + 2.5 + 4.2 + 6.0	14.3	1.01	1.57	2.64	3.78		9.00	3.0 ~ 11.0	2460	440 ~ 3460	3.66	A
1.6 + 2.5 + 4.2 + 7.1	15.4	0.94	1.46	2.45	4.15		9.00	3.0 ~ 11.0	2400	440 ~ 3390	3.75	A
1.6 + 2.5 + 5.0 + 5.0	14.1	1.02	1.60	3.19	3.19		9.00	2.9 ~ 10.8	2410	490 ~ 3180	3.73	A
1.6 + 2.5 + 5.0 + 6.0	15.1	0.95	1.49	2.98	3.58		9.00	3.0 ~ 11.0	2410	490 ~ 3320	3.73	A
1.6 + 2.5 + 5.0 + 7.1	16.2	0.89	1.39	2.78	3.94		9.00	3.0 ~ 11.2	2410	520 ~ 3400	3.73	A
1.6 + 2.5 + 6.0 + 6.0	16.1	0.89	1.41	3.35	3.35		9.00	3.0 ~ 11.2	2410	490 ~ 3390	3.73	A
1.6 + 2.5 + 6.0 + 7.1	17.2	0.83	1.31	3.14	3.72		9.00	3.0 ~ 11.2	2410	520 ~ 3400	3.73	A
1.6 + 2.5 + 7.1 + 7.1	18.3	0.79	1.23	3.49	3.49		9.00	3.0 ~ 11.2	2360	530 ~ 3400	3.81	A
1.6 + 3.5 + 3.5 + 3.5	12.1	1.20	2.60	2.60	2.60		9.00	2.9 ~ 10.8	2510	380 ~ 3530	3.59	A
1.6 + 3.5 + 3.5 + 4.2	12.8	1.13	2.46	2.46	2.95		9.00	2.9 ~ 10.8	2510	400 ~ 3530	3.59	A
1.6 + 3.5 + 3.5 + 5.0	13.6	1.05	2.32	2.32	3.31		9.00	2.9 ~ 10.8	2400	440 ~ 3310	3.75	A
1.6 + 3.5 + 3.5 + 6.0	14.6	0.98	2.16	2.16	3.70		9.00	3.0 ~ 11.0	2400	440 ~ 3460	3.75	A
1.6 + 3.5 + 3.5 + 7.1	15.7	0.91	2.01	2.01	4.07		9.00	3.0 ~ 11.0	2400	470 ~ 3390	3.75	A
1.6 + 3.5 + 4.2 + 4.2	13.5	1.07	2.33	2.80	2.80		9.00	2.9 ~ 10.8	2510	400 ~ 3530	3.59	A
1.6 + 3.5 + 4.2 + 5.0	14.3	1.01	2.20	2.64	3.15		9.00	3.0 ~ 11.0	2400	440 ~ 3460	3.75	A
1.6 + 3.5 + 4.2 + 6.0	15.3	0.94	2.06	2.47	3.53		9.00	3.0 ~ 11.0	2400	440 ~ 3460	3.75	A
1.6 + 3.5 + 4.2 + 7.1	16.4	0.88	1.92	2.30	3.90		9.00	3.0 ~ 11.2	2400	470 ~ 3530	3.75	A
1.6 + 3.5 + 5.0 + 5.0	15.1	0.95	2.09	2.98	2.98		9.00	3.0 ~ 11.0	2410	520 ~ 3250	3.73	A
1.6 + 3.5 + 5.0 + 6.0	16.1	0.89	1.96	2.80	3.35		9.00	3.0 ~ 11.2	2410	520 ~ 3400	3.73	A
1.6 + 3.5 + 5.0 + 7.1	17.2	0.83	1.83	2.62	3.72		9.00	3.0 ~ 11.2	2350	520 ~ 3400	3.83	A
1.6 + 3.5 + 6.0 + 6.0	17.1	0.84	1.84	3.16	3.16		9.00	3.0 ~ 11.2	2410	520 ~ 3400	3.73	A
1.6 + 3.5 + 6.0 + 7.1	18.2	0.79	1.73	2.97	3.51		9.00	3.0 ~ 11.2	2350	520 ~ 3400	3.83	A
1.6 + 4.2 + 4.2 + 4.2	14.2	1.02	2.66	2.66	2.66		9.00	3.0 ~ 11.0	2510	400 ~ 3680	3.59	A
1.6 + 4.2 + 4.2 + 5.0	15.0	0.96	2.52	2.52	3.00		9.00	3.0 ~ 11.0	2400	440 ~ 3390	3.75	A
1.6 + 4.2 + 4.2 + 6.0	16.0	0.90	2.36	2.36	3.38		9.00	3.0 ~ 11.2	2400	440 ~ 3530	3.75	A
1.6 + 4.2 + 4.2 + 7.1	17.1	0.84	2.21	2.21	3.74		9.00	3.0 ~ 11.2	2400	480 ~ 3540	3.75	A
1.6 + 4.2 + 5.0 + 5.0	15.8	0.91	2.39	2.85	2.85		9.00	3.0 ~ 11.2	2410	520 ~ 3400	3.73	A
1.6 + 4.2 + 5.0 + 6.0	16.8	0.86	2.25	2.68	3.21		9.00	3.0 ~ 11.2	2410	520 ~ 3400	3.73	A
1.6 + 4.2 + 5.0 + 7.1	17.9	0.80	2.11	2.51	3.58		9.00	3.0 ~ 11.2	2360	530 ~ 3400	3.81	A
1.6 + 4.2 + 6.0 + 6.0	17.8	0.81	2.13	3.03	3.03		9.00	3.0 ~ 11.2	2410	520 ~ 3400	3.73	A
1.6 + 5.0 + 5.0 + 5.0	16.6	0.87	2.71	2.71	2.71		9.00	3.0 ~ 11.2	2370	570 ~ 3340	3.80	A
1.6 + 5.0 + 5.0 + 6.0	17.6	0.81	2.56	2.56	3.07		9.00	3.0 ~ 11.2	2370	570 ~ 3340	3.80	A
2.0 + 2.0 + 2.0 + 2.0	8.0	2.00	2.00	2.00	2.00		8.00	2.9 ~ 10.6	2170	370 ~ 3600	3.69	A
2.0 + 2.0 + 2.0 + 2.5	8.5	2.00	2.00	2.00	2.50		8.50	2.9 ~ 10.6	2350	370 ~ 3600	3.62	A
2.0 + 2.0 + 2.0 + 3.5	9.5	1.89	1.89	1.89	3.33		9.00	2.9 ~ 10.6	2580	370 ~ 3530	3.49	A
2.0 + 2.0 + 2.0 + 4.2	10.2	1.76	1.76	1.76	3.72		9.00	2.9 ~ 10.6	2580	370 ~ 3530	3.49	A
2.0 + 2.0 + 2.0 + 5.0	11.0	1.64	1.64	1.64	4.08		9.00	2.9 ~ 10.6	2450	410 ~ 3240	3.67	A
2.0 + 2.0 + 2.0 + 6.0	12.0	1.50	1.50	1.50	4.50		9.00	2.9 ~ 10.6	2450	410 ~ 3240	3.67	A
2.0 + 2.0 + 2.0 + 7.1	13.1	1.37	1.37	1.37	4.89		9.00	2.9 ~ 10.8	2400	440 ~ 3310	3.75	A

4  
Room

	Indoor unit capacity Cooling	Annual Energy Consumption (kWh)	Current 230V (A)	ERP				Moisture Removal Volume l/h
				Pdesign (kW)	SEER		Annual Consumption (kWh)	
					WW	CLASS		
4 Room	1.6 + 2.0 + 5.0 + 5.0	1205	11.5	9.00	6.00	A+	525	0.7 + 0.8 + 1.9 + 1.9
	1.6 + 2.0 + 5.0 + 6.0	1205	11.5	9.00	6.00	A+	525	0.7 + 0.8 + 1.7 + 2.2
	1.6 + 2.0 + 5.0 + 7.1	1205	11.5	9.00	6.00	A+	525	0.7 + 0.7 + 1.7 + 2.3
	1.6 + 2.0 + 6.0 + 6.0	1205	11.5	9.00	6.00	A+	525	0.7 + 0.7 + 2.0 + 2.0
	1.6 + 2.0 + 6.0 + 7.1	1205	11.5	9.00	6.00	A+	525	0.7 + 0.7 + 1.8 + 2.2
	1.6 + 2.0 + 7.1 + 7.1	1180	11.3	9.00	6.00	A+	525	0.7 + 0.7 + 2.1 + 2.1
	1.6 + 2.5 + 2.5 + 2.5	1290	12.4	9.00	6.00	A+	525	1.0 + 1.5 + 1.5 + 1.5
	1.6 + 2.5 + 2.5 + 3.5	1290	12.4	9.00	6.00	A+	525	0.9 + 1.5 + 1.5 + 1.8
	1.6 + 2.5 + 2.5 + 4.2	1290	12.4	9.00	6.00	A+	525	0.8 + 1.3 + 1.3 + 2.0
	1.6 + 2.5 + 2.5 + 5.0	1225	11.7	9.00	6.00	A+	525	0.8 + 1.3 + 1.3 + 2.3
	1.6 + 2.5 + 2.5 + 6.0	1225	11.7	9.00	6.00	A+	525	0.7 + 1.2 + 1.2 + 2.4
	1.6 + 2.5 + 2.5 + 7.1	1230	11.8	9.00	6.00	A+	525	0.7 + 1.0 + 1.0 + 2.5
	1.6 + 2.5 + 3.5 + 3.5	1255	12.0	9.00	6.00	A+	525	0.8 + 1.3 + 1.7 + 1.7
	1.6 + 2.5 + 3.5 + 4.2	1255	12.0	9.00	6.00	A+	525	0.8 + 1.2 + 1.6 + 1.8
	1.6 + 2.5 + 3.5 + 5.0	1230	11.8	9.00	6.00	A+	525	0.7 + 1.2 + 1.5 + 2.1
	1.6 + 2.5 + 3.5 + 6.0	1230	11.8	9.00	6.00	A+	525	0.7 + 1.1 + 1.5 + 2.3
	1.6 + 2.5 + 3.5 + 7.1	1200	11.5	9.00	6.00	A+	525	0.7 + 1.0 + 1.4 + 2.4
	1.6 + 2.5 + 4.2 + 4.2	1255	12.0	9.00	6.00	A+	525	0.7 + 1.2 + 1.7 + 1.7
	1.6 + 2.5 + 4.2 + 5.0	1230	11.8	9.00	6.00	A+	525	0.7 + 1.1 + 1.7 + 1.9
	1.6 + 2.5 + 4.2 + 6.0	1230	11.8	9.00	6.00	A+	525	0.7 + 1.0 + 1.6 + 2.2
	1.6 + 2.5 + 4.2 + 7.1	1200	11.5	9.00	6.00	A+	525	0.7 + 0.9 + 1.5 + 2.4
	1.6 + 2.5 + 5.0 + 5.0	1205	11.5	9.00	6.00	A+	525	0.7 + 1.0 + 1.8 + 1.8
	1.6 + 2.5 + 5.0 + 6.0	1205	11.5	9.00	6.00	A+	525	0.7 + 0.9 + 1.7 + 2.1
	1.6 + 2.5 + 5.0 + 7.1	1205	11.5	9.00	6.00	A+	525	0.7 + 0.9 + 1.6 + 2.3
	1.6 + 2.5 + 6.0 + 6.0	1205	11.5	9.00	6.00	A+	525	0.7 + 0.9 + 1.9 + 1.9
	1.6 + 2.5 + 6.0 + 7.1	1205	11.5	9.00	6.00	A+	525	0.7 + 0.8 + 1.8 + 2.2
	1.6 + 2.5 + 7.1 + 7.1	1180	11.3	9.00	6.00	A+	525	0.7 + 0.8 + 2.0 + 2.0
	1.6 + 3.5 + 3.5 + 3.5	1255	12.0	9.00	6.00	A+	525	0.7 + 1.6 + 1.6 + 1.6
	1.6 + 3.5 + 3.5 + 4.2	1255	12.0	9.00	6.00	A+	525	0.7 + 1.5 + 1.5 + 1.7
	1.6 + 3.5 + 3.5 + 5.0	1200	11.5	9.00	6.00	A+	525	0.7 + 1.5 + 1.5 + 1.9
	1.6 + 3.5 + 3.5 + 6.0	1200	11.5	9.00	6.00	A+	525	0.7 + 1.4 + 1.4 + 2.2
	1.6 + 3.5 + 3.5 + 7.1	1200	11.5	9.00	6.00	A+	525	0.7 + 1.3 + 1.3 + 2.3
	1.6 + 3.5 + 4.2 + 4.2	1255	12.0	9.00	6.00	A+	525	0.7 + 1.5 + 1.6 + 1.6
	1.6 + 3.5 + 4.2 + 5.0	1200	11.5	9.00	6.00	A+	525	0.7 + 1.4 + 1.6 + 1.8
	1.6 + 3.5 + 4.2 + 6.0	1200	11.5	9.00	6.00	A+	525	0.7 + 1.3 + 1.5 + 2.0
	1.6 + 3.5 + 4.2 + 7.1	1200	11.5	9.00	6.00	A+	525	0.7 + 1.2 + 1.5 + 2.3
	1.6 + 3.5 + 5.0 + 5.0	1205	11.5	9.00	6.00	A+	525	0.7 + 1.4 + 1.7 + 1.7
	1.6 + 3.5 + 5.0 + 6.0	1205	11.5	9.00	6.00	A+	525	0.7 + 1.3 + 1.6 + 1.9
	1.6 + 3.5 + 5.0 + 7.1	1175	11.2	9.00	6.00	A+	525	0.7 + 1.2 + 1.6 + 2.2
	1.6 + 3.5 + 6.0 + 6.0	1205	11.5	9.00	6.00	A+	525	0.7 + 1.2 + 1.8 + 1.8
1.6 + 3.5 + 6.0 + 7.1	1175	11.2	9.00	6.00	A+	525	0.7 + 1.1 + 1.7 + 2.0	
1.6 + 4.2 + 4.2 + 4.2	1255	12.0	9.00	6.00	A+	525	0.7 + 1.6 + 1.6 + 1.6	
1.6 + 4.2 + 4.2 + 5.0	1200	11.5	9.00	6.00	A+	525	0.7 + 1.5 + 1.5 + 1.7	
1.6 + 4.2 + 4.2 + 6.0	1200	11.5	9.00	6.00	A+	525	0.7 + 1.5 + 1.5 + 1.9	
1.6 + 4.2 + 4.2 + 7.1	1200	11.5	9.00	6.00	A+	525	0.7 + 1.4 + 1.4 + 2.2	
1.6 + 4.2 + 5.0 + 5.0	1205	11.5	9.00	6.00	A+	525	0.7 + 1.5 + 1.7 + 1.7	
1.6 + 4.2 + 5.0 + 6.0	1205	11.5	9.00	6.00	A+	525	0.7 + 1.5 + 1.6 + 1.8	
1.6 + 4.2 + 5.0 + 7.1	1180	11.3	9.00	6.00	A+	525	0.7 + 1.4 + 1.5 + 2.1	
1.6 + 4.2 + 6.0 + 6.0	1205	11.5	9.00	6.00	A+	525	0.7 + 1.4 + 1.7 + 1.7	
1.6 + 5.0 + 5.0 + 5.0	1185	11.3	9.00	6.00	A+	525	0.7 + 1.6 + 1.6 + 1.6	
1.6 + 5.0 + 5.0 + 6.0	1185	11.3	9.00	6.00	A+	525	0.7 + 1.6 + 1.6 + 1.7	
2.0 + 2.0 + 2.0 + 2.0	1085	10.4	8.00	6.00	A+	467	1.3 + 1.3 + 1.3 + 1.3	
2.0 + 2.0 + 2.0 + 2.5	1175	11.2	8.50	6.00	A+	496	1.3 + 1.3 + 1.3 + 1.5	
2.0 + 2.0 + 2.0 + 3.5	1290	12.4	9.00	6.00	A+	525	1.2 + 1.2 + 1.2 + 1.9	
2.0 + 2.0 + 2.0 + 4.2	1290	12.4	9.00	6.00	A+	525	1.1 + 1.1 + 1.1 + 2.2	
2.0 + 2.0 + 2.0 + 5.0	1225	11.7	9.00	6.00	A+	525	1.0 + 1.0 + 1.0 + 2.3	
2.0 + 2.0 + 2.0 + 6.0	1225	11.7	9.00	6.00	A+	525	1.0 + 1.0 + 1.0 + 2.5	
2.0 + 2.0 + 2.0 + 7.1	1200	11.5	9.00	6.00	A+	525	0.9 + 0.9 + 0.9 + 2.7	

Indoor unit capacity Cooling		Total	Cooling Capacity (kW)							Input Power (W)		EER	
			Room A	Room B	Room C	Room D	Room E	Total	min ~ max	Rating	min ~ max	WW	CLASS
4 Room	2.0 + 2.0 + 2.5 + 2.5	9.0	2.00	2.00	2.50	2.50		9.00	2.9 ~ 10.6	2580	370 ~ 3600	3.49	A
	2.0 + 2.0 + 2.5 + 3.5	10.0	1.80	1.80	2.25	3.15		9.00	2.9 ~ 10.6	2580	370 ~ 3530	3.49	A
	2.0 + 2.0 + 2.5 + 4.2	10.7	1.68	1.68	2.10	3.54		9.00	2.9 ~ 10.6	2580	370 ~ 3530	3.49	A
	2.0 + 2.0 + 2.5 + 5.0	11.5	1.57	1.57	1.95	3.91		9.00	2.9 ~ 10.6	2450	410 ~ 3240	3.67	A
	2.0 + 2.0 + 2.5 + 6.0	12.5	1.44	1.44	1.80	4.32		9.00	2.9 ~ 10.8	2450	410 ~ 3380	3.67	A
	2.0 + 2.0 + 2.5 + 7.1	13.6	1.32	1.32	1.65	4.71		9.00	2.9 ~ 10.8	2400	440 ~ 3310	3.75	A
	2.0 + 2.0 + 3.5 + 3.5	11.0	1.64	1.64	2.86	2.86		9.00	2.9 ~ 10.6	2510	370 ~ 3450	3.59	A
	2.0 + 2.0 + 3.5 + 4.2	11.7	1.54	1.54	2.69	3.23		9.00	2.9 ~ 10.6	2510	370 ~ 3450	3.59	A
	2.0 + 2.0 + 3.5 + 5.0	12.5	1.44	1.44	2.52	3.60		9.00	2.9 ~ 10.8	2460	440 ~ 3310	3.66	A
	2.0 + 2.0 + 3.5 + 6.0	13.5	1.33	1.33	2.33	4.01		9.00	2.9 ~ 10.8	2460	440 ~ 3310	3.66	A
	2.0 + 2.0 + 3.5 + 7.1	14.6	1.23	1.23	2.16	4.38		9.00	3.0 ~ 11.0	2400	440 ~ 3390	3.75	A
	2.0 + 2.0 + 4.2 + 4.2	12.4	1.45	1.45	3.05	3.05		9.00	2.9 ~ 10.8	2510	370 ~ 3600	3.59	A
	2.0 + 2.0 + 4.2 + 5.0	13.2	1.36	1.36	2.86	3.42		9.00	2.9 ~ 10.8	2400	440 ~ 3310	3.75	A
	2.0 + 2.0 + 4.2 + 6.0	14.2	1.27	1.27	2.66	3.80		9.00	3.0 ~ 11.0	2400	440 ~ 3460	3.75	A
	2.0 + 2.0 + 4.2 + 7.1	15.3	1.18	1.18	2.46	4.18		9.00	3.0 ~ 11.0	2400	450 ~ 3390	3.75	A
	2.0 + 2.0 + 5.0 + 5.0	14.0	1.29	1.29	3.21	3.21		9.00	2.9 ~ 10.8	2410	490 ~ 3180	3.73	A
	2.0 + 2.0 + 5.0 + 6.0	15.0	1.20	1.20	3.00	3.60		9.00	3.0 ~ 11.0	2410	490 ~ 3320	3.73	A
	2.0 + 2.0 + 5.0 + 7.1	16.1	1.12	1.12	2.79	3.97		9.00	3.0 ~ 11.2	2350	520 ~ 3400	3.83	A
	2.0 + 2.0 + 6.0 + 6.0	16.0	1.12	1.12	3.38	3.38		9.00	3.0 ~ 11.2	2410	490 ~ 3390	3.73	A
	2.0 + 2.0 + 6.0 + 7.1	17.1	1.05	1.05	3.16	3.74		9.00	3.0 ~ 11.2	2350	520 ~ 3400	3.83	A
	2.0 + 2.0 + 7.1 + 7.1	18.2	0.99	0.99	3.51	3.51		9.00	3.0 ~ 11.2	2360	530 ~ 3330	3.81	A
	2.0 + 2.5 + 2.5 + 2.5	9.5	1.89	2.37	2.37	2.37		9.00	2.9 ~ 10.6	2580	370 ~ 3600	3.49	A
	2.0 + 2.5 + 2.5 + 3.5	10.5	1.71	2.14	2.14	3.01		9.00	2.9 ~ 10.6	2580	370 ~ 3530	3.49	A
	2.0 + 2.5 + 2.5 + 4.2	11.2	1.60	2.01	2.01	3.38		9.00	2.9 ~ 10.6	2580	370 ~ 3530	3.49	A
	2.0 + 2.5 + 2.5 + 5.0	12.0	1.49	1.88	1.88	3.75		9.00	2.9 ~ 10.6	2450	410 ~ 3240	3.67	A
	2.0 + 2.5 + 2.5 + 6.0	13.0	1.38	1.73	1.73	4.16		9.00	2.9 ~ 10.8	2450	410 ~ 3380	3.67	A
	2.0 + 2.5 + 2.5 + 7.1	14.1	1.27	1.60	1.60	4.53		9.00	2.9 ~ 10.8	2400	440 ~ 3310	3.75	A
	2.0 + 2.5 + 3.5 + 3.5	11.5	1.56	1.96	2.74	2.74		9.00	2.9 ~ 10.6	2510	370 ~ 3450	3.59	A
	2.0 + 2.5 + 3.5 + 4.2	12.2	1.48	1.84	2.58	3.10		9.00	2.9 ~ 10.8	2510	370 ~ 3600	3.59	A
	2.0 + 2.5 + 3.5 + 5.0	13.0	1.38	1.73	2.42	3.47		9.00	2.9 ~ 10.8	2460	440 ~ 3310	3.66	A
	2.0 + 2.5 + 3.5 + 6.0	14.0	1.28	1.61	2.25	3.86		9.00	2.9 ~ 10.8	2460	440 ~ 3310	3.66	A
	2.0 + 2.5 + 3.5 + 7.1	15.1	1.19	1.49	2.09	4.23		9.00	3.0 ~ 11.0	2400	440 ~ 3390	3.75	A
	2.0 + 2.5 + 4.2 + 4.2	12.9	1.40	1.74	2.93	2.93		9.00	2.9 ~ 10.8	2510	370 ~ 3600	3.59	A
	2.0 + 2.5 + 4.2 + 5.0	13.7	1.31	1.64	2.76	3.29		9.00	2.9 ~ 10.8	2400	440 ~ 3310	3.75	A
	2.0 + 2.5 + 4.2 + 6.0	14.7	1.22	1.53	2.57	3.68		9.00	3.0 ~ 11.0	2400	440 ~ 3460	3.75	A
	2.0 + 2.5 + 4.2 + 7.1	15.8	1.14	1.42	2.39	4.05		9.00	3.0 ~ 11.2	2400	450 ~ 3530	3.75	A
	2.0 + 2.5 + 5.0 + 5.0	14.5	1.24	1.55	3.10	3.11		9.00	3.0 ~ 11.0	2410	490 ~ 3320	3.73	A
	2.0 + 2.5 + 5.0 + 6.0	15.5	1.16	1.45	2.90	3.49		9.00	3.0 ~ 11.0	2410	490 ~ 3320	3.73	A
	2.0 + 2.5 + 5.0 + 7.1	16.6	1.08	1.36	2.71	3.85		9.00	3.0 ~ 11.2	2350	520 ~ 3400	3.83	A
	2.0 + 2.5 + 6.0 + 6.0	16.5	1.09	1.37	3.27	3.27		9.00	3.0 ~ 11.2	2410	490 ~ 3390	3.73	A
	2.0 + 2.5 + 6.0 + 7.1	17.6	1.02	1.28	3.07	3.63		9.00	3.0 ~ 11.2	2350	520 ~ 3400	3.83	A
	2.0 + 3.5 + 3.5 + 3.5	12.5	1.44	2.52	2.52	2.52		9.00	2.9 ~ 10.8	2510	400 ~ 3530	3.59	A
2.0 + 3.5 + 3.5 + 4.2	13.2	1.36	2.39	2.39	2.86		9.00	2.9 ~ 10.8	2510	400 ~ 3530	3.59	A	
2.0 + 3.5 + 3.5 + 5.0	14.0	1.29	2.25	2.25	3.21		9.00	2.9 ~ 10.8	2400	440 ~ 3310	3.75	A	
2.0 + 3.5 + 3.5 + 6.0	15.0	1.20	2.10	2.10	3.60		9.00	3.0 ~ 11.0	2400	440 ~ 3460	3.75	A	
2.0 + 3.5 + 3.5 + 7.1	16.1	1.11	1.96	1.96	3.97		9.00	3.0 ~ 11.2	2400	470 ~ 3530	3.75	A	
2.0 + 3.5 + 4.2 + 4.2	13.9	1.29	2.27	2.72	2.72		9.00	2.9 ~ 10.8	2510	400 ~ 3530	3.59	A	
2.0 + 3.5 + 4.2 + 5.0	14.7	1.22	2.14	2.57	3.07		9.00	3.0 ~ 11.0	2400	440 ~ 3390	3.75	A	
2.0 + 3.5 + 4.2 + 6.0	15.7	1.14	2.01	2.41	3.44		9.00	3.0 ~ 11.0	2400	440 ~ 3390	3.75	A	
2.0 + 3.5 + 4.2 + 7.1	16.8	1.07	1.88	2.25	3.80		9.00	3.0 ~ 11.2	2400	480 ~ 3540	3.75	A	
2.0 + 3.5 + 5.0 + 5.0	15.5	1.16	2.04	2.90	2.90		9.00	3.0 ~ 11.0	2410	520 ~ 3250	3.73	A	
2.0 + 3.5 + 5.0 + 6.0	16.5	1.09	1.91	2.73	3.27		9.00	3.0 ~ 11.2	2410	520 ~ 3400	3.73	A	
2.0 + 3.5 + 5.0 + 7.1	17.6	1.02	1.79	2.56	3.63		9.00	3.0 ~ 11.2	2360	530 ~ 3400	3.81	A	
2.0 + 3.5 + 6.0 + 6.0	17.5	1.02	1.80	3.09	3.09		9.00	3.0 ~ 11.2	2410	520 ~ 3400	3.73	A	
2.0 + 4.2 + 4.2 + 4.2	14.6	1.23	2.59	2.59	2.59		9.00	3.0 ~ 11.0	2510	400 ~ 3600	3.59	A	
2.0 + 4.2 + 4.2 + 5.0	15.4	1.17	2.45	2.45	2.93		9.00	3.0 ~ 11.0	2400	450 ~ 3390	3.75	A	
2.0 + 4.2 + 4.2 + 6.0	16.4	1.10	2.30	2.30	3.30		9.00	3.0 ~ 11.2	2400	450 ~ 3530	3.75	A	
2.0 + 4.2 + 4.2 + 7.1	17.5	1.03	2.16	2.16	3.65		9.00	3.0 ~ 11.2	2400	480 ~ 3460	3.75	A	

	Indoor unit capacity Cooling	Annual Energy Consumption (kWh)	Current 230V (A)	ERP				Moisture Removal Volume l/h
				Pdesign (kW)	SEER		Annual Consumption (kWh)	
					WW	CLASS		
4 Room	2.0 + 2.0 + 2.5 + 2.5	1290	12.4	9.00	6.00	A+	525	1.3 + 1.3 + 1.5 + 1.5
	2.0 + 2.0 + 2.5 + 3.5	1290	12.4	9.00	6.00	A+	525	1.2 + 1.2 + 1.5 + 1.8
	2.0 + 2.0 + 2.5 + 4.2	1290	12.4	9.00	6.00	A+	525	1.1 + 1.1 + 1.4 + 2.0
	2.0 + 2.0 + 2.5 + 5.0	1225	11.7	9.00	6.00	A+	525	1.0 + 1.0 + 1.3 + 2.3
	2.0 + 2.0 + 2.5 + 6.0	1225	11.7	9.00	6.00	A+	525	0.9 + 0.9 + 1.2 + 2.4
	2.0 + 2.0 + 2.5 + 7.1	1200	11.5	9.00	6.00	A+	525	0.8 + 0.8 + 1.1 + 2.5
	2.0 + 2.0 + 3.5 + 3.5	1255	12.0	9.00	6.00	A+	525	1.0 + 1.0 + 1.7 + 1.7
	2.0 + 2.0 + 3.5 + 4.2	1255	12.0	9.00	6.00	A+	525	1.0 + 1.0 + 1.6 + 1.8
	2.0 + 2.0 + 3.5 + 5.0	1230	11.8	9.00	6.00	A+	525	0.9 + 0.9 + 1.5 + 2.1
	2.0 + 2.0 + 3.5 + 6.0	1230	11.8	9.00	6.00	A+	525	0.8 + 0.8 + 1.5 + 2.3
	2.0 + 2.0 + 3.5 + 7.1	1200	11.5	9.00	6.00	A+	525	0.8 + 0.8 + 1.4 + 2.4
	2.0 + 2.0 + 4.2 + 4.2	1255	12.0	9.00	6.00	A+	525	0.9 + 0.9 + 1.7 + 1.7
	2.0 + 2.0 + 4.2 + 5.0	1200	11.5	9.00	6.00	A+	525	0.9 + 0.9 + 1.7 + 2.0
	2.0 + 2.0 + 4.2 + 6.0	1200	11.5	9.00	6.00	A+	525	0.8 + 0.8 + 1.6 + 2.2
	2.0 + 2.0 + 4.2 + 7.1	1200	11.5	9.00	6.00	A+	525	0.7 + 0.7 + 1.5 + 2.4
	2.0 + 2.0 + 5.0 + 5.0	1205	11.5	9.00	6.00	A+	525	0.8 + 0.8 + 1.8 + 1.8
	2.0 + 2.0 + 5.0 + 6.0	1205	11.5	9.00	6.00	A+	525	0.7 + 0.7 + 1.7 + 2.1
	2.0 + 2.0 + 5.0 + 7.1	1175	11.2	9.00	6.00	A+	525	0.7 + 0.7 + 1.6 + 2.3
	2.0 + 2.0 + 6.0 + 6.0	1205	11.5	9.00	6.00	A+	525	0.7 + 0.7 + 1.9 + 1.9
	2.0 + 2.0 + 6.0 + 7.1	1175	11.2	9.00	6.00	A+	525	0.7 + 0.7 + 1.8 + 2.2
	2.0 + 2.0 + 7.1 + 7.1	1180	11.3	9.00	6.00	A+	525	0.7 + 0.7 + 2.0 + 2.0
	2.0 + 2.5 + 2.5 + 2.5	1290	12.4	9.00	6.00	A+	525	1.2 + 1.5 + 1.5 + 1.5
	2.0 + 2.5 + 2.5 + 3.5	1290	12.4	9.00	6.00	A+	525	1.1 + 1.4 + 1.4 + 1.7
	2.0 + 2.5 + 2.5 + 4.2	1290	12.4	9.00	6.00	A+	525	1.0 + 1.3 + 1.3 + 1.9
	2.0 + 2.5 + 2.5 + 5.0	1225	11.7	9.00	6.00	A+	525	0.9 + 1.2 + 1.2 + 2.2
	2.0 + 2.5 + 2.5 + 6.0	1225	11.7	9.00	6.00	A+	525	0.9 + 1.1 + 1.1 + 2.4
	2.0 + 2.5 + 2.5 + 7.1	1200	11.5	9.00	6.00	A+	525	0.8 + 1.0 + 1.0 + 2.5
	2.0 + 2.5 + 3.5 + 3.5	1255	12.0	9.00	6.00	A+	525	1.0 + 1.3 + 1.6 + 1.6
	2.0 + 2.5 + 3.5 + 4.2	1255	12.0	9.00	6.00	A+	525	0.9 + 1.2 + 1.6 + 1.7
	2.0 + 2.5 + 3.5 + 5.0	1230	11.8	9.00	6.00	A+	525	0.9 + 1.1 + 1.5 + 2.0
	2.0 + 2.5 + 3.5 + 6.0	1230	11.8	9.00	6.00	A+	525	0.8 + 1.0 + 1.5 + 2.3
	2.0 + 2.5 + 3.5 + 7.1	1200	11.5	9.00	6.00	A+	525	0.7 + 0.9 + 1.4 + 2.4
	2.0 + 2.5 + 4.2 + 4.2	1255	12.0	9.00	6.00	A+	525	0.9 + 1.1 + 1.7 + 1.7
	2.0 + 2.5 + 4.2 + 5.0	1200	11.5	9.00	6.00	A+	525	0.8 + 1.0 + 1.6 + 1.9
	2.0 + 2.5 + 4.2 + 6.0	1200	11.5	9.00	6.00	A+	525	0.8 + 1.0 + 1.6 + 2.1
	2.0 + 2.5 + 4.2 + 7.1	1200	11.5	9.00	6.00	A+	525	0.7 + 0.9 + 1.5 + 2.3
	2.0 + 2.5 + 5.0 + 5.0	1205	11.5	9.00	6.00	A+	525	0.8 + 1.0 + 1.7 + 1.8
	2.0 + 2.5 + 5.0 + 6.0	1205	11.5	9.00	6.00	A+	525	0.7 + 0.9 + 1.7 + 2.0
	2.0 + 2.5 + 5.0 + 7.1	1175	11.2	9.00	6.00	A+	525	0.7 + 0.9 + 1.6 + 2.3
	2.0 + 2.5 + 6.0 + 6.0	1205	11.5	9.00	6.00	A+	525	0.7 + 0.9 + 1.9 + 1.9
2.0 + 2.5 + 6.0 + 7.1	1175	11.2	9.00	6.00	A+	525	0.7 + 0.8 + 1.7 + 2.1	
2.0 + 3.5 + 3.5 + 3.5	1255	12.0	9.00	6.00	A+	525	0.9 + 1.5 + 1.5 + 1.5	
2.0 + 3.5 + 3.5 + 4.2	1255	12.0	9.00	6.00	A+	525	0.9 + 1.5 + 1.5 + 1.7	
2.0 + 3.5 + 3.5 + 5.0	1200	11.5	9.00	6.00	A+	525	0.8 + 1.5 + 1.5 + 1.8	
2.0 + 3.5 + 3.5 + 6.0	1200	11.5	9.00	6.00	A+	525	0.7 + 1.4 + 1.4 + 2.1	
2.0 + 3.5 + 3.5 + 7.1	1200	11.5	9.00	6.00	A+	525	0.7 + 1.3 + 1.3 + 2.3	
2.0 + 3.5 + 4.2 + 4.2	1255	12.0	9.00	6.00	A+	525	0.8 + 1.5 + 1.6 + 1.6	
2.0 + 3.5 + 4.2 + 5.0	1200	11.5	9.00	6.00	A+	525	0.8 + 1.4 + 1.6 + 1.7	
2.0 + 3.5 + 4.2 + 6.0	1200	11.5	9.00	6.00	A+	525	0.7 + 1.3 + 1.5 + 2.0	
2.0 + 3.5 + 4.2 + 7.1	1200	11.5	9.00	6.00	A+	525	0.7 + 1.2 + 1.5 + 2.2	
2.0 + 3.5 + 5.0 + 5.0	1205	11.5	9.00	6.00	A+	525	0.7 + 1.3 + 1.7 + 1.7	
2.0 + 3.5 + 5.0 + 6.0	1205	11.5	9.00	6.00	A+	525	0.7 + 1.2 + 1.6 + 1.9	
2.0 + 3.5 + 5.0 + 7.1	1180	11.3	9.00	6.00	A+	525	0.7 + 1.2 + 1.6 + 2.1	
2.0 + 3.5 + 6.0 + 6.0	1205	11.5	9.00	6.00	A+	525	0.7 + 1.2 + 1.7 + 1.7	
2.0 + 4.2 + 4.2 + 4.2	1255	12.0	9.00	6.00	A+	525	0.8 + 1.6 + 1.6 + 1.6	
2.0 + 4.2 + 4.2 + 5.0	1200	11.5	9.00	6.00	A+	525	0.7 + 1.5 + 1.5 + 1.7	
2.0 + 4.2 + 4.2 + 6.0	1200	11.5	9.00	6.00	A+	525	0.7 + 1.5 + 1.5 + 1.9	
2.0 + 4.2 + 4.2 + 7.1	1200	11.5	9.00	6.00	A+	525	0.7 + 1.4 + 1.4 + 2.1	

Indoor unit capacity Cooling		Total	Cooling Capacity (kW)						Input Power (W)		EER		
			Room A	Room B	Room C	Room D	Room E	Total	min ~ max	Rating	min ~ max	WW	CLASS
4 Room	2.0 + 4.2 + 5.0 + 5.0	16.2	1.11	2.33	2.78	2.78		9.00	3.0 ~ 11.2	2350	520 ~ 3400	3.83	A
	2.0 + 4.2 + 5.0 + 6.0	17.2	1.04	2.20	2.62	3.14		9.00	3.0 ~ 11.2	2350	520 ~ 3400	3.83	A
	2.0 + 4.2 + 5.0 + 7.1	18.3	0.98	2.07	2.46	3.49		9.00	3.0 ~ 11.2	2360	530 ~ 3330	3.81	A
	2.0 + 4.2 + 6.0 + 6.0	18.2	0.98	2.08	2.97	2.97		9.00	3.0 ~ 11.2	2350	520 ~ 3400	3.83	A
	2.0 + 5.0 + 5.0 + 5.0	17.0	1.05	2.65	2.65	2.65		9.00	3.0 ~ 11.2	2370	580 ~ 3340	3.80	A
	2.0 + 5.0 + 5.0 + 6.0	18.0	1.00	2.50	2.50	3.00		9.00	3.0 ~ 11.2	2370	580 ~ 3340	3.80	A
	2.5 + 2.5 + 2.5 + 2.5	10.0	2.25	2.25	2.25	2.25		9.00	2.9 ~ 10.6	2580	370 ~ 3600	3.49	A
	2.5 + 2.5 + 2.5 + 3.5	11.0	2.05	2.05	2.05	2.85		9.00	2.9 ~ 10.6	2580	370 ~ 3530	3.49	A
	2.5 + 2.5 + 2.5 + 4.2	11.7	1.92	1.92	1.92	3.24		9.00	2.9 ~ 10.6	2580	370 ~ 3530	3.49	A
	2.5 + 2.5 + 2.5 + 5.0	12.5	1.80	1.80	1.80	3.60		9.00	2.9 ~ 10.8	2450	410 ~ 3380	3.67	A
	2.5 + 2.5 + 2.5 + 6.0	13.5	1.67	1.67	1.67	3.99		9.00	2.9 ~ 10.8	2450	410 ~ 3380	3.67	A
	2.5 + 2.5 + 2.5 + 7.1	14.6	1.54	1.54	1.54	4.38		9.00	3.0 ~ 11.0	2400	440 ~ 3460	3.75	A
	2.5 + 2.5 + 3.5 + 3.5	12.0	1.87	1.87	2.63	2.63		9.00	2.9 ~ 10.6	2510	370 ~ 3450	3.59	A
	2.5 + 2.5 + 3.5 + 4.2	12.7	1.77	1.77	2.48	2.98		9.00	2.9 ~ 10.8	2510	370 ~ 3600	3.59	A
	2.5 + 2.5 + 3.5 + 5.0	13.5	1.67	1.67	2.33	3.33		9.00	2.9 ~ 10.8	2460	440 ~ 3310	3.66	A
	2.5 + 2.5 + 3.5 + 6.0	14.5	1.55	1.55	2.17	3.73		9.00	3.0 ~ 11.0	2460	440 ~ 3460	3.66	A
	2.5 + 2.5 + 3.5 + 7.1	15.6	1.44	1.44	2.02	4.10		9.00	3.0 ~ 11.0	2400	440 ~ 3390	3.75	A
	2.5 + 2.5 + 4.2 + 4.2	13.4	1.68	1.68	2.82	2.82		9.00	2.9 ~ 10.8	2510	370 ~ 3600	3.59	A
	2.5 + 2.5 + 4.2 + 5.0	14.2	1.58	1.58	2.66	3.18		9.00	3.0 ~ 11.0	2400	440 ~ 3460	3.75	A
	2.5 + 2.5 + 4.2 + 6.0	15.2	1.48	1.48	2.49	3.55		9.00	3.0 ~ 11.0	2400	440 ~ 3460	3.75	A
	2.5 + 2.5 + 4.2 + 7.1	16.3	1.38	1.38	2.32	3.92		9.00	3.0 ~ 11.2	2400	450 ~ 3530	3.75	A
	2.5 + 2.5 + 5.0 + 5.0	15.0	1.50	1.50	3.00	3.00		9.00	3.0 ~ 11.0	2410	490 ~ 3320	3.73	A
	2.5 + 2.5 + 5.0 + 6.0	16.0	1.41	1.41	2.80	3.38		9.00	3.0 ~ 11.2	2410	490 ~ 3390	3.73	A
	2.5 + 2.5 + 5.0 + 7.1	17.1	1.32	1.32	2.62	3.74		9.00	3.0 ~ 11.2	2350	520 ~ 3400	3.83	A
	2.5 + 2.5 + 6.0 + 6.0	17.0	1.32	1.32	3.18	3.18		9.00	3.0 ~ 11.2	2410	490 ~ 3390	3.73	A
	2.5 + 2.5 + 6.0 + 7.1	18.1	1.24	1.24	2.98	3.54		9.00	3.0 ~ 11.2	2350	520 ~ 3400	3.83	A
	2.5 + 3.5 + 3.5 + 3.5	13.0	1.74	2.42	2.42	2.42		9.00	2.9 ~ 10.8	2510	400 ~ 3530	3.59	A
	2.5 + 3.5 + 3.5 + 4.2	13.7	1.64	2.30	2.30	2.76		9.00	2.9 ~ 10.8	2510	400 ~ 3530	3.59	A
	2.5 + 3.5 + 3.5 + 5.0	14.5	1.55	2.17	2.17	3.11		9.00	3.0 ~ 11.0	2400	440 ~ 3460	3.75	A
	2.5 + 3.5 + 3.5 + 6.0	15.5	1.45	2.03	2.03	3.49		9.00	3.0 ~ 11.0	2400	440 ~ 3460	3.75	A
	2.5 + 3.5 + 3.5 + 7.1	16.6	1.35	1.90	1.90	3.85		9.00	3.0 ~ 11.2	2400	470 ~ 3530	3.75	A
	2.5 + 3.5 + 4.2 + 4.2	14.4	1.55	2.19	2.63	2.63		9.00	3.0 ~ 11.0	2510	400 ~ 3680	3.59	A
	2.5 + 3.5 + 4.2 + 5.0	15.2	1.48	2.07	2.49	2.96		9.00	3.0 ~ 11.0	2400	440 ~ 3390	3.75	A
	2.5 + 3.5 + 4.2 + 6.0	16.2	1.39	1.95	2.33	3.33		9.00	3.0 ~ 11.2	2400	440 ~ 3530	3.75	A
	2.5 + 3.5 + 4.2 + 7.1	17.3	1.30	1.82	2.18	3.70		9.00	3.0 ~ 11.2	2400	480 ~ 3540	3.75	A
	2.5 + 3.5 + 5.0 + 5.0	16.0	1.41	1.97	2.81	2.81		9.00	3.0 ~ 11.2	2410	520 ~ 3400	3.73	A
	2.5 + 3.5 + 5.0 + 6.0	17.0	1.32	1.85	2.65	3.18		9.00	3.0 ~ 11.2	2410	520 ~ 3400	3.73	A
	2.5 + 3.5 + 5.0 + 7.1	18.1	1.24	1.74	2.49	3.53		9.00	3.0 ~ 11.2	2360	530 ~ 3400	3.81	A
	2.5 + 3.5 + 6.0 + 6.0	18.0	1.25	1.75	3.00	3.00		9.00	3.0 ~ 11.2	2410	520 ~ 3400	3.73	A
	2.5 + 4.2 + 4.2 + 4.2	15.1	1.50	2.50	2.50	2.50		9.00	3.0 ~ 11.0	2510	400 ~ 3600	3.59	A
2.5 + 4.2 + 4.2 + 5.0	15.9	1.41	2.38	2.38	2.83		9.00	3.0 ~ 11.2	2400	450 ~ 3530	3.75	A	
2.5 + 4.2 + 4.2 + 6.0	16.9	1.32	2.24	2.24	3.20		9.00	3.0 ~ 11.2	2400	450 ~ 3530	3.75	A	
2.5 + 4.2 + 4.2 + 7.1	18.0	1.25	2.10	2.10	3.55		9.00	3.0 ~ 11.2	2400	480 ~ 3460	3.75	A	
2.5 + 4.2 + 5.0 + 5.0	16.7	1.35	2.27	2.69	2.69		9.00	3.0 ~ 11.2	2350	520 ~ 3400	3.83	A	
2.5 + 4.2 + 5.0 + 6.0	17.7	1.27	2.14	2.54	3.05		9.00	3.0 ~ 11.2	2350	520 ~ 3400	3.83	A	
2.5 + 5.0 + 5.0 + 5.0	17.5	1.29	2.57	2.57	2.57		9.00	3.0 ~ 11.2	2370	580 ~ 3340	3.80	A	
3.5 + 3.5 + 3.5 + 3.5	14.0	2.25	2.25	2.25	2.25		9.00	2.9 ~ 10.8	2450	400 ~ 3450	3.67	A	
3.5 + 3.5 + 3.5 + 4.2	14.7	2.14	2.14	2.14	2.58		9.00	3.0 ~ 11.0	2450	410 ~ 3600	3.67	A	
3.5 + 3.5 + 3.5 + 5.0	15.5	2.03	2.03	2.03	2.91		9.00	3.0 ~ 11.0	2400	470 ~ 3390	3.75	A	
3.5 + 3.5 + 3.5 + 6.0	16.5	1.91	1.91	1.91	3.27		9.00	3.0 ~ 11.2	2400	470 ~ 3530	3.75	A	
3.5 + 3.5 + 3.5 + 7.1	17.6	1.79	1.79	1.79	3.63		9.00	3.0 ~ 11.2	2400	480 ~ 3460	3.75	A	
3.5 + 3.5 + 4.2 + 4.2	15.4	2.05	2.05	2.45	2.45		9.00	3.0 ~ 11.0	2450	410 ~ 3600	3.67	A	
3.5 + 3.5 + 4.2 + 5.0	16.2	1.94	1.94	2.33	2.79		9.00	3.0 ~ 11.2	2400	470 ~ 3530	3.75	A	
3.5 + 3.5 + 4.2 + 6.0	17.2	1.83	1.83	2.20	3.14		9.00	3.0 ~ 11.2	2400	470 ~ 3530	3.75	A	
3.5 + 3.5 + 4.2 + 7.1	18.3	1.72	1.72	2.07	3.49		9.00	3.0 ~ 11.2	2400	480 ~ 3460	3.75	A	
3.5 + 3.5 + 5.0 + 5.0	17.0	1.85	1.85	2.65	2.65		9.00	3.0 ~ 11.2	2360	520 ~ 3400	3.81	A	
3.5 + 3.5 + 5.0 + 6.0	18.0	1.75	1.75	2.50	3.00		9.00	3.0 ~ 11.2	2360	520 ~ 3400	3.81	A	
3.5 + 4.2 + 4.2 + 4.2	16.1	1.95	2.35	2.35	2.35		9.00	3.0 ~ 11.2	2450	410 ~ 3760	3.67	A	



	Indoor unit capacity Cooling	Annual Energy Consumption (kWh)	Current 230V (A)	ERP				Moisture Removal Volume l/h
				Pdesign (kW)	SEER		Annual Consumption (kWh)	
					WW	CLASS		
4 Room	2.0 + 4.2 + 5.0 + 5.0	1175	11.2	9.00	6.00	A+	525	0.7 + 1.5 + 1.6 + 1.6
	2.0 + 4.2 + 5.0 + 6.0	1175	11.2	9.00	6.00	A+	525	0.7 + 1.4 + 1.6 + 1.8
	2.0 + 4.2 + 5.0 + 7.1	1180	11.3	9.00	6.00	A+	525	0.7 + 1.3 + 1.5 + 2.0
	2.0 + 4.2 + 6.0 + 6.0	1175	11.2	9.00	6.00	A+	525	0.7 + 1.3 + 1.7 + 1.7
	2.0 + 5.0 + 5.0 + 5.0	1185	11.3	9.00	6.00	A+	525	0.7 + 1.6 + 1.6 + 1.6
	2.0 + 5.0 + 5.0 + 6.0	1185	11.3	9.00	6.00	A+	525	0.7 + 1.5 + 1.5 + 1.7
	2.5 + 2.5 + 2.5 + 2.5	1290	12.4	9.00	6.00	A+	525	1.5 + 1.5 + 1.5 + 1.5
	2.5 + 2.5 + 2.5 + 3.5	1290	12.4	9.00	6.00	A+	525	1.3 + 1.3 + 1.3 + 1.7
	2.5 + 2.5 + 2.5 + 4.2	1290	12.4	9.00	6.00	A+	525	1.2 + 1.2 + 1.2 + 1.8
	2.5 + 2.5 + 2.5 + 5.0	1225	11.7	9.00	6.00	A+	525	1.2 + 1.2 + 1.2 + 2.1
	2.5 + 2.5 + 2.5 + 6.0	1225	11.7	9.00	6.00	A+	525	1.1 + 1.1 + 1.1 + 2.3
	2.5 + 2.5 + 2.5 + 7.1	1200	11.5	9.00	6.00	A+	525	1.0 + 1.0 + 1.0 + 2.4
	2.5 + 2.5 + 3.5 + 3.5	1255	12.0	9.00	6.00	A+	525	1.2 + 1.2 + 1.6 + 1.6
	2.5 + 2.5 + 3.5 + 4.2	1255	12.0	9.00	6.00	A+	525	1.1 + 1.1 + 1.5 + 1.7
	2.5 + 2.5 + 3.5 + 5.0	1230	11.8	9.00	6.00	A+	525	1.1 + 1.1 + 1.5 + 1.9
	2.5 + 2.5 + 3.5 + 6.0	1230	11.8	9.00	6.00	A+	525	1.0 + 1.0 + 1.4 + 2.2
	2.5 + 2.5 + 3.5 + 7.1	1200	11.5	9.00	6.00	A+	525	0.9 + 0.9 + 1.3 + 2.3
	2.5 + 2.5 + 4.2 + 4.2	1255	12.0	9.00	6.00	A+	525	1.1 + 1.1 + 1.7 + 1.7
	2.5 + 2.5 + 4.2 + 5.0	1200	11.5	9.00	6.00	A+	525	1.0 + 1.0 + 1.6 + 1.8
	2.5 + 2.5 + 4.2 + 6.0	1200	11.5	9.00	6.00	A+	525	0.9 + 0.9 + 1.5 + 2.1
	2.5 + 2.5 + 4.2 + 7.1	1200	11.5	9.00	6.00	A+	525	0.9 + 0.9 + 1.5 + 2.3
	2.5 + 2.5 + 5.0 + 5.0	1205	11.5	9.00	6.00	A+	525	1.0 + 1.0 + 1.7 + 1.7
	2.5 + 2.5 + 5.0 + 6.0	1205	11.5	9.00	6.00	A+	525	0.9 + 0.9 + 1.6 + 1.9
	2.5 + 2.5 + 5.0 + 7.1	1175	11.2	9.00	6.00	A+	525	0.8 + 0.8 + 1.6 + 2.2
	2.5 + 2.5 + 6.0 + 6.0	1205	11.5	9.00	6.00	A+	525	0.8 + 0.8 + 1.8 + 1.8
	2.5 + 2.5 + 6.0 + 7.1	1175	11.2	9.00	6.00	A+	525	0.8 + 0.8 + 1.7 + 2.0
	2.5 + 3.5 + 3.5 + 3.5	1255	12.0	9.00	6.00	A+	525	1.1 + 1.5 + 1.5 + 1.5
	2.5 + 3.5 + 3.5 + 4.2	1255	12.0	9.00	6.00	A+	525	1.0 + 1.5 + 1.5 + 1.6
	2.5 + 3.5 + 3.5 + 5.0	1200	11.5	9.00	6.00	A+	525	1.0 + 1.4 + 1.4 + 1.8
	2.5 + 3.5 + 3.5 + 6.0	1200	11.5	9.00	6.00	A+	525	0.9 + 1.3 + 1.3 + 2.0
	2.5 + 3.5 + 3.5 + 7.1	1200	11.5	9.00	6.00	A+	525	0.9 + 1.2 + 1.2 + 2.3
	2.5 + 3.5 + 4.2 + 4.2	1255	12.0	9.00	6.00	A+	525	1.0 + 1.4 + 1.6 + 1.6
	2.5 + 3.5 + 4.2 + 5.0	1200	11.5	9.00	6.00	A+	525	0.9 + 1.3 + 1.5 + 1.7
	2.5 + 3.5 + 4.2 + 6.0	1200	11.5	9.00	6.00	A+	525	0.9 + 1.3 + 1.5 + 1.9
	2.5 + 3.5 + 4.2 + 7.1	1200	11.5	9.00	6.00	A+	525	0.8 + 1.2 + 1.4 + 2.2
	2.5 + 3.5 + 5.0 + 5.0	1205	11.5	9.00	6.00	A+	525	0.9 + 1.3 + 1.6 + 1.6
	2.5 + 3.5 + 5.0 + 6.0	1205	11.5	9.00	6.00	A+	525	0.8 + 1.2 + 1.6 + 1.8
	2.5 + 3.5 + 5.0 + 7.1	1180	11.3	9.00	6.00	A+	525	0.8 + 1.1 + 1.5 + 2.0
	2.5 + 3.5 + 6.0 + 6.0	1205	11.5	9.00	6.00	A+	525	0.8 + 1.1 + 1.7 + 1.7
	2.5 + 4.2 + 4.2 + 4.2	1255	12.0	9.00	6.00	A+	525	1.0 + 1.5 + 1.5 + 1.5
2.5 + 4.2 + 4.2 + 5.0	1200	11.5	9.00	6.00	A+	525	0.9 + 1.5 + 1.5 + 1.7	
2.5 + 4.2 + 4.2 + 6.0	1200	11.5	9.00	6.00	A+	525	0.8 + 1.5 + 1.5 + 1.8	
2.5 + 4.2 + 4.2 + 7.1	1200	11.5	9.00	6.00	A+	525	0.8 + 1.4 + 1.4 + 2.1	
2.5 + 4.2 + 5.0 + 5.0	1175	11.2	9.00	6.00	A+	525	0.9 + 1.5 + 1.6 + 1.6	
2.5 + 4.2 + 5.0 + 6.0	1175	11.2	9.00	6.00	A+	525	0.8 + 1.4 + 1.6 + 1.7	
2.5 + 5.0 + 5.0 + 5.0	1185	11.3	9.00	6.00	A+	525	0.8 + 1.6 + 1.6 + 1.6	
3.5 + 3.5 + 3.5 + 3.5	1225	11.7	9.00	6.00	A+	525	1.5 + 1.5 + 1.5 + 1.5	
3.5 + 3.5 + 3.5 + 4.2	1225	11.7	9.00	6.00	A+	525	1.4 + 1.4 + 1.4 + 1.6	
3.5 + 3.5 + 3.5 + 5.0	1200	11.5	9.00	6.00	A+	525	1.3 + 1.3 + 1.3 + 1.7	
3.5 + 3.5 + 3.5 + 6.0	1200	11.5	9.00	6.00	A+	525	1.2 + 1.2 + 1.2 + 1.9	
3.5 + 3.5 + 3.5 + 7.1	1200	11.5	9.00	6.00	A+	525	1.2 + 1.2 + 1.2 + 2.1	
3.5 + 3.5 + 4.2 + 4.2	1225	11.7	9.00	6.00	A+	525	1.3 + 1.3 + 1.5 + 1.5	
3.5 + 3.5 + 4.2 + 5.0	1200	11.5	9.00	6.00	A+	525	1.3 + 1.3 + 1.5 + 1.6	
3.5 + 3.5 + 4.2 + 6.0	1200	11.5	9.00	6.00	A+	525	1.2 + 1.2 + 1.4 + 1.8	
3.5 + 3.5 + 4.2 + 7.1	1200	11.5	9.00	6.00	A+	525	1.1 + 1.1 + 1.3 + 2.0	
3.5 + 3.5 + 5.0 + 5.0	1180	11.3	9.00	6.00	A+	525	1.2 + 1.2 + 1.6 + 1.6	
3.5 + 3.5 + 5.0 + 6.0	1180	11.3	9.00	6.00	A+	525	1.1 + 1.1 + 1.5 + 1.7	
3.5 + 4.2 + 4.2 + 4.2	1225	11.7	9.00	6.00	A+	525	1.3 + 1.5 + 1.5 + 1.5	

Indoor unit capacity Cooling		Total	Cooling Capacity (kW)							Input Power (W)		EER	
			Room A	Room B	Room C	Room D	Room E	Total	min ~ max	Rating	min ~ max	WW	CLASS
4 Room	3.5 + 4.2 + 4.2 + 5.0	16.9	1.86	2.24	2.24	2.66		9.00	3.0 ~ 11.2	2400	480 ~ 3540	3.75	A
	3.5 + 4.2 + 4.2 + 6.0	17.9	1.76	2.11	2.11	3.02		9.00	3.0 ~ 11.2	2400	480 ~ 3540	3.75	A
	3.5 + 4.2 + 5.0 + 5.0	17.7	1.78	2.14	2.54	2.54		9.00	3.0 ~ 11.2	2360	530 ~ 3400	3.81	A
	4.2 + 4.2 + 4.2 + 4.2	16.8	2.25	2.25	2.25	2.25		9.00	3.0 ~ 11.2	2450	430 ~ 3680	3.67	A
	4.2 + 4.2 + 4.2 + 5.0	17.6	2.15	2.15	2.15	2.55		9.00	3.0 ~ 11.2	2400	480 ~ 3460	3.75	A

Indoor unit capacity Cooling		Annual Energy Consumption (kWh)	Current 230V (A)	ERP				Moisture Removal Volume l/h
				Pdesign (kW)	SEER		Annual Consumption (kWh)	
					WW	CLASS		
4 Room	3.5 + 4.2 + 4.2 + 5.0	1200	11.5	9.00	6.00	A+	525	1.2 + 1.5 + 1.5 + 1.6
	3.5 + 4.2 + 4.2 + 6.0	1200	11.5	9.00	6.00	A+	525	1.1 + 1.4 + 1.4 + 1.7
	3.5 + 4.2 + 5.0 + 5.0	1180	11.3	9.00	6.00	A+	525	1.1 + 1.4 + 1.6 + 1.6
	4.2 + 4.2 + 4.2 + 4.2	1225	11.7	9.00	6.00	A+	525	1.5 + 1.5 + 1.5 + 1.5
	4.2 + 4.2 + 4.2 + 5.0	1200	11.5	9.00	6.00	A+	525	1.4 + 1.4 + 1.4 + 1.6

Indoor unit capacity Cooling	Total	Cooling Capacity (kW)							Input Power (W)		EER	
		Room A	Room B	Room C	Room D	Room E	Total	min ~ max	Rating	min ~ max	WW	CLASS
1.6 + 1.6 + 1.6 + 1.6 + 1.6	8.0	1.60	1.60	1.60	1.60	1.60	8.00	2.9 ~ 11.5	2120	450 ~ 3810	3.77	A
1.6 + 1.6 + 1.6 + 1.6 + 2.0	8.4	1.60	1.60	1.60	1.60	2.00	8.40	2.9 ~ 11.5	2230	450 ~ 3810	3.77	A
1.6 + 1.6 + 1.6 + 1.6 + 2.5	8.9	1.62	1.62	1.62	1.62	2.52	9.00	2.9 ~ 11.5	2450	450 ~ 3810	3.67	A
1.6 + 1.6 + 1.6 + 1.6 + 3.5	9.9	1.45	1.45	1.45	1.45	3.20	9.00	2.9 ~ 11.5	2450	450 ~ 3740	3.67	A
1.6 + 1.6 + 1.6 + 1.6 + 4.2	10.6	1.36	1.36	1.36	1.36	3.56	9.00	2.9 ~ 11.5	2450	450 ~ 3740	3.67	A
1.6 + 1.6 + 1.6 + 1.6 + 5.0	11.4	1.26	1.26	1.26	1.26	3.96	9.00	2.9 ~ 11.5	2410	530 ~ 3600	3.73	A
1.6 + 1.6 + 1.6 + 1.6 + 6.0	12.4	1.16	1.16	1.16	1.16	4.36	9.00	2.9 ~ 11.5	2410	530 ~ 3600	3.73	A
1.6 + 1.6 + 1.6 + 1.6 + 7.1	13.5	1.07	1.07	1.07	1.07	4.72	9.00	2.9 ~ 11.5	2410	540 ~ 3530	3.73	A
1.6 + 1.6 + 1.6 + 2.0 + 2.0	8.8	1.60	1.60	1.60	2.00	2.00	8.80	2.9 ~ 11.5	2390	450 ~ 3730	3.68	A
1.6 + 1.6 + 1.6 + 2.0 + 2.5	9.3	1.55	1.55	1.55	1.94	2.41	9.00	2.9 ~ 11.5	2450	450 ~ 3730	3.67	A
1.6 + 1.6 + 1.6 + 2.0 + 3.5	10.3	1.40	1.40	1.40	1.75	3.05	9.00	2.9 ~ 11.5	2450	450 ~ 3740	3.67	A
1.6 + 1.6 + 1.6 + 2.0 + 4.2	11.0	1.31	1.31	1.31	1.64	3.43	9.00	2.9 ~ 11.5	2450	480 ~ 3740	3.67	A
1.6 + 1.6 + 1.6 + 2.0 + 5.0	11.8	1.22	1.22	1.22	1.53	3.81	9.00	2.9 ~ 11.5	2410	530 ~ 3600	3.73	A
1.6 + 1.6 + 1.6 + 2.0 + 6.0	12.8	1.13	1.13	1.13	1.41	4.20	9.00	2.9 ~ 11.5	2410	530 ~ 3600	3.73	A
1.6 + 1.6 + 1.6 + 2.0 + 7.1	13.9	1.04	1.04	1.04	1.29	4.59	9.00	2.9 ~ 11.5	2420	540 ~ 3530	3.72	A
1.6 + 1.6 + 1.6 + 2.5 + 2.5	9.8	1.47	1.47	1.47	2.29	2.29	8.99	2.9 ~ 11.5	2450	450 ~ 3730	3.67	A
1.6 + 1.6 + 1.6 + 2.5 + 3.5	10.8	1.33	1.33	1.33	2.08	2.93	9.00	2.9 ~ 11.5	2450	450 ~ 3740	3.67	A
1.6 + 1.6 + 1.6 + 2.5 + 4.2	11.5	1.25	1.25	1.25	1.96	3.29	9.00	2.9 ~ 11.5	2450	480 ~ 3740	3.67	A
1.6 + 1.6 + 1.6 + 2.5 + 5.0	12.3	1.17	1.17	1.17	1.83	3.66	9.00	2.9 ~ 11.5	2410	530 ~ 3600	3.73	A
1.6 + 1.6 + 1.6 + 2.5 + 6.0	13.3	1.08	1.08	1.08	1.69	4.07	9.00	2.9 ~ 11.5	2410	530 ~ 3600	3.73	A
1.6 + 1.6 + 1.6 + 2.5 + 7.1	14.4	1.00	1.00	1.00	1.56	4.44	9.00	2.9 ~ 11.5	2420	540 ~ 3530	3.72	A
1.6 + 1.6 + 1.6 + 3.5 + 3.5	11.8	1.22	1.22	1.22	2.67	2.67	9.00	2.9 ~ 11.5	2460	480 ~ 3660	3.66	A
1.6 + 1.6 + 1.6 + 3.5 + 4.2	12.5	1.15	1.15	1.15	2.52	3.03	9.00	2.9 ~ 11.5	2460	480 ~ 3660	3.66	A
1.6 + 1.6 + 1.6 + 3.5 + 5.0	13.3	1.08	1.08	1.08	2.37	3.39	9.00	2.9 ~ 11.5	2420	540 ~ 3530	3.72	A
1.6 + 1.6 + 1.6 + 3.5 + 6.0	14.3	1.01	1.01	1.01	2.20	3.77	9.00	2.9 ~ 11.5	2420	540 ~ 3530	3.72	A
1.6 + 1.6 + 1.6 + 3.5 + 7.1	15.4	0.94	0.94	0.94	2.05	4.13	9.00	2.9 ~ 11.5	2420	570 ~ 3530	3.72	A
1.6 + 1.6 + 1.6 + 4.2 + 4.2	13.2	1.09	1.09	1.09	2.86	2.86	8.99	2.9 ~ 11.5	2460	490 ~ 3660	3.65	A
1.6 + 1.6 + 1.6 + 4.2 + 5.0	14.0	1.03	1.03	1.03	2.70	3.21	9.00	2.9 ~ 11.5	2420	540 ~ 3530	3.72	A
1.6 + 1.6 + 1.6 + 4.2 + 6.0	15.0	0.96	0.96	0.96	2.52	3.60	9.00	2.9 ~ 11.5	2420	540 ~ 3530	3.72	A
1.6 + 1.6 + 1.6 + 4.2 + 7.1	16.1	0.89	0.89	0.89	2.35	3.98	9.00	2.9 ~ 11.5	2420	570 ~ 3540	3.72	A
1.6 + 1.6 + 1.6 + 5.0 + 5.0	14.8	0.97	0.97	0.97	3.04	3.05	9.00	2.9 ~ 11.5	2440	620 ~ 3480	3.69	A
1.6 + 1.6 + 1.6 + 5.0 + 6.0	15.8	0.91	0.91	0.91	2.85	3.42	9.00	2.9 ~ 11.5	2440	620 ~ 3480	3.69	A
1.6 + 1.6 + 1.6 + 5.0 + 7.1	16.9	0.85	0.85	0.85	2.66	3.79	9.00	2.9 ~ 11.5	2510	660 ~ 3490	3.59	A
1.6 + 1.6 + 1.6 + 6.0 + 6.0	16.8	0.86	0.86	0.86	3.21	3.21	9.00	2.9 ~ 11.5	2440	620 ~ 3480	3.69	A
1.6 + 1.6 + 1.6 + 6.0 + 7.1	17.9	0.80	0.80	0.80	3.02	3.58	9.00	2.9 ~ 11.5	2510	660 ~ 3490	3.59	A
1.6 + 1.6 + 2.0 + 2.0 + 2.0	9.2	1.56	1.56	1.96	1.96	1.96	9.00	2.9 ~ 11.5	2450	450 ~ 3740	3.67	A
1.6 + 1.6 + 2.0 + 2.0 + 2.5	9.7	1.48	1.48	1.86	1.86	2.32	9.00	2.9 ~ 11.5	2450	450 ~ 3740	3.67	A
1.6 + 1.6 + 2.0 + 2.0 + 3.5	10.7	1.35	1.35	1.68	1.68	2.94	9.00	2.9 ~ 11.5	2450	480 ~ 3740	3.67	A
1.6 + 1.6 + 2.0 + 2.0 + 4.2	11.4	1.26	1.26	1.58	1.58	3.32	9.00	2.9 ~ 11.5	2450	480 ~ 3660	3.67	A
1.6 + 1.6 + 2.0 + 2.0 + 5.0	12.2	1.18	1.18	1.48	1.48	3.68	9.00	2.9 ~ 11.5	2410	530 ~ 3530	3.73	A
1.6 + 1.6 + 2.0 + 2.0 + 6.0	13.2	1.09	1.09	1.36	1.36	4.10	9.00	2.9 ~ 11.5	2410	530 ~ 3530	3.73	A
1.6 + 1.6 + 2.0 + 2.0 + 7.1	14.3	1.01	1.01	1.26	1.26	4.46	9.00	2.9 ~ 11.5	2420	570 ~ 3530	3.72	A
1.6 + 1.6 + 2.0 + 2.5 + 2.5	10.2	1.41	1.41	1.76	2.21	2.21	9.00	2.9 ~ 11.5	2450	450 ~ 3740	3.67	A
1.6 + 1.6 + 2.0 + 2.5 + 3.5	11.2	1.29	1.29	1.61	2.01	2.80	9.00	2.9 ~ 11.5	2450	480 ~ 3740	3.67	A
1.6 + 1.6 + 2.0 + 2.5 + 4.2	11.9	1.21	1.21	1.51	1.89	3.18	9.00	2.9 ~ 11.5	2450	480 ~ 3660	3.67	A
1.6 + 1.6 + 2.0 + 2.5 + 5.0	12.7	1.13	1.13	1.42	1.77	3.55	9.00	2.9 ~ 11.5	2410	530 ~ 3530	3.73	A
1.6 + 1.6 + 2.0 + 2.5 + 6.0	13.7	1.05	1.05	1.31	1.64	3.95	9.00	2.9 ~ 11.5	2410	530 ~ 3530	3.73	A
1.6 + 1.6 + 2.0 + 2.5 + 7.1	14.8	0.97	0.97	1.22	1.52	4.32	9.00	2.9 ~ 11.5	2420	570 ~ 3530	3.72	A
1.6 + 1.6 + 2.0 + 3.5 + 3.5	12.2	1.18	1.18	1.48	2.58	2.58	9.00	2.9 ~ 11.5	2460	490 ~ 3660	3.66	A
1.6 + 1.6 + 2.0 + 3.5 + 4.2	12.9	1.12	1.12	1.40	2.44	2.92	9.00	2.9 ~ 11.5	2460	490 ~ 3660	3.66	A
1.6 + 1.6 + 2.0 + 3.5 + 5.0	13.7	1.05	1.05	1.31	2.30	3.29	9.00	2.9 ~ 11.5	2420	540 ~ 3530	3.72	A
1.6 + 1.6 + 2.0 + 3.5 + 6.0	14.7	0.98	0.98	1.22	2.14	3.68	9.00	2.9 ~ 11.5	2420	540 ~ 3530	3.72	A
1.6 + 1.6 + 2.0 + 3.5 + 7.1	15.8	0.91	0.91	1.14	1.99	4.05	9.00	2.9 ~ 11.5	2420	570 ~ 3540	3.72	A
1.6 + 1.6 + 2.0 + 4.2 + 4.2	13.6	1.06	1.06	1.32	2.78	2.78	9.00	2.9 ~ 11.5	2460	490 ~ 3670	3.66	A
1.6 + 1.6 + 2.0 + 4.2 + 5.0	14.4	1.00	1.00	1.25	2.63	3.12	9.00	2.9 ~ 11.5	2420	570 ~ 3530	3.72	A
1.6 + 1.6 + 2.0 + 4.2 + 6.0	15.4	0.94	0.94	1.17	2.45	3.50	9.00	2.9 ~ 11.5	2420	570 ~ 3530	3.72	A
1.6 + 1.6 + 2.0 + 4.2 + 7.1	16.5	0.87	0.87	1.09	2.29	3.88	9.00	2.9 ~ 11.5	2420	580 ~ 3540	3.72	A
1.6 + 1.6 + 2.0 + 5.0 + 5.0	15.2	0.95	0.95	1.18	2.96	2.96	9.00	2.9 ~ 11.5	2510	630 ~ 3480	3.59	A

5 Room

	Indoor unit capacity Cooling	Annual Energy Consumption (kWh)	Current 230V (A)	ERP				Moisture Removal Volume l/h
				Pdesign (kW)	SEER		Annual Consumption (kWh)	
					W/W	CLASS		
5 Room	1.6 + 1.6 + 1.6 + 1.6 + 1.6	1060	10.1	8.00	6.00	A+	467	1.0 + 1.0 + 1.0 + 1.0 + 1.0
	1.6 + 1.6 + 1.6 + 1.6 + 2.0	1115	10.7	8.40	6.00	A+	490	1.0 + 1.0 + 1.0 + 1.0 + 1.3
	1.6 + 1.6 + 1.6 + 1.6 + 2.5	1225	11.7	9.00	6.00	A+	525	1.0 + 1.0 + 1.0 + 1.0 + 1.5
	1.6 + 1.6 + 1.6 + 1.6 + 3.5	1225	11.7	9.00	6.00	A+	525	0.9 + 0.9 + 0.9 + 0.9 + 1.8
	1.6 + 1.6 + 1.6 + 1.6 + 4.2	1225	11.7	9.00	6.00	A+	525	0.9 + 0.9 + 0.9 + 0.9 + 2.1
	1.6 + 1.6 + 1.6 + 1.6 + 5.0	1205	11.5	9.00	6.00	A+	525	0.8 + 0.8 + 0.8 + 0.8 + 2.3
	1.6 + 1.6 + 1.6 + 1.6 + 6.0	1205	11.5	9.00	6.00	A+	525	0.7 + 0.7 + 0.7 + 0.7 + 2.4
	1.6 + 1.6 + 1.6 + 1.6 + 7.1	1205	11.5	9.00	6.00	A+	525	0.7 + 0.7 + 0.7 + 0.7 + 2.5
	1.6 + 1.6 + 1.6 + 2.0 + 2.0	1195	11.4	8.80	6.00	A+	513	1.0 + 1.0 + 1.0 + 1.3 + 1.3
	1.6 + 1.6 + 1.6 + 2.0 + 2.5	1225	11.7	9.00	6.00	A+	525	1.0 + 1.0 + 1.0 + 1.3 + 1.5
	1.6 + 1.6 + 1.6 + 2.0 + 3.5	1225	11.7	9.00	6.00	A+	525	0.9 + 0.9 + 0.9 + 1.1 + 1.7
	1.6 + 1.6 + 1.6 + 2.0 + 4.2	1225	11.7	9.00	6.00	A+	525	0.8 + 0.8 + 0.8 + 1.0 + 2.0
	1.6 + 1.6 + 1.6 + 2.0 + 5.0	1205	11.5	9.00	6.00	A+	525	0.8 + 0.8 + 0.8 + 1.0 + 2.2
	1.6 + 1.6 + 1.6 + 2.0 + 6.0	1205	11.5	9.00	6.00	A+	525	0.7 + 0.7 + 0.7 + 0.9 + 2.4
	1.6 + 1.6 + 1.6 + 2.0 + 7.1	1210	11.6	9.00	6.00	A+	525	0.7 + 0.7 + 0.7 + 0.8 + 2.5
	1.6 + 1.6 + 1.6 + 2.5 + 2.5	1225	11.7	8.99	6.00	A+	524	0.9 + 0.9 + 0.9 + 1.5 + 1.5
	1.6 + 1.6 + 1.6 + 2.5 + 3.5	1225	11.7	9.00	6.00	A+	525	0.8 + 0.8 + 0.8 + 1.3 + 1.7
	1.6 + 1.6 + 1.6 + 2.5 + 4.2	1225	11.7	9.00	6.00	A+	525	0.8 + 0.8 + 0.8 + 1.3 + 1.9
	1.6 + 1.6 + 1.6 + 2.5 + 5.0	1205	11.5	9.00	6.00	A+	525	0.7 + 0.7 + 0.7 + 1.2 + 2.1
	1.6 + 1.6 + 1.6 + 2.5 + 6.0	1205	11.5	9.00	6.00	A+	525	0.7 + 0.7 + 0.7 + 1.1 + 2.3
	1.6 + 1.6 + 1.6 + 2.5 + 7.1	1210	11.6	9.00	6.00	A+	525	0.7 + 0.7 + 0.7 + 1.0 + 2.5
	1.6 + 1.6 + 1.6 + 3.5 + 3.5	1230	11.8	9.00	6.00	A+	525	0.8 + 0.8 + 0.8 + 1.6 + 1.6
	1.6 + 1.6 + 1.6 + 3.5 + 4.2	1230	11.8	9.00	6.00	A+	525	0.7 + 0.7 + 0.7 + 1.5 + 1.7
	1.6 + 1.6 + 1.6 + 3.5 + 5.0	1210	11.6	9.00	6.00	A+	525	0.7 + 0.7 + 0.7 + 1.5 + 1.9
	1.6 + 1.6 + 1.6 + 3.5 + 6.0	1210	11.6	9.00	6.00	A+	525	0.7 + 0.7 + 0.7 + 1.4 + 2.2
	1.6 + 1.6 + 1.6 + 3.5 + 7.1	1210	11.6	9.00	6.00	A+	525	0.7 + 0.7 + 0.7 + 1.3 + 2.3
	1.6 + 1.6 + 1.6 + 4.2 + 4.2	1230	11.8	8.99	6.00	A+	524	0.7 + 0.7 + 0.7 + 1.7 + 1.7
	1.6 + 1.6 + 1.6 + 4.2 + 5.0	1210	11.6	9.00	6.00	A+	525	0.7 + 0.7 + 0.7 + 1.6 + 1.8
	1.6 + 1.6 + 1.6 + 4.2 + 6.0	1210	11.6	9.00	6.00	A+	525	0.7 + 0.7 + 0.7 + 1.5 + 2.1
	1.6 + 1.6 + 1.6 + 4.2 + 7.1	1210	11.6	9.00	6.00	A+	525	0.7 + 0.7 + 0.7 + 1.5 + 2.3
	1.6 + 1.6 + 1.6 + 5.0 + 5.0	1220	11.7	9.00	6.00	A+	525	0.7 + 0.7 + 0.7 + 1.7 + 1.7
	1.6 + 1.6 + 1.6 + 5.0 + 6.0	1220	11.7	9.00	6.00	A+	525	0.7 + 0.7 + 0.7 + 1.7 + 2.0
	1.6 + 1.6 + 1.6 + 5.0 + 7.1	1255	12.0	9.00	6.00	A+	525	0.7 + 0.7 + 0.7 + 1.6 + 2.2
	1.6 + 1.6 + 1.6 + 6.0 + 6.0	1220	11.7	9.00	6.00	A+	525	0.7 + 0.7 + 0.7 + 1.8 + 1.8
	1.6 + 1.6 + 1.6 + 6.0 + 7.1	1255	12.0	9.00	6.00	A+	525	0.7 + 0.7 + 0.7 + 1.7 + 2.1
	1.6 + 1.6 + 2.0 + 2.0 + 2.0	1225	11.7	9.00	6.00	A+	525	1.0 + 1.0 + 1.3 + 1.3 + 1.3
	1.6 + 1.6 + 2.0 + 2.0 + 2.5	1225	11.7	9.00	6.00	A+	525	0.9 + 0.9 + 1.2 + 1.2 + 1.5
	1.6 + 1.6 + 2.0 + 2.0 + 3.5	1225	11.7	9.00	6.00	A+	525	0.9 + 0.9 + 1.1 + 1.1 + 1.7
	1.6 + 1.6 + 2.0 + 2.0 + 4.2	1225	11.7	9.00	6.00	A+	525	0.8 + 0.8 + 1.0 + 1.0 + 1.9
	1.6 + 1.6 + 2.0 + 2.0 + 5.0	1205	11.5	9.00	6.00	A+	525	0.7 + 0.7 + 0.9 + 0.9 + 2.1
1.6 + 1.6 + 2.0 + 2.0 + 6.0	1205	11.5	9.00	6.00	A+	525	0.7 + 0.7 + 0.9 + 0.9 + 2.3	
1.6 + 1.6 + 2.0 + 2.0 + 7.1	1210	11.6	9.00	6.00	A+	525	0.7 + 0.7 + 0.8 + 0.8 + 2.5	
1.6 + 1.6 + 2.0 + 2.5 + 2.5	1225	11.7	9.00	6.00	A+	525	0.9 + 0.9 + 1.1 + 1.4 + 1.4	
1.6 + 1.6 + 2.0 + 2.5 + 3.5	1225	11.7	9.00	6.00	A+	525	0.8 + 0.8 + 1.0 + 1.3 + 1.6	
1.6 + 1.6 + 2.0 + 2.5 + 4.2	1225	11.7	9.00	6.00	A+	525	0.8 + 0.8 + 1.0 + 1.2 + 1.8	
1.6 + 1.6 + 2.0 + 2.5 + 5.0	1205	11.5	9.00	6.00	A+	525	0.7 + 0.7 + 0.9 + 1.1 + 2.1	
1.6 + 1.6 + 2.0 + 2.5 + 6.0	1205	11.5	9.00	6.00	A+	525	0.7 + 0.7 + 0.8 + 1.0 + 2.3	
1.6 + 1.6 + 2.0 + 2.5 + 7.1	1210	11.6	9.00	6.00	A+	525	0.7 + 0.7 + 0.8 + 1.0 + 2.4	
1.6 + 1.6 + 2.0 + 3.5 + 3.5	1230	11.8	9.00	6.00	A+	525	0.7 + 0.7 + 0.9 + 1.6 + 1.6	
1.6 + 1.6 + 2.0 + 3.5 + 4.2	1230	11.8	9.00	6.00	A+	525	0.7 + 0.7 + 0.9 + 1.5 + 1.7	
1.6 + 1.6 + 2.0 + 3.5 + 5.0	1210	11.6	9.00	6.00	A+	525	0.7 + 0.7 + 0.8 + 1.5 + 1.9	
1.6 + 1.6 + 2.0 + 3.5 + 6.0	1210	11.6	9.00	6.00	A+	525	0.7 + 0.7 + 0.8 + 1.4 + 2.1	
1.6 + 1.6 + 2.0 + 3.5 + 7.1	1210	11.6	9.00	6.00	A+	525	0.7 + 0.7 + 0.7 + 1.3 + 2.3	
1.6 + 1.6 + 2.0 + 4.2 + 4.2	1230	11.8	9.00	6.00	A+	525	0.7 + 0.7 + 0.8 + 1.6 + 1.6	
1.6 + 1.6 + 2.0 + 4.2 + 5.0	1210	11.6	9.00	6.00	A+	525	0.7 + 0.7 + 0.8 + 1.6 + 1.8	
1.6 + 1.6 + 2.0 + 4.2 + 6.0	1210	11.6	9.00	6.00	A+	525	0.7 + 0.7 + 0.7 + 1.5 + 2.0	
1.6 + 1.6 + 2.0 + 4.2 + 7.1	1210	11.6	9.00	6.00	A+	525	0.7 + 0.7 + 0.7 + 1.5 + 2.3	
1.6 + 1.6 + 2.0 + 5.0 + 5.0	1255	12.0	9.00	6.00	A+	525	0.7 + 0.7 + 0.7 + 1.7 + 1.7	

Indoor unit capacity Cooling	Total	Cooling Capacity (kW)							Input Power (W)		EER	
		Room A	Room B	Room C	Room D	Room E	Total	min ~ max	Rating	min ~ max	WW	CLASS
1.6 + 1.6 + 2.0 + 5.0 + 6.0	16.2	0.89	0.89	1.11	2.78	3.33	9.00	2.9 ~ 11.5	2510	630 ~ 3480	3.59	A
1.6 + 1.6 + 2.0 + 5.0 + 7.1	17.3	0.83	0.83	1.04	2.60	3.70	9.00	2.9 ~ 11.5	2520	660 ~ 3490	3.57	A
1.6 + 1.6 + 2.0 + 6.0 + 6.0	17.2	0.84	0.84	1.04	3.14	3.14	9.00	2.9 ~ 11.5	2510	630 ~ 3480	3.59	A
1.6 + 1.6 + 2.0 + 6.0 + 7.1	18.3	0.79	0.79	0.98	2.95	3.49	9.00	2.9 ~ 11.5	2520	660 ~ 3490	3.57	A
1.6 + 1.6 + 2.5 + 2.5 + 2.5	10.7	1.35	1.35	2.10	2.10	2.10	9.00	2.9 ~ 11.5	2450	450 ~ 3740	3.67	A
1.6 + 1.6 + 2.5 + 2.5 + 3.5	11.7	1.23	1.23	1.92	1.92	2.70	9.00	2.9 ~ 11.5	2450	480 ~ 3740	3.67	A
1.6 + 1.6 + 2.5 + 2.5 + 4.2	12.4	1.16	1.16	1.81	1.81	3.06	9.00	2.9 ~ 11.5	2450	480 ~ 3660	3.67	A
1.6 + 1.6 + 2.5 + 2.5 + 5.0	13.2	1.09	1.09	1.70	1.70	3.42	9.00	2.9 ~ 11.5	2410	530 ~ 3530	3.73	A
1.6 + 1.6 + 2.5 + 2.5 + 6.0	14.2	1.01	1.01	1.58	1.58	3.82	9.00	2.9 ~ 11.5	2410	530 ~ 3530	3.73	A
1.6 + 1.6 + 2.5 + 2.5 + 7.1	15.3	0.94	0.94	1.47	1.47	4.18	9.00	2.9 ~ 11.5	2420	570 ~ 3530	3.72	A
1.6 + 1.6 + 2.5 + 3.5 + 3.5	12.7	1.13	1.13	1.78	2.48	2.48	9.00	2.9 ~ 11.5	2460	490 ~ 3660	3.66	A
1.6 + 1.6 + 2.5 + 3.5 + 4.2	13.4	1.07	1.07	1.68	2.35	2.83	9.00	2.9 ~ 11.5	2460	490 ~ 3660	3.66	A
1.6 + 1.6 + 2.5 + 3.5 + 5.0	14.2	1.01	1.01	1.58	2.22	3.18	9.00	2.9 ~ 11.5	2420	540 ~ 3530	3.72	A
1.6 + 1.6 + 2.5 + 3.5 + 6.0	15.2	0.95	0.95	1.48	2.07	3.55	9.00	2.9 ~ 11.5	2420	540 ~ 3530	3.72	A
1.6 + 1.6 + 2.5 + 3.5 + 7.1	16.3	0.88	0.88	1.38	1.93	3.93	9.00	2.9 ~ 11.5	2420	570 ~ 3540	3.72	A
1.6 + 1.6 + 2.5 + 4.2 + 4.2	14.1	1.02	1.02	1.60	2.68	2.68	9.00	2.9 ~ 11.5	2460	490 ~ 3670	3.66	A
1.6 + 1.6 + 2.5 + 4.2 + 5.0	14.9	0.97	0.97	1.51	2.54	3.01	9.00	2.9 ~ 11.5	2420	570 ~ 3530	3.72	A
1.6 + 1.6 + 2.5 + 4.2 + 6.0	15.9	0.91	0.91	1.42	2.38	3.38	9.00	2.9 ~ 11.5	2420	570 ~ 3530	3.72	A
1.6 + 1.6 + 2.5 + 4.2 + 7.1	17.0	0.85	0.85	1.32	2.22	3.76	9.00	2.9 ~ 11.5	2420	580 ~ 3540	3.72	A
1.6 + 1.6 + 2.5 + 5.0 + 5.0	15.7	0.92	0.92	1.42	2.87	2.87	9.00	2.9 ~ 11.5	2510	630 ~ 3480	3.59	A
1.6 + 1.6 + 2.5 + 5.0 + 6.0	16.7	0.86	0.86	1.35	2.69	3.24	9.00	2.9 ~ 11.5	2510	630 ~ 3480	3.59	A
1.6 + 1.6 + 2.5 + 5.0 + 7.1	17.8	0.81	0.81	1.26	2.53	3.59	9.00	2.9 ~ 11.5	2520	660 ~ 3490	3.57	A
1.6 + 1.6 + 2.5 + 6.0 + 6.0	17.7	0.81	0.81	1.28	3.05	3.05	9.00	2.9 ~ 11.5	2510	630 ~ 3480	3.59	A
1.6 + 1.6 + 3.5 + 3.5 + 3.5	13.7	1.05	1.05	2.30	2.30	2.30	9.00	2.9 ~ 11.5	2460	490 ~ 3670	3.66	A
1.6 + 1.6 + 3.5 + 3.5 + 4.2	14.4	1.00	1.00	2.19	2.19	2.62	9.00	2.9 ~ 11.5	2460	490 ~ 3670	3.66	A
1.6 + 1.6 + 3.5 + 3.5 + 5.0	15.2	0.95	0.95	2.07	2.07	2.96	9.00	2.9 ~ 11.5	2420	570 ~ 3530	3.72	A
1.6 + 1.6 + 3.5 + 3.5 + 6.0	16.2	0.89	0.89	1.94	1.94	3.34	9.00	2.9 ~ 11.5	2420	570 ~ 3530	3.72	A
1.6 + 1.6 + 3.5 + 3.5 + 7.1	17.3	0.83	0.83	1.82	1.82	3.70	9.00	2.9 ~ 11.5	2430	580 ~ 3540	3.70	A
1.6 + 1.6 + 3.5 + 4.2 + 4.2	15.1	0.95	0.95	2.10	2.50	2.50	9.00	2.9 ~ 11.5	2460	490 ~ 3590	3.66	A
1.6 + 1.6 + 3.5 + 4.2 + 5.0	15.9	0.91	0.91	1.98	2.38	2.82	9.00	2.9 ~ 11.5	2420	570 ~ 3540	3.72	A
1.6 + 1.6 + 3.5 + 4.2 + 6.0	16.9	0.85	0.85	1.86	2.24	3.20	9.00	2.9 ~ 11.5	2420	570 ~ 3540	3.72	A
1.6 + 1.6 + 3.5 + 4.2 + 7.1	18.0	0.80	0.80	1.75	2.10	3.55	9.00	2.9 ~ 11.5	2430	580 ~ 3540	3.70	A
1.6 + 1.6 + 3.5 + 5.0 + 5.0	16.7	0.86	0.86	1.90	2.69	2.69	9.00	2.9 ~ 11.5	2510	660 ~ 3490	3.59	A
1.6 + 1.6 + 3.5 + 5.0 + 6.0	17.7	0.81	0.81	1.78	2.54	3.06	9.00	2.9 ~ 11.5	2510	660 ~ 3490	3.59	A
1.6 + 1.6 + 4.2 + 4.2 + 4.2	15.8	0.91	0.91	2.39	2.39	2.39	8.99	2.9 ~ 11.5	2400	490 ~ 3590	3.75	A
1.6 + 1.6 + 4.2 + 4.2 + 5.0	16.6	0.87	0.87	2.28	2.28	2.70	9.00	2.9 ~ 11.5	2420	570 ~ 3540	3.72	A
1.6 + 1.6 + 4.2 + 4.2 + 6.0	17.6	0.82	0.82	2.15	2.15	3.06	9.00	2.9 ~ 11.5	2420	570 ~ 3540	3.72	A
1.6 + 1.6 + 4.2 + 5.0 + 5.0	17.4	0.83	0.83	2.16	2.59	2.59	9.00	2.9 ~ 11.5	2520	660 ~ 3490	3.57	A
1.6 + 1.6 + 5.0 + 5.0 + 5.0	18.2	0.79	0.79	2.47	2.47	2.47	8.99	2.9 ~ 11.5	2550	760 ~ 3520	3.53	A
1.6 + 2.0 + 2.0 + 2.0 + 2.0	9.6	1.48	1.88	1.88	1.88	1.88	9.00	2.9 ~ 11.5	2450	450 ~ 3740	3.67	A
1.6 + 2.0 + 2.0 + 2.0 + 2.5	10.1	1.43	1.78	1.78	1.78	2.23	9.00	2.9 ~ 11.5	2450	450 ~ 3740	3.67	A
1.6 + 2.0 + 2.0 + 2.0 + 3.5	11.1	1.30	1.62	1.62	1.62	2.84	9.00	2.9 ~ 11.5	2450	480 ~ 3660	3.67	A
1.6 + 2.0 + 2.0 + 2.0 + 4.2	11.8	1.22	1.53	1.53	1.53	3.19	9.00	2.9 ~ 11.5	2460	480 ~ 3660	3.66	A
1.6 + 2.0 + 2.0 + 2.0 + 5.0	12.6	1.14	1.43	1.43	1.43	3.57	9.00	2.9 ~ 11.5	2410	540 ~ 3530	3.73	A
1.6 + 2.0 + 2.0 + 2.0 + 6.0	13.6	1.06	1.32	1.32	1.32	3.98	9.00	2.9 ~ 11.5	2410	540 ~ 3530	3.73	A
1.6 + 2.0 + 2.0 + 2.0 + 7.1	14.7	0.98	1.22	1.22	1.22	4.36	9.00	2.9 ~ 11.5	2420	570 ~ 3530	3.72	A
1.6 + 2.0 + 2.0 + 2.5 + 2.5	10.6	1.36	1.70	1.70	2.12	2.12	9.00	2.9 ~ 11.5	2450	450 ~ 3740	3.67	A
1.6 + 2.0 + 2.0 + 2.5 + 3.5	11.6	1.24	1.55	1.55	1.94	2.72	9.00	2.9 ~ 11.5	2450	480 ~ 3660	3.67	A
1.6 + 2.0 + 2.0 + 2.5 + 4.2	12.3	1.17	1.46	1.46	1.83	3.08	9.00	2.9 ~ 11.5	2460	480 ~ 3660	3.66	A
1.6 + 2.0 + 2.0 + 2.5 + 5.0	13.1	1.10	1.37	1.37	1.72	3.44	9.00	2.9 ~ 11.5	2410	540 ~ 3530	3.73	A
1.6 + 2.0 + 2.0 + 2.5 + 6.0	14.1	1.02	1.28	1.28	1.60	3.82	9.00	2.9 ~ 11.5	2410	540 ~ 3530	3.73	A
1.6 + 2.0 + 2.0 + 2.5 + 7.1	15.2	0.95	1.18	1.18	1.48	4.21	9.00	2.9 ~ 11.5	2420	570 ~ 3530	3.72	A
1.6 + 2.0 + 2.0 + 3.5 + 3.5	12.6	1.14	1.43	1.43	2.50	2.50	9.00	2.9 ~ 11.5	2460	490 ~ 3660	3.66	A
1.6 + 2.0 + 2.0 + 3.5 + 4.2	13.3	1.08	1.35	1.35	2.37	2.85	9.00	2.9 ~ 11.5	2460	490 ~ 3670	3.66	A
1.6 + 2.0 + 2.0 + 3.5 + 5.0	14.1	1.02	1.28	1.28	2.23	3.19	9.00	2.9 ~ 11.5	2420	570 ~ 3530	3.72	A
1.6 + 2.0 + 2.0 + 3.5 + 6.0	15.1	0.95	1.19	1.19	2.09	3.58	9.00	2.9 ~ 11.5	2420	570 ~ 3530	3.72	A
1.6 + 2.0 + 2.0 + 3.5 + 7.1	16.2	0.89	1.11	1.11	1.94	3.95	9.00	2.9 ~ 11.5	2430	580 ~ 3540	3.70	A
1.6 + 2.0 + 2.0 + 4.2 + 4.2	14.0	1.02	1.29	1.29	2.70	2.70	9.00	2.9 ~ 11.5	2460	490 ~ 3670	3.66	A

5  
Room

	Indoor unit capacity Cooling	Annual Energy Consumption (kWh)	Current 230V (A)	ERP				Moisture Removal Volume l/h
				Pdesign (kW)	SEER		Annual Consumption (kWh)	
					W/W	CLASS		
5 Room	1.6 + 1.6 + 2.0 + 5.0 + 6.0	1255	12.0	9.00	6.00	A+	525	0.7 + 0.7 + 0.7 + 1.6 + 1.9
	1.6 + 1.6 + 2.0 + 5.0 + 7.1	1260	12.1	9.00	6.00	A+	525	0.7 + 0.7 + 0.7 + 1.6 + 2.2
	1.6 + 1.6 + 2.0 + 6.0 + 6.0	1255	12.0	9.00	6.00	A+	525	0.7 + 0.7 + 0.7 + 1.8 + 1.8
	1.6 + 1.6 + 2.0 + 6.0 + 7.1	1260	12.1	9.00	6.00	A+	525	0.7 + 0.7 + 0.7 + 1.7 + 2.0
	1.6 + 1.6 + 2.5 + 2.5 + 2.5	1225	11.7	9.00	6.00	A+	525	0.9 + 0.9 + 1.4 + 1.4 + 1.4
	1.6 + 1.6 + 2.5 + 2.5 + 3.5	1225	11.7	9.00	6.00	A+	525	0.8 + 0.8 + 1.2 + 1.2 + 1.6
	1.6 + 1.6 + 2.5 + 2.5 + 4.2	1225	11.7	9.00	6.00	A+	525	0.7 + 0.7 + 1.2 + 1.2 + 1.7
	1.6 + 1.6 + 2.5 + 2.5 + 5.0	1205	11.5	9.00	6.00	A+	525	0.7 + 0.7 + 1.1 + 1.1 + 2.0
	1.6 + 1.6 + 2.5 + 2.5 + 6.0	1205	11.5	9.00	6.00	A+	525	0.7 + 0.7 + 1.0 + 1.0 + 2.2
	1.6 + 1.6 + 2.5 + 2.5 + 7.1	1210	11.6	9.00	6.00	A+	525	0.7 + 0.7 + 0.9 + 0.9 + 2.4
	1.6 + 1.6 + 2.5 + 3.5 + 3.5	1230	11.8	9.00	6.00	A+	525	0.7 + 0.7 + 1.1 + 1.5 + 1.5
	1.6 + 1.6 + 2.5 + 3.5 + 4.2	1230	11.8	9.00	6.00	A+	525	0.7 + 0.7 + 1.1 + 1.5 + 1.7
	1.6 + 1.6 + 2.5 + 3.5 + 5.0	1210	11.6	9.00	6.00	A+	525	0.7 + 0.7 + 1.0 + 1.4 + 1.8
	1.6 + 1.6 + 2.5 + 3.5 + 6.0	1210	11.6	9.00	6.00	A+	525	0.7 + 0.7 + 0.9 + 1.3 + 2.1
	1.6 + 1.6 + 2.5 + 3.5 + 7.1	1210	11.6	9.00	6.00	A+	525	0.7 + 0.7 + 0.9 + 1.2 + 2.3
	1.6 + 1.6 + 2.5 + 4.2 + 4.2	1230	11.8	9.00	6.00	A+	525	0.7 + 0.7 + 1.0 + 1.6 + 1.6
	1.6 + 1.6 + 2.5 + 4.2 + 5.0	1210	11.6	9.00	6.00	A+	525	0.7 + 0.7 + 1.0 + 1.6 + 1.7
	1.6 + 1.6 + 2.5 + 4.2 + 6.0	1210	11.6	9.00	6.00	A+	525	0.7 + 0.7 + 0.9 + 1.5 + 1.9
	1.6 + 1.6 + 2.5 + 4.2 + 7.1	1210	11.6	9.00	6.00	A+	525	0.7 + 0.7 + 0.8 + 1.4 + 2.2
	1.6 + 1.6 + 2.5 + 5.0 + 5.0	1255	12.0	9.00	6.00	A+	525	0.7 + 0.7 + 0.9 + 1.7 + 1.7
	1.6 + 1.6 + 2.5 + 5.0 + 6.0	1255	12.0	9.00	6.00	A+	525	0.7 + 0.7 + 0.9 + 1.6 + 1.8
	1.6 + 1.6 + 2.5 + 5.0 + 7.1	1260	12.1	9.00	6.00	A+	525	0.7 + 0.7 + 0.8 + 1.6 + 2.1
	1.6 + 1.6 + 2.5 + 6.0 + 6.0	1255	12.0	9.00	6.00	A+	525	0.7 + 0.7 + 0.8 + 1.7 + 1.7
	1.6 + 1.6 + 3.5 + 3.5 + 3.5	1230	11.8	9.00	6.00	A+	525	0.7 + 0.7 + 1.5 + 1.5 + 1.5
	1.6 + 1.6 + 3.5 + 3.5 + 4.2	1230	11.8	9.00	6.00	A+	525	0.7 + 0.7 + 1.4 + 1.4 + 1.6
	1.6 + 1.6 + 3.5 + 3.5 + 5.0	1210	11.6	9.00	6.00	A+	525	0.7 + 0.7 + 1.3 + 1.3 + 1.7
	1.6 + 1.6 + 3.5 + 3.5 + 6.0	1210	11.6	9.00	6.00	A+	525	0.7 + 0.7 + 1.3 + 1.3 + 1.9
	1.6 + 1.6 + 3.5 + 3.5 + 7.1	1215	11.6	9.00	6.00	A+	525	0.7 + 0.7 + 1.2 + 1.2 + 2.2
	1.6 + 1.6 + 3.5 + 4.2 + 4.2	1230	11.8	9.00	6.00	A+	525	0.7 + 0.7 + 1.4 + 1.5 + 1.5
	1.6 + 1.6 + 3.5 + 4.2 + 5.0	1210	11.6	9.00	6.00	A+	525	0.7 + 0.7 + 1.3 + 1.5 + 1.7
	1.6 + 1.6 + 3.5 + 4.2 + 6.0	1210	11.6	9.00	6.00	A+	525	0.7 + 0.7 + 1.2 + 1.5 + 1.8
	1.6 + 1.6 + 3.5 + 4.2 + 7.1	1215	11.6	9.00	6.00	A+	525	0.7 + 0.7 + 1.1 + 1.4 + 2.1
	1.6 + 1.6 + 3.5 + 5.0 + 5.0	1255	12.0	9.00	6.00	A+	525	0.7 + 0.7 + 1.2 + 1.6 + 1.6
	1.6 + 1.6 + 3.5 + 5.0 + 6.0	1255	12.0	9.00	6.00	A+	525	0.7 + 0.7 + 1.1 + 1.6 + 1.7
	1.6 + 1.6 + 4.2 + 4.2 + 4.2	1200	11.5	8.99	6.00	A+	524	0.7 + 0.7 + 1.5 + 1.5 + 1.5
	1.6 + 1.6 + 4.2 + 4.2 + 5.0	1210	11.6	9.00	6.00	A+	525	0.7 + 0.7 + 1.5 + 1.5 + 1.6
	1.6 + 1.6 + 4.2 + 4.2 + 6.0	1210	11.6	9.00	6.00	A+	525	0.7 + 0.7 + 1.4 + 1.4 + 1.7
	1.6 + 1.6 + 4.2 + 5.0 + 5.0	1260	12.1	9.00	6.00	A+	525	0.7 + 0.7 + 1.4 + 1.6 + 1.6
	1.6 + 1.6 + 5.0 + 5.0 + 5.0	1275	12.2	8.99	6.00	A+	524	0.7 + 0.7 + 1.5 + 1.5 + 1.5
	1.6 + 2.0 + 2.0 + 2.0 + 2.0	1225	11.7	9.00	6.00	A+	525	0.9 + 1.2 + 1.2 + 1.2 + 1.2
	1.6 + 2.0 + 2.0 + 2.0 + 2.5	1225	11.7	9.00	6.00	A+	525	0.9 + 1.1 + 1.1 + 1.1 + 1.5
	1.6 + 2.0 + 2.0 + 2.0 + 3.5	1225	11.7	9.00	6.00	A+	525	0.8 + 1.0 + 1.0 + 1.0 + 1.7
	1.6 + 2.0 + 2.0 + 2.0 + 4.2	1230	11.8	9.00	6.00	A+	525	0.8 + 1.0 + 1.0 + 1.0 + 1.8
	1.6 + 2.0 + 2.0 + 2.0 + 5.0	1205	11.5	9.00	6.00	A+	525	0.7 + 0.9 + 0.9 + 0.9 + 2.1
	1.6 + 2.0 + 2.0 + 2.0 + 6.0	1205	11.5	9.00	6.00	A+	525	0.7 + 0.8 + 0.8 + 0.8 + 2.3
	1.6 + 2.0 + 2.0 + 2.0 + 7.1	1210	11.6	9.00	6.00	A+	525	0.7 + 0.8 + 0.8 + 0.8 + 2.4
	1.6 + 2.0 + 2.0 + 2.5 + 2.5	1225	11.7	9.00	6.00	A+	525	0.9 + 1.1 + 1.1 + 1.4 + 1.4
	1.6 + 2.0 + 2.0 + 2.5 + 3.5	1225	11.7	9.00	6.00	A+	525	0.8 + 1.0 + 1.0 + 1.3 + 1.6
	1.6 + 2.0 + 2.0 + 2.5 + 4.2	1230	11.8	9.00	6.00	A+	525	0.7 + 0.9 + 0.9 + 1.2 + 1.7
	1.6 + 2.0 + 2.0 + 2.5 + 5.0	1205	11.5	9.00	6.00	A+	525	0.7 + 0.9 + 0.9 + 1.1 + 2.0
1.6 + 2.0 + 2.0 + 2.5 + 6.0	1205	11.5	9.00	6.00	A+	525	0.7 + 0.8 + 0.8 + 1.0 + 2.2	
1.6 + 2.0 + 2.0 + 2.5 + 7.1	1210	11.6	9.00	6.00	A+	525	0.7 + 0.7 + 0.7 + 0.9 + 2.4	
1.6 + 2.0 + 2.0 + 3.5 + 3.5	1230	11.8	9.00	6.00	A+	525	0.7 + 0.9 + 0.9 + 1.5 + 1.5	
1.6 + 2.0 + 2.0 + 3.5 + 4.2	1230	11.8	9.00	6.00	A+	525	0.7 + 0.9 + 0.9 + 1.5 + 1.7	
1.6 + 2.0 + 2.0 + 3.5 + 5.0	1210	11.6	9.00	6.00	A+	525	0.7 + 0.8 + 0.8 + 1.5 + 1.8	
1.6 + 2.0 + 2.0 + 3.5 + 6.0	1210	11.6	9.00	6.00	A+	525	0.7 + 0.7 + 0.7 + 1.4 + 2.1	
1.6 + 2.0 + 2.0 + 3.5 + 7.1	1215	11.6	9.00	6.00	A+	525	0.7 + 0.7 + 0.7 + 1.3 + 2.3	
1.6 + 2.0 + 2.0 + 4.2 + 4.2	1230	11.8	9.00	6.00	A+	525	0.7 + 0.8 + 0.8 + 1.6 + 1.6	

Indoor unit capacity Cooling	Total	Cooling Capacity (kW)							Input Power (W)		EER	
		Room A	Room B	Room C	Room D	Room E	Total	min ~ max	Rating	min ~ max	WW	CLASS
1.6 + 2.0 + 2.0 + 4.2 + 5.0	14.8	0.97	1.22	1.22	2.55	3.04	9.00	2.9 ~ 11.5	2420	570 ~ 3530	3.72	A
1.6 + 2.0 + 2.0 + 4.2 + 6.0	15.8	0.91	1.14	1.14	2.39	3.42	9.00	2.9 ~ 11.5	2420	570 ~ 3530	3.72	A
1.6 + 2.0 + 2.0 + 4.2 + 7.1	16.9	0.85	1.07	1.07	2.24	3.77	9.00	2.9 ~ 11.5	2430	580 ~ 3540	3.70	A
1.6 + 2.0 + 2.0 + 5.0 + 5.0	15.6	0.94	1.15	1.15	2.88	2.88	9.00	2.9 ~ 11.5	2510	630 ~ 3480	3.59	A
1.6 + 2.0 + 2.0 + 5.0 + 6.0	16.6	0.87	1.08	1.08	2.71	3.26	9.00	2.9 ~ 11.5	2510	630 ~ 3480	3.59	A
1.6 + 2.0 + 2.0 + 5.0 + 7.1	17.7	0.81	1.02	1.02	2.54	3.61	9.00	2.9 ~ 11.5	2520	670 ~ 3490	3.57	A
1.6 + 2.0 + 2.0 + 6.0 + 6.0	17.6	0.82	1.02	1.02	3.07	3.07	9.00	2.9 ~ 11.5	2510	630 ~ 3480	3.59	A
1.6 + 2.0 + 2.5 + 2.5 + 2.5	11.1	1.29	1.62	2.03	2.03	2.03	9.00	2.9 ~ 11.5	2450	450 ~ 3740	3.67	A
1.6 + 2.0 + 2.5 + 2.5 + 3.5	12.1	1.19	1.49	1.86	1.86	2.60	9.00	2.9 ~ 11.5	2450	480 ~ 3660	3.67	A
1.6 + 2.0 + 2.5 + 2.5 + 4.2	12.8	1.13	1.41	1.76	1.76	2.94	9.00	2.9 ~ 11.5	2460	480 ~ 3660	3.66	A
1.6 + 2.0 + 2.5 + 2.5 + 5.0	13.6	1.06	1.32	1.65	1.65	3.32	9.00	2.9 ~ 11.5	2410	540 ~ 3530	3.73	A
1.6 + 2.0 + 2.5 + 2.5 + 6.0	14.6	0.99	1.23	1.54	1.54	3.70	9.00	2.9 ~ 11.5	2410	540 ~ 3530	3.73	A
1.6 + 2.0 + 2.5 + 2.5 + 7.1	15.7	0.92	1.15	1.43	1.43	4.07	9.00	2.9 ~ 11.5	2420	570 ~ 3530	3.72	A
1.6 + 2.0 + 2.5 + 3.5 + 3.5	13.1	1.10	1.37	1.73	2.40	2.40	9.00	2.9 ~ 11.5	2460	490 ~ 3660	3.66	A
1.6 + 2.0 + 2.5 + 3.5 + 4.2	13.8	1.04	1.30	1.63	2.28	2.75	9.00	2.9 ~ 11.5	2460	490 ~ 3670	3.66	A
1.6 + 2.0 + 2.5 + 3.5 + 5.0	14.6	0.99	1.23	1.54	2.16	3.08	9.00	2.9 ~ 11.5	2420	570 ~ 3530	3.72	A
1.6 + 2.0 + 2.5 + 3.5 + 6.0	15.6	0.92	1.15	1.44	2.02	3.47	9.00	2.9 ~ 11.5	2420	570 ~ 3530	3.72	A
1.6 + 2.0 + 2.5 + 3.5 + 7.1	16.7	0.86	1.08	1.35	1.89	3.82	9.00	2.9 ~ 11.5	2430	580 ~ 3540	3.70	A
1.6 + 2.0 + 2.5 + 4.2 + 4.2	14.5	0.99	1.24	1.55	2.61	2.61	9.00	2.9 ~ 11.5	2460	490 ~ 3670	3.66	A
1.6 + 2.0 + 2.5 + 4.2 + 5.0	15.3	0.94	1.18	1.47	2.47	2.94	9.00	2.9 ~ 11.5	2420	570 ~ 3530	3.72	A
1.6 + 2.0 + 2.5 + 4.2 + 6.0	16.3	0.88	1.10	1.38	2.32	3.32	9.00	2.9 ~ 11.5	2420	570 ~ 3530	3.72	A
1.6 + 2.0 + 2.5 + 4.2 + 7.1	17.4	0.83	1.03	1.29	2.17	3.68	9.00	2.9 ~ 11.5	2430	580 ~ 3540	3.70	A
1.6 + 2.0 + 2.5 + 5.0 + 5.0	16.1	0.89	1.12	1.39	2.80	2.80	9.00	2.9 ~ 11.5	2510	630 ~ 3480	3.59	A
1.6 + 2.0 + 2.5 + 5.0 + 6.0	17.1	0.84	1.05	1.32	2.63	3.16	9.00	2.9 ~ 11.5	2510	630 ~ 3480	3.59	A
1.6 + 2.0 + 2.5 + 5.0 + 7.1	18.2	0.79	0.99	1.24	2.47	3.51	9.00	2.9 ~ 11.5	2520	670 ~ 3490	3.57	A
1.6 + 2.0 + 2.5 + 6.0 + 6.0	18.1	0.80	0.99	1.25	2.98	2.98	9.00	2.9 ~ 11.5	2510	630 ~ 3480	3.59	A
1.6 + 2.0 + 3.5 + 3.5 + 3.5	14.1	1.02	1.29	2.23	2.23	2.23	9.00	2.9 ~ 11.5	2460	490 ~ 3590	3.66	A
1.6 + 2.0 + 3.5 + 3.5 + 4.2	14.8	0.97	1.22	2.13	2.13	2.55	9.00	2.9 ~ 11.5	2400	490 ~ 3590	3.75	A
1.6 + 2.0 + 3.5 + 3.5 + 5.0	15.6	0.92	1.15	2.02	2.02	2.89	9.00	2.9 ~ 11.5	2420	570 ~ 3540	3.72	A
1.6 + 2.0 + 3.5 + 3.5 + 6.0	16.6	0.87	1.08	1.90	1.90	3.25	9.00	2.9 ~ 11.5	2420	570 ~ 3540	3.72	A
1.6 + 2.0 + 3.5 + 3.5 + 7.1	17.7	0.81	1.02	1.78	1.78	3.61	9.00	2.9 ~ 11.5	2430	580 ~ 3540	3.70	A
1.6 + 2.0 + 3.5 + 4.2 + 4.2	15.5	0.93	1.16	2.03	2.44	2.44	9.00	2.9 ~ 11.5	2400	490 ~ 3590	3.75	A
1.6 + 2.0 + 3.5 + 4.2 + 5.0	16.3	0.88	1.10	1.93	2.32	2.77	9.00	2.9 ~ 11.5	2430	580 ~ 3540	3.70	A
1.6 + 2.0 + 3.5 + 4.2 + 6.0	17.3	0.83	1.04	1.82	2.18	3.13	9.00	2.9 ~ 11.5	2430	580 ~ 3540	3.70	A
1.6 + 2.0 + 3.5 + 5.0 + 5.0	17.1	0.84	1.05	1.85	2.63	2.63	9.00	2.9 ~ 11.5	2520	660 ~ 3490	3.57	A
1.6 + 2.0 + 3.5 + 5.0 + 6.0	18.1	0.80	0.99	1.74	2.49	2.98	9.00	2.9 ~ 11.5	2520	660 ~ 3490	3.57	A
1.6 + 2.0 + 4.2 + 4.2 + 4.2	16.2	0.89	1.12	2.33	2.33	2.33	9.00	2.9 ~ 11.5	2400	520 ~ 3590	3.75	A
1.6 + 2.0 + 4.2 + 4.2 + 5.0	17.0	0.85	1.06	2.22	2.22	2.65	9.00	2.9 ~ 11.5	2430	580 ~ 3540	3.70	A
1.6 + 2.0 + 4.2 + 4.2 + 6.0	18.0	0.80	1.00	2.10	2.10	3.00	9.00	2.9 ~ 11.5	2430	580 ~ 3540	3.70	A
1.6 + 2.0 + 4.2 + 5.0 + 5.0	17.8	0.81	1.01	2.12	2.53	2.53	9.00	2.9 ~ 11.5	2520	670 ~ 3490	3.57	A
1.6 + 2.5 + 2.5 + 2.5 + 2.5	11.6	1.24	1.94	1.94	1.94	1.94	9.00	2.9 ~ 11.5	2450	450 ~ 3740	3.67	A
1.6 + 2.5 + 2.5 + 2.5 + 3.5	12.6	1.14	1.79	1.79	1.79	2.49	9.00	2.9 ~ 11.5	2450	480 ~ 3660	3.67	A
1.6 + 2.5 + 2.5 + 2.5 + 4.2	13.3	1.08	1.69	1.69	1.69	2.85	9.00	2.9 ~ 11.5	2460	480 ~ 3660	3.66	A
1.6 + 2.5 + 2.5 + 2.5 + 5.0	14.1	1.02	1.60	1.60	1.60	3.18	9.00	2.9 ~ 11.5	2410	540 ~ 3530	3.73	A
1.6 + 2.5 + 2.5 + 2.5 + 6.0	15.1	0.95	1.49	1.49	1.49	3.58	9.00	2.9 ~ 11.5	2410	540 ~ 3530	3.73	A
1.6 + 2.5 + 2.5 + 2.5 + 7.1	16.2	0.89	1.39	1.39	1.39	3.94	9.00	2.9 ~ 11.5	2420	570 ~ 3530	3.72	A
1.6 + 2.5 + 2.5 + 3.5 + 3.5	13.6	1.06	1.65	1.65	2.32	2.32	9.00	2.9 ~ 11.5	2460	490 ~ 3660	3.66	A
1.6 + 2.5 + 2.5 + 3.5 + 4.2	14.3	1.01	1.57	1.57	2.20	2.65	9.00	2.9 ~ 11.5	2460	490 ~ 3670	3.66	A
1.6 + 2.5 + 2.5 + 3.5 + 5.0	15.1	0.95	1.49	1.49	2.09	2.98	9.00	2.9 ~ 11.5	2420	570 ~ 3530	3.72	A
1.6 + 2.5 + 2.5 + 3.5 + 6.0	16.1	0.89	1.40	1.40	1.96	3.35	9.00	2.9 ~ 11.5	2420	570 ~ 3530	3.72	A
1.6 + 2.5 + 2.5 + 3.5 + 7.1	17.2	0.84	1.31	1.31	1.83	3.71	9.00	2.9 ~ 11.5	2430	580 ~ 3540	3.70	A
1.6 + 2.5 + 2.5 + 4.2 + 4.2	15.0	0.96	1.50	1.50	2.52	2.52	9.00	2.9 ~ 11.5	2460	490 ~ 3670	3.66	A
1.6 + 2.5 + 2.5 + 4.2 + 5.0	15.8	0.91	1.42	1.42	2.39	2.86	9.00	2.9 ~ 11.5	2420	570 ~ 3530	3.72	A
1.6 + 2.5 + 2.5 + 4.2 + 6.0	16.8	0.86	1.34	1.34	2.25	3.21	9.00	2.9 ~ 11.5	2420	570 ~ 3530	3.72	A
1.6 + 2.5 + 2.5 + 4.2 + 7.1	17.9	0.80	1.26	1.26	2.11	3.57	9.00	2.9 ~ 11.5	2430	580 ~ 3540	3.70	A
1.6 + 2.5 + 2.5 + 5.0 + 5.0	16.6	0.86	1.36	1.36	2.71	2.71	9.00	2.9 ~ 11.5	2510	630 ~ 3480	3.59	A
1.6 + 2.5 + 2.5 + 5.0 + 6.0	17.6	0.82	1.28	1.28	2.56	3.06	9.00	2.9 ~ 11.5	2510	630 ~ 3480	3.59	A
1.6 + 2.5 + 3.5 + 3.5 + 3.5	14.6	0.99	1.53	2.16	2.16	2.16	9.00	2.9 ~ 11.5	2460	490 ~ 3590	3.66	A

5 Room



	Indoor unit capacity Cooling	Annual Energy Consumption (kWh)	Current 230V (A)	ERP				Moisture Removal Volume l/h
				Pdesign (kW)	SEER		Annual Consumption (kWh)	
					W/W	CLASS		
5 Room	1.6 + 2.0 + 2.0 + 4.2 + 5.0	1210	11.6	9.00	6.00	A+	525	0.7 + 0.8 + 0.8 + 1.6 + 1.7
	1.6 + 2.0 + 2.0 + 4.2 + 6.0	1210	11.6	9.00	6.00	A+	525	0.7 + 0.7 + 0.7 + 1.5 + 2.0
	1.6 + 2.0 + 2.0 + 4.2 + 7.1	1215	11.6	9.00	6.00	A+	525	0.7 + 0.7 + 0.7 + 1.5 + 2.2
	1.6 + 2.0 + 2.0 + 5.0 + 5.0	1255	12.0	9.00	6.00	A+	525	0.7 + 0.7 + 0.7 + 1.7 + 1.7
	1.6 + 2.0 + 2.0 + 5.0 + 6.0	1255	12.0	9.00	6.00	A+	525	0.7 + 0.7 + 0.7 + 1.6 + 1.9
	1.6 + 2.0 + 2.0 + 5.0 + 7.1	1260	12.1	9.00	6.00	A+	525	0.7 + 0.7 + 0.7 + 1.6 + 2.1
	1.6 + 2.0 + 2.0 + 6.0 + 6.0	1255	12.0	9.00	6.00	A+	525	0.7 + 0.7 + 0.7 + 1.7 + 1.7
	1.6 + 2.0 + 2.5 + 2.5 + 2.5	1225	11.7	9.00	6.00	A+	525	0.8 + 1.0 + 1.3 + 1.3 + 1.3
	1.6 + 2.0 + 2.5 + 2.5 + 3.5	1225	11.7	9.00	6.00	A+	525	0.7 + 0.9 + 1.2 + 1.2 + 1.6
	1.6 + 2.0 + 2.5 + 2.5 + 4.2	1230	11.8	9.00	6.00	A+	525	0.7 + 0.9 + 1.1 + 1.1 + 1.7
	1.6 + 2.0 + 2.5 + 2.5 + 5.0	1205	11.5	9.00	6.00	A+	525	0.7 + 0.8 + 1.1 + 1.1 + 1.9
	1.6 + 2.0 + 2.5 + 2.5 + 6.0	1205	11.5	9.00	6.00	A+	525	0.7 + 0.8 + 1.0 + 1.0 + 2.2
	1.6 + 2.0 + 2.5 + 2.5 + 7.1	1210	11.6	9.00	6.00	A+	525	0.7 + 0.7 + 0.9 + 0.9 + 2.3
	1.6 + 2.0 + 2.5 + 3.5 + 3.5	1230	11.8	9.00	6.00	A+	525	0.7 + 0.9 + 1.1 + 1.5 + 1.5
	1.6 + 2.0 + 2.5 + 3.5 + 4.2	1230	11.8	9.00	6.00	A+	525	0.7 + 0.8 + 1.0 + 1.5 + 1.6
	1.6 + 2.0 + 2.5 + 3.5 + 5.0	1210	11.6	9.00	6.00	A+	525	0.7 + 0.8 + 1.0 + 1.4 + 1.7
	1.6 + 2.0 + 2.5 + 3.5 + 6.0	1210	11.6	9.00	6.00	A+	525	0.7 + 0.7 + 0.9 + 1.3 + 2.0
	1.6 + 2.0 + 2.5 + 3.5 + 7.1	1215	11.6	9.00	6.00	A+	525	0.7 + 0.7 + 0.9 + 1.2 + 2.2
	1.6 + 2.0 + 2.5 + 4.2 + 4.2	1230	11.8	9.00	6.00	A+	525	0.7 + 0.8 + 1.0 + 1.6 + 1.6
	1.6 + 2.0 + 2.5 + 4.2 + 5.0	1210	11.6	9.00	6.00	A+	525	0.7 + 0.7 + 0.9 + 1.5 + 1.7
	1.6 + 2.0 + 2.5 + 4.2 + 6.0	1210	11.6	9.00	6.00	A+	525	0.7 + 0.7 + 0.9 + 1.5 + 1.9
	1.6 + 2.0 + 2.5 + 4.2 + 7.1	1215	11.6	9.00	6.00	A+	525	0.7 + 0.7 + 0.8 + 1.4 + 2.1
	1.6 + 2.0 + 2.5 + 5.0 + 5.0	1255	12.0	9.00	6.00	A+	525	0.7 + 0.7 + 0.9 + 1.6 + 1.6
	1.6 + 2.0 + 2.5 + 5.0 + 6.0	1255	12.0	9.00	6.00	A+	525	0.7 + 0.7 + 0.8 + 1.6 + 1.8
	1.6 + 2.0 + 2.5 + 5.0 + 7.1	1260	12.1	9.00	6.00	A+	525	0.7 + 0.7 + 0.8 + 1.5 + 2.0
	1.6 + 2.0 + 2.5 + 6.0 + 6.0	1255	12.0	9.00	6.00	A+	525	0.7 + 0.7 + 0.8 + 1.7 + 1.7
	1.6 + 2.0 + 3.5 + 3.5 + 3.5	1230	11.8	9.00	6.00	A+	525	0.7 + 0.8 + 1.5 + 1.5 + 1.5
	1.6 + 2.0 + 3.5 + 3.5 + 4.2	1200	11.5	9.00	6.00	A+	525	0.7 + 0.8 + 1.4 + 1.4 + 1.6
	1.6 + 2.0 + 3.5 + 3.5 + 5.0	1210	11.6	9.00	6.00	A+	525	0.7 + 0.7 + 1.3 + 1.3 + 1.7
	1.6 + 2.0 + 3.5 + 3.5 + 6.0	1210	11.6	9.00	6.00	A+	525	0.7 + 0.7 + 1.2 + 1.2 + 1.8
	1.6 + 2.0 + 3.5 + 3.5 + 7.1	1215	11.6	9.00	6.00	A+	525	0.7 + 0.7 + 1.1 + 1.1 + 2.1
	1.6 + 2.0 + 3.5 + 4.2 + 4.2	1200	11.5	9.00	6.00	A+	525	0.7 + 0.7 + 1.3 + 1.5 + 1.5
	1.6 + 2.0 + 3.5 + 4.2 + 5.0	1215	11.6	9.00	6.00	A+	525	0.7 + 0.7 + 1.2 + 1.5 + 1.6
	1.6 + 2.0 + 3.5 + 4.2 + 6.0	1215	11.6	9.00	6.00	A+	525	0.7 + 0.7 + 1.2 + 1.4 + 1.8
	1.6 + 2.0 + 3.5 + 5.0 + 5.0	1260	12.1	9.00	6.00	A+	525	0.7 + 0.7 + 1.2 + 1.6 + 1.6
	1.6 + 2.0 + 3.5 + 5.0 + 6.0	1260	12.1	9.00	6.00	A+	525	0.7 + 0.7 + 1.1 + 1.5 + 1.7
	1.6 + 2.0 + 4.2 + 4.2 + 4.2	1200	11.5	9.00	6.00	A+	525	0.7 + 0.7 + 1.5 + 1.5 + 1.5
	1.6 + 2.0 + 4.2 + 4.2 + 5.0	1215	11.6	9.00	6.00	A+	525	0.7 + 0.7 + 1.4 + 1.4 + 1.6
	1.6 + 2.0 + 4.2 + 4.2 + 6.0	1215	11.6	9.00	6.00	A+	525	0.7 + 0.7 + 1.4 + 1.4 + 1.7
	1.6 + 2.0 + 4.2 + 5.0 + 5.0	1260	12.1	9.00	6.00	A+	525	0.7 + 0.7 + 1.4 + 1.6 + 1.6
	1.6 + 2.5 + 2.5 + 2.5 + 2.5	1225	11.7	9.00	6.00	A+	525	0.8 + 1.3 + 1.3 + 1.3 + 1.3
	1.6 + 2.5 + 2.5 + 2.5 + 3.5	1225	11.7	9.00	6.00	A+	525	0.7 + 1.2 + 1.2 + 1.2 + 1.5
	1.6 + 2.5 + 2.5 + 2.5 + 4.2	1230	11.8	9.00	6.00	A+	525	0.7 + 1.1 + 1.1 + 1.1 + 1.7
	1.6 + 2.5 + 2.5 + 2.5 + 5.0	1205	11.5	9.00	6.00	A+	525	0.7 + 1.0 + 1.0 + 1.0 + 1.8
	1.6 + 2.5 + 2.5 + 2.5 + 6.0	1205	11.5	9.00	6.00	A+	525	0.7 + 0.9 + 0.9 + 0.9 + 2.1
1.6 + 2.5 + 2.5 + 2.5 + 7.1	1210	11.6	9.00	6.00	A+	525	0.7 + 0.9 + 0.9 + 0.9 + 2.3	
1.6 + 2.5 + 2.5 + 3.5 + 3.5	1230	11.8	9.00	6.00	A+	525	0.7 + 1.1 + 1.1 + 1.5 + 1.5	
1.6 + 2.5 + 2.5 + 3.5 + 4.2	1230	11.8	9.00	6.00	A+	525	0.7 + 1.0 + 1.0 + 1.4 + 1.6	
1.6 + 2.5 + 2.5 + 3.5 + 5.0	1210	11.6	9.00	6.00	A+	525	0.7 + 0.9 + 0.9 + 1.4 + 1.7	
1.6 + 2.5 + 2.5 + 3.5 + 6.0	1210	11.6	9.00	6.00	A+	525	0.7 + 0.9 + 0.9 + 1.3 + 1.9	
1.6 + 2.5 + 2.5 + 3.5 + 7.1	1215	11.6	9.00	6.00	A+	525	0.7 + 0.8 + 0.8 + 1.2 + 2.2	
1.6 + 2.5 + 2.5 + 4.2 + 4.2	1230	11.8	9.00	6.00	A+	525	0.7 + 1.0 + 1.0 + 1.5 + 1.5	
1.6 + 2.5 + 2.5 + 4.2 + 5.0	1210	11.6	9.00	6.00	A+	525	0.7 + 0.9 + 0.9 + 1.5 + 1.7	
1.6 + 2.5 + 2.5 + 4.2 + 6.0	1210	11.6	9.00	6.00	A+	525	0.7 + 0.8 + 0.8 + 1.5 + 1.8	
1.6 + 2.5 + 2.5 + 4.2 + 7.1	1215	11.6	9.00	6.00	A+	525	0.7 + 0.8 + 0.8 + 1.4 + 2.1	
1.6 + 2.5 + 2.5 + 5.0 + 5.0	1255	12.0	9.00	6.00	A+	525	0.7 + 0.9 + 0.9 + 1.6 + 1.6	
1.6 + 2.5 + 2.5 + 5.0 + 6.0	1255	12.0	9.00	6.00	A+	525	0.7 + 0.8 + 0.8 + 1.6 + 1.7	
1.6 + 2.5 + 3.5 + 3.5 + 3.5	1230	11.8	9.00	6.00	A+	525	0.7 + 1.0 + 1.4 + 1.4 + 1.4	

Indoor unit capacity Cooling	Total	Cooling Capacity (kW)							Input Power (W)		EER	
		Room A	Room B	Room C	Room D	Room E	Total	min ~ max	Rating	min ~ max	WW	CLASS
1.6 + 2.5 + 3.5 + 3.5 + 4.2	15.3	0.94	1.47	2.06	2.06	2.47	9.00	2.9 ~ 11.5	2400	490 ~ 3590	3.75	A
1.6 + 2.5 + 3.5 + 3.5 + 5.0	16.1	0.89	1.40	1.96	1.96	2.79	9.00	2.9 ~ 11.5	2420	570 ~ 3540	3.72	A
1.6 + 2.5 + 3.5 + 3.5 + 6.0	17.1	0.84	1.32	1.84	1.84	3.16	9.00	2.9 ~ 11.5	2420	570 ~ 3540	3.72	A
1.6 + 2.5 + 3.5 + 3.5 + 7.1	18.2	0.79	1.24	1.73	1.73	3.51	9.00	2.9 ~ 11.5	2430	580 ~ 3540	3.70	A
1.6 + 2.5 + 3.5 + 4.2 + 4.2	16.0	0.90	1.41	1.97	2.36	2.36	9.00	2.9 ~ 11.5	2400	490 ~ 3590	3.75	A
1.6 + 2.5 + 3.5 + 4.2 + 5.0	16.8	0.86	1.34	1.88	2.25	2.67	9.00	2.9 ~ 11.5	2430	580 ~ 3540	3.70	A
1.6 + 2.5 + 3.5 + 4.2 + 6.0	17.8	0.81	1.26	1.77	2.12	3.04	9.00	2.9 ~ 11.5	2430	580 ~ 3540	3.70	A
1.6 + 2.5 + 3.5 + 5.0 + 5.0	17.6	0.82	1.28	1.78	2.56	2.56	9.00	2.9 ~ 11.5	2520	660 ~ 3490	3.57	A
1.6 + 2.5 + 4.2 + 4.2 + 4.2	16.7	0.86	1.36	2.26	2.26	2.26	9.00	2.9 ~ 11.5	2400	520 ~ 3590	3.75	A
1.6 + 2.5 + 4.2 + 4.2 + 5.0	17.5	0.82	1.29	2.16	2.16	2.57	9.00	2.9 ~ 11.5	2430	580 ~ 3540	3.70	A
1.6 + 2.5 + 4.2 + 5.0 + 5.0	18.3	0.79	1.23	2.06	2.46	2.46	9.00	2.9 ~ 11.5	2520	670 ~ 3490	3.57	A
1.6 + 3.5 + 3.5 + 3.5 + 3.5	15.6	0.92	2.02	2.02	2.02	2.02	9.00	2.9 ~ 11.5	2400	520 ~ 3600	3.75	A
1.6 + 3.5 + 3.5 + 3.5 + 4.2	16.3	0.88	1.93	1.93	1.93	2.33	9.00	2.9 ~ 11.5	2410	520 ~ 3600	3.73	A
1.6 + 3.5 + 3.5 + 3.5 + 5.0	17.1	0.84	1.84	1.84	1.84	2.64	9.00	2.9 ~ 11.5	2430	580 ~ 3540	3.70	A
1.6 + 3.5 + 3.5 + 3.5 + 6.0	18.1	0.80	1.74	1.74	1.74	2.98	9.00	2.9 ~ 11.5	2430	580 ~ 3540	3.70	A
1.6 + 3.5 + 3.5 + 4.2 + 4.2	17.0	0.86	1.85	1.85	2.22	2.22	9.00	2.9 ~ 11.5	2410	530 ~ 3600	3.73	A
1.6 + 3.5 + 3.5 + 4.2 + 5.0	17.8	0.81	1.77	1.77	2.12	2.53	9.00	2.9 ~ 11.5	2430	580 ~ 3540	3.70	A
1.6 + 3.5 + 4.2 + 4.2 + 4.2	17.7	0.81	1.77	2.14	2.14	2.14	9.00	2.9 ~ 11.5	2410	530 ~ 3600	3.73	A
2.0 + 2.0 + 2.0 + 2.0 + 2.0	10.0	1.80	1.80	1.80	1.80	1.80	9.00	2.9 ~ 11.5	2450	480 ~ 3740	3.67	A
2.0 + 2.0 + 2.0 + 2.0 + 2.5	10.5	1.71	1.71	1.71	1.71	2.16	9.00	2.9 ~ 11.5	2450	480 ~ 3740	3.67	A
2.0 + 2.0 + 2.0 + 2.0 + 3.5	11.5	1.57	1.57	1.57	1.57	2.72	9.00	2.9 ~ 11.5	2460	480 ~ 3660	3.66	A
2.0 + 2.0 + 2.0 + 2.0 + 4.2	12.2	1.48	1.48	1.48	1.48	3.08	9.00	2.9 ~ 11.5	2460	490 ~ 3660	3.66	A
2.0 + 2.0 + 2.0 + 2.0 + 5.0	13.0	1.38	1.38	1.38	1.38	3.48	9.00	2.9 ~ 11.5	2420	540 ~ 3530	3.72	A
2.0 + 2.0 + 2.0 + 2.0 + 6.0	14.0	1.29	1.29	1.29	1.29	3.84	9.00	2.9 ~ 11.5	2420	540 ~ 3530	3.72	A
2.0 + 2.0 + 2.0 + 2.0 + 7.1	15.1	1.19	1.19	1.19	1.19	4.24	9.00	2.9 ~ 11.5	2420	570 ~ 3530	3.72	A
2.0 + 2.0 + 2.0 + 2.5 + 2.5	11.0	1.64	1.64	1.64	2.04	2.04	9.00	2.9 ~ 11.5	2450	480 ~ 3740	3.67	A
2.0 + 2.0 + 2.0 + 2.5 + 3.5	12.0	1.50	1.50	1.50	1.88	2.62	9.00	2.9 ~ 11.5	2460	480 ~ 3660	3.66	A
2.0 + 2.0 + 2.0 + 2.5 + 4.2	12.7	1.42	1.42	1.42	1.77	2.97	9.00	2.9 ~ 11.5	2460	490 ~ 3660	3.66	A
2.0 + 2.0 + 2.0 + 2.5 + 5.0	13.5	1.33	1.33	1.33	1.67	3.34	9.00	2.9 ~ 11.5	2420	540 ~ 3530	3.72	A
2.0 + 2.0 + 2.0 + 2.5 + 6.0	14.5	1.24	1.24	1.24	1.55	3.73	9.00	2.9 ~ 11.5	2420	540 ~ 3530	3.72	A
2.0 + 2.0 + 2.0 + 2.5 + 7.1	15.6	1.15	1.15	1.15	1.44	4.11	9.00	2.9 ~ 11.5	2420	570 ~ 3530	3.72	A
2.0 + 2.0 + 2.0 + 3.5 + 3.5	13.0	1.38	1.38	1.38	2.43	2.43	9.00	2.9 ~ 11.5	2460	490 ~ 3670	3.66	A
2.0 + 2.0 + 2.0 + 3.5 + 4.2	13.7	1.31	1.31	1.31	2.30	2.77	9.00	2.9 ~ 11.5	2460	490 ~ 3670	3.66	A
2.0 + 2.0 + 2.0 + 3.5 + 5.0	14.5	1.24	1.24	1.24	2.17	3.11	9.00	2.9 ~ 11.5	2420	570 ~ 3530	3.72	A
2.0 + 2.0 + 2.0 + 3.5 + 6.0	15.5	1.16	1.16	1.16	2.03	3.49	9.00	2.9 ~ 11.5	2420	570 ~ 3530	3.72	A
2.0 + 2.0 + 2.0 + 3.5 + 7.1	16.6	1.08	1.08	1.08	1.90	3.86	9.00	2.9 ~ 11.5	2430	580 ~ 3540	3.70	A
2.0 + 2.0 + 2.0 + 4.2 + 4.2	14.4	1.25	1.25	1.25	2.62	2.62	8.99	2.9 ~ 11.5	2400	490 ~ 3670	3.75	A
2.0 + 2.0 + 2.0 + 4.2 + 5.0	15.2	1.18	1.18	1.18	2.49	2.97	9.00	2.9 ~ 11.5	2420	570 ~ 3530	3.72	A
2.0 + 2.0 + 2.0 + 4.2 + 6.0	16.2	1.11	1.11	1.11	2.33	3.34	9.00	2.9 ~ 11.5	2420	570 ~ 3530	3.72	A
2.0 + 2.0 + 2.0 + 4.2 + 7.1	17.3	1.04	1.04	1.04	2.18	3.70	9.00	2.9 ~ 11.5	2430	580 ~ 3540	3.70	A
2.0 + 2.0 + 2.0 + 5.0 + 5.0	16.0	1.13	1.13	1.13	2.80	2.80	8.99	2.9 ~ 11.5	2510	660 ~ 3480	3.58	A
2.0 + 2.0 + 2.0 + 5.0 + 6.0	17.0	1.06	1.06	1.06	2.65	3.17	9.00	2.9 ~ 11.5	2510	660 ~ 3480	3.59	A
2.0 + 2.0 + 2.0 + 5.0 + 7.1	18.1	0.99	0.99	0.99	2.49	3.54	9.00	2.9 ~ 11.5	2520	670 ~ 3490	3.57	A
2.0 + 2.0 + 2.0 + 6.0 + 6.0	18.0	1.00	1.00	1.00	3.00	3.00	9.00	2.9 ~ 11.5	2510	660 ~ 3480	3.59	A
2.0 + 2.0 + 2.5 + 2.5 + 2.5	11.5	1.56	1.56	1.96	1.96	1.96	9.00	2.9 ~ 11.5	2450	480 ~ 3740	3.67	A
2.0 + 2.0 + 2.5 + 2.5 + 3.5	12.5	1.44	1.44	1.80	1.80	2.52	9.00	2.9 ~ 11.5	2460	480 ~ 3660	3.66	A
2.0 + 2.0 + 2.5 + 2.5 + 4.2	13.2	1.36	1.36	1.70	1.70	2.88	9.00	2.9 ~ 11.5	2460	490 ~ 3660	3.66	A
2.0 + 2.0 + 2.5 + 2.5 + 5.0	14.0	1.29	1.29	1.61	1.61	3.20	9.00	2.9 ~ 11.5	2420	540 ~ 3530	3.72	A
2.0 + 2.0 + 2.5 + 2.5 + 6.0	15.0	1.20	1.20	1.50	1.50	3.60	9.00	2.9 ~ 11.5	2420	540 ~ 3530	3.72	A
2.0 + 2.0 + 2.5 + 2.5 + 7.1	16.1	1.12	1.12	1.40	1.40	3.96	9.00	2.9 ~ 11.5	2420	570 ~ 3530	3.72	A
2.0 + 2.0 + 2.5 + 3.5 + 3.5	13.5	1.33	1.33	1.68	2.33	2.33	9.00	2.9 ~ 11.5	2460	490 ~ 3670	3.66	A
2.0 + 2.0 + 2.5 + 3.5 + 4.2	14.2	1.27	1.27	1.58	2.22	2.66	9.00	2.9 ~ 11.5	2460	490 ~ 3670	3.66	A
2.0 + 2.0 + 2.5 + 3.5 + 5.0	15.0	1.20	1.20	1.50	2.10	3.00	9.00	2.9 ~ 11.5	2420	570 ~ 3530	3.72	A
2.0 + 2.0 + 2.5 + 3.5 + 6.0	16.0	1.13	1.13	1.41	1.97	3.36	9.00	2.9 ~ 11.5	2420	570 ~ 3530	3.72	A
2.0 + 2.0 + 2.5 + 3.5 + 7.1	17.1	1.05	1.05	1.32	1.84	3.74	9.00	2.9 ~ 11.5	2430	580 ~ 3540	3.70	A
2.0 + 2.0 + 2.5 + 4.2 + 4.2	14.9	1.21	1.21	1.50	2.54	2.54	9.00	2.9 ~ 11.5	2460	490 ~ 3670	3.66	A
2.0 + 2.0 + 2.5 + 4.2 + 5.0	15.7	1.15	1.15	1.43	2.41	2.86	9.00	2.9 ~ 11.5	2420	570 ~ 3530	3.72	A
2.0 + 2.0 + 2.5 + 4.2 + 6.0	16.7	1.08	1.08	1.35	2.26	3.23	9.00	2.9 ~ 11.5	2420	570 ~ 3530	3.72	A

	Indoor unit capacity Cooling	Annual Energy Consumption (kWh)	Current 230V (A)	ERP				Moisture Removal Volume l/h
				Pdesign (kW)	SEER		Annual Consumption (kWh)	
					W/W	CLASS		
5 Room	1.6 + 2.5 + 3.5 + 3.5 + 4.2	1200	11.5	9.00	6.00	A+	525	0.7 + 0.9 + 1.3 + 1.3 + 1.5
	1.6 + 2.5 + 3.5 + 3.5 + 5.0	1210	11.6	9.00	6.00	A+	525	0.7 + 0.9 + 1.3 + 1.3 + 1.6
	1.6 + 2.5 + 3.5 + 3.5 + 6.0	1210	11.6	9.00	6.00	A+	525	0.7 + 0.8 + 1.2 + 1.2 + 1.8
	1.6 + 2.5 + 3.5 + 3.5 + 7.1	1215	11.6	9.00	6.00	A+	525	0.7 + 0.8 + 1.1 + 1.1 + 2.0
	1.6 + 2.5 + 3.5 + 4.2 + 4.2	1200	11.5	9.00	6.00	A+	525	0.7 + 0.9 + 1.3 + 1.5 + 1.5
	1.6 + 2.5 + 3.5 + 4.2 + 5.0	1215	11.6	9.00	6.00	A+	525	0.7 + 0.8 + 1.2 + 1.5 + 1.6
	1.6 + 2.5 + 3.5 + 4.2 + 6.0	1215	11.6	9.00	6.00	A+	525	0.7 + 0.8 + 1.1 + 1.4 + 1.7
	1.6 + 2.5 + 3.5 + 5.0 + 5.0	1260	12.1	9.00	6.00	A+	525	0.7 + 0.8 + 1.1 + 1.6 + 1.6
	1.6 + 2.5 + 4.2 + 4.2 + 4.2	1200	11.5	9.00	6.00	A+	525	0.7 + 0.9 + 1.5 + 1.5 + 1.5
	1.6 + 2.5 + 4.2 + 4.2 + 5.0	1215	11.6	9.00	6.00	A+	525	0.7 + 0.8 + 1.4 + 1.4 + 1.6
	1.6 + 2.5 + 4.2 + 5.0 + 5.0	1260	12.1	9.00	6.00	A+	525	0.7 + 0.8 + 1.3 + 1.5 + 1.5
	1.6 + 3.5 + 3.5 + 3.5 + 3.5	1200	11.5	9.00	6.00	A+	525	0.7 + 1.3 + 1.3 + 1.3 + 1.3
	1.6 + 3.5 + 3.5 + 3.5 + 4.2	1205	11.5	9.00	6.00	A+	525	0.7 + 1.2 + 1.2 + 1.2 + 1.5
	1.6 + 3.5 + 3.5 + 3.5 + 5.0	1215	11.6	9.00	6.00	A+	525	0.7 + 1.2 + 1.2 + 1.2 + 1.6
	1.6 + 3.5 + 3.5 + 3.5 + 6.0	1215	11.6	9.00	6.00	A+	525	0.7 + 1.1 + 1.1 + 1.1 + 1.7
	1.6 + 3.5 + 3.5 + 4.2 + 4.2	1205	11.5	9.00	6.00	A+	525	0.7 + 1.2 + 1.2 + 1.4 + 1.4
	1.6 + 3.5 + 3.5 + 4.2 + 5.0	1215	11.6	9.00	6.00	A+	525	0.7 + 1.1 + 1.1 + 1.4 + 1.6
	1.6 + 3.5 + 4.2 + 4.2 + 4.2	1205	11.5	9.00	6.00	A+	525	0.7 + 1.1 + 1.4 + 1.4 + 1.4
	2.0 + 2.0 + 2.0 + 2.0 + 2.0	1225	11.7	9.00	6.00	A+	525	1.2 + 1.2 + 1.2 + 1.2 + 1.2
	2.0 + 2.0 + 2.0 + 2.0 + 2.5	1225	11.7	9.00	6.00	A+	525	1.1 + 1.1 + 1.1 + 1.1 + 1.4
	2.0 + 2.0 + 2.0 + 2.0 + 3.5	1230	11.8	9.00	6.00	A+	525	1.0 + 1.0 + 1.0 + 1.0 + 1.6
	2.0 + 2.0 + 2.0 + 2.0 + 4.2	1230	11.8	9.00	6.00	A+	525	0.9 + 0.9 + 0.9 + 0.9 + 1.7
	2.0 + 2.0 + 2.0 + 2.0 + 5.0	1210	11.6	9.00	6.00	A+	525	0.9 + 0.9 + 0.9 + 0.9 + 2.0
	2.0 + 2.0 + 2.0 + 2.0 + 6.0	1210	11.6	9.00	6.00	A+	525	0.8 + 0.8 + 0.8 + 0.8 + 2.2
	2.0 + 2.0 + 2.0 + 2.0 + 7.1	1210	11.6	9.00	6.00	A+	525	0.7 + 0.7 + 0.7 + 0.7 + 2.4
	2.0 + 2.0 + 2.0 + 2.5 + 2.5	1225	11.7	9.00	6.00	A+	525	1.0 + 1.0 + 1.0 + 1.3 + 1.3
	2.0 + 2.0 + 2.0 + 2.5 + 3.5	1230	11.8	9.00	6.00	A+	525	1.0 + 1.0 + 1.0 + 1.2 + 1.6
	2.0 + 2.0 + 2.0 + 2.5 + 4.2	1230	11.8	9.00	6.00	A+	525	0.9 + 0.9 + 0.9 + 1.1 + 1.7
	2.0 + 2.0 + 2.0 + 2.5 + 5.0	1210	11.6	9.00	6.00	A+	525	0.8 + 0.8 + 0.8 + 1.1 + 1.9
	2.0 + 2.0 + 2.0 + 2.5 + 6.0	1210	11.6	9.00	6.00	A+	525	0.8 + 0.8 + 0.8 + 1.0 + 2.2
	2.0 + 2.0 + 2.0 + 2.5 + 7.1	1210	11.6	9.00	6.00	A+	525	0.7 + 0.7 + 0.7 + 0.9 + 2.3
	2.0 + 2.0 + 2.0 + 3.5 + 3.5	1230	11.8	9.00	6.00	A+	525	0.9 + 0.9 + 0.9 + 1.5 + 1.5
	2.0 + 2.0 + 2.0 + 3.5 + 4.2	1230	11.8	9.00	6.00	A+	525	0.8 + 0.8 + 0.8 + 1.5 + 1.6
	2.0 + 2.0 + 2.0 + 3.5 + 5.0	1210	11.6	9.00	6.00	A+	525	0.8 + 0.8 + 0.8 + 1.4 + 1.8
	2.0 + 2.0 + 2.0 + 3.5 + 6.0	1210	11.6	9.00	6.00	A+	525	0.7 + 0.7 + 0.7 + 1.3 + 2.0
	2.0 + 2.0 + 2.0 + 3.5 + 7.1	1215	11.6	9.00	6.00	A+	525	0.7 + 0.7 + 0.7 + 1.2 + 2.3
	2.0 + 2.0 + 2.0 + 4.2 + 4.2	1200	11.5	8.99	6.00	A+	524	0.8 + 0.8 + 0.8 + 1.6 + 1.6
	2.0 + 2.0 + 2.0 + 4.2 + 5.0	1210	11.6	9.00	6.00	A+	525	0.7 + 0.7 + 0.7 + 1.5 + 1.7
	2.0 + 2.0 + 2.0 + 4.2 + 6.0	1210	11.6	9.00	6.00	A+	525	0.7 + 0.7 + 0.7 + 1.5 + 1.9
	2.0 + 2.0 + 2.0 + 4.2 + 7.1	1215	11.6	9.00	6.00	A+	525	0.7 + 0.7 + 0.7 + 1.4 + 2.2
	2.0 + 2.0 + 2.0 + 5.0 + 5.0	1255	12.0	8.99	6.00	A+	524	0.7 + 0.7 + 0.7 + 1.6 + 1.6
	2.0 + 2.0 + 2.0 + 5.0 + 6.0	1255	12.0	9.00	6.00	A+	525	0.7 + 0.7 + 0.7 + 1.6 + 1.8
	2.0 + 2.0 + 2.0 + 5.0 + 7.1	1260	12.1	9.00	6.00	A+	525	0.7 + 0.7 + 0.7 + 1.5 + 2.0
	2.0 + 2.0 + 2.0 + 6.0 + 6.0	1255	12.0	9.00	6.00	A+	525	0.7 + 0.7 + 0.7 + 1.7 + 1.7
	2.0 + 2.0 + 2.5 + 2.5 + 2.5	1225	11.7	9.00	6.00	A+	525	1.0 + 1.0 + 1.3 + 1.3 + 1.3
	2.0 + 2.0 + 2.5 + 2.5 + 3.5	1230	11.8	9.00	6.00	A+	525	0.9 + 0.9 + 1.2 + 1.2 + 1.5
	2.0 + 2.0 + 2.5 + 2.5 + 4.2	1230	11.8	9.00	6.00	A+	525	0.9 + 0.9 + 1.1 + 1.1 + 1.7
	2.0 + 2.0 + 2.5 + 2.5 + 5.0	1210	11.6	9.00	6.00	A+	525	0.8 + 0.8 + 1.0 + 1.0 + 1.8
	2.0 + 2.0 + 2.5 + 2.5 + 6.0	1210	11.6	9.00	6.00	A+	525	0.7 + 0.7 + 1.0 + 1.0 + 2.1
	2.0 + 2.0 + 2.5 + 2.5 + 7.1	1210	11.6	9.00	6.00	A+	525	0.7 + 0.7 + 0.9 + 0.9 + 2.3
2.0 + 2.0 + 2.5 + 3.5 + 3.5	1230	11.8	9.00	6.00	A+	525	0.8 + 0.8 + 1.1 + 1.5 + 1.5	
2.0 + 2.0 + 2.5 + 3.5 + 4.2	1230	11.8	9.00	6.00	A+	525	0.8 + 0.8 + 1.0 + 1.4 + 1.6	
2.0 + 2.0 + 2.5 + 3.5 + 5.0	1210	11.6	9.00	6.00	A+	525	0.7 + 0.7 + 1.0 + 1.4 + 1.7	
2.0 + 2.0 + 2.5 + 3.5 + 6.0	1210	11.6	9.00	6.00	A+	525	0.7 + 0.7 + 0.9 + 1.3 + 1.9	
2.0 + 2.0 + 2.5 + 3.5 + 7.1	1215	11.6	9.00	6.00	A+	525	0.7 + 0.7 + 0.8 + 1.2 + 2.2	
2.0 + 2.0 + 2.5 + 4.2 + 4.2	1230	11.8	9.00	6.00	A+	525	0.8 + 0.8 + 1.0 + 1.6 + 1.6	
2.0 + 2.0 + 2.5 + 4.2 + 5.0	1210	11.6	9.00	6.00	A+	525	0.7 + 0.7 + 0.9 + 1.5 + 1.7	
2.0 + 2.0 + 2.5 + 4.2 + 6.0	1210	11.6	9.00	6.00	A+	525	0.7 + 0.7 + 0.9 + 1.5 + 1.8	

Indoor unit capacity Cooling		Total	Cooling Capacity (kW)							Input Power (W)		EER	
			Room A	Room B	Room C	Room D	Room E	Total	min ~ max	Rating	min ~ max	WW	CLASS
5 Room	2.0 + 2.0 + 2.5 + 4.2 + 7.1	17.8	1.01	1.01	1.26	2.12	3.60	9.00	2.9 ~ 11.5	2430	580 ~ 3540	3.70	A
	2.0 + 2.0 + 2.5 + 5.0 + 5.0	16.5	1.09	1.09	1.36	2.73	2.73	9.00	2.9 ~ 11.5	2510	660 ~ 3480	3.59	A
	2.0 + 2.0 + 2.5 + 5.0 + 6.0	17.5	1.03	1.03	1.29	2.57	3.08	9.00	2.9 ~ 11.5	2510	660 ~ 3480	3.59	A
	2.0 + 2.0 + 3.5 + 3.5 + 3.5	14.5	1.24	1.24	2.17	2.17	2.17	8.99	2.9 ~ 11.5	2400	490 ~ 3590	3.75	A
	2.0 + 2.0 + 3.5 + 3.5 + 4.2	15.2	1.18	1.18	2.07	2.07	2.50	9.00	2.9 ~ 11.5	2400	500 ~ 3590	3.75	A
	2.0 + 2.0 + 3.5 + 3.5 + 5.0	16.0	1.13	1.13	1.97	1.97	2.80	9.00	2.9 ~ 11.5	2430	580 ~ 3540	3.70	A
	2.0 + 2.0 + 3.5 + 3.5 + 6.0	17.0	1.06	1.06	1.85	1.85	3.18	9.00	2.9 ~ 11.5	2430	580 ~ 3540	3.70	A
	2.0 + 2.0 + 3.5 + 3.5 + 7.1	18.1	0.99	0.99	1.74	1.74	3.54	9.00	2.9 ~ 11.5	2430	610 ~ 3540	3.70	A
	2.0 + 2.0 + 3.5 + 4.2 + 4.2	15.9	1.13	1.13	1.98	2.38	2.38	9.00	2.9 ~ 11.5	2400	520 ~ 3600	3.75	A
	2.0 + 2.0 + 3.5 + 4.2 + 5.0	16.7	1.08	1.08	1.89	2.26	2.69	9.00	2.9 ~ 11.5	2430	580 ~ 3540	3.70	A
	2.0 + 2.0 + 3.5 + 4.2 + 6.0	17.7	1.02	1.02	1.78	2.14	3.04	9.00	2.9 ~ 11.5	2430	580 ~ 3540	3.70	A
	2.0 + 2.0 + 3.5 + 5.0 + 5.0	17.5	1.03	1.03	1.80	2.57	2.57	9.00	2.9 ~ 11.5	2520	670 ~ 3490	3.57	A
	2.0 + 2.0 + 4.2 + 4.2 + 4.2	16.6	1.08	1.08	2.28	2.28	2.28	9.00	2.9 ~ 11.5	2400	520 ~ 3600	3.75	A
	2.0 + 2.0 + 4.2 + 4.2 + 5.0	17.4	1.03	1.03	2.17	2.17	2.60	9.00	2.9 ~ 11.5	2430	580 ~ 3540	3.70	A
	2.0 + 2.0 + 4.2 + 5.0 + 5.0	18.2	0.99	0.99	2.08	2.47	2.47	9.00	2.9 ~ 11.5	2520	670 ~ 3490	3.57	A
	2.0 + 2.5 + 2.5 + 2.5 + 2.5	12.0	1.48	1.88	1.88	1.88	1.88	9.00	2.9 ~ 11.5	2450	480 ~ 3740	3.67	A
	2.0 + 2.5 + 2.5 + 2.5 + 3.5	13.0	1.38	1.73	1.73	1.73	2.43	9.00	2.9 ~ 11.5	2460	480 ~ 3660	3.66	A
	2.0 + 2.5 + 2.5 + 2.5 + 4.2	13.7	1.31	1.64	1.64	1.64	2.77	9.00	2.9 ~ 11.5	2460	490 ~ 3660	3.66	A
	2.0 + 2.5 + 2.5 + 2.5 + 5.0	14.5	1.24	1.55	1.55	1.55	3.11	9.00	2.9 ~ 11.5	2420	540 ~ 3530	3.72	A
	2.0 + 2.5 + 2.5 + 2.5 + 6.0	15.5	1.16	1.45	1.45	1.45	3.49	9.00	2.9 ~ 11.5	2420	540 ~ 3530	3.72	A
	2.0 + 2.5 + 2.5 + 2.5 + 7.1	16.6	1.08	1.36	1.36	1.36	3.84	9.00	2.9 ~ 11.5	2420	570 ~ 3530	3.72	A
	2.0 + 2.5 + 2.5 + 3.5 + 3.5	14.0	1.28	1.61	1.61	2.25	2.25	9.00	2.9 ~ 11.5	2460	490 ~ 3670	3.66	A
	2.0 + 2.5 + 2.5 + 3.5 + 4.2	14.7	1.22	1.53	1.53	2.14	2.58	9.00	2.9 ~ 11.5	2460	490 ~ 3670	3.66	A
	2.0 + 2.5 + 2.5 + 3.5 + 5.0	15.5	1.16	1.45	1.45	2.03	2.91	9.00	2.9 ~ 11.5	2420	570 ~ 3530	3.72	A
	2.0 + 2.5 + 2.5 + 3.5 + 6.0	16.5	1.09	1.36	1.36	1.91	3.28	9.00	2.9 ~ 11.5	2420	570 ~ 3530	3.72	A
	2.0 + 2.5 + 2.5 + 3.5 + 7.1	17.6	1.02	1.28	1.28	1.79	3.63	9.00	2.9 ~ 11.5	2430	580 ~ 3540	3.70	A
	2.0 + 2.5 + 2.5 + 4.2 + 4.2	15.4	1.18	1.46	1.46	2.45	2.45	9.00	2.9 ~ 11.5	2460	490 ~ 3670	3.66	A
	2.0 + 2.5 + 2.5 + 4.2 + 5.0	16.2	1.11	1.39	1.39	2.33	2.78	9.00	2.9 ~ 11.5	2420	570 ~ 3530	3.72	A
	2.0 + 2.5 + 2.5 + 4.2 + 6.0	17.2	1.05	1.31	1.31	2.20	3.13	9.00	2.9 ~ 11.5	2420	570 ~ 3530	3.72	A
	2.0 + 2.5 + 2.5 + 4.2 + 7.1	18.3	0.98	1.23	1.23	2.07	3.49	9.00	2.9 ~ 11.5	2430	580 ~ 3540	3.70	A
	2.0 + 2.5 + 2.5 + 5.0 + 5.0	17.0	1.06	1.32	1.32	2.65	2.65	9.00	2.9 ~ 11.5	2510	660 ~ 3480	3.59	A
	2.0 + 2.5 + 2.5 + 5.0 + 6.0	18.0	1.00	1.25	1.25	2.50	3.00	9.00	2.9 ~ 11.5	2510	660 ~ 3480	3.59	A
	2.0 + 2.5 + 3.5 + 3.5 + 3.5	15.0	1.20	1.50	2.10	2.10	2.10	9.00	2.9 ~ 11.5	2400	490 ~ 3590	3.75	A
	2.0 + 2.5 + 3.5 + 3.5 + 4.2	15.7	1.15	1.43	2.01	2.01	2.40	9.00	2.9 ~ 11.5	2400	500 ~ 3590	3.75	A
	2.0 + 2.5 + 3.5 + 3.5 + 5.0	16.5	1.09	1.36	1.91	1.91	2.73	9.00	2.9 ~ 11.5	2430	580 ~ 3540	3.70	A
	2.0 + 2.5 + 3.5 + 3.5 + 6.0	17.5	1.03	1.29	1.80	1.80	3.08	9.00	2.9 ~ 11.5	2430	580 ~ 3540	3.70	A
	2.0 + 2.5 + 3.5 + 4.2 + 4.2	16.4	1.10	1.37	1.93	2.30	2.30	9.00	2.9 ~ 11.5	2400	520 ~ 3600	3.75	A
	2.0 + 2.5 + 3.5 + 4.2 + 5.0	17.2	1.05	1.31	1.83	2.20	2.61	9.00	2.9 ~ 11.5	2430	580 ~ 3540	3.70	A
	2.0 + 2.5 + 3.5 + 4.2 + 6.0	18.2	0.99	1.24	1.73	2.08	2.96	9.00	2.9 ~ 11.5	2430	580 ~ 3540	3.70	A
	2.0 + 2.5 + 3.5 + 5.0 + 5.0	18.0	1.00	1.25	1.75	2.50	2.50	9.00	2.9 ~ 11.5	2520	670 ~ 3490	3.57	A
	2.0 + 2.5 + 4.2 + 4.2 + 4.2	17.1	1.05	1.32	2.21	2.21	2.21	9.00	2.9 ~ 11.5	2400	520 ~ 3600	3.75	A
	2.0 + 2.5 + 4.2 + 4.2 + 5.0	17.9	1.01	1.26	2.11	2.11	2.51	9.00	2.9 ~ 11.5	2430	580 ~ 3540	3.70	A
	2.0 + 3.5 + 3.5 + 3.5 + 3.5	16.0	1.12	1.97	1.97	1.97	1.97	9.00	2.9 ~ 11.5	2410	530 ~ 3600	3.73	A
	2.0 + 3.5 + 3.5 + 3.5 + 4.2	16.7	1.08	1.89	1.89	1.89	2.25	9.00	2.9 ~ 11.5	2410	530 ~ 3600	3.73	A
	2.0 + 3.5 + 3.5 + 3.5 + 5.0	17.5	1.03	1.80	1.80	1.80	2.57	9.00	2.9 ~ 11.5	2430	580 ~ 3540	3.70	A
2.0 + 3.5 + 3.5 + 4.2 + 4.2	17.4	1.04	1.81	1.81	2.17	2.17	9.00	2.9 ~ 11.5	2410	530 ~ 3600	3.73	A	
2.0 + 3.5 + 3.5 + 4.2 + 5.0	18.2	0.99	1.73	1.73	2.08	2.47	9.00	2.9 ~ 11.5	2430	580 ~ 3540	3.70	A	
2.0 + 3.5 + 4.2 + 4.2 + 4.2	18.1	0.99	1.74	2.09	2.09	2.09	9.00	2.9 ~ 11.5	2410	530 ~ 3600	3.73	A	
2.5 + 2.5 + 2.5 + 2.5 + 2.5	12.5	1.80	1.80	1.80	1.80	1.80	9.00	2.9 ~ 11.5	2450	480 ~ 3740	3.67	A	
2.5 + 2.5 + 2.5 + 2.5 + 3.5	13.5	1.67	1.67	1.67	1.67	2.32	9.00	2.9 ~ 11.5	2460	480 ~ 3660	3.66	A	
2.5 + 2.5 + 2.5 + 2.5 + 4.2	14.2	1.58	1.58	1.58	1.58	2.68	9.00	2.9 ~ 11.5	2460	490 ~ 3660	3.66	A	
2.5 + 2.5 + 2.5 + 2.5 + 5.0	15.0	1.50	1.50	1.50	1.50	3.00	9.00	2.9 ~ 11.5	2420	540 ~ 3530	3.72	A	
2.5 + 2.5 + 2.5 + 2.5 + 6.0	16.0	1.41	1.41	1.41	1.41	3.36	9.00	2.9 ~ 11.5	2420	540 ~ 3530	3.72	A	
2.5 + 2.5 + 2.5 + 2.5 + 7.1	17.1	1.32	1.32	1.32	1.32	3.72	9.00	2.9 ~ 11.5	2420	570 ~ 3530	3.72	A	
2.5 + 2.5 + 2.5 + 3.5 + 3.5	14.5	1.55	1.55	1.55	2.17	2.17	8.99	2.9 ~ 11.5	2460	490 ~ 3670	3.65	A	
2.5 + 2.5 + 2.5 + 3.5 + 4.2	15.2	1.48	1.48	1.48	2.07	2.49	9.00	2.9 ~ 11.5	2460	490 ~ 3670	3.66	A	
2.5 + 2.5 + 2.5 + 3.5 + 5.0	16.0	1.41	1.41	1.41	1.97	2.80	9.00	2.9 ~ 11.5	2420	570 ~ 3530	3.72	A	
2.5 + 2.5 + 2.5 + 3.5 + 6.0	17.0	1.32	1.32	1.32	1.85	3.19	9.00	2.9 ~ 11.5	2420	570 ~ 3530	3.72	A	

	Indoor unit capacity Cooling	Annual Energy Consumption (kWh)	Current 230V (A)	ERP			Moisture Removal Volume l/h	
				Pdesign (kW)	SEER			Annual Consumption (kWh)
					W/W	CLASS		
5 Room	2.0 + 2.0 + 2.5 + 4.2 + 7.1	1215	11.6	9.00	6.00	A+	525	0.7 + 0.7 + 0.8 + 1.4 + 2.1
	2.0 + 2.0 + 2.5 + 5.0 + 5.0	1255	12.0	9.00	6.00	A+	525	0.7 + 0.7 + 0.9 + 1.6 + 1.6
	2.0 + 2.0 + 2.5 + 5.0 + 6.0	1255	12.0	9.00	6.00	A+	525	0.7 + 0.7 + 0.8 + 1.6 + 1.7
	2.0 + 2.0 + 3.5 + 3.5 + 3.5	1200	11.5	8.99	6.00	A+	524	0.8 + 0.8 + 1.4 + 1.4 + 1.4
	2.0 + 2.0 + 3.5 + 3.5 + 4.2	1200	11.5	9.00	6.00	A+	525	0.7 + 0.7 + 1.3 + 1.3 + 1.5
	2.0 + 2.0 + 3.5 + 3.5 + 5.0	1215	11.6	9.00	6.00	A+	525	0.7 + 0.7 + 1.3 + 1.3 + 1.6
	2.0 + 2.0 + 3.5 + 3.5 + 6.0	1215	11.6	9.00	6.00	A+	525	0.7 + 0.7 + 1.2 + 1.2 + 1.8
	2.0 + 2.0 + 3.5 + 3.5 + 7.1	1215	11.6	9.00	6.00	A+	525	0.7 + 0.7 + 1.1 + 1.1 + 2.0
	2.0 + 2.0 + 3.5 + 4.2 + 4.2	1200	11.5	9.00	6.00	A+	525	0.7 + 0.7 + 1.3 + 1.5 + 1.5
	2.0 + 2.0 + 3.5 + 4.2 + 5.0	1215	11.6	9.00	6.00	A+	525	0.7 + 0.7 + 1.2 + 1.5 + 1.6
	2.0 + 2.0 + 3.5 + 4.2 + 6.0	1215	11.6	9.00	6.00	A+	525	0.7 + 0.7 + 1.1 + 1.4 + 1.7
	2.0 + 2.0 + 3.5 + 5.0 + 5.0	1260	12.1	9.00	6.00	A+	525	0.7 + 0.7 + 1.2 + 1.6 + 1.6
	2.0 + 2.0 + 4.2 + 4.2 + 4.2	1200	11.5	9.00	6.00	A+	525	0.7 + 0.7 + 1.5 + 1.5 + 1.5
	2.0 + 2.0 + 4.2 + 4.2 + 5.0	1215	11.6	9.00	6.00	A+	525	0.7 + 0.7 + 1.4 + 1.4 + 1.6
	2.0 + 2.0 + 4.2 + 5.0 + 5.0	1260	12.1	9.00	6.00	A+	525	0.7 + 0.7 + 1.3 + 1.5 + 1.5
	2.0 + 2.5 + 2.5 + 2.5 + 2.5	1225	11.7	9.00	6.00	A+	525	0.9 + 1.2 + 1.2 + 1.2 + 1.2
	2.0 + 2.5 + 2.5 + 2.5 + 3.5	1230	11.8	9.00	6.00	A+	525	0.9 + 1.1 + 1.1 + 1.1 + 1.5
	2.0 + 2.5 + 2.5 + 2.5 + 4.2	1230	11.8	9.00	6.00	A+	525	0.8 + 1.0 + 1.0 + 1.0 + 1.6
	2.0 + 2.5 + 2.5 + 2.5 + 5.0	1210	11.6	9.00	6.00	A+	525	0.8 + 1.0 + 1.0 + 1.0 + 1.8
	2.0 + 2.5 + 2.5 + 2.5 + 6.0	1210	11.6	9.00	6.00	A+	525	0.7 + 0.9 + 0.9 + 0.9 + 2.0
	2.0 + 2.5 + 2.5 + 2.5 + 7.1	1210	11.6	9.00	6.00	A+	525	0.7 + 0.9 + 0.9 + 0.9 + 2.2
	2.0 + 2.5 + 2.5 + 3.5 + 3.5	1230	11.8	9.00	6.00	A+	525	0.8 + 1.0 + 1.0 + 1.5 + 1.5
	2.0 + 2.5 + 2.5 + 3.5 + 4.2	1230	11.8	9.00	6.00	A+	525	0.8 + 1.0 + 1.0 + 1.4 + 1.6
	2.0 + 2.5 + 2.5 + 3.5 + 5.0	1210	11.6	9.00	6.00	A+	525	0.7 + 0.9 + 0.9 + 1.3 + 1.7
	2.0 + 2.5 + 2.5 + 3.5 + 6.0	1210	11.6	9.00	6.00	A+	525	0.7 + 0.9 + 0.9 + 1.2 + 1.9
	2.0 + 2.5 + 2.5 + 3.5 + 7.1	1215	11.6	9.00	6.00	A+	525	0.7 + 0.8 + 0.8 + 1.2 + 2.1
	2.0 + 2.5 + 2.5 + 4.2 + 4.2	1230	11.8	9.00	6.00	A+	525	0.7 + 0.9 + 0.9 + 1.5 + 1.5
	2.0 + 2.5 + 2.5 + 4.2 + 5.0	1210	11.6	9.00	6.00	A+	525	0.7 + 0.9 + 0.9 + 1.5 + 1.6
	2.0 + 2.5 + 2.5 + 4.2 + 6.0	1210	11.6	9.00	6.00	A+	525	0.7 + 0.8 + 0.8 + 1.4 + 1.8
	2.0 + 2.5 + 2.5 + 4.2 + 7.1	1215	11.6	9.00	6.00	A+	525	0.7 + 0.8 + 0.8 + 1.3 + 2.0
	2.0 + 2.5 + 2.5 + 5.0 + 5.0	1255	12.0	9.00	6.00	A+	525	0.7 + 0.8 + 0.8 + 1.6 + 1.6
	2.0 + 2.5 + 2.5 + 5.0 + 6.0	1255	12.0	9.00	6.00	A+	525	0.7 + 0.8 + 0.8 + 1.5 + 1.7
	2.0 + 2.5 + 3.5 + 3.5 + 3.5	1200	11.5	9.00	6.00	A+	525	0.7 + 1.0 + 1.4 + 1.4 + 1.4
	2.0 + 2.5 + 3.5 + 3.5 + 4.2	1200	11.5	9.00	6.00	A+	525	0.7 + 0.9 + 1.3 + 1.3 + 1.5
	2.0 + 2.5 + 3.5 + 3.5 + 5.0	1215	11.6	9.00	6.00	A+	525	0.7 + 0.9 + 1.2 + 1.2 + 1.6
	2.0 + 2.5 + 3.5 + 3.5 + 6.0	1215	11.6	9.00	6.00	A+	525	0.7 + 0.8 + 1.2 + 1.2 + 1.7
	2.0 + 2.5 + 3.5 + 4.2 + 4.2	1200	11.5	9.00	6.00	A+	525	0.7 + 0.9 + 1.2 + 1.5 + 1.5
	2.0 + 2.5 + 3.5 + 4.2 + 5.0	1215	11.6	9.00	6.00	A+	525	0.7 + 0.8 + 1.2 + 1.4 + 1.6
	2.0 + 2.5 + 3.5 + 4.2 + 6.0	1215	11.6	9.00	6.00	A+	525	0.7 + 0.8 + 1.1 + 1.3 + 1.7
	2.0 + 2.5 + 3.5 + 5.0 + 5.0	1260	12.1	9.00	6.00	A+	525	0.7 + 0.8 + 1.1 + 1.5 + 1.5
	2.0 + 2.5 + 4.2 + 4.2 + 4.2	1200	11.5	9.00	6.00	A+	525	0.7 + 0.8 + 1.4 + 1.4 + 1.4
	2.0 + 2.5 + 4.2 + 4.2 + 5.0	1215	11.6	9.00	6.00	A+	525	0.7 + 0.8 + 1.4 + 1.4 + 1.5
	2.0 + 3.5 + 3.5 + 3.5 + 3.5	1205	11.5	9.00	6.00	A+	525	0.7 + 1.3 + 1.3 + 1.3 + 1.3
	2.0 + 3.5 + 3.5 + 3.5 + 4.2	1205	11.5	9.00	6.00	A+	525	0.7 + 1.2 + 1.2 + 1.2 + 1.5
	2.0 + 3.5 + 3.5 + 3.5 + 5.0	1215	11.6	9.00	6.00	A+	525	0.7 + 1.2 + 1.2 + 1.2 + 1.6
	2.0 + 3.5 + 3.5 + 4.2 + 4.2	1205	11.5	9.00	6.00	A+	525	0.7 + 1.2 + 1.2 + 1.4 + 1.4
	2.0 + 3.5 + 3.5 + 4.2 + 5.0	1215	11.6	9.00	6.00	A+	525	0.7 + 1.1 + 1.1 + 1.3 + 1.5
	2.0 + 3.5 + 4.2 + 4.2 + 4.2	1205	11.5	9.00	6.00	A+	525	0.7 + 1.1 + 1.4 + 1.4 + 1.4
	2.5 + 2.5 + 2.5 + 2.5 + 2.5	1225	11.7	9.00	6.00	A+	525	1.2 + 1.2 + 1.2 + 1.2 + 1.2
	2.5 + 2.5 + 2.5 + 2.5 + 3.5	1230	11.8	9.00	6.00	A+	525	1.1 + 1.1 + 1.1 + 1.1 + 1.5
2.5 + 2.5 + 2.5 + 2.5 + 4.2	1230	11.8	9.00	6.00	A+	525	1.0 + 1.0 + 1.0 + 1.0 + 1.6	
2.5 + 2.5 + 2.5 + 2.5 + 5.0	1210	11.6	9.00	6.00	A+	525	1.0 + 1.0 + 1.0 + 1.0 + 1.7	
2.5 + 2.5 + 2.5 + 2.5 + 6.0	1210	11.6	9.00	6.00	A+	525	0.9 + 0.9 + 0.9 + 0.9 + 1.9	
2.5 + 2.5 + 2.5 + 2.5 + 7.1	1210	11.6	9.00	6.00	A+	525	0.8 + 0.8 + 0.8 + 0.8 + 2.2	
2.5 + 2.5 + 2.5 + 3.5 + 3.5	1230	11.8	8.99	6.00	A+	524	1.0 + 1.0 + 1.0 + 1.4 + 1.4	
2.5 + 2.5 + 2.5 + 3.5 + 4.2	1230	11.8	9.00	6.00	A+	525	0.9 + 0.9 + 0.9 + 1.3 + 1.5	
2.5 + 2.5 + 2.5 + 3.5 + 5.0	1210	11.6	9.00	6.00	A+	525	0.9 + 0.9 + 0.9 + 1.3 + 1.6	
2.5 + 2.5 + 2.5 + 3.5 + 6.0	1210	11.6	9.00	6.00	A+	525	0.8 + 0.8 + 0.8 + 1.2 + 1.8	

Indoor unit capacity Cooling		Total	Cooling Capacity (kW)							Input Power (W)		EER	
			Room A	Room B	Room C	Room D	Room E	Total	min ~ max	Rating	min ~ max	WW	CLASS
5 Room	2.5 + 2.5 + 2.5 + 3.5 + 7.1	18.1	1.24	1.24	1.24	1.74	3.54	9.00	2.9 ~ 11.5	2430	580 ~ 3540	3.70	A
	2.5 + 2.5 + 2.5 + 4.2 + 4.2	15.9	1.42	1.42	1.42	2.37	2.37	9.00	2.9 ~ 11.5	2460	490 ~ 3670	3.66	A
	2.5 + 2.5 + 2.5 + 4.2 + 5.0	16.7	1.35	1.35	1.35	2.26	2.69	9.00	2.9 ~ 11.5	2420	570 ~ 3530	3.72	A
	2.5 + 2.5 + 2.5 + 4.2 + 6.0	17.7	1.27	1.27	1.27	2.14	3.05	9.00	2.9 ~ 11.5	2420	570 ~ 3530	3.72	A
	2.5 + 2.5 + 2.5 + 5.0 + 5.0	17.5	1.29	1.29	1.29	2.56	2.56	8.99	2.9 ~ 11.5	2510	660 ~ 3480	3.58	A
	2.5 + 2.5 + 3.5 + 3.5 + 3.5	15.5	1.45	1.45	2.03	2.03	2.03	8.99	2.9 ~ 11.5	2400	490 ~ 3590	3.75	A
	2.5 + 2.5 + 3.5 + 3.5 + 4.2	16.2	1.39	1.39	1.94	1.94	2.34	9.00	2.9 ~ 11.5	2400	500 ~ 3590	3.75	A
	2.5 + 2.5 + 3.5 + 3.5 + 5.0	17.0	1.32	1.32	1.85	1.85	2.66	9.00	2.9 ~ 11.5	2430	580 ~ 3540	3.70	A
	2.5 + 2.5 + 3.5 + 3.5 + 6.0	18.0	1.25	1.25	1.75	1.75	3.00	9.00	2.9 ~ 11.5	2430	580 ~ 3540	3.70	A
	2.5 + 2.5 + 3.5 + 4.2 + 4.2	16.9	1.33	1.33	1.86	2.24	2.24	9.00	2.9 ~ 11.5	2400	520 ~ 3600	3.75	A
	2.5 + 2.5 + 3.5 + 4.2 + 5.0	17.7	1.27	1.27	1.78	2.14	2.54	9.00	2.9 ~ 11.5	2430	580 ~ 3540	3.70	A
	2.5 + 2.5 + 4.2 + 4.2 + 4.2	17.6	1.27	1.27	2.15	2.15	2.15	8.99	2.9 ~ 11.5	2400	520 ~ 3600	3.75	A
	2.5 + 3.5 + 3.5 + 3.5 + 3.5	16.5	1.36	1.91	1.91	1.91	1.91	9.00	2.9 ~ 11.5	2410	530 ~ 3600	3.73	A
	2.5 + 3.5 + 3.5 + 3.5 + 4.2	17.2	1.31	1.83	1.83	1.83	2.20	9.00	2.9 ~ 11.5	2410	530 ~ 3600	3.73	A
	2.5 + 3.5 + 3.5 + 3.5 + 5.0	18.0	1.25	1.75	1.75	1.75	2.50	9.00	2.9 ~ 11.5	2430	580 ~ 3540	3.70	A
	2.5 + 3.5 + 3.5 + 4.2 + 4.2	17.9	1.26	1.76	1.76	2.11	2.11	9.00	2.9 ~ 11.5	2410	530 ~ 3600	3.73	A
	3.5 + 3.5 + 3.5 + 3.5 + 3.5	17.5	1.80	1.80	1.80	1.80	1.80	9.00	2.9 ~ 11.5	2410	530 ~ 3600	3.73	A
3.5 + 3.5 + 3.5 + 3.5 + 4.2	18.2	1.73	1.73	1.73	1.73	2.08	9.00	2.9 ~ 11.5	2410	530 ~ 3600	3.73	A	

	Indoor unit capacity Cooling	Annual Energy Consumption (kWh)	Current 230V (A)	ERP				Moisture Removal Volume l/h
				Pdesign (kW)	SEER		Annual Consumption (kWh)	
					W/W	CLASS		
5 Room	2.5 + 2.5 + 2.5 + 3.5 + 7.1	1215	11.6	9.00	6.00	A+	525	0.8 + 0.8 + 0.8 + 1.1 + 2.0
	2.5 + 2.5 + 2.5 + 4.2 + 4.2	1230	11.8	9.00	6.00	A+	525	0.9 + 0.9 + 0.9 + 1.5 + 1.5
	2.5 + 2.5 + 2.5 + 4.2 + 5.0	1210	11.6	9.00	6.00	A+	525	0.9 + 0.9 + 0.9 + 1.5 + 1.6
	2.5 + 2.5 + 2.5 + 4.2 + 6.0	1210	11.6	9.00	6.00	A+	525	0.8 + 0.8 + 0.8 + 1.4 + 1.7
	2.5 + 2.5 + 2.5 + 5.0 + 5.0	1255	12.0	8.99	6.00	A+	524	0.8 + 0.8 + 0.8 + 1.6 + 1.6
	2.5 + 2.5 + 3.5 + 3.5 + 3.5	1200	11.5	8.99	6.00	A+	524	0.9 + 0.9 + 1.3 + 1.3 + 1.3
	2.5 + 2.5 + 3.5 + 3.5 + 4.2	1200	11.5	9.00	6.00	A+	525	0.9 + 0.9 + 1.3 + 1.3 + 1.5
	2.5 + 2.5 + 3.5 + 3.5 + 5.0	1215	11.6	9.00	6.00	A+	525	0.8 + 0.8 + 1.2 + 1.2 + 1.6
	2.5 + 2.5 + 3.5 + 3.5 + 6.0	1215	11.6	9.00	6.00	A+	525	0.8 + 0.8 + 1.1 + 1.1 + 1.7
	2.5 + 2.5 + 3.5 + 4.2 + 4.2	1200	11.5	9.00	6.00	A+	525	0.8 + 0.8 + 1.2 + 1.5 + 1.5
	2.5 + 2.5 + 3.5 + 4.2 + 5.0	1215	11.6	9.00	6.00	A+	525	0.8 + 0.8 + 1.1 + 1.4 + 1.6
	2.5 + 2.5 + 4.2 + 4.2 + 4.2	1200	11.5	8.99	6.00	A+	524	0.8 + 0.8 + 1.4 + 1.4 + 1.4
	2.5 + 3.5 + 3.5 + 3.5 + 3.5	1205	11.5	9.00	6.00	A+	525	0.9 + 1.2 + 1.2 + 1.2 + 1.2
	2.5 + 3.5 + 3.5 + 3.5 + 4.2	1205	11.5	9.00	6.00	A+	525	0.8 + 1.2 + 1.2 + 1.2 + 1.4
	2.5 + 3.5 + 3.5 + 3.5 + 5.0	1215	11.6	9.00	6.00	A+	525	0.8 + 1.1 + 1.1 + 1.1 + 1.5
	2.5 + 3.5 + 3.5 + 4.2 + 4.2	1205	11.5	9.00	6.00	A+	525	0.8 + 1.1 + 1.1 + 1.4 + 1.4
	3.5 + 3.5 + 3.5 + 3.5 + 3.5	1205	11.5	9.00	6.00	A+	525	1.2 + 1.2 + 1.2 + 1.2 + 1.2
	3.5 + 3.5 + 3.5 + 3.5 + 4.2	1205	11.5	9.00	6.00	A+	525	1.1 + 1.1 + 1.1 + 1.1 + 1.3

- Indoor Unit : Combination of all type of wall and non-wall series (CS-MZ / Z / XZ / MTZ / TZ / TE / E)
- Outdoor Unit : CU-5Z90TBE

	Indoor unit capacity Heating	Total	Heating Capacity (kW)						Input Power (W)		COP		
			Room A	Room B	Room C	Room D	Room E	Total	min ~ max	Rating	min ~ max	WW	CLASS
1 Room	1.6	1.6	2.60					2.60	1.2 ~ 3.2	740	300 ~ 1060	3.51	B
	2.0	2.0	3.20					3.20	1.2 ~ 4.1	840	300 ~ 1330	3.81	A
	2.5	2.5	3.60					3.60	1.2 ~ 4.3	1040	300 ~ 1330	3.46	B
	3.5	3.5	4.50					4.50	1.2 ~ 5.8	1330	300 ~ 2200	3.38	C
	4.2	4.2	5.60					5.60	1.2 ~ 6.8	1820	300 ~ 3030	3.08	D
	5.0	5.0	6.80					6.80	1.2 ~ 6.9	2200	300 ~ 2620	3.09	D
	6.0	6.0	8.50					8.50	1.3 ~ 9.0	2500	620 ~ 2650	3.40	C
	7.1	7.1	8.70					8.70	1.4 ~ 9.2	2650	680 ~ 2820	3.28	C
2 Room	1.6 + 1.6	3.2	2.35	2.35				4.70	2.0 ~ 8.2	1410	220 ~ 2610	3.33	C
	1.6 + 2.0	3.6	2.31	2.89				5.20	2.0 ~ 8.2	1570	220 ~ 2600	3.31	C
	1.6 + 2.5	4.1	2.19	3.41				5.60	2.0 ~ 8.2	1700	220 ~ 2600	3.29	C
	1.6 + 3.5	5.1	2.01	4.39				6.40	2.0 ~ 8.6	1890	210 ~ 2680	3.39	C
	1.6 + 4.2	5.8	2.04	5.36				7.40	2.0 ~ 10.1	2190	210 ~ 3230	3.38	C
	1.6 + 5.0	6.6	2.06	6.44				8.50	2.0 ~ 11.0	2400	160 ~ 3240	3.54	B
	1.6 + 6.0	7.6	2.11	7.89				10.00	2.0 ~ 11.0	2870	160 ~ 3240	3.48	B
	1.6 + 7.1	8.7	1.88	8.32				10.20	2.0 ~ 13.0	2870	160 ~ 4030	3.55	B
	2.0 + 2.0	4.0	2.90	2.90				5.80	2.0 ~ 8.2	1730	220 ~ 2590	3.35	C
	2.0 + 2.5	4.5	2.71	3.39				6.10	2.0 ~ 8.2	1820	220 ~ 2590	3.35	C
	2.0 + 3.5	5.5	2.51	4.39				6.90	2.0 ~ 8.6	2010	210 ~ 2620	3.43	B
	2.0 + 4.2	6.2	2.55	5.35				7.90	2.0 ~ 11.0	2360	200 ~ 3430	3.35	C
	2.0 + 5.0	7.0	2.57	6.43				9.00	2.0 ~ 11.0	2460	160 ~ 3180	3.66	A
	2.0 + 6.0	8.0	2.60	7.80				10.40	2.0 ~ 11.9	2880	160 ~ 3530	3.61	A
	2.0 + 7.1	9.1	2.29	8.11				10.40	2.0 ~ 13.0	2820	160 ~ 4020	3.69	A
	2.5 + 2.5	5.0	3.25	3.25				6.50	2.0 ~ 8.6	1900	220 ~ 2700	3.42	B
	2.5 + 3.5	6.0	3.04	4.26				7.30	2.0 ~ 10.1	2140	210 ~ 3230	3.41	B
	2.5 + 4.2	6.7	3.10	5.20				8.30	2.0 ~ 11.0	2500	200 ~ 3430	3.32	C
	2.5 + 5.0	7.5	3.13	6.27				9.40	2.0 ~ 11.0	2650	160 ~ 3180	3.55	B
	2.5 + 6.0	8.5	3.06	7.34				10.40	2.0 ~ 13.0	2880	160 ~ 4030	3.61	A
	2.5 + 7.1	9.6	2.71	7.69				10.40	2.0 ~ 13.0	2820	160 ~ 4020	3.69	A
	3.5 + 3.5	7.0	4.05	4.05				8.10	2.0 ~ 11.0	2390	200 ~ 3420	3.39	C
	3.5 + 4.2	7.7	4.14	4.96				9.10	2.0 ~ 11.0	2690	200 ~ 3360	3.38	C
	3.5 + 5.0	8.5	4.20	6.00				10.20	2.0 ~ 13.0	2790	160 ~ 4010	3.66	A
	3.5 + 6.0	9.5	3.83	6.57				10.40	2.0 ~ 13.0	2810	160 ~ 4010	3.70	A
	3.5 + 7.1	10.6	3.43	6.97				10.40	2.0 ~ 13.8	2790	160 ~ 4340	3.73	A
	4.2 + 4.2	8.4	5.05	5.05				10.10	2.0 ~ 13.0	2990	190 ~ 4190	3.38	C
4.2 + 5.0	9.2	4.75	5.65				10.40	2.0 ~ 13.0	2800	160 ~ 3940	3.71	A	
4.2 + 6.0	10.2	4.28	6.12				10.40	2.0 ~ 13.8	2800	160 ~ 4350	3.71	A	
4.2 + 7.1	11.3	3.87	6.53				10.40	2.0 ~ 13.8	2780	160 ~ 4330	3.74	A	
5.0 + 5.0	10.0	5.20	5.20				10.40	2.0 ~ 13.8	2630	170 ~ 4100	3.95	A	
5.0 + 6.0	11.0	4.73	5.67				10.40	2.0 ~ 13.8	2630	170 ~ 4100	3.95	A	
5.0 + 7.1	12.1	4.30	6.10				10.40	2.0 ~ 13.8	2610	170 ~ 4090	3.98	A	
6.0 + 6.0	12.0	5.20	5.20				10.40	2.0 ~ 13.8	2630	170 ~ 4100	3.95	A	
6.0 + 7.1	13.1	4.76	5.64				10.40	2.0 ~ 13.8	2610	170 ~ 4090	3.98	A	
7.1 + 7.1	14.2	5.20	5.20				10.40	2.0 ~ 13.8	2550	180 ~ 4070	4.08	A	



	Indoor unit capacity Heating	Annual Energy Consumption (kWh)	Current 230V (A)	ERP				Moisture Removal Volume l/h
				Pdesign (kW)	SCOP		Annual Consumption (kWh)	
					W/W	CLASS		
1 Room	1.6	370	3.5	-	-	-	-	
	2.0	420	4.1	-	-	-	-	
	2.5	520	5.1	-	-	-	-	
	3.5	665	6.5	-	-	-	-	
	4.2	910	8.4	-	-	-	-	
	5.0	1100	10.1	-	-	-	-	
	6.0	1250	11.5	-	-	-	-	
	7.1	1325	12.2	-	-	-	-	
2 Room	1.6 + 1.6	705	6.7	3.60	3.80	A	1326	
	1.6 + 2.0	785	7.5	3.60	3.80	A	1326	
	1.6 + 2.5	850	8.1	3.60	3.80	A	1326	
	1.6 + 3.5	945	8.9	4.60	3.80	A	1695	
	1.6 + 4.2	1095	10.3	4.60	3.80	A	1695	
	1.6 + 5.0	1200	11.3	5.60	3.80	A	2063	
	1.6 + 6.0	1435	13.5	5.60	3.80	A	2063	
	1.6 + 7.1	1435	13.5	5.60	3.80	A	2063	
	2.0 + 2.0	865	8.2	3.60	3.80	A	1326	
	2.0 + 2.5	910	8.6	3.60	3.80	A	1326	
	2.0 + 3.5	1005	9.4	4.60	3.80	A	1695	
	2.0 + 4.2	1180	11.1	4.60	3.80	A	1695	
	2.0 + 5.0	1230	11.6	5.60	3.80	A	2063	
	2.0 + 6.0	1440	13.5	5.60	3.80	A	2063	
	2.0 + 7.1	1410	13.3	5.60	3.80	A	2063	
	2.5 + 2.5	950	8.9	3.60	3.80	A	1326	
	2.5 + 3.5	1070	10.1	4.60	3.80	A	1695	
	2.5 + 4.2	1250	11.7	4.60	3.80	A	1695	
	2.5 + 5.0	1325	12.5	5.60	3.80	A	2063	
	2.5 + 6.0	1440	13.5	5.60	3.80	A	2063	
	2.5 + 7.1	1410	13.3	5.60	3.80	A	2063	
	3.5 + 3.5	1195	11.2	4.60	3.80	A	1695	
	3.5 + 4.2	1345	12.6	4.60	3.80	A	1695	
	3.5 + 5.0	1395	13.1	5.60	3.80	A	2063	
	3.5 + 6.0	1405	13.2	5.60	3.80	A	2063	
	3.5 + 7.1	1395	13.1	5.60	3.80	A	2063	
	4.2 + 4.2	1495	14.1	4.60	3.80	A	1695	
4.2 + 5.0	1400	13.2	5.60	3.80	A	2063		
4.2 + 6.0	1400	13.2	5.60	3.80	A	2063		
4.2 + 7.1	1390	13.1	5.60	3.80	A	2063		
5.0 + 5.0	1315	12.4	7.60	3.80	A	2800		
5.0 + 6.0	1315	12.4	7.60	3.80	A	2800		
5.0 + 7.1	1305	12.3	7.60	3.80	A	2800		
6.0 + 6.0	1315	12.4	7.60	3.80	A	2800		
6.0 + 7.1	1305	12.3	7.60	3.80	A	2800		
7.1 + 7.1	1275	12.0	7.60	3.80	A	2800		

	Indoor unit capacity Heating	Total	Heating Capacity (kW)						Input Power (W)		COP		
			Room A	Room B	Room C	Room D	Room E	Total	min ~ max	Rating	min ~ max	WW	CLASS
3 Room	1.6 + 1.6 + 1.6	4.8	2.33	2.33	2.33			6.99	2.7 ~ 12.3	1840	230 ~ 3680	3.80	A
	1.6 + 1.6 + 2.0	5.2	2.34	2.34	2.92			7.60	2.7 ~ 12.3	2040	230 ~ 3670	3.73	A
	1.6 + 1.6 + 2.5	5.7	2.22	2.22	3.46			7.90	2.7 ~ 12.3	2130	230 ~ 3670	3.71	A
	1.6 + 1.6 + 3.5	6.7	2.08	2.08	4.54			8.70	2.7 ~ 12.3	2320	230 ~ 3580	3.75	A
	1.6 + 1.6 + 4.2	7.4	2.10	2.10	5.50			9.70	2.7 ~ 12.3	2690	230 ~ 3570	3.61	A
	1.6 + 1.6 + 5.0	8.2	2.03	2.03	6.34			10.40	2.7 ~ 12.9	2610	250 ~ 3660	3.98	A
	1.6 + 1.6 + 6.0	9.2	1.81	1.81	6.78			10.40	2.7 ~ 13.6	2610	250 ~ 4000	3.98	A
	1.6 + 1.6 + 7.1	10.3	1.62	1.62	7.16			10.40	2.7 ~ 13.6	2600	250 ~ 3920	4.00	A
	1.6 + 2.0 + 2.0	5.6	2.32	2.89	2.89			8.10	2.7 ~ 12.3	2170	230 ~ 3660	3.73	A
	1.6 + 2.0 + 2.5	6.1	2.23	2.79	3.48			8.50	2.7 ~ 12.3	2350	230 ~ 3660	3.62	A
	1.6 + 2.0 + 3.5	7.1	2.10	2.62	4.58			9.30	2.7 ~ 12.3	2500	230 ~ 3570	3.72	A
	1.6 + 2.0 + 4.2	7.8	2.11	2.64	5.55			10.30	2.7 ~ 12.9	2720	230 ~ 3840	3.79	A
	1.6 + 2.0 + 5.0	8.6	1.93	2.42	6.05			10.40	2.7 ~ 13.6	2600	250 ~ 3930	4.00	A
	1.6 + 2.0 + 6.0	9.6	1.73	2.17	6.50			10.40	2.7 ~ 13.6	2600	250 ~ 3930	4.00	A
	1.6 + 2.0 + 7.1	10.7	1.56	1.94	6.90			10.40	2.7 ~ 13.8	2590	250 ~ 4030	4.02	A
	1.6 + 2.5 + 2.5	6.6	2.14	3.33	3.33			8.80	2.7 ~ 12.3	2380	230 ~ 3660	3.70	A
	1.6 + 2.5 + 3.5	7.6	2.02	3.16	4.42			9.60	2.7 ~ 12.3	2640	230 ~ 3570	3.64	A
	1.6 + 2.5 + 4.2	8.3	2.00	3.13	5.27			10.40	2.7 ~ 12.9	2760	230 ~ 3840	3.77	A
	1.6 + 2.5 + 5.0	9.1	1.83	2.86	5.71			10.40	2.7 ~ 13.6	2600	250 ~ 3930	4.00	A
	1.6 + 2.5 + 6.0	10.1	1.65	2.57	6.18			10.40	2.7 ~ 13.6	2600	250 ~ 3930	4.00	A
	1.6 + 2.5 + 7.1	11.2	1.49	2.32	6.59			10.40	2.7 ~ 13.8	2590	250 ~ 4030	4.02	A
	1.6 + 3.5 + 3.5	8.6	1.94	4.23	4.23			10.40	2.7 ~ 13.6	2750	230 ~ 4160	3.78	A
	1.6 + 3.5 + 4.2	9.3	1.79	3.91	4.70			10.40	2.7 ~ 13.6	2730	240 ~ 4150	3.81	A
	1.6 + 3.5 + 5.0	10.1	1.65	3.60	5.15			10.40	2.7 ~ 13.6	2570	250 ~ 3890	4.05	A
	1.6 + 3.5 + 6.0	11.1	1.50	3.28	5.62			10.40	2.7 ~ 13.8	2570	250 ~ 4010	4.05	A
	1.6 + 3.5 + 7.1	12.2	1.36	2.98	6.06			10.40	2.7 ~ 13.8	2560	270 ~ 3990	4.06	A
	1.6 + 4.2 + 4.2	10.0	1.66	4.37	4.37			10.40	2.7 ~ 13.6	2720	240 ~ 4080	3.82	A
	1.6 + 4.2 + 5.0	10.8	1.54	4.04	4.82			10.40	2.7 ~ 13.8	2560	270 ~ 4000	4.06	A
	1.6 + 4.2 + 6.0	11.8	1.41	3.70	5.29			10.40	2.7 ~ 13.8	2560	270 ~ 4000	4.06	A
	1.6 + 4.2 + 7.1	12.9	1.29	3.39	5.72			10.40	2.7 ~ 14.1	2550	270 ~ 4100	4.08	A
	1.6 + 5.0 + 5.0	11.6	1.44	4.48	4.48			10.40	2.7 ~ 13.8	2470	300 ~ 3800	4.21	A
	1.6 + 5.0 + 6.0	12.6	1.32	4.13	4.95			10.40	2.7 ~ 13.8	2470	300 ~ 3800	4.21	A
	1.6 + 5.0 + 7.1	13.7	1.21	3.80	5.39			10.40	2.7 ~ 14.1	2460	310 ~ 3950	4.23	A
	1.6 + 6.0 + 6.0	13.6	1.22	4.59	4.59			10.40	2.7 ~ 14.1	2470	300 ~ 3970	4.21	A
	1.6 + 6.0 + 7.1	14.7	1.13	4.24	5.03			10.40	2.7 ~ 14.1	2460	310 ~ 3950	4.23	A
	1.6 + 7.1 + 7.1	15.8	1.06	4.67	4.67			10.40	2.7 ~ 14.4	2490	320 ~ 4050	4.18	A
	2.0 + 2.0 + 2.0	6.0	2.86	2.86	2.86			8.58	2.7 ~ 12.3	2280	230 ~ 3650	3.76	A
	2.0 + 2.0 + 2.5	6.5	2.77	2.77	3.46			9.00	2.7 ~ 12.3	2420	230 ~ 3650	3.72	A
	2.0 + 2.0 + 3.5	7.5	2.61	2.61	4.58			9.80	2.7 ~ 12.3	2680	230 ~ 3560	3.66	A
	2.0 + 2.0 + 4.2	8.2	2.54	2.54	5.32			10.40	2.7 ~ 12.9	2750	230 ~ 3830	3.78	A
	2.0 + 2.0 + 5.0	9.0	2.31	2.31	5.78			10.40	2.7 ~ 13.6	2590	250 ~ 3920	4.02	A
	2.0 + 2.0 + 6.0	10.0	2.08	2.08	6.24			10.40	2.7 ~ 13.6	2590	250 ~ 3920	4.02	A
2.0 + 2.0 + 7.1	11.1	1.87	1.87	6.66			10.40	2.7 ~ 13.8	2580	250 ~ 4010	4.03	A	
2.0 + 2.5 + 2.5	7.0	2.68	3.36	3.36			9.40	2.7 ~ 12.3	2560	230 ~ 3650	3.67	A	
2.0 + 2.5 + 3.5	8.0	2.55	3.19	4.46			10.20	2.7 ~ 12.9	2750	230 ~ 3840	3.71	A	
2.0 + 2.5 + 4.2	8.7	2.39	2.99	5.02			10.40	2.7 ~ 13.6	2750	230 ~ 4170	3.78	A	
2.0 + 2.5 + 5.0	9.5	2.19	2.74	5.47			10.40	2.7 ~ 13.6	2590	250 ~ 3920	4.02	A	
2.0 + 2.5 + 6.0	10.5	1.98	2.48	5.94			10.40	2.7 ~ 13.8	2590	250 ~ 4030	4.02	A	
2.0 + 2.5 + 7.1	11.6	1.79	2.24	6.37			10.40	2.7 ~ 13.8	2580	250 ~ 4010	4.03	A	
2.0 + 3.5 + 3.5	9.0	2.32	4.04	4.04			10.40	2.7 ~ 13.6	2730	240 ~ 4150	3.81	A	
2.0 + 3.5 + 4.2	9.7	2.14	3.75	4.51			10.40	2.7 ~ 13.6	2720	240 ~ 4080	3.82	A	
2.0 + 3.5 + 5.0	10.5	1.98	3.47	4.95			10.40	2.7 ~ 13.8	2560	270 ~ 4000	4.06	A	
2.0 + 3.5 + 6.0	11.5	1.81	3.17	5.42			10.40	2.7 ~ 13.8	2560	270 ~ 4000	4.06	A	
2.0 + 3.5 + 7.1	12.6	1.65	2.89	5.86			10.40	2.7 ~ 13.8	2550	270 ~ 3980	4.08	A	
2.0 + 4.2 + 4.2	10.4	2.00	4.20	4.20			10.40	2.7 ~ 13.6	2710	240 ~ 4070	3.84	A	
2.0 + 4.2 + 5.0	11.2	1.86	3.90	4.64			10.40	2.7 ~ 13.8	2560	270 ~ 3980	4.06	A	
2.0 + 4.2 + 6.0	12.2	1.70	3.58	5.12			10.40	2.7 ~ 13.8	2560	270 ~ 3980	4.06	A	
2.0 + 4.2 + 7.1	13.3	1.56	3.28	5.56			10.40	2.7 ~ 14.1	2540	270 ~ 4080	4.09	A	

	Indoor unit capacity Heating	Annual Energy Consumption (kWh)	Current 230V (A)	ERP				Moisture Removal Volume l/h
				Pdesign (kW)	SCOP		Annual Consumption (kWh)	
					W/W	CLASS		
3 Room	1.6 + 1.6 + 1.6	920	8.6	5.60	3.80	A	2063	
	1.6 + 1.6 + 2.0	1020	9.6	5.60	3.80	A	2063	
	1.6 + 1.6 + 2.5	1065	10.0	5.60	3.80	A	2063	
	1.6 + 1.6 + 3.5	1160	10.9	6.60	3.80	A	2432	
	1.6 + 1.6 + 4.2	1345	12.6	6.60	3.80	A	2432	
	1.6 + 1.6 + 5.0	1305	12.3	6.60	3.80	A	2432	
	1.6 + 1.6 + 6.0	1305	12.3	7.60	3.80	A	2800	
	1.6 + 1.6 + 7.1	1300	12.2	7.60	3.80	A	2800	
	1.6 + 2.0 + 2.0	1085	10.2	5.60	3.80	A	2063	
	1.6 + 2.0 + 2.5	1175	11.0	6.60	3.80	A	2432	
	1.6 + 2.0 + 3.5	1250	11.7	6.60	3.80	A	2432	
	1.6 + 2.0 + 4.2	1360	12.8	6.60	3.80	A	2432	
	1.6 + 2.0 + 5.0	1300	12.2	7.60	3.80	A	2800	
	1.6 + 2.0 + 6.0	1300	12.2	7.60	3.80	A	2800	
	1.6 + 2.0 + 7.1	1295	12.2	7.60	3.80	A	2800	
	1.6 + 2.5 + 2.5	1190	11.2	6.60	3.80	A	2432	
	1.6 + 2.5 + 3.5	1320	12.4	6.60	3.80	A	2432	
	1.6 + 2.5 + 4.2	1380	13.0	6.60	3.80	A	2432	
	1.6 + 2.5 + 5.0	1300	12.2	7.60	3.80	A	2800	
	1.6 + 2.5 + 6.0	1300	12.2	7.60	3.80	A	2800	
	1.6 + 2.5 + 7.1	1295	12.2	7.60	3.80	A	2800	
	1.6 + 3.5 + 3.5	1375	12.9	7.60	3.80	A	2800	
	1.6 + 3.5 + 4.2	1365	12.8	7.60	3.80	A	2800	
	1.6 + 3.5 + 5.0	1285	12.1	7.60	3.80	A	2800	
	1.6 + 3.5 + 6.0	1285	12.1	7.60	3.80	A	2800	
	1.6 + 3.5 + 7.1	1280	12.0	7.60	3.80	A	2800	
	1.6 + 4.2 + 4.2	1360	12.8	7.60	3.80	A	2800	
	1.6 + 4.2 + 5.0	1280	12.0	7.60	3.80	A	2800	
	1.6 + 4.2 + 6.0	1280	12.0	7.60	3.80	A	2800	
	1.6 + 4.2 + 7.1	1275	12.0	7.60	3.80	A	2800	
	1.6 + 5.0 + 5.0	1235	11.6	7.60	3.80	A	2800	
	1.6 + 5.0 + 6.0	1235	11.6	7.60	3.80	A	2800	
	1.6 + 5.0 + 7.1	1230	11.6	7.60	3.80	A	2800	
	1.6 + 6.0 + 6.0	1235	11.6	7.60	3.80	A	2800	
	1.6 + 6.0 + 7.1	1230	11.6	7.60	3.80	A	2800	
	1.6 + 7.1 + 7.1	1245	11.7	7.60	3.80	A	2800	
	2.0 + 2.0 + 2.0	1140	10.7	6.60	3.80	A	2432	
	2.0 + 2.0 + 2.5	1210	11.4	6.60	3.80	A	2432	
	2.0 + 2.0 + 3.5	1340	12.6	6.60	3.80	A	2432	
	2.0 + 2.0 + 4.2	1375	12.9	6.60	3.80	A	2432	
2.0 + 2.0 + 5.0	1295	12.2	7.60	3.80	A	2800		
2.0 + 2.0 + 6.0	1295	12.2	7.60	3.80	A	2800		
2.0 + 2.0 + 7.1	1290	12.1	7.60	3.80	A	2800		
2.0 + 2.5 + 2.5	1280	12.0	6.60	3.80	A	2432		
2.0 + 2.5 + 3.5	1375	12.9	6.60	3.80	A	2432		
2.0 + 2.5 + 4.2	1375	12.9	7.60	3.80	A	2800		
2.0 + 2.5 + 5.0	1295	12.2	7.60	3.80	A	2800		
2.0 + 2.5 + 6.0	1295	12.2	7.60	3.80	A	2800		
2.0 + 2.5 + 7.1	1290	12.1	7.60	3.80	A	2800		
2.0 + 3.5 + 3.5	1365	12.8	7.60	3.80	A	2800		
2.0 + 3.5 + 4.2	1360	12.8	7.60	3.80	A	2800		
2.0 + 3.5 + 5.0	1280	12.0	7.60	3.80	A	2800		
2.0 + 3.5 + 6.0	1280	12.0	7.60	3.80	A	2800		
2.0 + 3.5 + 7.1	1275	12.0	7.60	3.80	A	2800		
2.0 + 4.2 + 4.2	1355	12.7	7.60	3.80	A	2800		
2.0 + 4.2 + 5.0	1280	12.0	7.60	3.80	A	2800		
2.0 + 4.2 + 6.0	1280	12.0	7.60	3.80	A	2800		
2.0 + 4.2 + 7.1	1270	11.9	7.60	3.80	A	2800		

Indoor unit capacity Heating	Total	Heating Capacity (kW)							Input Power (W)		COP	
		Room A	Room B	Room C	Room D	Room E	Total	min ~ max	Rating	min ~ max	WW	CLASS
2.0 + 5.0 + 5.0	12.0	1.74	4.33	4.33			10.40	2.7 ~ 13.8	2460	310 ~ 3780	4.23	A
2.0 + 5.0 + 6.0	13.0	1.60	4.00	4.80			10.40	2.7 ~ 14.1	2460	310 ~ 3950	4.23	A
2.0 + 5.0 + 7.1	14.1	1.48	3.69	5.23			10.40	2.7 ~ 14.1	2490	320 ~ 3940	4.18	A
2.0 + 6.0 + 6.0	14.0	1.48	4.46	4.46			10.40	2.7 ~ 14.1	2460	310 ~ 3950	4.23	A
2.0 + 6.0 + 7.1	15.1	1.38	4.13	4.89			10.40	2.7 ~ 14.4	2490	320 ~ 4050	4.18	A
2.0 + 7.1 + 7.1	16.2	1.28	4.56	4.56			10.40	2.7 ~ 14.4	2480	330 ~ 4040	4.19	A
2.5 + 2.5 + 2.5	7.5	3.23	3.23	3.23			9.69	2.7 ~ 12.3	2710	230 ~ 3650	3.58	B
2.5 + 2.5 + 3.5	8.5	3.06	3.06	4.28			10.40	2.7 ~ 13.6	2760	230 ~ 4190	3.77	A
2.5 + 2.5 + 4.2	9.2	2.83	2.83	4.74			10.40	2.7 ~ 13.6	2750	230 ~ 4170	3.78	A
2.5 + 2.5 + 5.0	10.0	2.60	2.60	5.20			10.40	2.7 ~ 13.6	2590	250 ~ 3920	4.02	A
2.5 + 2.5 + 6.0	11.0	2.36	2.36	5.68			10.40	2.7 ~ 13.8	2590	250 ~ 4030	4.02	A
2.5 + 2.5 + 7.1	12.1	2.15	2.15	6.10			10.40	2.7 ~ 13.8	2580	250 ~ 4010	4.03	A
2.5 + 3.5 + 3.5	9.5	2.74	3.83	3.83			10.40	2.7 ~ 13.6	2730	240 ~ 4150	3.81	A
2.5 + 3.5 + 4.2	10.2	2.55	3.57	4.28			10.40	2.7 ~ 13.6	2720	240 ~ 4080	3.82	A
2.5 + 3.5 + 5.0	11.0	2.36	3.31	4.73			10.40	2.7 ~ 13.8	2560	270 ~ 4000	4.06	A
2.5 + 3.5 + 6.0	12.0	2.17	3.03	5.20			10.40	2.7 ~ 13.8	2560	270 ~ 4000	4.06	A
2.5 + 3.5 + 7.1	13.1	1.98	2.78	5.64			10.40	2.7 ~ 14.1	2550	270 ~ 4100	4.08	A
2.5 + 4.2 + 4.2	10.9	2.38	4.01	4.01			10.40	2.7 ~ 13.8	2710	240 ~ 4190	3.84	A
2.5 + 4.2 + 5.0	11.7	2.22	3.73	4.45			10.40	2.7 ~ 13.8	2560	270 ~ 3980	4.06	A
2.5 + 4.2 + 6.0	12.7	2.05	3.44	4.91			10.40	2.7 ~ 14.1	2560	270 ~ 4100	4.06	A
2.5 + 4.2 + 7.1	13.8	1.88	3.17	5.35			10.40	2.7 ~ 14.1	2540	270 ~ 4080	4.09	A
2.5 + 5.0 + 5.0	12.5	2.08	4.16	4.16			10.40	2.7 ~ 13.8	2460	310 ~ 3780	4.23	A
2.5 + 5.0 + 6.0	13.5	1.93	3.85	4.62			10.40	2.7 ~ 14.1	2460	310 ~ 3950	4.23	A
2.5 + 5.0 + 7.1	14.6	1.78	3.56	5.06			10.40	2.7 ~ 14.1	2490	320 ~ 3940	4.18	A
2.5 + 6.0 + 6.0	14.5	1.80	4.30	4.30			10.40	2.7 ~ 14.1	2460	310 ~ 3950	4.23	A
2.5 + 6.0 + 7.1	15.6	1.67	4.00	4.73			10.40	2.7 ~ 14.4	2490	320 ~ 4050	4.18	A
2.5 + 7.1 + 7.1	16.7	1.56	4.42	4.42			10.40	2.7 ~ 14.4	2480	330 ~ 4040	4.19	A
3.5 + 3.5 + 3.5	10.5	3.46	3.46	3.46			10.38	2.7 ~ 13.8	2660	240 ~ 4180	3.90	A
3.5 + 3.5 + 4.2	11.2	3.25	3.25	3.90			10.40	2.7 ~ 13.8	2650	240 ~ 4170	3.92	A
3.5 + 3.5 + 5.0	12.0	3.03	3.03	4.34			10.40	2.7 ~ 13.8	2540	270 ~ 3960	4.09	A
3.5 + 3.5 + 6.0	13.0	2.80	2.80	4.80			10.40	2.7 ~ 14.1	2540	270 ~ 4080	4.09	A
3.5 + 3.5 + 7.1	14.1	2.58	2.58	5.24			10.40	2.7 ~ 14.1	2530	270 ~ 4060	4.11	A
3.5 + 4.2 + 4.2	11.9	3.06	3.67	3.67			10.40	2.7 ~ 13.8	2640	250 ~ 4150	3.94	A
3.5 + 4.2 + 5.0	12.7	2.87	3.44	4.09			10.40	2.7 ~ 14.1	2530	270 ~ 4070	4.11	A
3.5 + 4.2 + 6.0	13.7	2.66	3.19	4.55			10.40	2.7 ~ 14.1	2530	270 ~ 4070	4.11	A
3.5 + 4.2 + 7.1	14.8	2.46	2.95	4.99			10.40	2.7 ~ 14.1	2520	280 ~ 4050	4.13	A
3.5 + 5.0 + 5.0	13.5	2.70	3.85	3.85			10.40	2.7 ~ 14.1	2480	330 ~ 3920	4.19	A
3.5 + 5.0 + 6.0	14.5	2.51	3.59	4.30			10.40	2.7 ~ 14.1	2480	330 ~ 3920	4.19	A
3.5 + 5.0 + 7.1	15.6	2.33	3.33	4.74			10.40	2.7 ~ 14.4	2470	330 ~ 4020	4.21	A
3.5 + 6.0 + 6.0	15.5	2.34	4.03	4.03			10.40	2.7 ~ 14.4	2480	330 ~ 4040	4.19	A
3.5 + 6.0 + 7.1	16.6	2.19	3.76	4.45			10.40	2.7 ~ 14.4	2470	330 ~ 4020	4.21	A
3.5 + 7.1 + 7.1	17.7	2.06	4.17	4.17			10.40	2.7 ~ 14.4	2460	340 ~ 4000	4.23	A
4.2 + 4.2 + 4.2	12.6	3.46	3.46	3.46			10.38	2.7 ~ 13.8	2630	250 ~ 4080	3.95	A
4.2 + 4.2 + 5.0	13.4	3.26	3.26	3.88			10.40	2.7 ~ 14.1	2520	280 ~ 4050	4.13	A
4.2 + 4.2 + 6.0	14.4	3.03	3.03	4.34			10.40	2.7 ~ 14.1	2520	280 ~ 4050	4.13	A
4.2 + 4.2 + 7.1	15.5	2.82	2.82	4.76			10.40	2.7 ~ 14.4	2510	280 ~ 4150	4.14	A
4.2 + 5.0 + 5.0	14.2	3.08	3.66	3.66			10.40	2.7 ~ 14.1	2480	330 ~ 3910	4.19	A
4.2 + 5.0 + 6.0	15.2	2.87	3.42	4.11			10.40	2.7 ~ 14.4	2480	330 ~ 4020	4.19	A
4.2 + 5.0 + 7.1	16.3	2.68	3.19	4.53			10.40	2.7 ~ 14.4	2470	340 ~ 4010	4.21	A
4.2 + 6.0 + 6.0	16.2	2.70	3.85	3.85			10.40	2.7 ~ 14.4	2480	330 ~ 4020	4.19	A
4.2 + 6.0 + 7.1	17.3	2.52	3.61	4.27			10.40	2.7 ~ 14.4	2470	340 ~ 4010	4.21	A
5.0 + 5.0 + 5.0	15.0	3.46	3.46	3.46			10.38	2.7 ~ 14.4	2450	400 ~ 3940	4.24	A
5.0 + 5.0 + 6.0	16.0	3.25	3.25	3.90			10.40	2.7 ~ 14.4	2450	400 ~ 3940	4.24	A
5.0 + 5.0 + 7.1	17.1	3.04	3.04	4.32			10.40	2.7 ~ 14.4	2440	410 ~ 3930	4.26	A
5.0 + 6.0 + 6.0	17.0	3.06	3.67	3.67			10.40	2.7 ~ 14.4	2450	400 ~ 3940	4.24	A
5.0 + 6.0 + 7.1	18.1	2.87	3.45	4.08			10.40	2.7 ~ 14.4	2440	410 ~ 3930	4.26	A
6.0 + 6.0 + 6.0	18.0	3.46	3.46	3.46			10.38	2.7 ~ 14.4	2450	400 ~ 3940	4.24	A

3 Room

	Indoor unit capacity Heating	Annual Energy Consumption (kWh)	Current 230V (A)	ERP				Moisture Removal Volume l/h
				Pdesign (kW)	SCOP		Annual Consumption (kWh)	
					W/W	CLASS		
3 Room	2.0 + 5.0 + 5.0	1230	11.6	7.60	3.80	A	2800	
	2.0 + 5.0 + 6.0	1230	11.6	7.60	3.80	A	2800	
	2.0 + 5.0 + 7.1	1245	11.7	7.60	3.80	A	2800	
	2.0 + 6.0 + 6.0	1230	11.6	7.60	3.80	A	2800	
	2.0 + 6.0 + 7.1	1245	11.7	7.60	3.80	A	2800	
	2.0 + 7.1 + 7.1	1240	11.7	7.60	3.80	A	2800	
	2.5 + 2.5 + 2.5	1355	12.7	6.60	3.80	A	2432	
	2.5 + 2.5 + 3.5	1380	13.0	7.60	3.80	A	2800	
	2.5 + 2.5 + 4.2	1375	12.9	7.60	3.80	A	2800	
	2.5 + 2.5 + 5.0	1295	12.2	7.60	3.80	A	2800	
	2.5 + 2.5 + 6.0	1295	12.2	7.60	3.80	A	2800	
	2.5 + 2.5 + 7.1	1290	12.1	7.60	3.80	A	2800	
	2.5 + 3.5 + 3.5	1365	12.8	7.60	3.80	A	2800	
	2.5 + 3.5 + 4.2	1360	12.8	7.60	3.80	A	2800	
	2.5 + 3.5 + 5.0	1280	12.0	7.60	3.80	A	2800	
	2.5 + 3.5 + 6.0	1280	12.0	7.60	3.80	A	2800	
	2.5 + 3.5 + 7.1	1275	12.0	7.60	3.80	A	2800	
	2.5 + 4.2 + 4.2	1355	12.7	7.60	3.80	A	2800	
	2.5 + 4.2 + 5.0	1280	12.0	7.60	3.80	A	2800	
	2.5 + 4.2 + 6.0	1280	12.0	7.60	3.80	A	2800	
	2.5 + 4.2 + 7.1	1270	11.9	7.60	3.80	A	2800	
	2.5 + 5.0 + 5.0	1230	11.6	7.60	3.80	A	2800	
	2.5 + 5.0 + 6.0	1230	11.6	7.60	3.80	A	2800	
	2.5 + 5.0 + 7.1	1245	11.7	7.60	3.80	A	2800	
	2.5 + 6.0 + 6.0	1230	11.6	7.60	3.80	A	2800	
	2.5 + 6.0 + 7.1	1245	11.7	7.60	3.80	A	2800	
	2.5 + 7.1 + 7.1	1240	11.7	7.60	3.80	A	2800	
	3.5 + 3.5 + 3.5	1330	12.5	7.60	3.80	A	2800	
	3.5 + 3.5 + 4.2	1325	12.5	7.60	3.80	A	2800	
	3.5 + 3.5 + 5.0	1270	11.9	7.60	3.80	A	2800	
	3.5 + 3.5 + 6.0	1270	11.9	7.60	3.80	A	2800	
	3.5 + 3.5 + 7.1	1265	11.9	7.60	3.80	A	2800	
	3.5 + 4.2 + 4.2	1320	12.4	7.60	3.80	A	2800	
	3.5 + 4.2 + 5.0	1265	11.9	7.60	3.80	A	2800	
	3.5 + 4.2 + 6.0	1265	11.9	7.60	3.80	A	2800	
	3.5 + 4.2 + 7.1	1260	11.8	7.60	3.80	A	2800	
	3.5 + 5.0 + 5.0	1240	11.7	7.60	3.80	A	2800	
	3.5 + 5.0 + 6.0	1240	11.7	7.60	3.80	A	2800	
	3.5 + 5.0 + 7.1	1235	11.6	7.60	3.80	A	2800	
	3.5 + 6.0 + 6.0	1240	11.7	7.60	3.80	A	2800	
3.5 + 6.0 + 7.1	1235	11.6	7.60	3.80	A	2800		
3.5 + 7.1 + 7.1	1230	11.6	7.60	3.80	A	2800		
4.2 + 4.2 + 4.2	1315	12.4	7.60	3.80	A	2800		
4.2 + 4.2 + 5.0	1260	11.8	7.60	3.80	A	2800		
4.2 + 4.2 + 6.0	1260	11.8	7.60	3.80	A	2800		
4.2 + 4.2 + 7.1	1255	11.8	7.60	3.80	A	2800		
4.2 + 5.0 + 5.0	1240	11.7	7.60	3.80	A	2800		
4.2 + 5.0 + 6.0	1240	11.7	7.60	3.80	A	2800		
4.2 + 5.0 + 7.1	1235	11.6	7.60	3.80	A	2800		
4.2 + 6.0 + 6.0	1240	11.7	7.60	3.80	A	2800		
4.2 + 6.0 + 7.1	1235	11.6	7.60	3.80	A	2800		
5.0 + 5.0 + 5.0	1225	11.5	7.60	3.80	A	2800		
5.0 + 5.0 + 6.0	1225	11.5	7.60	3.80	A	2800		
5.0 + 5.0 + 7.1	1220	11.5	7.60	3.80	A	2800		
5.0 + 6.0 + 6.0	1225	11.5	7.60	3.80	A	2800		
5.0 + 6.0 + 7.1	1220	11.5	7.60	3.80	A	2800		
6.0 + 6.0 + 6.0	1225	11.5	7.60	3.80	A	2800		

Indoor unit capacity Heating	Total	Heating Capacity (kW)						Input Power (W)		COP		
		Room A	Room B	Room C	Room D	Room E	Total	min ~ max	Rating	min ~ max	WW	CLASS
1.6 + 1.6 + 1.6 + 1.6	6.4	2.35	2.35	2.35	2.35		9.40	3.4 ~ 14.2	2470	340 ~ 4240	3.81	A
1.6 + 1.6 + 1.6 + 2.0	6.8	2.33	2.33	2.33	2.91		9.90	3.4 ~ 14.2	2600	340 ~ 4230	3.81	A
1.6 + 1.6 + 1.6 + 2.5	7.3	2.26	2.26	2.26	3.52		10.30	3.4 ~ 14.2	2590	340 ~ 4230	3.98	A
1.6 + 1.6 + 1.6 + 3.5	8.3	2.00	2.00	2.00	4.40		10.40	3.4 ~ 14.2	2610	340 ~ 4200	3.98	A
1.6 + 1.6 + 1.6 + 4.2	9.0	1.85	1.85	1.85	4.85		10.40	3.4 ~ 14.2	2600	340 ~ 4180	4.00	A
1.6 + 1.6 + 1.6 + 5.0	9.8	1.70	1.70	1.70	5.30		10.40	3.4 ~ 14.2	2560	390 ~ 4040	4.06	A
1.6 + 1.6 + 1.6 + 6.0	10.8	1.54	1.54	1.54	5.78		10.40	3.4 ~ 14.2	2560	390 ~ 4040	4.06	A
1.6 + 1.6 + 1.6 + 7.1	11.9	1.40	1.40	1.40	6.20		10.40	3.4 ~ 14.2	2550	400 ~ 4020	4.08	A
1.6 + 1.6 + 2.0 + 2.0	7.2	2.31	2.31	2.89	2.89		10.40	3.4 ~ 14.2	2630	340 ~ 4220	3.95	A
1.6 + 1.6 + 2.0 + 2.5	7.7	2.16	2.16	2.70	3.38		10.40	3.4 ~ 14.2	2630	340 ~ 4220	3.95	A
1.6 + 1.6 + 2.0 + 3.5	8.7	1.91	1.91	2.39	4.19		10.40	3.4 ~ 14.2	2600	340 ~ 4180	4.00	A
1.6 + 1.6 + 2.0 + 4.2	9.4	1.77	1.77	2.21	4.65		10.40	3.4 ~ 14.2	2600	340 ~ 4170	4.00	A
1.6 + 1.6 + 2.0 + 5.0	10.2	1.63	1.63	2.04	5.10		10.40	3.4 ~ 14.2	2550	400 ~ 4030	4.08	A
1.6 + 1.6 + 2.0 + 6.0	11.2	1.49	1.49	1.86	5.56		10.40	3.4 ~ 14.2	2550	400 ~ 4030	4.08	A
1.6 + 1.6 + 2.0 + 7.1	12.3	1.35	1.35	1.69	6.01		10.40	3.4 ~ 14.2	2550	400 ~ 4010	4.08	A
1.6 + 1.6 + 2.5 + 2.5	8.2	2.03	2.03	3.17	3.17		10.40	3.4 ~ 14.2	2630	340 ~ 4220	3.95	A
1.6 + 1.6 + 2.5 + 3.5	9.2	1.81	1.81	2.83	3.95		10.40	3.4 ~ 14.2	2600	340 ~ 4180	4.00	A
1.6 + 1.6 + 2.5 + 4.2	9.9	1.68	1.68	2.63	4.41		10.40	3.4 ~ 14.2	2600	340 ~ 4170	4.00	A
1.6 + 1.6 + 2.5 + 5.0	10.7	1.56	1.56	2.43	4.85		10.40	3.4 ~ 14.2	2550	400 ~ 4030	4.08	A
1.6 + 1.6 + 2.5 + 6.0	11.7	1.42	1.42	2.22	5.34		10.40	3.4 ~ 14.2	2550	400 ~ 4030	4.08	A
1.6 + 1.6 + 2.5 + 7.1	12.8	1.30	1.30	2.03	5.77		10.40	3.4 ~ 14.4	2550	400 ~ 4070	4.08	A
1.6 + 1.6 + 3.5 + 3.5	10.2	1.63	1.63	3.57	3.57		10.40	3.4 ~ 14.2	2580	360 ~ 4150	4.03	A
1.6 + 1.6 + 3.5 + 4.2	10.9	1.53	1.53	3.34	4.00		10.40	3.4 ~ 14.2	2570	360 ~ 4080	4.05	A
1.6 + 1.6 + 3.5 + 5.0	11.7	1.42	1.42	3.11	4.45		10.40	3.4 ~ 14.2	2540	420 ~ 3990	4.09	A
1.6 + 1.6 + 3.5 + 6.0	12.7	1.31	1.31	2.87	4.91		10.40	3.4 ~ 14.2	2540	420 ~ 3990	4.09	A
1.6 + 1.6 + 3.5 + 7.1	13.8	1.21	1.21	2.64	5.34		10.40	3.4 ~ 14.4	2530	420 ~ 4040	4.11	A
1.6 + 1.6 + 4.2 + 4.2	11.6	1.43	1.43	3.77	3.77		10.40	3.4 ~ 14.2	2570	370 ~ 4060	4.05	A
1.6 + 1.6 + 4.2 + 5.0	12.4	1.34	1.34	3.52	4.20		10.40	3.4 ~ 14.2	2530	420 ~ 3980	4.11	A
1.6 + 1.6 + 4.2 + 6.0	13.4	1.24	1.24	3.26	4.66		10.40	3.4 ~ 14.4	2530	420 ~ 4040	4.11	A
1.6 + 1.6 + 4.2 + 7.1	14.5	1.15	1.15	3.01	5.09		10.40	3.4 ~ 14.4	2560	430 ~ 4020	4.06	A
1.6 + 1.6 + 5.0 + 5.0	13.2	1.26	1.26	3.94	3.94		10.40	3.4 ~ 14.4	2560	490 ~ 3970	4.06	A
1.6 + 1.6 + 5.0 + 6.0	14.2	1.17	1.17	3.66	4.40		10.40	3.4 ~ 14.4	2560	490 ~ 3970	4.06	A
1.6 + 1.6 + 5.0 + 7.1	15.3	1.09	1.09	3.40	4.82		10.40	3.4 ~ 14.4	2550	510 ~ 3950	4.08	A
1.6 + 1.6 + 6.0 + 6.0	15.2	1.09	1.09	4.11	4.11		10.40	3.4 ~ 14.4	2560	490 ~ 3970	4.06	A
1.6 + 1.6 + 6.0 + 7.1	16.3	1.02	1.02	3.83	4.53		10.40	3.4 ~ 14.4	2550	510 ~ 3950	4.08	A
1.6 + 1.6 + 7.1 + 7.1	17.4	0.96	0.96	4.24	4.24		10.40	3.4 ~ 14.4	2540	510 ~ 4000	4.09	A
1.6 + 2.0 + 2.0 + 2.0	7.6	2.18	2.74	2.74	2.74		10.40	3.4 ~ 14.2	2620	340 ~ 4210	3.97	A
1.6 + 2.0 + 2.0 + 2.5	8.1	2.05	2.57	2.57	3.21		10.40	3.4 ~ 14.2	2620	340 ~ 4210	3.97	A
1.6 + 2.0 + 2.0 + 3.5	9.1	1.83	2.29	2.29	3.99		10.40	3.4 ~ 14.2	2600	340 ~ 4170	4.00	A
1.6 + 2.0 + 2.0 + 4.2	9.8	1.70	2.12	2.12	4.46		10.40	3.4 ~ 14.2	2590	350 ~ 4160	4.02	A
1.6 + 2.0 + 2.0 + 5.0	10.6	1.57	1.96	1.96	4.91		10.40	3.4 ~ 14.2	2550	400 ~ 4020	4.08	A
1.6 + 2.0 + 2.0 + 6.0	11.6	1.43	1.79	1.79	5.39		10.40	3.4 ~ 14.2	2550	400 ~ 4020	4.08	A
1.6 + 2.0 + 2.0 + 7.1	12.7	1.31	1.64	1.64	5.81		10.40	3.4 ~ 14.2	2540	420 ~ 4000	4.09	A
1.6 + 2.0 + 2.5 + 2.5	8.6	1.93	2.43	3.02	3.02		10.40	3.4 ~ 14.2	2620	340 ~ 4210	3.97	A
1.6 + 2.0 + 2.5 + 3.5	9.6	1.73	2.17	2.71	3.79		10.40	3.4 ~ 14.2	2600	340 ~ 4170	4.00	A
1.6 + 2.0 + 2.5 + 4.2	10.3	1.62	2.02	2.52	4.24		10.40	3.4 ~ 14.2	2590	350 ~ 4160	4.02	A
1.6 + 2.0 + 2.5 + 5.0	11.1	1.50	1.87	2.34	4.69		10.40	3.4 ~ 14.2	2550	400 ~ 4020	4.08	A
1.6 + 2.0 + 2.5 + 6.0	12.1	1.38	1.72	2.15	5.15		10.40	3.4 ~ 14.2	2550	400 ~ 4020	4.08	A
1.6 + 2.0 + 2.5 + 7.1	13.2	1.26	1.58	1.97	5.59		10.40	3.4 ~ 14.4	2540	420 ~ 4060	4.09	A
1.6 + 2.0 + 3.5 + 3.5	10.6	1.57	1.97	3.43	3.43		10.40	3.4 ~ 14.2	2570	360 ~ 4080	4.05	A
1.6 + 2.0 + 3.5 + 4.2	11.3	1.47	1.84	3.22	3.87		10.40	3.4 ~ 14.2	2570	370 ~ 4060	4.05	A
1.6 + 2.0 + 3.5 + 5.0	12.1	1.38	1.72	3.01	4.29		10.40	3.4 ~ 14.2	2530	420 ~ 3980	4.11	A
1.6 + 2.0 + 3.5 + 6.0	13.1	1.27	1.59	2.78	4.76		10.40	3.4 ~ 14.4	2530	420 ~ 4040	4.11	A
1.6 + 2.0 + 3.5 + 7.1	14.2	1.17	1.46	2.56	5.21		10.40	3.4 ~ 14.4	2560	430 ~ 4020	4.06	A
1.6 + 2.0 + 4.2 + 4.2	12.0	1.39	1.73	3.64	3.64		10.40	3.4 ~ 14.2	2560	370 ~ 4050	4.06	A
1.6 + 2.0 + 4.2 + 5.0	12.8	1.30	1.63	3.41	4.06		10.40	3.4 ~ 14.4	2520	420 ~ 4030	4.13	A
1.6 + 2.0 + 4.2 + 6.0	13.8	1.21	1.51	3.17	4.51		10.40	3.4 ~ 14.4	2520	420 ~ 4030	4.13	A
1.6 + 2.0 + 4.2 + 7.1	14.9	1.12	1.40	2.93	4.95		10.40	3.4 ~ 14.4	2560	430 ~ 4010	4.06	A

	Indoor unit capacity Heating	Annual Energy Consumption (kWh)	Current 230V (A)	ERP				Moisture Removal Volume l/h
				Pdesign (kW)	SCOP		Annual Consumption (kWh)	
					W/W	CLASS		
4 Room	1.6 + 1.6 + 1.6 + 1.6	1235	11.6	7.60	3.80	A	2800	
	1.6 + 1.6 + 1.6 + 2.0	1300	12.2	7.60	3.80	A	2800	
	1.6 + 1.6 + 1.6 + 2.5	1295	12.2	7.60	3.80	A	2800	
	1.6 + 1.6 + 1.6 + 3.5	1305	12.3	7.60	3.80	A	2800	
	1.6 + 1.6 + 1.6 + 4.2	1300	12.2	7.60	3.80	A	2800	
	1.6 + 1.6 + 1.6 + 5.0	1280	12.0	7.60	3.80	A	2800	
	1.6 + 1.6 + 1.6 + 6.0	1280	12.0	7.60	3.80	A	2800	
	1.6 + 1.6 + 1.6 + 7.1	1275	12.0	7.60	3.80	A	2800	
	1.6 + 1.6 + 2.0 + 2.0	1315	12.4	7.60	3.80	A	2800	
	1.6 + 1.6 + 2.0 + 2.5	1315	12.4	7.60	3.80	A	2800	
	1.6 + 1.6 + 2.0 + 3.5	1300	12.2	7.60	3.80	A	2800	
	1.6 + 1.6 + 2.0 + 4.2	1300	12.2	7.60	3.80	A	2800	
	1.6 + 1.6 + 2.0 + 5.0	1275	12.0	7.60	3.80	A	2800	
	1.6 + 1.6 + 2.0 + 6.0	1275	12.0	7.60	3.80	A	2800	
	1.6 + 1.6 + 2.0 + 7.1	1275	12.0	7.60	3.80	A	2800	
	1.6 + 1.6 + 2.5 + 2.5	1315	12.4	7.60	3.80	A	2800	
	1.6 + 1.6 + 2.5 + 3.5	1300	12.2	7.60	3.80	A	2800	
	1.6 + 1.6 + 2.5 + 4.2	1300	12.2	7.60	3.80	A	2800	
	1.6 + 1.6 + 2.5 + 5.0	1275	12.0	7.60	3.80	A	2800	
	1.6 + 1.6 + 2.5 + 6.0	1275	12.0	7.60	3.80	A	2800	
	1.6 + 1.6 + 2.5 + 7.1	1275	12.0	7.60	3.80	A	2800	
	1.6 + 1.6 + 3.5 + 3.5	1290	12.1	7.60	3.80	A	2800	
	1.6 + 1.6 + 3.5 + 4.2	1285	12.1	7.60	3.80	A	2800	
	1.6 + 1.6 + 3.5 + 5.0	1270	11.9	7.60	3.80	A	2800	
	1.6 + 1.6 + 3.5 + 6.0	1270	11.9	7.60	3.80	A	2800	
	1.6 + 1.6 + 3.5 + 7.1	1265	11.9	7.60	3.80	A	2800	
	1.6 + 1.6 + 4.2 + 4.2	1285	12.1	7.60	3.80	A	2800	
	1.6 + 1.6 + 4.2 + 5.0	1265	11.9	7.60	3.80	A	2800	
	1.6 + 1.6 + 4.2 + 6.0	1265	11.9	7.60	3.80	A	2800	
	1.6 + 1.6 + 4.2 + 7.1	1280	12.0	7.60	3.80	A	2800	
	1.6 + 1.6 + 5.0 + 5.0	1280	12.0	7.60	3.80	A	2800	
	1.6 + 1.6 + 5.0 + 6.0	1280	12.0	7.60	3.80	A	2800	
	1.6 + 1.6 + 5.0 + 7.1	1275	12.0	7.60	3.80	A	2800	
	1.6 + 1.6 + 6.0 + 6.0	1280	12.0	7.60	3.80	A	2800	
	1.6 + 1.6 + 6.0 + 7.1	1275	12.0	7.60	3.80	A	2800	
	1.6 + 1.6 + 7.1 + 7.1	1270	11.9	7.60	3.80	A	2800	
	1.6 + 2.0 + 2.0 + 2.0	1310	12.3	7.60	3.80	A	2800	
	1.6 + 2.0 + 2.0 + 2.5	1310	12.3	7.60	3.80	A	2800	
	1.6 + 2.0 + 2.0 + 3.5	1300	12.2	7.60	3.80	A	2800	
	1.6 + 2.0 + 2.0 + 4.2	1295	12.2	7.60	3.80	A	2800	
	1.6 + 2.0 + 2.0 + 5.0	1275	12.0	7.60	3.80	A	2800	
	1.6 + 2.0 + 2.0 + 6.0	1275	12.0	7.60	3.80	A	2800	
	1.6 + 2.0 + 2.0 + 7.1	1270	11.9	7.60	3.80	A	2800	
	1.6 + 2.0 + 2.5 + 2.5	1310	12.3	7.60	3.80	A	2800	
	1.6 + 2.0 + 2.5 + 3.5	1300	12.2	7.60	3.80	A	2800	
1.6 + 2.0 + 2.5 + 4.2	1295	12.2	7.60	3.80	A	2800		
1.6 + 2.0 + 2.5 + 5.0	1275	12.0	7.60	3.80	A	2800		
1.6 + 2.0 + 2.5 + 6.0	1275	12.0	7.60	3.80	A	2800		
1.6 + 2.0 + 2.5 + 7.1	1270	11.9	7.60	3.80	A	2800		
1.6 + 2.0 + 3.5 + 3.5	1285	12.1	7.60	3.80	A	2800		
1.6 + 2.0 + 3.5 + 4.2	1285	12.1	7.60	3.80	A	2800		
1.6 + 2.0 + 3.5 + 5.0	1265	11.9	7.60	3.80	A	2800		
1.6 + 2.0 + 3.5 + 6.0	1265	11.9	7.60	3.80	A	2800		
1.6 + 2.0 + 3.5 + 7.1	1280	12.0	7.60	3.80	A	2800		
1.6 + 2.0 + 4.2 + 4.2	1280	12.0	7.60	3.80	A	2800		
1.6 + 2.0 + 4.2 + 5.0	1260	11.8	7.60	3.80	A	2800		
1.6 + 2.0 + 4.2 + 6.0	1260	11.8	7.60	3.80	A	2800		
1.6 + 2.0 + 4.2 + 7.1	1280	12.0	7.60	3.80	A	2800		

Indoor unit capacity Heating	Total	Heating Capacity (kW)							Input Power (W)		COP	
		Room A	Room B	Room C	Room D	Room E	Total	min ~ max	Rating	min ~ max	WW	CLASS
1.6 + 2.0 + 5.0 + 5.0	13.6	1.22	1.54	3.82	3.82		10.40	3.4 ~ 14.4	2550	500 ~ 3960	4.08	A
1.6 + 2.0 + 5.0 + 6.0	14.6	1.14	1.42	3.56	4.28		10.40	3.4 ~ 14.4	2550	500 ~ 3960	4.08	A
1.6 + 2.0 + 5.0 + 7.1	15.7	1.06	1.32	3.31	4.71		10.40	3.4 ~ 14.4	2550	510 ~ 4000	4.08	A
1.6 + 2.0 + 6.0 + 6.0	15.6	1.07	1.33	4.00	4.00		10.40	3.4 ~ 14.4	2550	500 ~ 3960	4.08	A
1.6 + 2.0 + 6.0 + 7.1	16.7	1.00	1.25	3.74	4.41		10.40	3.4 ~ 14.4	2550	510 ~ 4000	4.08	A
1.6 + 2.0 + 7.1 + 7.1	17.8	0.93	1.17	4.15	4.15		10.40	3.4 ~ 14.4	2580	520 ~ 3990	4.03	A
1.6 + 2.5 + 2.5 + 2.5	9.1	1.82	2.86	2.86	2.86		10.40	3.4 ~ 14.2	2620	340 ~ 4210	3.97	A
1.6 + 2.5 + 2.5 + 3.5	10.1	1.65	2.57	2.57	3.61		10.40	3.4 ~ 14.2	2600	340 ~ 4170	4.00	A
1.6 + 2.5 + 2.5 + 4.2	10.8	1.54	2.41	2.41	4.04		10.40	3.4 ~ 14.2	2590	350 ~ 4160	4.02	A
1.6 + 2.5 + 2.5 + 5.0	11.6	1.43	2.24	2.24	4.49		10.40	3.4 ~ 14.2	2550	400 ~ 4020	4.08	A
1.6 + 2.5 + 2.5 + 6.0	12.6	1.32	2.06	2.06	4.96		10.40	3.4 ~ 14.2	2550	400 ~ 4020	4.08	A
1.6 + 2.5 + 2.5 + 7.1	13.7	1.21	1.90	1.90	5.39		10.40	3.4 ~ 14.4	2540	420 ~ 4060	4.09	A
1.6 + 2.5 + 3.5 + 3.5	11.1	1.50	2.34	3.28	3.28		10.40	3.4 ~ 14.2	2570	360 ~ 4080	4.05	A
1.6 + 2.5 + 3.5 + 4.2	11.8	1.41	2.20	3.08	3.71		10.40	3.4 ~ 14.2	2570	370 ~ 4060	4.05	A
1.6 + 2.5 + 3.5 + 5.0	12.6	1.32	2.06	2.89	4.13		10.40	3.4 ~ 14.2	2530	420 ~ 3980	4.11	A
1.6 + 2.5 + 3.5 + 6.0	13.6	1.22	1.91	2.68	4.59		10.40	3.4 ~ 14.4	2530	420 ~ 4040	4.11	A
1.6 + 2.5 + 3.5 + 7.1	14.7	1.13	1.77	2.48	5.02		10.40	3.4 ~ 14.4	2560	430 ~ 4020	4.06	A
1.6 + 2.5 + 4.2 + 4.2	12.5	1.33	2.09	3.49	3.49		10.40	3.4 ~ 14.2	2560	370 ~ 4050	4.06	A
1.6 + 2.5 + 4.2 + 5.0	13.3	1.25	1.95	3.28	3.92		10.40	3.4 ~ 14.4	2520	420 ~ 4030	4.13	A
1.6 + 2.5 + 4.2 + 6.0	14.3	1.16	1.82	3.05	4.37		10.40	3.4 ~ 14.4	2520	420 ~ 4030	4.13	A
1.6 + 2.5 + 4.2 + 7.1	15.4	1.08	1.69	2.84	4.79		10.40	3.4 ~ 14.4	2560	430 ~ 4010	4.06	A
1.6 + 2.5 + 5.0 + 5.0	14.1	1.18	1.84	3.69	3.69		10.40	3.4 ~ 14.4	2550	500 ~ 3960	4.08	A
1.6 + 2.5 + 5.0 + 6.0	15.1	1.10	1.72	3.44	4.14		10.40	3.4 ~ 14.4	2550	500 ~ 3960	4.08	A
1.6 + 2.5 + 5.0 + 7.1	16.2	1.03	1.60	3.21	4.56		10.40	3.4 ~ 14.4	2550	510 ~ 4000	4.08	A
1.6 + 2.5 + 6.0 + 6.0	16.1	1.03	1.61	3.88	3.88		10.40	3.4 ~ 14.4	2550	500 ~ 3960	4.08	A
1.6 + 2.5 + 6.0 + 7.1	17.2	0.97	1.51	3.63	4.29		10.40	3.4 ~ 14.4	2550	510 ~ 4000	4.08	A
1.6 + 2.5 + 7.1 + 7.1	18.3	0.91	1.43	4.03	4.03		10.40	3.4 ~ 14.4	2580	520 ~ 3990	4.03	A
1.6 + 3.5 + 3.5 + 3.5	12.1	1.37	3.01	3.01	3.01		10.40	3.4 ~ 14.2	2550	370 ~ 4040	4.08	A
1.6 + 3.5 + 3.5 + 4.2	12.8	1.30	2.84	2.84	3.42		10.40	3.4 ~ 14.4	2590	370 ~ 4150	4.02	A
1.6 + 3.5 + 3.5 + 5.0	13.6	1.22	2.68	2.68	3.82		10.40	3.4 ~ 14.4	2560	430 ~ 4010	4.06	A
1.6 + 3.5 + 3.5 + 6.0	14.6	1.14	2.49	2.49	4.28		10.40	3.4 ~ 14.4	2560	430 ~ 4010	4.06	A
1.6 + 3.5 + 3.5 + 7.1	15.7	1.06	2.32	2.32	4.70		10.40	3.4 ~ 14.4	2550	450 ~ 4050	4.08	A
1.6 + 3.5 + 4.2 + 4.2	13.5	1.22	2.70	3.24	3.24		10.40	3.4 ~ 14.4	2580	370 ~ 4130	4.03	A
1.6 + 3.5 + 4.2 + 5.0	14.3	1.16	2.55	3.05	3.64		10.40	3.4 ~ 14.4	2550	450 ~ 4050	4.08	A
1.6 + 3.5 + 4.2 + 6.0	15.3	1.09	2.38	2.85	4.08		10.40	3.4 ~ 14.4	2550	450 ~ 4050	4.08	A
1.6 + 3.5 + 4.2 + 7.1	16.4	1.01	2.22	2.66	4.51		10.40	3.4 ~ 14.4	2540	450 ~ 4040	4.09	A
1.6 + 3.5 + 5.0 + 5.0	15.1	1.10	2.42	3.44	3.44		10.40	3.4 ~ 14.4	2580	520 ~ 3990	4.03	A
1.6 + 3.5 + 5.0 + 6.0	16.1	1.03	2.26	3.23	3.88		10.40	3.4 ~ 14.4	2580	520 ~ 3990	4.03	A
1.6 + 3.5 + 5.0 + 7.1	17.2	0.97	2.12	3.02	4.29		10.40	3.4 ~ 14.4	2580	540 ~ 3970	4.03	A
1.6 + 3.5 + 6.0 + 6.0	17.1	0.97	2.13	3.65	3.65		10.40	3.4 ~ 14.4	2580	520 ~ 3990	4.03	A
1.6 + 3.5 + 6.0 + 7.1	18.2	0.91	2.00	3.43	4.06		10.40	3.4 ~ 14.4	2580	540 ~ 3970	4.03	A
1.6 + 4.2 + 4.2 + 4.2	14.2	1.16	3.08	3.08	3.08		10.40	3.4 ~ 14.4	2570	390 ~ 4120	4.05	A
1.6 + 4.2 + 4.2 + 5.0	15.0	1.11	2.91	2.91	3.47		10.40	3.4 ~ 14.4	2550	450 ~ 4040	4.08	A
1.6 + 4.2 + 4.2 + 6.0	16.0	1.04	2.73	2.73	3.90		10.40	3.4 ~ 14.4	2550	450 ~ 4040	4.08	A
1.6 + 4.2 + 4.2 + 7.1	17.1	0.97	2.55	2.55	4.33		10.40	3.4 ~ 14.4	2540	460 ~ 4030	4.09	A
1.6 + 4.2 + 5.0 + 5.0	15.8	1.05	2.77	3.29	3.29		10.40	3.4 ~ 14.4	2580	530 ~ 3980	4.03	A
1.6 + 4.2 + 5.0 + 6.0	16.8	0.99	2.60	3.10	3.71		10.40	3.4 ~ 14.4	2580	530 ~ 3980	4.03	A
1.6 + 4.2 + 5.0 + 7.1	17.9	0.93	2.44	2.91	4.12		10.40	3.4 ~ 14.4	2570	540 ~ 3960	4.05	A
1.6 + 4.2 + 6.0 + 6.0	17.8	0.93	2.45	3.51	3.51		10.40	3.4 ~ 14.4	2580	530 ~ 3980	4.03	A
1.6 + 5.0 + 5.0 + 5.0	16.6	1.01	3.13	3.13	3.13		10.40	3.4 ~ 14.4	2630	630 ~ 3980	3.95	A
1.6 + 5.0 + 5.0 + 6.0	17.6	0.95	2.95	2.95	3.55		10.40	3.4 ~ 14.4	2630	630 ~ 3980	3.95	A
2.0 + 2.0 + 2.0 + 2.0	8.0	2.60	2.60	2.60	2.60		10.40	3.4 ~ 14.2	2610	340 ~ 4190	3.98	A
2.0 + 2.0 + 2.0 + 2.5	8.5	2.45	2.45	2.45	3.05		10.40	3.4 ~ 14.2	2610	340 ~ 4190	3.98	A
2.0 + 2.0 + 2.0 + 3.5	9.5	2.19	2.19	2.19	3.83		10.40	3.4 ~ 14.2	2590	350 ~ 4160	4.02	A
2.0 + 2.0 + 2.0 + 4.2	10.2	2.04	2.04	2.04	4.28		10.40	3.4 ~ 14.2	2580	360 ~ 4140	4.03	A
2.0 + 2.0 + 2.0 + 5.0	11.0	1.89	1.89	1.89	4.73		10.40	3.4 ~ 14.2	2540	420 ~ 4000	4.09	A
2.0 + 2.0 + 2.0 + 6.0	12.0	1.73	1.73	1.73	5.21		10.40	3.4 ~ 14.2	2540	420 ~ 4000	4.09	A
2.0 + 2.0 + 2.0 + 7.1	13.1	1.59	1.59	1.59	5.63		10.40	3.4 ~ 14.4	2530	420 ~ 4040	4.11	A



	Indoor unit capacity Heating	Annual Energy Consumption (kWh)	Current 230V (A)	ERP				Moisture Removal Volume l/h
				Pdesign (kW)	SCOP		Annual Consumption (kWh)	
					W/W	CLASS		
4 Room	1.6 + 2.0 + 5.0 + 5.0	1275	12.0	7.60	3.80	A	2800	
	1.6 + 2.0 + 5.0 + 6.0	1275	12.0	7.60	3.80	A	2800	
	1.6 + 2.0 + 5.0 + 7.1	1275	12.0	7.60	3.80	A	2800	
	1.6 + 2.0 + 6.0 + 6.0	1275	12.0	7.60	3.80	A	2800	
	1.6 + 2.0 + 6.0 + 7.1	1275	12.0	7.60	3.80	A	2800	
	1.6 + 2.0 + 7.1 + 7.1	1290	12.1	7.60	3.80	A	2800	
	1.6 + 2.5 + 2.5 + 2.5	1310	12.3	7.60	3.80	A	2800	
	1.6 + 2.5 + 2.5 + 3.5	1300	12.2	7.60	3.80	A	2800	
	1.6 + 2.5 + 2.5 + 4.2	1295	12.2	7.60	3.80	A	2800	
	1.6 + 2.5 + 2.5 + 5.0	1275	12.0	7.60	3.80	A	2800	
	1.6 + 2.5 + 2.5 + 6.0	1275	12.0	7.60	3.80	A	2800	
	1.6 + 2.5 + 2.5 + 7.1	1270	11.9	7.60	3.80	A	2800	
	1.6 + 2.5 + 3.5 + 3.5	1285	12.1	7.60	3.80	A	2800	
	1.6 + 2.5 + 3.5 + 4.2	1285	12.1	7.60	3.80	A	2800	
	1.6 + 2.5 + 3.5 + 5.0	1265	11.9	7.60	3.80	A	2800	
	1.6 + 2.5 + 3.5 + 6.0	1265	11.9	7.60	3.80	A	2800	
	1.6 + 2.5 + 3.5 + 7.1	1280	12.0	7.60	3.80	A	2800	
	1.6 + 2.5 + 4.2 + 4.2	1280	12.0	7.60	3.80	A	2800	
	1.6 + 2.5 + 4.2 + 5.0	1260	11.8	7.60	3.80	A	2800	
	1.6 + 2.5 + 4.2 + 6.0	1260	11.8	7.60	3.80	A	2800	
	1.6 + 2.5 + 4.2 + 7.1	1280	12.0	7.60	3.80	A	2800	
	1.6 + 2.5 + 5.0 + 5.0	1275	12.0	7.60	3.80	A	2800	
	1.6 + 2.5 + 5.0 + 6.0	1275	12.0	7.60	3.80	A	2800	
	1.6 + 2.5 + 5.0 + 7.1	1275	12.0	7.60	3.80	A	2800	
	1.6 + 2.5 + 6.0 + 6.0	1275	12.0	7.60	3.80	A	2800	
	1.6 + 2.5 + 6.0 + 7.1	1275	12.0	7.60	3.80	A	2800	
	1.6 + 2.5 + 7.1 + 7.1	1290	12.1	7.60	3.80	A	2800	
	1.6 + 3.5 + 3.5 + 3.5	1275	12.0	7.60	3.80	A	2800	
	1.6 + 3.5 + 3.5 + 4.2	1295	12.2	7.60	3.80	A	2800	
	1.6 + 3.5 + 3.5 + 5.0	1280	12.0	7.60	3.80	A	2800	
	1.6 + 3.5 + 3.5 + 6.0	1280	12.0	7.60	3.80	A	2800	
	1.6 + 3.5 + 3.5 + 7.1	1275	12.0	7.60	3.80	A	2800	
	1.6 + 3.5 + 4.2 + 4.2	1290	12.1	7.60	3.80	A	2800	
	1.6 + 3.5 + 4.2 + 5.0	1275	12.0	7.60	3.80	A	2800	
	1.6 + 3.5 + 4.2 + 6.0	1275	12.0	7.60	3.80	A	2800	
	1.6 + 3.5 + 4.2 + 7.1	1270	11.9	7.60	3.80	A	2800	
	1.6 + 3.5 + 5.0 + 5.0	1290	12.1	7.60	3.80	A	2800	
	1.6 + 3.5 + 5.0 + 6.0	1290	12.1	7.60	3.80	A	2800	
	1.6 + 3.5 + 5.0 + 7.1	1290	12.1	7.60	3.80	A	2800	
	1.6 + 3.5 + 6.0 + 6.0	1290	12.1	7.60	3.80	A	2800	
1.6 + 3.5 + 6.0 + 7.1	1290	12.1	7.60	3.80	A	2800		
1.6 + 4.2 + 4.2 + 4.2	1285	12.1	7.60	3.80	A	2800		
1.6 + 4.2 + 4.2 + 5.0	1275	12.0	7.60	3.80	A	2800		
1.6 + 4.2 + 4.2 + 6.0	1275	12.0	7.60	3.80	A	2800		
1.6 + 4.2 + 4.2 + 7.1	1270	11.9	7.60	3.80	A	2800		
1.6 + 4.2 + 5.0 + 5.0	1290	12.1	7.60	3.80	A	2800		
1.6 + 4.2 + 5.0 + 6.0	1290	12.1	7.60	3.80	A	2800		
1.6 + 4.2 + 5.0 + 7.1	1285	12.1	7.60	3.80	A	2800		
1.6 + 4.2 + 6.0 + 6.0	1290	12.1	7.60	3.80	A	2800		
1.6 + 5.0 + 5.0 + 5.0	1315	12.4	7.60	3.80	A	2800		
1.6 + 5.0 + 5.0 + 6.0	1315	12.4	7.60	3.80	A	2800		
2.0 + 2.0 + 2.0 + 2.0	1305	12.3	7.60	3.80	A	2800		
2.0 + 2.0 + 2.0 + 2.5	1305	12.3	7.60	3.80	A	2800		
2.0 + 2.0 + 2.0 + 3.5	1295	12.2	7.60	3.80	A	2800		
2.0 + 2.0 + 2.0 + 4.2	1290	12.1	7.60	3.80	A	2800		
2.0 + 2.0 + 2.0 + 5.0	1270	11.9	7.60	3.80	A	2800		
2.0 + 2.0 + 2.0 + 6.0	1270	11.9	7.60	3.80	A	2800		
2.0 + 2.0 + 2.0 + 7.1	1265	11.9	7.60	3.80	A	2800		

Indoor unit capacity Heating	Total	Heating Capacity (kW)							Input Power (W)		COP	
		Room A	Room B	Room C	Room D	Room E	Total	min ~ max	Rating	min ~ max	WW	CLASS
2.0 + 2.0 + 2.5 + 2.5	9.0	2.31	2.31	2.89	2.89		10.40	3.4 ~ 14.2	2610	340 ~ 4190	3.98	A
2.0 + 2.0 + 2.5 + 3.5	10.0	2.08	2.08	2.60	3.64		10.40	3.4 ~ 14.2	2590	350 ~ 4160	4.02	A
2.0 + 2.0 + 2.5 + 4.2	10.7	1.94	1.94	2.43	4.09		10.40	3.4 ~ 14.2	2580	360 ~ 4140	4.03	A
2.0 + 2.0 + 2.5 + 5.0	11.5	1.81	1.81	2.26	4.52		10.40	3.4 ~ 14.2	2540	420 ~ 4000	4.09	A
2.0 + 2.0 + 2.5 + 6.0	12.5	1.66	1.66	2.08	5.00		10.40	3.4 ~ 14.2	2540	420 ~ 4000	4.09	A
2.0 + 2.0 + 2.5 + 7.1	13.6	1.53	1.53	1.91	5.43		10.40	3.4 ~ 14.4	2530	420 ~ 4040	4.11	A
2.0 + 2.0 + 3.5 + 3.5	11.0	1.89	1.89	3.31	3.31		10.40	3.4 ~ 14.2	2570	370 ~ 4060	4.05	A
2.0 + 2.0 + 3.5 + 4.2	11.7	1.78	1.78	3.11	3.73		10.40	3.4 ~ 14.2	2560	370 ~ 4050	4.06	A
2.0 + 2.0 + 3.5 + 5.0	12.5	1.66	1.66	2.91	4.17		10.40	3.4 ~ 14.2	2520	420 ~ 3970	4.13	A
2.0 + 2.0 + 3.5 + 6.0	13.5	1.54	1.54	2.70	4.62		10.40	3.4 ~ 14.4	2520	420 ~ 4030	4.13	A
2.0 + 2.0 + 3.5 + 7.1	14.6	1.42	1.42	2.49	5.07		10.40	3.4 ~ 14.4	2560	430 ~ 4010	4.06	A
2.0 + 2.0 + 4.2 + 4.2	12.4	1.68	1.68	3.52	3.52		10.40	3.4 ~ 14.2	2590	370 ~ 4040	4.02	A
2.0 + 2.0 + 4.2 + 5.0	13.2	1.58	1.58	3.31	3.93		10.40	3.4 ~ 14.4	2560	430 ~ 4020	4.06	A
2.0 + 2.0 + 4.2 + 6.0	14.2	1.46	1.46	3.08	4.40		10.40	3.4 ~ 14.4	2560	430 ~ 4020	4.06	A
2.0 + 2.0 + 4.2 + 7.1	15.3	1.36	1.36	2.85	4.83		10.40	3.4 ~ 14.4	2550	440 ~ 4060	4.08	A
2.0 + 2.0 + 5.0 + 5.0	14.0	1.49	1.49	3.71	3.71		10.40	3.4 ~ 14.4	2550	510 ~ 4000	4.08	A
2.0 + 2.0 + 5.0 + 6.0	15.0	1.39	1.39	3.47	4.15		10.40	3.4 ~ 14.4	2550	510 ~ 4000	4.08	A
2.0 + 2.0 + 5.0 + 7.1	16.1	1.29	1.29	3.23	4.59		10.40	3.4 ~ 14.4	2580	520 ~ 3990	4.03	A
2.0 + 2.0 + 6.0 + 6.0	16.0	1.30	1.30	3.90	3.90		10.40	3.4 ~ 14.4	2550	510 ~ 4000	4.08	A
2.0 + 2.0 + 6.0 + 7.1	17.1	1.22	1.22	3.65	4.31		10.40	3.4 ~ 14.4	2580	520 ~ 3990	4.03	A
2.0 + 2.0 + 7.1 + 7.1	18.2	1.14	1.14	4.06	4.06		10.40	3.4 ~ 14.4	2580	530 ~ 3980	4.03	A
2.0 + 2.5 + 2.5 + 2.5	9.5	2.18	2.74	2.74	2.74		10.40	3.4 ~ 14.2	2610	340 ~ 4190	3.98	A
2.0 + 2.5 + 2.5 + 3.5	10.5	1.98	2.48	2.48	3.46		10.40	3.4 ~ 14.2	2590	350 ~ 4160	4.02	A
2.0 + 2.5 + 2.5 + 4.2	11.2	1.86	2.32	2.32	3.90		10.40	3.4 ~ 14.2	2580	360 ~ 4140	4.03	A
2.0 + 2.5 + 2.5 + 5.0	12.0	1.73	2.17	2.17	4.33		10.40	3.4 ~ 14.2	2540	420 ~ 4000	4.09	A
2.0 + 2.5 + 2.5 + 6.0	13.0	1.60	2.00	2.00	4.80		10.40	3.4 ~ 14.4	2540	420 ~ 4060	4.09	A
2.0 + 2.5 + 2.5 + 7.1	14.1	1.48	1.84	1.84	5.24		10.40	3.4 ~ 14.4	2530	420 ~ 4040	4.11	A
2.0 + 2.5 + 3.5 + 3.5	11.5	1.80	2.26	3.17	3.17		10.40	3.4 ~ 14.2	2570	370 ~ 4060	4.05	A
2.0 + 2.5 + 3.5 + 4.2	12.2	1.70	2.13	2.98	3.59		10.40	3.4 ~ 14.2	2560	370 ~ 4050	4.06	A
2.0 + 2.5 + 3.5 + 5.0	13.0	1.60	2.00	2.80	4.00		10.40	3.4 ~ 14.4	2520	420 ~ 4030	4.13	A
2.0 + 2.5 + 3.5 + 6.0	14.0	1.49	1.86	2.60	4.45		10.40	3.4 ~ 14.4	2520	420 ~ 4030	4.13	A
2.0 + 2.5 + 3.5 + 7.1	15.1	1.38	1.72	2.41	4.89		10.40	3.4 ~ 14.4	2560	430 ~ 4010	4.06	A
2.0 + 2.5 + 4.2 + 4.2	12.9	1.60	2.02	3.39	3.39		10.40	3.4 ~ 14.4	2590	370 ~ 4160	4.02	A
2.0 + 2.5 + 4.2 + 5.0	13.7	1.52	1.90	3.19	3.79		10.40	3.4 ~ 14.4	2560	430 ~ 4020	4.06	A
2.0 + 2.5 + 4.2 + 6.0	14.7	1.41	1.77	2.97	4.25		10.40	3.4 ~ 14.4	2560	430 ~ 4020	4.06	A
2.0 + 2.5 + 4.2 + 7.1	15.8	1.32	1.65	2.76	4.67		10.40	3.4 ~ 14.4	2550	440 ~ 4060	4.08	A
2.0 + 2.5 + 5.0 + 5.0	14.5	1.43	1.79	3.59	3.59		10.40	3.4 ~ 14.4	2550	510 ~ 4000	4.08	A
2.0 + 2.5 + 5.0 + 6.0	15.5	1.34	1.68	3.35	4.03		10.40	3.4 ~ 14.4	2550	510 ~ 4000	4.08	A
2.0 + 2.5 + 5.0 + 7.1	16.6	1.25	1.57	3.13	4.45		10.40	3.4 ~ 14.4	2580	520 ~ 3990	4.03	A
2.0 + 2.5 + 6.0 + 6.0	16.5	1.26	1.58	3.78	3.78		10.40	3.4 ~ 14.4	2550	510 ~ 4000	4.08	A
2.0 + 2.5 + 6.0 + 7.1	17.6	1.18	1.48	3.55	4.19		10.40	3.4 ~ 14.4	2580	520 ~ 3990	4.03	A
2.0 + 3.5 + 3.5 + 3.5	12.5	1.67	2.91	2.91	2.91		10.40	3.4 ~ 14.2	2590	370 ~ 4030	4.02	A
2.0 + 3.5 + 3.5 + 4.2	13.2	1.58	2.76	2.76	3.30		10.40	3.4 ~ 14.4	2580	370 ~ 4130	4.03	A
2.0 + 3.5 + 3.5 + 5.0	14.0	1.49	2.60	2.60	3.71		10.40	3.4 ~ 14.4	2550	450 ~ 4050	4.08	A
2.0 + 3.5 + 3.5 + 6.0	15.0	1.39	2.43	2.43	4.15		10.40	3.4 ~ 14.4	2550	450 ~ 4050	4.08	A
2.0 + 3.5 + 3.5 + 7.1	16.1	1.29	2.26	2.26	4.59		10.40	3.4 ~ 14.4	2540	450 ~ 4040	4.09	A
2.0 + 3.5 + 4.2 + 4.2	13.9	1.50	2.62	3.14	3.14		10.40	3.4 ~ 14.4	2570	390 ~ 4120	4.05	A
2.0 + 3.5 + 4.2 + 5.0	14.7	1.41	2.48	2.97	3.54		10.40	3.4 ~ 14.4	2550	450 ~ 4040	4.08	A
2.0 + 3.5 + 4.2 + 6.0	15.7	1.32	2.32	2.78	3.98		10.40	3.4 ~ 14.4	2550	450 ~ 4040	4.08	A
2.0 + 3.5 + 4.2 + 7.1	16.8	1.24	2.17	2.60	4.39		10.40	3.4 ~ 14.4	2540	460 ~ 4030	4.09	A
2.0 + 3.5 + 5.0 + 5.0	15.5	1.34	2.36	3.35	3.35		10.40	3.4 ~ 14.4	2580	530 ~ 3980	4.03	A
2.0 + 3.5 + 5.0 + 6.0	16.5	1.26	2.21	3.15	3.78		10.40	3.4 ~ 14.4	2580	530 ~ 3980	4.03	A
2.0 + 3.5 + 5.0 + 7.1	17.6	1.18	2.07	2.95	4.20		10.40	3.4 ~ 14.4	2570	540 ~ 3960	4.05	A
2.0 + 3.5 + 6.0 + 6.0	17.5	1.19	2.07	3.57	3.57		10.40	3.4 ~ 14.4	2580	530 ~ 3980	4.03	A
2.0 + 4.2 + 4.2 + 4.2	14.6	1.43	2.99	2.99	2.99		10.40	3.4 ~ 14.4	2570	390 ~ 4110	4.05	A
2.0 + 4.2 + 4.2 + 5.0	15.4	1.35	2.84	2.84	3.37		10.40	3.4 ~ 14.4	2540	450 ~ 4030	4.09	A
2.0 + 4.2 + 4.2 + 6.0	16.4	1.27	2.66	2.66	3.81		10.40	3.4 ~ 14.4	2540	450 ~ 4030	4.09	A
2.0 + 4.2 + 4.2 + 7.1	17.5	1.19	2.50	2.50	4.21		10.40	3.4 ~ 14.4	2530	460 ~ 4010	4.11	A

	Indoor unit capacity Heating	Annual Energy Consumption (kWh)	Current 230V (A)	ERP				Moisture Removal Volume l/h
				Pdesign (kW)	SCOP		Annual Consumption (kWh)	
					W/W	CLASS		
4 Room	2.0 + 2.0 + 2.5 + 2.5	1305	12.3	7.60	3.80	A	2800	
	2.0 + 2.0 + 2.5 + 3.5	1295	12.2	7.60	3.80	A	2800	
	2.0 + 2.0 + 2.5 + 4.2	1290	12.1	7.60	3.80	A	2800	
	2.0 + 2.0 + 2.5 + 5.0	1270	11.9	7.60	3.80	A	2800	
	2.0 + 2.0 + 2.5 + 6.0	1270	11.9	7.60	3.80	A	2800	
	2.0 + 2.0 + 2.5 + 7.1	1265	11.9	7.60	3.80	A	2800	
	2.0 + 2.0 + 3.5 + 3.5	1285	12.1	7.60	3.80	A	2800	
	2.0 + 2.0 + 3.5 + 4.2	1280	12.0	7.60	3.80	A	2800	
	2.0 + 2.0 + 3.5 + 5.0	1260	11.8	7.60	3.80	A	2800	
	2.0 + 2.0 + 3.5 + 6.0	1260	11.8	7.60	3.80	A	2800	
	2.0 + 2.0 + 3.5 + 7.1	1280	12.0	7.60	3.80	A	2800	
	2.0 + 2.0 + 4.2 + 4.2	1295	12.2	7.60	3.80	A	2800	
	2.0 + 2.0 + 4.2 + 5.0	1280	12.0	7.60	3.80	A	2800	
	2.0 + 2.0 + 4.2 + 6.0	1280	12.0	7.60	3.80	A	2800	
	2.0 + 2.0 + 4.2 + 7.1	1275	12.0	7.60	3.80	A	2800	
	2.0 + 2.0 + 5.0 + 5.0	1275	12.0	7.60	3.80	A	2800	
	2.0 + 2.0 + 5.0 + 6.0	1275	12.0	7.60	3.80	A	2800	
	2.0 + 2.0 + 5.0 + 7.1	1290	12.1	7.60	3.80	A	2800	
	2.0 + 2.0 + 6.0 + 6.0	1275	12.0	7.60	3.80	A	2800	
	2.0 + 2.0 + 6.0 + 7.1	1290	12.1	7.60	3.80	A	2800	
	2.0 + 2.0 + 7.1 + 7.1	1290	12.1	7.60	3.80	A	2800	
	2.0 + 2.5 + 2.5 + 2.5	1305	12.3	7.60	3.80	A	2800	
	2.0 + 2.5 + 2.5 + 3.5	1295	12.2	7.60	3.80	A	2800	
	2.0 + 2.5 + 2.5 + 4.2	1290	12.1	7.60	3.80	A	2800	
	2.0 + 2.5 + 2.5 + 5.0	1270	11.9	7.60	3.80	A	2800	
	2.0 + 2.5 + 2.5 + 6.0	1270	11.9	7.60	3.80	A	2800	
	2.0 + 2.5 + 2.5 + 7.1	1265	11.9	7.60	3.80	A	2800	
	2.0 + 2.5 + 3.5 + 3.5	1285	12.1	7.60	3.80	A	2800	
	2.0 + 2.5 + 3.5 + 4.2	1280	12.0	7.60	3.80	A	2800	
	2.0 + 2.5 + 3.5 + 5.0	1260	11.8	7.60	3.80	A	2800	
	2.0 + 2.5 + 3.5 + 6.0	1260	11.8	7.60	3.80	A	2800	
	2.0 + 2.5 + 3.5 + 7.1	1280	12.0	7.60	3.80	A	2800	
	2.0 + 2.5 + 4.2 + 4.2	1295	12.2	7.60	3.80	A	2800	
	2.0 + 2.5 + 4.2 + 5.0	1280	12.0	7.60	3.80	A	2800	
	2.0 + 2.5 + 4.2 + 6.0	1280	12.0	7.60	3.80	A	2800	
	2.0 + 2.5 + 4.2 + 7.1	1275	12.0	7.60	3.80	A	2800	
	2.0 + 2.5 + 5.0 + 5.0	1275	12.0	7.60	3.80	A	2800	
	2.0 + 2.5 + 5.0 + 6.0	1275	12.0	7.60	3.80	A	2800	
	2.0 + 2.5 + 5.0 + 7.1	1290	12.1	7.60	3.80	A	2800	
	2.0 + 2.5 + 6.0 + 6.0	1275	12.0	7.60	3.80	A	2800	
	2.0 + 2.5 + 6.0 + 7.1	1290	12.1	7.60	3.80	A	2800	
	2.0 + 3.5 + 3.5 + 3.5	1295	12.2	7.60	3.80	A	2800	
2.0 + 3.5 + 3.5 + 4.2	1290	12.1	7.60	3.80	A	2800		
2.0 + 3.5 + 3.5 + 5.0	1275	12.0	7.60	3.80	A	2800		
2.0 + 3.5 + 3.5 + 6.0	1275	12.0	7.60	3.80	A	2800		
2.0 + 3.5 + 3.5 + 7.1	1270	11.9	7.60	3.80	A	2800		
2.0 + 3.5 + 4.2 + 4.2	1285	12.1	7.60	3.80	A	2800		
2.0 + 3.5 + 4.2 + 5.0	1275	12.0	7.60	3.80	A	2800		
2.0 + 3.5 + 4.2 + 6.0	1275	12.0	7.60	3.80	A	2800		
2.0 + 3.5 + 4.2 + 7.1	1270	11.9	7.60	3.80	A	2800		
2.0 + 3.5 + 5.0 + 5.0	1290	12.1	7.60	3.80	A	2800		
2.0 + 3.5 + 5.0 + 6.0	1290	12.1	7.60	3.80	A	2800		
2.0 + 3.5 + 5.0 + 7.1	1285	12.1	7.60	3.80	A	2800		
2.0 + 3.5 + 6.0 + 6.0	1290	12.1	7.60	3.80	A	2800		
2.0 + 4.2 + 4.2 + 4.2	1285	12.1	7.60	3.80	A	2800		
2.0 + 4.2 + 4.2 + 5.0	1270	11.9	7.60	3.80	A	2800		
2.0 + 4.2 + 4.2 + 6.0	1270	11.9	7.60	3.80	A	2800		
2.0 + 4.2 + 4.2 + 7.1	1265	11.9	7.60	3.80	A	2800		

Indoor unit capacity Heating	Total	Heating Capacity (kW)							Input Power (W)		COP	
		Room A	Room B	Room C	Room D	Room E	Total	min ~ max	Rating	min ~ max	WW	CLASS
2.0 + 4.2 + 5.0 + 5.0	16.2	1.28	2.70	3.21	3.21		10.40	3.4 ~ 14.4	2570	540 ~ 3970	4.05	A
2.0 + 4.2 + 5.0 + 6.0	17.2	1.21	2.54	3.02	3.63		10.40	3.4 ~ 14.4	2570	540 ~ 3970	4.05	A
2.0 + 4.2 + 5.0 + 7.1	18.3	1.14	2.39	2.84	4.03		10.40	3.4 ~ 14.4	2570	550 ~ 3950	4.05	A
2.0 + 4.2 + 6.0 + 6.0	18.2	1.14	2.40	3.43	3.43		10.40	3.4 ~ 14.4	2570	540 ~ 3970	4.05	A
2.0 + 5.0 + 5.0 + 5.0	17.0	1.22	3.06	3.06	3.06		10.40	3.4 ~ 14.4	2660	630 ~ 3970	3.91	A
2.0 + 5.0 + 5.0 + 6.0	18.0	1.16	2.89	2.89	3.46		10.40	3.4 ~ 14.4	2660	630 ~ 3970	3.91	A
2.5 + 2.5 + 2.5 + 2.5	10.0	2.60	2.60	2.60	2.60		10.40	3.4 ~ 14.2	2610	340 ~ 4190	3.98	A
2.5 + 2.5 + 2.5 + 3.5	11.0	2.36	2.36	2.36	3.32		10.40	3.4 ~ 14.2	2590	350 ~ 4160	4.02	A
2.5 + 2.5 + 2.5 + 4.2	11.7	2.22	2.22	2.22	3.74		10.40	3.4 ~ 14.2	2580	360 ~ 4140	4.03	A
2.5 + 2.5 + 2.5 + 5.0	12.5	2.08	2.08	2.08	4.16		10.40	3.4 ~ 14.2	2540	420 ~ 4000	4.09	A
2.5 + 2.5 + 2.5 + 6.0	13.5	1.93	1.93	1.93	4.61		10.40	3.4 ~ 14.4	2540	420 ~ 4060	4.09	A
2.5 + 2.5 + 2.5 + 7.1	14.6	1.78	1.78	1.78	5.06		10.40	3.4 ~ 14.4	2530	420 ~ 4040	4.11	A
2.5 + 2.5 + 3.5 + 3.5	12.0	2.17	2.17	3.03	3.03		10.40	3.4 ~ 14.2	2570	370 ~ 4060	4.05	A
2.5 + 2.5 + 3.5 + 4.2	12.7	2.05	2.05	2.87	3.43		10.40	3.4 ~ 14.2	2560	370 ~ 4050	4.06	A
2.5 + 2.5 + 3.5 + 5.0	13.5	1.93	1.93	2.70	3.84		10.40	3.4 ~ 14.4	2520	420 ~ 4030	4.13	A
2.5 + 2.5 + 3.5 + 6.0	14.5	1.79	1.79	2.51	4.31		10.40	3.4 ~ 14.4	2520	420 ~ 4030	4.13	A
2.5 + 2.5 + 3.5 + 7.1	15.6	1.67	1.67	2.33	4.73		10.40	3.4 ~ 14.4	2560	430 ~ 4010	4.06	A
2.5 + 2.5 + 4.2 + 4.2	13.4	1.94	1.94	3.26	3.26		10.40	3.4 ~ 14.4	2590	370 ~ 4160	4.02	A
2.5 + 2.5 + 4.2 + 5.0	14.2	1.83	1.83	3.08	3.66		10.40	3.4 ~ 14.4	2560	430 ~ 4020	4.06	A
2.5 + 2.5 + 4.2 + 6.0	15.2	1.71	1.71	2.87	4.11		10.40	3.4 ~ 14.4	2560	430 ~ 4020	4.06	A
2.5 + 2.5 + 4.2 + 7.1	16.3	1.60	1.60	2.68	4.52		10.40	3.4 ~ 14.4	2550	440 ~ 4060	4.08	A
2.5 + 2.5 + 5.0 + 5.0	15.0	1.73	1.73	3.47	3.47		10.40	3.4 ~ 14.4	2550	510 ~ 4000	4.08	A
2.5 + 2.5 + 5.0 + 6.0	16.0	1.63	1.63	3.25	3.89		10.40	3.4 ~ 14.4	2550	510 ~ 4000	4.08	A
2.5 + 2.5 + 5.0 + 7.1	17.1	1.52	1.52	3.04	4.32		10.40	3.4 ~ 14.4	2580	520 ~ 3990	4.03	A
2.5 + 2.5 + 6.0 + 6.0	17.0	1.53	1.53	3.67	3.67		10.40	3.4 ~ 14.4	2550	510 ~ 4000	4.08	A
2.5 + 2.5 + 6.0 + 7.1	18.1	1.44	1.44	3.45	4.07		10.40	3.4 ~ 14.4	2580	520 ~ 3990	4.03	A
2.5 + 3.5 + 3.5 + 3.5	13.0	2.00	2.80	2.80	2.80		10.40	3.4 ~ 14.4	2590	370 ~ 4150	4.02	A
2.5 + 3.5 + 3.5 + 4.2	13.7	1.90	2.66	2.66	3.18		10.40	3.4 ~ 14.4	2580	370 ~ 4130	4.03	A
2.5 + 3.5 + 3.5 + 5.0	14.5	1.79	2.51	2.51	3.59		10.40	3.4 ~ 14.4	2550	450 ~ 4050	4.08	A
2.5 + 3.5 + 3.5 + 6.0	15.5	1.68	2.35	2.35	4.02		10.40	3.4 ~ 14.4	2550	450 ~ 4050	4.08	A
2.5 + 3.5 + 3.5 + 7.1	16.6	1.57	2.19	2.19	4.45		10.40	3.4 ~ 14.4	2540	450 ~ 4040	4.09	A
2.5 + 3.5 + 4.2 + 4.2	14.4	1.81	2.53	3.03	3.03		10.40	3.4 ~ 14.4	2570	390 ~ 4120	4.05	A
2.5 + 3.5 + 4.2 + 5.0	15.2	1.71	2.39	2.87	3.43		10.40	3.4 ~ 14.4	2550	450 ~ 4040	4.08	A
2.5 + 3.5 + 4.2 + 6.0	16.2	1.60	2.25	2.70	3.85		10.40	3.4 ~ 14.4	2550	450 ~ 4040	4.08	A
2.5 + 3.5 + 4.2 + 7.1	17.3	1.50	2.10	2.52	4.28		10.40	3.4 ~ 14.4	2540	460 ~ 4030	4.09	A
2.5 + 3.5 + 5.0 + 5.0	16.0	1.62	2.28	3.25	3.25		10.40	3.4 ~ 14.4	2580	530 ~ 3980	4.03	A
2.5 + 3.5 + 5.0 + 6.0	17.0	1.53	2.14	3.06	3.67		10.40	3.4 ~ 14.4	2580	530 ~ 3980	4.03	A
2.5 + 3.5 + 5.0 + 7.1	18.1	1.44	2.01	2.87	4.08		10.40	3.4 ~ 14.4	2570	540 ~ 3960	4.05	A
2.5 + 3.5 + 6.0 + 6.0	18.0	1.44	2.02	3.47	3.47		10.40	3.4 ~ 14.4	2580	530 ~ 3980	4.03	A
2.5 + 4.2 + 4.2 + 4.2	15.1	1.73	2.89	2.89	2.89		10.40	3.4 ~ 14.4	2570	390 ~ 4110	4.05	A
2.5 + 4.2 + 4.2 + 5.0	15.9	1.64	2.75	2.75	3.26		10.40	3.4 ~ 14.4	2540	450 ~ 4030	4.09	A
2.5 + 4.2 + 4.2 + 6.0	16.9	1.54	2.58	2.58	3.70		10.40	3.4 ~ 14.4	2540	450 ~ 4030	4.09	A
2.5 + 4.2 + 4.2 + 7.1	18.0	1.44	2.43	2.43	4.10		10.40	3.4 ~ 14.4	2530	460 ~ 4010	4.11	A
2.5 + 4.2 + 5.0 + 5.0	16.7	1.56	2.62	3.11	3.11		10.40	3.4 ~ 14.4	2570	540 ~ 3970	4.05	A
2.5 + 4.2 + 5.0 + 6.0	17.7	1.47	2.47	2.94	3.52		10.40	3.4 ~ 14.4	2570	540 ~ 3970	4.05	A
2.5 + 5.0 + 5.0 + 5.0	17.5	1.49	2.97	2.97	2.97		10.40	3.4 ~ 14.4	2660	630 ~ 3970	3.91	A
3.5 + 3.5 + 3.5 + 3.5	14.0	2.60	2.60	2.60	2.60		10.40	3.4 ~ 14.4	2570	390 ~ 4110	4.05	A
3.5 + 3.5 + 3.5 + 4.2	14.7	2.48	2.48	2.48	2.96		10.40	3.4 ~ 14.4	2560	390 ~ 4100	4.06	A
3.5 + 3.5 + 3.5 + 5.0	15.5	2.35	2.35	2.35	3.35		10.40	3.4 ~ 14.4	2540	460 ~ 4020	4.09	A
3.5 + 3.5 + 3.5 + 6.0	16.5	2.21	2.21	2.21	3.77		10.40	3.4 ~ 14.4	2540	460 ~ 4020	4.09	A
3.5 + 3.5 + 3.5 + 7.1	17.6	2.07	2.07	2.07	4.19		10.40	3.4 ~ 14.4	2530	470 ~ 4010	4.11	A
3.5 + 3.5 + 4.2 + 4.2	15.4	2.36	2.36	2.84	2.84		10.40	3.4 ~ 14.4	2560	400 ~ 4090	4.06	A
3.5 + 3.5 + 4.2 + 5.0	16.2	2.25	2.25	2.70	3.20		10.40	3.4 ~ 14.4	2530	470 ~ 4010	4.11	A
3.5 + 3.5 + 4.2 + 6.0	17.2	2.12	2.12	2.54	3.62		10.40	3.4 ~ 14.4	2530	470 ~ 4010	4.11	A
3.5 + 3.5 + 4.2 + 7.1	18.3	1.99	1.99	2.39	4.03		10.40	3.4 ~ 14.4	2570	480 ~ 4000	4.05	A
3.5 + 3.5 + 5.0 + 5.0	17.0	2.14	2.14	3.06	3.06		10.40	3.4 ~ 14.4	2570	550 ~ 3950	4.05	A
3.5 + 3.5 + 5.0 + 6.0	18.0	2.02	2.02	2.89	3.47		10.40	3.4 ~ 14.4	2570	550 ~ 3950	4.05	A
3.5 + 4.2 + 4.2 + 4.2	16.1	2.27	2.71	2.71	2.71		10.40	3.4 ~ 14.4	2550	400 ~ 4070	4.08	A

	Indoor unit capacity Heating	Annual Energy Consumption (kWh)	Current 230V (A)	ERP				Moisture Removal Volume l/h
				Pdesign (kW)	SCOP		Annual Consumption (kWh)	
					W/W	CLASS		
4 Room	2.0 + 4.2 + 5.0 + 5.0	1285	12.1	7.60	3.80	A	2800	
	2.0 + 4.2 + 5.0 + 6.0	1285	12.1	7.60	3.80	A	2800	
	2.0 + 4.2 + 5.0 + 7.1	1285	12.1	7.60	3.80	A	2800	
	2.0 + 4.2 + 6.0 + 6.0	1285	12.1	7.60	3.80	A	2800	
	2.0 + 5.0 + 5.0 + 5.0	1330	12.5	7.60	3.80	A	2800	
	2.0 + 5.0 + 5.0 + 6.0	1330	12.5	7.60	3.80	A	2800	
	2.5 + 2.5 + 2.5 + 2.5	1305	12.3	7.60	3.80	A	2800	
	2.5 + 2.5 + 2.5 + 3.5	1295	12.2	7.60	3.80	A	2800	
	2.5 + 2.5 + 2.5 + 4.2	1290	12.1	7.60	3.80	A	2800	
	2.5 + 2.5 + 2.5 + 5.0	1270	11.9	7.60	3.80	A	2800	
	2.5 + 2.5 + 2.5 + 6.0	1270	11.9	7.60	3.80	A	2800	
	2.5 + 2.5 + 2.5 + 7.1	1265	11.9	7.60	3.80	A	2800	
	2.5 + 2.5 + 3.5 + 3.5	1285	12.1	7.60	3.80	A	2800	
	2.5 + 2.5 + 3.5 + 4.2	1280	12.0	7.60	3.80	A	2800	
	2.5 + 2.5 + 3.5 + 5.0	1260	11.8	7.60	3.80	A	2800	
	2.5 + 2.5 + 3.5 + 6.0	1260	11.8	7.60	3.80	A	2800	
	2.5 + 2.5 + 3.5 + 7.1	1280	12.0	7.60	3.80	A	2800	
	2.5 + 2.5 + 4.2 + 4.2	1295	12.2	7.60	3.80	A	2800	
	2.5 + 2.5 + 4.2 + 5.0	1280	12.0	7.60	3.80	A	2800	
	2.5 + 2.5 + 4.2 + 6.0	1280	12.0	7.60	3.80	A	2800	
	2.5 + 2.5 + 4.2 + 7.1	1275	12.0	7.60	3.80	A	2800	
	2.5 + 2.5 + 5.0 + 5.0	1275	12.0	7.60	3.80	A	2800	
	2.5 + 2.5 + 5.0 + 6.0	1275	12.0	7.60	3.80	A	2800	
	2.5 + 2.5 + 5.0 + 7.1	1290	12.1	7.60	3.80	A	2800	
	2.5 + 2.5 + 6.0 + 6.0	1275	12.0	7.60	3.80	A	2800	
	2.5 + 2.5 + 6.0 + 7.1	1290	12.1	7.60	3.80	A	2800	
	2.5 + 3.5 + 3.5 + 3.5	1295	12.2	7.60	3.80	A	2800	
	2.5 + 3.5 + 3.5 + 4.2	1290	12.1	7.60	3.80	A	2800	
	2.5 + 3.5 + 3.5 + 5.0	1275	12.0	7.60	3.80	A	2800	
	2.5 + 3.5 + 3.5 + 6.0	1275	12.0	7.60	3.80	A	2800	
	2.5 + 3.5 + 3.5 + 7.1	1270	11.9	7.60	3.80	A	2800	
	2.5 + 3.5 + 4.2 + 4.2	1285	12.1	7.60	3.80	A	2800	
	2.5 + 3.5 + 4.2 + 5.0	1275	12.0	7.60	3.80	A	2800	
	2.5 + 3.5 + 4.2 + 6.0	1275	12.0	7.60	3.80	A	2800	
	2.5 + 3.5 + 4.2 + 7.1	1270	11.9	7.60	3.80	A	2800	
	2.5 + 3.5 + 5.0 + 5.0	1290	12.1	7.60	3.80	A	2800	
	2.5 + 3.5 + 5.0 + 6.0	1290	12.1	7.60	3.80	A	2800	
	2.5 + 3.5 + 5.0 + 7.1	1285	12.1	7.60	3.80	A	2800	
	2.5 + 3.5 + 6.0 + 6.0	1290	12.1	7.60	3.80	A	2800	
	2.5 + 4.2 + 4.2 + 4.2	1285	12.1	7.60	3.80	A	2800	
	2.5 + 4.2 + 4.2 + 5.0	1270	11.9	7.60	3.80	A	2800	
	2.5 + 4.2 + 4.2 + 6.0	1270	11.9	7.60	3.80	A	2800	
2.5 + 4.2 + 4.2 + 7.1	1265	11.9	7.60	3.80	A	2800		
2.5 + 4.2 + 5.0 + 5.0	1285	12.1	7.60	3.80	A	2800		
2.5 + 4.2 + 5.0 + 6.0	1285	12.1	7.60	3.80	A	2800		
2.5 + 5.0 + 5.0 + 5.0	1330	12.5	7.60	3.80	A	2800		
3.5 + 3.5 + 3.5 + 3.5	1285	12.1	7.60	3.80	A	2800		
3.5 + 3.5 + 3.5 + 4.2	1280	12.0	7.60	3.80	A	2800		
3.5 + 3.5 + 3.5 + 5.0	1270	11.9	7.60	3.80	A	2800		
3.5 + 3.5 + 3.5 + 6.0	1270	11.9	7.60	3.80	A	2800		
3.5 + 3.5 + 3.5 + 7.1	1265	11.9	7.60	3.80	A	2800		
3.5 + 3.5 + 4.2 + 4.2	1280	12.0	7.60	3.80	A	2800		
3.5 + 3.5 + 4.2 + 5.0	1265	11.9	7.60	3.80	A	2800		
3.5 + 3.5 + 4.2 + 6.0	1265	11.9	7.60	3.80	A	2800		
3.5 + 3.5 + 4.2 + 7.1	1285	12.1	7.60	3.80	A	2800		
3.5 + 3.5 + 5.0 + 5.0	1285	12.1	7.60	3.80	A	2800		
3.5 + 3.5 + 5.0 + 6.0	1285	12.1	7.60	3.80	A	2800		
3.5 + 4.2 + 4.2 + 4.2	1275	12.0	7.60	3.80	A	2800		

Indoor unit capacity Heating		Total	Heating Capacity (kW)							Input Power (W)		COP	
			Room A	Room B	Room C	Room D	Room E	Total	min ~ max	Rating	min ~ max	WW	CLASS
4 Room	3.5 + 4.2 + 4.2 + 5.0	16.9	2.15	2.58	2.58	3.09		10.40	3.4 ~ 14.4	2570	480 ~ 4000	4.05	A
	3.5 + 4.2 + 4.2 + 6.0	17.9	2.03	2.44	2.44	3.49		10.40	3.4 ~ 14.4	2570	480 ~ 4000	4.05	A
	3.5 + 4.2 + 5.0 + 5.0	17.7	2.05	2.47	2.94	2.94		10.40	3.4 ~ 14.4	2600	560 ~ 3940	4.00	A
	4.2 + 4.2 + 4.2 + 4.2	16.8	2.60	2.60	2.60	2.60		10.40	3.4 ~ 14.4	2540	400 ~ 4060	4.09	A
	4.2 + 4.2 + 4.2 + 5.0	17.6	2.48	2.48	2.48	2.96		10.40	3.4 ~ 14.4	2560	480 ~ 3990	4.06	A

	Indoor unit capacity Heating	Annual Energy Consumption (kWh)	Current 230V (A)	ERP				Moisture Removal Volume l/h
				Pdesign (kW)	SCOP		Annual Consumption (kWh)	
					W/W	CLASS		
4 Room	3.5 + 4.2 + 4.2 + 5.0	1285	12.1	7.60	3.80	A	2800	
	3.5 + 4.2 + 4.2 + 6.0	1285	12.1	7.60	3.80	A	2800	
	3.5 + 4.2 + 5.0 + 5.0	1300	12.2	7.60	3.80	A	2800	
	4.2 + 4.2 + 4.2 + 4.2	1270	11.9	7.60	3.80	A	2800	
	4.2 + 4.2 + 4.2 + 5.0	1280	12.0	7.60	3.80	A	2800	

Indoor unit capacity Heating		Total	Heating Capacity (kW)						Input Power (W)			COP	
			Room A	Room B	Room C	Room D	Room E	Total	min ~ max	Rating	min ~ max	WW	CLASS
5 Room	1.6 + 1.6 + 1.6 + 1.6 + 1.6	8.0	2.08	2.08	2.08	2.08	2.08	10.40	3.4 ~ 14.5	2660	430 ~ 4170	3.91	A
	1.6 + 1.6 + 1.6 + 1.6 + 2.0	8.4	1.98	1.98	1.98	1.98	2.48	10.40	3.4 ~ 14.5	2650	440 ~ 4160	3.92	A
	1.6 + 1.6 + 1.6 + 1.6 + 2.5	8.9	1.87	1.87	1.87	1.87	2.92	10.40	3.4 ~ 14.5	2650	440 ~ 4160	3.92	A
	1.6 + 1.6 + 1.6 + 1.6 + 3.5	9.9	1.68	1.68	1.68	1.68	3.68	10.40	3.4 ~ 14.5	2640	450 ~ 4130	3.94	A
	1.6 + 1.6 + 1.6 + 1.6 + 4.2	10.6	1.57	1.57	1.57	1.57	4.12	10.40	3.4 ~ 14.5	2640	460 ~ 4170	3.94	A
	1.6 + 1.6 + 1.6 + 1.6 + 5.0	11.4	1.46	1.46	1.46	1.46	4.56	10.40	3.4 ~ 14.5	2670	540 ~ 4110	3.90	A
	1.6 + 1.6 + 1.6 + 1.6 + 6.0	12.4	1.34	1.34	1.34	1.34	5.04	10.40	3.4 ~ 14.5	2670	540 ~ 4110	3.90	A
	1.6 + 1.6 + 1.6 + 1.6 + 7.1	13.5	1.23	1.23	1.23	1.23	5.48	10.40	3.4 ~ 14.5	2710	560 ~ 4100	3.84	A
	1.6 + 1.6 + 1.6 + 2.0 + 2.0	8.8	1.89	1.89	1.89	2.36	2.36	10.39	3.4 ~ 14.5	2650	450 ~ 4150	3.92	A
	1.6 + 1.6 + 1.6 + 2.0 + 2.5	9.3	1.79	1.79	1.79	2.24	2.79	10.40	3.4 ~ 14.5	2650	450 ~ 4150	3.92	A
	1.6 + 1.6 + 1.6 + 2.0 + 3.5	10.3	1.62	1.62	1.62	2.02	3.52	10.40	3.4 ~ 14.5	2640	460 ~ 4170	3.94	A
	1.6 + 1.6 + 1.6 + 2.0 + 4.2	11.0	1.51	1.51	1.51	1.89	3.98	10.40	3.4 ~ 14.5	2630	470 ~ 4160	3.95	A
	1.6 + 1.6 + 1.6 + 2.0 + 5.0	11.8	1.41	1.41	1.41	1.76	4.41	10.40	3.4 ~ 14.5	2670	560 ~ 4100	3.90	A
	1.6 + 1.6 + 1.6 + 2.0 + 6.0	12.8	1.30	1.30	1.30	1.63	4.87	10.40	3.4 ~ 14.5	2670	560 ~ 4100	3.90	A
	1.6 + 1.6 + 1.6 + 2.0 + 7.1	13.9	1.20	1.20	1.20	1.50	5.30	10.40	3.4 ~ 14.5	2700	570 ~ 4090	3.85	A
	1.6 + 1.6 + 1.6 + 2.5 + 2.5	9.8	1.70	1.70	1.70	2.65	2.65	10.40	3.4 ~ 14.5	2650	450 ~ 4150	3.92	A
	1.6 + 1.6 + 1.6 + 2.5 + 3.5	10.8	1.54	1.54	1.54	2.41	3.37	10.40	3.4 ~ 14.5	2640	460 ~ 4170	3.94	A
	1.6 + 1.6 + 1.6 + 2.5 + 4.2	11.5	1.45	1.45	1.45	2.26	3.79	10.40	3.4 ~ 14.5	2630	470 ~ 4160	3.95	A
	1.6 + 1.6 + 1.6 + 2.5 + 5.0	12.3	1.35	1.35	1.35	2.11	4.24	10.40	3.4 ~ 14.5	2670	560 ~ 4100	3.90	A
	1.6 + 1.6 + 1.6 + 2.5 + 6.0	13.3	1.25	1.25	1.25	1.95	4.70	10.40	3.4 ~ 14.5	2670	560 ~ 4100	3.90	A
	1.6 + 1.6 + 1.6 + 2.5 + 7.1	14.4	1.16	1.16	1.16	1.81	5.11	10.40	3.4 ~ 14.5	2700	570 ~ 4090	3.85	A
	1.6 + 1.6 + 1.6 + 3.5 + 3.5	11.8	1.41	1.41	1.41	3.08	3.08	10.39	3.4 ~ 14.5	2660	480 ~ 4140	3.91	A
	1.6 + 1.6 + 1.6 + 3.5 + 4.2	12.5	1.33	1.33	1.33	2.91	3.50	10.40	3.4 ~ 14.5	2660	490 ~ 4130	3.91	A
	1.6 + 1.6 + 1.6 + 3.5 + 5.0	13.3	1.25	1.25	1.25	2.74	3.91	10.40	3.4 ~ 14.5	2700	570 ~ 4130	3.85	A
	1.6 + 1.6 + 1.6 + 3.5 + 6.0	14.3	1.16	1.16	1.16	2.55	4.37	10.40	3.4 ~ 14.5	2700	570 ~ 4130	3.85	A
	1.6 + 1.6 + 1.6 + 3.5 + 7.1	15.4	1.08	1.08	1.08	2.36	4.80	10.40	3.4 ~ 14.5	2700	590 ~ 4120	3.85	A
	1.6 + 1.6 + 1.6 + 4.2 + 4.2	13.2	1.26	1.26	1.26	3.31	3.31	10.40	3.4 ~ 14.5	2650	500 ~ 4120	3.92	A
	1.6 + 1.6 + 1.6 + 4.2 + 5.0	14.0	1.19	1.19	1.19	3.12	3.71	10.40	3.4 ~ 14.5	2700	590 ~ 4120	3.85	A
	1.6 + 1.6 + 1.6 + 4.2 + 6.0	15.0	1.11	1.11	1.11	2.91	4.16	10.40	3.4 ~ 14.5	2700	590 ~ 4120	3.85	A
	1.6 + 1.6 + 1.6 + 4.2 + 7.1	16.1	1.03	1.03	1.03	2.71	4.60	10.40	3.4 ~ 14.5	2730	600 ~ 4110	3.81	A
	1.6 + 1.6 + 1.6 + 5.0 + 5.0	14.8	1.12	1.12	1.12	3.52	3.52	10.40	3.4 ~ 14.5	2790	690 ~ 4130	3.73	A
	1.6 + 1.6 + 1.6 + 5.0 + 6.0	15.8	1.05	1.05	1.05	3.29	3.96	10.40	3.4 ~ 14.5	2790	690 ~ 4130	3.73	A
	1.6 + 1.6 + 1.6 + 5.0 + 7.1	16.9	0.98	0.98	0.98	3.08	4.38	10.40	3.4 ~ 14.5	2790	710 ~ 4120	3.73	A
	1.6 + 1.6 + 1.6 + 6.0 + 6.0	16.8	0.99	0.99	0.99	3.71	3.71	10.39	3.4 ~ 14.5	2790	690 ~ 4130	3.72	A
	1.6 + 1.6 + 1.6 + 6.0 + 7.1	17.9	0.93	0.93	0.93	3.49	4.12	10.40	3.4 ~ 14.5	2790	710 ~ 4120	3.73	A
	1.6 + 1.6 + 2.0 + 2.0 + 2.0	9.2	1.81	1.81	2.26	2.26	2.26	10.40	3.4 ~ 14.5	2640	450 ~ 4140	3.94	A
	1.6 + 1.6 + 2.0 + 2.0 + 2.5	9.7	1.72	1.72	2.14	2.14	2.68	10.40	3.4 ~ 14.5	2640	450 ~ 4140	3.94	A
	1.6 + 1.6 + 2.0 + 2.0 + 3.5	10.7	1.56	1.56	1.94	1.94	3.40	10.40	3.4 ~ 14.5	2630	470 ~ 4160	3.95	A
	1.6 + 1.6 + 2.0 + 2.0 + 4.2	11.4	1.46	1.46	1.82	1.82	3.84	10.40	3.4 ~ 14.5	2670	480 ~ 4150	3.90	A
	1.6 + 1.6 + 2.0 + 2.0 + 5.0	12.2	1.36	1.36	1.70	1.70	4.28	10.40	3.4 ~ 14.5	2700	560 ~ 4090	3.85	A
1.6 + 1.6 + 2.0 + 2.0 + 6.0	13.2	1.26	1.26	1.58	1.58	4.72	10.40	3.4 ~ 14.5	2700	560 ~ 4090	3.85	A	
1.6 + 1.6 + 2.0 + 2.0 + 7.1	14.3	1.16	1.16	1.45	1.45	5.18	10.40	3.4 ~ 14.5	2700	570 ~ 4080	3.85	A	
1.6 + 1.6 + 2.0 + 2.5 + 2.5	10.2	1.63	1.63	2.04	2.55	2.55	10.40	3.4 ~ 14.5	2640	450 ~ 4140	3.94	A	
1.6 + 1.6 + 2.0 + 2.5 + 3.5	11.2	1.49	1.49	1.86	2.32	3.24	10.40	3.4 ~ 14.5	2630	470 ~ 4160	3.95	A	
1.6 + 1.6 + 2.0 + 2.5 + 4.2	11.9	1.40	1.40	1.75	2.18	3.67	10.40	3.4 ~ 14.5	2670	480 ~ 4150	3.90	A	
1.6 + 1.6 + 2.0 + 2.5 + 5.0	12.7	1.31	1.31	1.64	2.05	4.09	10.40	3.4 ~ 14.5	2700	560 ~ 4090	3.85	A	
1.6 + 1.6 + 2.0 + 2.5 + 6.0	13.7	1.21	1.21	1.52	1.90	4.56	10.40	3.4 ~ 14.5	2700	560 ~ 4090	3.85	A	
1.6 + 1.6 + 2.0 + 2.5 + 7.1	14.8	1.12	1.12	1.41	1.76	4.99	10.40	3.4 ~ 14.5	2700	570 ~ 4080	3.85	A	
1.6 + 1.6 + 2.0 + 3.5 + 3.5	12.2	1.36	1.36	1.72	2.98	2.98	10.40	3.4 ~ 14.5	2660	490 ~ 4130	3.91	A	
1.6 + 1.6 + 2.0 + 3.5 + 4.2	12.9	1.29	1.29	1.61	2.82	3.39	10.40	3.4 ~ 14.5	2650	500 ~ 4120	3.92	A	
1.6 + 1.6 + 2.0 + 3.5 + 5.0	13.7	1.21	1.21	1.52	2.66	3.80	10.40	3.4 ~ 14.5	2700	590 ~ 4120	3.85	A	
1.6 + 1.6 + 2.0 + 3.5 + 6.0	14.7	1.13	1.13	1.41	2.48	4.25	10.40	3.4 ~ 14.5	2700	590 ~ 4120	3.85	A	
1.6 + 1.6 + 2.0 + 3.5 + 7.1	15.8	1.05	1.05	1.32	2.30	4.68	10.40	3.4 ~ 14.5	2730	600 ~ 4110	3.81	A	
1.6 + 1.6 + 2.0 + 4.2 + 4.2	13.6	1.22	1.22	1.54	3.21	3.21	10.40	3.4 ~ 14.5	2650	510 ~ 4110	3.92	A	
1.6 + 1.6 + 2.0 + 4.2 + 5.0	14.4	1.16	1.16	1.44	3.03	3.61	10.40	3.4 ~ 14.5	2690	600 ~ 4110	3.87	A	
1.6 + 1.6 + 2.0 + 4.2 + 6.0	15.4	1.08	1.08	1.35	2.84	4.05	10.40	3.4 ~ 14.5	2690	600 ~ 4110	3.87	A	
1.6 + 1.6 + 2.0 + 4.2 + 7.1	16.5	1.01	1.01	1.26	2.65	4.47	10.40	3.4 ~ 14.5	2730	600 ~ 4100	3.81	A	
1.6 + 1.6 + 2.0 + 5.0 + 5.0	15.2	1.09	1.09	1.38	3.42	3.42	10.40	3.4 ~ 14.5	2790	700 ~ 4120	3.73	A	



	Indoor unit capacity Heating	Annual Energy Consumption (kWh)	Current 230V (A)	ERP				Moisture Removal Volume l/h
				Pdesign (kW)	SCOP		Annual Consumption (kWh)	
					W/W	CLASS		
5 Room	1.6 + 1.6 + 1.6 + 1.6 + 1.6	1330	12.5	7.60	3.80	A	2800	
	1.6 + 1.6 + 1.6 + 1.6 + 2.0	1325	12.5	7.60	3.80	A	2800	
	1.6 + 1.6 + 1.6 + 1.6 + 2.5	1325	12.5	7.60	3.80	A	2800	
	1.6 + 1.6 + 1.6 + 1.6 + 3.5	1320	12.4	7.60	3.80	A	2800	
	1.6 + 1.6 + 1.6 + 1.6 + 4.2	1320	12.4	7.60	3.80	A	2800	
	1.6 + 1.6 + 1.6 + 1.6 + 5.0	1335	12.5	7.60	3.80	A	2800	
	1.6 + 1.6 + 1.6 + 1.6 + 6.0	1335	12.5	7.60	3.80	A	2800	
	1.6 + 1.6 + 1.6 + 1.6 + 7.1	1355	12.7	7.60	3.80	A	2800	
	1.6 + 1.6 + 1.6 + 2.0 + 2.0	1325	12.5	7.60	3.80	A	2800	
	1.6 + 1.6 + 1.6 + 2.0 + 2.5	1325	12.5	7.60	3.80	A	2800	
	1.6 + 1.6 + 1.6 + 2.0 + 3.5	1320	12.4	7.60	3.80	A	2800	
	1.6 + 1.6 + 1.6 + 2.0 + 4.2	1315	12.4	7.60	3.80	A	2800	
	1.6 + 1.6 + 1.6 + 2.0 + 5.0	1335	12.5	7.60	3.80	A	2800	
	1.6 + 1.6 + 1.6 + 2.0 + 6.0	1335	12.5	7.60	3.80	A	2800	
	1.6 + 1.6 + 1.6 + 2.0 + 7.1	1350	12.7	7.60	3.80	A	2800	
	1.6 + 1.6 + 1.6 + 2.5 + 2.5	1325	12.5	7.60	3.80	A	2800	
	1.6 + 1.6 + 1.6 + 2.5 + 3.5	1320	12.4	7.60	3.80	A	2800	
	1.6 + 1.6 + 1.6 + 2.5 + 4.2	1315	12.4	7.60	3.80	A	2800	
	1.6 + 1.6 + 1.6 + 2.5 + 5.0	1335	12.5	7.60	3.80	A	2800	
	1.6 + 1.6 + 1.6 + 2.5 + 6.0	1335	12.5	7.60	3.80	A	2800	
	1.6 + 1.6 + 1.6 + 2.5 + 7.1	1350	12.7	7.60	3.80	A	2800	
	1.6 + 1.6 + 1.6 + 3.5 + 3.5	1330	12.5	7.60	3.80	A	2800	
	1.6 + 1.6 + 1.6 + 3.5 + 4.2	1330	12.5	7.60	3.80	A	2800	
	1.6 + 1.6 + 1.6 + 3.5 + 5.0	1350	12.7	7.60	3.80	A	2800	
	1.6 + 1.6 + 1.6 + 3.5 + 6.0	1350	12.7	7.60	3.80	A	2800	
	1.6 + 1.6 + 1.6 + 3.5 + 7.1	1350	12.7	7.60	3.80	A	2800	
	1.6 + 1.6 + 1.6 + 4.2 + 4.2	1325	12.5	7.60	3.80	A	2800	
	1.6 + 1.6 + 1.6 + 4.2 + 5.0	1350	12.7	7.60	3.80	A	2800	
	1.6 + 1.6 + 1.6 + 4.2 + 6.0	1350	12.7	7.60	3.80	A	2800	
	1.6 + 1.6 + 1.6 + 4.2 + 7.1	1365	12.8	7.60	3.80	A	2800	
	1.6 + 1.6 + 1.6 + 5.0 + 5.0	1395	13.1	7.60	3.80	A	2800	
	1.6 + 1.6 + 1.6 + 5.0 + 6.0	1395	13.1	7.60	3.80	A	2800	
	1.6 + 1.6 + 1.6 + 5.0 + 7.1	1395	13.1	7.60	3.80	A	2800	
	1.6 + 1.6 + 1.6 + 6.0 + 6.0	1395	13.1	7.60	3.80	A	2800	
	1.6 + 1.6 + 1.6 + 6.0 + 7.1	1395	13.1	7.60	3.80	A	2800	
	1.6 + 1.6 + 2.0 + 2.0 + 2.0	1320	12.4	7.60	3.80	A	2800	
	1.6 + 1.6 + 2.0 + 2.0 + 2.5	1320	12.4	7.60	3.80	A	2800	
	1.6 + 1.6 + 2.0 + 2.0 + 3.5	1315	12.4	7.60	3.80	A	2800	
	1.6 + 1.6 + 2.0 + 2.0 + 4.2	1335	12.5	7.60	3.80	A	2800	
	1.6 + 1.6 + 2.0 + 2.0 + 5.0	1350	12.7	7.60	3.80	A	2800	
1.6 + 1.6 + 2.0 + 2.0 + 6.0	1350	12.7	7.60	3.80	A	2800		
1.6 + 1.6 + 2.0 + 2.0 + 7.1	1350	12.7	7.60	3.80	A	2800		
1.6 + 1.6 + 2.0 + 2.5 + 2.5	1320	12.4	7.60	3.80	A	2800		
1.6 + 1.6 + 2.0 + 2.5 + 3.5	1315	12.4	7.60	3.80	A	2800		
1.6 + 1.6 + 2.0 + 2.5 + 4.2	1335	12.5	7.60	3.80	A	2800		
1.6 + 1.6 + 2.0 + 2.5 + 5.0	1350	12.7	7.60	3.80	A	2800		
1.6 + 1.6 + 2.0 + 2.5 + 6.0	1350	12.7	7.60	3.80	A	2800		
1.6 + 1.6 + 2.0 + 2.5 + 7.1	1350	12.7	7.60	3.80	A	2800		
1.6 + 1.6 + 2.0 + 3.5 + 3.5	1330	12.5	7.60	3.80	A	2800		
1.6 + 1.6 + 2.0 + 3.5 + 4.2	1325	12.5	7.60	3.80	A	2800		
1.6 + 1.6 + 2.0 + 3.5 + 5.0	1350	12.7	7.60	3.80	A	2800		
1.6 + 1.6 + 2.0 + 3.5 + 6.0	1350	12.7	7.60	3.80	A	2800		
1.6 + 1.6 + 2.0 + 3.5 + 7.1	1365	12.8	7.60	3.80	A	2800		
1.6 + 1.6 + 2.0 + 4.2 + 4.2	1325	12.5	7.60	3.80	A	2800		
1.6 + 1.6 + 2.0 + 4.2 + 5.0	1345	12.6	7.60	3.80	A	2800		
1.6 + 1.6 + 2.0 + 4.2 + 6.0	1345	12.6	7.60	3.80	A	2800		
1.6 + 1.6 + 2.0 + 4.2 + 7.1	1365	12.8	7.60	3.80	A	2800		
1.6 + 1.6 + 2.0 + 5.0 + 5.0	1395	13.1	7.60	3.80	A	2800		

	Indoor unit capacity Heating	Total	Heating Capacity (kW)						Input Power (W)			COP	
			Room A	Room B	Room C	Room D	Room E	Total	min ~ max	Rating	min ~ max	WW	CLASS
5 Room	1.6 + 1.6 + 2.0 + 5.0 + 6.0	16.2	1.03	1.03	1.28	3.21	3.85	10.40	3.4 ~ 14.5	2790	700 ~ 4120	3.73	A
	1.6 + 1.6 + 2.0 + 5.0 + 7.1	17.3	0.96	0.96	1.20	3.01	4.27	10.40	3.4 ~ 14.5	2830	710 ~ 4160	3.67	A
	1.6 + 1.6 + 2.0 + 6.0 + 6.0	17.2	0.97	0.97	1.20	3.63	3.63	10.40	3.4 ~ 14.5	2790	700 ~ 4120	3.73	A
	1.6 + 1.6 + 2.0 + 6.0 + 7.1	18.3	0.91	0.91	1.14	3.41	4.03	10.40	3.4 ~ 14.5	2830	710 ~ 4160	3.67	A
	1.6 + 1.6 + 2.5 + 2.5 + 2.5	10.7	1.55	1.55	2.43	2.43	2.43	10.39	3.4 ~ 14.5	2640	450 ~ 4140	3.94	A
	1.6 + 1.6 + 2.5 + 2.5 + 3.5	11.7	1.42	1.42	2.22	2.22	3.12	10.40	3.4 ~ 14.5	2630	470 ~ 4160	3.95	A
	1.6 + 1.6 + 2.5 + 2.5 + 4.2	12.4	1.34	1.34	2.10	2.10	3.52	10.40	3.4 ~ 14.5	2670	480 ~ 4150	3.90	A
	1.6 + 1.6 + 2.5 + 2.5 + 5.0	13.2	1.26	1.26	1.97	1.97	3.94	10.40	3.4 ~ 14.5	2700	560 ~ 4090	3.85	A
	1.6 + 1.6 + 2.5 + 2.5 + 6.0	14.2	1.17	1.17	1.83	1.83	4.40	10.40	3.4 ~ 14.5	2700	560 ~ 4090	3.85	A
	1.6 + 1.6 + 2.5 + 2.5 + 7.1	15.3	1.09	1.09	1.70	1.70	4.82	10.40	3.4 ~ 14.5	2700	570 ~ 4080	3.85	A
	1.6 + 1.6 + 2.5 + 3.5 + 3.5	12.7	1.31	1.31	2.04	2.87	2.87	10.40	3.4 ~ 14.5	2660	490 ~ 4130	3.91	A
	1.6 + 1.6 + 2.5 + 3.5 + 4.2	13.4	1.24	1.24	1.94	2.72	3.26	10.40	3.4 ~ 14.5	2650	500 ~ 4120	3.92	A
	1.6 + 1.6 + 2.5 + 3.5 + 5.0	14.2	1.17	1.17	1.83	2.56	3.67	10.40	3.4 ~ 14.5	2700	590 ~ 4120	3.85	A
	1.6 + 1.6 + 2.5 + 3.5 + 6.0	15.2	1.09	1.09	1.71	2.39	4.12	10.40	3.4 ~ 14.5	2700	590 ~ 4120	3.85	A
	1.6 + 1.6 + 2.5 + 3.5 + 7.1	16.3	1.02	1.02	1.60	2.23	4.53	10.40	3.4 ~ 14.5	2730	600 ~ 4110	3.81	A
	1.6 + 1.6 + 2.5 + 4.2 + 4.2	14.1	1.18	1.18	1.84	3.10	3.10	10.40	3.4 ~ 14.5	2650	510 ~ 4110	3.92	A
	1.6 + 1.6 + 2.5 + 4.2 + 5.0	14.9	1.12	1.12	1.74	2.93	3.49	10.40	3.4 ~ 14.5	2690	600 ~ 4110	3.87	A
	1.6 + 1.6 + 2.5 + 4.2 + 6.0	15.9	1.05	1.05	1.64	2.75	3.91	10.40	3.4 ~ 14.5	2690	600 ~ 4110	3.87	A
	1.6 + 1.6 + 2.5 + 4.2 + 7.1	17.0	0.98	0.98	1.53	2.57	4.34	10.40	3.4 ~ 14.5	2730	600 ~ 4100	3.81	A
	1.6 + 1.6 + 2.5 + 5.0 + 5.0	15.7	1.06	1.06	1.66	3.31	3.31	10.40	3.4 ~ 14.5	2790	700 ~ 4120	3.73	A
	1.6 + 1.6 + 2.5 + 5.0 + 6.0	16.7	1.00	1.00	1.56	3.11	3.73	10.40	3.4 ~ 14.5	2790	700 ~ 4120	3.73	A
	1.6 + 1.6 + 2.5 + 5.0 + 7.1	17.8	0.93	0.93	1.46	2.92	4.16	10.40	3.4 ~ 14.5	2830	710 ~ 4160	3.67	A
	1.6 + 1.6 + 2.5 + 6.0 + 6.0	17.7	0.94	0.94	1.46	3.53	3.53	10.40	3.4 ~ 14.5	2790	700 ~ 4120	3.73	A
	1.6 + 1.6 + 3.5 + 3.5 + 3.5	13.7	1.21	1.21	2.66	2.66	2.66	10.40	3.4 ~ 14.5	2650	510 ~ 4100	3.92	A
	1.6 + 1.6 + 3.5 + 3.5 + 4.2	14.4	1.16	1.16	2.53	2.53	3.02	10.40	3.4 ~ 14.5	2680	510 ~ 4090	3.88	A
	1.6 + 1.6 + 3.5 + 3.5 + 5.0	15.2	1.09	1.09	2.39	2.39	3.44	10.40	3.4 ~ 14.5	2730	610 ~ 4090	3.81	A
	1.6 + 1.6 + 3.5 + 3.5 + 6.0	16.2	1.03	1.03	2.25	2.25	3.84	10.40	3.4 ~ 14.5	2730	610 ~ 4090	3.81	A
	1.6 + 1.6 + 3.5 + 3.5 + 7.1	17.3	0.96	0.96	2.10	2.10	4.28	10.40	3.4 ~ 14.5	2730	620 ~ 4080	3.81	A
	1.6 + 1.6 + 3.5 + 4.2 + 4.2	15.1	1.10	1.10	2.42	2.89	2.89	10.40	3.4 ~ 14.5	2680	520 ~ 4140	3.88	A
	1.6 + 1.6 + 3.5 + 4.2 + 5.0	15.9	1.05	1.05	2.29	2.75	3.26	10.40	3.4 ~ 14.5	2730	620 ~ 4090	3.81	A
	1.6 + 1.6 + 3.5 + 4.2 + 6.0	16.9	0.98	0.98	2.15	2.58	3.71	10.40	3.4 ~ 14.5	2730	620 ~ 4090	3.81	A
	1.6 + 1.6 + 3.5 + 4.2 + 7.1	18.0	0.92	0.92	2.02	2.43	4.11	10.40	3.4 ~ 14.5	2720	630 ~ 4130	3.82	A
	1.6 + 1.6 + 3.5 + 5.0 + 5.0	16.7	1.00	1.00	2.18	3.11	3.11	10.40	3.4 ~ 14.5	2830	720 ~ 4150	3.67	A
	1.6 + 1.6 + 3.5 + 5.0 + 6.0	17.7	0.94	0.94	2.06	2.94	3.52	10.40	3.4 ~ 14.5	2830	720 ~ 4150	3.67	A
	1.6 + 1.6 + 4.2 + 4.2 + 4.2	15.8	1.06	1.06	2.76	2.76	2.76	10.40	3.4 ~ 14.5	2680	530 ~ 4130	3.88	A
	1.6 + 1.6 + 4.2 + 4.2 + 5.0	16.6	1.00	1.00	2.63	2.63	3.14	10.40	3.4 ~ 14.5	2730	630 ~ 4130	3.81	A
	1.6 + 1.6 + 4.2 + 4.2 + 6.0	17.6	0.95	0.95	2.48	2.48	3.54	10.40	3.4 ~ 14.5	2730	630 ~ 4130	3.81	A
	1.6 + 1.6 + 4.2 + 5.0 + 5.0	17.4	0.96	0.96	2.50	2.99	2.99	10.40	3.4 ~ 14.5	2830	740 ~ 4150	3.67	A
	1.6 + 1.6 + 5.0 + 5.0 + 5.0	18.2	0.91	0.91	2.86	2.86	2.86	10.40	3.4 ~ 14.5	2980	860 ~ 4230	3.49	B
	1.6 + 2.0 + 2.0 + 2.0 + 2.0	9.6	1.72	2.17	2.17	2.17	2.17	10.40	3.4 ~ 14.5	2640	460 ~ 4180	3.94	A
	1.6 + 2.0 + 2.0 + 2.0 + 2.5	10.1	1.65	2.06	2.06	2.06	2.57	10.40	3.4 ~ 14.5	2640	460 ~ 4180	3.94	A
	1.6 + 2.0 + 2.0 + 2.0 + 3.5	11.1	1.50	1.87	1.87	1.87	3.29	10.40	3.4 ~ 14.5	2670	480 ~ 4150	3.90	A
	1.6 + 2.0 + 2.0 + 2.0 + 4.2	11.8	1.41	1.76	1.76	1.76	3.71	10.40	3.4 ~ 14.5	2660	480 ~ 4140	3.91	A
	1.6 + 2.0 + 2.0 + 2.0 + 5.0	12.6	1.32	1.65	1.65	1.65	4.13	10.40	3.4 ~ 14.5	2700	570 ~ 4080	3.85	A
	1.6 + 2.0 + 2.0 + 2.0 + 6.0	13.6	1.22	1.53	1.53	1.53	4.59	10.40	3.4 ~ 14.5	2700	570 ~ 4080	3.85	A
1.6 + 2.0 + 2.0 + 2.0 + 7.1	14.7	1.13	1.41	1.41	1.41	5.04	10.40	3.4 ~ 14.5	2700	580 ~ 4120	3.85	A	
1.6 + 2.0 + 2.0 + 2.5 + 2.5	10.6	1.58	1.96	1.96	2.45	2.45	10.40	3.4 ~ 14.5	2640	460 ~ 4180	3.94	A	
1.6 + 2.0 + 2.0 + 2.5 + 3.5	11.6	1.43	1.79	1.79	2.24	3.15	10.40	3.4 ~ 14.5	2670	480 ~ 4150	3.90	A	
1.6 + 2.0 + 2.0 + 2.5 + 4.2	12.3	1.35	1.69	1.69	2.11	3.56	10.40	3.4 ~ 14.5	2660	480 ~ 4140	3.91	A	
1.6 + 2.0 + 2.0 + 2.5 + 5.0	13.1	1.27	1.59	1.59	1.98	3.97	10.40	3.4 ~ 14.5	2700	570 ~ 4080	3.85	A	
1.6 + 2.0 + 2.0 + 2.5 + 6.0	14.1	1.18	1.48	1.48	1.84	4.42	10.40	3.4 ~ 14.5	2700	570 ~ 4080	3.85	A	
1.6 + 2.0 + 2.0 + 2.5 + 7.1	15.2	1.09	1.37	1.37	1.71	4.86	10.40	3.4 ~ 14.5	2700	580 ~ 4120	3.85	A	
1.6 + 2.0 + 2.0 + 3.5 + 3.5	12.6	1.32	1.65	1.65	2.89	2.89	10.40	3.4 ~ 14.5	2650	500 ~ 4120	3.92	A	
1.6 + 2.0 + 2.0 + 3.5 + 4.2	13.3	1.25	1.56	1.56	2.74	3.29	10.40	3.4 ~ 14.5	2650	510 ~ 4110	3.92	A	
1.6 + 2.0 + 2.0 + 3.5 + 5.0	14.1	1.18	1.48	1.48	2.58	3.68	10.40	3.4 ~ 14.5	2690	600 ~ 4110	3.87	A	
1.6 + 2.0 + 2.0 + 3.5 + 6.0	15.1	1.10	1.38	1.38	2.41	4.13	10.40	3.4 ~ 14.5	2690	600 ~ 4110	3.87	A	
1.6 + 2.0 + 2.0 + 3.5 + 7.1	16.2	1.03	1.28	1.28	2.25	4.56	10.40	3.4 ~ 14.5	2730	600 ~ 4100	3.81	A	
1.6 + 2.0 + 2.0 + 4.2 + 4.2	14.0	1.18	1.49	1.49	3.12	3.12	10.40	3.4 ~ 14.5	2650	510 ~ 4100	3.92	A	

	Indoor unit capacity Heating	Annual Energy Consumption (kWh)	Current 230V (A)	ERP			Moisture Removal Volume l/h	
				Pdesign (kW)	SCOP			Annual Consumption (kWh)
					W/W	CLASS		
5 Room	1.6 + 1.6 + 2.0 + 5.0 + 6.0	1395	13.1	7.60	3.80	A	2800	
	1.6 + 1.6 + 2.0 + 5.0 + 7.1	1415	13.3	7.60	3.80	A	2800	
	1.6 + 1.6 + 2.0 + 6.0 + 6.0	1395	13.1	7.60	3.80	A	2800	
	1.6 + 1.6 + 2.0 + 6.0 + 7.1	1415	13.3	7.60	3.80	A	2800	
	1.6 + 1.6 + 2.5 + 2.5 + 2.5	1320	12.4	7.60	3.80	A	2800	
	1.6 + 1.6 + 2.5 + 2.5 + 3.5	1315	12.4	7.60	3.80	A	2800	
	1.6 + 1.6 + 2.5 + 2.5 + 4.2	1335	12.5	7.60	3.80	A	2800	
	1.6 + 1.6 + 2.5 + 2.5 + 5.0	1350	12.7	7.60	3.80	A	2800	
	1.6 + 1.6 + 2.5 + 2.5 + 6.0	1350	12.7	7.60	3.80	A	2800	
	1.6 + 1.6 + 2.5 + 2.5 + 7.1	1350	12.7	7.60	3.80	A	2800	
	1.6 + 1.6 + 2.5 + 3.5 + 3.5	1330	12.5	7.60	3.80	A	2800	
	1.6 + 1.6 + 2.5 + 3.5 + 4.2	1325	12.5	7.60	3.80	A	2800	
	1.6 + 1.6 + 2.5 + 3.5 + 5.0	1350	12.7	7.60	3.80	A	2800	
	1.6 + 1.6 + 2.5 + 3.5 + 6.0	1350	12.7	7.60	3.80	A	2800	
	1.6 + 1.6 + 2.5 + 3.5 + 7.1	1365	12.8	7.60	3.80	A	2800	
	1.6 + 1.6 + 2.5 + 4.2 + 4.2	1325	12.5	7.60	3.80	A	2800	
	1.6 + 1.6 + 2.5 + 4.2 + 5.0	1345	12.6	7.60	3.80	A	2800	
	1.6 + 1.6 + 2.5 + 4.2 + 6.0	1345	12.6	7.60	3.80	A	2800	
	1.6 + 1.6 + 2.5 + 4.2 + 7.1	1365	12.8	7.60	3.80	A	2800	
	1.6 + 1.6 + 2.5 + 5.0 + 5.0	1395	13.1	7.60	3.80	A	2800	
	1.6 + 1.6 + 2.5 + 5.0 + 6.0	1395	13.1	7.60	3.80	A	2800	
	1.6 + 1.6 + 2.5 + 5.0 + 7.1	1415	13.3	7.60	3.80	A	2800	
	1.6 + 1.6 + 2.5 + 6.0 + 6.0	1395	13.1	7.60	3.80	A	2800	
	1.6 + 1.6 + 3.5 + 3.5 + 3.5	1325	12.5	7.60	3.80	A	2800	
	1.6 + 1.6 + 3.5 + 3.5 + 4.2	1340	12.6	7.60	3.80	A	2800	
	1.6 + 1.6 + 3.5 + 3.5 + 5.0	1365	12.8	7.60	3.80	A	2800	
	1.6 + 1.6 + 3.5 + 3.5 + 6.0	1365	12.8	7.60	3.80	A	2800	
	1.6 + 1.6 + 3.5 + 3.5 + 7.1	1365	12.8	7.60	3.80	A	2800	
	1.6 + 1.6 + 3.5 + 4.2 + 4.2	1340	12.6	7.60	3.80	A	2800	
	1.6 + 1.6 + 3.5 + 4.2 + 5.0	1365	12.8	7.60	3.80	A	2800	
	1.6 + 1.6 + 3.5 + 4.2 + 6.0	1365	12.8	7.60	3.80	A	2800	
	1.6 + 1.6 + 3.5 + 4.2 + 7.1	1360	12.8	7.60	3.80	A	2800	
	1.6 + 1.6 + 3.5 + 5.0 + 5.0	1415	13.3	7.60	3.80	A	2800	
	1.6 + 1.6 + 3.5 + 5.0 + 6.0	1415	13.3	7.60	3.80	A	2800	
	1.6 + 1.6 + 4.2 + 4.2 + 4.2	1340	12.6	7.60	3.80	A	2800	
	1.6 + 1.6 + 4.2 + 4.2 + 5.0	1365	12.8	7.60	3.80	A	2800	
	1.6 + 1.6 + 4.2 + 4.2 + 6.0	1365	12.8	7.60	3.80	A	2800	
	1.6 + 1.6 + 4.2 + 5.0 + 5.0	1415	13.3	7.60	3.80	A	2800	
	1.6 + 1.6 + 5.0 + 5.0 + 5.0	1490	14.0	7.60	3.80	A	2800	
	1.6 + 2.0 + 2.0 + 2.0 + 2.0	1320	12.4	7.60	3.80	A	2800	
1.6 + 2.0 + 2.0 + 2.0 + 2.5	1320	12.4	7.60	3.80	A	2800		
1.6 + 2.0 + 2.0 + 2.0 + 3.5	1335	12.5	7.60	3.80	A	2800		
1.6 + 2.0 + 2.0 + 2.0 + 4.2	1330	12.5	7.60	3.80	A	2800		
1.6 + 2.0 + 2.0 + 2.0 + 5.0	1350	12.7	7.60	3.80	A	2800		
1.6 + 2.0 + 2.0 + 2.0 + 6.0	1350	12.7	7.60	3.80	A	2800		
1.6 + 2.0 + 2.0 + 2.0 + 7.1	1350	12.7	7.60	3.80	A	2800		
1.6 + 2.0 + 2.0 + 2.5 + 2.5	1320	12.4	7.60	3.80	A	2800		
1.6 + 2.0 + 2.0 + 2.5 + 3.5	1335	12.5	7.60	3.80	A	2800		
1.6 + 2.0 + 2.0 + 2.5 + 4.2	1330	12.5	7.60	3.80	A	2800		
1.6 + 2.0 + 2.0 + 2.5 + 5.0	1350	12.7	7.60	3.80	A	2800		
1.6 + 2.0 + 2.0 + 2.5 + 6.0	1350	12.7	7.60	3.80	A	2800		
1.6 + 2.0 + 2.0 + 2.5 + 7.1	1350	12.7	7.60	3.80	A	2800		
1.6 + 2.0 + 2.0 + 3.5 + 3.5	1325	12.5	7.60	3.80	A	2800		
1.6 + 2.0 + 2.0 + 3.5 + 4.2	1325	12.5	7.60	3.80	A	2800		
1.6 + 2.0 + 2.0 + 3.5 + 5.0	1345	12.6	7.60	3.80	A	2800		
1.6 + 2.0 + 2.0 + 3.5 + 6.0	1345	12.6	7.60	3.80	A	2800		
1.6 + 2.0 + 2.0 + 3.5 + 7.1	1365	12.8	7.60	3.80	A	2800		
1.6 + 2.0 + 2.0 + 4.2 + 4.2	1325	12.5	7.60	3.80	A	2800		

	Indoor unit capacity Heating	Total	Heating Capacity (kW)						Input Power (W)		COP		
			Room A	Room B	Room C	Room D	Room E	Total	min ~ max	Rating	min ~ max	WW	CLASS
5 Room	1.6 + 2.0 + 2.0 + 4.2 + 5.0	14.8	1.12	1.41	1.41	2.95	3.51	10.40	3.4 ~ 14.5	2730	600 ~ 4100	3.81	A
	1.6 + 2.0 + 2.0 + 4.2 + 6.0	15.8	1.05	1.32	1.32	2.76	3.95	10.40	3.4 ~ 14.5	2730	600 ~ 4100	3.81	A
	1.6 + 2.0 + 2.0 + 4.2 + 7.1	16.9	0.98	1.23	1.23	2.58	4.38	10.40	3.4 ~ 14.5	2730	620 ~ 4090	3.81	A
	1.6 + 2.0 + 2.0 + 5.0 + 5.0	15.6	1.08	1.33	1.33	3.33	3.33	10.40	3.4 ~ 14.5	2830	710 ~ 4110	3.67	A
	1.6 + 2.0 + 2.0 + 5.0 + 6.0	16.6	1.00	1.25	1.25	3.13	3.77	10.40	3.4 ~ 14.5	2830	710 ~ 4110	3.67	A
	1.6 + 2.0 + 2.0 + 5.0 + 7.1	17.7	0.94	1.18	1.18	2.94	4.16	10.40	3.4 ~ 14.5	2830	720 ~ 4160	3.67	A
	1.6 + 2.0 + 2.0 + 6.0 + 6.0	17.6	0.94	1.18	1.18	3.55	3.55	10.40	3.4 ~ 14.5	2830	710 ~ 4110	3.67	A
	1.6 + 2.0 + 2.5 + 2.5 + 2.5	11.1	1.50	1.88	2.34	2.34	2.34	10.40	3.4 ~ 14.5	2640	460 ~ 4180	3.94	A
	1.6 + 2.0 + 2.5 + 2.5 + 3.5	12.1	1.38	1.72	2.15	2.15	3.00	10.40	3.4 ~ 14.5	2670	480 ~ 4150	3.90	A
	1.6 + 2.0 + 2.5 + 2.5 + 4.2	12.8	1.30	1.63	2.03	2.03	3.41	10.40	3.4 ~ 14.5	2660	480 ~ 4140	3.91	A
	1.6 + 2.0 + 2.5 + 2.5 + 5.0	13.6	1.22	1.53	1.91	1.91	3.83	10.40	3.4 ~ 14.5	2700	570 ~ 4080	3.85	A
	1.6 + 2.0 + 2.5 + 2.5 + 6.0	14.6	1.14	1.42	1.78	1.78	4.28	10.40	3.4 ~ 14.5	2700	570 ~ 4080	3.85	A
	1.6 + 2.0 + 2.5 + 2.5 + 7.1	15.7	1.06	1.32	1.66	1.66	4.70	10.40	3.4 ~ 14.5	2700	580 ~ 4120	3.85	A
	1.6 + 2.0 + 2.5 + 3.5 + 3.5	13.1	1.27	1.59	1.98	2.78	2.78	10.40	3.4 ~ 14.5	2650	500 ~ 4120	3.92	A
	1.6 + 2.0 + 2.5 + 3.5 + 4.2	13.8	1.21	1.51	1.88	2.64	3.16	10.40	3.4 ~ 14.5	2650	510 ~ 4110	3.92	A
	1.6 + 2.0 + 2.5 + 3.5 + 5.0	14.6	1.14	1.42	1.78	2.49	3.57	10.40	3.4 ~ 14.5	2690	600 ~ 4110	3.87	A
	1.6 + 2.0 + 2.5 + 3.5 + 6.0	15.6	1.07	1.33	1.67	2.33	4.00	10.40	3.4 ~ 14.5	2690	600 ~ 4110	3.87	A
	1.6 + 2.0 + 2.5 + 3.5 + 7.1	16.7	1.00	1.25	1.56	2.18	4.41	10.40	3.4 ~ 14.5	2730	600 ~ 4100	3.81	A
	1.6 + 2.0 + 2.5 + 4.2 + 4.2	14.5	1.15	1.43	1.80	3.01	3.01	10.40	3.4 ~ 14.5	2650	510 ~ 4100	3.92	A
	1.6 + 2.0 + 2.5 + 4.2 + 5.0	15.3	1.09	1.36	1.70	2.85	3.40	10.40	3.4 ~ 14.5	2730	600 ~ 4100	3.81	A
	1.6 + 2.0 + 2.5 + 4.2 + 6.0	16.3	1.02	1.28	1.60	2.68	3.82	10.40	3.4 ~ 14.5	2730	600 ~ 4100	3.81	A
	1.6 + 2.0 + 2.5 + 4.2 + 7.1	17.4	0.96	1.20	1.49	2.51	4.24	10.40	3.4 ~ 14.5	2730	620 ~ 4090	3.81	A
	1.6 + 2.0 + 2.5 + 5.0 + 5.0	16.1	1.03	1.29	1.62	3.23	3.23	10.40	3.4 ~ 14.5	2830	710 ~ 4110	3.67	A
	1.6 + 2.0 + 2.5 + 5.0 + 6.0	17.1	0.97	1.22	1.52	3.04	3.65	10.40	3.4 ~ 14.5	2830	710 ~ 4110	3.67	A
	1.6 + 2.0 + 2.5 + 5.0 + 7.1	18.2	0.91	1.14	1.43	2.86	4.06	10.40	3.4 ~ 14.5	2830	720 ~ 4160	3.67	A
	1.6 + 2.0 + 2.5 + 6.0 + 6.0	18.1	0.91	1.15	1.44	3.45	3.45	10.40	3.4 ~ 14.5	2830	710 ~ 4110	3.67	A
	1.6 + 2.0 + 3.5 + 3.5 + 3.5	14.1	1.18	1.48	2.58	2.58	2.58	10.40	3.4 ~ 14.5	2680	510 ~ 4090	3.88	A
	1.6 + 2.0 + 3.5 + 3.5 + 4.2	14.8	1.12	1.41	2.46	2.46	2.95	10.40	3.4 ~ 14.5	2680	520 ~ 4140	3.88	A
	1.6 + 2.0 + 3.5 + 3.5 + 5.0	15.6	1.07	1.33	2.33	2.33	3.34	10.40	3.4 ~ 14.5	2730	620 ~ 4090	3.81	A
	1.6 + 2.0 + 3.5 + 3.5 + 6.0	16.6	1.00	1.25	2.19	2.19	3.77	10.40	3.4 ~ 14.5	2730	620 ~ 4090	3.81	A
	1.6 + 2.0 + 3.5 + 3.5 + 7.1	17.7	0.94	1.18	2.06	2.06	4.16	10.40	3.4 ~ 14.5	2720	630 ~ 4130	3.82	A
	1.6 + 2.0 + 3.5 + 4.2 + 4.2	15.5	1.07	1.34	2.35	2.82	2.82	10.40	3.4 ~ 14.5	2680	530 ~ 4130	3.88	A
	1.6 + 2.0 + 3.5 + 4.2 + 5.0	16.3	1.02	1.28	2.23	2.68	3.19	10.40	3.4 ~ 14.5	2730	630 ~ 4130	3.81	A
	1.6 + 2.0 + 3.5 + 4.2 + 6.0	17.3	0.96	1.20	2.10	2.52	3.62	10.40	3.4 ~ 14.5	2730	630 ~ 4130	3.81	A
	1.6 + 2.0 + 3.5 + 5.0 + 5.0	17.1	0.97	1.22	2.13	3.04	3.04	10.40	3.4 ~ 14.5	2830	740 ~ 4150	3.67	A
	1.6 + 2.0 + 3.5 + 5.0 + 6.0	18.1	0.92	1.15	2.01	2.87	3.45	10.40	3.4 ~ 14.5	2830	740 ~ 4150	3.67	A
	1.6 + 2.0 + 4.2 + 4.2 + 4.2	16.2	1.02	1.28	2.70	2.70	2.70	10.40	3.4 ~ 14.5	2670	540 ~ 4120	3.90	A
	1.6 + 2.0 + 4.2 + 4.2 + 5.0	17.0	0.98	1.22	2.57	2.57	3.06	10.40	3.4 ~ 14.5	2760	630 ~ 4120	3.77	A
	1.6 + 2.0 + 4.2 + 4.2 + 6.0	18.0	0.92	1.16	2.43	2.43	3.46	10.40	3.4 ~ 14.5	2760	630 ~ 4120	3.77	A
	1.6 + 2.0 + 4.2 + 5.0 + 5.0	17.8	0.93	1.17	2.46	2.92	2.92	10.40	3.4 ~ 14.5	2860	750 ~ 4140	3.64	A
	1.6 + 2.5 + 2.5 + 2.5 + 2.5	11.6	1.44	2.24	2.24	2.24	2.24	10.40	3.4 ~ 14.5	2640	460 ~ 4180	3.94	A
	1.6 + 2.5 + 2.5 + 2.5 + 3.5	12.6	1.32	2.06	2.06	2.06	2.90	10.40	3.4 ~ 14.5	2670	480 ~ 4150	3.90	A
1.6 + 2.5 + 2.5 + 2.5 + 4.2	13.3	1.25	1.95	1.95	1.95	3.30	10.40	3.4 ~ 14.5	2660	480 ~ 4140	3.91	A	
1.6 + 2.5 + 2.5 + 2.5 + 5.0	14.1	1.18	1.84	1.84	1.84	3.70	10.40	3.4 ~ 14.5	2700	570 ~ 4080	3.85	A	
1.6 + 2.5 + 2.5 + 2.5 + 6.0	15.1	1.10	1.72	1.72	1.72	4.14	10.40	3.4 ~ 14.5	2700	570 ~ 4080	3.85	A	
1.6 + 2.5 + 2.5 + 2.5 + 7.1	16.2	1.03	1.60	1.60	1.60	4.57	10.40	3.4 ~ 14.5	2700	580 ~ 4120	3.85	A	
1.6 + 2.5 + 2.5 + 3.5 + 3.5	13.6	1.22	1.91	1.91	2.68	2.68	10.40	3.4 ~ 14.5	2650	500 ~ 4120	3.92	A	
1.6 + 2.5 + 2.5 + 3.5 + 4.2	14.3	1.16	1.82	1.82	2.55	3.05	10.40	3.4 ~ 14.5	2650	510 ~ 4110	3.92	A	
1.6 + 2.5 + 2.5 + 3.5 + 5.0	15.1	1.10	1.72	1.72	2.41	3.45	10.40	3.4 ~ 14.5	2690	600 ~ 4110	3.87	A	
1.6 + 2.5 + 2.5 + 3.5 + 6.0	16.1	1.03	1.61	1.61	2.26	3.89	10.40	3.4 ~ 14.5	2690	600 ~ 4110	3.87	A	
1.6 + 2.5 + 2.5 + 3.5 + 7.1	17.2	0.97	1.51	1.51	2.12	4.29	10.40	3.4 ~ 14.5	2730	600 ~ 4100	3.81	A	
1.6 + 2.5 + 2.5 + 4.2 + 4.2	15.0	1.12	1.73	1.73	2.91	2.91	10.40	3.4 ~ 14.5	2650	510 ~ 4100	3.92	A	
1.6 + 2.5 + 2.5 + 4.2 + 5.0	15.8	1.05	1.65	1.65	2.76	3.29	10.40	3.4 ~ 14.5	2730	600 ~ 4100	3.81	A	
1.6 + 2.5 + 2.5 + 4.2 + 6.0	16.8	0.99	1.55	1.55	2.60	3.71	10.40	3.4 ~ 14.5	2730	600 ~ 4100	3.81	A	
1.6 + 2.5 + 2.5 + 4.2 + 7.1	17.9	0.93	1.45	1.45	2.44	4.13	10.40	3.4 ~ 14.5	2730	620 ~ 4090	3.81	A	
1.6 + 2.5 + 2.5 + 5.0 + 5.0	16.6	1.00	1.57	1.57	3.13	3.13	10.40	3.4 ~ 14.5	2830	710 ~ 4110	3.67	A	
1.6 + 2.5 + 2.5 + 5.0 + 6.0	17.6	0.95	1.48	1.48	2.95	3.54	10.40	3.4 ~ 14.5	2830	710 ~ 4110	3.67	A	
1.6 + 2.5 + 3.5 + 3.5 + 3.5	14.6	1.14	1.79	2.49	2.49	2.49	10.40	3.4 ~ 14.5	2680	510 ~ 4090	3.88	A	

	Indoor unit capacity Heating	Annual Energy Consumption (kWh)	Current 230V (A)	ERP			Moisture Removal Volume l/h	
				Pdesign (kW)	SCOP			Annual Consumption (kWh)
					W/W	CLASS		
5 Room	1.6 + 2.0 + 2.0 + 4.2 + 5.0	1365	12.8	7.60	3.80	A	2800	
	1.6 + 2.0 + 2.0 + 4.2 + 6.0	1365	12.8	7.60	3.80	A	2800	
	1.6 + 2.0 + 2.0 + 4.2 + 7.1	1365	12.8	7.60	3.80	A	2800	
	1.6 + 2.0 + 2.0 + 5.0 + 5.0	1415	13.3	7.60	3.80	A	2800	
	1.6 + 2.0 + 2.0 + 5.0 + 6.0	1415	13.3	7.60	3.80	A	2800	
	1.6 + 2.0 + 2.0 + 5.0 + 7.1	1415	13.3	7.60	3.80	A	2800	
	1.6 + 2.0 + 2.0 + 6.0 + 6.0	1415	13.3	7.60	3.80	A	2800	
	1.6 + 2.0 + 2.5 + 2.5 + 2.5	1320	12.4	7.60	3.80	A	2800	
	1.6 + 2.0 + 2.5 + 2.5 + 3.5	1335	12.5	7.60	3.80	A	2800	
	1.6 + 2.0 + 2.5 + 2.5 + 4.2	1330	12.5	7.60	3.80	A	2800	
	1.6 + 2.0 + 2.5 + 2.5 + 5.0	1350	12.7	7.60	3.80	A	2800	
	1.6 + 2.0 + 2.5 + 2.5 + 6.0	1350	12.7	7.60	3.80	A	2800	
	1.6 + 2.0 + 2.5 + 2.5 + 7.1	1350	12.7	7.60	3.80	A	2800	
	1.6 + 2.0 + 2.5 + 3.5 + 3.5	1325	12.5	7.60	3.80	A	2800	
	1.6 + 2.0 + 2.5 + 3.5 + 4.2	1325	12.5	7.60	3.80	A	2800	
	1.6 + 2.0 + 2.5 + 3.5 + 5.0	1345	12.6	7.60	3.80	A	2800	
	1.6 + 2.0 + 2.5 + 3.5 + 6.0	1345	12.6	7.60	3.80	A	2800	
	1.6 + 2.0 + 2.5 + 3.5 + 7.1	1365	12.8	7.60	3.80	A	2800	
	1.6 + 2.0 + 2.5 + 4.2 + 4.2	1325	12.5	7.60	3.80	A	2800	
	1.6 + 2.0 + 2.5 + 4.2 + 5.0	1365	12.8	7.60	3.80	A	2800	
	1.6 + 2.0 + 2.5 + 4.2 + 6.0	1365	12.8	7.60	3.80	A	2800	
	1.6 + 2.0 + 2.5 + 4.2 + 7.1	1365	12.8	7.60	3.80	A	2800	
	1.6 + 2.0 + 2.5 + 5.0 + 5.0	1415	13.3	7.60	3.80	A	2800	
	1.6 + 2.0 + 2.5 + 5.0 + 6.0	1415	13.3	7.60	3.80	A	2800	
	1.6 + 2.0 + 2.5 + 5.0 + 7.1	1415	13.3	7.60	3.80	A	2800	
	1.6 + 2.0 + 2.5 + 6.0 + 6.0	1415	13.3	7.60	3.80	A	2800	
	1.6 + 2.0 + 3.5 + 3.5 + 3.5	1340	12.6	7.60	3.80	A	2800	
	1.6 + 2.0 + 3.5 + 3.5 + 4.2	1340	12.6	7.60	3.80	A	2800	
	1.6 + 2.0 + 3.5 + 3.5 + 5.0	1365	12.8	7.60	3.80	A	2800	
	1.6 + 2.0 + 3.5 + 3.5 + 6.0	1365	12.8	7.60	3.80	A	2800	
	1.6 + 2.0 + 3.5 + 3.5 + 7.1	1360	12.8	7.60	3.80	A	2800	
	1.6 + 2.0 + 3.5 + 4.2 + 4.2	1340	12.6	7.60	3.80	A	2800	
	1.6 + 2.0 + 3.5 + 4.2 + 5.0	1365	12.8	7.60	3.80	A	2800	
	1.6 + 2.0 + 3.5 + 4.2 + 6.0	1365	12.8	7.60	3.80	A	2800	
	1.6 + 2.0 + 3.5 + 5.0 + 5.0	1415	13.3	7.60	3.80	A	2800	
	1.6 + 2.0 + 3.5 + 5.0 + 6.0	1415	13.3	7.60	3.80	A	2800	
	1.6 + 2.0 + 4.2 + 4.2 + 4.2	1335	12.5	7.60	3.80	A	2800	
	1.6 + 2.0 + 4.2 + 4.2 + 5.0	1380	13.0	7.60	3.80	A	2800	
	1.6 + 2.0 + 4.2 + 4.2 + 6.0	1380	13.0	7.60	3.80	A	2800	
	1.6 + 2.0 + 4.2 + 5.0 + 5.0	1430	13.4	7.60	3.80	A	2800	
1.6 + 2.5 + 2.5 + 2.5 + 2.5	1320	12.4	7.60	3.80	A	2800		
1.6 + 2.5 + 2.5 + 2.5 + 3.5	1335	12.5	7.60	3.80	A	2800		
1.6 + 2.5 + 2.5 + 2.5 + 4.2	1330	12.5	7.60	3.80	A	2800		
1.6 + 2.5 + 2.5 + 2.5 + 5.0	1350	12.7	7.60	3.80	A	2800		
1.6 + 2.5 + 2.5 + 2.5 + 6.0	1350	12.7	7.60	3.80	A	2800		
1.6 + 2.5 + 2.5 + 2.5 + 7.1	1350	12.7	7.60	3.80	A	2800		
1.6 + 2.5 + 2.5 + 3.5 + 3.5	1325	12.5	7.60	3.80	A	2800		
1.6 + 2.5 + 2.5 + 3.5 + 4.2	1325	12.5	7.60	3.80	A	2800		
1.6 + 2.5 + 2.5 + 3.5 + 5.0	1345	12.6	7.60	3.80	A	2800		
1.6 + 2.5 + 2.5 + 3.5 + 6.0	1345	12.6	7.60	3.80	A	2800		
1.6 + 2.5 + 2.5 + 3.5 + 7.1	1365	12.8	7.60	3.80	A	2800		
1.6 + 2.5 + 2.5 + 4.2 + 4.2	1325	12.5	7.60	3.80	A	2800		
1.6 + 2.5 + 2.5 + 4.2 + 5.0	1365	12.8	7.60	3.80	A	2800		
1.6 + 2.5 + 2.5 + 4.2 + 6.0	1365	12.8	7.60	3.80	A	2800		
1.6 + 2.5 + 2.5 + 4.2 + 7.1	1365	12.8	7.60	3.80	A	2800		
1.6 + 2.5 + 2.5 + 5.0 + 5.0	1415	13.3	7.60	3.80	A	2800		
1.6 + 2.5 + 2.5 + 5.0 + 6.0	1415	13.3	7.60	3.80	A	2800		
1.6 + 2.5 + 3.5 + 3.5 + 3.5	1340	12.6	7.60	3.80	A	2800		

Indoor unit capacity Heating	Total	Heating Capacity (kW)							Input Power (W)			COP	
		Room A	Room B	Room C	Room D	Room E	Total	min ~ max	Rating	min ~ max	WW	CLASS	
1.6 + 2.5 + 3.5 + 3.5 + 4.2	15.3	1.09	1.70	2.38	2.38	2.85	10.40	3.4 ~ 14.5	2680	520 ~ 4140	3.88	A	
1.6 + 2.5 + 3.5 + 3.5 + 5.0	16.1	1.03	1.61	2.26	2.26	3.24	10.40	3.4 ~ 14.5	2730	620 ~ 4090	3.81	A	
1.6 + 2.5 + 3.5 + 3.5 + 6.0	17.1	0.97	1.52	2.13	2.13	3.65	10.40	3.4 ~ 14.5	2730	620 ~ 4090	3.81	A	
1.6 + 2.5 + 3.5 + 3.5 + 7.1	18.2	0.91	1.43	2.00	2.00	4.06	10.40	3.4 ~ 14.5	2720	630 ~ 4130	3.82	A	
1.6 + 2.5 + 3.5 + 4.2 + 4.2	16.0	1.03	1.63	2.28	2.73	2.73	10.40	3.4 ~ 14.5	2680	530 ~ 4130	3.88	A	
1.6 + 2.5 + 3.5 + 4.2 + 5.0	16.8	0.99	1.55	2.17	2.60	3.09	10.40	3.4 ~ 14.5	2730	630 ~ 4130	3.81	A	
1.6 + 2.5 + 3.5 + 4.2 + 6.0	17.8	0.93	1.46	2.04	2.45	3.52	10.40	3.4 ~ 14.5	2730	630 ~ 4130	3.81	A	
1.6 + 2.5 + 3.5 + 5.0 + 5.0	17.6	0.95	1.48	2.07	2.95	2.95	10.40	3.4 ~ 14.5	2830	740 ~ 4150	3.67	A	
1.6 + 2.5 + 4.2 + 4.2 + 4.2	16.7	0.98	1.56	2.62	2.62	2.62	10.40	3.4 ~ 14.5	2670	540 ~ 4120	3.90	A	
1.6 + 2.5 + 4.2 + 4.2 + 5.0	17.5	0.95	1.49	2.50	2.50	2.96	10.40	3.4 ~ 14.5	2760	630 ~ 4120	3.77	A	
1.6 + 2.5 + 4.2 + 5.0 + 5.0	18.3	0.91	1.42	2.39	2.84	2.84	10.40	3.4 ~ 14.5	2860	750 ~ 4140	3.64	A	
1.6 + 3.5 + 3.5 + 3.5 + 3.5	15.6	1.08	2.33	2.33	2.33	2.33	10.40	3.4 ~ 14.5	2670	540 ~ 4120	3.90	A	
1.6 + 3.5 + 3.5 + 3.5 + 4.2	16.3	1.02	2.23	2.23	2.23	2.69	10.40	3.4 ~ 14.5	2670	540 ~ 4110	3.90	A	
1.6 + 3.5 + 3.5 + 3.5 + 5.0	17.1	0.97	2.13	2.13	2.13	3.04	10.40	3.4 ~ 14.5	2760	650 ~ 4120	3.77	A	
1.6 + 3.5 + 3.5 + 3.5 + 6.0	18.1	0.92	2.01	2.01	2.01	3.45	10.40	3.4 ~ 14.5	2760	650 ~ 4120	3.77	A	
1.6 + 3.5 + 3.5 + 4.2 + 4.2	17.0	0.98	2.14	2.14	2.57	2.57	10.40	3.4 ~ 14.5	2670	550 ~ 4100	3.90	A	
1.6 + 3.5 + 3.5 + 4.2 + 5.0	17.8	0.93	2.04	2.04	2.45	2.94	10.40	3.4 ~ 14.5	2760	650 ~ 4110	3.77	A	
1.6 + 3.5 + 4.2 + 4.2 + 4.2	17.7	0.93	2.06	2.47	2.47	2.47	10.40	3.4 ~ 14.5	2700	560 ~ 4090	3.85	A	
2.0 + 2.0 + 2.0 + 2.0 + 2.0	10.0	2.08	2.08	2.08	2.08	2.08	10.40	3.4 ~ 14.5	2630	460 ~ 4170	3.95	A	
2.0 + 2.0 + 2.0 + 2.0 + 2.5	10.5	1.98	1.98	1.98	1.98	2.48	10.40	3.4 ~ 14.5	2630	460 ~ 4170	3.95	A	
2.0 + 2.0 + 2.0 + 2.0 + 3.5	11.5	1.81	1.81	1.81	1.81	3.16	10.40	3.4 ~ 14.5	2660	480 ~ 4140	3.91	A	
2.0 + 2.0 + 2.0 + 2.0 + 4.2	12.2	1.70	1.70	1.70	1.70	3.60	10.40	3.4 ~ 14.5	2660	490 ~ 4130	3.91	A	
2.0 + 2.0 + 2.0 + 2.0 + 5.0	13.0	1.60	1.60	1.60	1.60	4.00	10.40	3.4 ~ 14.5	2700	580 ~ 4130	3.85	A	
2.0 + 2.0 + 2.0 + 2.0 + 6.0	14.0	1.49	1.49	1.49	1.49	4.44	10.40	3.4 ~ 14.5	2700	580 ~ 4130	3.85	A	
2.0 + 2.0 + 2.0 + 2.0 + 7.1	15.1	1.38	1.38	1.38	1.38	4.88	10.40	3.4 ~ 14.5	2690	590 ~ 4110	3.87	A	
2.0 + 2.0 + 2.0 + 2.5 + 2.5	11.0	1.89	1.89	1.89	2.36	2.36	10.39	3.4 ~ 14.5	2630	460 ~ 4170	3.95	A	
2.0 + 2.0 + 2.0 + 2.5 + 3.5	12.0	1.73	1.73	1.73	2.17	3.04	10.40	3.4 ~ 14.5	2660	480 ~ 4140	3.91	A	
2.0 + 2.0 + 2.0 + 2.5 + 4.2	12.7	1.64	1.64	1.64	2.05	3.43	10.40	3.4 ~ 14.5	2660	490 ~ 4130	3.91	A	
2.0 + 2.0 + 2.0 + 2.5 + 5.0	13.5	1.54	1.54	1.54	1.93	3.85	10.40	3.4 ~ 14.5	2700	580 ~ 4130	3.85	A	
2.0 + 2.0 + 2.0 + 2.5 + 6.0	14.5	1.43	1.43	1.43	1.79	4.32	10.40	3.4 ~ 14.5	2700	580 ~ 4130	3.85	A	
2.0 + 2.0 + 2.0 + 2.5 + 7.1	15.6	1.33	1.33	1.33	1.67	4.74	10.40	3.4 ~ 14.5	2690	590 ~ 4110	3.87	A	
2.0 + 2.0 + 2.0 + 3.5 + 3.5	13.0	1.60	1.60	1.60	2.80	2.80	10.40	3.4 ~ 14.5	2650	510 ~ 4110	3.92	A	
2.0 + 2.0 + 2.0 + 3.5 + 4.2	13.7	1.52	1.52	1.52	2.66	3.18	10.40	3.4 ~ 14.5	2650	510 ~ 4100	3.92	A	
2.0 + 2.0 + 2.0 + 3.5 + 5.0	14.5	1.43	1.43	1.43	2.51	3.60	10.40	3.4 ~ 14.5	2730	600 ~ 4100	3.81	A	
2.0 + 2.0 + 2.0 + 3.5 + 6.0	15.5	1.34	1.34	1.34	2.35	4.03	10.40	3.4 ~ 14.5	2730	600 ~ 4100	3.81	A	
2.0 + 2.0 + 2.0 + 3.5 + 7.1	16.6	1.25	1.25	1.25	2.19	4.46	10.40	3.4 ~ 14.5	2730	620 ~ 4090	3.81	A	
2.0 + 2.0 + 2.0 + 4.2 + 4.2	14.4	1.44	1.44	1.44	3.04	3.04	10.40	3.4 ~ 14.5	2680	520 ~ 4090	3.88	A	
2.0 + 2.0 + 2.0 + 4.2 + 5.0	15.2	1.37	1.37	1.37	2.87	3.42	10.40	3.4 ~ 14.5	2730	610 ~ 4090	3.81	A	
2.0 + 2.0 + 2.0 + 4.2 + 6.0	16.2	1.28	1.28	1.28	2.70	3.86	10.40	3.4 ~ 14.5	2730	610 ~ 4090	3.81	A	
2.0 + 2.0 + 2.0 + 4.2 + 7.1	17.3	1.20	1.20	1.20	2.52	4.28	10.40	3.4 ~ 14.5	2730	630 ~ 4130	3.81	A	
2.0 + 2.0 + 2.0 + 5.0 + 5.0	16.0	1.30	1.30	1.30	3.25	3.25	10.40	3.4 ~ 14.5	2830	720 ~ 4160	3.67	A	
2.0 + 2.0 + 2.0 + 5.0 + 6.0	17.0	1.22	1.22	1.22	3.06	3.68	10.40	3.4 ~ 14.5	2830	720 ~ 4160	3.67	A	
2.0 + 2.0 + 2.0 + 5.0 + 7.1	18.1	1.15	1.15	1.15	2.87	4.08	10.40	3.4 ~ 14.5	2830	740 ~ 4150	3.67	A	
2.0 + 2.0 + 2.0 + 6.0 + 6.0	18.0	1.16	1.16	1.16	3.46	3.46	10.40	3.4 ~ 14.5	2830	720 ~ 4160	3.67	A	
2.0 + 2.0 + 2.5 + 2.5 + 2.5	11.5	1.81	1.81	2.26	2.26	2.26	10.40	3.4 ~ 14.5	2630	460 ~ 4170	3.95	A	
2.0 + 2.0 + 2.5 + 2.5 + 3.5	12.5	1.66	1.66	2.08	2.08	2.92	10.40	3.4 ~ 14.5	2660	480 ~ 4140	3.91	A	
2.0 + 2.0 + 2.5 + 2.5 + 4.2	13.2	1.58	1.58	1.97	1.97	3.30	10.40	3.4 ~ 14.5	2660	490 ~ 4130	3.91	A	
2.0 + 2.0 + 2.5 + 2.5 + 5.0	14.0	1.49	1.49	1.86	1.86	3.70	10.40	3.4 ~ 14.5	2700	580 ~ 4130	3.85	A	
2.0 + 2.0 + 2.5 + 2.5 + 6.0	15.0	1.39	1.39	1.73	1.73	4.16	10.40	3.4 ~ 14.5	2700	580 ~ 4130	3.85	A	
2.0 + 2.0 + 2.5 + 2.5 + 7.1	16.1	1.29	1.29	1.61	1.61	4.60	10.40	3.4 ~ 14.5	2690	590 ~ 4110	3.87	A	
2.0 + 2.0 + 2.5 + 3.5 + 3.5	13.5	1.54	1.54	1.92	2.70	2.70	10.40	3.4 ~ 14.5	2650	510 ~ 4110	3.92	A	
2.0 + 2.0 + 2.5 + 3.5 + 4.2	14.2	1.46	1.46	1.83	2.56	3.09	10.40	3.4 ~ 14.5	2650	510 ~ 4100	3.92	A	
2.0 + 2.0 + 2.5 + 3.5 + 5.0	15.0	1.39	1.39	1.73	2.43	3.46	10.40	3.4 ~ 14.5	2730	600 ~ 4100	3.81	A	
2.0 + 2.0 + 2.5 + 3.5 + 6.0	16.0	1.30	1.30	1.63	2.28	3.89	10.40	3.4 ~ 14.5	2730	600 ~ 4100	3.81	A	
2.0 + 2.0 + 2.5 + 3.5 + 7.1	17.1	1.22	1.22	1.52	2.13	4.31	10.40	3.4 ~ 14.5	2730	620 ~ 4090	3.81	A	
2.0 + 2.0 + 2.5 + 4.2 + 4.2	14.9	1.40	1.40	1.74	2.93	2.93	10.40	3.4 ~ 14.5	2680	520 ~ 4090	3.88	A	
2.0 + 2.0 + 2.5 + 4.2 + 5.0	15.7	1.32	1.32	1.66	2.78	3.32	10.40	3.4 ~ 14.5	2730	610 ~ 4090	3.81	A	
2.0 + 2.0 + 2.5 + 4.2 + 6.0	16.7	1.25	1.25	1.56	2.62	3.72	10.40	3.4 ~ 14.5	2730	610 ~ 4090	3.81	A	

	Indoor unit capacity Heating	Annual Energy Consumption (kWh)	Current 230V (A)	ERP			Moisture Removal Volume l/h	
				Pdesign (kW)	SCOP			Annual Consumption (kWh)
					W/W	CLASS		
5 Room	1.6 + 2.5 + 3.5 + 3.5 + 4.2	1340	12.6	7.60	3.80	A	2800	
	1.6 + 2.5 + 3.5 + 3.5 + 5.0	1365	12.8	7.60	3.80	A	2800	
	1.6 + 2.5 + 3.5 + 3.5 + 6.0	1365	12.8	7.60	3.80	A	2800	
	1.6 + 2.5 + 3.5 + 3.5 + 7.1	1360	12.8	7.60	3.80	A	2800	
	1.6 + 2.5 + 3.5 + 4.2 + 4.2	1340	12.6	7.60	3.80	A	2800	
	1.6 + 2.5 + 3.5 + 4.2 + 5.0	1365	12.8	7.60	3.80	A	2800	
	1.6 + 2.5 + 3.5 + 4.2 + 6.0	1365	12.8	7.60	3.80	A	2800	
	1.6 + 2.5 + 3.5 + 5.0 + 5.0	1415	13.3	7.60	3.80	A	2800	
	1.6 + 2.5 + 4.2 + 4.2 + 4.2	1335	12.5	7.60	3.80	A	2800	
	1.6 + 2.5 + 4.2 + 4.2 + 5.0	1380	13.0	7.60	3.80	A	2800	
	1.6 + 2.5 + 4.2 + 5.0 + 5.0	1430	13.4	7.60	3.80	A	2800	
	1.6 + 3.5 + 3.5 + 3.5 + 3.5	1335	12.5	7.60	3.80	A	2800	
	1.6 + 3.5 + 3.5 + 3.5 + 4.2	1335	12.5	7.60	3.80	A	2800	
	1.6 + 3.5 + 3.5 + 3.5 + 5.0	1380	13.0	7.60	3.80	A	2800	
	1.6 + 3.5 + 3.5 + 3.5 + 6.0	1380	13.0	7.60	3.80	A	2800	
	1.6 + 3.5 + 3.5 + 4.2 + 4.2	1335	12.5	7.60	3.80	A	2800	
	1.6 + 3.5 + 3.5 + 4.2 + 5.0	1380	13.0	7.60	3.80	A	2800	
	1.6 + 3.5 + 4.2 + 4.2 + 4.2	1350	12.7	7.60	3.80	A	2800	
	2.0 + 2.0 + 2.0 + 2.0 + 2.0	1315	12.4	7.60	3.80	A	2800	
	2.0 + 2.0 + 2.0 + 2.0 + 2.5	1315	12.4	7.60	3.80	A	2800	
	2.0 + 2.0 + 2.0 + 2.0 + 3.5	1330	12.5	7.60	3.80	A	2800	
	2.0 + 2.0 + 2.0 + 2.0 + 4.2	1330	12.5	7.60	3.80	A	2800	
	2.0 + 2.0 + 2.0 + 2.0 + 5.0	1350	12.7	7.60	3.80	A	2800	
	2.0 + 2.0 + 2.0 + 2.0 + 6.0	1350	12.7	7.60	3.80	A	2800	
	2.0 + 2.0 + 2.0 + 2.0 + 7.1	1345	12.6	7.60	3.80	A	2800	
	2.0 + 2.0 + 2.0 + 2.5 + 2.5	1315	12.4	7.60	3.80	A	2800	
	2.0 + 2.0 + 2.0 + 2.5 + 3.5	1330	12.5	7.60	3.80	A	2800	
	2.0 + 2.0 + 2.0 + 2.5 + 4.2	1330	12.5	7.60	3.80	A	2800	
	2.0 + 2.0 + 2.0 + 2.5 + 5.0	1350	12.7	7.60	3.80	A	2800	
	2.0 + 2.0 + 2.0 + 2.5 + 6.0	1350	12.7	7.60	3.80	A	2800	
	2.0 + 2.0 + 2.0 + 2.5 + 7.1	1345	12.6	7.60	3.80	A	2800	
	2.0 + 2.0 + 2.0 + 3.5 + 3.5	1325	12.5	7.60	3.80	A	2800	
	2.0 + 2.0 + 2.0 + 3.5 + 4.2	1325	12.5	7.60	3.80	A	2800	
	2.0 + 2.0 + 2.0 + 3.5 + 5.0	1365	12.8	7.60	3.80	A	2800	
	2.0 + 2.0 + 2.0 + 3.5 + 6.0	1365	12.8	7.60	3.80	A	2800	
	2.0 + 2.0 + 2.0 + 3.5 + 7.1	1365	12.8	7.60	3.80	A	2800	
	2.0 + 2.0 + 2.0 + 4.2 + 4.2	1340	12.6	7.60	3.80	A	2800	
	2.0 + 2.0 + 2.0 + 4.2 + 5.0	1365	12.8	7.60	3.80	A	2800	
	2.0 + 2.0 + 2.0 + 4.2 + 6.0	1365	12.8	7.60	3.80	A	2800	
	2.0 + 2.0 + 2.0 + 4.2 + 7.1	1365	12.8	7.60	3.80	A	2800	
	2.0 + 2.0 + 2.0 + 5.0 + 5.0	1415	13.3	7.60	3.80	A	2800	
	2.0 + 2.0 + 2.0 + 5.0 + 6.0	1415	13.3	7.60	3.80	A	2800	
	2.0 + 2.0 + 2.0 + 5.0 + 7.1	1415	13.3	7.60	3.80	A	2800	
	2.0 + 2.0 + 2.0 + 6.0 + 6.0	1415	13.3	7.60	3.80	A	2800	
	2.0 + 2.0 + 2.5 + 2.5 + 2.5	1315	12.4	7.60	3.80	A	2800	
	2.0 + 2.0 + 2.5 + 2.5 + 3.5	1330	12.5	7.60	3.80	A	2800	
	2.0 + 2.0 + 2.5 + 2.5 + 4.2	1330	12.5	7.60	3.80	A	2800	
	2.0 + 2.0 + 2.5 + 2.5 + 5.0	1350	12.7	7.60	3.80	A	2800	
	2.0 + 2.0 + 2.5 + 2.5 + 6.0	1350	12.7	7.60	3.80	A	2800	
	2.0 + 2.0 + 2.5 + 2.5 + 7.1	1345	12.6	7.60	3.80	A	2800	
2.0 + 2.0 + 2.5 + 3.5 + 3.5	1325	12.5	7.60	3.80	A	2800		
2.0 + 2.0 + 2.5 + 3.5 + 4.2	1325	12.5	7.60	3.80	A	2800		
2.0 + 2.0 + 2.5 + 3.5 + 5.0	1365	12.8	7.60	3.80	A	2800		
2.0 + 2.0 + 2.5 + 3.5 + 6.0	1365	12.8	7.60	3.80	A	2800		
2.0 + 2.0 + 2.5 + 3.5 + 7.1	1365	12.8	7.60	3.80	A	2800		
2.0 + 2.0 + 2.5 + 4.2 + 4.2	1340	12.6	7.60	3.80	A	2800		
2.0 + 2.0 + 2.5 + 4.2 + 5.0	1365	12.8	7.60	3.80	A	2800		
2.0 + 2.0 + 2.5 + 4.2 + 6.0	1365	12.8	7.60	3.80	A	2800		

Indoor unit capacity Heating		Total	Heating Capacity (kW)						Input Power (W)			COP	
			Room A	Room B	Room C	Room D	Room E	Total	min ~ max	Rating	min ~ max	WW	CLASS
5 Room	2.0 + 2.0 + 2.5 + 4.2 + 7.1	17.8	1.17	1.17	1.46	2.45	4.15	10.40	3.4 ~ 14.5	2730	630 ~ 4130	3.81	A
	2.0 + 2.0 + 2.5 + 5.0 + 5.0	16.5	1.26	1.26	1.58	3.15	3.15	10.40	3.4 ~ 14.5	2830	720 ~ 4160	3.67	A
	2.0 + 2.0 + 2.5 + 5.0 + 6.0	17.5	1.19	1.19	1.49	2.97	3.56	10.40	3.4 ~ 14.5	2830	720 ~ 4160	3.67	A
	2.0 + 2.0 + 3.5 + 3.5 + 3.5	14.5	1.43	1.43	2.51	2.51	2.51	10.39	3.4 ~ 14.5	2680	520 ~ 4140	3.88	A
	2.0 + 2.0 + 3.5 + 3.5 + 4.2	15.2	1.37	1.37	2.39	2.39	2.88	10.40	3.4 ~ 14.5	2680	530 ~ 4130	3.88	A
	2.0 + 2.0 + 3.5 + 3.5 + 5.0	16.0	1.30	1.30	2.28	2.28	3.24	10.40	3.4 ~ 14.5	2730	630 ~ 4130	3.81	A
	2.0 + 2.0 + 3.5 + 3.5 + 6.0	17.0	1.22	1.22	2.14	2.14	3.68	10.40	3.4 ~ 14.5	2730	630 ~ 4130	3.81	A
	2.0 + 2.0 + 3.5 + 3.5 + 7.1	18.1	1.15	1.15	2.01	2.01	4.08	10.40	3.4 ~ 14.5	2760	640 ~ 4120	3.77	A
	2.0 + 2.0 + 3.5 + 4.2 + 4.2	15.9	1.31	1.31	2.28	2.75	2.75	10.40	3.4 ~ 14.5	2670	540 ~ 4120	3.90	A
	2.0 + 2.0 + 3.5 + 4.2 + 5.0	16.7	1.25	1.25	2.18	2.62	3.10	10.40	3.4 ~ 14.5	2760	630 ~ 4120	3.77	A
	2.0 + 2.0 + 3.5 + 4.2 + 6.0	17.7	1.18	1.18	2.06	2.47	3.51	10.40	3.4 ~ 14.5	2760	630 ~ 4120	3.77	A
	2.0 + 2.0 + 3.5 + 5.0 + 5.0	17.5	1.19	1.19	2.08	2.97	2.97	10.40	3.4 ~ 14.5	2860	750 ~ 4140	3.64	A
	2.0 + 2.0 + 4.2 + 4.2 + 4.2	16.6	1.25	1.25	2.63	2.63	2.63	10.39	3.4 ~ 14.5	2670	540 ~ 4110	3.89	A
	2.0 + 2.0 + 4.2 + 4.2 + 5.0	17.4	1.20	1.20	2.51	2.51	2.98	10.40	3.4 ~ 14.5	2760	650 ~ 4110	3.77	A
	2.0 + 2.0 + 4.2 + 5.0 + 5.0	18.2	1.14	1.14	2.40	2.86	2.86	10.40	3.4 ~ 14.5	2870	750 ~ 4190	3.62	A
	2.0 + 2.5 + 2.5 + 2.5 + 2.5	12.0	1.72	2.17	2.17	2.17	2.17	10.40	3.4 ~ 14.5	2630	460 ~ 4170	3.95	A
	2.0 + 2.5 + 2.5 + 2.5 + 3.5	13.0	1.60	2.00	2.00	2.00	2.80	10.40	3.4 ~ 14.5	2660	480 ~ 4140	3.91	A
	2.0 + 2.5 + 2.5 + 2.5 + 4.2	13.7	1.52	1.90	1.90	1.90	3.18	10.40	3.4 ~ 14.5	2660	490 ~ 4130	3.91	A
	2.0 + 2.5 + 2.5 + 2.5 + 5.0	14.5	1.43	1.79	1.79	1.79	3.60	10.40	3.4 ~ 14.5	2700	580 ~ 4130	3.85	A
	2.0 + 2.5 + 2.5 + 2.5 + 6.0	15.5	1.34	1.68	1.68	1.68	4.02	10.40	3.4 ~ 14.5	2700	580 ~ 4130	3.85	A
	2.0 + 2.5 + 2.5 + 2.5 + 7.1	16.6	1.25	1.57	1.57	1.57	4.44	10.40	3.4 ~ 14.5	2690	590 ~ 4110	3.87	A
	2.0 + 2.5 + 2.5 + 3.5 + 3.5	14.0	1.48	1.86	1.86	2.60	2.60	10.40	3.4 ~ 14.5	2650	510 ~ 4110	3.92	A
	2.0 + 2.5 + 2.5 + 3.5 + 4.2	14.7	1.41	1.77	1.77	2.48	2.97	10.40	3.4 ~ 14.5	2650	510 ~ 4100	3.92	A
	2.0 + 2.5 + 2.5 + 3.5 + 5.0	15.5	1.34	1.68	1.68	2.35	3.35	10.40	3.4 ~ 14.5	2730	600 ~ 4100	3.81	A
	2.0 + 2.5 + 2.5 + 3.5 + 6.0	16.5	1.26	1.58	1.58	2.21	3.77	10.40	3.4 ~ 14.5	2730	600 ~ 4100	3.81	A
	2.0 + 2.5 + 2.5 + 3.5 + 7.1	17.6	1.18	1.48	1.48	2.07	4.19	10.40	3.4 ~ 14.5	2730	620 ~ 4090	3.81	A
	2.0 + 2.5 + 2.5 + 4.2 + 4.2	15.4	1.34	1.69	1.69	2.84	2.84	10.40	3.4 ~ 14.5	2680	520 ~ 4090	3.88	A
	2.0 + 2.5 + 2.5 + 4.2 + 5.0	16.2	1.28	1.60	1.60	2.70	3.22	10.40	3.4 ~ 14.5	2730	610 ~ 4090	3.81	A
	2.0 + 2.5 + 2.5 + 4.2 + 6.0	17.2	1.21	1.51	1.51	2.54	3.63	10.40	3.4 ~ 14.5	2730	610 ~ 4090	3.81	A
	2.0 + 2.5 + 2.5 + 4.2 + 7.1	18.3	1.14	1.42	1.42	2.39	4.03	10.40	3.4 ~ 14.5	2730	630 ~ 4130	3.81	A
	2.0 + 2.5 + 2.5 + 5.0 + 5.0	17.0	1.22	1.53	1.53	3.06	3.06	10.40	3.4 ~ 14.5	2830	720 ~ 4160	3.67	A
	2.0 + 2.5 + 2.5 + 5.0 + 6.0	18.0	1.16	1.44	1.44	2.89	3.47	10.40	3.4 ~ 14.5	2830	720 ~ 4160	3.67	A
	2.0 + 2.5 + 3.5 + 3.5 + 3.5	15.0	1.38	1.73	2.43	2.43	2.43	10.40	3.4 ~ 14.5	2680	520 ~ 4140	3.88	A
	2.0 + 2.5 + 3.5 + 3.5 + 4.2	15.7	1.32	1.66	2.32	2.32	2.78	10.40	3.4 ~ 14.5	2680	530 ~ 4130	3.88	A
	2.0 + 2.5 + 3.5 + 3.5 + 5.0	16.5	1.26	1.58	2.21	2.21	3.14	10.40	3.4 ~ 14.5	2730	630 ~ 4130	3.81	A
	2.0 + 2.5 + 3.5 + 3.5 + 6.0	17.5	1.19	1.49	2.08	2.08	3.56	10.40	3.4 ~ 14.5	2730	630 ~ 4130	3.81	A
	2.0 + 2.5 + 3.5 + 4.2 + 4.2	16.4	1.27	1.59	2.22	2.66	2.66	10.40	3.4 ~ 14.5	2670	540 ~ 4120	3.90	A
	2.0 + 2.5 + 3.5 + 4.2 + 5.0	17.2	1.21	1.51	2.12	2.54	3.02	10.40	3.4 ~ 14.5	2760	630 ~ 4120	3.77	A
	2.0 + 2.5 + 3.5 + 4.2 + 6.0	18.2	1.14	1.43	2.00	2.40	3.43	10.40	3.4 ~ 14.5	2760	630 ~ 4120	3.77	A
	2.0 + 2.5 + 3.5 + 5.0 + 5.0	18.0	1.16	1.44	2.02	2.89	2.89	10.40	3.4 ~ 14.5	2860	750 ~ 4140	3.64	A
	2.0 + 2.5 + 4.2 + 4.2 + 4.2	17.1	1.23	1.52	2.55	2.55	2.55	10.40	3.4 ~ 14.5	2670	540 ~ 4110	3.90	A
	2.0 + 2.5 + 4.2 + 4.2 + 5.0	17.9	1.16	1.45	2.44	2.44	2.91	10.40	3.4 ~ 14.5	2760	650 ~ 4110	3.77	A
	2.0 + 3.5 + 3.5 + 3.5 + 3.5	16.0	1.28	2.28	2.28	2.28	2.28	10.40	3.4 ~ 14.5	2670	540 ~ 4110	3.90	A
2.0 + 3.5 + 3.5 + 3.5 + 4.2	16.7	1.25	2.18	2.18	2.18	2.61	10.40	3.4 ~ 14.5	2670	550 ~ 4100	3.90	A	
2.0 + 3.5 + 3.5 + 3.5 + 5.0	17.5	1.19	2.08	2.08	2.08	2.97	10.40	3.4 ~ 14.5	2760	650 ~ 4110	3.77	A	
2.0 + 3.5 + 3.5 + 4.2 + 4.2	17.4	1.20	2.09	2.09	2.51	2.51	10.40	3.4 ~ 14.5	2700	560 ~ 4090	3.85	A	
2.0 + 3.5 + 3.5 + 4.2 + 5.0	18.2	1.14	2.00	2.00	2.40	2.86	10.40	3.4 ~ 14.5	2760	660 ~ 4100	3.77	A	
2.0 + 3.5 + 4.2 + 4.2 + 4.2	18.1	1.15	2.02	2.41	2.41	2.41	10.40	3.4 ~ 14.5	2700	570 ~ 4080	3.85	A	
2.5 + 2.5 + 2.5 + 2.5 + 2.5	12.5	2.08	2.08	2.08	2.08	2.08	10.40	3.4 ~ 14.5	2630	460 ~ 4170	3.95	A	
2.5 + 2.5 + 2.5 + 2.5 + 3.5	13.5	1.93	1.93	1.93	1.93	2.68	10.40	3.4 ~ 14.5	2660	480 ~ 4140	3.91	A	
2.5 + 2.5 + 2.5 + 2.5 + 4.2	14.2	1.83	1.83	1.83	1.83	3.08	10.40	3.4 ~ 14.5	2660	490 ~ 4130	3.91	A	
2.5 + 2.5 + 2.5 + 2.5 + 5.0	15.0	1.73	1.73	1.73	1.73	3.48	10.40	3.4 ~ 14.5	2700	580 ~ 4130	3.85	A	
2.5 + 2.5 + 2.5 + 2.5 + 6.0	16.0	1.63	1.63	1.63	1.63	3.88	10.40	3.4 ~ 14.5	2700	580 ~ 4130	3.85	A	
2.5 + 2.5 + 2.5 + 2.5 + 7.1	17.1	1.52	1.52	1.52	1.52	4.32	10.40	3.4 ~ 14.5	2690	590 ~ 4110	3.87	A	
2.5 + 2.5 + 2.5 + 3.5 + 3.5	14.5	1.79	1.79	1.79	2.51	2.51	10.39	3.4 ~ 14.5	2650	510 ~ 4110	3.92	A	
2.5 + 2.5 + 2.5 + 3.5 + 4.2	15.2	1.71	1.71	1.71	2.39	2.88	10.40	3.4 ~ 14.5	2650	510 ~ 4100	3.92	A	
2.5 + 2.5 + 2.5 + 3.5 + 5.0	16.0	1.63	1.63	1.63	2.28	3.23	10.40	3.4 ~ 14.5	2730	600 ~ 4100	3.81	A	
2.5 + 2.5 + 2.5 + 3.5 + 6.0	17.0	1.53	1.53	1.53	2.14	3.67	10.40	3.4 ~ 14.5	2730	600 ~ 4100	3.81	A	



	Indoor unit capacity Heating	Annual Energy Consumption (kWh)	Current 230V (A)	ERP			Moisture Removal Volume l/h	
				Pdesign (kW)	SCOP			Annual Consumption (kWh)
					W/W	CLASS		
5 Room	2.0+2.0+2.5+4.2+7.1	1365	12.8	7.60	3.80	A	2800	
	2.0+2.0+2.5+5.0+5.0	1415	13.3	7.60	3.80	A	2800	
	2.0+2.0+2.5+5.0+6.0	1415	13.3	7.60	3.80	A	2800	
	2.0+2.0+3.5+3.5+3.5	1340	12.6	7.60	3.80	A	2800	
	2.0+2.0+3.5+3.5+4.2	1340	12.6	7.60	3.80	A	2800	
	2.0+2.0+3.5+3.5+5.0	1365	12.8	7.60	3.80	A	2800	
	2.0+2.0+3.5+3.5+6.0	1365	12.8	7.60	3.80	A	2800	
	2.0+2.0+3.5+3.5+7.1	1380	13.0	7.60	3.80	A	2800	
	2.0+2.0+3.5+4.2+4.2	1335	12.5	7.60	3.80	A	2800	
	2.0+2.0+3.5+4.2+5.0	1380	13.0	7.60	3.80	A	2800	
	2.0+2.0+3.5+4.2+6.0	1380	13.0	7.60	3.80	A	2800	
	2.0+2.0+3.5+5.0+5.0	1430	13.4	7.60	3.80	A	2800	
	2.0+2.0+4.2+4.2+4.2	1335	12.5	7.60	3.80	A	2800	
	2.0+2.0+4.2+4.2+5.0	1380	13.0	7.60	3.80	A	2800	
	2.0+2.0+4.2+5.0+5.0	1435	13.5	7.60	3.80	A	2800	
	2.0+2.5+2.5+2.5+2.5	1315	12.4	7.60	3.80	A	2800	
	2.0+2.5+2.5+2.5+3.5	1330	12.5	7.60	3.80	A	2800	
	2.0+2.5+2.5+2.5+4.2	1330	12.5	7.60	3.80	A	2800	
	2.0+2.5+2.5+2.5+5.0	1350	12.7	7.60	3.80	A	2800	
	2.0+2.5+2.5+2.5+6.0	1350	12.7	7.60	3.80	A	2800	
	2.0+2.5+2.5+2.5+7.1	1345	12.6	7.60	3.80	A	2800	
	2.0+2.5+2.5+3.5+3.5	1325	12.5	7.60	3.80	A	2800	
	2.0+2.5+2.5+3.5+4.2	1325	12.5	7.60	3.80	A	2800	
	2.0+2.5+2.5+3.5+5.0	1365	12.8	7.60	3.80	A	2800	
	2.0+2.5+2.5+3.5+6.0	1365	12.8	7.60	3.80	A	2800	
	2.0+2.5+2.5+3.5+7.1	1365	12.8	7.60	3.80	A	2800	
	2.0+2.5+2.5+4.2+4.2	1340	12.6	7.60	3.80	A	2800	
	2.0+2.5+2.5+4.2+5.0	1365	12.8	7.60	3.80	A	2800	
	2.0+2.5+2.5+4.2+6.0	1365	12.8	7.60	3.80	A	2800	
	2.0+2.5+2.5+4.2+7.1	1365	12.8	7.60	3.80	A	2800	
	2.0+2.5+2.5+5.0+5.0	1415	13.3	7.60	3.80	A	2800	
	2.0+2.5+2.5+5.0+6.0	1415	13.3	7.60	3.80	A	2800	
	2.0+2.5+3.5+3.5+3.5	1340	12.6	7.60	3.80	A	2800	
	2.0+2.5+3.5+3.5+4.2	1340	12.6	7.60	3.80	A	2800	
	2.0+2.5+3.5+3.5+5.0	1365	12.8	7.60	3.80	A	2800	
	2.0+2.5+3.5+3.5+6.0	1365	12.8	7.60	3.80	A	2800	
	2.0+2.5+3.5+4.2+4.2	1335	12.5	7.60	3.80	A	2800	
	2.0+2.5+3.5+4.2+5.0	1380	13.0	7.60	3.80	A	2800	
	2.0+2.5+3.5+4.2+6.0	1380	13.0	7.60	3.80	A	2800	
	2.0+2.5+3.5+5.0+5.0	1430	13.4	7.60	3.80	A	2800	
	2.0+2.5+4.2+4.2+4.2	1335	12.5	7.60	3.80	A	2800	
	2.0+2.5+4.2+4.2+5.0	1380	13.0	7.60	3.80	A	2800	
	2.0+3.5+3.5+3.5+3.5	1335	12.5	7.60	3.80	A	2800	
	2.0+3.5+3.5+3.5+4.2	1335	12.5	7.60	3.80	A	2800	
	2.0+3.5+3.5+3.5+5.0	1380	13.0	7.60	3.80	A	2800	
	2.0+3.5+3.5+4.2+4.2	1350	12.7	7.60	3.80	A	2800	
	2.0+3.5+3.5+4.2+5.0	1380	13.0	7.60	3.80	A	2800	
	2.0+3.5+4.2+4.2+4.2	1350	12.7	7.60	3.80	A	2800	
	2.5+2.5+2.5+2.5+2.5	1315	12.4	7.60	3.80	A	2800	
	2.5+2.5+2.5+2.5+3.5	1330	12.5	7.60	3.80	A	2800	
2.5+2.5+2.5+2.5+4.2	1330	12.5	7.60	3.80	A	2800		
2.5+2.5+2.5+2.5+5.0	1350	12.7	7.60	3.80	A	2800		
2.5+2.5+2.5+2.5+6.0	1350	12.7	7.60	3.80	A	2800		
2.5+2.5+2.5+2.5+7.1	1345	12.6	7.60	3.80	A	2800		
2.5+2.5+2.5+3.5+3.5	1325	12.5	7.60	3.80	A	2800		
2.5+2.5+2.5+3.5+4.2	1325	12.5	7.60	3.80	A	2800		
2.5+2.5+2.5+3.5+5.0	1365	12.8	7.60	3.80	A	2800		
2.5+2.5+2.5+3.5+6.0	1365	12.8	7.60	3.80	A	2800		

Indoor unit capacity Heating		Total	Heating Capacity (kW)							Input Power (W)		COP	
			Room A	Room B	Room C	Room D	Room E	Total	min ~ max	Rating	min ~ max	WW	CLASS
5 Room	2.5 + 2.5 + 2.5 + 3.5 + 7.1	18.1	1.44	1.44	1.44	2.01	4.07	10.40	3.4 ~ 14.5	2730	620 ~ 4090	3.81	A
	2.5 + 2.5 + 2.5 + 4.2 + 4.2	15.9	1.64	1.64	1.64	2.74	2.74	10.40	3.4 ~ 14.5	2680	520 ~ 4090	3.88	A
	2.5 + 2.5 + 2.5 + 4.2 + 5.0	16.7	1.56	1.56	1.56	2.62	3.10	10.40	3.4 ~ 14.5	2730	610 ~ 4090	3.81	A
	2.5 + 2.5 + 2.5 + 4.2 + 6.0	17.7	1.47	1.47	1.47	2.47	3.52	10.40	3.4 ~ 14.5	2730	610 ~ 4090	3.81	A
	2.5 + 2.5 + 2.5 + 5.0 + 5.0	17.5	1.49	1.49	1.49	2.96	2.96	10.39	3.4 ~ 14.5	2830	720 ~ 4160	3.67	A
	2.5 + 2.5 + 3.5 + 3.5 + 3.5	15.5	1.67	1.67	2.35	2.35	2.35	10.39	3.4 ~ 14.5	2680	520 ~ 4140	3.88	A
	2.5 + 2.5 + 3.5 + 3.5 + 4.2	16.2	1.60	1.60	2.25	2.25	2.70	10.40	3.4 ~ 14.5	2680	530 ~ 4130	3.88	A
	2.5 + 2.5 + 3.5 + 3.5 + 5.0	17.0	1.53	1.53	2.14	2.14	3.06	10.40	3.4 ~ 14.5	2730	630 ~ 4130	3.81	A
	2.5 + 2.5 + 3.5 + 3.5 + 6.0	18.0	1.44	1.44	2.02	2.02	3.48	10.40	3.4 ~ 14.5	2730	630 ~ 4130	3.81	A
	2.5 + 2.5 + 3.5 + 4.2 + 4.2	16.9	1.54	1.54	2.16	2.58	2.58	10.40	3.4 ~ 14.5	2670	540 ~ 4120	3.90	A
	2.5 + 2.5 + 3.5 + 4.2 + 5.0	17.7	1.47	1.47	2.06	2.47	2.93	10.40	3.4 ~ 14.5	2760	630 ~ 4120	3.77	A
	2.5 + 2.5 + 4.2 + 4.2 + 4.2	17.6	1.48	1.48	2.48	2.48	2.48	10.40	3.4 ~ 14.5	2670	540 ~ 4110	3.90	A
	2.5 + 3.5 + 3.5 + 3.5 + 3.5	16.5	1.56	2.21	2.21	2.21	2.21	10.40	3.4 ~ 14.5	2670	540 ~ 4110	3.90	A
	2.5 + 3.5 + 3.5 + 3.5 + 4.2	17.2	1.51	2.12	2.12	2.12	2.53	10.40	3.4 ~ 14.5	2670	550 ~ 4100	3.90	A
	2.5 + 3.5 + 3.5 + 3.5 + 5.0	18.0	1.44	2.02	2.02	2.02	2.90	10.40	3.4 ~ 14.5	2760	650 ~ 4110	3.77	A
	2.5 + 3.5 + 3.5 + 4.2 + 4.2	17.9	1.46	2.03	2.03	2.44	2.44	10.40	3.4 ~ 14.5	2700	560 ~ 4090	3.85	A
	3.5 + 3.5 + 3.5 + 3.5 + 3.5	17.5	2.08	2.08	2.08	2.08	2.08	10.40	3.4 ~ 14.5	2700	570 ~ 4080	3.85	A
3.5 + 3.5 + 3.5 + 3.5 + 4.2	18.2	2.00	2.00	2.00	2.00	2.40	10.40	3.4 ~ 14.5	2700	570 ~ 4130	3.85	A	

	Indoor unit capacity Heating	Annual Energy Consumption (kWh)	Current 230V (A)	ERP				Moisture Removal Volume l/h
				Pdesign (kW)	SCOP		Annual Consumption (kWh)	
					W/W	CLASS		
5 Room	2.5 + 2.5 + 2.5 + 3.5 + 7.1	1365	12.8	7.60	3.80	A	2800	
	2.5 + 2.5 + 2.5 + 4.2 + 4.2	1340	12.6	7.60	3.80	A	2800	
	2.5 + 2.5 + 2.5 + 4.2 + 5.0	1365	12.8	7.60	3.80	A	2800	
	2.5 + 2.5 + 2.5 + 4.2 + 6.0	1365	12.8	7.60	3.80	A	2800	
	2.5 + 2.5 + 2.5 + 5.0 + 5.0	1415	13.3	7.60	3.80	A	2800	
	2.5 + 2.5 + 3.5 + 3.5 + 3.5	1340	12.6	7.60	3.80	A	2800	
	2.5 + 2.5 + 3.5 + 3.5 + 4.2	1340	12.6	7.60	3.80	A	2800	
	2.5 + 2.5 + 3.5 + 3.5 + 5.0	1365	12.8	7.60	3.80	A	2800	
	2.5 + 2.5 + 3.5 + 3.5 + 6.0	1365	12.8	7.60	3.80	A	2800	
	2.5 + 2.5 + 3.5 + 4.2 + 4.2	1335	12.5	7.60	3.80	A	2800	
	2.5 + 2.5 + 3.5 + 4.2 + 5.0	1380	13.0	7.60	3.80	A	2800	
	2.5 + 2.5 + 4.2 + 4.2 + 4.2	1335	12.5	7.60	3.80	A	2800	
	2.5 + 3.5 + 3.5 + 3.5 + 3.5	1335	12.5	7.60	3.80	A	2800	
	2.5 + 3.5 + 3.5 + 3.5 + 4.2	1335	12.5	7.60	3.80	A	2800	
	2.5 + 3.5 + 3.5 + 3.5 + 5.0	1380	13.0	7.60	3.80	A	2800	
	2.5 + 3.5 + 3.5 + 4.2 + 4.2	1350	12.7	7.60	3.80	A	2800	
	3.5 + 3.5 + 3.5 + 3.5 + 3.5	1350	12.7	7.60	3.80	A	2800	
3.5 + 3.5 + 3.5 + 3.5 + 4.2	1350	12.7	7.60	3.80	A	2800		

# 4. Dimensions

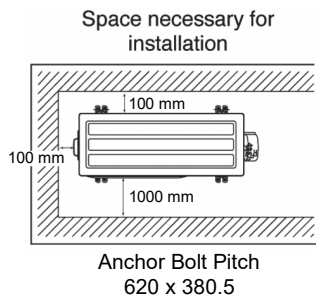

<Top View>

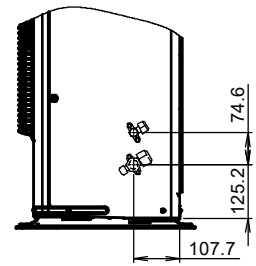
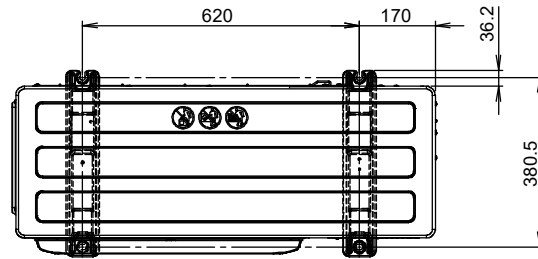

<Side View>

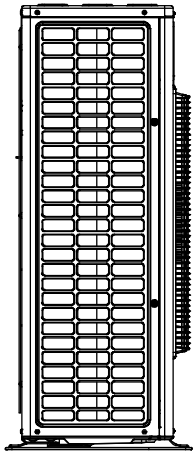

<Front View>

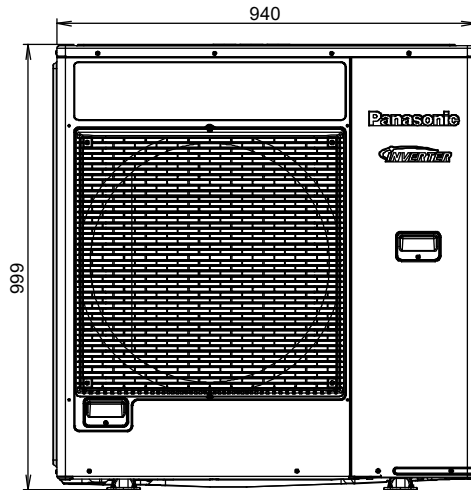

<Side View>

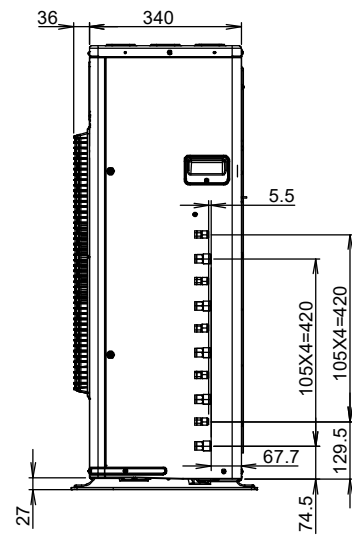

Unit: mm

# 5. Refrigeration Cycle Diagram

## 5.1 CU-4Z80TBE

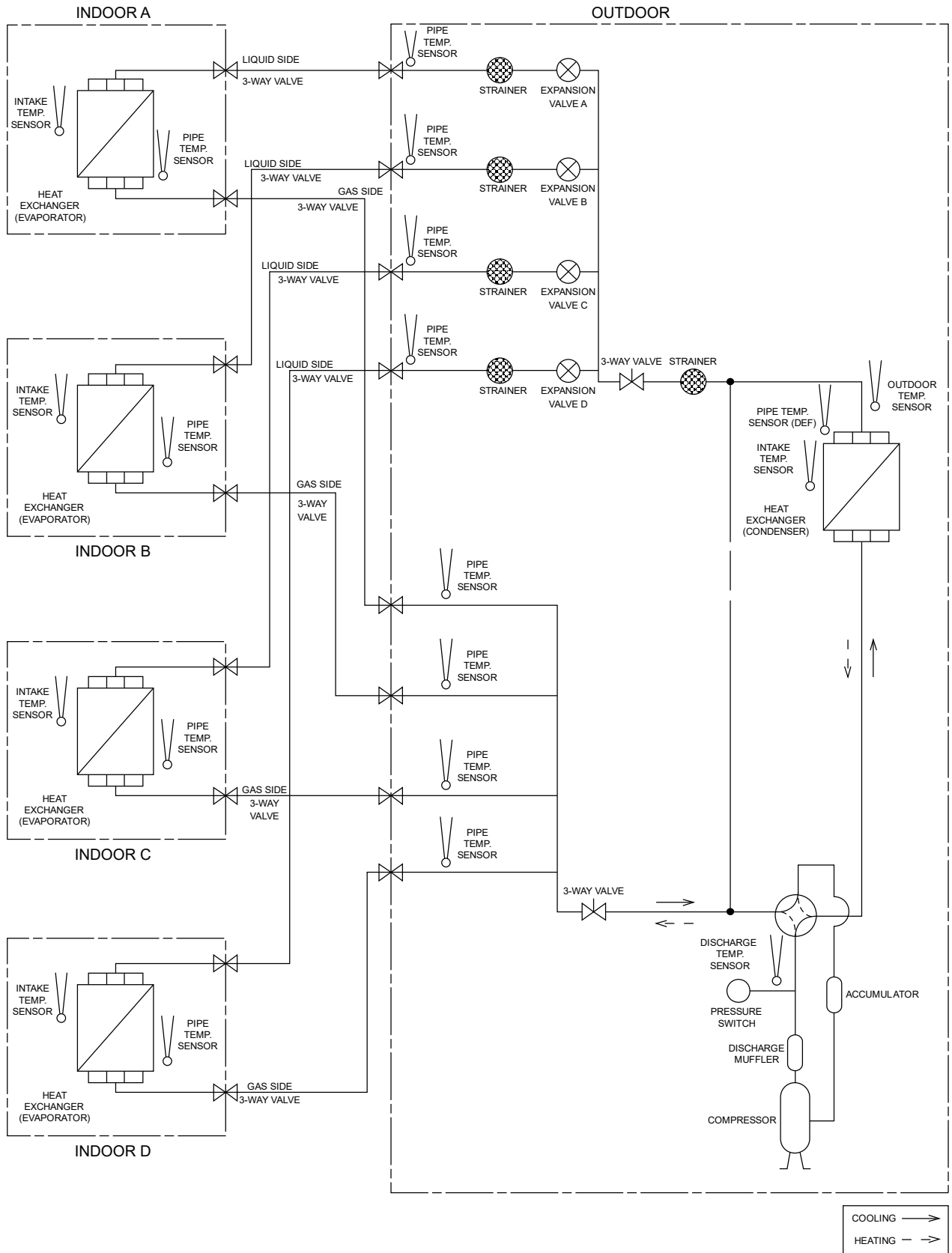

## 5.2 CU-5Z90TBE

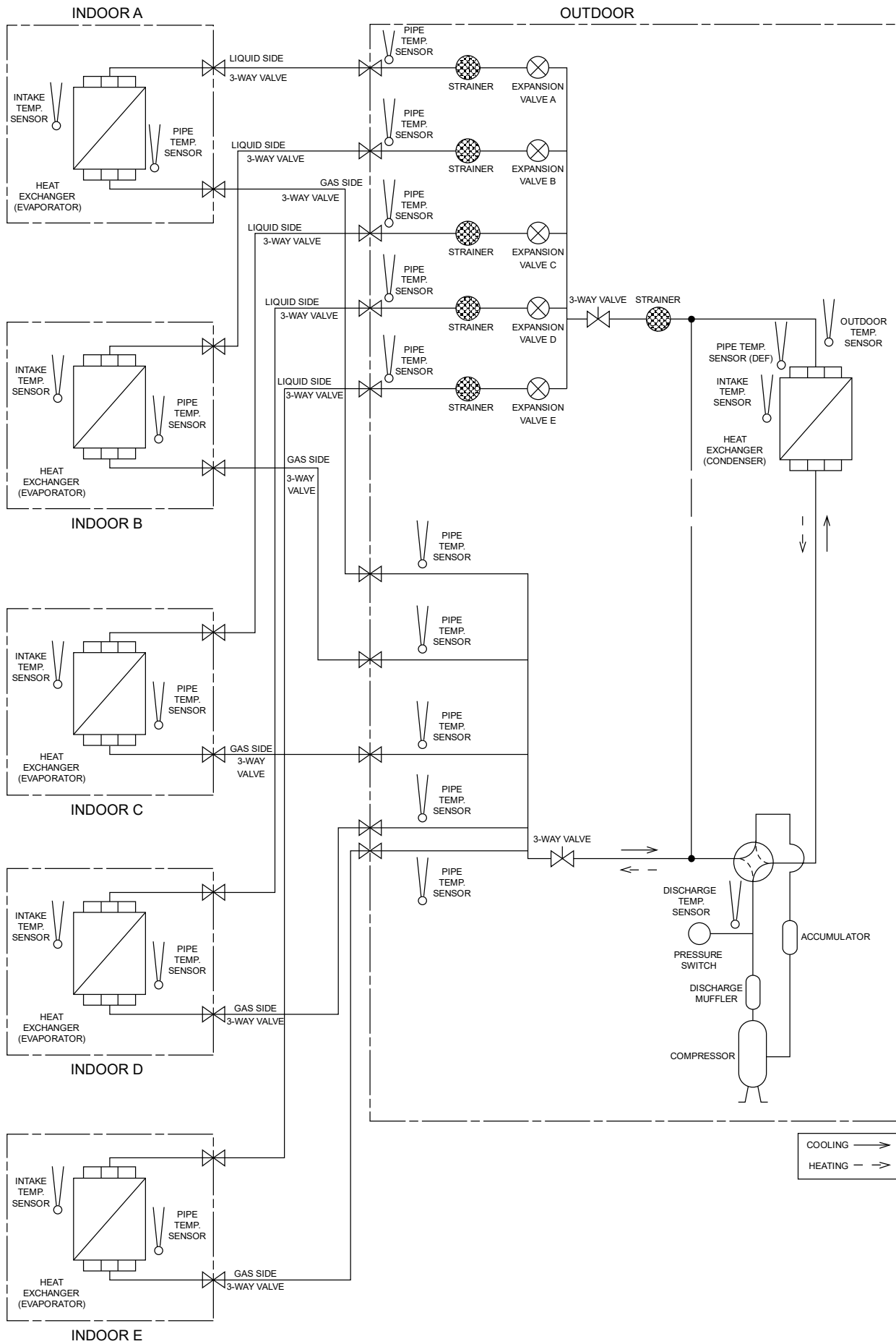

# 6. Block Diagram

## 6.1 CU-4Z80TBE

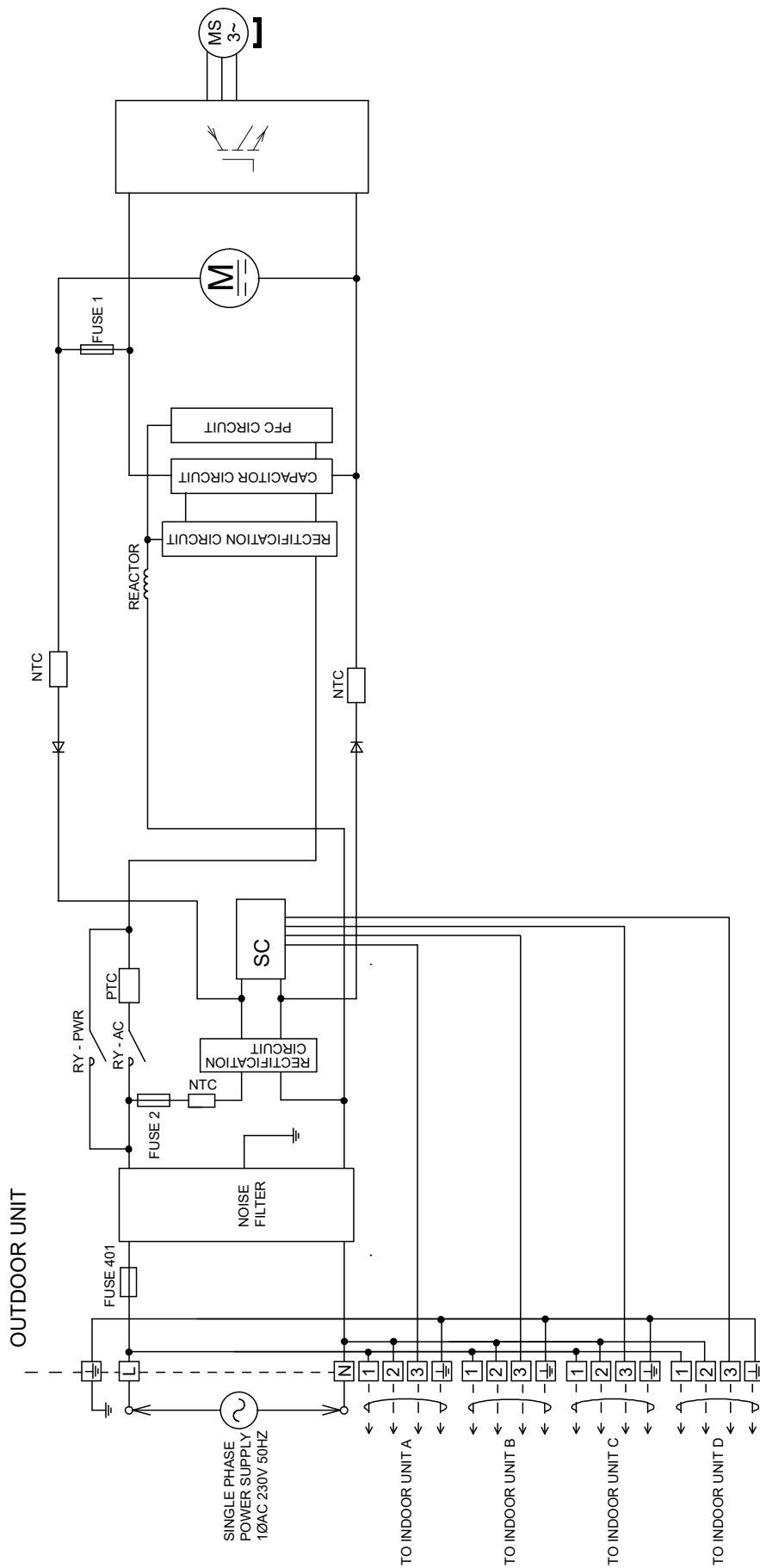

## 6.2 CU-5Z90TBE

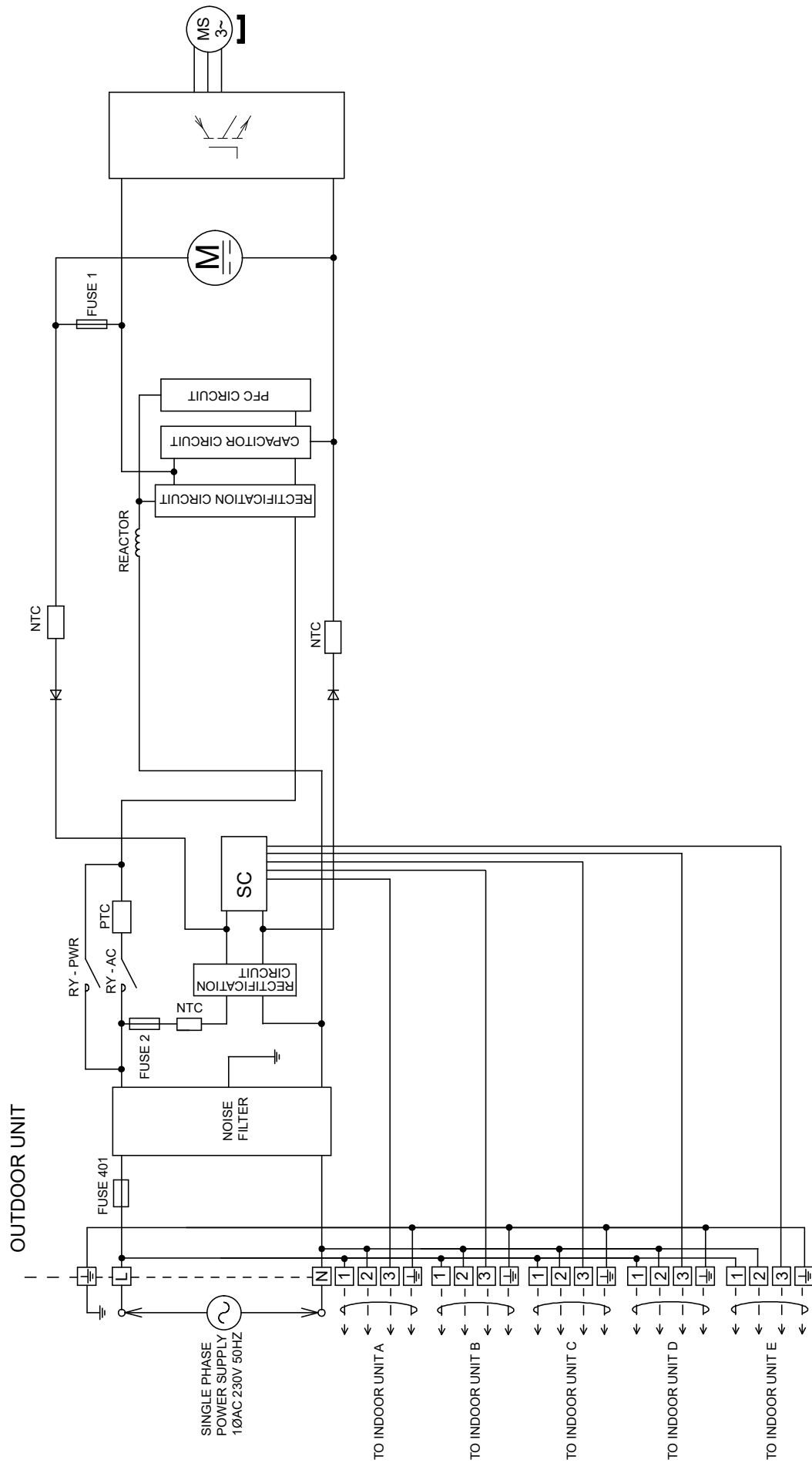



# 7. Wiring Connection Diagram

## 7.1 CU-4Z80TBE

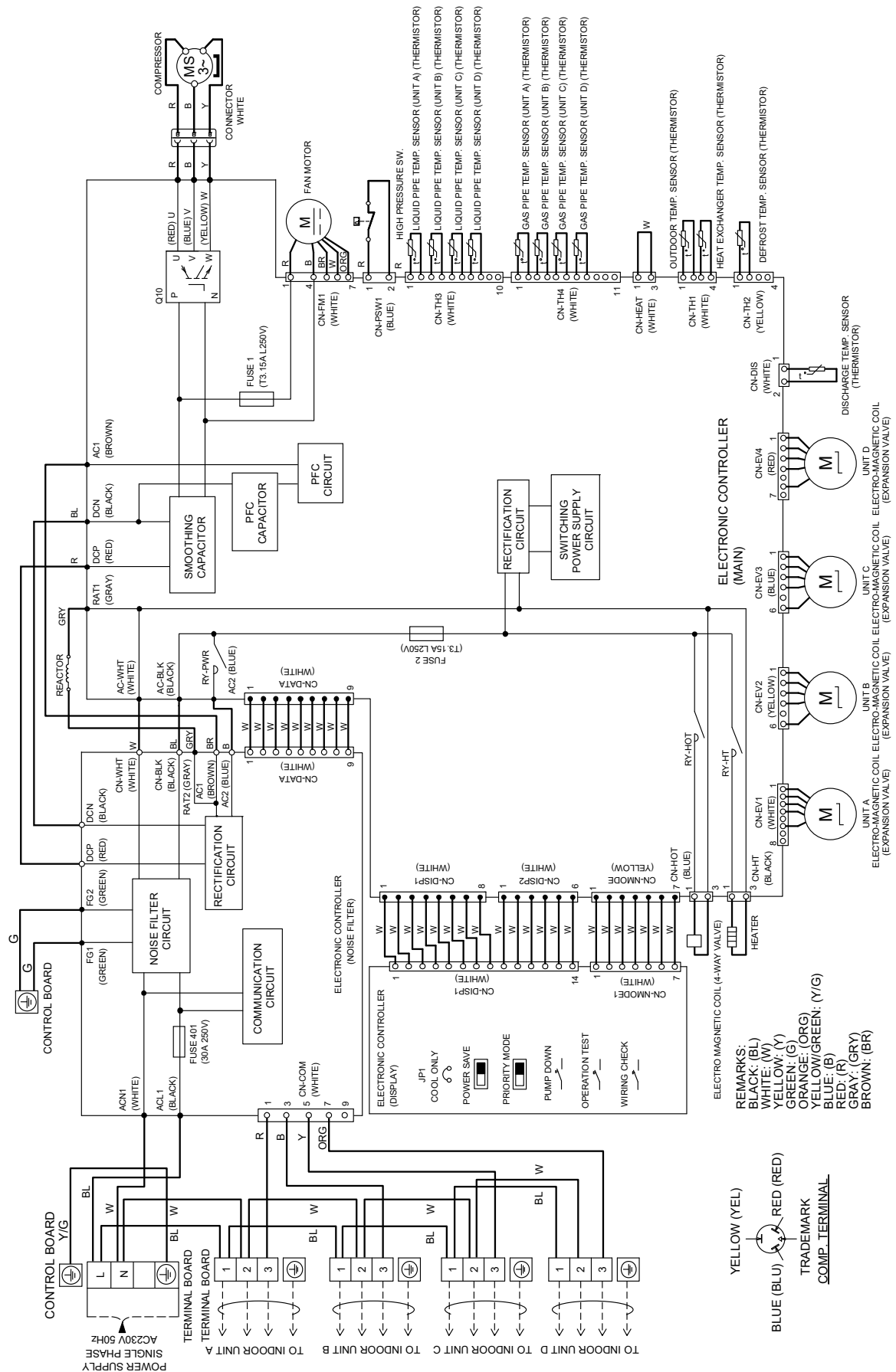

# 7.2 CU-5Z90TBE

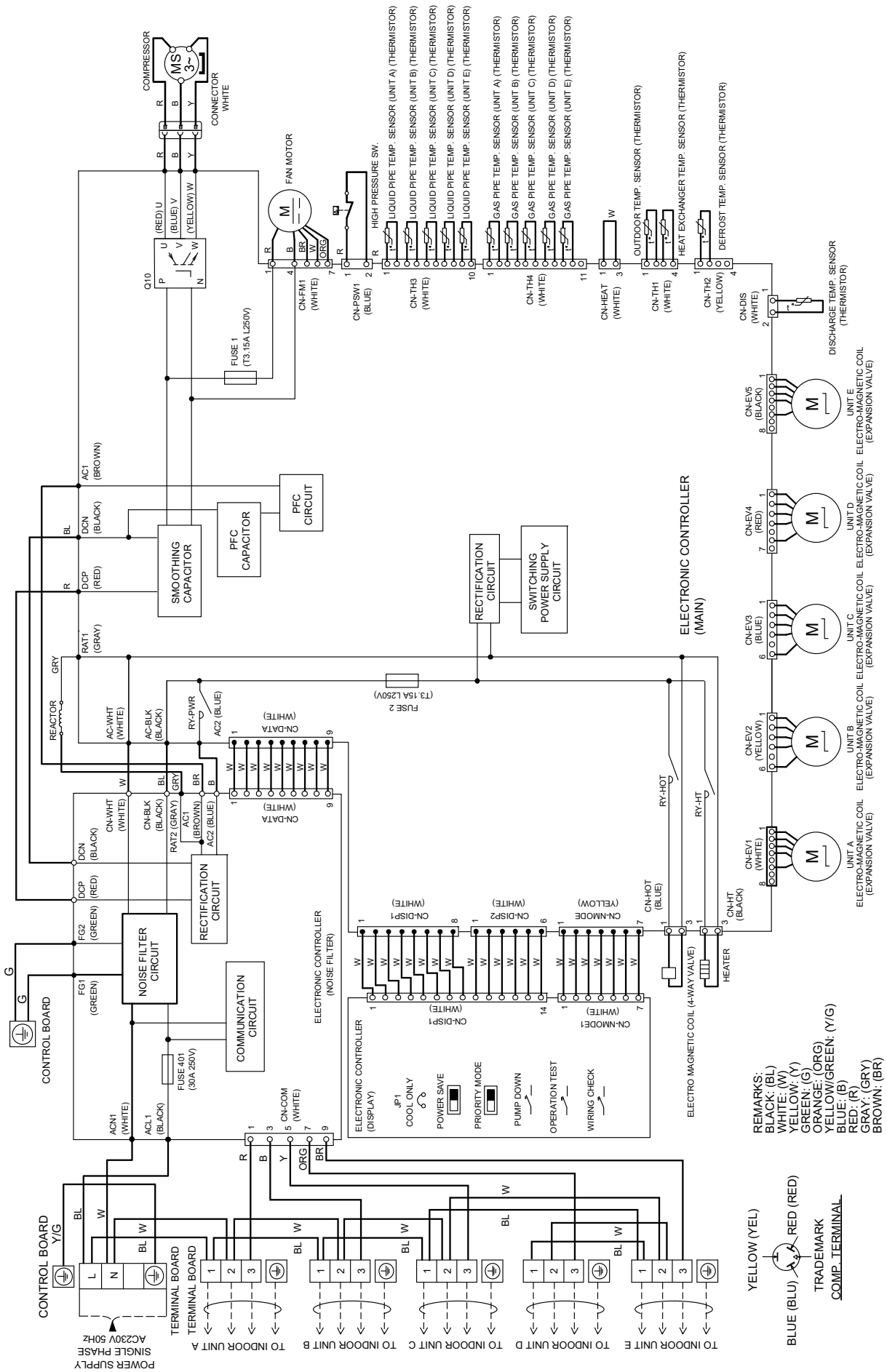

# 8. Electronic Circuit Diagram

## 8.1 CU-4Z80TBE

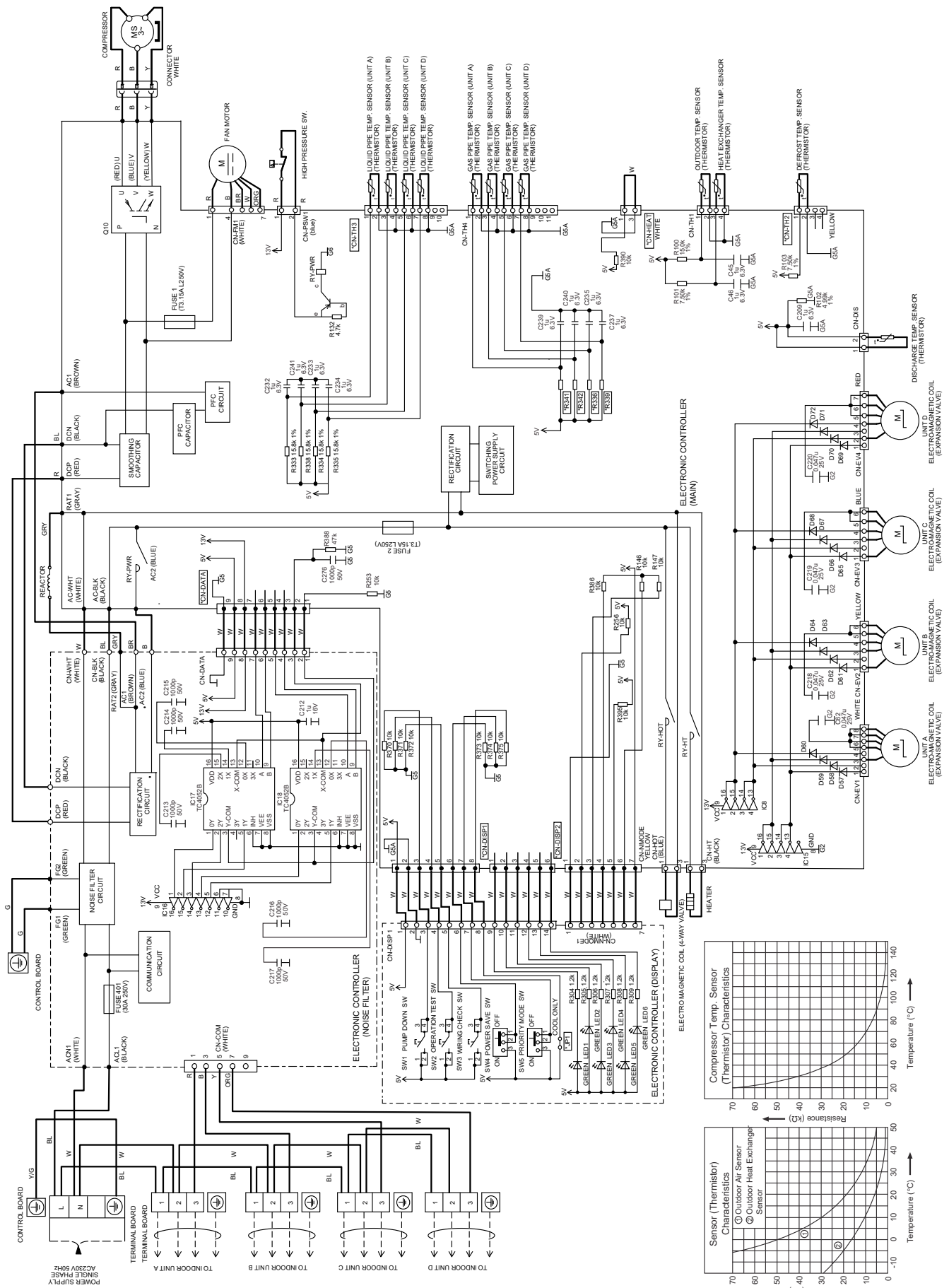

# 8.2 CU-5Z90TBE

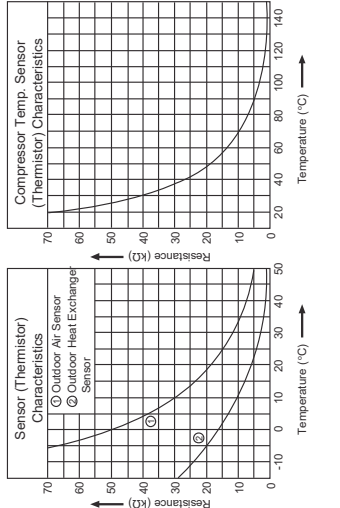
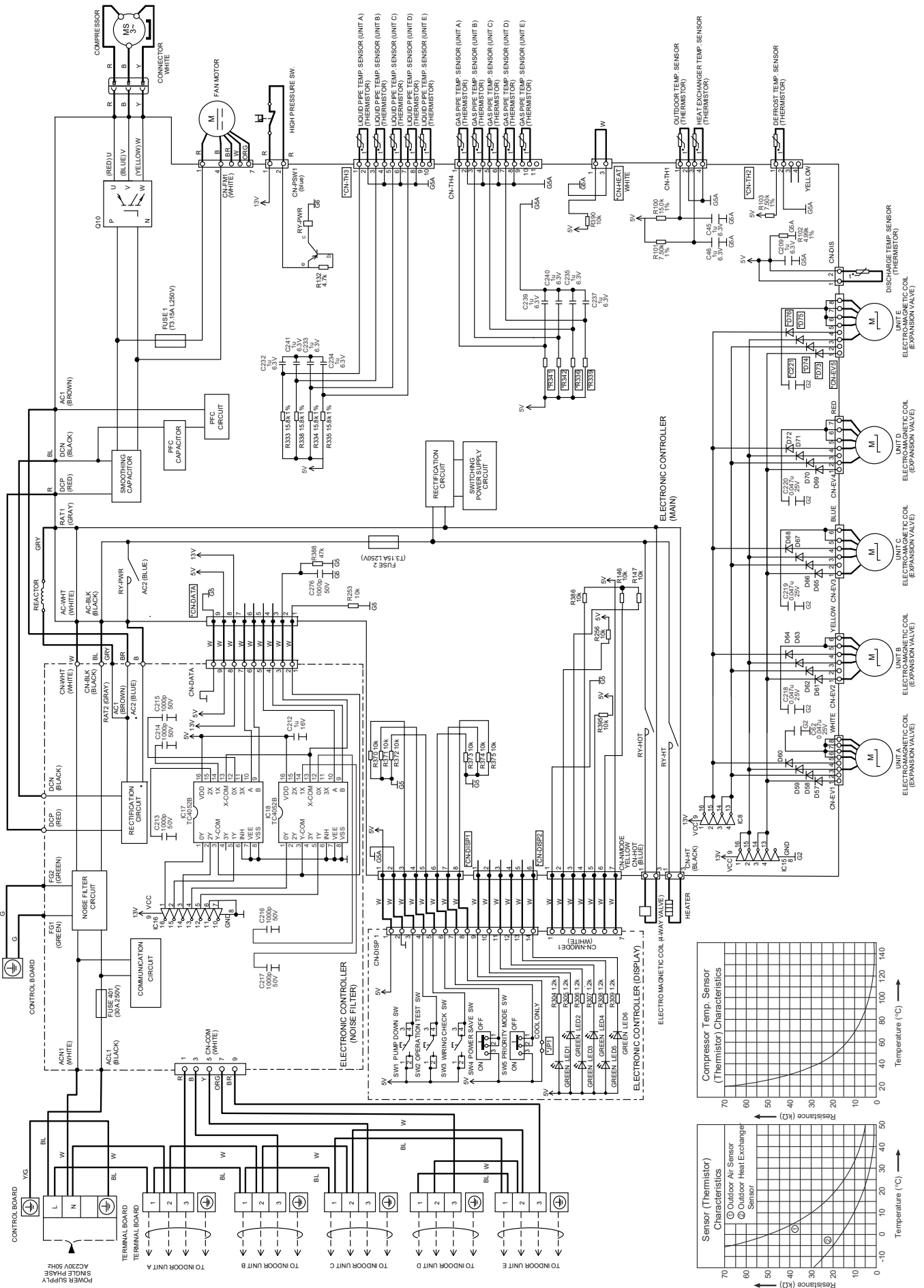

# 9. Printed Circuit Board

## 9.1 Main Printed Circuit Board

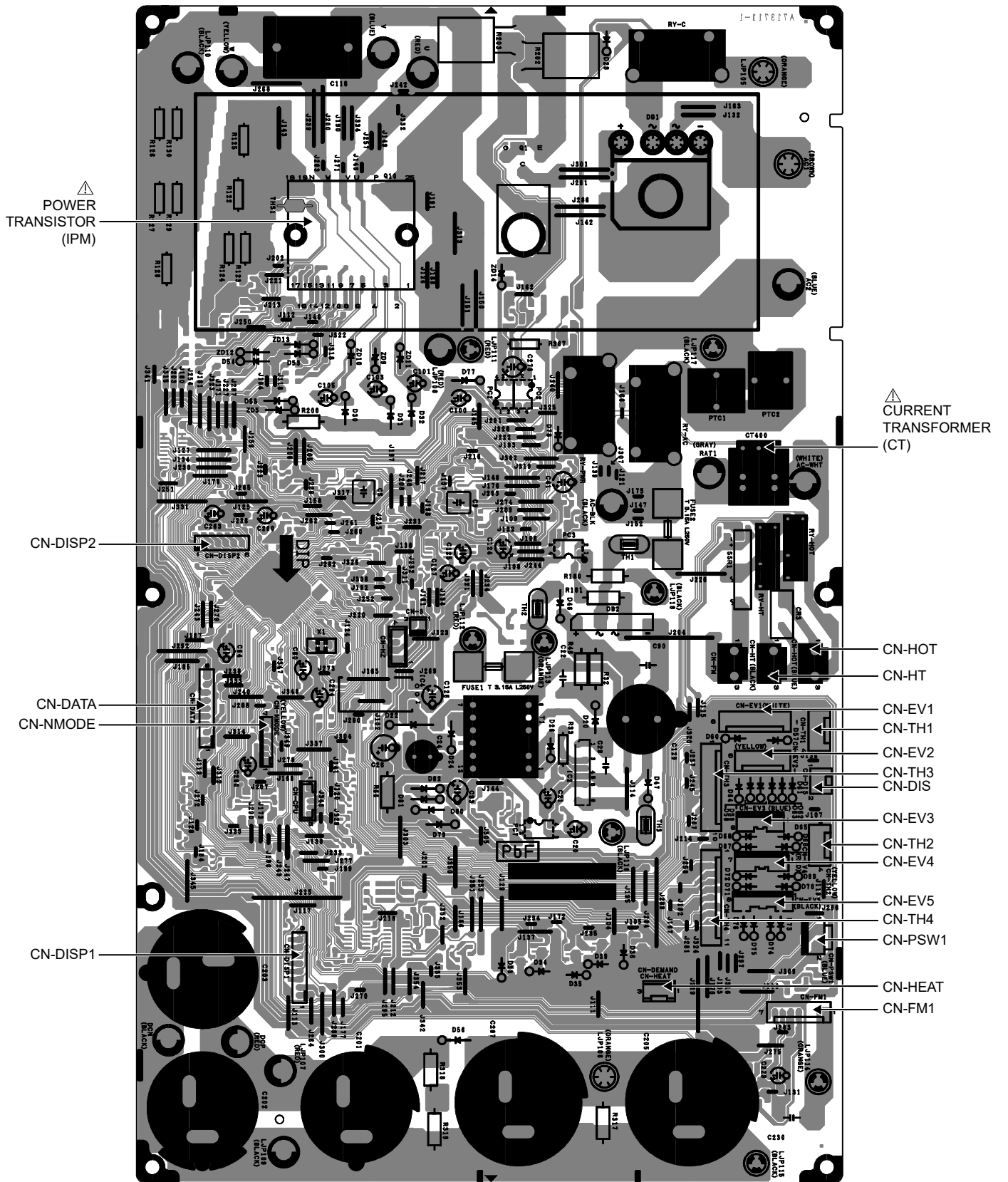

## 9.2 Noise Filter Printed Circuit Board

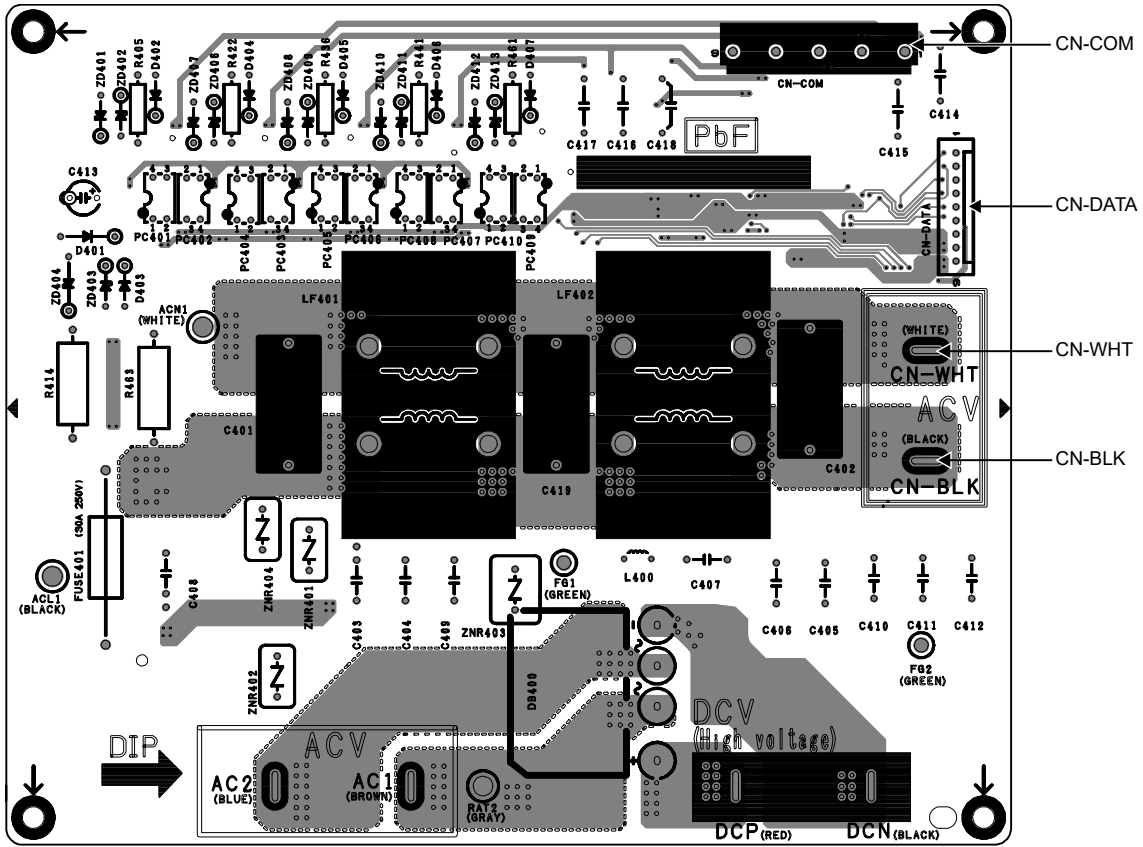

## 9.3 Display Printed Circuit Board

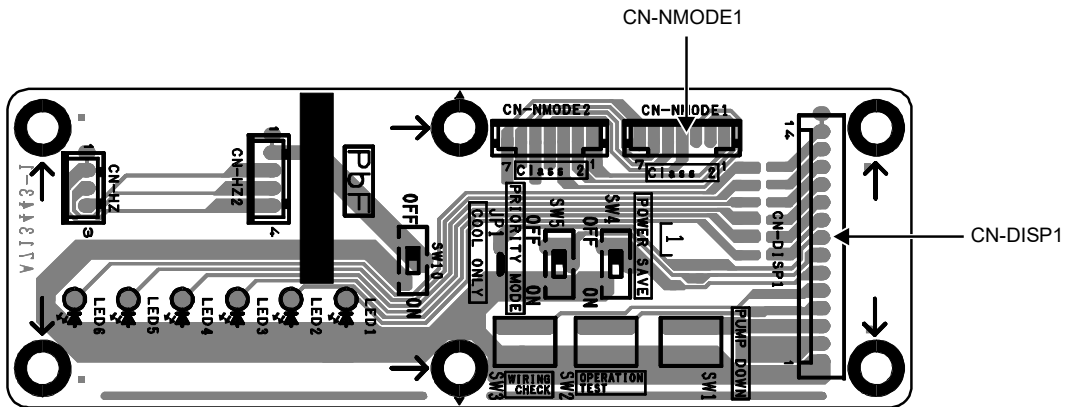

# 10. Installation Information

## 10.1 CU-4Z80TBE

### 10.1.1 Check Points

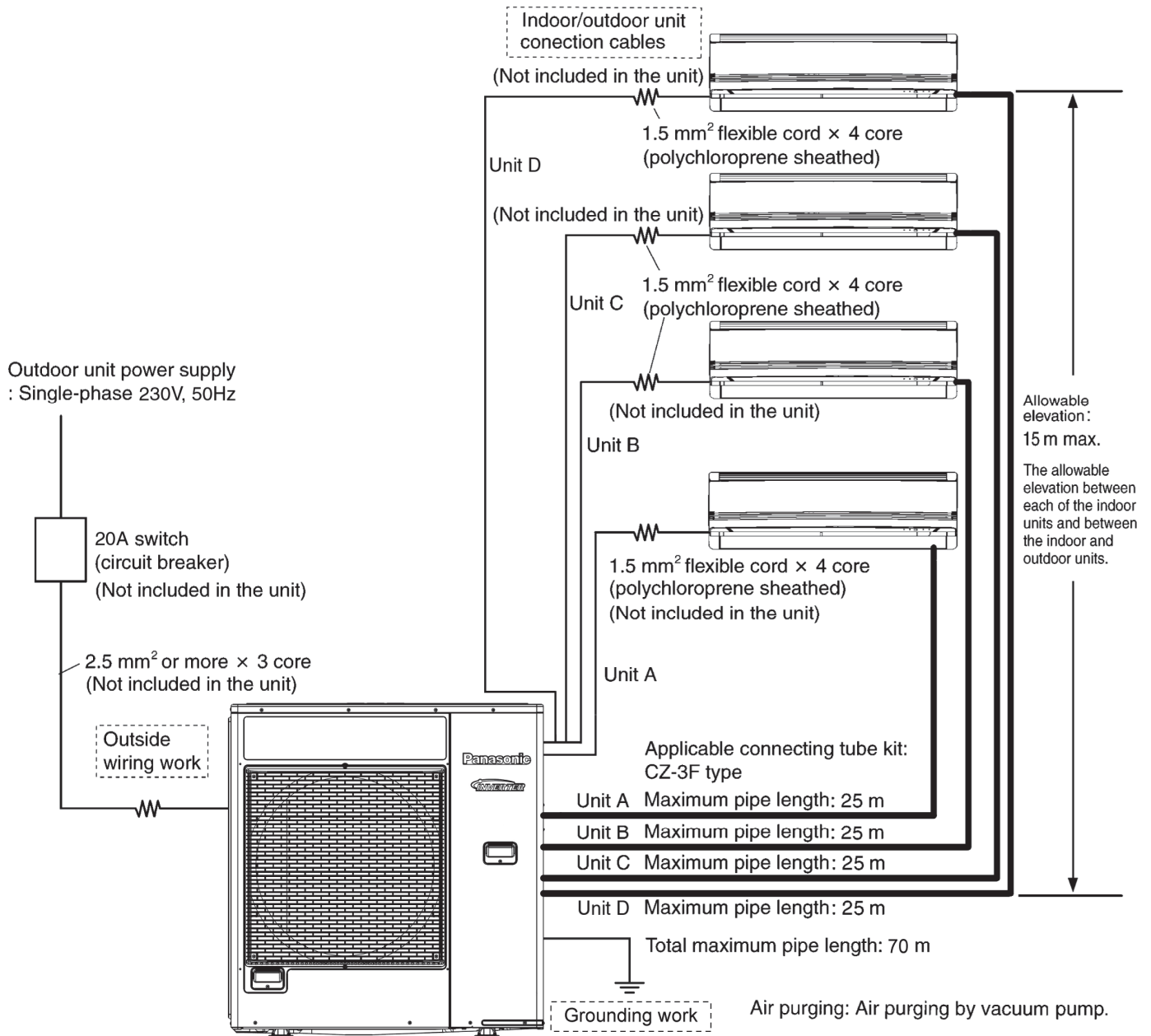

# 10.2 CU-5Z90TBE

## 10.2.1 Check Points

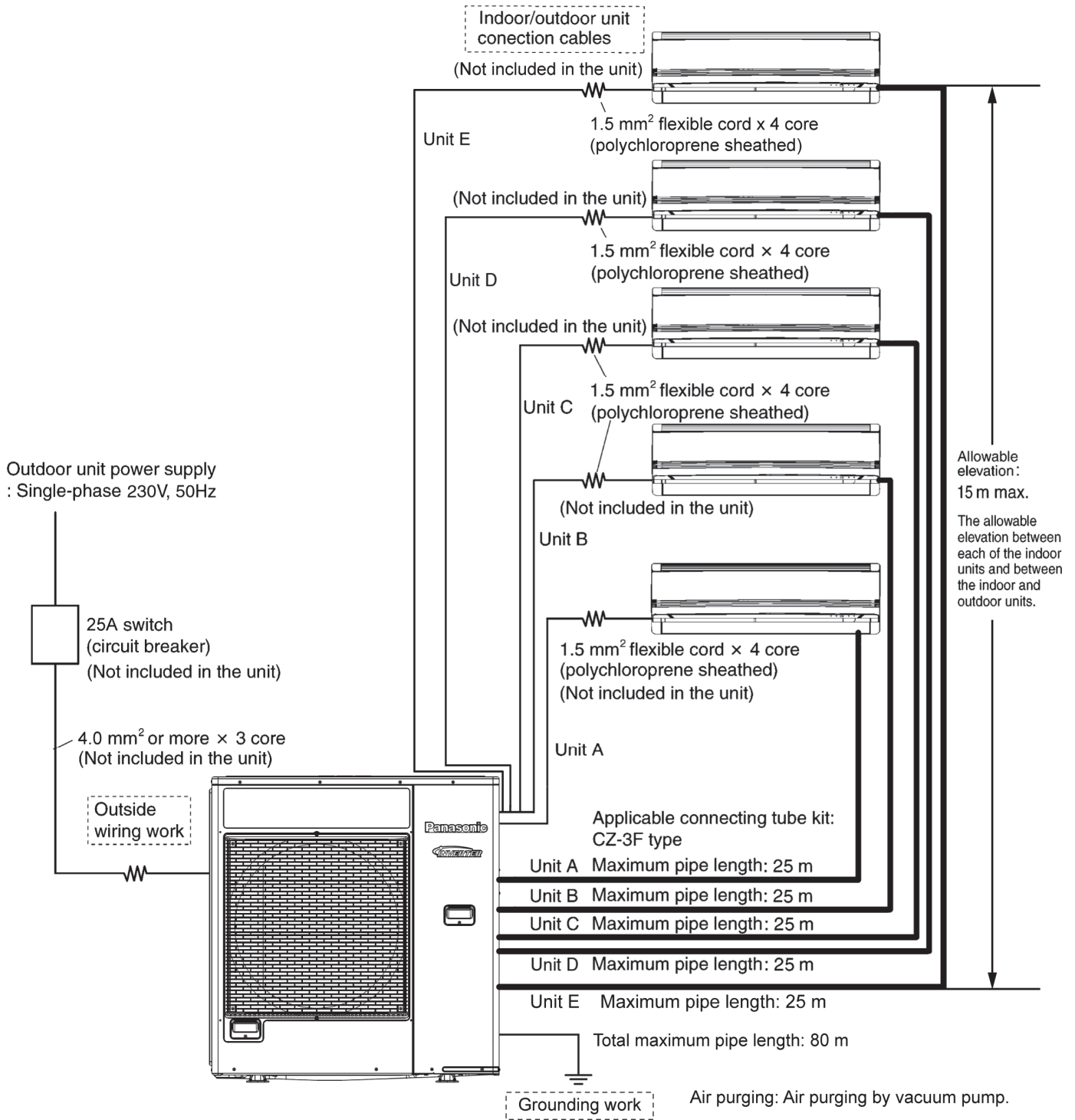



# 11. Installation Instruction

## 11.1 Select The Best Location

### 11.1.1 Outdoor Unit

- If an awning is built over the unit to prevent direct sunlight or rain, be careful that heat radiation from the condenser is not obstructed.
- There should not be any animal or plant which could be affected by hot air discharged.
- Keep the spaces indicated by arrows from wall, ceiling, fence or other obstacles.
- Do not place any obstacles which may cause a short circuit of the discharged air.

Refrigerant piping size		
Outdoor Unit	CU-4Z80***	CU-5Z90***
Liquid - side	ø 6.35 t0.8	ø 6.35 t0.8
Gas - side	ø 9.52 t0.8 *(ø 12.7 t0.8)	ø 9.52 t0.8 *(ø 12.7 t0.8)

\*In case of indoor is CS-Z71\*\*\*, CS-TZ71\*\*\*, CS-TZ60\*\*\*, CS-TE60\*\*\*, CS-E21\*\*\*, then ø 12.7 t0.8 gas-pipe size must be used together with CZ-MA2P (pipe size expander)

Table A

MODEL	Maximum Total Piping Length for Add. Gas (m)	Additional Refrigerant (g/m)	Wall Mounted Indoor A <sub>min</sub> (m <sup>2</sup> )	Mini Cassette Indoor A <sub>min</sub> (m <sup>2</sup> )	Ducted Indoor A <sub>min</sub> (m <sup>2</sup> )
CU-4Z80***	45	20	9.89	6.62	6.62
CU-5Z90***	45	20	11.15	7.46	7.46

- If total piping length of all indoor units exceed the maximum total length listed above, additionally charge with 20 g of refrigerant (R32) for each additional meter of piping.

$$A_{\min} = (M / (2.5 \times (LFL)^{(5/4)} \times h_0))^2$$

A<sub>min</sub> = Required minimum room area, in m<sup>2</sup>

M = Required charge amount in appliance, in kg

LFL = Lower flammable limit (0.306 kg/m<sup>3</sup>)

h<sub>0</sub> = Installation height of the appliance (1.8 m for Wall Mounted, 2.2 m for Mini Cassette & Ducted).

Allowable piping length				
Outdoor Unit			CU-4Z80***	CU-5Z90***
Allowable piping length of each indoor unit (min. ~ max.)			3 m ~ 25 m	3 m ~ 25 m
Allowable total piping length of all indoor unit			70 m or less	80 m or less
Height difference between indoor and outdoor unit	Outdoor unit located on upper side	Ⓐ	15 m or less	15 m or less
	Outdoor unit located otherwise	Ⓑ	7.5 m or less	7.5 m or less
Height difference between indoor unit	Outdoor unit located on upper side	Ⓒ	7.5 m or less	7.5 m or less
	Outdoor unit located otherwise	Ⓓ	15 m or less	15 m or less

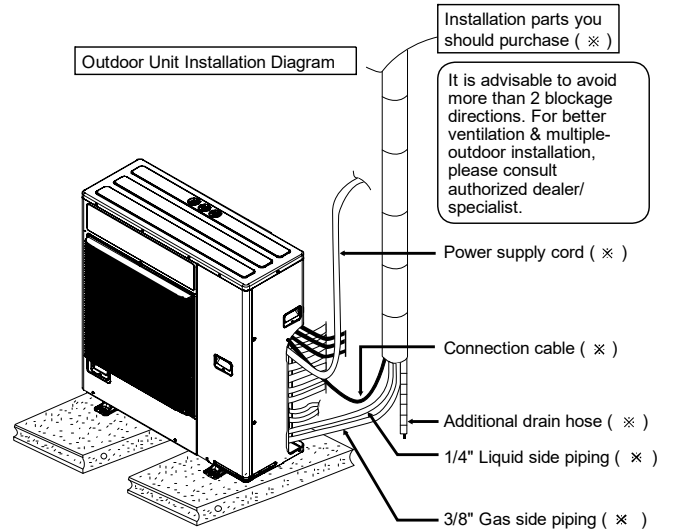

- This illustration is for explanation purposes only.

\* Note:  
Respective indoor unit installation procedure shall refer to instruction manual provided in the indoor unit packaging.

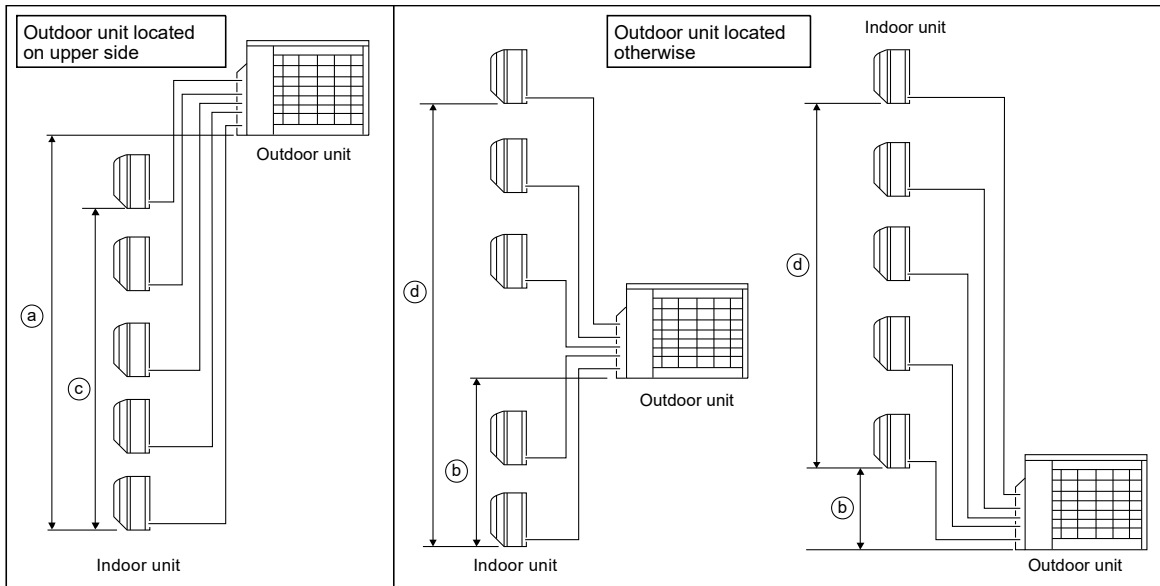

### Outdoor Unit Installation Guidelines

- Where a wall or other obstacle is in the path of outdoor unit's intake or exhaust airflow, follow the installation guidelines below.
- For any of the below installation patterns, the wall height on the exhaust side should be 1200 mm or less.

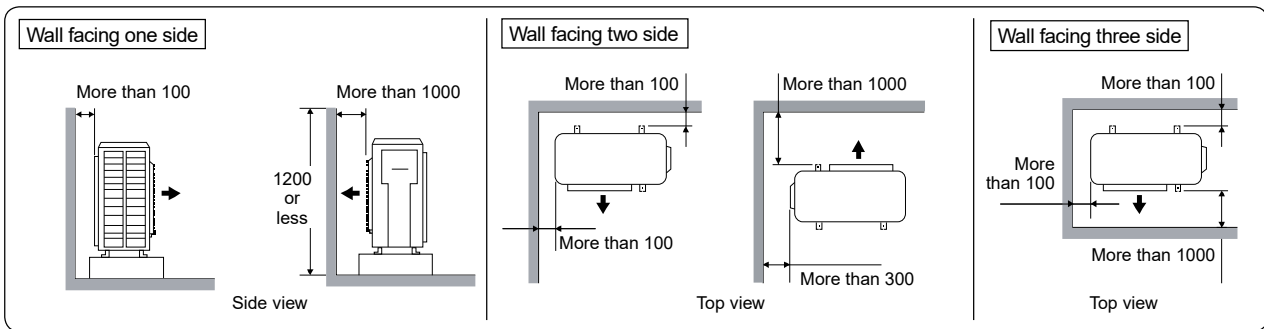

Unit : mm

## 11.2 Install The Outdoor Unit

- After selecting the best location, start installation to Indoor/Outdoor Unit Installation Diagram.
  1. Fix the unit on concrete or rigid frame firmly and horizontally by bolt nut ( $\phi 10$  mm).
  2. When installing at roof, please consider strong wind and earthquake. Please fasten the installation stand firmly with bolt or nails.

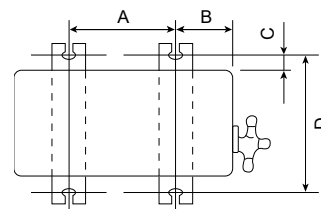

Model	A	B	C	D
CU-4Z80***, CU-5Z90***	620 mm	170 mm	20 mm	380.5 mm

## 11.3 Connect The Piping

- Remove the cabinet side plate (metal) from the unit by loosening six screws.

### Connecting The Piping To Outdoor Unit

Decide piping length and then cut by using pipe cutter. Remove burrs from cut edge. Make flare after inserting the flare nut (locate at valve) onto the copper pipe.

Align center of piping to valves and then tighten with torque wrench to the specified torque as stated in the table.

Do not over tighten, over tightening may cause gas leakage	
Piping size	Torque
1/4" [6.35 mm]	[18N•m (1.8 kgf.m)]
3/8" [9.52 mm]	[42 N•m (4.3 kgf.m)]
1/2" [12.7 mm]	[55 N•m (5.6 kgf.m)]
5/8" [15.88 mm]	[65 N•m (6.6 kgf.m)]
3/4" [19.05 mm]	[100N•m (10.2 kgf.m)]

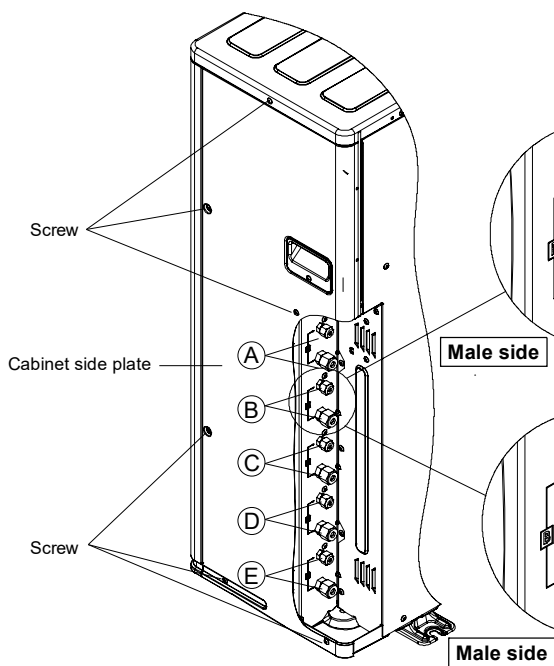

**Female side**

Applicable to  
 Liquid and Gas side of  
 CS-MZ16\*\*\*, CS-TZ25\*\*\*,  
 CS-MTZ16\*\*\*, CS-TZ35\*\*\*,  
 CS-Z20\*\*\*, CS-TZ42\*\*\*,  
 CS-Z25\*\*\*, CS-TZ50\*\*\*,  
 CS-Z35\*\*\*, CS-TE20\*\*\*,  
 CS-Z42\*\*\*, CS-TE25\*\*\*,  
 CS-Z50\*\*\*, CS-TE35\*\*\*,  
 CS-XZ20\*\*\*, CS-TE42\*\*\*,  
 CS-XZ25\*\*\*, CS-TE50\*\*\*,  
 CS-XZ35\*\*\*, CS-E9\*\*\*,  
 CS-XZ50\*\*\*, CS-E12\*\*\*,  
 CS-TZ20\*\*\*, CS-E18\*\*\*

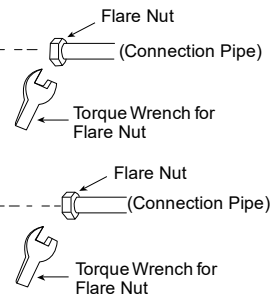

Liquid side of  
 CS-Z71\*\*\*, CS-TZ71\*\*\*,  
 CS-TZ60\*\*\*, CS-TE60\*\*\*,  
 CS-E21\*\*\*

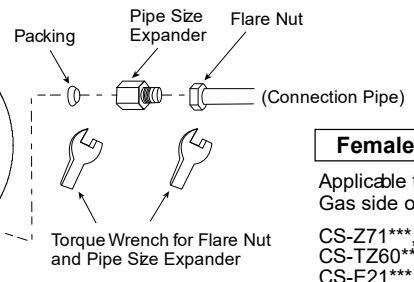

**Female side**

Applicable to  
 Gas side of  
 CS-Z71\*\*\*, CS-TZ71\*\*\*,  
 CS-TZ60\*\*\*, CS-TE60\*\*\*,  
 CS-E21\*\*\*

## 11.4 Air Tightness Test on the Refrigerating System

Before system charged with refrigerant and before the refrigerating system is put into operation, below site test procedure and acceptance criteria shall be verified by the certified technicians, and/or the installer:-

Step 1: Pressure test for refrigerant leak detection:

- 1) Steps for pressure test, in accordance to ISO 5149.
- 2) Evacuate the system from refrigerant before the leak test, attach the gauge manifold set correctly and tightly. Charging hose of Low side connect to Gas side. (Charging hose of High side connect to Liquid side if applicable.)
- 3) Adjust the knob on the service valves, and regulator on the gauge set, so that test gas can be inserted through the centre manifold of the gauge set.
- 4) Insert Nitrogen gas into the system through the centre manifold and wait until the pressure within the system to reach about 1 MPa (10 BarG) wait for a few hours and monitor the pressure reading on the gauges.
- 5) Please note that the system's pressure may rise slightly if the test is carried out on mid day, due to temperature rise. The inverse may happen when there is temperature drop at night. However, this variation will be minimal.
- 6) Waiting time depends on the size of the system. Larger systems may require 12 hours of waiting time. Leak detection within smaller system can be achieved in 4 hours.
- 7) Check if there is a constant pressure drop. Move to next step "Step 2: Refrigerant leak detection..." if there is any pressure drop. Otherwise, release the Nitrogen gas and, move to "Step 3: Evacuation of the equipment".
- 8) Next, insert a small amount of same refrigerant into the system through the centre hose, until the pressure reaches about 1 MPa (10BarG).

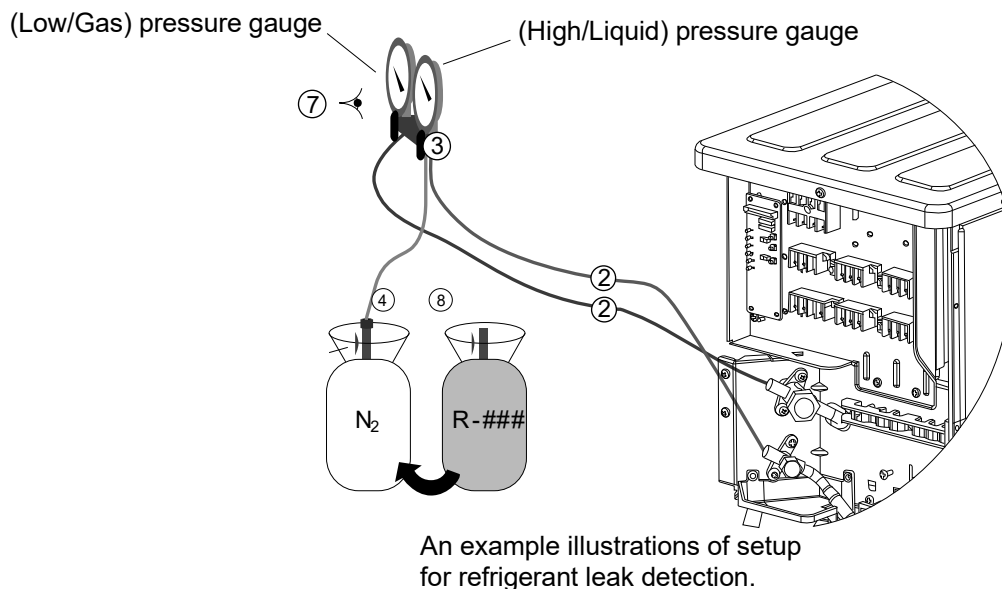

Step 2: Refrigerant leak detection through Electronic halogen leak detector and/or ultrasonic leak detector:

- 1) Use any one of below detector to check leaking.
  - i. Electronic halogen leak detector.
    - i-a) Switch on the unit.
    - i-b) Cover the test area from direct draft.
    - i-c) Pass the detection probe near test area and wait for audible and visible signals.
  - ii. Ultrasonic Leak Detector.
    - ii-a) Make sure the area is quiet.
    - ii-b) Switch on the ultrasonic leak detector.
    - ii-c) Move the probe along your air conditioning system to test for leaks, and mark for repair.
- 2) Any leak detected at this level shall be repaired and retested, starting from "Step 1: Pressure test".

NOTE:

- Always recover the refrigerant and Nitrogen gas into recovery cylinder after completion of a test.
- You must use the detection equipment with Detectable Leak Rate of  $10^{-6}$  Pa.  $m^3/s$  or better.
- Do not use refrigerant as test medium for system with total refrigerant charge more than 5 kg.
- Test shall be performed with dry Nitrogen or another non-flammable, non-reactive, dried gas. Oxygen, air or mixtures containing them shall not be used.

**Step 3: Air Evacuation of the equipment:**

	Do not purge the air with refrigerants but use a vacuum pump to vacuum the installation.
	There is no extra refrigerant in the outdoor unit for air purging.

1. Connect a charging hose with a push pin to the Low side of a charging set and the service port of the gas side 3-way valve.
  - Be sure to connect the end of the charging hose with the push pin to the service port.
2. Connect the center hose of the charging set to a vacuum pump.
3. Turn on the power switch of the vacuum pump and make sure that the needle in the gauge moves from 0 cmHg (0 MPa) to -76 cmHg (-0.1 MPa). Then evacuate the air approximately ten minutes.
4. Close the Low side valve of the charging set and turn off the vacuum pump. Make sure that the needle in the gauge does not move after approximately five minutes.
 

Note : BE SURE TO TAKE THIS PROCEDURE IN ORDER TO AVOID REFRIGERANT GAS LEAKAGE.
5. Disconnect the charging hose from the vacuum pump and from the service port of the 3-way valve.
6. Tighten the service port caps of gas side 3-way valve at a torque of 18 N•m with a torque wrench.
7. Remove the valve caps of both of the gas side and liquid side 3-way valve. Position both of the valves to “OPEN” using a hexagonal wrench (4 mm).
8. Mount valve caps onto the gas side and liquid side of the 3-way valve.
  - Be sure to check for gas leakages.

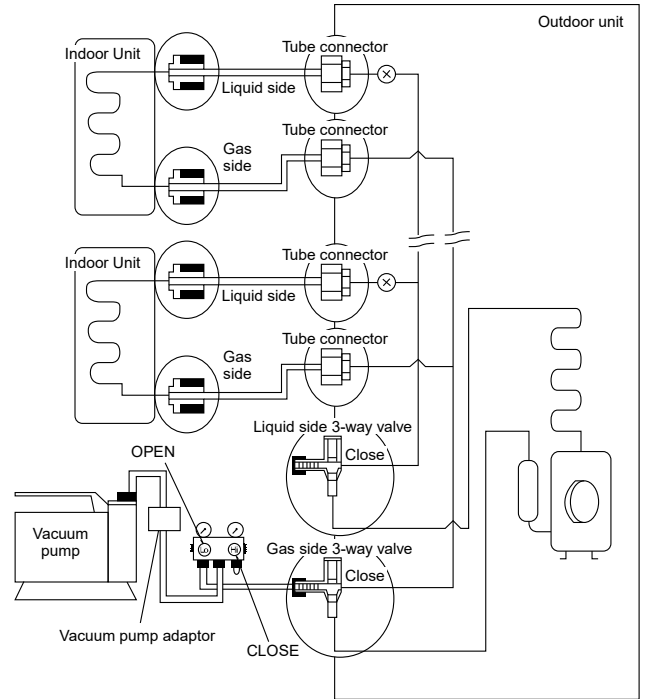

	<b>CAUTION</b>
<ul style="list-style-type: none"> <li>• If gauge needle does not move from 0 cmHg (0 MPa) to -76 cmHg (-0.1 MPa), in step ③ above take the following measure:</li> <li>- If the leak stops when the piping connections are tightened further, continue working from step ③.</li> <li>- If the leak does not stop when the connections are retightened, repair location of leak.</li> <li>- Do not release refrigerant during piping work for installation and reinstallation.</li> <li>- Take care of the liquid refrigerant, it may cause frostbite.</li> </ul>	

**11.5 Connect The Cable To The Outdoor Unit**

1. Remove the particular plate from the unit by loosening two screws.
2. Cable connection to the power supply through isolating Devices (Disconnecting means).
  - Connect approved type polychloroprene sheathed **power supply cord** CU-4Z80\*\*\* (3 x 2.5 mm<sup>2</sup>), CU-5Z90\*\*\* (3 x 4.0 mm<sup>2</sup>) 60245 IEC 57 type designation or heavier cord to the terminal board, and connect the others end of the cord to Isolating Devices (Disconnecting means).
3. **Connection cable** between indoor unit and outdoor unit shall be approved polychloroprene sheathed 4 x 1.5 mm<sup>2</sup> flexible cord, type designation 60245 IEC 57 or heavier cord. Allowable connection cable

- length of each indoor unit shall be 30 m or less.
4. Connect the power supply cord and connection cable between indoor unit and outdoor unit according to the diagram as shown.

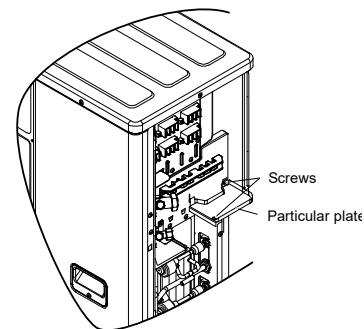

**CU-4Z80\*\*\***

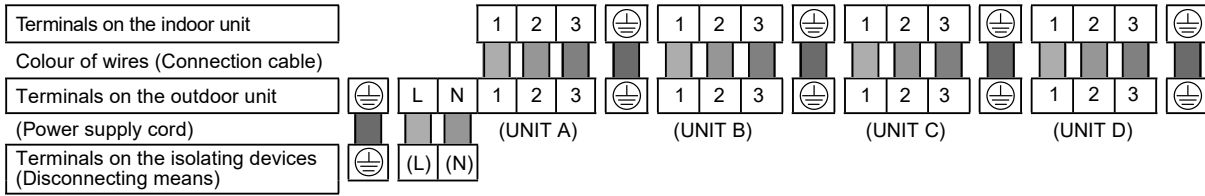

**CU-5Z90\*\*\***

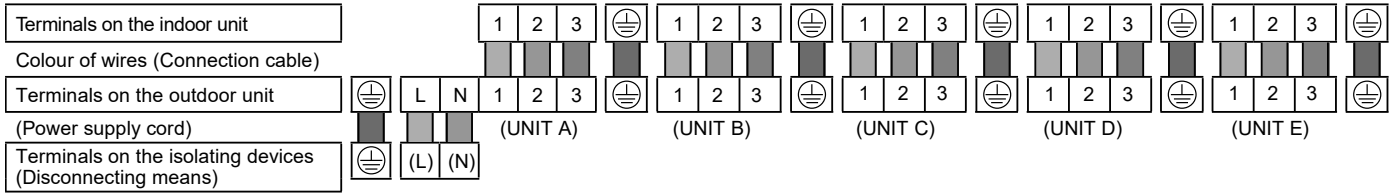

**Remarks:**

It is the responsibility of the installer or user of the equipment to ensure, by consultation with the suitable distribution/supply network operator if necessary, that the equipment should be connected only to a supply with,

- Short-circuit power  $S_{sc} \geq 2750\text{kW}$
- Service current capacity  $\geq 100\text{A}$  per phase

The equipment complies with IEC/EN 61000-3-11 and IEC/EN 61000-3-12. Please liaise with supply authority to ensure that the above items at the interface point are sufficient for the installation of the equipment.

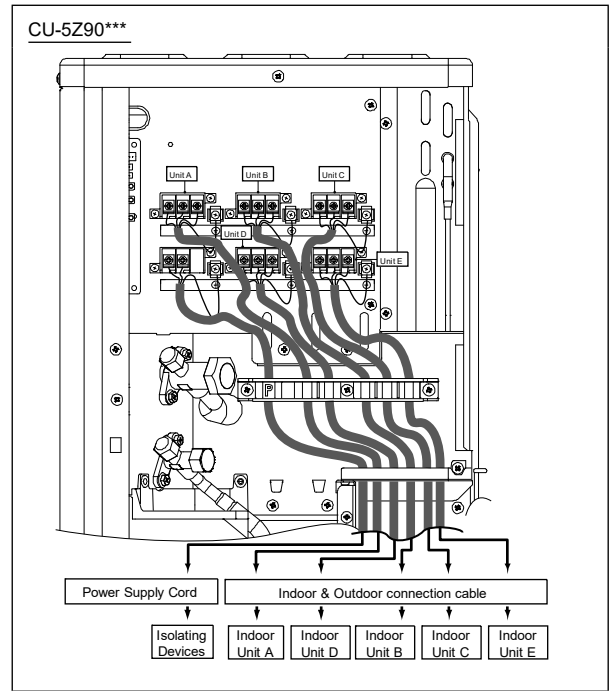
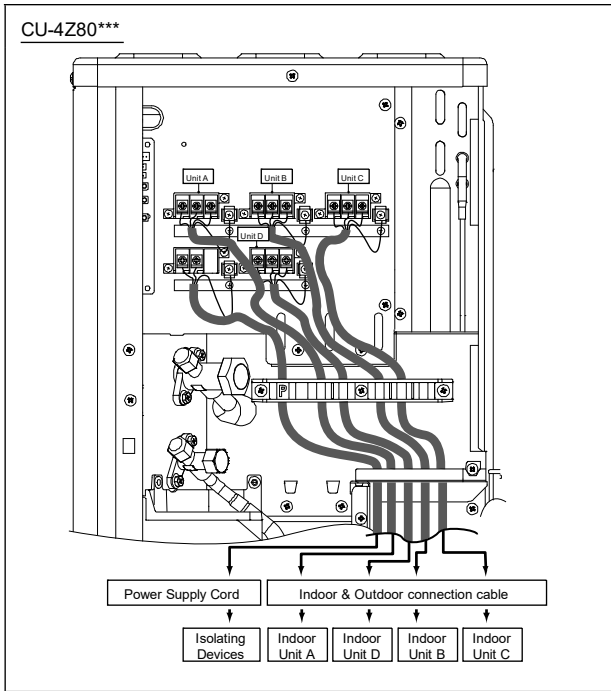

5. For wire stripping and connection requirement, refer to the diagram below.
6. Secure the power supply cord and connecting cables onto the control board with the holder.
7. Attach the control board cover back to the original position with screw.

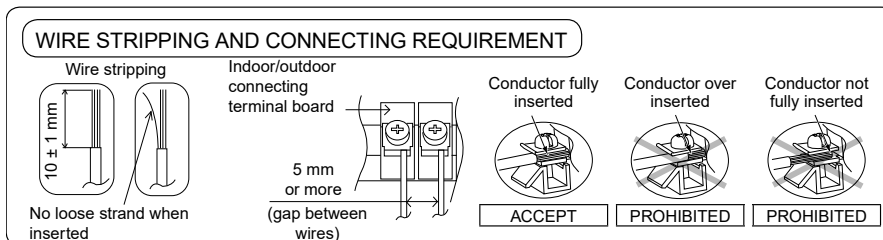



This equipment must be properly earthed.

- Note: Isolating Devices (Disconnecting means) should have minimum 3.0 mm contact gap.
- Earth wire shall be Yellow/Green (Y/G) in colour and longer than other AC wires for safety reason.

## 11.6 Heat Insulation

1. Please carry out insulation at pipe connection portion as mentioned in Indoor/Outdoor Unit Installation Diagram. Please wrap the insulated piping end to prevent water from going inside the piping.
2. If drain hose or connecting piping is in the room (where dew may form), please increase the insulation by using POLY-E FOAM with thickness 6 mm or above.

	Refrigerant tubing shall be protected against mechanical damage.
---	--

 <b>CAUTION</b>	Use a material with good heat-resistant properties as the heat insulation for the pipes. Be sure to insulate both the gas-side and liquid-side pipes. If the pipes are not adequately insulated, condensation or water leakages may occur.	Liquid-side pipes	Material shall withstand 120°C or higher
	Gas-side pipes		

### CUTTING AND FLARING THE PIPING

1. Please cut using pipe cutter and then remove the burrs.
2. Remove the burrs by using reamer. If burrs is not removed, gas leakage may be caused. Turn the piping end down to avoid the metal powder entering the pipe.
3. Please make flare after inserting the flare nut onto the copper pipes.

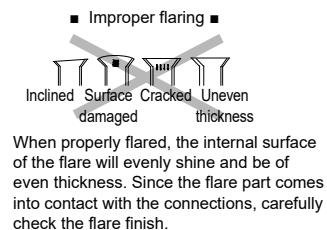
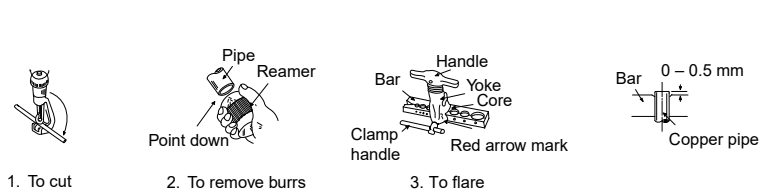

### 11.6.1 Disposal Of Outdoor Unit Drain Water

- If a drain elbow is used, the unit should be placed on a stand which is taller than 5 cm.
- If the unit is used in an area where temperature falls below 0°C for 2 or 3 days in succession, it is recommended not to use a drain elbow, for the drain water freezes and the fan will not rotate.

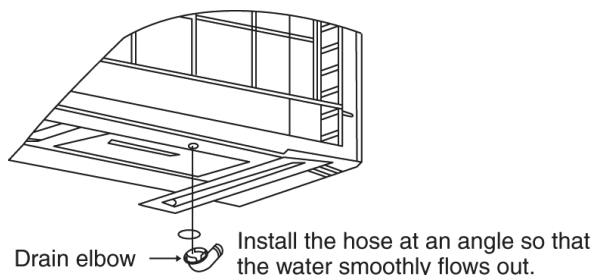

## 12. Operation Control

### 12.1 Cooling Operation

#### 12.1.1 Outdoor fan control

- When cooling operation is enabled, based on outdoor ambient temperature, fan motor control will be adjusted according to figure below:

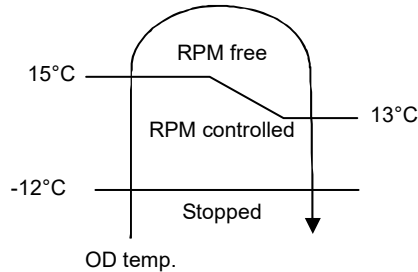

#### 12.1.2 Annual Cooling control

- This control is to enable cooling operation when outdoor ambient temperature is low.
- Control start conditions:
  - Cooling operation is activated with compressor ON.
  - Outdoor ambient temperature is less than 15°C.
- Control contents:
  - When the above conditions are fulfilled, based on outdoor pipe temperature, the outdoor fan motor will operate according to figure below:

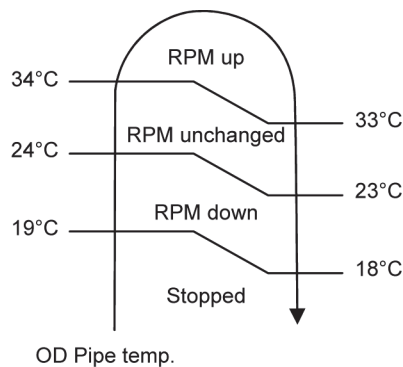

- To improve the judgment accuracy during annual cooling control, outdoor ambient temperature sampling for 2 minutes will be activated every 35 minutes under designated fan speed.
- Control stop conditions:
  - When either one of the start conditions are not complied.

#### 12.1.3 Cooling Powerful Operation 1

- During cooling operation, this control is to concentrate outdoor unit capability to the powerful operation enabled indoor unit by temporary stop the capability supply to low load demand indoor units.
- Operation start condition:
  - Powerful operation ON for targeted indoor unit
- Operation content:
  - If other indoor units (where Powerful operation are OFF) achieve setting temperature continuously for 1 minute after received powerful command from indoor unit, then capability supply to other indoor units are stopped for minimum 3 minutes.  
Capability supply stop period follows powerful operation period.
- Operation stops when comply either one of the following conditions:
  - When other indoor units (where Powerful operation are OFF) is demand for capacity.
  - When the powerful operation is OFF for all indoor units.
  - When Quiet operation received from 1 indoor unit.
  - When protection control starts.



### 12.1.4 Outdoor Quiet Cooling Operation Control

- Purpose  
Provide quiet cooling operation when only 1 indoor in operation.
- Start Condition
  - Indoor fan speed is lower than Lo fan.
  - Only 1 operation indoor unit.
  - Not in any cooling overload zone.
  - Not during annual cooling
  - Not initial frequency operation.
  - Not during starting control.
  - Not during “Electronic part temperature rise protection by outdoor air & total current”
  - Not during “Electronic part temperature rise protection by total current”
  - Not during “IPM temperature rise prevention control”
  - During cool mode

All conditions above are satisfied and function selection enable.
- Control Contents  
Compressor frequency and outdoor fan speed maximum limit is set. Adjust accordingly.

	Compressor frequency	Outdoor fan speed
Cool/Quiet	#27 Hz	#400 rpm

- Cancel Condition
  - Indoor fan speed is equal or higher than Lo fan.
  - > 1 operation indoor unit.
  - In any cooling overload zone.
  - During annual cooling
  - Initial frequency operation.
  - During starting control.
  - During “Electronic part temperature rise protection by outdoor air & total current”
  - During “Electronic part temperature rise protection by total current”
  - During “IPM temperature rise prevention control”
  - Not during cool mode

When any above is satisfied

## 12.2 Heating Operation

### 12.2.1 Outdoor fan control

- When heating operation is enabled, based on outdoor ambient temperature, fan motor control will be adjusted according to figure below for Heating overload control:

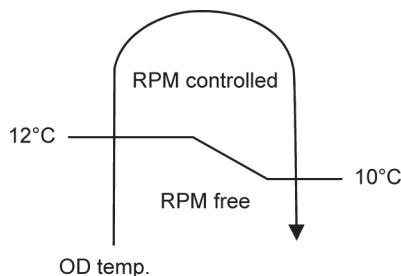

### 12.2.2 Heating Room Temp Sampling Control

- To improve the judgment accuracy, indoor room temperature sampling starts when any indoor unit has stopped capability supplied (heating thermo-off) during heating operation with compressor ON, outdoor unit will send signal to all thermo-off indoor units to ON fan motor and get room temperature sample.
- To prevent discharge temperature drop at indoor units which is ON when sampling the room temperature of heating thermo-off units, the compressor frequency is increased accordingly.
- However, if indoor room temperature is much higher compare to remote control setting temperature, before thermo-off, sampling of corresponding indoor unit will be cancelled.

### 12.2.3 Powerful Operation 2

- During cooling / heating operation, this control is to provide fast cooling / heating operation compare to normal operation.
- Operation start if all condition below are complied:
  - Powerful operation ON for indoor unit.
  - Not under Annual Cooling control.
- Operation content:
  - Outdoor fan speed will adjust automatically.
  - Compressor frequency will adjust automatically.
- Operation stop when comply either one of the follow conditions:
  - When the powerful operation is OFF for all indoor units.
  - When annual cooling control activated.

### 13. Simultaneous Operation Control

- Operation modes which can be selected using the remote control unit:
  - Automatic, Cooling, Dry, Heating and nanoe operation mode.
- Types of operation modes which can be performed simultaneously
  - Cooling operation and Cooling, Dry or nanoe operation.
  - Heating operation and Heating operation.
- Types of operation modes which cannot be performed simultaneously
  - During cooling operation, heating operation is impossible at another indoor unit in another room.
  - The priority is given to cooling operation if the cooling mode is selected first. In another room where heating mode is selected afterward, the POWER LED blinks to indicate the heating operation is in standby condition, where the fan is stopped hence no discharged air.
  - During heating operation, cooling operation is impossible at another indoor unit in another room.
  - The priority is given to heating operation if the heating mode is selected first. In another room where cooling mode is selected afterward, the POWER LED blinks to indicate the cooling operation is in standby condition, where the fan is stopped hence no discharged air.
- Operation mode priority control
  - The operation mode designated first by the indoor unit has priority.
  - If the priority indoor unit stops operation or initiates the fan operation, the priority is transferred to other indoor units.

“Waiting” denotes the standby status in which the POWER LED blinks (ON for 2.5 seconds and OFF for 0.5 seconds) and the fan is stopped.

		ROOM A	Non Priority Unit (2 <sup>nd</sup> ON)			
			Cooling	Dry	Heating	nanoe
Priority Unit (1 <sup>st</sup> ON)	Cooling	C	D	Waiting	E	
	Dry	C	C	C	C	
		C	D	Waiting	E	
	Heating	D	D	D	D	
		Waiting	Waiting	H	Stop	
e-ion	H	H	H	H		
	C	D	H	E		
	E	E	Stop	E		

In the e-ion mode, priority is transferred to a non-priority unit.

Note

- C: Cooling operation mode
- D: Dry operation mode
- H: Heating operation mode
- E: nanoe operation mode

## 14. Protection Control

### 14.1 Freeze Prevention control (Cool)

- When received freeze prevention signal from indoor unit, the compressor frequency changes according to indoor heat exchanger temperature.
- When indoor unit request capability OFF due to freeze condition, immediately the capability supply to targeted indoor unit stops.

### 14.2 Dew Prevention control (Cool)

- When received dew prevention signal from indoor unit, which according to indoor intake temperature and indoor heat exchanger temperature the compressor frequency changes.

### 14.3 Electronic Parts Temperature Rise Protection 1 (Cool)

- This control prevents electronic parts temperature rise during cooling overload condition.
- Start conditions:
  - Outdoor ambient temperature is at protection region as shown in figure below:

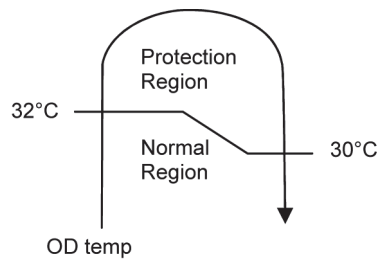

- Outdoor unit total current is above 7.1A.
- Control content
  - Outdoor fan speed is adjusted accordingly.
- Control stop condition
  - When outdoor ambient temperature is back to normal region.
- During this control, outdoor fan speed does not reduce for Quiet operation.

### 14.4 Electronic Parts Temperature Rise Protection 2 (Cool)

- This control prevents electronic parts temperature rise during cooling/dry operation.
- Start conditions:
  - Total current is at protection region as shown in figure below:

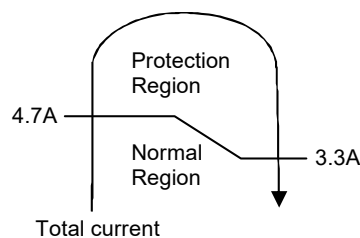

- Control content
  - Outdoor fan speed is adjusted accordingly.
- Control stop conditions
  - When total current is back to normal region.
- During this control, outdoor fan speed does not reduce for Quiet operation.

### 14.5 Cooling overload control (Cool)

- This control detect outdoor pipe temperature and perform the compressor frequency restriction during cooling operation.

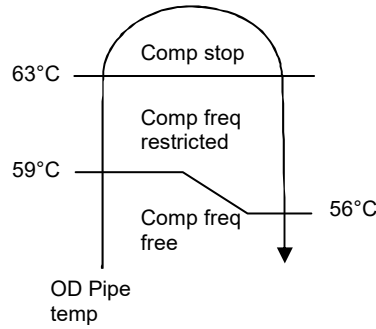

### 14.6 Heating overload control (Heat)

- This control detect indoor pipe temperature and perform the compressor frequency restriction during heating operation.

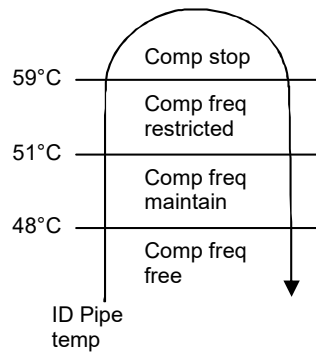

- This control detect outdoor ambient temperature and perform the fan speed adjustment during heating operation.

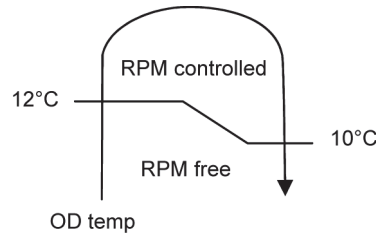

### 14.7 Extreme Low Temperature Compressor low pressure protection control (Heat)

- This control is to prevent low pressure drops too low during extremely low outdoor ambient temperature to improve the compressor reliability.
- During heating operation, when outdoor ambient temperature is in Zone 1, this control will be activated. Compressor frequency restriction will be based on outdoor piping temperature.

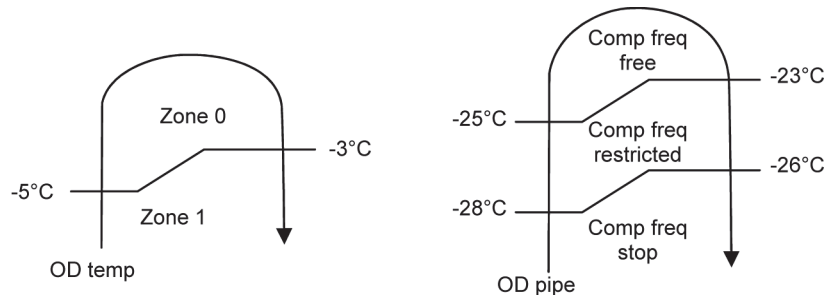

## 14.8 Deice Control

- When outdoor pipe temperature and outdoor air temperature is low, deice operation starts where indoor fan motor and outdoor fan motor stop, indoor unit horizontal vane close and operation LED blink with compressor ON.

## 14.9 Time Delay Safety Control (Restart Control)

- The compressor will not restart within three minutes after compressor is stopped.
- This control is not applicable if the power supply reset or after deice condition.

## 14.10 30 seconds Force Operation

- Once the compressor starts operation, it will not stop its operation for 30 seconds in order to cycle back compressor oil.
- However, it can be stopped using remote control or Auto OFF/ON button at indoor unit.

## 14.11 Total Current Control

- By referring to table below, during normal (default) operation, the running current refer to Hi values and during Power Save Mode, the running current refer to Lo values.
- When the outdoor unit total running current (AC) exceeds X value, compressor frequency will decrease.
- If the running current does not exceed X value for 5 seconds, compressor frequency will increase.
- However, if total outdoor unit running current exceeds Y value, compressor will be stopped immediately for 3 minutes.

Current Table

Model		CU-4Z80TBE		CU-5Z90TBE	
		Hi	Lo	Hi	Lo
Cool (X)	A	18.10 A	12.65 A	19.45 A	13.58 A
	B	17.38 A	12.65 A	17.38 A	13.58 A
	C	15.08 A		15.08 A	
Heat (X)		18.10 A	12.65 A	18.46 A	14.05 A
Y		23.06 A		23.06 A	

Current Control

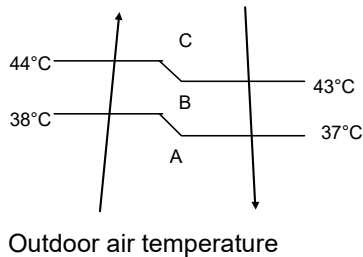

## 14.12 IPM (power transistor) Protection Control

- Overheating Prevention Control
  - If IPM temperature rises to 80°C, outdoor fan speed will be increased.
  - When the IPM temperature rises to 95°C, compressor operation will stop immediately.
  - Compressor operation restarts when temperature decreases to 90°C.
  - If IPM temperature detected less than -30°C, IPM is judged as open circuit ("F96" is indicated).
- DC peak current control
  - When IPMDC current exceeds set value of 30.0 ± 3.0 A, the compressor will stop.
  - If the DC peak current detected within 30 seconds after operation starts, compressor will restart after 1 minute.
  - If the DC peak current detected 30 seconds or more after operation starts, compressor will restart after 2 minutes.
  - Within 30 seconds after compressor restarts, if the DC peak current is exceeded set value continuously for 7 times, all indoor and outdoor relays will be cut off ("F99" is indicated).
- Error reset can be done by power supply reset.

### **14.13 Compressor Protection Control (Gas leak detection control 1)**

- Control start conditions
  - For 5 minutes (cool & dry), 8 minutes (heating), the compressor continuously operates and total current is low.
  - During Cooling or Soft Dry operation:  
Indoor intake temperature — indoor piping temperature is below 4°C.
  - During Heating operation:  
Indoor pipe temperature — indoor intake temperature is below 3°C.
  - Not during deice control.
  - Compressor ON with maximum frequency.
- Control content
  - Compressor stops (and restart after 3 minutes)
  - If the conditions above happen 4 times within 60 minutes, the unit will stop operation (“F91” is indicated).

### **14.14 Compressor Protection Control (Gas leak detection control 2)**

- This control detect gas leakage condition to prevent compressor damage.
- Control start condition
  - All connected indoor units capability supply ON.
  - Compressor ON with maximum frequency.
  - Not during annual cooling.
  - Compressor discharge temperature high.
- Control content
  - Compressor OFF during this control (“F91” is memorized in EEPROM)
  - If the above conditions happen 2 times within 60 minutes, indoor units’ Timer LED will blinks (“F91” is indicated at all indoor units)

### **14.15 Valve close detection control**

- This control detects 3-way valve close condition to prevent damage to refrigerant cycle.
- Start conditions:
  - For all connected indoor units, if Indoor intake temperature — indoor piping temperature are between -2°C and 2°C continuously for 5 minutes after compressor ON at first cooling operation.
  - The first cooling operation is defined as cooling operation is ON for less than 8 minutes after new installation or after pump down.
- Control content
  - During this control, compressor stop, indoor units’ Timer LED will blink. (“F91” is indicated at indoor units)
- Error reset can be done by power supply reset or reset by using remote control.

### **14.16 Compressor discharge high pressure protection control**

- This control protect by using high pressure switch during operation.
- Start conditions
  - High pressure switch is activated (from normally close to open) when outdoor operation mode is cooling or heating during compressor running.
- Control 1 content
  - Compressor stop when high pressure switch is opened and restart after high pressure switch closed. If this condition happen 4 times within 30 minutes, “F94” is indicated.
  - After 30 minutes, counter is reset if this condition does not happen for 4 times.
- Control 1 stop conditions
  - Power supply reset
  - Reset by using remote control

### 14.17 Compressor discharge high temperature protection control

This control detect compressor tank temperature (CU-4Z80/5Z90TBE) and perform the compressor frequency restriction.

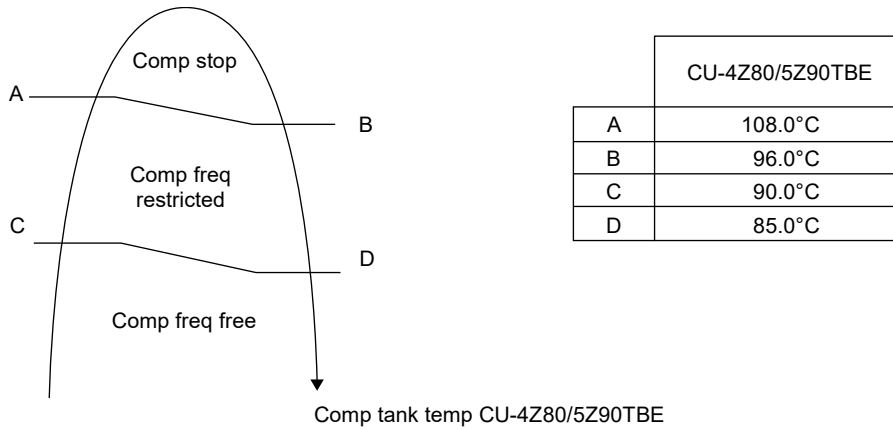

When the discharge temperature more than 108°C, the compressor stops. If this conditions happens for 3 times within 30 minutes, "F97" is indicated.

### 14.18 Cooling Outdoor Air Temperature Control (Cool)

- The compressor will be stopped to avoid compressor overloading.

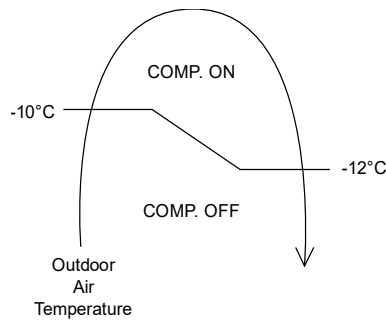

### 14.19 Heating Outdoor Air Temperature Control (Heat)

- The compressor will be stopped to avoid compressor overloading.

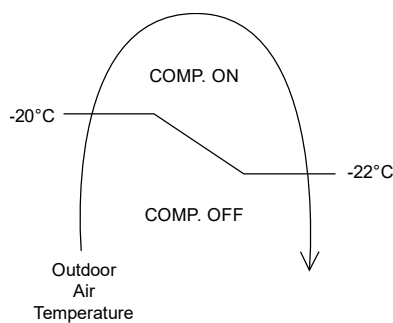



# 15. Servicing Mode

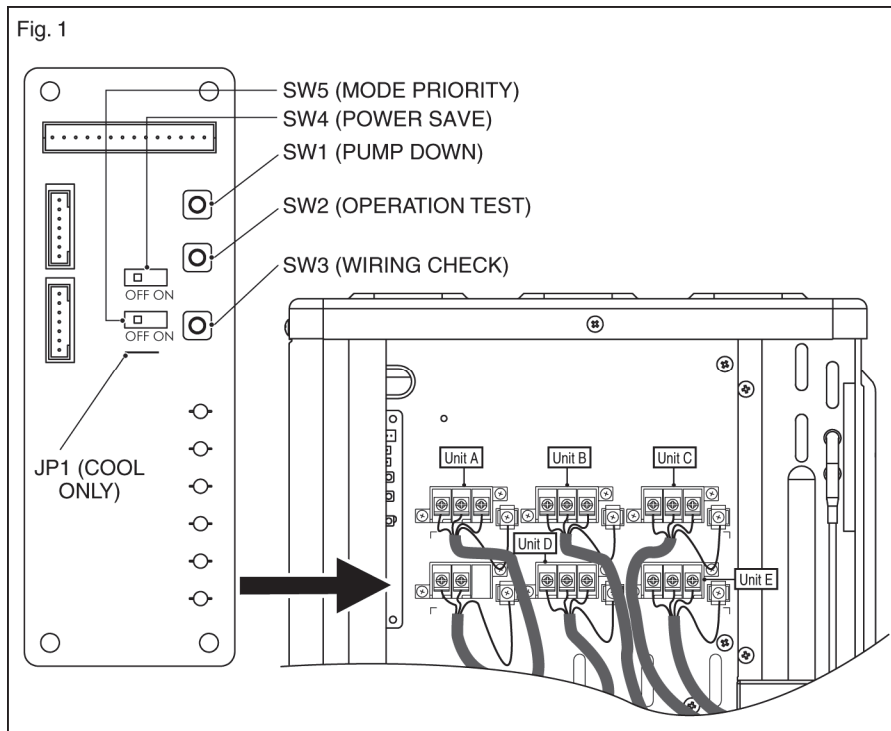

## 15.1.1 Pump down operation (SW1)

- Operate the pump down process according to the following procedure.
  - Confirm the valve on the liquid side and gas side are open.
  - Press PUMP DOWN button (SW1) on the Service PCB inside the outdoor unit for more than 5 seconds. Pump down (cooling) operation is performed for 15 minutes.
  - Set the liquid side 3 way valve to close position and wait until the pressure gauge indicates 0.01MPa (0.1kg/cm<sup>2</sup>G).
  - Immediate set the gas side valve to close position and then press the PUMP DOWN button (SW1) to stop the pump down operation.

NOTE: Pump down operation will stop automatically after 15 minutes if PUMP DOWN switch (SW1) is not pressed again. Pump down operation is not started within 3 minutes after compressor is stopped.

LED	2	3	4	5	Message
Status	○	○	○	○	Pump down operation in progress
	○	○	○		3 minutes before operation end
	○	○			2 minutes before operation end
	○				1 minute before operation end
					Pump down operation end

○: Flashing

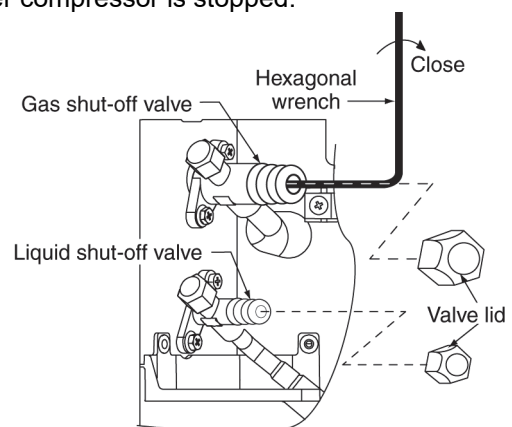

## 15.1.2 Test Run Operation

- Test operation can be carried out using TEST OPERATION button (SW2) on the Service PCB inside the outdoor unit.
- For Cooling test, press the TEST OPERATION button (SW2) for 5 seconds or more but less than 10 seconds, LED1 and LED 2 will illuminate when shift into cooling test operation.
- For Heating test, press the TEST OPERATION button (SW2) for more than 10 seconds, LED 1 and LED 3 will illuminate when shift into heating test operation.
- Press the TEST OPERATION button (SW2) again to cancel test operation.

### 15.1.3 Wiring Error Check

- The unit capable to correct the wiring error automatically by following procedures.
  - Confirm the valve on the liquid side and gas side is open.
  - Press WIRING CHECK button (SW3) on the Service PCB inside the outdoor unit for more than 10 seconds to start wiring check operation.
  - Wiring check process will complete in approximately 20 - 25 minutes. However, wiring check operation will not start within 3 minutes after compressor is stopped. When outdoor air temperature is less than 5°C or unit has abnormality, wiring check will not start. (See NOTE 2)
- The LED 2 to LED 6 in Service PCB inside the outdoor unit indicate the possibility of the correction as shown in the table below:

LED	2	3	4	5	6	Message
Room	A	B	C	D	E	
Status	All flashing					Automatic correction impossible
	LED2, 4, 6 and LED 3, 5 alternatively flashing					Wiring check in progress
	Flashing one after another					Automatic correction completed
	Other than above					Unit has abnormality (NOTE 4)

- If automatic correct is impossible, check the indoor unit wiring and piping manually.

#### NOTE:

- For two rooms, LED 4,5 and 6 are not illuminated, for three rooms, LED 5 and 6 are not illuminated and for four rooms, LED 6 is not illuminated after wiring operation complete.
- If the outdoor air temperature is less than 5°C or unit has abnormality, wiring operation will not start.
- After wiring check operation is complete, LED indication will illuminated until normal operation starts.
- Follow the product diagnosis procedure. (Check the diagnostic label at the cabinet side plate.)
- When LED 1 only illuminate, indicates that outdoor unit is operating normally.

### 15.1.4 Power Save Mode

- Power Save Mode can be enabled by pushing POWER SAVE switch (SW4) to ON before power supply ON.
- When Power Save Mode is ON, the unit can be operate at lower running current where the breaker capacity not achieve the requirement.

### 15.1.5 Mode priority function

- Mode priority function can be enabled by pushing MODE PRIORITY switch (SW5) to ON before power supply ON.
- When Mode Priority Function is ON, the mode priority is given to higher capacity indoor units.

### 15.1.6 Cooling only function

- The unit capable to limit the operation mode to Cooling Mode only (Heating mode disabled) by cutting JP1 (COOL ONLY) before power supply ON.
- This function prevent wrong operation during the unit installed in server room.
- This function could be disabled again by short the JP1 (COOL ONLY) before power supply ON.

#### Wiring automatic correct example

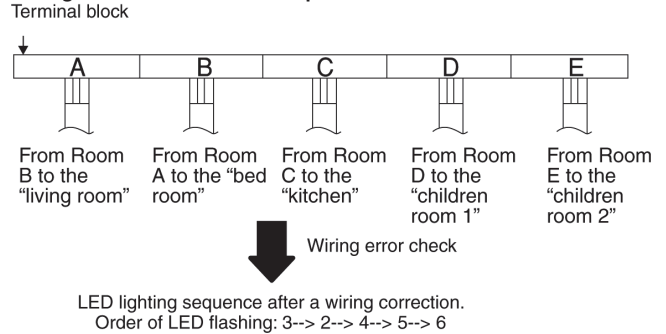

## 16. Troubleshooting Guide

### 16.1 Self Diagnosis Function

- The display screen of wireless remote control unit and the self-diagnosis LEDs (green) on the outdoor printed circuit board in the outdoor unit can be used to identify the location of the problem.  
Refer to the table below to identify and solve the cause of the problem, and then re-start the air conditioner system.
- If the problem is solved and operation returns to normal.  
LED 1 illuminates and others LED are off.

Diagnosis display	Abnormality or protection control	LED 6	LED 5	LED 4	LED 3	LED 2	LED 1	Abnormality judgement	Protection operation	Problem	Check location
H11	Indoor/outdoor abnormal communication						○	After operation for 1 minute	Indoor fan only operation can start by entering into force cooling operation	Indoor/outdoor communication not establish	<ul style="list-style-type: none"> <li>Indoor/outdoor wire terminal</li> <li>Indoor/outdoor PCB</li> <li>Indoor/outdoor connection wire</li> </ul>
H12	Indoor unit capacity unmatched					○		90s after power supply	—	Total indoor capability more than maximum limit or less than minimum limit, or number of indoor unit less than two.	<ul style="list-style-type: none"> <li>Indoor/outdoor connection wire</li> <li>Indoor/outdoor PCB</li> <li>Specification and combination table in catalogue</li> </ul>
H15	Compressor temperature sensor abnormality					○	○	Continuous for 5s	—	Compressor temperature sensor open or short circuit	<ul style="list-style-type: none"> <li>Compressor temperature sensor lead wire and connector</li> </ul>
H16	Outdoor current transformer (CT) abnormality				○		○	—	—	Current transformer faulty or compressor faulty	<ul style="list-style-type: none"> <li>Outdoor PCB faulty or compressor faulty</li> </ul>
H27	Outdoor air temperature sensor abnormality				○	○		Continuous for 5s	—	Outdoor air temperature sensor open or short circuit	<ul style="list-style-type: none"> <li>Outdoor air temperature sensor lead wire and connector</li> </ul>
H28	Outdoor heat exchanger temperature sensor 1 abnormality				○	○	○	Continuous for 5s	—	Outdoor heat exchanger temperature sensor 1 open or short circuit	<ul style="list-style-type: none"> <li>Outdoor heat exchanger temperature sensor 1 lead wire and connector</li> </ul>
H32	Outdoor heat exchanger temperature sensor 2 abnormality			○				Continuous for 5s	—	Outdoor heat exchanger temperature sensor 2 open or short circuit	<ul style="list-style-type: none"> <li>Outdoor heat exchanger temperature sensor 2 lead wire and connector</li> </ul>
H33	Indoor / outdoor misconnection abnormality			○			○	—	—	Indoor and outdoor rated voltage different	<ul style="list-style-type: none"> <li>Indoor and outdoor units check</li> </ul>
H36	Outdoor gas pipe temperature sensor abnormality			○		○		Continuous for 5s	Heating protection operation only	Outdoor gas pipe temperature sensor open or short circuit	<ul style="list-style-type: none"> <li>Outdoor gas pipe temperature sensor lead wire and connector</li> </ul>
H37	Outdoor liquid pipe temperature sensor abnormality			○		○	○	Continuous for 5s	Cooling protection operation only	Outdoor liquid pipe temperature sensor open or short circuit	<ul style="list-style-type: none"> <li>Outdoor liquid pipe temperature sensor lead wire and connector</li> </ul>

Diagnosis display	Abnormality or protection control	LED 6	LED 5	LED 4	LED 3	LED 2	LED 1	Abnormality judgement	Protection operation	Problem	Check location
H64	Outdoor high pressure sensor abnormality			○	○			Continuous for 1 minute	—	High pressure sensor open circuit during compressor stop	<ul style="list-style-type: none"> <li>High pressure sensor</li> <li>Lead wire and connector</li> </ul>
H97	Outdoor fan motor mechanism lock			○	○		○	2 times happen within 30 minutes	—	Outdoor fan motor lock or feedback abnormal	<ul style="list-style-type: none"> <li>Outdoor fan motor lead wire and connector</li> <li>Fan motor lock or block</li> </ul>
H98	Indoor high pressure protection			○	○	○		—	—	Indoor high pressure protection (Heating)	<ul style="list-style-type: none"> <li>Check indoor heat exchanger</li> <li>Air filter dirty</li> <li>Air circulation short circuit</li> </ul>
H99	Indoor operating unit freeze protection			○	○	○		—	—	Indoor freeze protection (Cooling)	<ul style="list-style-type: none"> <li>Check indoor heat exchanger</li> <li>Air filter dirty</li> <li>Air circulation short circuit</li> </ul>
F11	4-way valve switching abnormality			○	○	○	○	4 times happen within 30 minutes	—	4-way valve switching abnormal	<ul style="list-style-type: none"> <li>4-way valve</li> <li>Lead wire and connector.</li> </ul>
F17	Indoor standby units freezing abnormality		○					3 times happen within 40 minutes	—	Wrong wiring and connecting pipe, expansion valve leakage.	<ul style="list-style-type: none"> <li>Check indoor/outdoor connection wire and pipe</li> <li>Indoor heat exchanger sensor lead wire and connector</li> <li>Expansion valve lead wire and connector.</li> </ul>
F90	Power factor correction (PFC) circuit protection		○				○	4 times happen within 20 minutes	—	Power factor correction circuit abnormal	<ul style="list-style-type: none"> <li>Outdoor PCB faulty</li> </ul>
F91	Refrigeration cycle abnormality		○			○		4 times happen within 60 minutes	—	Refrigeration cycle abnormal	<ul style="list-style-type: none"> <li>Insufficient refrigerant or valve close</li> </ul>
F93	Compressor abnormal revolution		○			○	○	4 times happen within 20 minutes	—	Compressor abnormal revolution	<ul style="list-style-type: none"> <li>Power transistor module faulty or compressor lock</li> </ul>
F94	Compressor discharge pressure overshoot protection		○		○			4 times happen within 30 minutes	—	Compressor discharge pressure overshoot	<ul style="list-style-type: none"> <li>Check refrigeration system</li> </ul>
F95	Outdoor cooling high pressure protection		○		○		○	4 times happen within 20 minutes	—	Cooling high pressure protection	<ul style="list-style-type: none"> <li>Check refrigeration system</li> <li>Outdoor air circuit</li> </ul>
F96	Power transistor module overheating protection		○		○	○		4 times happen within 30 minutes	—	Power transistor module overheat	<ul style="list-style-type: none"> <li>PCB faulty</li> <li>Outdoor air circuit (fan motor)</li> </ul>

Diagnosis display	Abnormality or protection control	LED 6	LED 5	LED 4	LED 3	LED 2	LED 1	Abnormality judgement	Protection operation	Problem	Check location
F97	Compressor overheating protection		○		○	○	○	3 times happen within 30 minutes	—	Compressor overheat	• Insufficient refrigerant
F98	Total running current protection		○	○				3 times happen within 20 minutes	—	Total current protection	• Check refrigeration system • Power source or compressor lock
F99	Outdoor direct current (DC) peak detection		○	○			○	Continuous happen for 7 times	—	Power transistor module current protection	• Power transistor module faulty or compressor lock

LED 1 illuminate is indicated that outdoor unit is operating normally. If the LED 1 is switched off or flashing, check the power supply and self-diagnosis indication.

● ----- Illuminate
○ ----- Flashing
Blank ----- OFF

## 16.2 Self-diagnosis Method

### 16.2.1 H11 (Indoor/Outdoor Abnormal Communication)

#### Malfunction Decision Conditions

- During startup and operation of cooling and heating, the data received from outdoor unit in indoor unit signal transmission is checked whether it is normal.

#### Malfunction Caused

- Faulty indoor unit PCB.
- Faulty outdoor unit PCB.
- Indoor unit-outdoor unit signal transmission error due to wiring error.
- Indoor unit-outdoor unit signal transmission error due to breaking of wire in the connection wires between the indoor and outdoor units.

#### Troubleshooting

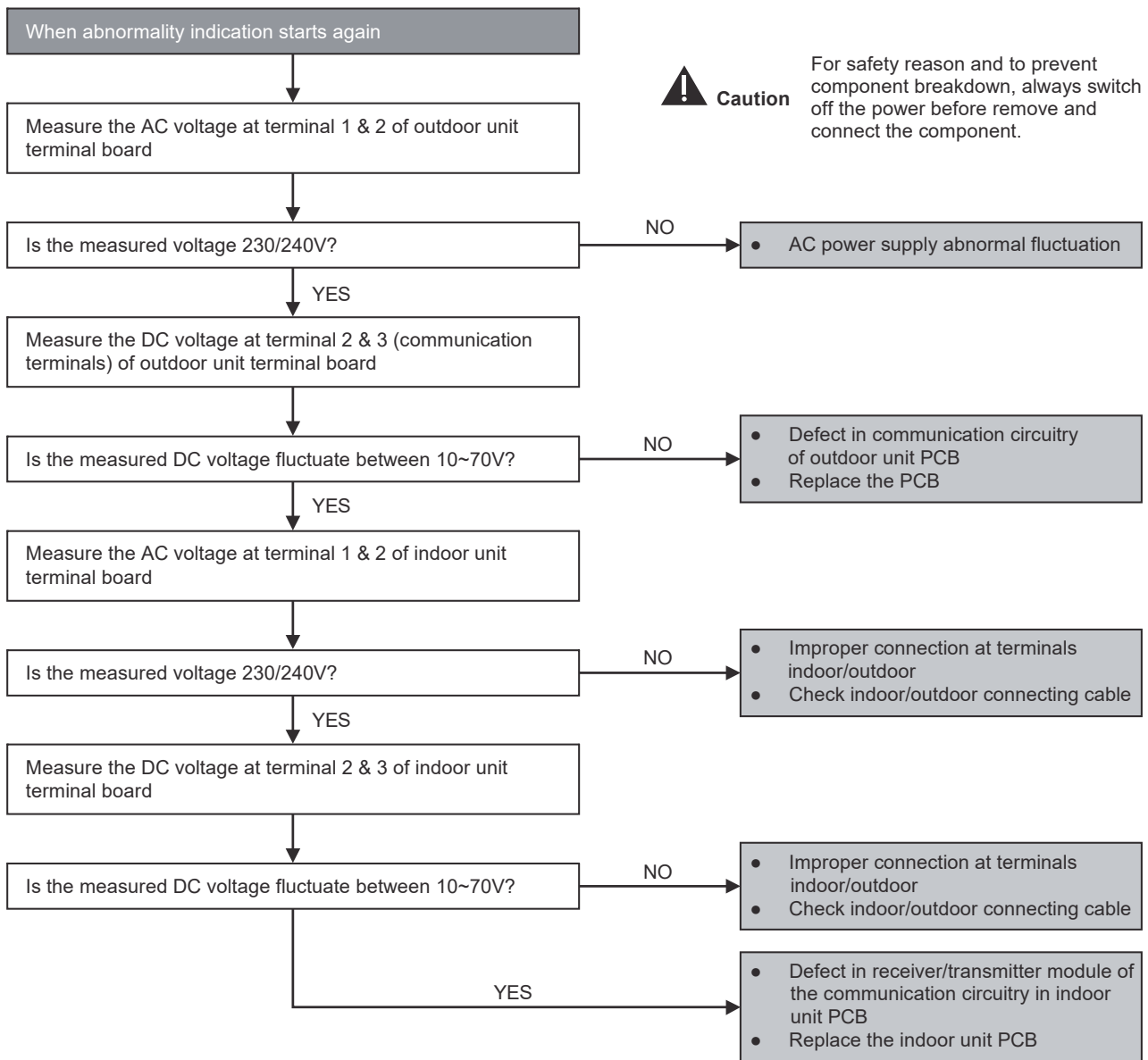

## 16.2.2 H12 (Indoor/Outdoor Capacity Rank Mismatched)

### Malfunction Decision Conditions

- During startup, error code appears when different types of indoor and outdoor units are interconnected.

### Malfunction Caused

- Wrong models interconnected.
- Wrong indoor unit or outdoor unit PCBs mounted.
- Indoor unit or outdoor unit PCBs defective.
- Indoor-outdoor unit signal transmission error due to wrong wiring.
- Indoor-outdoor unit signal transmission error due to breaking of wire 3 in the connection wires between the indoor and outdoor units.

### Troubleshooting

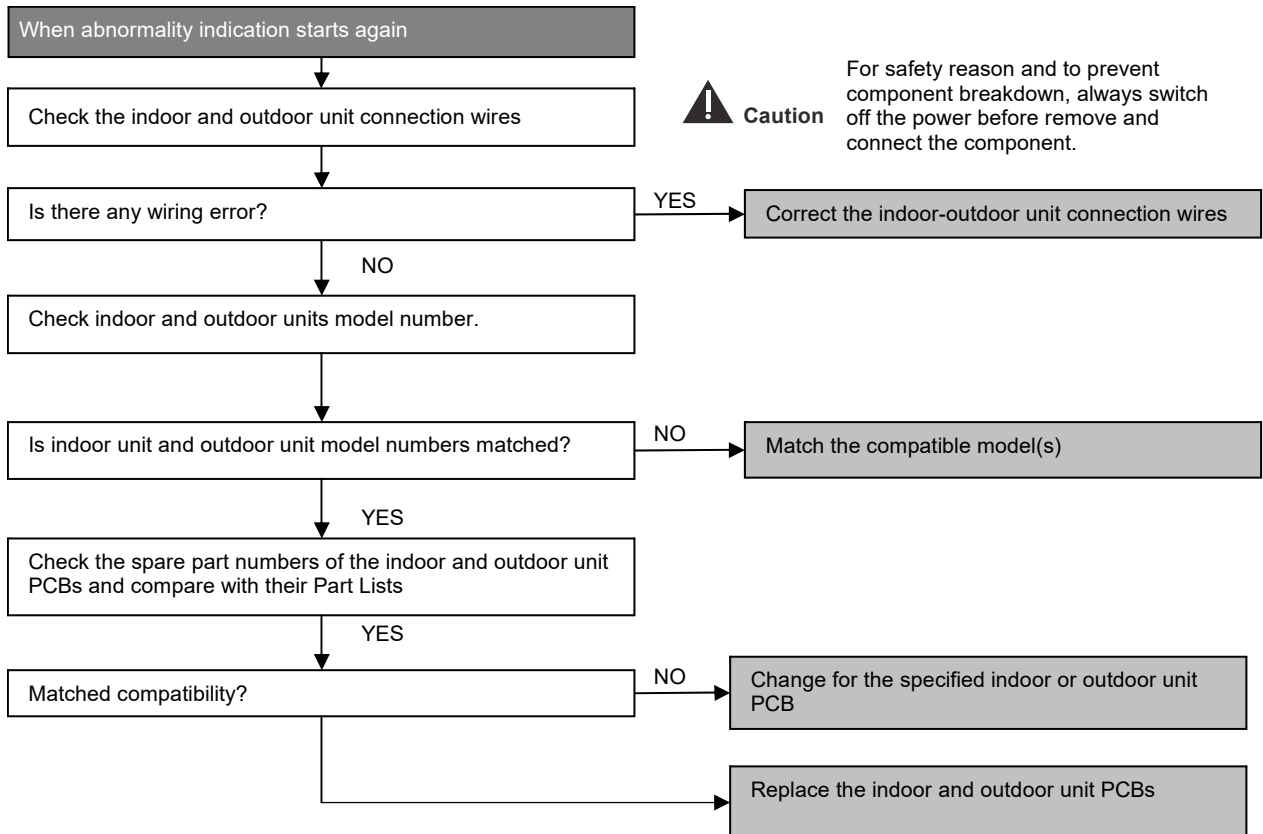

## 16.2.3 H15 (Compressor Temperature Sensor Abnormality)

### Malfunction Decision Conditions

- During startup and operation of cooling and heating, the temperatures detected by the outdoor compressor temperature sensor are used to determine sensor errors.

### Malfunction Caused

- Faulty connector connection.
- Faulty sensor.
- Faulty PCB.

### Troubleshooting

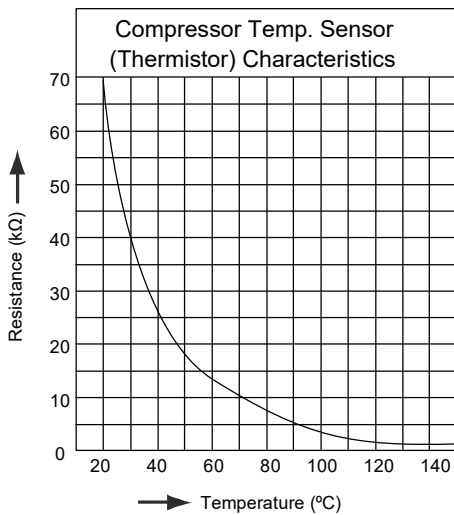
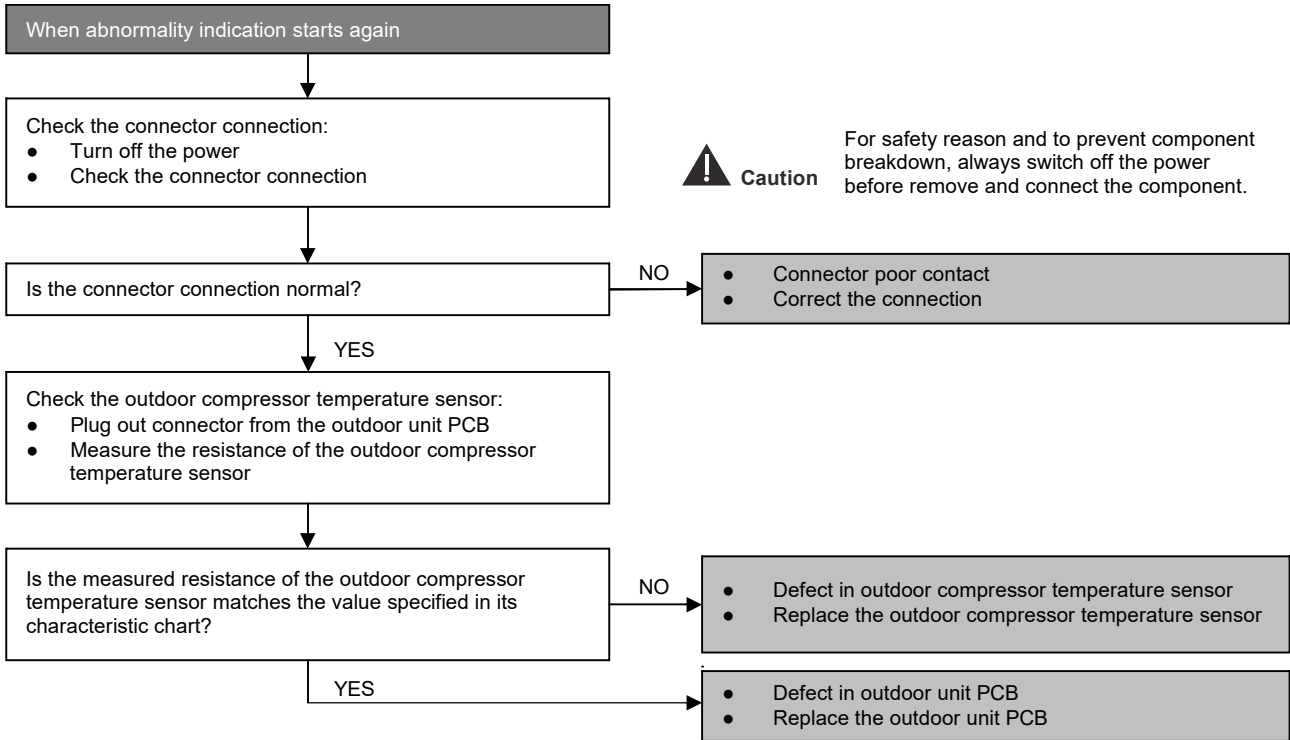



## 16.2.4 H16 (Outdoor Current Transformer)

### Malfunction Decision Conditions

- An input current, detected by Current Transformer CT, is below threshold value when the compressor is operating at certain frequency value for 3 minutes.

### Malfunction Caused

- Lack of gas
- Broken CT (current transformer)
- Broken Outdoor PCB

### Troubleshooting

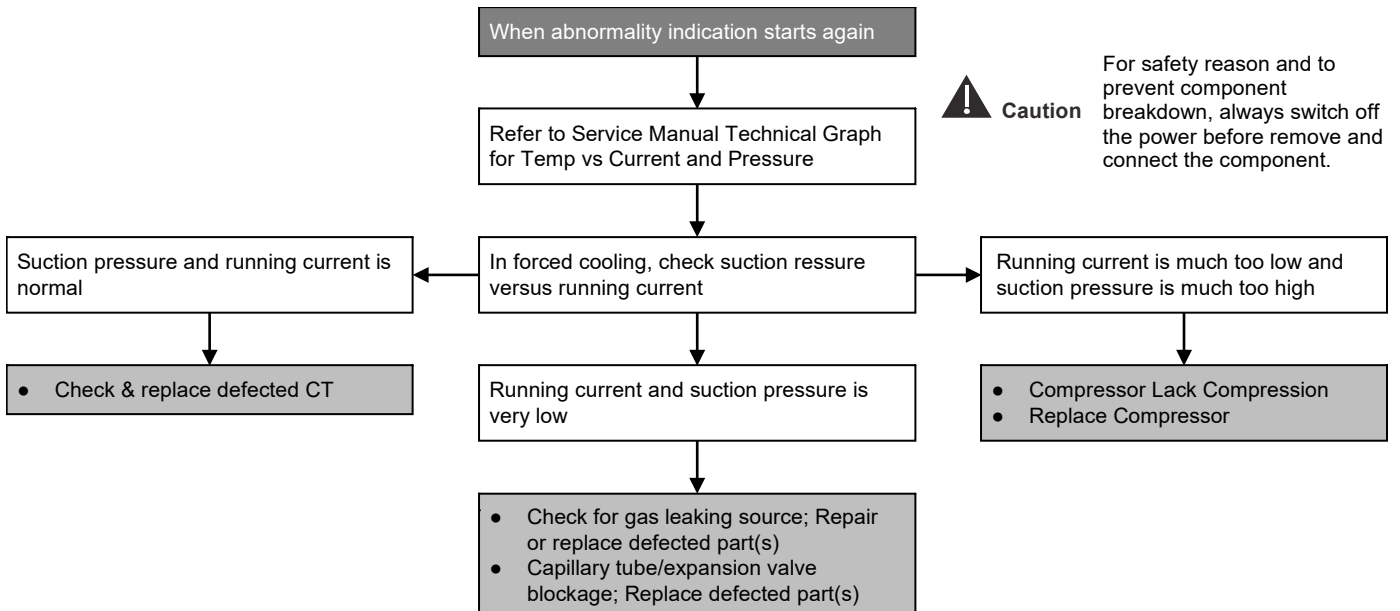

## 16.2.5 H27 (Outdoor Air Temperature Sensor Abnormality)

### Malfunction Decision Conditions

- During startup and operation of cooling and heating, the temperatures detected by the outdoor air temperature sensor are used to determine sensor errors.

### Malfunction Caused

- Faulty connector connection.
- Faulty sensor.
- Faulty PCB.

### Troubleshooting

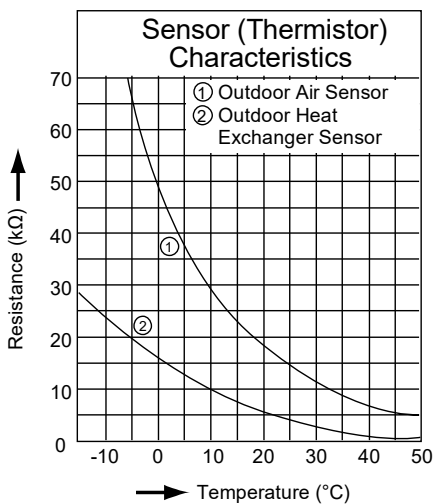
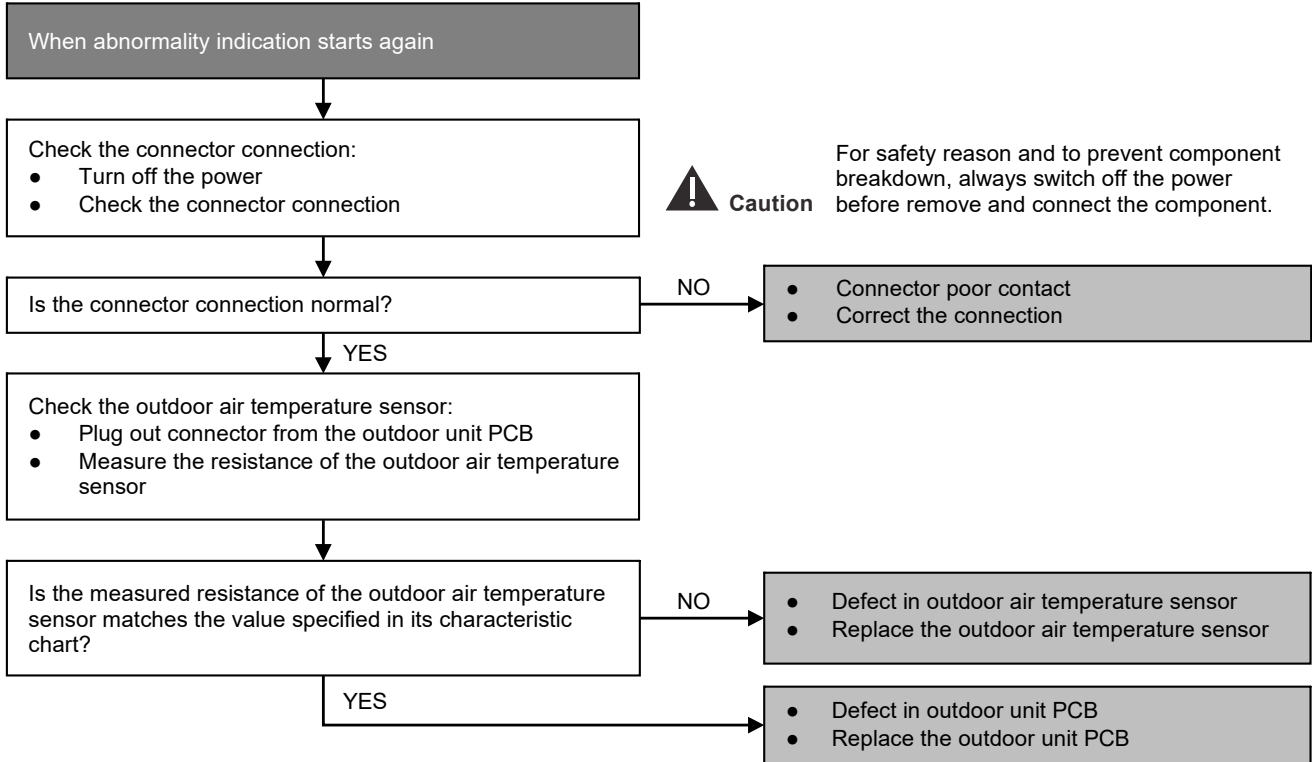

## 16.2.6 H28 (Outdoor Pipe Temperature Sensor Abnormality)

### Malfunction Decision Conditions

- During startup and operation of cooling and heating, the temperatures detected by the outdoor pipe temperature sensor are used to determine sensor errors.

### Malfunction Caused

- Faulty connector connection.
- Faulty sensor.
- Faulty PCB.

### Troubleshooting

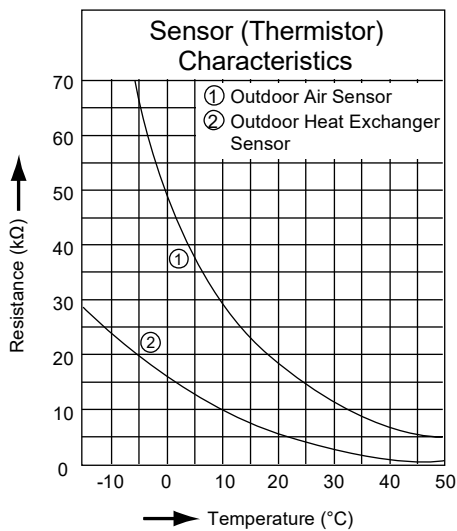
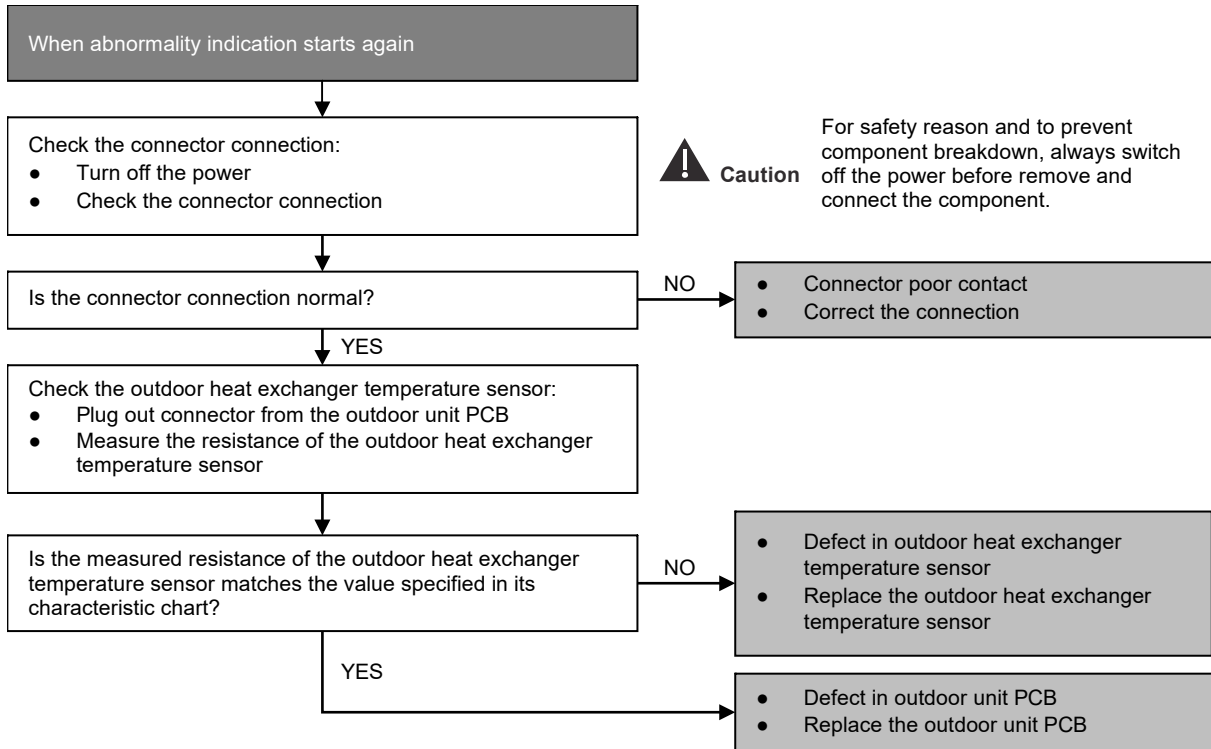

## 16.2.7 H32 (Outdoor Heat Exchanger Temperature Sensor 2 Abnormality)

### Malfunction Decision Conditions

- During startup and operation of cooling and heating, the temperatures detected by the outdoor heat exchanger temperature sensor are used to determine sensor errors.

### Malfunction Caused

- Faulty connector connection.
- Faulty sensor.
- Faulty PCB.

### Troubleshooting

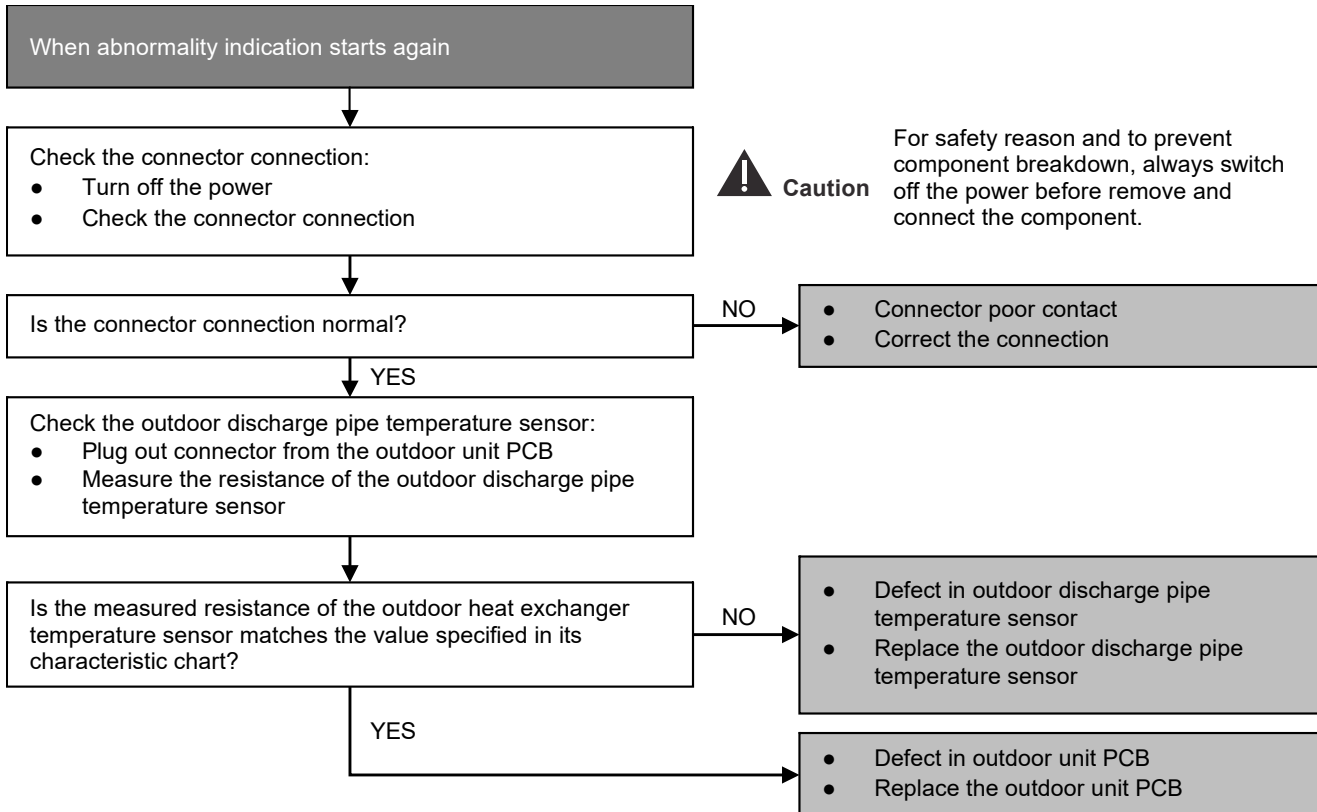

## 16.2.8 H33 (Unspecified Voltage between Indoor and Outdoor)

### Malfunction Decision Conditions

- The supply power is detected for its requirement by the indoor/outdoor transmission.

### Malfunction Caused

- Wrong models interconnected.
- Wrong indoor unit and outdoor unit PCBs used.
- Indoor unit or outdoor unit PCB defective.

### Troubleshooting

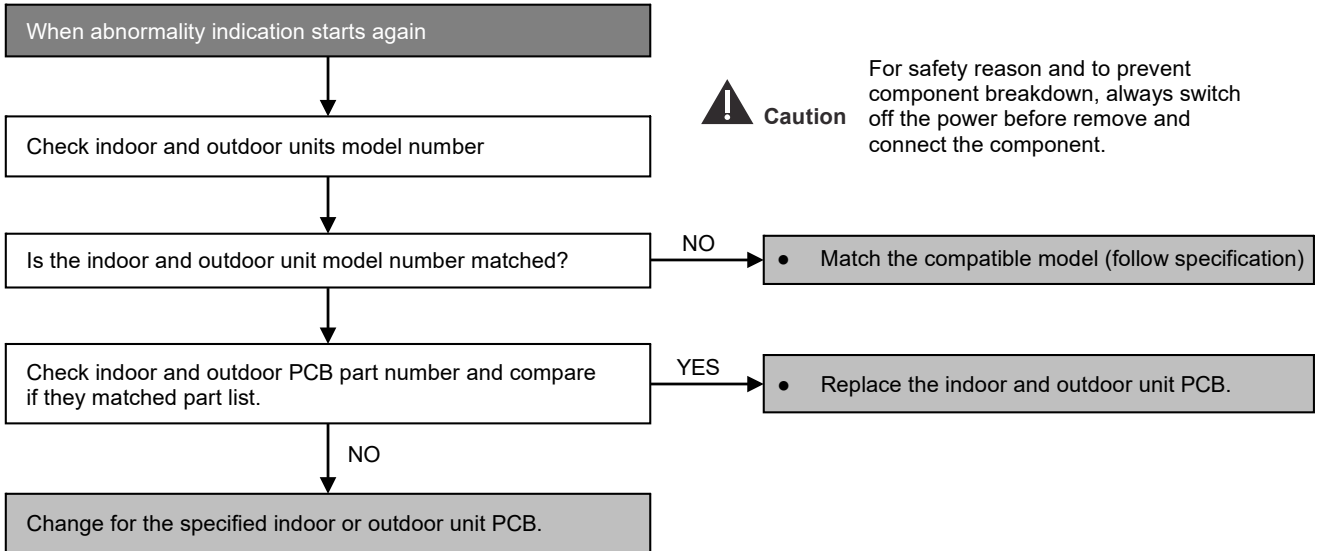

## 16.2.9 H36 (Outdoor Gas Pipe Sensor Abnormality)

### Malfunction Decision Conditions

- During startup and operation of cooling and heating, the temperatures detected by the outdoor gas pipe temperature sensor are used to determine sensor errors.

### Malfunction Caused

- Faulty connector connection.
- Faulty sensor.
- Faulty PCB.

### Troubleshooting

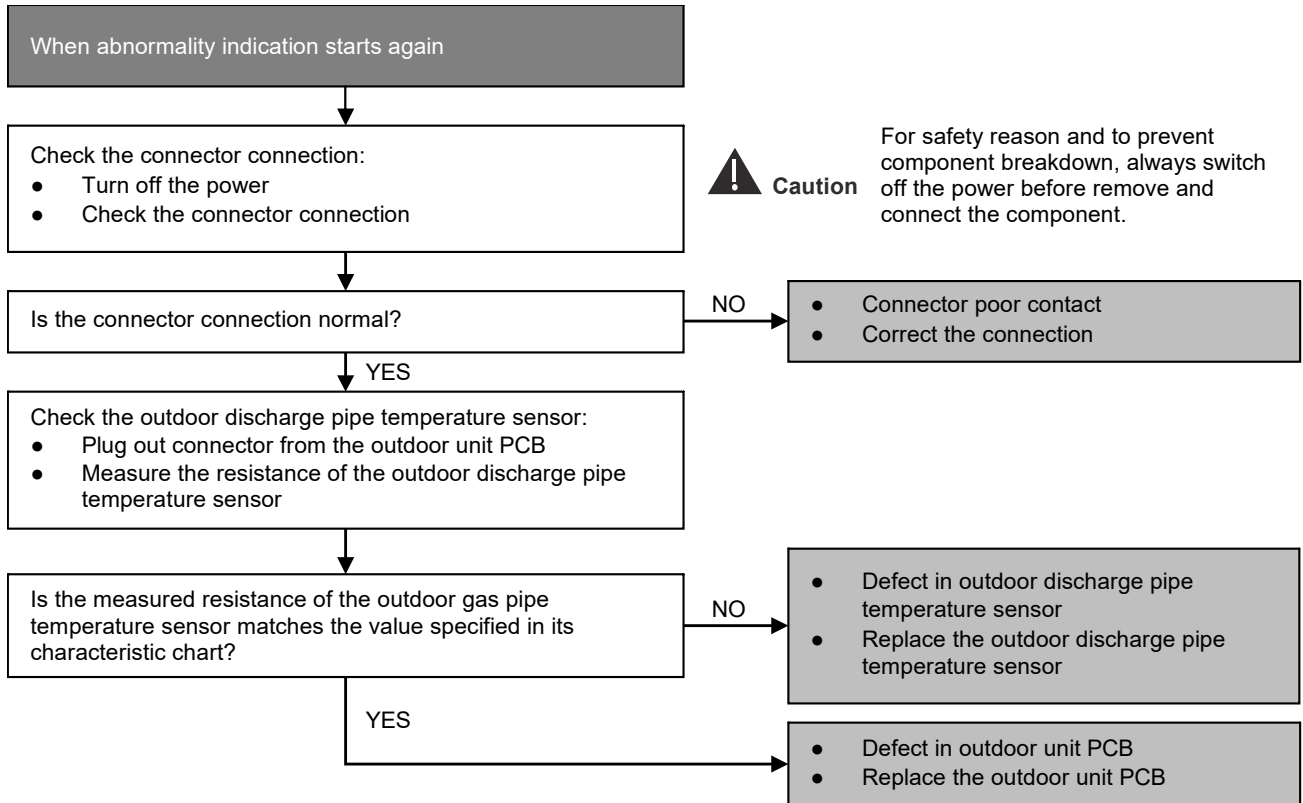

## 16.2.10 H37 (Outdoor Liquid Pipe Temperature Sensor Abnormality)

### Malfunction Decision Conditions

- During startup and operation of cooling and heating, the temperatures detected by the outdoor liquid pipe temperature sensor are used to determine sensor errors.

### Malfunction Caused

- Faulty connector connection.
- Faulty sensor.
- Faulty PCB.

### Troubleshooting

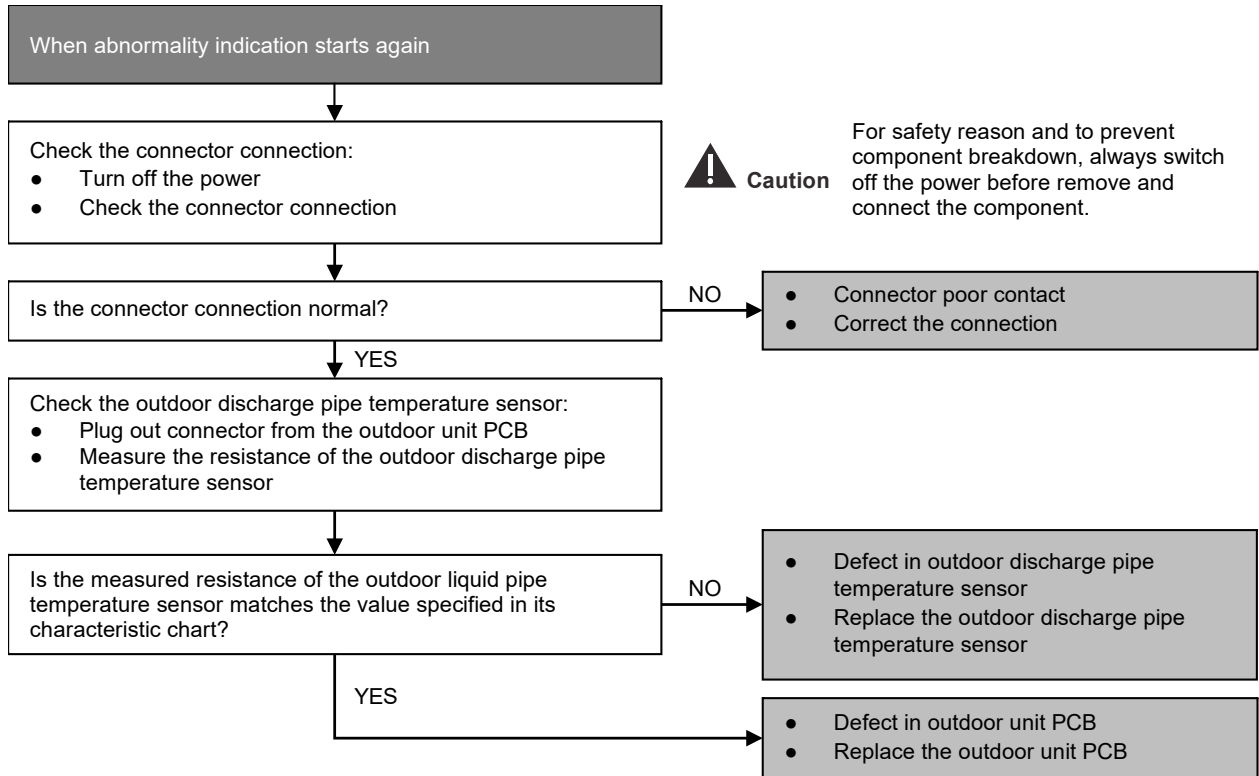

## 16.2.11 H97 (Outdoor Fan Motor – DC Motor Mechanism Locked)

### Malfunction Decision Conditions

- The rotation speed detected by the Hall IC during fan motor operation is used to determine abnormal fan motor.

### Malfunction Caused

- Operation stops due to short circuit inside the fan motor winding.
- Operation stops due to breaking of wire inside the fan motor.
- Operation stops due to breaking of fan motor lead wires.
- Operation stops due to Hall IC malfunction.
- Operation error due to faulty outdoor unit PCB.

### Troubleshooting

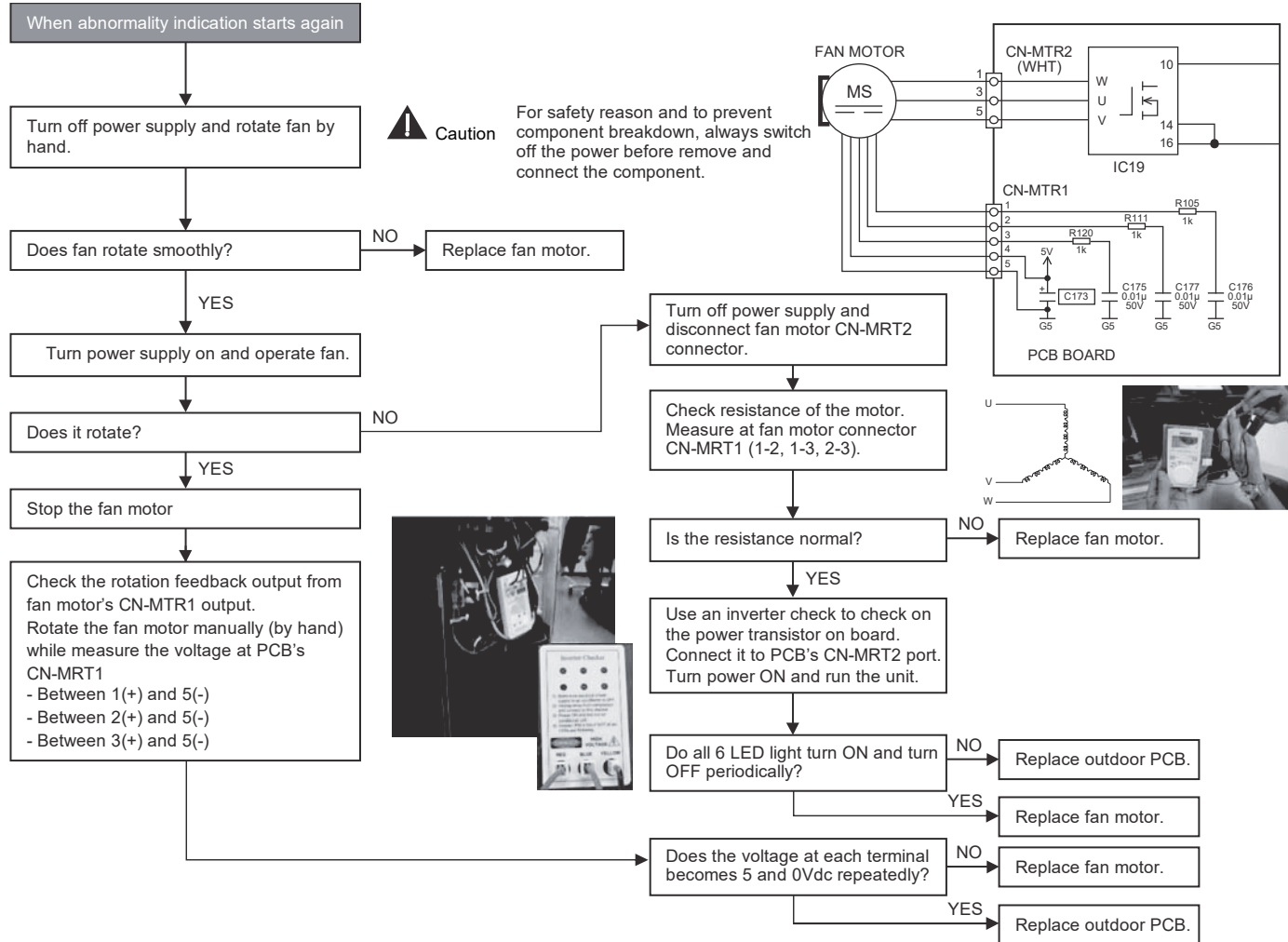



## 16.2.12 H98 (Error Code Stored in Memory and no alarm is triggered / no TIMER LED flashing)

### Malfunction Decision Conditions

- Indoor high pressure is detected when indoor heat exchanger is detecting very high temperature when the unit is operating in heating operation.
- Phenomena: unit is stopping and re-starting very often in heating mode

### Malfunction Caused

- Indoor heat exchanger thermistor
- Clogged air filter or heat exchanger
- Over-bent pipe (liquid side)

### Troubleshooting

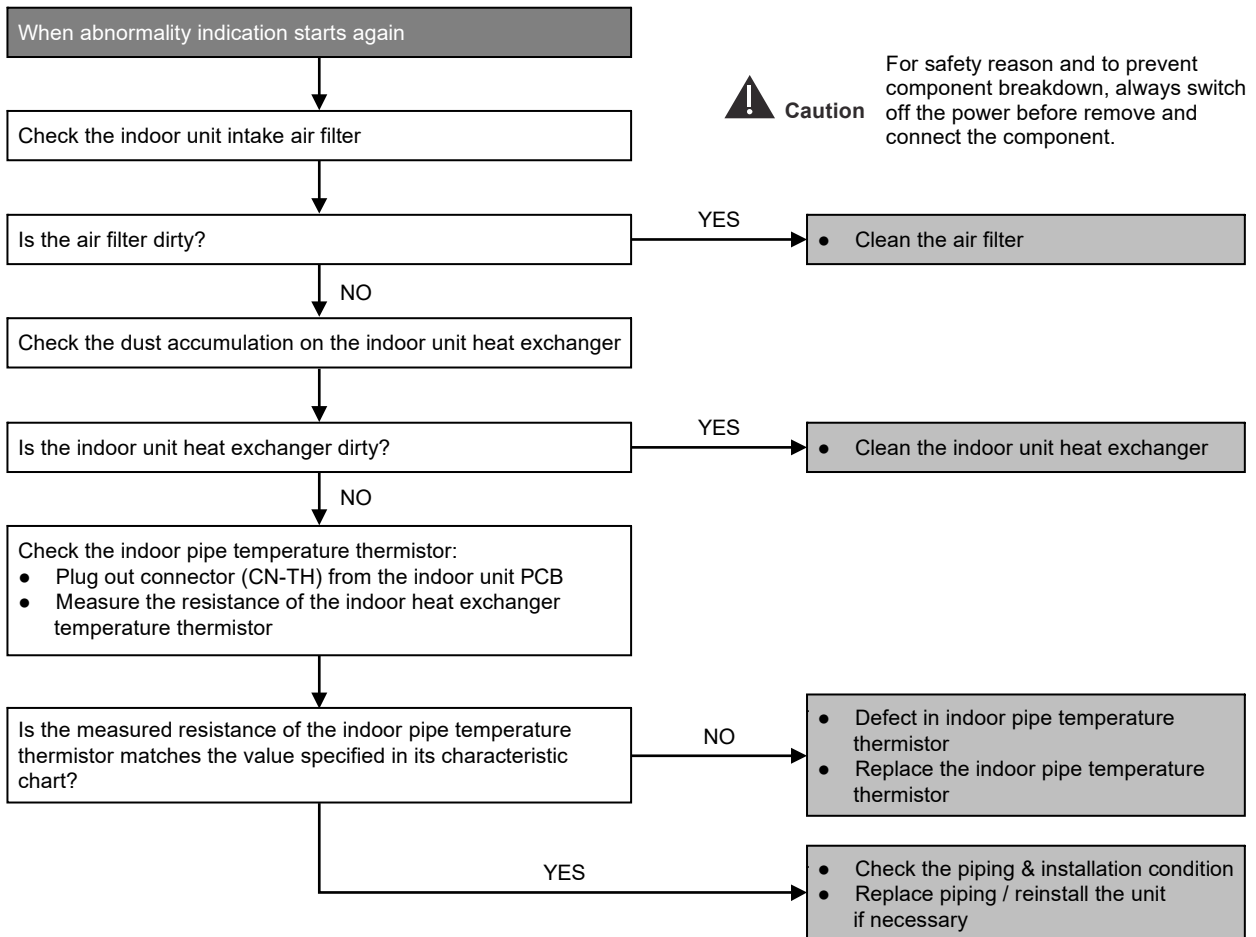

## 16.2.13 H99 (Indoor Freeze Prevention Protection: Cooling or Soft Dry)

Error Code will not display (no Timer LED blinking) but store in EEPROM

### Malfunction Decision Conditions

- Freeze prevention control takes place (when indoor pipe temperature is lower than 2°C)

### Malfunction Caused

- Air short circuit at indoor unit
- Clogged indoor unit air filter
- Dust accumulation on the indoor unit heat exchanger
- 2/3 way valve closed
- Faulty indoor unit fan motor
- Refrigerant shortage (refrigerant leakage)
- Clogged expansion valve or strainer
- Faulty indoor pipe temperature sensor
- Faulty indoor unit PCB

### Troubleshooting

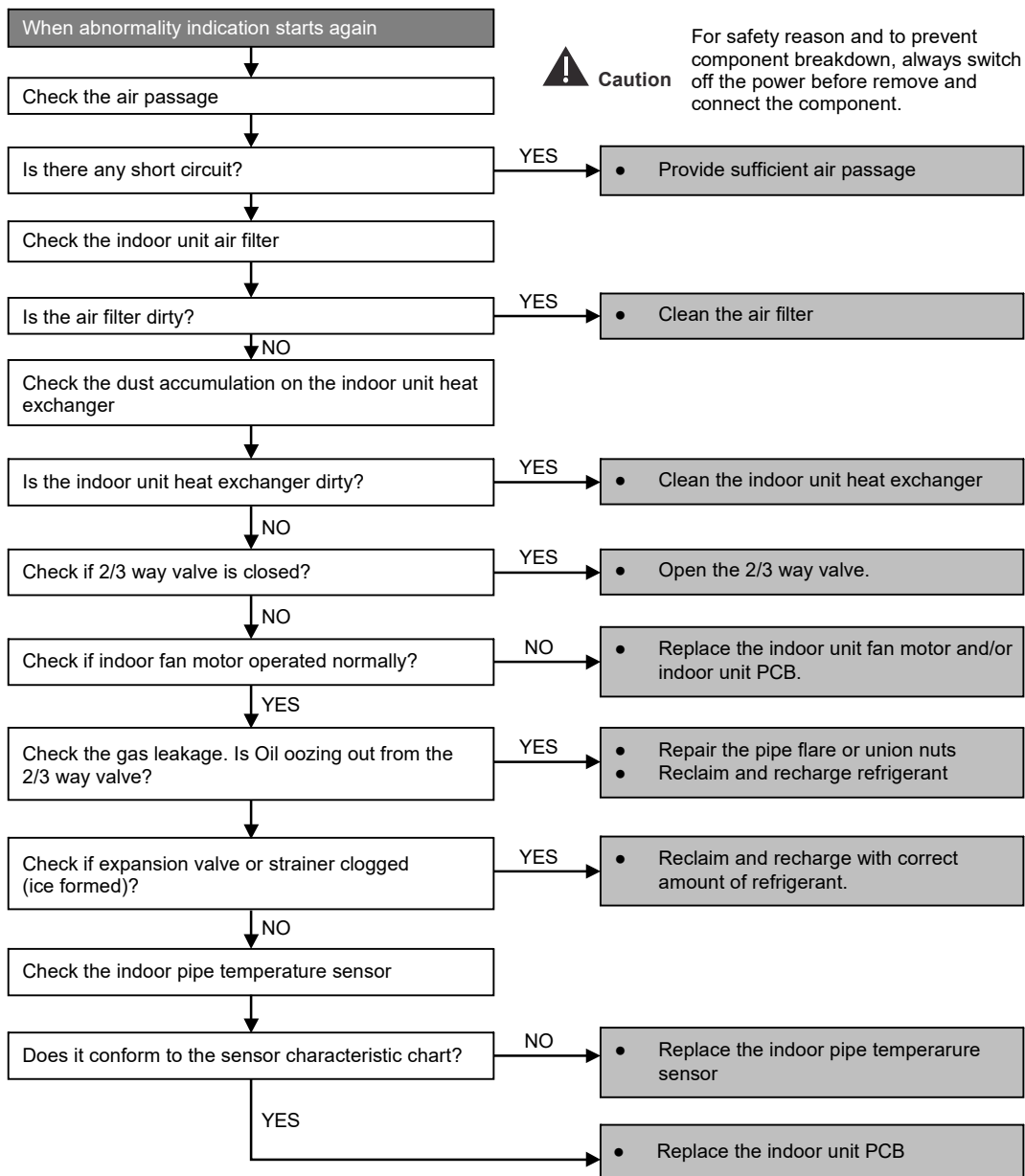

## 16.2.14 F11 (4-way Valve Switching Failure)

### Malfunction Decision Conditions

- When indoor heat exchanger is cold during heating (except deice) or when indoor heat exchanger is hot during cooling and compressor operating, the 4-way valve is detected as malfunction.

### Malfunction Caused

- Indoor heat exchanger (pipe) thermistor
- 4-way valve malfunction

### Troubleshooting

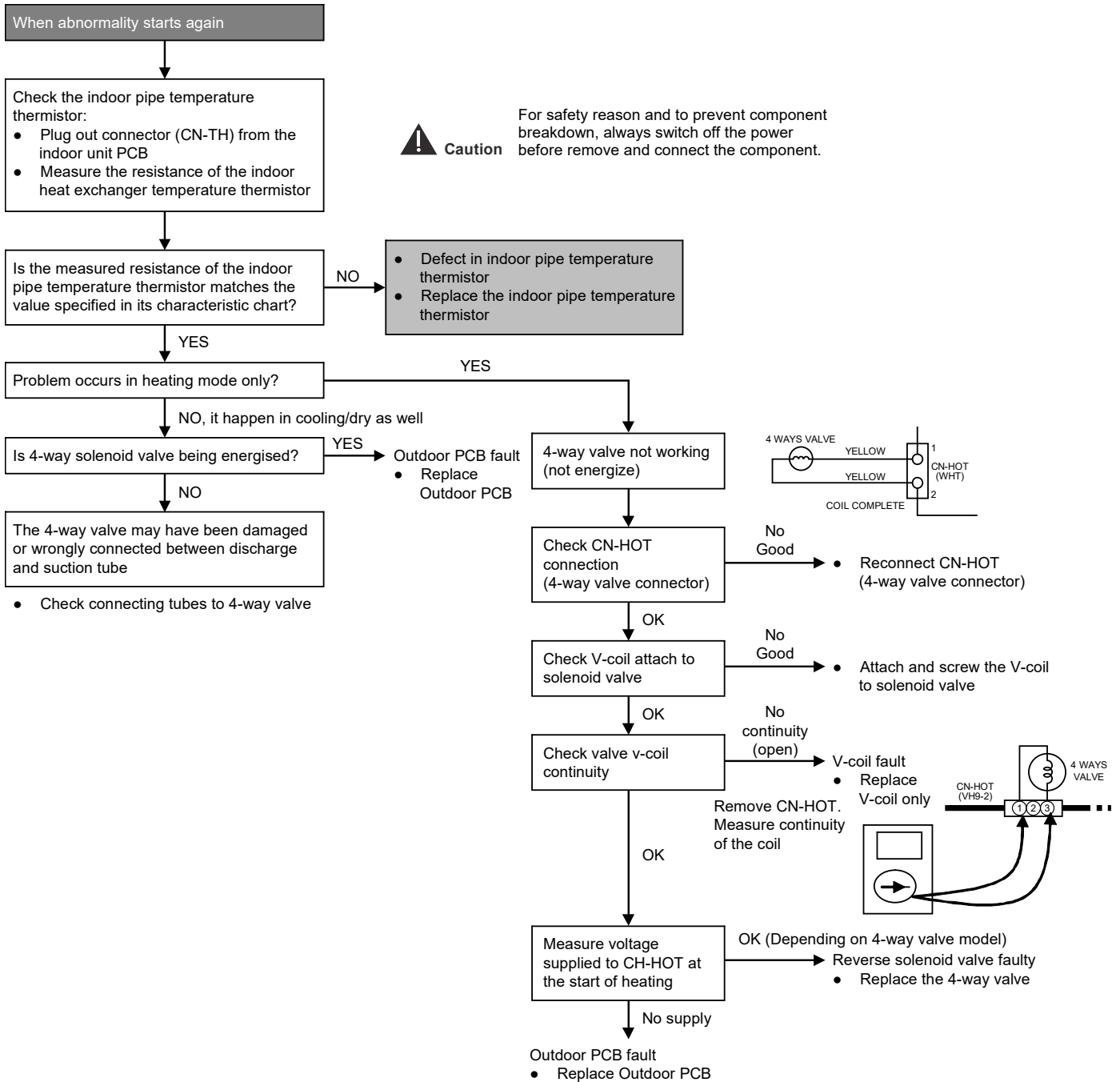

\* Check gas side pipe – for hot gas flow in cooling mode

## 16.2.15 F17 (Indoor Standby Units Freezing Abnormality)

### Malfunction Decision Conditions

- When the different between indoor intake air temperature and indoor pipe temperature is above 10°C or indoor pipe temperature is below -1.0°C.

### Remark:

When the indoor standby unit is freezing, the outdoor unit transfers F17 error code to the corresponding indoor unit and H39 to other indoor unit(s).

### Malfunction Caused

- Wrong wiring connection
- Faulty sensor
- Faulty expansion valve

### Troubleshooting

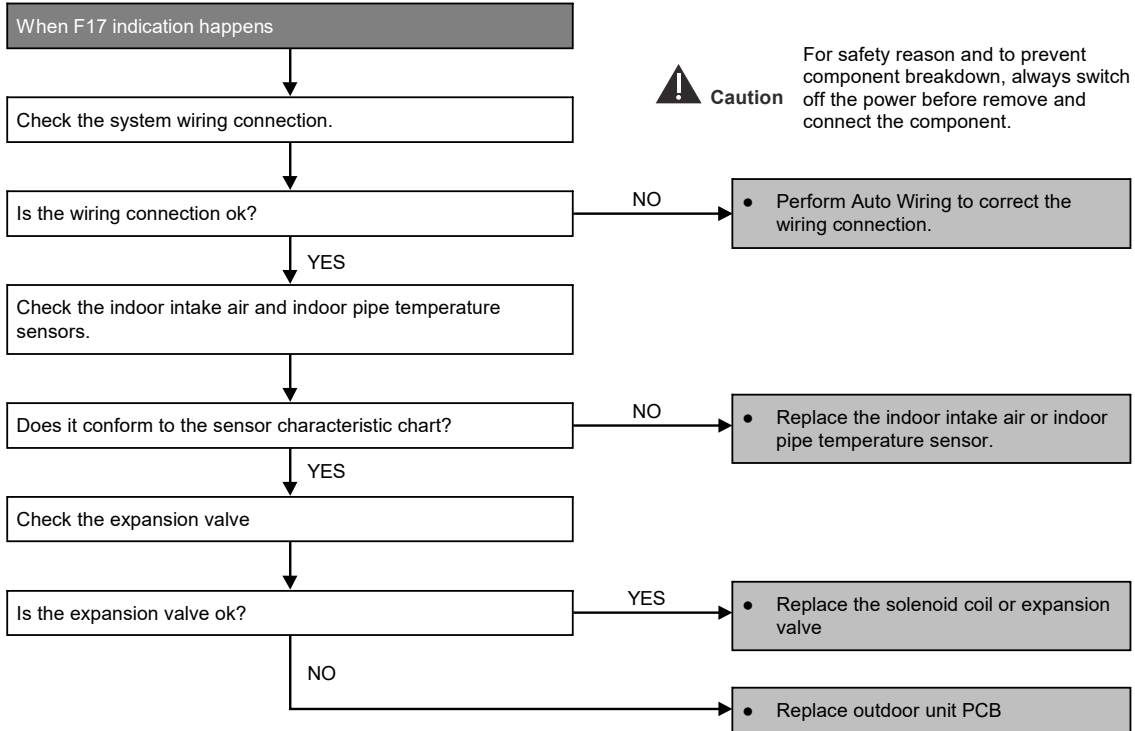

## 16.2.16 F90 (Power Factor Correction Protection)

### Malfunction Decision Conditions

- To maintain DC voltage level supply to power transistor.
- To detect high DC voltage level after rectification.

### Malfunction Caused

- During startup and operation of cooling and heating, when Power Factor Correction (PFC) protection circuitry at the outdoor unit main PCB senses abnormal DC voltage level for power transistors.
- When DC voltage detected is LOW, transistor switching will turn ON by controller to push-up the DC level.
- When DC voltage detected is HIGH (391Vdc – 425Vdc), active LOW signal will send by the controller to turn OFF relay RY-C.

### Troubleshooting

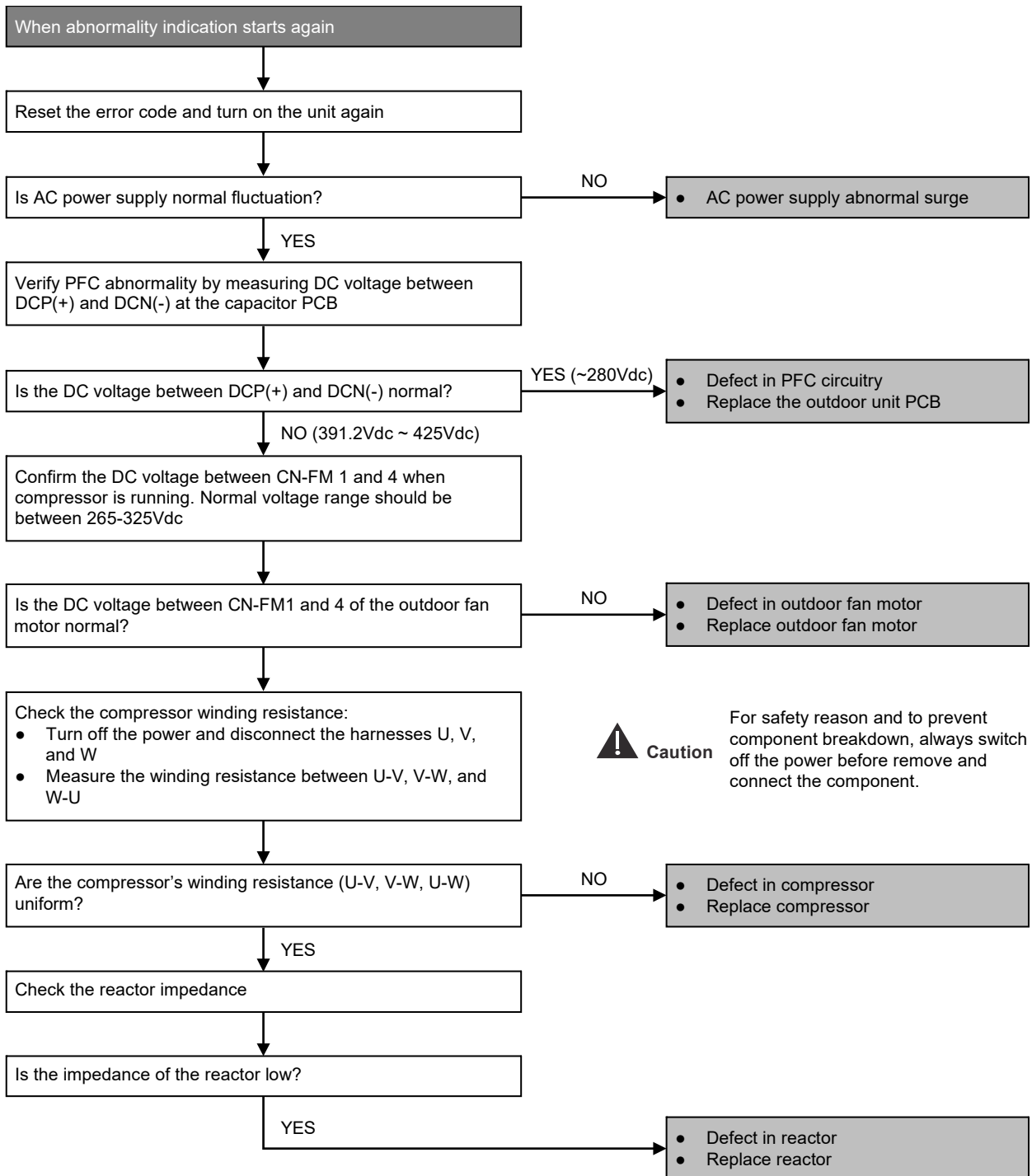

## 16.2.17 F91 (Refrigeration Cycle Abnormality)

### Malfunction Decision Conditions

- The input current is low while the compressor is running at higher than the setting frequency.

### Malfunction Caused

- Lack of gas.
- 3-way valve close.

### Troubleshooting

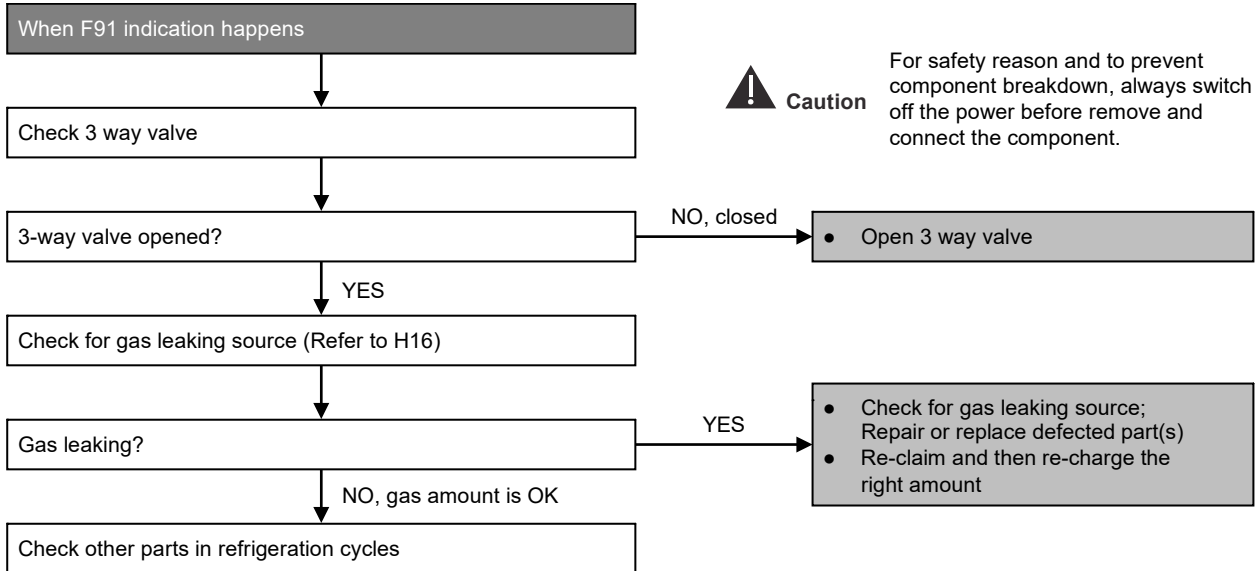

## 16.2.18 F93 (Compressor Rotation Failure)

### Malfunction Decision Conditions

- A compressor rotation failure is detected by checking the compressor running condition through the position detection circuit.

### Malfunction Caused

- Compressor terminal disconnect
- Faulty Outdoor PCB
- Faulty compressor

### Troubleshooting

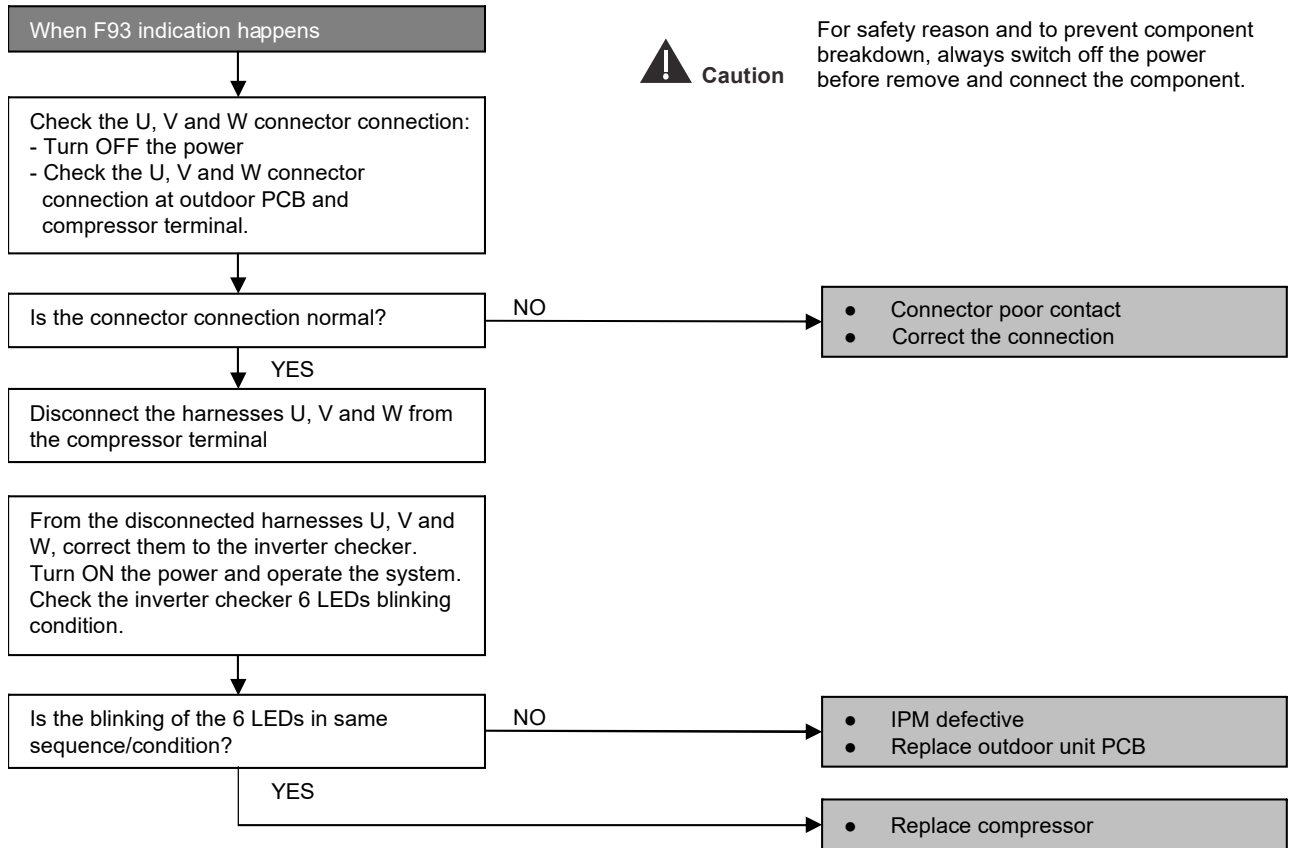

## 16.2.19 F95 (Outdoor High Pressure Protection: Cooling or Soft Dry)

### Malfunction Decision Conditions

- During operation of cooling or soft dry, when outdoor unit heat exchanger high temperature data is detected by the outdoor unit heat exchanger thermistor.

### Malfunction Caused

- Outdoor heat exchanger temperature rise due to short-circuit of hot discharge air flow.
- Outdoor heat exchanger temperature rise due to defective of outdoor fan motor.
- Outdoor heat exchange temperature rise due to defective outdoor heat exchanger thermistor.
- Outdoor heat exchanger temperature rise due to defective of outdoor unit PCB.

### Troubleshooting

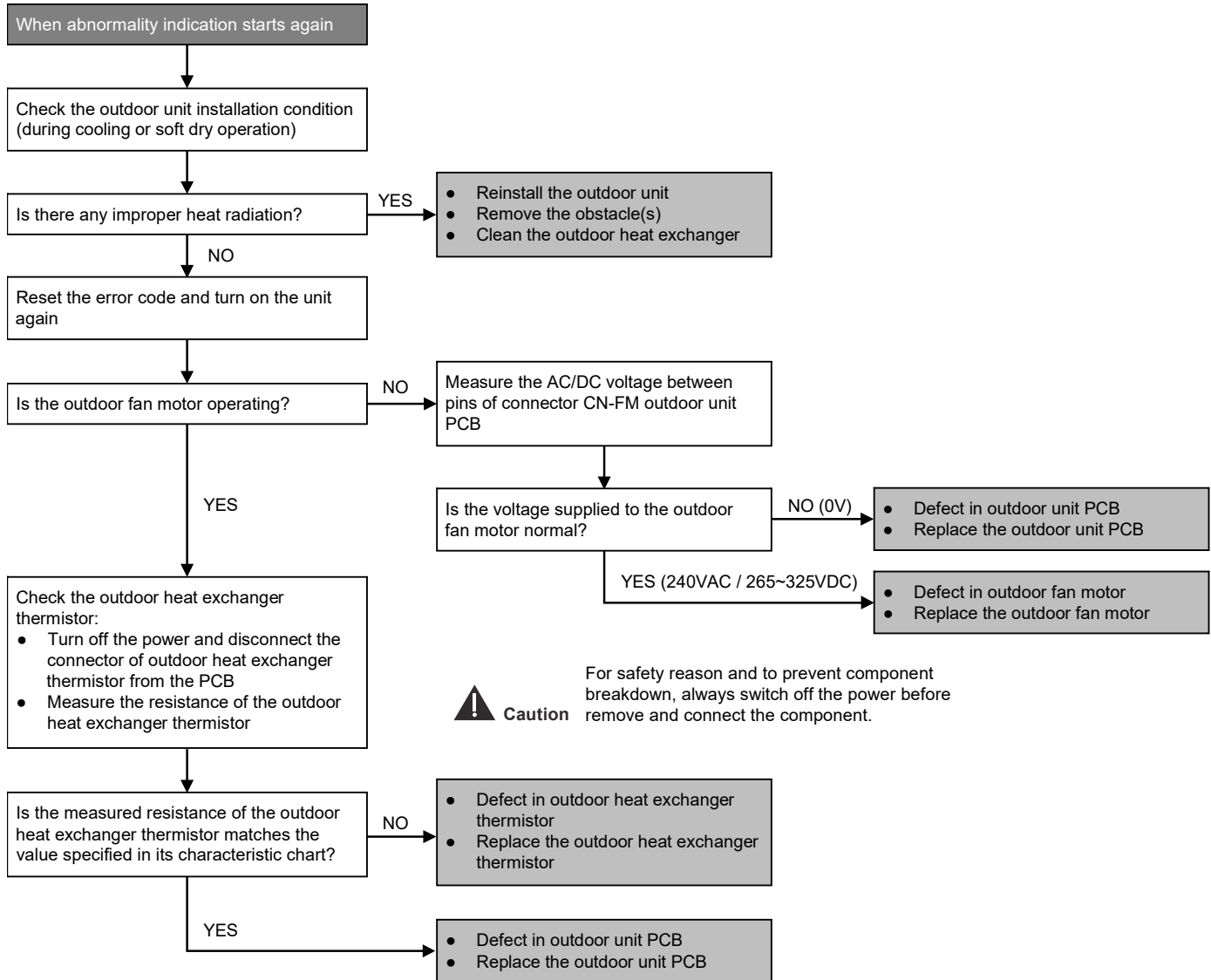



## 16.2.20 F96 (IPM Overheating)

### Malfunction Decision Conditions

- During operating of cooling and heating, when IPM temperature data (100°C) is detected by the IPM temperature sensor.

#### *Multi Models only*

- Compressor Overheating: During operation of cooling and heating, when the compressor OL is activated.
- Heat Sink Overheating: During operation of cooling and heating, when heat sink temperature data (90°C) is detected by the heat sink temperature sensor.

### Malfunction Caused

- IPM overheats due to short circuit of hot discharge air flow.
- IPM overheats due to defective of outdoor fan motor.
- IPM overheats due to defective of internal circuitry of IPM.
- IPM overheats due to defective IPM temperature sensor.

#### *Multi Models Only*

- Compressor OL connector poor contact.
- Compressor OL faulty.

### Troubleshooting

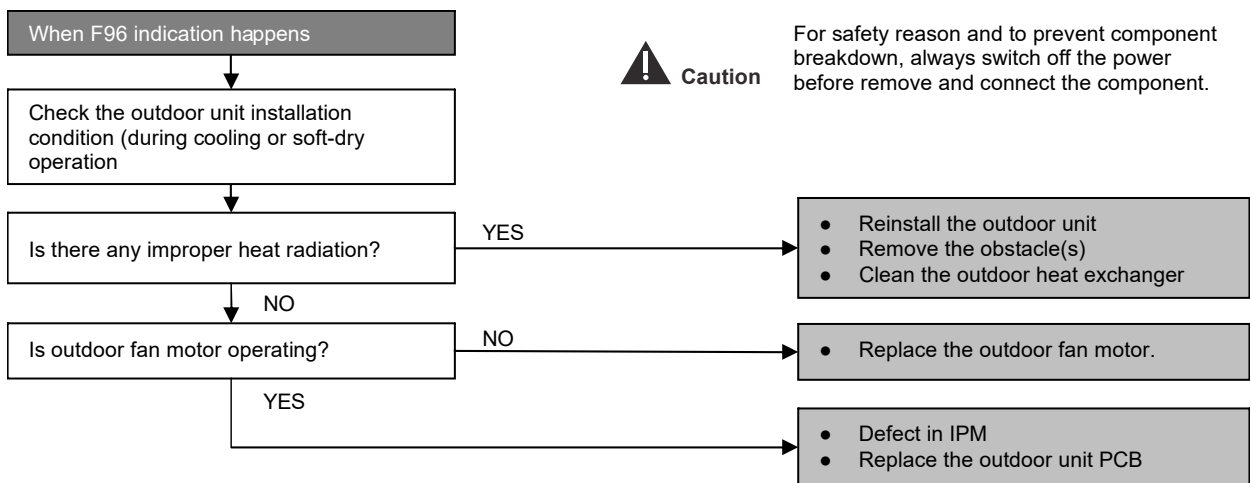

## 16.2.21 F97 (Compressor Overheating)

### Malfunction Decision Conditions

- During operation of cooling and heating, when compressor tank temperature data (112°C) is detected by the compressor tank temperature sensor.

### Malfunction Caused

- Faulty compressor tank temperature sensor
- 2/3 way valve closed
- Refrigerant shortage (refrigerant leakage)
- Faulty outdoor unit PCB
- Faulty compressor

### Troubleshooting

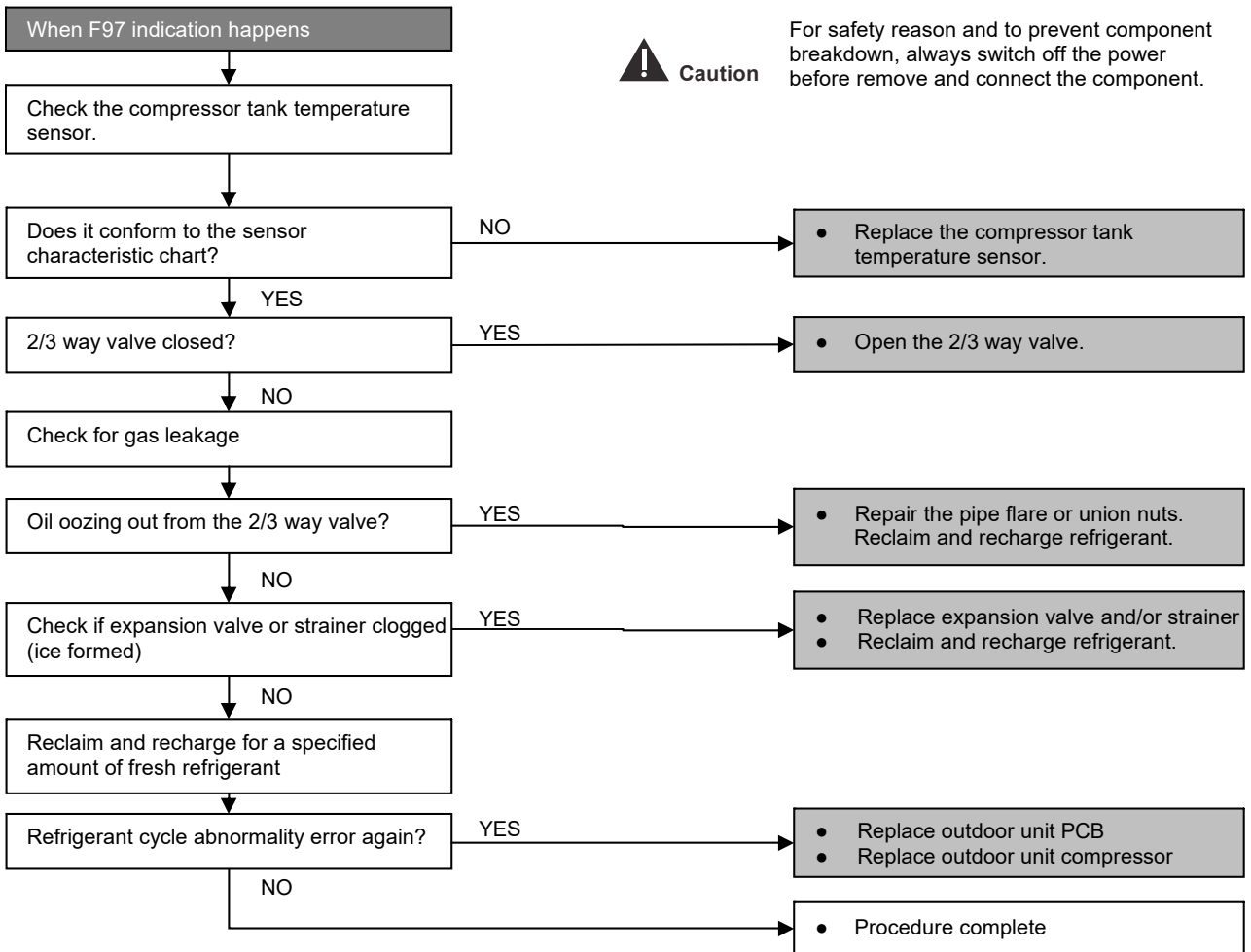

## 16.2.22 F98 (Input Over Current Detection)

### Malfunction Decision Conditions

- During operation of cooling and heating, when an input over-current (X value in Total Running Current Control) is detected by checking the input current value being detected by current transformer (CT) with the compressor running.

### Malfunction Caused

- Excessive refrigerant.
- Faulty outdoor unit PCB.

### Troubleshooting

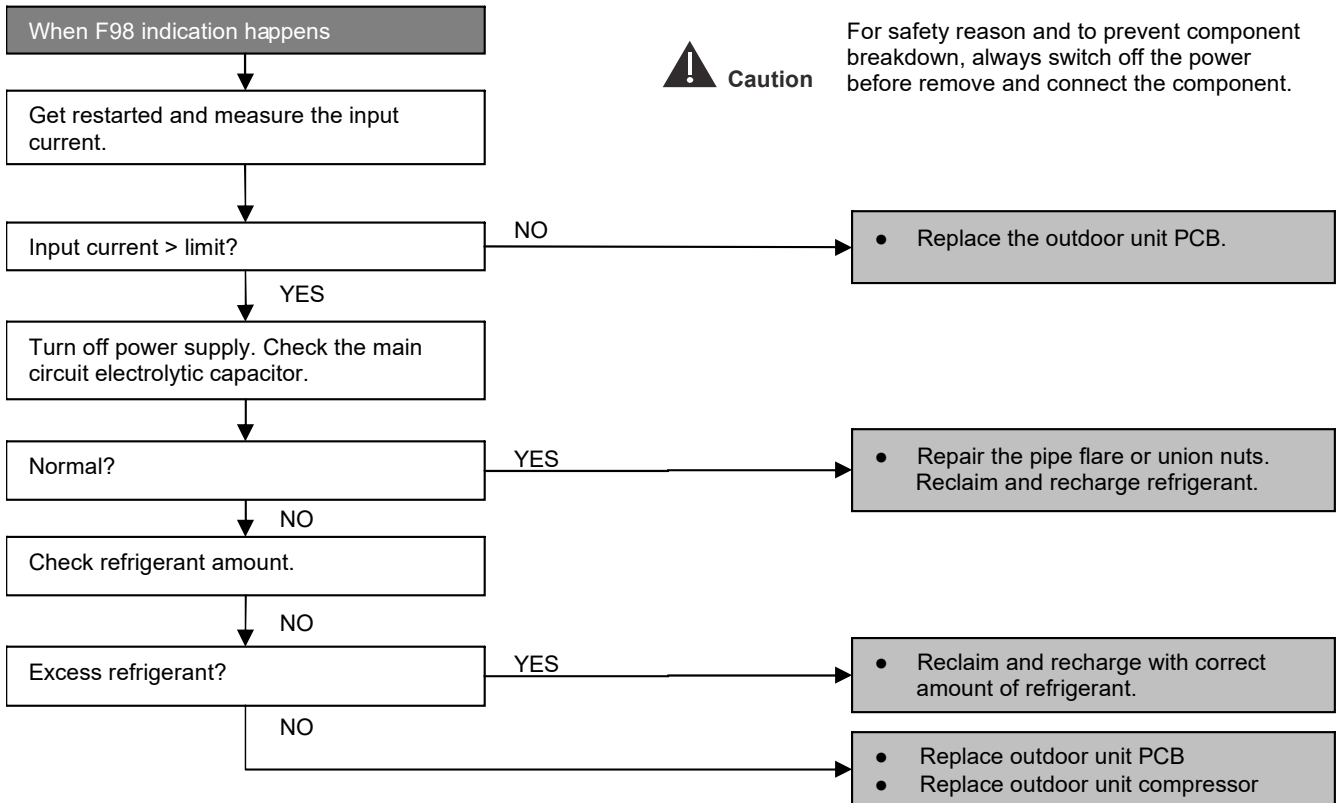

## 16.2.23 F99 (DC Peak Detection)

### Malfunction Decision Conditions

During startup and operation of cooling and heating, when inverter DC peak data is received by the outdoor internal DC Peak sensing circuitry.

### Malfunction Caused

- DC current peak due to compressor failure.
- DC current peak due to defective power transistor(s).
- DC current peak due to defective outdoor unit PCB.
- DC current peak due to short circuit.

### Troubleshooting

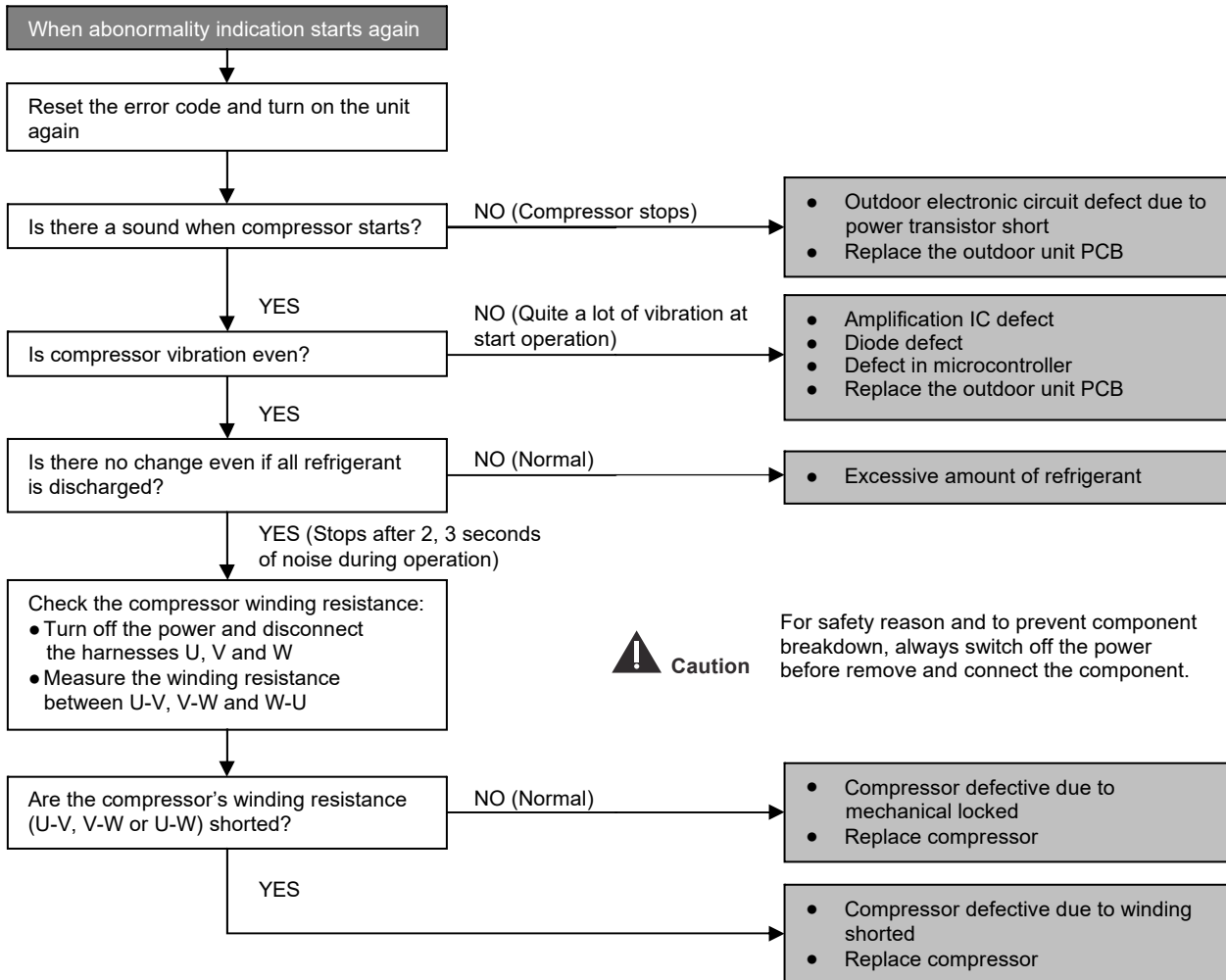

## 17. Disassembly and Assembly Instructions

### WARNING

High Voltage is generated in the electrical parts area by the capacitor. Ensure that the capacitor has discharged sufficiently before proceeding with repair work. Failure to heed this caution may result in electric shocks.

### 17.1 Outdoor Unit Removal Procedure

 Caution! When handling electronic controller, be careful of electrostatic discharge.

#### 17.1.1 Removing the Cabinet Top Plate

1. Remove the cabinet top plate (remove the 11 screws).



Fig. 1

#### 17.1.2 Remove the Control Board Cover and Particular Plates

2. Remove the control board cover (remove the 5 screws).



Fig. 2

3. Remove the particular plate (remove the 3 screws).



Fig. 3

4. Remove the particular plate (remove the 8 screws).



Fig. 4

### 17.1.3 Removing the Cabinet Front Plate

5. Remove the cabinet front plate (remove the 7 screws).



Fig. 5

### 17.1.4 Removing the Control P.C. Board

6. Remove the cover by release the screw.

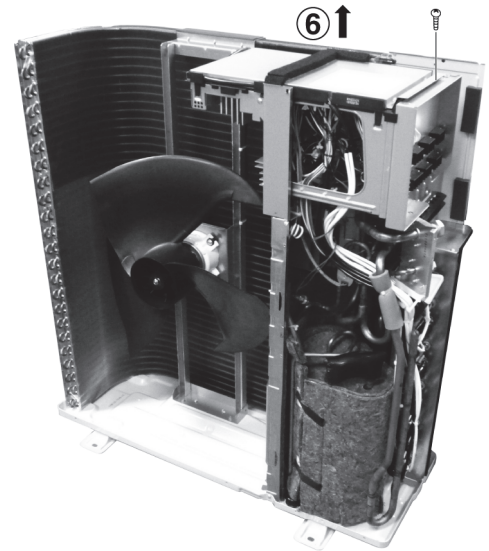

Fig. 6

7. Disconnect the connectors (lead wires of the compressor, sensors, and others).
8. Release the Control P.C. Board tab to remove the Control P.C. Board.

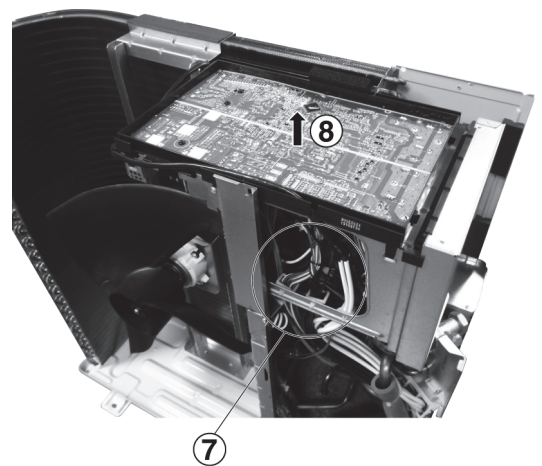

Fig. 7

### 17.1.5 Removing the Propeller Fan and Fan Motor

9. Remove the propeller fan by removing the nut turning clockwise as its center.
10. Disconnect the fan motor connector from the Control P.C. Board. Loosen the 4 fan motor mounting screws then remove the fan motor.

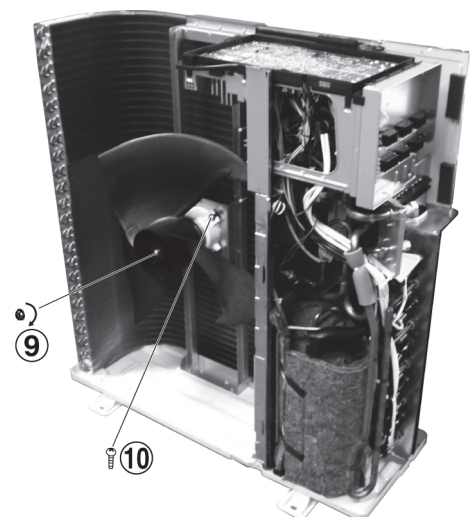

Fig. 8

## 18. Technical Data

Technical data provided are based on the air conditioner running under free frequency.

### 18.1 Cool Mode Performance Data

Unit setting: Standard piping length, Hi Fan, Cool mode at 16°C

Voltage: 230V, 50Hz

#### 18.1.1 CU-4Z80TBE

Combination (Capacity)	Outdoor Air Temp. °C DB	Indoor Air Temp. °C											
		27/16		27/17.5		27/18		27/19		27/22		27/24	
		Total Q	Input Power	Total Q	Input Power	Total Q	Input Power	Total Q	Input Power	Total Q	Input Power	Total Q	Input Power
1.6	22	2.15	0.35	2.17	0.33	2.18	0.33	2.20	0.32	2.73	0.35	3.09	0.38
	25	2.21	0.43	2.24	0.41	2.25	0.41	2.27	0.40	2.76	0.43	3.09	0.45
	29	2.23	0.56	2.27	0.53	2.29	0.52	2.31	0.49	2.75	0.53	3.04	0.55
	32	2.22	0.63	2.27	0.60	2.29	0.59	2.32	0.57	2.71	0.60	2.97	0.62
	35	2.18	0.69	2.24	0.66	2.26	0.66	2.30	0.64	2.65	0.66	2.88	0.67
	40	2.08	0.79	2.14	0.77	2.16	0.76	2.20	0.75	2.48	0.76	2.66	0.76
	43	1.98	0.83	2.05	0.83	2.07	0.83	2.11	0.83	2.34	0.82	2.49	0.81
	46	1.87	0.88	1.93	0.88	1.95	0.88	1.99	0.88	2.17	0.86	2.29	0.85
2.0	22	2.71	0.44	2.74	0.42	2.75	0.41	2.77	0.40	3.45	0.45	3.90	0.48
	25	2.79	0.54	2.82	0.52	2.84	0.52	2.86	0.50	3.48	0.55	3.90	0.57
	29	2.81	0.71	2.86	0.67	2.88	0.65	2.92	0.63	3.47	0.67	3.83	0.70
	32	2.80	0.80	2.86	0.76	2.88	0.75	2.93	0.72	3.42	0.75	3.75	0.78
	35	2.75	0.87	2.82	0.84	2.85	0.83	2.90	0.81	3.34	0.83	3.63	0.85
	40	2.63	0.99	2.70	0.97	2.73	0.97	2.78	0.95	3.12	0.96	3.35	0.96
	43	2.50	1.05	2.58	1.05	2.61	1.05	2.66	1.05	2.95	1.03	3.14	1.03
	46	2.35	1.12	2.43	1.12	2.45	1.12	2.50	1.12	2.73	1.09	2.88	1.08
2.5	22	2.71	0.44	2.74	0.42	2.75	0.41	2.77	0.40	3.45	0.45	3.90	0.48
	25	2.79	0.54	2.82	0.52	2.84	0.52	2.86	0.50	3.48	0.55	3.90	0.57
	29	2.81	0.71	2.86	0.67	2.88	0.65	2.92	0.63	3.47	0.67	3.83	0.70
	32	2.80	0.80	2.86	0.76	2.88	0.75	2.93	0.72	3.42	0.75	3.75	0.78
	35	2.75	0.87	2.82	0.84	2.85	0.83	2.90	0.81	3.34	0.83	3.63	0.85
	40	2.63	0.99	2.70	0.97	2.73	0.97	2.78	0.95	3.12	0.96	3.35	0.96
	43	2.50	1.05	2.58	1.05	2.61	1.05	2.66	1.05	2.95	1.03	3.14	1.03
	46	2.35	1.12	2.43	1.12	2.45	1.12	2.50	1.12	2.73	1.09	2.88	1.08
3.5	22	3.83	0.74	3.87	0.71	3.89	0.69	3.91	0.67	4.87	0.75	5.51	0.81
	25	3.94	0.91	3.99	0.88	4.01	0.87	4.05	0.84	4.93	0.92	5.51	0.96
	29	3.97	1.19	4.05	1.12	4.07	1.10	4.13	1.05	4.90	1.12	5.42	1.17
	32	3.95	1.34	4.05	1.27	4.08	1.25	4.14	1.21	4.83	1.27	5.30	1.31
	35	3.89	1.46	3.99	1.41	4.03	1.39	4.10	1.36	4.72	1.40	5.13	1.43
	40	3.71	1.67	3.82	1.64	3.86	1.62	3.93	1.60	4.41	1.61	4.74	1.62
	43	3.53	1.76	3.65	1.76	3.69	1.76	3.77	1.76	4.17	1.74	4.43	1.72
	46	3.33	1.88	3.43	1.88	3.47	1.88	3.54	1.88	3.86	1.84	4.07	1.81



Combination (Capacity)	Outdoor Air Temp. °C DB	Indoor Air Temp. °C											
		27/16		27/17.5		27/18		27/19		27/22		27/24	
		Total Q	Input Power	Total Q	Input Power	Total Q	Input Power	Total Q	Input Power	Total Q	Input Power	Total Q	Input Power
4.2	22	4.21	1.08	4.25	1.03	4.27	1.02	4.30	0.98	5.35	1.10	6.05	1.18
	25	4.32	1.34	4.38	1.28	4.40	1.27	4.44	1.23	5.41	1.34	6.05	1.41
	29	4.35	1.74	4.44	1.64	4.47	1.60	4.53	1.54	5.38	1.64	5.95	1.71
	32	4.34	1.96	4.44	1.86	4.48	1.83	4.54	1.76	5.31	1.85	5.81	1.91
	35	4.27	2.14	4.38	2.07	4.42	2.04	4.50	1.99	5.18	2.05	5.63	2.09
	40	4.08	2.44	4.19	2.39	4.23	2.38	4.31	2.34	4.84	2.36	5.20	2.37
	43	3.87	2.57	4.00	2.57	4.05	2.57	4.13	2.57	4.57	2.54	4.87	2.52
	46	3.65	2.75	3.77	2.75	3.81	2.75	3.89	2.75	4.24	2.69	4.47	2.64
5.0	22	5.33	1.16	5.39	1.11	5.40	1.09	5.44	1.05	6.77	1.18	7.66	1.27
	25	5.48	1.43	5.55	1.38	5.58	1.36	5.63	1.32	6.85	1.43	7.66	1.51
	29	5.51	1.86	5.63	1.75	5.66	1.72	5.74	1.64	6.81	1.76	7.53	1.83
	32	5.50	2.10	5.63	2.00	5.67	1.96	5.76	1.89	6.72	1.98	7.37	2.05
	35	5.40	2.29	5.55	2.21	5.60	2.18	5.70	2.13	6.56	2.19	7.13	2.24
	40	5.16	2.62	5.31	2.56	5.36	2.54	5.46	2.51	6.14	2.52	6.59	2.53
	43	4.90	2.75	5.07	2.75	5.13	2.75	5.24	2.75	5.79	2.72	6.16	2.70
	46	4.63	2.94	4.77	2.94	4.82	2.94	4.92	2.94	5.37	2.87	5.66	2.83
6.0	22	5.80	1.27	5.86	1.21	5.88	1.19	5.92	1.15	7.37	1.29	8.33	1.39
	25	5.96	1.56	6.04	1.50	6.07	1.48	6.12	1.45	7.45	1.57	8.33	1.65
	29	6.00	2.04	6.12	1.92	6.16	1.88	6.24	1.80	7.41	1.92	8.19	2.01
	32	5.98	2.30	6.12	2.18	6.17	2.14	6.26	2.06	7.31	2.17	8.01	2.24
	35	5.88	2.51	6.04	2.42	6.09	2.39	6.20	2.33	7.13	2.40	7.75	2.45
	40	5.62	2.86	5.78	2.80	5.83	2.78	5.94	2.74	6.68	2.76	7.17	2.77
	43	5.33	3.01	5.52	3.01	5.58	3.01	5.70	3.01	6.30	2.97	6.70	2.95
	46	5.03	3.21	5.19	3.21	5.25	3.21	5.35	3.21	5.84	3.14	6.16	3.10
7.1	22	6.73	1.51	6.80	1.44	6.83	1.41	6.87	1.37	8.56	1.54	9.68	1.65
	25	6.92	1.86	7.01	1.79	7.04	1.76	7.11	1.72	8.65	1.87	9.68	1.96
	29	6.97	2.42	7.11	2.28	7.15	2.23	7.25	2.14	8.61	2.29	9.51	2.38
	32	6.94	2.73	7.11	2.59	7.16	2.55	7.27	2.45	8.49	2.58	9.30	2.66
	35	6.83	2.98	7.01	2.88	7.08	2.84	7.20	2.77	8.28	2.85	9.00	2.91
	40	6.52	3.40	6.71	3.33	6.77	3.31	6.90	3.26	7.75	3.28	8.32	3.30
	43	6.19	3.58	6.41	3.58	6.48	3.58	6.62	3.58	7.32	3.53	7.78	3.51
	46	5.84	3.82	6.03	3.82	6.09	3.82	6.22	3.82	6.78	3.74	7.15	3.68
1.6 + 1.6	22	4.04	0.63	4.13	0.63	4.16	0.63	4.23	0.63	5.84	1.02	6.91	1.27
	25	4.61	1.07	4.73	1.05	4.77	1.05	4.85	1.04	6.05	1.28	6.86	1.45
	29	5.16	1.54	5.29	1.52	5.34	1.51	5.43	1.49	6.20	1.60	6.72	1.67
	32	5.40	1.81	5.55	1.79	5.60	1.78	5.69	1.77	6.94	1.80	7.78	1.81
	35	5.49	2.02	5.65	2.01	5.70	2.00	5.80	1.99	6.16	1.96	6.39	1.94
	40	5.34	2.12	5.49	2.13	5.54	2.13	5.65	2.13	5.57	2.08	5.74	2.06
	43	5.05	2.12	5.20	2.16	5.25	2.18	5.35	2.21	5.45	2.16	5.51	2.15
	46	4.60	2.07	4.75	2.15	4.80	2.18	4.91	2.21	5.20	2.22	5.40	2.23

Combination (Capacity)	Outdoor Air Temp. °C DB	Indoor Air Temp. °C											
		27/16		27/17.5		27/18		27/19		27/22		27/24	
		Total Q	Input Power	Total Q	Input Power	Total Q	Input Power	Total Q	Input Power	Total Q	Input Power	Total Q	Input Power
1.6 + 2.0	22	4.04	0.63	4.13	0.63	4.16	0.63	4.23	0.63	5.84	1.02	6.91	1.27
	25	4.61	1.07	4.73	1.05	4.77	1.05	4.85	1.04	6.05	1.28	6.86	1.45
	29	5.16	1.54	5.29	1.52	5.34	1.51	5.43	1.49	6.20	1.60	6.72	1.67
	32	5.40	1.81	5.55	1.79	5.60	1.78	5.69	1.77	6.94	1.80	7.78	1.81
	35	5.49	2.02	5.65	2.01	5.70	2.00	5.80	1.99	6.16	1.96	6.39	1.94
	40	5.34	2.12	5.49	2.13	5.54	2.13	5.65	2.13	5.57	2.08	5.74	2.06
	43	5.05	2.12	5.20	2.16	5.25	2.18	5.35	2.21	5.45	2.16	5.51	2.15
	46	4.60	2.07	4.75	2.15	4.80	2.18	4.91	2.21	5.20	2.22	5.40	2.23
1.6 + 2.5	22	4.04	0.63	4.13	0.63	4.16	0.63	4.23	0.63	5.84	1.02	6.91	1.27
	25	4.61	1.07	4.73	1.05	4.77	1.05	4.85	1.04	6.05	1.28	6.86	1.45
	29	5.16	1.54	5.29	1.52	5.34	1.51	5.43	1.49	6.20	1.60	6.72	1.67
	32	5.40	1.81	5.55	1.79	5.60	1.78	5.69	1.77	6.94	1.80	7.78	1.81
	35	5.49	2.02	5.65	2.01	5.70	2.00	5.80	1.99	6.16	1.96	6.39	1.94
	40	5.34	2.12	5.49	2.13	5.54	2.13	5.65	2.13	5.57	2.08	5.74	2.06
	43	5.05	2.12	5.20	2.16	5.25	2.18	5.35	2.21	5.45	2.16	5.51	2.15
	46	4.60	2.07	4.75	2.15	4.80	2.18	4.91	2.21	5.20	2.22	5.40	2.23
1.6 + 3.5	22	4.04	0.61	4.13	0.61	4.16	0.61	4.23	0.61	5.84	0.98	6.91	1.23
	25	4.61	1.03	4.73	1.02	4.77	1.01	4.85	1.00	6.05	1.24	6.86	1.40
	29	5.16	1.49	5.29	1.46	5.34	1.46	5.43	1.44	6.20	1.54	6.72	1.61
	32	5.40	1.75	5.55	1.73	5.60	1.72	5.69	1.71	6.94	1.73	7.78	1.75
	35	5.49	1.95	5.65	1.93	5.70	1.93	5.80	1.92	6.16	1.89	6.39	1.88
	40	5.34	2.04	5.49	2.05	5.54	2.05	5.65	2.06	5.57	2.00	5.74	1.98
	43	5.05	2.04	5.20	2.09	5.25	2.10	5.35	2.13	5.45	2.09	5.51	2.08
	46	4.60	2.00	4.75	2.07	4.80	2.10	4.91	2.13	5.20	2.14	5.40	2.15
1.6 + 4.2	22	4.67	0.79	4.77	0.79	4.81	0.79	4.88	0.79	6.74	1.27	7.99	1.59
	25	5.32	1.33	5.46	1.31	5.51	1.30	5.60	1.29	6.99	1.60	7.92	1.81
	29	5.96	1.92	6.11	1.89	6.17	1.88	6.27	1.86	7.17	1.99	7.76	2.08
	32	6.24	2.26	6.41	2.23	6.46	2.22	6.58	2.20	8.02	2.24	8.98	2.26
	35	6.35	2.52	6.52	2.50	6.58	2.49	6.70	2.48	7.11	2.45	7.39	2.42
	40	6.17	2.64	6.35	2.65	6.40	2.65	6.52	2.66	6.43	2.59	6.63	2.56
	43	5.83	2.64	6.01	2.70	6.07	2.72	6.18	2.76	6.30	2.70	6.37	2.68
	46	5.31	2.58	5.49	2.68	5.55	2.71	5.67	2.75	6.01	2.76	6.24	2.78
1.6 + 5.0	22	5.02	0.79	5.13	0.79	5.17	0.79	5.25	0.79	7.25	1.27	8.58	1.59
	25	5.72	1.33	5.87	1.31	5.92	1.30	6.02	1.29	7.52	1.60	8.52	1.81
	29	6.41	1.92	6.57	1.89	6.63	1.88	6.74	1.86	7.70	1.99	8.34	2.08
	32	6.70	2.26	6.89	2.23	6.95	2.22	7.07	2.20	8.62	2.24	9.66	2.26
	35	6.82	2.52	7.01	2.50	7.07	2.49	7.20	2.48	7.64	2.45	7.94	2.42
	40	6.63	2.64	6.82	2.65	6.88	2.65	7.01	2.66	6.91	2.59	7.13	2.56
	43	6.26	2.64	6.46	2.70	6.52	2.72	6.65	2.76	6.77	2.70	6.84	2.68
	46	5.71	2.58	5.90	2.68	5.96	2.71	6.09	2.75	6.46	2.76	6.70	2.78

Combination (Capacity)	Outdoor Air Temp. °C DB	Indoor Air Temp. °C											
		27/16		27/17.5		27/18		27/19		27/22		27/24	
		Total Q	Input Power	Total Q	Input Power	Total Q	Input Power	Total Q	Input Power	Total Q	Input Power	Total Q	Input Power
1.6 + 6.0	22	5.92	1.11	6.06	1.11	6.10	1.11	6.19	1.11	8.56	1.78	10.13	2.23
	25	6.75	1.87	6.93	1.85	6.99	1.84	7.10	1.82	8.87	2.25	10.05	2.54
	29	7.56	2.70	7.76	2.66	7.82	2.65	7.95	2.62	9.09	2.81	9.85	2.93
	32	7.91	3.18	8.13	3.14	8.20	3.13	8.34	3.10	10.18	3.15	11.40	3.18
	35	8.05	3.54	8.28	3.52	8.35	3.51	8.50	3.49	9.02	3.44	9.37	3.41
	40	7.83	3.72	8.05	3.73	8.13	3.73	8.28	3.74	8.16	3.64	8.42	3.60
	43	7.40	3.72	7.62	3.80	7.70	3.82	7.85	3.88	7.99	3.80	8.08	3.78
	46	6.74	3.64	6.97	3.77	7.04	3.81	7.19	3.87	7.62	3.89	7.91	3.91
1.6 + 7.1	22	5.92	1.06	6.06	1.06	6.10	1.06	6.19	1.06	8.56	1.71	10.13	2.14
	25	6.75	1.79	6.93	1.77	6.99	1.76	7.10	1.74	8.87	2.16	10.05	2.43
	29	7.56	2.58	7.76	2.55	7.82	2.53	7.95	2.51	9.09	2.68	9.85	2.80
	32	7.91	3.05	8.13	3.01	8.20	2.99	8.34	2.97	10.18	3.01	11.40	3.05
	35	8.05	3.39	8.28	3.37	8.35	3.36	8.50	3.34	9.02	3.29	9.37	3.26
	40	7.83	3.56	8.05	3.57	8.13	3.57	8.28	3.58	8.16	3.48	8.42	3.45
	43	7.40	3.56	7.62	3.63	7.70	3.66	7.85	3.71	7.99	3.63	8.08	3.62
	46	6.74	3.48	6.97	3.61	7.04	3.65	7.19	3.70	7.62	3.72	7.91	3.74
2.0 + 2.0	22	4.04	0.61	4.13	0.61	4.16	0.61	4.23	0.61	5.84	0.99	6.91	1.23
	25	4.61	1.04	4.73	1.02	4.77	1.02	4.85	1.01	6.05	1.25	6.86	1.40
	29	5.16	1.49	5.29	1.47	5.34	1.46	5.43	1.45	6.20	1.55	6.72	1.62
	32	5.40	1.76	5.55	1.74	5.60	1.73	5.69	1.72	6.94	1.74	7.78	1.76
	35	5.49	1.96	5.65	1.94	5.70	1.94	5.80	1.93	6.16	1.90	6.39	1.89
	40	5.34	2.06	5.49	2.06	5.54	2.07	5.65	2.07	5.57	2.01	5.74	1.99
	43	5.05	2.06	5.20	2.10	5.25	2.11	5.35	2.14	5.45	2.10	5.51	2.09
	46	4.60	2.01	4.75	2.08	4.80	2.11	4.91	2.14	5.20	2.15	5.40	2.16
2.0 + 2.5	22	4.04	0.61	4.13	0.61	4.16	0.61	4.23	0.61	5.84	0.99	6.91	1.23
	25	4.61	1.04	4.73	1.02	4.77	1.02	4.85	1.01	6.05	1.25	6.86	1.40
	29	5.16	1.49	5.29	1.47	5.34	1.46	5.43	1.45	6.20	1.55	6.72	1.62
	32	5.40	1.76	5.55	1.74	5.60	1.73	5.69	1.72	6.94	1.74	7.78	1.76
	35	5.49	1.96	5.65	1.94	5.70	1.94	5.80	1.93	6.16	1.90	6.39	1.89
	40	5.34	2.06	5.49	2.06	5.54	2.07	5.65	2.07	5.57	2.01	5.74	1.99
	43	5.05	2.06	5.20	2.10	5.25	2.11	5.35	2.14	5.45	2.10	5.51	2.09
	46	4.60	2.01	4.75	2.08	4.80	2.11	4.91	2.14	5.20	2.15	5.40	2.16
2.0 + 3.5	22	4.04	0.59	4.13	0.59	4.16	0.59	4.23	0.59	5.84	0.95	6.91	1.19
	25	4.61	1.00	4.73	0.98	4.77	0.98	4.85	0.97	6.05	1.20	6.86	1.35
	29	5.16	1.44	5.29	1.42	5.34	1.41	5.43	1.40	6.20	1.50	6.72	1.56
	32	5.40	1.70	5.55	1.67	5.60	1.67	5.69	1.65	6.94	1.68	7.78	1.70
	35	5.49	1.89	5.65	1.87	5.70	1.87	5.80	1.86	6.16	1.83	6.39	1.82
	40	5.34	1.98	5.49	1.99	5.54	1.99	5.65	2.00	5.57	1.94	5.74	1.92
	43	5.05	1.98	5.20	2.02	5.25	2.04	5.35	2.07	5.45	2.02	5.51	2.01
	46	4.60	1.94	4.75	2.01	4.80	2.03	4.91	2.06	5.20	2.07	5.40	2.08

Combination (Capacity)	Outdoor Air Temp. °C DB	Indoor Air Temp. °C											
		27/16		27/17.5		27/18		27/19		27/22		27/24	
		Total Q	Input Power	Total Q	Input Power	Total Q	Input Power	Total Q	Input Power	Total Q	Input Power	Total Q	Input Power
2.0 + 4.2	22	5.02	0.92	5.13	0.92	5.17	0.92	5.25	0.92	7.25	1.48	8.58	1.86
	25	5.72	1.56	5.87	1.53	5.92	1.53	6.02	1.51	7.52	1.87	8.52	2.11
	29	6.41	2.24	6.57	2.21	6.63	2.20	6.74	2.18	7.70	2.33	8.34	2.43
	32	6.70	2.64	6.89	2.61	6.95	2.60	7.07	2.58	8.62	2.62	9.66	2.64
	35	6.82	2.94	7.01	2.92	7.07	2.91	7.20	2.90	7.64	2.86	7.94	2.83
	40	6.63	3.09	6.82	3.10	6.88	3.10	7.01	3.11	6.91	3.02	7.13	3.00
	43	6.26	3.09	6.46	3.16	6.52	3.18	6.65	3.22	6.77	3.16	6.84	3.14
	46	5.71	3.02	5.90	3.13	5.96	3.17	6.09	3.21	6.46	3.23	6.70	3.25
2.0 + 5.0	22	5.64	0.99	5.77	0.99	5.82	0.99	5.90	0.99	8.15	1.58	9.65	1.98
	25	6.43	1.66	6.60	1.64	6.66	1.63	6.77	1.62	8.46	2.00	9.58	2.26
	29	7.21	2.40	7.39	2.36	7.45	2.35	7.58	2.33	8.66	2.49	9.38	2.60
	32	7.54	2.83	7.75	2.79	7.81	2.78	7.95	2.76	9.70	2.80	10.86	2.83
	35	7.67	3.15	7.89	3.12	7.96	3.12	8.10	3.10	8.60	3.06	8.93	3.03
	40	7.46	3.30	7.67	3.31	7.74	3.32	7.89	3.33	7.78	3.23	8.02	3.20
	43	7.05	3.30	7.26	3.37	7.33	3.40	7.48	3.44	7.61	3.37	7.70	3.36
	46	6.42	3.23	6.64	3.35	6.71	3.39	6.85	3.44	7.27	3.45	7.54	3.47
2.0 + 6.0	22	5.92	1.11	6.06	1.11	6.10	1.11	6.19	1.11	8.56	1.78	10.13	2.23
	25	6.75	1.87	6.93	1.85	6.99	1.84	7.10	1.82	8.87	2.25	10.05	2.54
	29	7.56	2.70	7.76	2.66	7.82	2.65	7.95	2.62	9.09	2.81	9.85	2.93
	32	7.91	3.18	8.13	3.14	8.20	3.13	8.34	3.10	10.18	3.15	11.40	3.18
	35	8.05	3.54	8.28	3.52	8.35	3.51	8.50	3.49	9.02	3.44	9.37	3.41
	40	7.83	3.72	8.05	3.73	8.13	3.73	8.28	3.74	8.16	3.64	8.42	3.60
	43	7.40	3.72	7.62	3.80	7.70	3.82	7.85	3.88	7.99	3.80	8.08	3.78
	46	6.74	3.64	6.97	3.77	7.04	3.81	7.19	3.87	7.62	3.89	7.91	3.91
2.0 + 7.1	22	5.92	1.06	6.06	1.06	6.10	1.06	6.19	1.06	8.56	1.71	10.13	2.14
	25	6.75	1.79	6.93	1.77	6.99	1.76	7.10	1.74	8.87	2.16	10.05	2.43
	29	7.56	2.58	7.76	2.55	7.82	2.53	7.95	2.51	9.09	2.68	9.85	2.80
	32	7.91	3.05	8.13	3.01	8.20	2.99	8.34	2.97	10.18	3.01	11.40	3.05
	35	8.05	3.39	8.28	3.37	8.35	3.36	8.50	3.34	9.02	3.29	9.37	3.26
	40	7.83	3.56	8.05	3.57	8.13	3.57	8.28	3.58	8.16	3.48	8.42	3.45
	43	7.40	3.56	7.62	3.63	7.70	3.66	7.85	3.71	7.99	3.63	8.08	3.62
	46	6.74	3.48	6.97	3.61	7.04	3.65	7.19	3.70	7.62	3.72	7.91	3.74
2.5 + 2.5	22	4.04	0.61	4.13	0.61	4.16	0.61	4.23	0.61	5.84	0.99	6.91	1.23
	25	4.61	1.04	4.73	1.02	4.77	1.02	4.85	1.01	6.05	1.25	6.86	1.40
	29	5.16	1.49	5.29	1.47	5.34	1.46	5.43	1.45	6.20	1.55	6.72	1.62
	32	5.40	1.76	5.55	1.74	5.60	1.73	5.69	1.72	6.94	1.74	7.78	1.76
	35	5.49	1.96	5.65	1.94	5.70	1.94	5.80	1.93	6.16	1.90	6.39	1.89
	40	5.34	2.06	5.49	2.06	5.54	2.07	5.65	2.07	5.57	2.01	5.74	1.99
	43	5.05	2.06	5.20	2.10	5.25	2.11	5.35	2.14	5.45	2.10	5.51	2.09
	46	4.60	2.01	4.75	2.08	4.80	2.11	4.91	2.14	5.20	2.15	5.40	2.16

Combination (Capacity)	Outdoor Air Temp. °C DB	Indoor Air Temp. °C											
		27/16		27/17.5		27/18		27/19		27/22		27/24	
		Total Q	Input Power	Total Q	Input Power	Total Q	Input Power	Total Q	Input Power	Total Q	Input Power	Total Q	Input Power
2.5 + 3.5	22	4.67	0.79	4.77	0.79	4.81	0.79	4.88	0.79	6.74	1.27	7.99	1.59
	25	5.32	1.33	5.46	1.31	5.51	1.30	5.60	1.29	6.99	1.60	7.92	1.81
	29	5.96	1.92	6.11	1.89	6.17	1.88	6.27	1.86	7.17	1.99	7.76	2.08
	32	6.24	2.26	6.41	2.23	6.46	2.22	6.58	2.20	8.02	2.24	8.98	2.26
	35	6.35	2.52	6.52	2.50	6.58	2.49	6.70	2.48	7.11	2.45	7.39	2.42
	40	6.17	2.64	6.35	2.65	6.40	2.65	6.52	2.66	6.43	2.59	6.63	2.56
	43	5.83	2.64	6.01	2.70	6.07	2.72	6.18	2.76	6.30	2.70	6.37	2.68
	46	5.31	2.58	5.49	2.68	5.55	2.71	5.67	2.75	6.01	2.76	6.24	2.78
2.5 + 4.2	22	5.02	0.92	5.13	0.92	5.17	0.92	5.25	0.92	7.25	1.48	8.58	1.86
	25	5.72	1.56	5.87	1.53	5.92	1.53	6.02	1.51	7.52	1.87	8.52	2.11
	29	6.41	2.24	6.57	2.21	6.63	2.20	6.74	2.18	7.70	2.33	8.34	2.43
	32	6.70	2.64	6.89	2.61	6.95	2.60	7.07	2.58	8.62	2.62	9.66	2.64
	35	6.82	2.94	7.01	2.92	7.07	2.91	7.20	2.90	7.64	2.86	7.94	2.83
	40	6.63	3.09	6.82	3.10	6.88	3.10	7.01	3.11	6.91	3.02	7.13	3.00
	43	6.26	3.09	6.46	3.16	6.52	3.18	6.65	3.22	6.77	3.16	6.84	3.14
	46	5.71	3.02	5.90	3.13	5.96	3.17	6.09	3.21	6.46	3.23	6.70	3.25
2.5 + 5.0	22	5.92	1.11	6.06	1.11	6.10	1.11	6.19	1.11	8.56	1.78	10.13	2.23
	25	6.75	1.87	6.93	1.85	6.99	1.84	7.10	1.82	8.87	2.25	10.05	2.54
	29	7.56	2.70	7.76	2.66	7.82	2.65	7.95	2.62	9.09	2.81	9.85	2.93
	32	7.91	3.18	8.13	3.14	8.20	3.13	8.34	3.10	10.18	3.15	11.40	3.18
	35	8.05	3.54	8.28	3.52	8.35	3.51	8.50	3.49	9.02	3.44	9.37	3.41
	40	7.83	3.72	8.05	3.73	8.13	3.73	8.28	3.74	8.16	3.64	8.42	3.60
	43	7.40	3.72	7.62	3.80	7.70	3.82	7.85	3.88	7.99	3.80	8.08	3.78
	46	6.74	3.64	6.97	3.77	7.04	3.81	7.19	3.87	7.62	3.89	7.91	3.91
2.5 + 6.0	22	5.92	1.11	6.06	1.11	6.10	1.11	6.19	1.11	8.56	1.78	10.13	2.23
	25	6.75	1.87	6.93	1.85	6.99	1.84	7.10	1.82	8.87	2.25	10.05	2.54
	29	7.56	2.70	7.76	2.66	7.82	2.65	7.95	2.62	9.09	2.81	9.85	2.93
	32	7.91	3.18	8.13	3.14	8.20	3.13	8.34	3.10	10.18	3.15	11.40	3.18
	35	8.05	3.54	8.28	3.52	8.35	3.51	8.50	3.49	9.02	3.44	9.37	3.41
	40	7.83	3.72	8.05	3.73	8.13	3.73	8.28	3.74	8.16	3.64	8.42	3.60
	43	7.40	3.72	7.62	3.80	7.70	3.82	7.85	3.88	7.99	3.80	8.08	3.78
	46	6.74	3.64	6.97	3.77	7.04	3.81	7.19	3.87	7.62	3.89	7.91	3.91
2.5 + 7.1	22	5.92	1.06	6.06	1.06	6.10	1.06	6.19	1.06	8.56	1.71	10.13	2.14
	25	6.75	1.79	6.93	1.77	6.99	1.76	7.10	1.74	8.87	2.16	10.05	2.43
	29	7.56	2.58	7.76	2.55	7.82	2.53	7.95	2.51	9.09	2.68	9.85	2.80
	32	7.91	3.05	8.13	3.01	8.20	2.99	8.34	2.97	10.18	3.01	11.40	3.05
	35	8.05	3.39	8.28	3.37	8.35	3.36	8.50	3.34	9.02	3.29	9.37	3.26
	40	7.83	3.56	8.05	3.57	8.13	3.57	8.28	3.58	8.16	3.48	8.42	3.45
	43	7.40	3.56	7.62	3.63	7.70	3.66	7.85	3.71	7.99	3.63	8.08	3.62
	46	6.74	3.48	6.97	3.61	7.04	3.65	7.19	3.70	7.62	3.72	7.91	3.74

Combination (Capacity)	Outdoor Air Temp. °C DB	Indoor Air Temp. °C											
		27/16		27/17.5		27/18		27/19		27/22		27/24	
		Total Q	Input Power	Total Q	Input Power	Total Q	Input Power	Total Q	Input Power	Total Q	Input Power	Total Q	Input Power
3.5 + 3.5	22	5.64	1.15	5.77	1.15	5.82	1.15	5.90	1.15	8.15	1.86	9.65	2.32
	25	6.43	1.95	6.60	1.92	6.66	1.91	6.77	1.89	8.46	2.34	9.58	2.64
	29	7.21	2.81	7.39	2.77	7.45	2.75	7.58	2.73	8.66	2.92	9.38	3.05
	32	7.54	3.31	7.75	3.27	7.81	3.25	7.95	3.23	9.70	3.28	10.86	3.31
	35	7.67	3.69	7.89	3.66	7.96	3.65	8.10	3.63	8.60	3.58	8.93	3.55
	40	7.46	3.87	7.67	3.88	7.74	3.88	7.89	3.89	7.78	3.79	8.02	3.75
	43	7.05	3.87	7.26	3.95	7.33	3.98	7.48	4.03	7.61	3.95	7.70	3.93
	46	6.42	3.78	6.64	3.92	6.71	3.97	6.85	4.02	7.27	4.04	7.54	4.07
3.5 + 4.2	22	5.92	1.31	6.06	1.31	6.10	1.31	6.19	1.31	8.56	2.11	10.13	2.64
	25	6.75	2.21	6.93	2.18	6.99	2.17	7.10	2.15	8.87	2.66	10.05	3.00
	29	7.56	3.19	7.76	3.14	7.82	3.13	7.95	3.09	9.09	3.31	9.85	3.46
	32	7.91	3.76	8.13	3.71	8.20	3.69	8.34	3.66	10.18	3.72	11.40	3.76
	35	8.05	4.18	8.28	4.15	8.35	4.14	8.50	4.12	9.02	4.06	9.37	4.03
	40	7.65	4.33	7.91	4.33	7.99	4.33	8.08	4.33	7.99	4.30	7.99	4.26
	43	7.23	4.33	7.48	4.33	7.65	4.33	7.65	4.33	7.99	4.33	8.25	4.33
	46	6.55	4.33	6.80	4.33	6.89	4.33	7.06	4.33	7.48	4.33	7.74	4.33
3.5 + 5.0	22	5.92	1.06	6.06	1.06	6.10	1.06	6.19	1.06	8.56	1.71	10.13	2.14
	25	6.75	1.79	6.93	1.77	6.99	1.76	7.10	1.74	8.87	2.16	10.05	2.43
	29	7.56	2.58	7.76	2.55	7.82	2.53	7.95	2.51	9.09	2.68	9.85	2.80
	32	7.91	3.05	8.13	3.01	8.20	2.99	8.34	2.97	10.18	3.01	11.40	3.05
	35	8.05	3.39	8.28	3.37	8.35	3.36	8.50	3.34	9.02	3.29	9.37	3.26
	40	7.83	3.56	8.05	3.57	8.13	3.57	8.28	3.58	8.16	3.48	8.42	3.45
	43	7.40	3.56	7.62	3.63	7.70	3.66	7.85	3.71	7.99	3.63	8.08	3.62
	46	6.74	3.48	6.97	3.61	7.04	3.65	7.19	3.70	7.62	3.72	7.91	3.74
3.5 + 6.0	22	5.92	1.06	6.06	1.06	6.10	1.06	6.19	1.06	8.56	1.71	10.13	2.14
	25	6.75	1.79	6.93	1.77	6.99	1.76	7.10	1.74	8.87	2.16	10.05	2.43
	29	7.56	2.58	7.76	2.55	7.82	2.53	7.95	2.51	9.09	2.68	9.85	2.80
	32	7.91	3.05	8.13	3.01	8.20	2.99	8.34	2.97	10.18	3.01	11.40	3.05
	35	8.05	3.39	8.28	3.37	8.35	3.36	8.50	3.34	9.02	3.29	9.37	3.26
	40	7.83	3.56	8.05	3.57	8.13	3.57	8.28	3.58	8.16	3.48	8.42	3.45
	43	7.40	3.56	7.62	3.63	7.70	3.66	7.85	3.71	7.99	3.63	8.08	3.62
	46	6.74	3.48	6.97	3.61	7.04	3.65	7.19	3.70	7.62	3.72	7.91	3.74
3.5 + 7.1	22	5.99	1.06	6.13	1.06	6.17	1.06	6.27	1.06	8.66	1.71	10.25	2.14
	25	6.83	1.79	7.01	1.77	7.07	1.76	7.19	1.74	8.98	2.16	10.17	2.43
	29	7.65	2.58	7.85	2.55	7.91	2.53	8.05	2.51	9.20	2.68	9.96	2.80
	32	8.01	3.05	8.22	3.01	8.30	2.99	8.44	2.97	10.30	3.01	11.53	3.05
	35	8.15	3.39	8.37	3.37	8.45	3.36	8.60	3.34	9.13	3.29	9.48	3.26
	40	7.92	3.56	8.15	3.57	8.22	3.57	8.37	3.58	8.26	3.48	8.51	3.45
	43	7.48	3.56	7.71	3.63	7.79	3.66	7.94	3.71	8.08	3.63	8.17	3.62
	46	6.82	3.48	7.05	3.61	7.12	3.65	7.28	3.70	7.71	3.72	8.01	3.74

Combination (Capacity)	Outdoor Air Temp. °C DB	Indoor Air Temp. °C											
		27/16		27/17.5		27/18		27/19		27/22		27/24	
		Total Q	Input Power	Total Q	Input Power	Total Q	Input Power	Total Q	Input Power	Total Q	Input Power	Total Q	Input Power
4.2 + 4.2	22	5.92	1.28	6.06	1.28	6.10	1.28	6.19	1.28	8.56	2.06	10.13	2.58
	25	6.75	2.17	6.93	2.14	6.99	2.13	7.10	2.11	8.87	2.61	10.05	2.94
	29	7.56	3.13	7.76	3.08	7.82	3.06	7.95	3.03	9.09	3.25	9.85	3.39
	32	7.91	3.68	8.13	3.64	8.20	3.62	8.34	3.59	10.18	3.65	11.40	3.68
	35	8.05	4.10	8.28	4.07	8.35	4.06	8.50	4.04	9.02	3.98	9.37	3.95
	40	7.83	4.30	8.05	4.32	8.13	4.32	8.28	4.33	8.01	4.21	7.83	4.17
	43	7.40	4.30	7.48	4.33	7.65	4.33	7.65	4.33	7.99	4.33	8.25	4.33
	46	6.74	4.21	6.80	4.33	6.89	4.33	7.06	4.33	7.48	4.33	7.74	4.33
4.2 + 5.0	22	5.92	1.06	6.06	1.06	6.10	1.06	6.19	1.06	8.56	1.71	10.13	2.14
	25	6.75	1.79	6.93	1.77	6.99	1.76	7.10	1.74	8.87	2.16	10.05	2.43
	29	7.56	2.58	7.76	2.55	7.82	2.53	7.95	2.51	9.09	2.68	9.85	2.80
	32	7.91	3.05	8.13	3.01	8.20	2.99	8.34	2.97	10.18	3.01	11.40	3.05
	35	8.05	3.39	8.28	3.37	8.35	3.36	8.50	3.34	9.02	3.29	9.37	3.26
	40	7.83	3.56	8.05	3.57	8.13	3.57	8.28	3.58	8.16	3.48	8.42	3.45
	43	7.40	3.56	7.62	3.63	7.70	3.66	7.85	3.71	7.99	3.63	8.08	3.62
	46	6.74	3.48	6.97	3.61	7.04	3.65	7.19	3.70	7.62	3.72	7.91	3.74
4.2 + 6.0	22	5.99	1.09	6.13	1.09	6.17	1.09	6.27	1.09	8.66	1.75	10.25	2.19
	25	6.83	1.83	7.01	1.81	7.07	1.80	7.19	1.78	8.98	2.21	10.17	2.49
	29	7.65	2.65	7.85	2.61	7.91	2.59	8.05	2.57	9.20	2.75	9.96	2.87
	32	8.01	3.12	8.22	3.08	8.30	3.07	8.44	3.04	10.30	3.09	11.53	3.12
	35	8.15	3.47	8.37	3.45	8.45	3.44	8.60	3.42	9.13	3.37	9.48	3.34
	40	7.92	3.64	8.15	3.66	8.22	3.66	8.37	3.67	8.26	3.57	8.51	3.53
	43	7.48	3.64	7.71	3.72	7.79	3.75	7.94	3.80	8.08	3.72	8.17	3.70
	46	6.82	3.56	7.05	3.69	7.12	3.74	7.28	3.79	7.71	3.81	8.01	3.83
4.2 + 7.1	22	5.99	1.04	6.13	1.04	6.17	1.04	6.27	1.04	8.66	1.67	10.25	2.09
	25	6.83	1.75	7.01	1.72	7.07	1.72	7.19	1.70	8.98	2.10	10.17	2.37
	29	7.65	2.52	7.85	2.49	7.91	2.47	8.05	2.45	9.20	2.62	9.96	2.74
	32	8.01	2.97	8.22	2.94	8.30	2.92	8.44	2.90	10.30	2.94	11.53	2.97
	35	8.15	3.31	8.37	3.28	8.45	3.28	8.60	3.26	9.13	3.22	9.48	3.19
	40	7.92	3.47	8.15	3.48	8.22	3.49	8.37	3.50	8.26	3.40	8.51	3.37
	43	7.48	3.47	7.71	3.55	7.79	3.57	7.94	3.62	8.08	3.55	8.17	3.53
	46	6.82	3.40	7.05	3.52	7.12	3.56	7.28	3.61	7.71	3.63	8.01	3.65
5.0 + 5.0	22	5.99	0.94	6.13	0.94	6.17	0.94	6.27	0.94	8.66	1.51	10.25	1.89
	25	6.83	1.58	7.01	1.56	7.07	1.55	7.19	1.54	8.98	1.90	10.17	2.15
	29	7.65	2.28	7.85	2.25	7.91	2.24	8.05	2.22	9.20	2.37	9.96	2.48
	32	8.01	2.69	8.22	2.66	8.30	2.64	8.44	2.62	10.30	2.66	11.53	2.69
	35	8.15	3.00	8.37	2.97	8.45	2.97	8.60	2.95	9.13	2.91	9.48	2.88
	40	7.92	3.14	8.15	3.15	8.22	3.16	8.37	3.16	8.26	3.08	8.51	3.05
	43	7.48	3.14	7.71	3.21	7.79	3.23	7.94	3.28	8.08	3.21	8.17	3.19
	46	6.82	3.07	7.05	3.19	7.12	3.22	7.28	3.27	7.71	3.29	8.01	3.31

Combination (Capacity)	Outdoor Air Temp. °C DB	Indoor Air Temp. °C											
		27/16		27/17.5		27/18		27/19		27/22		27/24	
		Total Q	Input Power	Total Q	Input Power	Total Q	Input Power	Total Q	Input Power	Total Q	Input Power	Total Q	Input Power
5.0 + 6.0	22	5.99	0.94	6.13	0.94	6.17	0.94	6.27	0.94	8.66	1.51	10.25	1.89
	25	6.83	1.58	7.01	1.56	7.07	1.55	7.19	1.54	8.98	1.90	10.17	2.15
	29	7.65	2.28	7.85	2.25	7.91	2.24	8.05	2.22	9.20	2.37	9.96	2.48
	32	8.01	2.69	8.22	2.66	8.30	2.64	8.44	2.62	10.30	2.66	11.53	2.69
	35	8.15	3.00	8.37	2.97	8.45	2.97	8.60	2.95	9.13	2.91	9.48	2.88
	40	7.92	3.14	8.15	3.15	8.22	3.16	8.37	3.16	8.26	3.08	8.51	3.05
	43	7.48	3.14	7.71	3.21	7.79	3.23	7.94	3.28	8.08	3.21	8.17	3.19
	46	6.82	3.07	7.05	3.19	7.12	3.22	7.28	3.27	7.71	3.29	8.01	3.31
5.0 + 7.1	22	5.99	0.92	6.13	0.92	6.17	0.92	6.27	0.92	8.66	1.47	10.25	1.84
	25	6.83	1.54	7.01	1.52	7.07	1.52	7.19	1.50	8.98	1.86	10.17	2.10
	29	7.65	2.23	7.85	2.20	7.91	2.18	8.05	2.16	9.20	2.32	9.96	2.42
	32	8.01	2.63	8.22	2.59	8.30	2.58	8.44	2.56	10.30	2.60	11.53	2.63
	35	8.15	2.92	8.37	2.90	8.45	2.89	8.60	2.88	9.13	2.84	9.48	2.81
	40	7.92	3.07	8.15	3.08	8.22	3.08	8.37	3.09	8.26	3.00	8.51	2.97
	43	7.48	3.07	7.71	3.13	7.79	3.16	7.94	3.20	8.08	3.13	8.17	3.12
	46	6.82	3.00	7.05	3.11	7.12	3.15	7.28	3.19	7.71	3.21	8.01	3.23
6.0 + 6.0	22	5.99	0.94	6.13	0.94	6.17	0.94	6.27	0.94	8.66	1.51	10.25	1.89
	25	6.83	1.58	7.01	1.56	7.07	1.55	7.19	1.54	8.98	1.90	10.17	2.15
	29	7.65	2.28	7.85	2.25	7.91	2.24	8.05	2.22	9.20	2.37	9.96	2.48
	32	8.01	2.69	8.22	2.66	8.30	2.64	8.44	2.62	10.30	2.66	11.53	2.69
	35	8.15	3.00	8.37	2.97	8.45	2.97	8.60	2.95	9.13	2.91	9.48	2.88
	40	7.92	3.14	8.15	3.15	8.22	3.16	8.37	3.16	8.26	3.08	8.51	3.05
	43	7.48	3.14	7.71	3.21	7.79	3.23	7.94	3.28	8.08	3.21	8.17	3.19
	46	6.82	3.07	7.05	3.19	7.12	3.22	7.28	3.27	7.71	3.29	8.01	3.31
6.0 + 7.1	22	5.99	0.92	6.13	0.92	6.17	0.92	6.27	0.92	8.66	1.47	10.25	1.84
	25	6.83	1.54	7.01	1.52	7.07	1.52	7.19	1.50	8.98	1.86	10.17	2.10
	29	7.65	2.23	7.85	2.20	7.91	2.18	8.05	2.16	9.20	2.32	9.96	2.42
	32	8.01	2.63	8.22	2.59	8.30	2.58	8.44	2.56	10.30	2.60	11.53	2.63
	35	8.15	2.92	8.37	2.90	8.45	2.89	8.60	2.88	9.13	2.84	9.48	2.81
	40	7.92	3.07	8.15	3.08	8.22	3.08	8.37	3.09	8.26	3.00	8.51	2.97
	43	7.48	3.07	7.71	3.13	7.79	3.16	7.94	3.20	8.08	3.13	8.17	3.12
	46	6.82	3.00	7.05	3.11	7.12	3.15	7.28	3.19	7.71	3.21	8.01	3.23
7.1 + 7.1	22	5.99	0.89	6.13	0.89	6.17	0.89	6.27	0.89	8.66	1.43	10.25	1.79
	25	6.83	1.50	7.01	1.48	7.07	1.47	7.19	1.46	8.98	1.81	10.17	2.04
	29	7.65	2.17	7.85	2.13	7.91	2.12	8.05	2.10	9.20	2.25	9.96	2.35
	32	8.01	2.55	8.22	2.52	8.30	2.51	8.44	2.49	10.30	2.53	11.53	2.55
	35	8.15	2.84	8.37	2.82	8.45	2.81	8.60	2.80	9.13	2.76	9.48	2.74
	40	7.92	2.98	8.15	2.99	8.22	3.00	8.37	3.00	8.26	2.92	8.51	2.89
	43	7.48	2.98	7.71	3.05	7.79	3.07	7.94	3.11	8.08	3.05	8.17	3.03
	46	6.82	2.92	7.05	3.02	7.12	3.06	7.28	3.10	7.71	3.12	8.01	3.14



Combination (Capacity)	Outdoor Air Temp. °C DB	Indoor Air Temp. °C											
		27/16		27/17.5		27/18		27/19		27/22		27/24	
		Total Q	Input Power	Total Q	Input Power	Total Q	Input Power	Total Q	Input Power	Total Q	Input Power	Total Q	Input Power
1.6 + 1.6 + 1.6	22	5.92	0.99	6.06	0.99	6.10	0.99	6.19	0.99	8.56	1.59	10.13	1.99
	25	6.75	1.67	6.93	1.64	6.99	1.64	7.10	1.62	8.87	2.01	10.05	2.26
	29	7.56	2.41	7.76	2.37	7.82	2.36	7.95	2.34	9.09	2.50	9.85	2.61
	32	7.91	2.84	8.13	2.80	8.20	2.79	8.34	2.76	10.18	2.81	11.40	2.84
	35	8.05	3.16	8.28	3.13	8.35	3.13	8.50	3.11	9.02	3.07	9.37	3.04
	40	7.83	3.31	8.05	3.32	8.13	3.33	8.28	3.34	8.16	3.24	8.42	3.21
	43	7.40	3.31	7.62	3.38	7.70	3.41	7.85	3.45	7.99	3.38	8.08	3.37
	46	6.74	3.24	6.97	3.36	7.04	3.40	7.19	3.45	7.62	3.46	7.91	3.49
1.6 + 1.6 + 2.0	22	5.92	0.99	6.06	0.99	6.10	0.99	6.19	0.99	8.56	1.59	10.13	1.99
	25	6.75	1.67	6.93	1.64	6.99	1.64	7.10	1.62	8.87	2.01	10.05	2.26
	29	7.56	2.41	7.76	2.37	7.82	2.36	7.95	2.34	9.09	2.50	9.85	2.61
	32	7.91	2.84	8.13	2.80	8.20	2.79	8.34	2.76	10.18	2.81	11.40	2.84
	35	8.05	3.16	8.28	3.13	8.35	3.13	8.50	3.11	9.02	3.07	9.37	3.04
	40	7.83	3.31	8.05	3.32	8.13	3.33	8.28	3.34	8.16	3.24	8.42	3.21
	43	7.40	3.31	7.62	3.38	7.70	3.41	7.85	3.45	7.99	3.38	8.08	3.37
	46	6.74	3.24	6.97	3.36	7.04	3.40	7.19	3.45	7.62	3.46	7.91	3.49
1.6 + 1.6 + 2.5	22	5.92	0.99	6.06	0.99	6.10	0.99	6.19	0.99	8.56	1.59	10.13	1.99
	25	6.75	1.67	6.93	1.64	6.99	1.64	7.10	1.62	8.87	2.01	10.05	2.26
	29	7.56	2.41	7.76	2.37	7.82	2.36	7.95	2.34	9.09	2.50	9.85	2.61
	32	7.91	2.84	8.13	2.80	8.20	2.79	8.34	2.76	10.18	2.81	11.40	2.84
	35	8.05	3.16	8.28	3.13	8.35	3.13	8.50	3.11	9.02	3.07	9.37	3.04
	40	7.83	3.31	8.05	3.32	8.13	3.33	8.28	3.34	8.16	3.24	8.42	3.21
	43	7.40	3.31	7.62	3.38	7.70	3.41	7.85	3.45	7.99	3.38	8.08	3.37
	46	6.74	3.24	6.97	3.36	7.04	3.40	7.19	3.45	7.62	3.46	7.91	3.49
1.6 + 1.6 + 3.5	22	5.92	0.96	6.06	0.96	6.10	0.96	6.19	0.96	8.56	1.55	10.13	1.94
	25	6.75	1.63	6.93	1.60	6.99	1.59	7.10	1.58	8.87	1.95	10.05	2.21
	29	7.56	2.35	7.76	2.31	7.82	2.30	7.95	2.28	9.09	2.44	9.85	2.54
	32	7.91	2.76	8.13	2.73	8.20	2.72	8.34	2.69	10.18	2.74	11.40	2.76
	35	8.05	3.08	8.28	3.05	8.35	3.05	8.50	3.03	9.02	2.99	9.37	2.96
	40	7.83	3.23	8.05	3.24	8.13	3.24	8.28	3.25	8.16	3.16	8.42	3.13
	43	7.40	3.23	7.62	3.30	7.70	3.32	7.85	3.37	7.99	3.30	8.08	3.28
	46	6.74	3.16	6.97	3.27	7.04	3.31	7.19	3.36	7.62	3.38	7.91	3.40
1.6 + 1.6 + 4.2	22	5.92	0.94	6.06	0.94	6.10	0.94	6.19	0.94	8.56	1.51	10.13	1.89
	25	6.75	1.58	6.93	1.56	6.99	1.55	7.10	1.54	8.87	1.90	10.05	2.15
	29	7.56	2.28	7.76	2.25	7.82	2.24	7.95	2.22	9.09	2.37	9.85	2.48
	32	7.91	2.69	8.13	2.66	8.20	2.64	8.34	2.62	10.18	2.66	11.40	2.69
	35	8.05	3.00	8.28	2.97	8.35	2.97	8.50	2.95	9.02	2.91	9.37	2.88
	40	7.83	3.14	8.05	3.15	8.13	3.16	8.28	3.16	8.16	3.08	8.42	3.05
	43	7.40	3.14	7.62	3.21	7.70	3.23	7.85	3.28	7.99	3.21	8.08	3.19
	46	6.74	3.07	6.97	3.19	7.04	3.22	7.19	3.27	7.62	3.29	7.91	3.31

Combination (Capacity)	Outdoor Air Temp. °C DB	Indoor Air Temp. °C											
		27/16		27/17.5		27/18		27/19		27/22		27/24	
		Total Q	Input Power	Total Q	Input Power	Total Q	Input Power	Total Q	Input Power	Total Q	Input Power	Total Q	Input Power
1.6 + 1.6 + 5.0	22	5.99	0.87	6.13	0.87	6.17	0.87	6.27	0.87	8.66	1.40	10.25	1.75
	25	6.83	1.46	7.01	1.44	7.07	1.44	7.19	1.42	8.98	1.76	10.17	1.99
	29	7.65	2.11	7.85	2.08	7.91	2.07	8.05	2.05	9.20	2.19	9.96	2.29
	32	8.01	2.49	8.22	2.46	8.30	2.45	8.44	2.43	10.30	2.46	11.53	2.49
	35	8.15	2.77	8.37	2.75	8.45	2.74	8.60	2.73	9.13	2.69	9.48	2.67
	40	7.92	2.91	8.15	2.92	8.22	2.92	8.37	2.93	8.26	2.85	8.51	2.82
	43	7.48	2.91	7.71	2.97	7.79	2.99	7.94	3.03	8.08	2.97	8.17	2.96
	46	6.82	2.84	7.05	2.95	7.12	2.98	7.28	3.03	7.71	3.04	8.01	3.06
1.6 + 1.6 + 6.0	22	5.99	0.87	6.13	0.87	6.17	0.87	6.27	0.87	8.66	1.40	10.25	1.75
	25	6.83	1.46	7.01	1.44	7.07	1.44	7.19	1.42	8.98	1.76	10.17	1.99
	29	7.65	2.11	7.85	2.08	7.91	2.07	8.05	2.05	9.20	2.19	9.96	2.29
	32	8.01	2.49	8.22	2.46	8.30	2.45	8.44	2.43	10.30	2.46	11.53	2.49
	35	8.15	2.77	8.37	2.75	8.45	2.74	8.60	2.73	9.13	2.69	9.48	2.67
	40	7.92	2.91	8.15	2.92	8.22	2.92	8.37	2.93	8.26	2.85	8.51	2.82
	43	7.48	2.91	7.71	2.97	7.79	2.99	7.94	3.03	8.08	2.97	8.17	2.96
	46	6.82	2.84	7.05	2.95	7.12	2.98	7.28	3.03	7.71	3.04	8.01	3.06
1.6 + 1.6 + 7.1	22	6.13	0.89	6.27	0.89	6.32	0.89	6.41	0.89	8.86	1.43	10.49	1.79
	25	6.99	1.50	7.17	1.48	7.23	1.47	7.35	1.46	9.19	1.81	10.41	2.04
	29	7.83	2.17	8.03	2.13	8.10	2.12	8.23	2.10	9.41	2.25	10.20	2.35
	32	8.19	2.55	8.42	2.52	8.49	2.51	8.64	2.49	10.54	2.53	11.80	2.55
	35	8.33	2.84	8.57	2.82	8.64	2.81	8.80	2.80	9.34	2.76	9.70	2.74
	40	8.10	2.98	8.33	2.99	8.41	3.00	8.57	3.00	8.45	2.92	8.71	2.89
	43	7.66	2.98	7.89	3.05	7.97	3.07	8.12	3.11	8.27	3.05	8.36	3.03
	46	6.98	2.92	7.21	3.02	7.29	3.06	7.44	3.10	7.89	3.12	8.19	3.14
1.6 + 2.0 + 2.0	22	5.92	0.96	6.06	0.96	6.10	0.96	6.19	0.96	8.56	1.55	10.13	1.94
	25	6.75	1.63	6.93	1.60	6.99	1.59	7.10	1.58	8.87	1.95	10.05	2.21
	29	7.56	2.35	7.76	2.31	7.82	2.30	7.95	2.28	9.09	2.44	9.85	2.54
	32	7.91	2.76	8.13	2.73	8.20	2.72	8.34	2.69	10.18	2.74	11.40	2.76
	35	8.05	3.08	8.28	3.05	8.35	3.05	8.50	3.03	9.02	2.99	9.37	2.96
	40	7.83	3.23	8.05	3.24	8.13	3.24	8.28	3.25	8.16	3.16	8.42	3.13
	43	7.40	3.23	7.62	3.30	7.70	3.32	7.85	3.37	7.99	3.30	8.08	3.28
	46	6.74	3.16	6.97	3.27	7.04	3.31	7.19	3.36	7.62	3.38	7.91	3.40
1.6 + 2.0 + 2.5	22	5.92	0.96	6.06	0.96	6.10	0.96	6.19	0.96	8.56	1.55	10.13	1.94
	25	6.75	1.63	6.93	1.60	6.99	1.59	7.10	1.58	8.87	1.95	10.05	2.21
	29	7.56	2.35	7.76	2.31	7.82	2.30	7.95	2.28	9.09	2.44	9.85	2.54
	32	7.91	2.76	8.13	2.73	8.20	2.72	8.34	2.69	10.18	2.74	11.40	2.76
	35	8.05	3.08	8.28	3.05	8.35	3.05	8.50	3.03	9.02	2.99	9.37	2.96
	40	7.83	3.23	8.05	3.24	8.13	3.24	8.28	3.25	8.16	3.16	8.42	3.13
	43	7.40	3.23	7.62	3.30	7.70	3.32	7.85	3.37	7.99	3.30	8.08	3.28
	46	6.74	3.16	6.97	3.27	7.04	3.31	7.19	3.36	7.62	3.38	7.91	3.40

Combination (Capacity)	Outdoor Air Temp. °C DB	Indoor Air Temp. °C											
		27/16		27/17.5		27/18		27/19		27/22		27/24	
		Total Q	Input Power	Total Q	Input Power	Total Q	Input Power	Total Q	Input Power	Total Q	Input Power	Total Q	Input Power
1.6 + 2.0 + 3.5	22	5.92	0.94	6.06	0.94	6.10	0.94	6.19	0.94	8.56	1.51	10.13	1.89
	25	6.75	1.58	6.93	1.56	6.99	1.55	7.10	1.54	8.87	1.90	10.05	2.15
	29	7.56	2.28	7.76	2.25	7.82	2.24	7.95	2.22	9.09	2.37	9.85	2.48
	32	7.91	2.69	8.13	2.66	8.20	2.64	8.34	2.62	10.18	2.66	11.40	2.69
	35	8.05	3.00	8.28	2.97	8.35	2.97	8.50	2.95	9.02	2.91	9.37	2.88
	40	7.83	3.14	8.05	3.15	8.13	3.16	8.28	3.16	8.16	3.08	8.42	3.05
	43	7.40	3.14	7.62	3.21	7.70	3.23	7.85	3.28	7.99	3.21	8.08	3.19
	46	6.74	3.07	6.97	3.19	7.04	3.22	7.19	3.27	7.62	3.29	7.91	3.31
1.6 + 2.0 + 4.2	22	5.92	0.94	6.06	0.94	6.10	0.94	6.19	0.94	8.56	1.51	10.13	1.89
	25	6.75	1.58	6.93	1.56	6.99	1.55	7.10	1.54	8.87	1.90	10.05	2.15
	29	7.56	2.28	7.76	2.25	7.82	2.24	7.95	2.22	9.09	2.37	9.85	2.48
	32	7.91	2.69	8.13	2.66	8.20	2.64	8.34	2.62	10.18	2.66	11.40	2.69
	35	8.05	3.00	8.28	2.97	8.35	2.97	8.50	2.95	9.02	2.91	9.37	2.88
	40	7.83	3.14	8.05	3.15	8.13	3.16	8.28	3.16	8.16	3.08	8.42	3.05
	43	7.40	3.14	7.62	3.21	7.70	3.23	7.85	3.28	7.99	3.21	8.08	3.19
	46	6.74	3.07	6.97	3.19	7.04	3.22	7.19	3.27	7.62	3.29	7.91	3.31
1.6 + 2.0 + 5.0	22	5.99	0.87	6.13	0.87	6.17	0.87	6.27	0.87	8.66	1.40	10.25	1.75
	25	6.83	1.46	7.01	1.44	7.07	1.44	7.19	1.42	8.98	1.76	10.17	1.99
	29	7.65	2.11	7.85	2.08	7.91	2.07	8.05	2.05	9.20	2.19	9.96	2.29
	32	8.01	2.49	8.22	2.46	8.30	2.45	8.44	2.43	10.30	2.46	11.53	2.49
	35	8.15	2.77	8.37	2.75	8.45	2.74	8.60	2.73	9.13	2.69	9.48	2.67
	40	7.92	2.91	8.15	2.92	8.22	2.92	8.37	2.93	8.26	2.85	8.51	2.82
	43	7.48	2.91	7.71	2.97	7.79	2.99	7.94	3.03	8.08	2.97	8.17	2.96
	46	6.82	2.84	7.05	2.95	7.12	2.98	7.28	3.03	7.71	3.04	8.01	3.06
1.6 + 2.0 + 6.0	22	5.99	0.87	6.13	0.87	6.17	0.87	6.27	0.87	8.66	1.40	10.25	1.75
	25	6.83	1.46	7.01	1.44	7.07	1.44	7.19	1.42	8.98	1.76	10.17	1.99
	29	7.65	2.11	7.85	2.08	7.91	2.07	8.05	2.05	9.20	2.19	9.96	2.29
	32	8.01	2.49	8.22	2.46	8.30	2.45	8.44	2.43	10.30	2.46	11.53	2.49
	35	8.15	2.77	8.37	2.75	8.45	2.74	8.60	2.73	9.13	2.69	9.48	2.67
	40	7.92	2.91	8.15	2.92	8.22	2.92	8.37	2.93	8.26	2.85	8.51	2.82
	43	7.48	2.91	7.71	2.97	7.79	2.99	7.94	3.03	8.08	2.97	8.17	2.96
	46	6.82	2.84	7.05	2.95	7.12	2.98	7.28	3.03	7.71	3.04	8.01	3.06
1.6 + 2.0 + 7.1	22	6.13	0.89	6.27	0.89	6.32	0.89	6.41	0.89	8.86	1.43	10.49	1.79
	25	6.99	1.50	7.17	1.48	7.23	1.47	7.35	1.46	9.19	1.81	10.41	2.04
	29	7.83	2.17	8.03	2.13	8.10	2.12	8.23	2.10	9.41	2.25	10.20	2.35
	32	8.19	2.55	8.42	2.52	8.49	2.51	8.64	2.49	10.54	2.53	11.80	2.55
	35	8.33	2.84	8.57	2.82	8.64	2.81	8.80	2.80	9.34	2.76	9.70	2.74
	40	8.10	2.98	8.33	2.99	8.41	3.00	8.57	3.00	8.45	2.92	8.71	2.89
	43	7.66	2.98	7.89	3.05	7.97	3.07	8.12	3.11	8.27	3.05	8.36	3.03
	46	6.98	2.92	7.21	3.02	7.29	3.06	7.44	3.10	7.89	3.12	8.19	3.14

Combination (Capacity)	Outdoor Air Temp. °C DB	Indoor Air Temp. °C											
		27/16		27/17.5		27/18		27/19		27/22		27/24	
		Total Q	Input Power	Total Q	Input Power	Total Q	Input Power	Total Q	Input Power	Total Q	Input Power	Total Q	Input Power
1.6 + 2.5 + 2.5	22	5.92	0.96	6.06	0.96	6.10	0.96	6.19	0.96	8.56	1.55	10.13	1.94
	25	6.75	1.63	6.93	1.60	6.99	1.59	7.10	1.58	8.87	1.95	10.05	2.21
	29	7.56	2.35	7.76	2.31	7.82	2.30	7.95	2.28	9.09	2.44	9.85	2.54
	32	7.91	2.76	8.13	2.73	8.20	2.72	8.34	2.69	10.18	2.74	11.40	2.76
	35	8.05	3.08	8.28	3.05	8.35	3.05	8.50	3.03	9.02	2.99	9.37	2.96
	40	7.83	3.23	8.05	3.24	8.13	3.24	8.28	3.25	8.16	3.16	8.42	3.13
	43	7.40	3.23	7.62	3.30	7.70	3.32	7.85	3.37	7.99	3.30	8.08	3.28
	46	6.74	3.16	6.97	3.27	7.04	3.31	7.19	3.36	7.62	3.38	7.91	3.40
1.6 + 2.5 + 3.5	22	5.92	0.94	6.06	0.94	6.10	0.94	6.19	0.94	8.56	1.51	10.13	1.89
	25	6.75	1.58	6.93	1.56	6.99	1.55	7.10	1.54	8.87	1.90	10.05	2.15
	29	7.56	2.28	7.76	2.25	7.82	2.24	7.95	2.22	9.09	2.37	9.85	2.48
	32	7.91	2.69	8.13	2.66	8.20	2.64	8.34	2.62	10.18	2.66	11.40	2.69
	35	8.05	3.00	8.28	2.97	8.35	2.97	8.50	2.95	9.02	2.91	9.37	2.88
	40	7.83	3.14	8.05	3.15	8.13	3.16	8.28	3.16	8.16	3.08	8.42	3.05
	43	7.40	3.14	7.62	3.21	7.70	3.23	7.85	3.28	7.99	3.21	8.08	3.19
	46	6.74	3.07	6.97	3.19	7.04	3.22	7.19	3.27	7.62	3.29	7.91	3.31
1.6 + 2.5 + 4.2	22	5.99	0.96	6.13	0.96	6.17	0.96	6.27	0.96	8.66	1.55	10.25	1.94
	25	6.83	1.63	7.01	1.60	7.07	1.59	7.19	1.58	8.98	1.95	10.17	2.21
	29	7.65	2.35	7.85	2.31	7.91	2.30	8.05	2.28	9.20	2.44	9.96	2.54
	32	8.01	2.76	8.22	2.73	8.30	2.72	8.44	2.69	10.30	2.74	11.53	2.76
	35	8.15	3.08	8.37	3.05	8.45	3.05	8.60	3.03	9.13	2.99	9.48	2.96
	40	7.92	3.23	8.15	3.24	8.22	3.24	8.37	3.25	8.26	3.16	8.51	3.13
	43	7.48	3.23	7.71	3.30	7.79	3.32	7.94	3.37	8.08	3.30	8.17	3.28
	46	6.82	3.16	7.05	3.27	7.12	3.31	7.28	3.36	7.71	3.38	8.01	3.40
1.6 + 2.5 + 5.0	22	5.99	0.87	6.13	0.87	6.17	0.87	6.27	0.87	8.66	1.40	10.25	1.75
	25	6.83	1.46	7.01	1.44	7.07	1.44	7.19	1.42	8.98	1.76	10.17	1.99
	29	7.65	2.11	7.85	2.08	7.91	2.07	8.05	2.05	9.20	2.19	9.96	2.29
	32	8.01	2.49	8.22	2.46	8.30	2.45	8.44	2.43	10.30	2.46	11.53	2.49
	35	8.15	2.77	8.37	2.75	8.45	2.74	8.60	2.73	9.13	2.69	9.48	2.67
	40	7.92	2.91	8.15	2.92	8.22	2.92	8.37	2.93	8.26	2.85	8.51	2.82
	43	7.48	2.91	7.71	2.97	7.79	2.99	7.94	3.03	8.08	2.97	8.17	2.96
	46	6.82	2.84	7.05	2.95	7.12	2.98	7.28	3.03	7.71	3.04	8.01	3.06
1.6 + 2.5 + 6.0	22	6.13	0.89	6.27	0.89	6.32	0.89	6.41	0.89	8.86	1.43	10.49	1.79
	25	6.99	1.50	7.17	1.48	7.23	1.47	7.35	1.46	9.19	1.81	10.41	2.04
	29	7.83	2.17	8.03	2.13	8.10	2.12	8.23	2.10	9.41	2.25	10.20	2.35
	32	8.19	2.55	8.42	2.52	8.49	2.51	8.64	2.49	10.54	2.53	11.80	2.55
	35	8.33	2.84	8.57	2.82	8.64	2.81	8.80	2.80	9.34	2.76	9.70	2.74
	40	8.10	2.98	8.33	2.99	8.41	3.00	8.57	3.00	8.45	2.92	8.71	2.89
	43	7.66	2.98	7.89	3.05	7.97	3.07	8.12	3.11	8.27	3.05	8.36	3.03
	46	6.98	2.92	7.21	3.02	7.29	3.06	7.44	3.10	7.89	3.12	8.19	3.14

Combination (Capacity)	Outdoor Air Temp. °C DB	Indoor Air Temp. °C											
		27/16		27/17.5		27/18		27/19		27/22		27/24	
		Total Q	Input Power	Total Q	Input Power	Total Q	Input Power	Total Q	Input Power	Total Q	Input Power	Total Q	Input Power
1.6 + 2.5 + 7.1	22	6.13	0.89	6.27	0.89	6.32	0.89	6.41	0.89	8.86	1.43	10.49	1.79
	25	6.99	1.50	7.17	1.48	7.23	1.47	7.35	1.46	9.19	1.81	10.41	2.04
	29	7.83	2.17	8.03	2.13	8.10	2.12	8.23	2.10	9.41	2.25	10.20	2.35
	32	8.19	2.55	8.42	2.52	8.49	2.51	8.64	2.49	10.54	2.53	11.80	2.55
	35	8.33	2.84	8.57	2.82	8.64	2.81	8.80	2.80	9.34	2.76	9.70	2.74
	40	8.10	2.98	8.33	2.99	8.41	3.00	8.57	3.00	8.45	2.92	8.71	2.89
	43	7.66	2.98	7.89	3.05	7.97	3.07	8.12	3.11	8.27	3.05	8.36	3.03
	46	6.98	2.92	7.21	3.02	7.29	3.06	7.44	3.10	7.89	3.12	8.19	3.14
1.6 + 3.5 + 3.5	22	5.99	0.94	6.13	0.94	6.17	0.94	6.27	0.94	8.66	1.51	10.25	1.89
	25	6.83	1.58	7.01	1.56	7.07	1.55	7.19	1.54	8.98	1.90	10.17	2.15
	29	7.65	2.28	7.85	2.25	7.91	2.24	8.05	2.22	9.20	2.37	9.96	2.48
	32	8.01	2.69	8.22	2.66	8.30	2.64	8.44	2.62	10.30	2.66	11.53	2.69
	35	8.15	3.00	8.37	2.97	8.45	2.97	8.60	2.95	9.13	2.91	9.48	2.88
	40	7.92	3.14	8.15	3.15	8.22	3.16	8.37	3.16	8.26	3.08	8.51	3.05
	43	7.48	3.14	7.71	3.21	7.79	3.23	7.94	3.28	8.08	3.21	8.17	3.19
	46	6.82	3.07	7.05	3.19	7.12	3.22	7.28	3.27	7.71	3.29	8.01	3.31
1.6 + 3.5 + 4.2	22	5.99	0.94	6.13	0.94	6.17	0.94	6.27	0.94	8.66	1.51	10.25	1.89
	25	6.83	1.58	7.01	1.56	7.07	1.55	7.19	1.54	8.98	1.90	10.17	2.15
	29	7.65	2.28	7.85	2.25	7.91	2.24	8.05	2.22	9.20	2.37	9.96	2.48
	32	8.01	2.69	8.22	2.66	8.30	2.64	8.44	2.62	10.30	2.66	11.53	2.69
	35	8.15	3.00	8.37	2.97	8.45	2.97	8.60	2.95	9.13	2.91	9.48	2.88
	40	7.92	3.14	8.15	3.15	8.22	3.16	8.37	3.16	8.26	3.08	8.51	3.05
	43	7.48	3.14	7.71	3.21	7.79	3.23	7.94	3.28	8.08	3.21	8.17	3.19
	46	6.82	3.07	7.05	3.19	7.12	3.22	7.28	3.27	7.71	3.29	8.01	3.31
1.6 + 3.5 + 5.0	22	6.13	0.89	6.27	0.89	6.32	0.89	6.41	0.89	8.86	1.43	10.49	1.79
	25	6.99	1.50	7.17	1.48	7.23	1.47	7.35	1.46	9.19	1.81	10.41	2.04
	29	7.83	2.17	8.03	2.13	8.10	2.12	8.23	2.10	9.41	2.25	10.20	2.35
	32	8.19	2.55	8.42	2.52	8.49	2.51	8.64	2.49	10.54	2.53	11.80	2.55
	35	8.33	2.84	8.57	2.82	8.64	2.81	8.80	2.80	9.34	2.76	9.70	2.74
	40	8.10	2.98	8.33	2.99	8.41	3.00	8.57	3.00	8.45	2.92	8.71	2.89
	43	7.66	2.98	7.89	3.05	7.97	3.07	8.12	3.11	8.27	3.05	8.36	3.03
	46	6.98	2.92	7.21	3.02	7.29	3.06	7.44	3.10	7.89	3.12	8.19	3.14
1.6 + 3.5 + 6.0	22	6.13	0.89	6.27	0.89	6.32	0.89	6.41	0.89	8.86	1.43	10.49	1.79
	25	6.99	1.50	7.17	1.48	7.23	1.47	7.35	1.46	9.19	1.81	10.41	2.04
	29	7.83	2.17	8.03	2.13	8.10	2.12	8.23	2.10	9.41	2.25	10.20	2.35
	32	8.19	2.55	8.42	2.52	8.49	2.51	8.64	2.49	10.54	2.53	11.80	2.55
	35	8.33	2.84	8.57	2.82	8.64	2.81	8.80	2.80	9.34	2.76	9.70	2.74
	40	8.10	2.98	8.33	2.99	8.41	3.00	8.57	3.00	8.45	2.92	8.71	2.89
	43	7.66	2.98	7.89	3.05	7.97	3.07	8.12	3.11	8.27	3.05	8.36	3.03
	46	6.98	2.92	7.21	3.02	7.29	3.06	7.44	3.10	7.89	3.12	8.19	3.14

Combination (Capacity)	Outdoor Air Temp. °C DB	Indoor Air Temp. °C											
		27/16		27/17.5		27/18		27/19		27/22		27/24	
		Total Q	Input Power	Total Q	Input Power	Total Q	Input Power	Total Q	Input Power	Total Q	Input Power	Total Q	Input Power
1.6 + 3.5 + 7.1	22	6.27	0.91	6.41	0.91	6.46	0.91	6.56	0.91	9.06	1.47	10.73	1.84
	25	7.15	1.54	7.33	1.52	7.40	1.51	7.52	1.50	9.40	1.85	10.64	2.09
	29	8.01	2.22	8.21	2.19	8.28	2.18	8.42	2.16	9.62	2.31	10.43	2.41
	32	8.38	2.62	8.61	2.58	8.68	2.57	8.83	2.55	10.78	2.59	12.07	2.62
	35	8.52	2.91	8.76	2.89	8.84	2.88	9.00	2.87	9.55	2.83	9.92	2.80
	40	8.29	3.06	8.52	3.07	8.60	3.07	8.76	3.08	8.64	2.99	8.91	2.96
	43	7.83	3.06	8.07	3.12	8.15	3.14	8.31	3.19	8.46	3.12	8.55	3.11
	46	7.14	2.99	7.38	3.10	7.46	3.14	7.61	3.18	8.07	3.20	8.38	3.22
1.6 + 4.2 + 4.2	22	6.13	0.99	6.27	0.99	6.32	0.99	6.41	0.99	8.86	1.58	10.49	1.98
	25	6.99	1.66	7.17	1.64	7.23	1.63	7.35	1.62	9.19	2.00	10.41	2.26
	29	7.83	2.40	8.03	2.36	8.10	2.35	8.23	2.33	9.41	2.49	10.20	2.60
	32	8.19	2.83	8.42	2.79	8.49	2.78	8.64	2.76	10.54	2.80	11.80	2.83
	35	8.33	3.15	8.57	3.12	8.64	3.12	8.80	3.10	9.34	3.06	9.70	3.03
	40	8.10	3.30	8.33	3.31	8.41	3.32	8.57	3.33	8.45	3.23	8.71	3.20
	43	7.66	3.30	7.89	3.37	7.97	3.40	8.12	3.44	8.27	3.37	8.36	3.36
	46	6.98	3.23	7.21	3.35	7.29	3.39	7.44	3.44	7.89	3.45	8.19	3.47
1.6 + 4.2 + 5.0	22	6.13	0.89	6.27	0.89	6.32	0.89	6.41	0.89	8.86	1.43	10.49	1.79
	25	6.99	1.50	7.17	1.48	7.23	1.47	7.35	1.46	9.19	1.81	10.41	2.04
	29	7.83	2.17	8.03	2.13	8.10	2.12	8.23	2.10	9.41	2.25	10.20	2.35
	32	8.19	2.55	8.42	2.52	8.49	2.51	8.64	2.49	10.54	2.53	11.80	2.55
	35	8.33	2.84	8.57	2.82	8.64	2.81	8.80	2.80	9.34	2.76	9.70	2.74
	40	8.10	2.98	8.33	2.99	8.41	3.00	8.57	3.00	8.45	2.92	8.71	2.89
	43	7.66	2.98	7.89	3.05	7.97	3.07	8.12	3.11	8.27	3.05	8.36	3.03
	46	6.98	2.92	7.21	3.02	7.29	3.06	7.44	3.10	7.89	3.12	8.19	3.14
1.6 + 4.2 + 6.0	22	6.27	0.91	6.41	0.91	6.46	0.91	6.56	0.91	9.06	1.47	10.73	1.84
	25	7.15	1.54	7.33	1.52	7.40	1.51	7.52	1.50	9.40	1.85	10.64	2.09
	29	8.01	2.22	8.21	2.19	8.28	2.18	8.42	2.16	9.62	2.31	10.43	2.41
	32	8.38	2.62	8.61	2.58	8.68	2.57	8.83	2.55	10.78	2.59	12.07	2.62
	35	8.52	2.91	8.76	2.89	8.84	2.88	9.00	2.87	9.55	2.83	9.92	2.80
	40	8.29	3.06	8.52	3.07	8.60	3.07	8.76	3.08	8.64	2.99	8.91	2.96
	43	7.83	3.06	8.07	3.12	8.15	3.14	8.31	3.19	8.46	3.12	8.55	3.11
	46	7.14	2.99	7.38	3.10	7.46	3.14	7.61	3.18	8.07	3.20	8.38	3.22
1.6 + 4.2 + 7.1	22	6.27	0.89	6.41	0.89	6.46	0.89	6.56	0.89	9.06	1.43	10.73	1.79
	25	7.15	1.50	7.33	1.48	7.40	1.47	7.52	1.46	9.40	1.81	10.64	2.04
	29	8.01	2.17	8.21	2.13	8.28	2.12	8.42	2.10	9.62	2.25	10.43	2.35
	32	8.38	2.55	8.61	2.52	8.68	2.51	8.83	2.49	10.78	2.53	12.07	2.55
	35	8.52	2.84	8.76	2.82	8.84	2.81	9.00	2.80	9.55	2.76	9.92	2.74
	40	8.29	2.98	8.52	2.99	8.60	3.00	8.76	3.00	8.64	2.92	8.91	2.89
	43	7.83	2.98	8.07	3.05	8.15	3.07	8.31	3.11	8.46	3.05	8.55	3.03
	46	7.14	2.92	7.38	3.02	7.46	3.06	7.61	3.10	8.07	3.12	8.38	3.14

Combination (Capacity)	Outdoor Air Temp. °C DB	Indoor Air Temp. °C											
		27/16		27/17.5		27/18		27/19		27/22		27/24	
		Total Q	Input Power	Total Q	Input Power	Total Q	Input Power	Total Q	Input Power	Total Q	Input Power	Total Q	Input Power
1.6 + 5.0 + 5.0	22	6.13	0.82	6.27	0.82	6.32	0.82	6.41	0.82	8.86	1.32	10.49	1.65
	25	6.99	1.38	7.17	1.36	7.23	1.36	7.35	1.34	9.19	1.66	10.41	1.88
	29	7.83	2.00	8.03	1.97	8.10	1.96	8.23	1.94	9.41	2.07	10.20	2.16
	32	8.19	2.35	8.42	2.32	8.49	2.31	8.64	2.29	10.54	2.33	11.80	2.35
	35	8.33	2.62	8.57	2.60	8.64	2.59	8.80	2.58	9.34	2.54	9.70	2.52
	40	8.10	2.75	8.33	2.76	8.41	2.76	8.57	2.77	8.45	2.69	8.71	2.66
	43	7.66	2.75	7.89	2.81	7.97	2.83	8.12	2.87	8.27	2.81	8.36	2.79
	46	6.98	2.69	7.21	2.79	7.29	2.82	7.44	2.86	7.89	2.87	8.19	2.89
1.6 + 5.0 + 6.0	22	6.27	0.84	6.41	0.84	6.46	0.84	6.56	0.84	9.06	1.35	10.73	1.70
	25	7.15	1.42	7.33	1.40	7.40	1.39	7.52	1.38	9.40	1.71	10.64	1.93
	29	8.01	2.05	8.21	2.02	8.28	2.01	8.42	1.99	9.62	2.13	10.43	2.22
	32	8.38	2.42	8.61	2.39	8.68	2.38	8.83	2.36	10.78	2.39	12.07	2.42
	35	8.52	2.69	8.76	2.67	8.84	2.66	9.00	2.65	9.55	2.61	9.92	2.59
	40	8.29	2.82	8.52	2.83	8.60	2.84	8.76	2.84	8.64	2.76	8.91	2.74
	43	7.83	2.82	8.07	2.88	8.15	2.90	8.31	2.94	8.46	2.88	8.55	2.87
	46	7.14	2.76	7.38	2.86	7.46	2.90	7.61	2.94	8.07	2.95	8.38	2.97
1.6 + 5.0 + 7.1	22	6.27	0.84	6.41	0.84	6.46	0.84	6.56	0.84	9.06	1.35	10.73	1.70
	25	7.15	1.42	7.33	1.40	7.40	1.39	7.52	1.38	9.40	1.71	10.64	1.93
	29	8.01	2.05	8.21	2.02	8.28	2.01	8.42	1.99	9.62	2.13	10.43	2.22
	32	8.38	2.42	8.61	2.39	8.68	2.38	8.83	2.36	10.78	2.39	12.07	2.42
	35	8.52	2.69	8.76	2.67	8.84	2.66	9.00	2.65	9.55	2.61	9.92	2.59
	40	8.29	2.82	8.52	2.83	8.60	2.84	8.76	2.84	8.64	2.76	8.91	2.74
	43	7.83	2.82	8.07	2.88	8.15	2.90	8.31	2.94	8.46	2.88	8.55	2.87
	46	7.14	2.76	7.38	2.86	7.46	2.90	7.61	2.94	8.07	2.95	8.38	2.97
1.6 + 6.0 + 6.0	22	6.27	0.84	6.41	0.84	6.46	0.84	6.56	0.84	9.06	1.35	10.73	1.70
	25	7.15	1.42	7.33	1.40	7.40	1.39	7.52	1.38	9.40	1.71	10.64	1.93
	29	8.01	2.05	8.21	2.02	8.28	2.01	8.42	1.99	9.62	2.13	10.43	2.22
	32	8.38	2.42	8.61	2.39	8.68	2.38	8.83	2.36	10.78	2.39	12.07	2.42
	35	8.52	2.69	8.76	2.67	8.84	2.66	9.00	2.65	9.55	2.61	9.92	2.59
	40	8.29	2.82	8.52	2.83	8.60	2.84	8.76	2.84	8.64	2.76	8.91	2.74
	43	7.83	2.82	8.07	2.88	8.15	2.90	8.31	2.94	8.46	2.88	8.55	2.87
	46	7.14	2.76	7.38	2.86	7.46	2.90	7.61	2.94	8.07	2.95	8.38	2.97
1.6 + 6.0 + 7.1	22	6.27	0.84	6.41	0.84	6.46	0.84	6.56	0.84	9.06	1.35	10.73	1.70
	25	7.15	1.42	7.33	1.40	7.40	1.39	7.52	1.38	9.40	1.71	10.64	1.93
	29	8.01	2.05	8.21	2.02	8.28	2.01	8.42	1.99	9.62	2.13	10.43	2.22
	32	8.38	2.42	8.61	2.39	8.68	2.38	8.83	2.36	10.78	2.39	12.07	2.42
	35	8.52	2.69	8.76	2.67	8.84	2.66	9.00	2.65	9.55	2.61	9.92	2.59
	40	8.29	2.82	8.52	2.83	8.60	2.84	8.76	2.84	8.64	2.76	8.91	2.74
	43	7.83	2.82	8.07	2.88	8.15	2.90	8.31	2.94	8.46	2.88	8.55	2.87
	46	7.14	2.76	7.38	2.86	7.46	2.90	7.61	2.94	8.07	2.95	8.38	2.97

Combination (Capacity)	Outdoor Air Temp. °C DB	Indoor Air Temp. °C											
		27/16		27/17.5		27/18		27/19		27/22		27/24	
		Total Q	Input Power	Total Q	Input Power	Total Q	Input Power	Total Q	Input Power	Total Q	Input Power	Total Q	Input Power
2.0 + 2.0 + 2.0	22	5.92	0.96	6.06	0.96	6.10	0.96	6.19	0.96	8.56	1.55	10.13	1.94
	25	6.75	1.63	6.93	1.60	6.99	1.59	7.10	1.58	8.87	1.95	10.05	2.21
	29	7.56	2.35	7.76	2.31	7.82	2.30	7.95	2.28	9.09	2.44	9.85	2.54
	32	7.91	2.76	8.13	2.73	8.20	2.72	8.34	2.69	10.18	2.74	11.40	2.76
	35	8.05	3.08	8.28	3.05	8.35	3.05	8.50	3.03	9.02	2.99	9.37	2.96
	40	7.83	3.23	8.05	3.24	8.13	3.24	8.28	3.25	8.16	3.16	8.42	3.13
	43	7.40	3.23	7.62	3.30	7.70	3.32	7.85	3.37	7.99	3.30	8.08	3.28
	46	6.74	3.16	6.97	3.27	7.04	3.31	7.19	3.36	7.62	3.38	7.91	3.40
2.0 + 2.0 + 2.5	22	5.92	0.96	6.06	0.96	6.10	0.96	6.19	0.96	8.56	1.55	10.13	1.94
	25	6.75	1.63	6.93	1.60	6.99	1.59	7.10	1.58	8.87	1.95	10.05	2.21
	29	7.56	2.35	7.76	2.31	7.82	2.30	7.95	2.28	9.09	2.44	9.85	2.54
	32	7.91	2.76	8.13	2.73	8.20	2.72	8.34	2.69	10.18	2.74	11.40	2.76
	35	8.05	3.08	8.28	3.05	8.35	3.05	8.50	3.03	9.02	2.99	9.37	2.96
	40	7.83	3.23	8.05	3.24	8.13	3.24	8.28	3.25	8.16	3.16	8.42	3.13
	43	7.40	3.23	7.62	3.30	7.70	3.32	7.85	3.37	7.99	3.30	8.08	3.28
	46	6.74	3.16	6.97	3.27	7.04	3.31	7.19	3.36	7.62	3.38	7.91	3.40
2.0 + 2.0 + 3.5	22	5.92	0.94	6.06	0.94	6.10	0.94	6.19	0.94	8.56	1.51	10.13	1.89
	25	6.75	1.58	6.93	1.56	6.99	1.55	7.10	1.54	8.87	1.90	10.05	2.15
	29	7.56	2.28	7.76	2.25	7.82	2.24	7.95	2.22	9.09	2.37	9.85	2.48
	32	7.91	2.69	8.13	2.66	8.20	2.64	8.34	2.62	10.18	2.66	11.40	2.69
	35	8.05	3.00	8.28	2.97	8.35	2.97	8.50	2.95	9.02	2.91	9.37	2.88
	40	7.83	3.14	8.05	3.15	8.13	3.16	8.28	3.16	8.16	3.08	8.42	3.05
	43	7.40	3.14	7.62	3.21	7.70	3.23	7.85	3.28	7.99	3.21	8.08	3.19
	46	6.74	3.07	6.97	3.19	7.04	3.22	7.19	3.27	7.62	3.29	7.91	3.31
2.0 + 2.0 + 4.2	22	5.99	0.96	6.13	0.96	6.17	0.96	6.27	0.96	8.66	1.55	10.25	1.94
	25	6.83	1.63	7.01	1.60	7.07	1.59	7.19	1.58	8.98	1.95	10.17	2.21
	29	7.65	2.35	7.85	2.31	7.91	2.30	8.05	2.28	9.20	2.44	9.96	2.54
	32	8.01	2.76	8.22	2.73	8.30	2.72	8.44	2.69	10.30	2.74	11.53	2.76
	35	8.15	3.08	8.37	3.05	8.45	3.05	8.60	3.03	9.13	2.99	9.48	2.96
	40	7.92	3.23	8.15	3.24	8.22	3.24	8.37	3.25	8.26	3.16	8.51	3.13
	43	7.48	3.23	7.71	3.30	7.79	3.32	7.94	3.37	8.08	3.30	8.17	3.28
	46	6.82	3.16	7.05	3.27	7.12	3.31	7.28	3.36	7.71	3.38	8.01	3.40
2.0 + 2.0 + 5.0	22	5.99	0.84	6.13	0.84	6.17	0.84	6.27	0.84	8.66	1.35	10.25	1.70
	25	6.83	1.42	7.01	1.40	7.07	1.39	7.19	1.38	8.98	1.71	10.17	1.93
	29	7.65	2.05	7.85	2.02	7.91	2.01	8.05	1.99	9.20	2.13	9.96	2.22
	32	8.01	2.42	8.22	2.39	8.30	2.38	8.44	2.36	10.30	2.39	11.53	2.42
	35	8.15	2.69	8.37	2.67	8.45	2.66	8.60	2.65	9.13	2.61	9.48	2.59
	40	7.92	2.82	8.15	2.83	8.22	2.84	8.37	2.84	8.26	2.76	8.51	2.74
	43	7.48	2.82	7.71	2.88	7.79	2.90	7.94	2.94	8.08	2.88	8.17	2.87
	46	6.82	2.76	7.05	2.86	7.12	2.90	7.28	2.94	7.71	2.95	8.01	2.97



Combination (Capacity)	Outdoor Air Temp. °C DB	Indoor Air Temp. °C											
		27/16		27/17.5		27/18		27/19		27/22		27/24	
		Total Q	Input Power	Total Q	Input Power	Total Q	Input Power	Total Q	Input Power	Total Q	Input Power	Total Q	Input Power
2.0 + 2.0 + 6.0	22	6.13	0.89	6.27	0.89	6.32	0.89	6.41	0.89	8.86	1.43	10.49	1.79
	25	6.99	1.50	7.17	1.48	7.23	1.47	7.35	1.46	9.19	1.81	10.41	2.04
	29	7.83	2.17	8.03	2.13	8.10	2.12	8.23	2.10	9.41	2.25	10.20	2.35
	32	8.19	2.55	8.42	2.52	8.49	2.51	8.64	2.49	10.54	2.53	11.80	2.55
	35	8.33	2.84	8.57	2.82	8.64	2.81	8.80	2.80	9.34	2.76	9.70	2.74
	40	8.10	2.98	8.33	2.99	8.41	3.00	8.57	3.00	8.45	2.92	8.71	2.89
	43	7.66	2.98	7.89	3.05	7.97	3.07	8.12	3.11	8.27	3.05	8.36	3.03
	46	6.98	2.92	7.21	3.02	7.29	3.06	7.44	3.10	7.89	3.12	8.19	3.14
2.0 + 2.0 + 7.1	22	6.13	0.86	6.27	0.86	6.32	0.86	6.41	0.86	8.86	1.39	10.49	1.74
	25	6.99	1.46	7.17	1.44	7.23	1.43	7.35	1.42	9.19	1.75	10.41	1.98
	29	7.83	2.11	8.03	2.07	8.10	2.06	8.23	2.04	9.41	2.19	10.20	2.28
	32	8.19	2.48	8.42	2.45	8.49	2.44	8.64	2.42	10.54	2.46	11.80	2.48
	35	8.33	2.76	8.57	2.74	8.64	2.73	8.80	2.72	9.34	2.68	9.70	2.66
	40	8.10	2.90	8.33	2.91	8.41	2.91	8.57	2.92	8.45	2.84	8.71	2.81
	43	7.66	2.90	7.89	2.96	7.97	2.98	8.12	3.02	8.27	2.96	8.36	2.94
	46	6.98	2.83	7.21	2.94	7.29	2.97	7.44	3.02	7.89	3.03	8.19	3.05
2.0 + 2.5 + 2.5	22	5.92	0.96	6.06	0.96	6.10	0.96	6.19	0.96	8.56	1.55	10.13	1.94
	25	6.75	1.63	6.93	1.60	6.99	1.59	7.10	1.58	8.87	1.95	10.05	2.21
	29	7.56	2.35	7.76	2.31	7.82	2.30	7.95	2.28	9.09	2.44	9.85	2.54
	32	7.91	2.76	8.13	2.73	8.20	2.72	8.34	2.69	10.18	2.74	11.40	2.76
	35	8.05	3.08	8.28	3.05	8.35	3.05	8.50	3.03	9.02	2.99	9.37	2.96
	40	7.83	3.23	8.05	3.24	8.13	3.24	8.28	3.25	8.16	3.16	8.42	3.13
	43	7.40	3.23	7.62	3.30	7.70	3.32	7.85	3.37	7.99	3.30	8.08	3.28
	46	6.74	3.16	6.97	3.27	7.04	3.31	7.19	3.36	7.62	3.38	7.91	3.40
2.0 + 2.5 + 3.5	22	5.99	0.96	6.13	0.96	6.17	0.96	6.27	0.96	8.66	1.55	10.25	1.94
	25	6.83	1.63	7.01	1.60	7.07	1.59	7.19	1.58	8.98	1.95	10.17	2.21
	29	7.65	2.35	7.85	2.31	7.91	2.30	8.05	2.28	9.20	2.44	9.96	2.54
	32	8.01	2.76	8.22	2.73	8.30	2.72	8.44	2.69	10.30	2.74	11.53	2.76
	35	8.15	3.08	8.37	3.05	8.45	3.05	8.60	3.03	9.13	2.99	9.48	2.96
	40	7.92	3.23	8.15	3.24	8.22	3.24	8.37	3.25	8.26	3.16	8.51	3.13
	43	7.48	3.23	7.71	3.30	7.79	3.32	7.94	3.37	8.08	3.30	8.17	3.28
	46	6.82	3.16	7.05	3.27	7.12	3.31	7.28	3.36	7.71	3.38	8.01	3.40
2.0 + 2.5 + 4.2	22	5.99	0.96	6.13	0.96	6.17	0.96	6.27	0.96	8.66	1.55	10.25	1.94
	25	6.83	1.63	7.01	1.60	7.07	1.59	7.19	1.58	8.98	1.95	10.17	2.21
	29	7.65	2.35	7.85	2.31	7.91	2.30	8.05	2.28	9.20	2.44	9.96	2.54
	32	8.01	2.76	8.22	2.73	8.30	2.72	8.44	2.69	10.30	2.74	11.53	2.76
	35	8.15	3.08	8.37	3.05	8.45	3.05	8.60	3.03	9.13	2.99	9.48	2.96
	40	7.92	3.23	8.15	3.24	8.22	3.24	8.37	3.25	8.26	3.16	8.51	3.13
	43	7.48	3.23	7.71	3.30	7.79	3.32	7.94	3.37	8.08	3.30	8.17	3.28
	46	6.82	3.16	7.05	3.27	7.12	3.31	7.28	3.36	7.71	3.38	8.01	3.40

Combination (Capacity)	Outdoor Air Temp. °C DB	Indoor Air Temp. °C											
		27/16		27/17.5		27/18		27/19		27/22		27/24	
		Total Q	Input Power	Total Q	Input Power	Total Q	Input Power	Total Q	Input Power	Total Q	Input Power	Total Q	Input Power
2.0 + 2.5 + 5.0	22	5.99	0.84	6.13	0.84	6.17	0.84	6.27	0.84	8.66	1.35	10.25	1.70
	25	6.83	1.42	7.01	1.40	7.07	1.39	7.19	1.38	8.98	1.71	10.17	1.93
	29	7.65	2.05	7.85	2.02	7.91	2.01	8.05	1.99	9.20	2.13	9.96	2.22
	32	8.01	2.42	8.22	2.39	8.30	2.38	8.44	2.36	10.30	2.39	11.53	2.42
	35	8.15	2.69	8.37	2.67	8.45	2.66	8.60	2.65	9.13	2.61	9.48	2.59
	40	7.92	2.82	8.15	2.83	8.22	2.84	8.37	2.84	8.26	2.76	8.51	2.74
	43	7.48	2.82	7.71	2.88	7.79	2.90	7.94	2.94	8.08	2.88	8.17	2.87
	46	6.82	2.76	7.05	2.86	7.12	2.90	7.28	2.94	7.71	2.95	8.01	2.97
2.0 + 2.5 + 6.0	22	6.13	0.89	6.27	0.89	6.32	0.89	6.41	0.89	8.86	1.43	10.49	1.79
	25	6.99	1.50	7.17	1.48	7.23	1.47	7.35	1.46	9.19	1.81	10.41	2.04
	29	7.83	2.17	8.03	2.13	8.10	2.12	8.23	2.10	9.41	2.25	10.20	2.35
	32	8.19	2.55	8.42	2.52	8.49	2.51	8.64	2.49	10.54	2.53	11.80	2.55
	35	8.33	2.84	8.57	2.82	8.64	2.81	8.80	2.80	9.34	2.76	9.70	2.74
	40	8.10	2.98	8.33	2.99	8.41	3.00	8.57	3.00	8.45	2.92	8.71	2.89
	43	7.66	2.98	7.89	3.05	7.97	3.07	8.12	3.11	8.27	3.05	8.36	3.03
	46	6.98	2.92	7.21	3.02	7.29	3.06	7.44	3.10	7.89	3.12	8.19	3.14
2.0 + 2.5 + 7.1	22	6.13	0.86	6.27	0.86	6.32	0.86	6.41	0.86	8.86	1.39	10.49	1.74
	25	6.99	1.46	7.17	1.44	7.23	1.43	7.35	1.42	9.19	1.75	10.41	1.98
	29	7.83	2.11	8.03	2.07	8.10	2.06	8.23	2.04	9.41	2.19	10.20	2.28
	32	8.19	2.48	8.42	2.45	8.49	2.44	8.64	2.42	10.54	2.46	11.80	2.48
	35	8.33	2.76	8.57	2.74	8.64	2.73	8.80	2.72	9.34	2.68	9.70	2.66
	40	8.10	2.90	8.33	2.91	8.41	2.91	8.57	2.92	8.45	2.84	8.71	2.81
	43	7.66	2.90	7.89	2.96	7.97	2.98	8.12	3.02	8.27	2.96	8.36	2.94
	46	6.98	2.83	7.21	2.94	7.29	2.97	7.44	3.02	7.89	3.03	8.19	3.05
2.0 + 3.5 + 3.5	22	5.99	0.94	6.13	0.94	6.17	0.94	6.27	0.94	8.66	1.51	10.25	1.89
	25	6.83	1.58	7.01	1.56	7.07	1.55	7.19	1.54	8.98	1.90	10.17	2.15
	29	7.65	2.28	7.85	2.25	7.91	2.24	8.05	2.22	9.20	2.37	9.96	2.48
	32	8.01	2.69	8.22	2.66	8.30	2.64	8.44	2.62	10.30	2.66	11.53	2.69
	35	8.15	3.00	8.37	2.97	8.45	2.97	8.60	2.95	9.13	2.91	9.48	2.88
	40	7.92	3.14	8.15	3.15	8.22	3.16	8.37	3.16	8.26	3.08	8.51	3.05
	43	7.48	3.14	7.71	3.21	7.79	3.23	7.94	3.28	8.08	3.21	8.17	3.19
	46	6.82	3.07	7.05	3.19	7.12	3.22	7.28	3.27	7.71	3.29	8.01	3.31
2.0 + 3.5 + 4.2	22	5.99	0.94	6.13	0.94	6.17	0.94	6.27	0.94	8.66	1.51	10.25	1.89
	25	6.83	1.58	7.01	1.56	7.07	1.55	7.19	1.54	8.98	1.90	10.17	2.15
	29	7.65	2.28	7.85	2.25	7.91	2.24	8.05	2.22	9.20	2.37	9.96	2.48
	32	8.01	2.69	8.22	2.66	8.30	2.64	8.44	2.62	10.30	2.66	11.53	2.69
	35	8.15	3.00	8.37	2.97	8.45	2.97	8.60	2.95	9.13	2.91	9.48	2.88
	40	7.92	3.14	8.15	3.15	8.22	3.16	8.37	3.16	8.26	3.08	8.51	3.05
	43	7.48	3.14	7.71	3.21	7.79	3.23	7.94	3.28	8.08	3.21	8.17	3.19
	46	6.82	3.07	7.05	3.19	7.12	3.22	7.28	3.27	7.71	3.29	8.01	3.31

Combination (Capacity)	Outdoor Air Temp. °C DB	Indoor Air Temp. °C											
		27/16		27/17.5		27/18		27/19		27/22		27/24	
		Total Q	Input Power	Total Q	Input Power	Total Q	Input Power	Total Q	Input Power	Total Q	Input Power	Total Q	Input Power
2.0 + 3.5 + 5.0	22	6.13	0.89	6.27	0.89	6.32	0.89	6.41	0.89	8.86	1.43	10.49	1.79
	25	6.99	1.50	7.17	1.48	7.23	1.47	7.35	1.46	9.19	1.81	10.41	2.04
	29	7.83	2.17	8.03	2.13	8.10	2.12	8.23	2.10	9.41	2.25	10.20	2.35
	32	8.19	2.55	8.42	2.52	8.49	2.51	8.64	2.49	10.54	2.53	11.80	2.55
	35	8.33	2.84	8.57	2.82	8.64	2.81	8.80	2.80	9.34	2.76	9.70	2.74
	40	8.10	2.98	8.33	2.99	8.41	3.00	8.57	3.00	8.45	2.92	8.71	2.89
	43	7.66	2.98	7.89	3.05	7.97	3.07	8.12	3.11	8.27	3.05	8.36	3.03
	46	6.98	2.92	7.21	3.02	7.29	3.06	7.44	3.10	7.89	3.12	8.19	3.14
2.0 + 3.5 + 6.0	22	6.13	0.89	6.27	0.89	6.32	0.89	6.41	0.89	8.86	1.43	10.49	1.79
	25	6.99	1.50	7.17	1.48	7.23	1.47	7.35	1.46	9.19	1.81	10.41	2.04
	29	7.83	2.17	8.03	2.13	8.10	2.12	8.23	2.10	9.41	2.25	10.20	2.35
	32	8.19	2.55	8.42	2.52	8.49	2.51	8.64	2.49	10.54	2.53	11.80	2.55
	35	8.33	2.84	8.57	2.82	8.64	2.81	8.80	2.80	9.34	2.76	9.70	2.74
	40	8.10	2.98	8.33	2.99	8.41	3.00	8.57	3.00	8.45	2.92	8.71	2.89
	43	7.66	2.98	7.89	3.05	7.97	3.07	8.12	3.11	8.27	3.05	8.36	3.03
	46	6.98	2.92	7.21	3.02	7.29	3.06	7.44	3.10	7.89	3.12	8.19	3.14
2.0 + 3.5 + 7.1	22	6.27	0.89	6.41	0.89	6.46	0.89	6.56	0.89	9.06	1.43	10.73	1.79
	25	7.15	1.50	7.33	1.48	7.40	1.47	7.52	1.46	9.40	1.81	10.64	2.04
	29	8.01	2.17	8.21	2.13	8.28	2.12	8.42	2.10	9.62	2.25	10.43	2.35
	32	8.38	2.55	8.61	2.52	8.68	2.51	8.83	2.49	10.78	2.53	12.07	2.55
	35	8.52	2.84	8.76	2.82	8.84	2.81	9.00	2.80	9.55	2.76	9.92	2.74
	40	8.29	2.98	8.52	2.99	8.60	3.00	8.76	3.00	8.64	2.92	8.91	2.89
	43	7.83	2.98	8.07	3.05	8.15	3.07	8.31	3.11	8.46	3.05	8.55	3.03
	46	7.14	2.92	7.38	3.02	7.46	3.06	7.61	3.10	8.07	3.12	8.38	3.14
2.0 + 4.2 + 4.2	22	6.13	0.96	6.27	0.96	6.32	0.96	6.41	0.96	8.86	1.55	10.49	1.94
	25	6.99	1.63	7.17	1.60	7.23	1.59	7.35	1.58	9.19	1.95	10.41	2.21
	29	7.83	2.35	8.03	2.31	8.10	2.30	8.23	2.28	9.41	2.44	10.20	2.54
	32	8.19	2.76	8.42	2.73	8.49	2.72	8.64	2.69	10.54	2.74	11.80	2.76
	35	8.33	3.08	8.57	3.05	8.64	3.05	8.80	3.03	9.34	2.99	9.70	2.96
	40	8.10	3.23	8.33	3.24	8.41	3.24	8.57	3.25	8.45	3.16	8.71	3.13
	43	7.66	3.23	7.89	3.30	7.97	3.32	8.12	3.37	8.27	3.30	8.36	3.28
	46	6.98	3.16	7.21	3.27	7.29	3.31	7.44	3.36	7.89	3.38	8.19	3.40
2.0 + 4.2 + 5.0	22	6.13	0.86	6.27	0.86	6.32	0.86	6.41	0.86	8.86	1.39	10.49	1.74
	25	6.99	1.46	7.17	1.44	7.23	1.43	7.35	1.42	9.19	1.75	10.41	1.98
	29	7.83	2.11	8.03	2.07	8.10	2.06	8.23	2.04	9.41	2.19	10.20	2.28
	32	8.19	2.48	8.42	2.45	8.49	2.44	8.64	2.42	10.54	2.46	11.80	2.48
	35	8.33	2.76	8.57	2.74	8.64	2.73	8.80	2.72	9.34	2.68	9.70	2.66
	40	8.10	2.90	8.33	2.91	8.41	2.91	8.57	2.92	8.45	2.84	8.71	2.81
	43	7.66	2.90	7.89	2.96	7.97	2.98	8.12	3.02	8.27	2.96	8.36	2.94
	46	6.98	2.83	7.21	2.94	7.29	2.97	7.44	3.02	7.89	3.03	8.19	3.05

Combination (Capacity)	Outdoor Air Temp. °C DB	Indoor Air Temp. °C											
		27/16		27/17.5		27/18		27/19		27/22		27/24	
		Total Q	Input Power	Total Q	Input Power	Total Q	Input Power	Total Q	Input Power	Total Q	Input Power	Total Q	Input Power
2.0 + 4.2 + 6.0	22	6.27	0.91	6.41	0.91	6.46	0.91	6.56	0.91	9.06	1.47	10.73	1.84
	25	7.15	1.54	7.33	1.52	7.40	1.51	7.52	1.50	9.40	1.85	10.64	2.09
	29	8.01	2.22	8.21	2.19	8.28	2.18	8.42	2.16	9.62	2.31	10.43	2.41
	32	8.38	2.62	8.61	2.58	8.68	2.57	8.83	2.55	10.78	2.59	12.07	2.62
	35	8.52	2.91	8.76	2.89	8.84	2.88	9.00	2.87	9.55	2.83	9.92	2.80
	40	8.29	3.06	8.52	3.07	8.60	3.07	8.76	3.08	8.64	2.99	8.91	2.96
	43	7.83	3.06	8.07	3.12	8.15	3.14	8.31	3.19	8.46	3.12	8.55	3.11
	46	7.14	2.99	7.38	3.10	7.46	3.14	7.61	3.18	8.07	3.20	8.38	3.22
2.0 + 4.2 + 7.1	22	6.27	0.89	6.41	0.89	6.46	0.89	6.56	0.89	9.06	1.43	10.73	1.79
	25	7.15	1.50	7.33	1.48	7.40	1.47	7.52	1.46	9.40	1.81	10.64	2.04
	29	8.01	2.17	8.21	2.13	8.28	2.12	8.42	2.10	9.62	2.25	10.43	2.35
	32	8.38	2.55	8.61	2.52	8.68	2.51	8.83	2.49	10.78	2.53	12.07	2.55
	35	8.52	2.84	8.76	2.82	8.84	2.81	9.00	2.80	9.55	2.76	9.92	2.74
	40	8.29	2.98	8.52	2.99	8.60	3.00	8.76	3.00	8.64	2.92	8.91	2.89
	43	7.83	2.98	8.07	3.05	8.15	3.07	8.31	3.11	8.46	3.05	8.55	3.03
	46	7.14	2.92	7.38	3.02	7.46	3.06	7.61	3.10	8.07	3.12	8.38	3.14
2.0 + 5.0 + 5.0	22	6.27	0.84	6.41	0.84	6.46	0.84	6.56	0.84	9.06	1.35	10.73	1.70
	25	7.15	1.42	7.33	1.40	7.40	1.39	7.52	1.38	9.40	1.71	10.64	1.93
	29	8.01	2.05	8.21	2.02	8.28	2.01	8.42	1.99	9.62	2.13	10.43	2.22
	32	8.38	2.42	8.61	2.39	8.68	2.38	8.83	2.36	10.78	2.39	12.07	2.42
	35	8.52	2.69	8.76	2.67	8.84	2.66	9.00	2.65	9.55	2.61	9.92	2.59
	40	8.29	2.82	8.52	2.83	8.60	2.84	8.76	2.84	8.64	2.76	8.91	2.74
	43	7.83	2.82	8.07	2.88	8.15	2.90	8.31	2.94	8.46	2.88	8.55	2.87
	46	7.14	2.76	7.38	2.86	7.46	2.90	7.61	2.94	8.07	2.95	8.38	2.97
2.0 + 5.0 + 6.0	22	6.27	0.84	6.41	0.84	6.46	0.84	6.56	0.84	9.06	1.35	10.73	1.70
	25	7.15	1.42	7.33	1.40	7.40	1.39	7.52	1.38	9.40	1.71	10.64	1.93
	29	8.01	2.05	8.21	2.02	8.28	2.01	8.42	1.99	9.62	2.13	10.43	2.22
	32	8.38	2.42	8.61	2.39	8.68	2.38	8.83	2.36	10.78	2.39	12.07	2.42
	35	8.52	2.69	8.76	2.67	8.84	2.66	9.00	2.65	9.55	2.61	9.92	2.59
	40	8.29	2.82	8.52	2.83	8.60	2.84	8.76	2.84	8.64	2.76	8.91	2.74
	43	7.83	2.82	8.07	2.88	8.15	2.90	8.31	2.94	8.46	2.88	8.55	2.87
	46	7.14	2.76	7.38	2.86	7.46	2.90	7.61	2.94	8.07	2.95	8.38	2.97
2.0 + 5.0 + 7.1	22	6.27	0.84	6.41	0.84	6.46	0.84	6.56	0.84	9.06	1.35	10.73	1.70
	25	7.15	1.42	7.33	1.40	7.40	1.39	7.52	1.38	9.40	1.71	10.64	1.93
	29	8.01	2.05	8.21	2.02	8.28	2.01	8.42	1.99	9.62	2.13	10.43	2.22
	32	8.38	2.42	8.61	2.39	8.68	2.38	8.83	2.36	10.78	2.39	12.07	2.42
	35	8.52	2.69	8.76	2.67	8.84	2.66	9.00	2.65	9.55	2.61	9.92	2.59
	40	8.29	2.82	8.52	2.83	8.60	2.84	8.76	2.84	8.64	2.76	8.91	2.74
	43	7.83	2.82	8.07	2.88	8.15	2.90	8.31	2.94	8.46	2.88	8.55	2.87
	46	7.14	2.76	7.38	2.86	7.46	2.90	7.61	2.94	8.07	2.95	8.38	2.97

Combination (Capacity)	Outdoor Air Temp. °C DB	Indoor Air Temp. °C											
		27/16		27/17.5		27/18		27/19		27/22		27/24	
		Total Q	Input Power	Total Q	Input Power	Total Q	Input Power	Total Q	Input Power	Total Q	Input Power	Total Q	Input Power
2.0 + 4.2 + 6.0	22	6.27	0.91	6.41	0.91	6.46	0.91	6.56	0.91	9.06	1.47	10.73	1.84
	25	7.15	1.54	7.33	1.52	7.40	1.51	7.52	1.50	9.40	1.85	10.64	2.09
	29	8.01	2.22	8.21	2.19	8.28	2.18	8.42	2.16	9.62	2.31	10.43	2.41
	32	8.38	2.62	8.61	2.58	8.68	2.57	8.83	2.55	10.78	2.59	12.07	2.62
	35	8.52	2.91	8.76	2.89	8.84	2.88	9.00	2.87	9.55	2.83	9.92	2.80
	40	8.29	3.06	8.52	3.07	8.60	3.07	8.76	3.08	8.64	2.99	8.91	2.96
	43	7.83	3.06	8.07	3.12	8.15	3.14	8.31	3.19	8.46	3.12	8.55	3.11
	46	7.14	2.99	7.38	3.10	7.46	3.14	7.61	3.18	8.07	3.20	8.38	3.22
2.0 + 4.2 + 7.1	22	6.27	0.89	6.41	0.89	6.46	0.89	6.56	0.89	9.06	1.43	10.73	1.79
	25	7.15	1.50	7.33	1.48	7.40	1.47	7.52	1.46	9.40	1.81	10.64	2.04
	29	8.01	2.17	8.21	2.13	8.28	2.12	8.42	2.10	9.62	2.25	10.43	2.35
	32	8.38	2.55	8.61	2.52	8.68	2.51	8.83	2.49	10.78	2.53	12.07	2.55
	35	8.52	2.84	8.76	2.82	8.84	2.81	9.00	2.80	9.55	2.76	9.92	2.74
	40	8.29	2.98	8.52	2.99	8.60	3.00	8.76	3.00	8.64	2.92	8.91	2.89
	43	7.83	2.98	8.07	3.05	8.15	3.07	8.31	3.11	8.46	3.05	8.55	3.03
	46	7.14	2.92	7.38	3.02	7.46	3.06	7.61	3.10	8.07	3.12	8.38	3.14
2.0 + 5.0 + 5.0	22	6.27	0.84	6.41	0.84	6.46	0.84	6.56	0.84	9.06	1.35	10.73	1.70
	25	7.15	1.42	7.33	1.40	7.40	1.39	7.52	1.38	9.40	1.71	10.64	1.93
	29	8.01	2.05	8.21	2.02	8.28	2.01	8.42	1.99	9.62	2.13	10.43	2.22
	32	8.38	2.42	8.61	2.39	8.68	2.38	8.83	2.36	10.78	2.39	12.07	2.42
	35	8.52	2.69	8.76	2.67	8.84	2.66	9.00	2.65	9.55	2.61	9.92	2.59
	40	8.29	2.82	8.52	2.83	8.60	2.84	8.76	2.84	8.64	2.76	8.91	2.74
	43	7.83	2.82	8.07	2.88	8.15	2.90	8.31	2.94	8.46	2.88	8.55	2.87
	46	7.14	2.76	7.38	2.86	7.46	2.90	7.61	2.94	8.07	2.95	8.38	2.97
2.0 + 5.0 + 6.0	22	6.27	0.84	6.41	0.84	6.46	0.84	6.56	0.84	9.06	1.35	10.73	1.70
	25	7.15	1.42	7.33	1.40	7.40	1.39	7.52	1.38	9.40	1.71	10.64	1.93
	29	8.01	2.05	8.21	2.02	8.28	2.01	8.42	1.99	9.62	2.13	10.43	2.22
	32	8.38	2.42	8.61	2.39	8.68	2.38	8.83	2.36	10.78	2.39	12.07	2.42
	35	8.52	2.69	8.76	2.67	8.84	2.66	9.00	2.65	9.55	2.61	9.92	2.59
	40	8.29	2.82	8.52	2.83	8.60	2.84	8.76	2.84	8.64	2.76	8.91	2.74
	43	7.83	2.82	8.07	2.88	8.15	2.90	8.31	2.94	8.46	2.88	8.55	2.87
	46	7.14	2.76	7.38	2.86	7.46	2.90	7.61	2.94	8.07	2.95	8.38	2.97
2.0 + 5.0 + 7.1	22	6.27	0.84	6.41	0.84	6.46	0.84	6.56	0.84	9.06	1.35	10.73	1.70
	25	7.15	1.42	7.33	1.40	7.40	1.39	7.52	1.38	9.40	1.71	10.64	1.93
	29	8.01	2.05	8.21	2.02	8.28	2.01	8.42	1.99	9.62	2.13	10.43	2.22
	32	8.38	2.42	8.61	2.39	8.68	2.38	8.83	2.36	10.78	2.39	12.07	2.42
	35	8.52	2.69	8.76	2.67	8.84	2.66	9.00	2.65	9.55	2.61	9.92	2.59
	40	8.29	2.82	8.52	2.83	8.60	2.84	8.76	2.84	8.64	2.76	8.91	2.74
	43	7.83	2.82	8.07	2.88	8.15	2.90	8.31	2.94	8.46	2.88	8.55	2.87
	46	7.14	2.76	7.38	2.86	7.46	2.90	7.61	2.94	8.07	2.95	8.38	2.97

Combination (Capacity)	Outdoor Air Temp. °C DB	Indoor Air Temp. °C											
		27/16		27/17.5		27/18		27/19		27/22		27/24	
		Total Q	Input Power	Total Q	Input Power	Total Q	Input Power	Total Q	Input Power	Total Q	Input Power	Total Q	Input Power
2.0 + 6.0 + 6.0	22	6.27	0.84	6.41	0.84	6.46	0.84	6.56	0.84	9.06	1.35	10.73	1.70
	25	7.15	1.42	7.33	1.40	7.40	1.39	7.52	1.38	9.40	1.71	10.64	1.93
	29	8.01	2.05	8.21	2.02	8.28	2.01	8.42	1.99	9.62	2.13	10.43	2.22
	32	8.38	2.42	8.61	2.39	8.68	2.38	8.83	2.36	10.78	2.39	12.07	2.42
	35	8.52	2.69	8.76	2.67	8.84	2.66	9.00	2.65	9.55	2.61	9.92	2.59
	40	8.29	2.82	8.52	2.83	8.60	2.84	8.76	2.84	8.64	2.76	8.91	2.74
	43	7.83	2.82	8.07	2.88	8.15	2.90	8.31	2.94	8.46	2.88	8.55	2.87
	46	7.14	2.76	7.38	2.86	7.46	2.90	7.61	2.94	8.07	2.95	8.38	2.97
2.5 + 2.5 + 2.5	22	5.92	0.96	6.06	0.96	6.10	0.96	6.19	0.96	8.56	1.55	10.13	1.94
	25	6.75	1.63	6.93	1.60	6.99	1.59	7.10	1.58	8.87	1.95	10.05	2.21
	29	7.56	2.35	7.76	2.31	7.82	2.30	7.95	2.28	9.09	2.44	9.85	2.54
	32	7.91	2.76	8.13	2.73	8.20	2.72	8.34	2.69	10.18	2.74	11.40	2.76
	35	8.05	3.08	8.28	3.05	8.35	3.05	8.50	3.03	9.02	2.99	9.37	2.96
	40	7.83	3.23	8.05	3.24	8.13	3.24	8.28	3.25	8.16	3.16	8.42	3.13
	43	7.40	3.23	7.62	3.30	7.70	3.32	7.85	3.37	7.99	3.30	8.08	3.28
	46	6.74	3.16	6.97	3.27	7.04	3.31	7.19	3.36	7.62	3.38	7.91	3.40
2.5 + 2.5 + 3.5	22	5.99	0.96	6.13	0.96	6.17	0.96	6.27	0.96	8.66	1.55	10.25	1.94
	25	6.83	1.63	7.01	1.60	7.07	1.59	7.19	1.58	8.98	1.95	10.17	2.21
	29	7.65	2.35	7.85	2.31	7.91	2.30	8.05	2.28	9.20	2.44	9.96	2.54
	32	8.01	2.76	8.22	2.73	8.30	2.72	8.44	2.69	10.30	2.74	11.53	2.76
	35	8.15	3.08	8.37	3.05	8.45	3.05	8.60	3.03	9.13	2.99	9.48	2.96
	40	7.92	3.23	8.15	3.24	8.22	3.24	8.37	3.25	8.26	3.16	8.51	3.13
	43	7.48	3.23	7.71	3.30	7.79	3.32	7.94	3.37	8.08	3.30	8.17	3.28
	46	6.82	3.16	7.05	3.27	7.12	3.31	7.28	3.36	7.71	3.38	8.01	3.40
2.5 + 2.5 + 4.2	22	5.99	0.96	6.13	0.96	6.17	0.96	6.27	0.96	8.66	1.55	10.25	1.94
	25	6.83	1.63	7.01	1.60	7.07	1.59	7.19	1.58	8.98	1.95	10.17	2.21
	29	7.65	2.35	7.85	2.31	7.91	2.30	8.05	2.28	9.20	2.44	9.96	2.54
	32	8.01	2.76	8.22	2.73	8.30	2.72	8.44	2.69	10.30	2.74	11.53	2.76
	35	8.15	3.08	8.37	3.05	8.45	3.05	8.60	3.03	9.13	2.99	9.48	2.96
	40	7.92	3.23	8.15	3.24	8.22	3.24	8.37	3.25	8.26	3.16	8.51	3.13
	43	7.48	3.23	7.71	3.30	7.79	3.32	7.94	3.37	8.08	3.30	8.17	3.28
	46	6.82	3.16	7.05	3.27	7.12	3.31	7.28	3.36	7.71	3.38	8.01	3.40
2.5 + 2.5 + 5.0	22	6.13	0.89	6.27	0.89	6.32	0.89	6.41	0.89	8.86	1.43	10.49	1.79
	25	6.99	1.50	7.17	1.48	7.23	1.47	7.35	1.46	9.19	1.81	10.41	2.04
	29	7.83	2.17	8.03	2.13	8.10	2.12	8.23	2.10	9.41	2.25	10.20	2.35
	32	8.19	2.55	8.42	2.52	8.49	2.51	8.64	2.49	10.54	2.53	11.80	2.55
	35	8.33	2.84	8.57	2.82	8.64	2.81	8.80	2.80	9.34	2.76	9.70	2.74
	40	8.10	2.98	8.33	2.99	8.41	3.00	8.57	3.00	8.45	2.92	8.71	2.89
	43	7.66	2.98	7.89	3.05	7.97	3.07	8.12	3.11	8.27	3.05	8.36	3.03
	46	6.98	2.92	7.21	3.02	7.29	3.06	7.44	3.10	7.89	3.12	8.19	3.14

Combination (Capacity)	Outdoor Air Temp. °C DB	Indoor Air Temp. °C											
		27/16		27/17.5		27/18		27/19		27/22		27/24	
		Total Q	Input Power	Total Q	Input Power	Total Q	Input Power	Total Q	Input Power	Total Q	Input Power	Total Q	Input Power
2.5 + 2.5 + 6.0	22	6.13	0.89	6.27	0.89	6.32	0.89	6.41	0.89	8.86	1.43	10.49	1.79
	25	6.99	1.50	7.17	1.48	7.23	1.47	7.35	1.46	9.19	1.81	10.41	2.04
	29	7.83	2.17	8.03	2.13	8.10	2.12	8.23	2.10	9.41	2.25	10.20	2.35
	32	8.19	2.55	8.42	2.52	8.49	2.51	8.64	2.49	10.54	2.53	11.80	2.55
	35	8.33	2.84	8.57	2.82	8.64	2.81	8.80	2.80	9.34	2.76	9.70	2.74
	40	8.10	2.98	8.33	2.99	8.41	3.00	8.57	3.00	8.45	2.92	8.71	2.89
	43	7.66	2.98	7.89	3.05	7.97	3.07	8.12	3.11	8.27	3.05	8.36	3.03
	46	6.98	2.92	7.21	3.02	7.29	3.06	7.44	3.10	7.89	3.12	8.19	3.14
2.5 + 2.5 + 7.1	22	6.27	0.91	6.41	0.91	6.46	0.91	6.56	0.91	9.06	1.47	10.73	1.84
	25	7.15	1.54	7.33	1.52	7.40	1.51	7.52	1.50	9.40	1.85	10.64	2.09
	29	8.01	2.22	8.21	2.19	8.28	2.18	8.42	2.16	9.62	2.31	10.43	2.41
	32	8.38	2.62	8.61	2.58	8.68	2.57	8.83	2.55	10.78	2.59	12.07	2.62
	35	8.52	2.91	8.76	2.89	8.84	2.88	9.00	2.87	9.55	2.83	9.92	2.80
	40	8.29	3.06	8.52	3.07	8.60	3.07	8.76	3.08	8.64	2.99	8.91	2.96
	43	7.83	3.06	8.07	3.12	8.15	3.14	8.31	3.19	8.46	3.12	8.55	3.11
	46	7.14	2.99	7.38	3.10	7.46	3.14	7.61	3.18	8.07	3.20	8.38	3.22
2.5 + 3.5 + 3.5	22	5.99	0.94	6.13	0.94	6.17	0.94	6.27	0.94	8.66	1.51	10.25	1.89
	25	6.83	1.58	7.01	1.56	7.07	1.55	7.19	1.54	8.98	1.90	10.17	2.15
	29	7.65	2.28	7.85	2.25	7.91	2.24	8.05	2.22	9.20	2.37	9.96	2.48
	32	8.01	2.69	8.22	2.66	8.30	2.64	8.44	2.62	10.30	2.66	11.53	2.69
	35	8.15	3.00	8.37	2.97	8.45	2.97	8.60	2.95	9.13	2.91	9.48	2.88
	40	7.92	3.14	8.15	3.15	8.22	3.16	8.37	3.16	8.26	3.08	8.51	3.05
	43	7.48	3.14	7.71	3.21	7.79	3.23	7.94	3.28	8.08	3.21	8.17	3.19
	46	6.82	3.07	7.05	3.19	7.12	3.22	7.28	3.27	7.71	3.29	8.01	3.31
2.5 + 3.5 + 4.2	22	6.13	0.99	6.27	0.99	6.32	0.99	6.41	0.99	8.86	1.58	10.49	1.98
	25	6.99	1.66	7.17	1.64	7.23	1.63	7.35	1.62	9.19	2.00	10.41	2.26
	29	7.83	2.40	8.03	2.36	8.10	2.35	8.23	2.33	9.41	2.49	10.20	2.60
	32	8.19	2.83	8.42	2.79	8.49	2.78	8.64	2.76	10.54	2.80	11.80	2.83
	35	8.33	3.15	8.57	3.12	8.64	3.12	8.80	3.10	9.34	3.06	9.70	3.03
	40	8.10	3.30	8.33	3.31	8.41	3.32	8.57	3.33	8.45	3.23	8.71	3.20
	43	7.66	3.30	7.89	3.37	7.97	3.40	8.12	3.44	8.27	3.37	8.36	3.36
	46	6.98	3.23	7.21	3.35	7.29	3.39	7.44	3.44	7.89	3.45	8.19	3.47
2.5 + 3.5 + 5.0	22	6.13	0.89	6.27	0.89	6.32	0.89	6.41	0.89	8.86	1.43	10.49	1.79
	25	6.99	1.50	7.17	1.48	7.23	1.47	7.35	1.46	9.19	1.81	10.41	2.04
	29	7.83	2.17	8.03	2.13	8.10	2.12	8.23	2.10	9.41	2.25	10.20	2.35
	32	8.19	2.55	8.42	2.52	8.49	2.51	8.64	2.49	10.54	2.53	11.80	2.55
	35	8.33	2.84	8.57	2.82	8.64	2.81	8.80	2.80	9.34	2.76	9.70	2.74
	40	8.10	2.98	8.33	2.99	8.41	3.00	8.57	3.00	8.45	2.92	8.71	2.89
	43	7.66	2.98	7.89	3.05	7.97	3.07	8.12	3.11	8.27	3.05	8.36	3.03
	46	6.98	2.92	7.21	3.02	7.29	3.06	7.44	3.10	7.89	3.12	8.19	3.14

Combination (Capacity)	Outdoor Air Temp. °C DB	Indoor Air Temp. °C											
		27/16		27/17.5		27/18		27/19		27/22		27/24	
		Total Q	Input Power	Total Q	Input Power	Total Q	Input Power	Total Q	Input Power	Total Q	Input Power	Total Q	Input Power
2.5 + 3.5 + 6.0	22	6.27	0.91	6.41	0.91	6.46	0.91	6.56	0.91	9.06	1.47	10.73	1.84
	25	7.15	1.54	7.33	1.52	7.40	1.51	7.52	1.50	9.40	1.85	10.64	2.09
	29	8.01	2.22	8.21	2.19	8.28	2.18	8.42	2.16	9.62	2.31	10.43	2.41
	32	8.38	2.62	8.61	2.58	8.68	2.57	8.83	2.55	10.78	2.59	12.07	2.62
	35	8.52	2.91	8.76	2.89	8.84	2.88	9.00	2.87	9.55	2.83	9.92	2.80
	40	8.29	3.06	8.52	3.07	8.60	3.07	8.76	3.08	8.64	2.99	8.91	2.96
	43	7.83	3.06	8.07	3.12	8.15	3.14	8.31	3.19	8.46	3.12	8.55	3.11
	46	7.14	2.99	7.38	3.10	7.46	3.14	7.61	3.18	8.07	3.20	8.38	3.22
2.5 + 3.5 + 7.1	22	6.27	0.89	6.41	0.89	6.46	0.89	6.56	0.89	9.06	1.43	10.73	1.79
	25	7.15	1.50	7.33	1.48	7.40	1.47	7.52	1.46	9.40	1.81	10.64	2.04
	29	8.01	2.17	8.21	2.13	8.28	2.12	8.42	2.10	9.62	2.25	10.43	2.35
	32	8.38	2.55	8.61	2.52	8.68	2.51	8.83	2.49	10.78	2.53	12.07	2.55
	35	8.52	2.84	8.76	2.82	8.84	2.81	9.00	2.80	9.55	2.76	9.92	2.74
	40	8.29	2.98	8.52	2.99	8.60	3.00	8.76	3.00	8.64	2.92	8.91	2.89
	43	7.83	2.98	8.07	3.05	8.15	3.07	8.31	3.11	8.46	3.05	8.55	3.03
	46	7.14	2.92	7.38	3.02	7.46	3.06	7.61	3.10	8.07	3.12	8.38	3.14
2.5 + 4.2 + 4.2	22	6.13	0.96	6.27	0.96	6.32	0.96	6.41	0.96	8.86	1.55	10.49	1.94
	25	6.99	1.63	7.17	1.60	7.23	1.59	7.35	1.58	9.19	1.95	10.41	2.21
	29	7.83	2.35	8.03	2.31	8.10	2.30	8.23	2.28	9.41	2.44	10.20	2.54
	32	8.19	2.76	8.42	2.73	8.49	2.72	8.64	2.69	10.54	2.74	11.80	2.76
	35	8.33	3.08	8.57	3.05	8.64	3.05	8.80	3.03	9.34	2.99	9.70	2.96
	40	8.10	3.23	8.33	3.24	8.41	3.24	8.57	3.25	8.45	3.16	8.71	3.13
	43	7.66	3.23	7.89	3.30	7.97	3.32	8.12	3.37	8.27	3.30	8.36	3.28
	46	6.98	3.16	7.21	3.27	7.29	3.31	7.44	3.36	7.89	3.38	8.19	3.40
2.5 + 4.2 + 5.0	22	6.13	0.86	6.27	0.86	6.32	0.86	6.41	0.86	8.86	1.39	10.49	1.74
	25	6.99	1.46	7.17	1.44	7.23	1.43	7.35	1.42	9.19	1.75	10.41	1.98
	29	7.83	2.11	8.03	2.07	8.10	2.06	8.23	2.04	9.41	2.19	10.20	2.28
	32	8.19	2.48	8.42	2.45	8.49	2.44	8.64	2.42	10.54	2.46	11.80	2.48
	35	8.33	2.76	8.57	2.74	8.64	2.73	8.80	2.72	9.34	2.68	9.70	2.66
	40	8.10	2.90	8.33	2.91	8.41	2.91	8.57	2.92	8.45	2.84	8.71	2.81
	43	7.66	2.90	7.89	2.96	7.97	2.98	8.12	3.02	8.27	2.96	8.36	2.94
	46	6.98	2.83	7.21	2.94	7.29	2.97	7.44	3.02	7.89	3.03	8.19	3.05
2.5 + 4.2 + 6.0	22	6.27	0.91	6.41	0.91	6.46	0.91	6.56	0.91	9.06	1.47	10.73	1.84
	25	7.15	1.54	7.33	1.52	7.40	1.51	7.52	1.50	9.40	1.85	10.64	2.09
	29	8.01	2.22	8.21	2.19	8.28	2.18	8.42	2.16	9.62	2.31	10.43	2.41
	32	8.38	2.62	8.61	2.58	8.68	2.57	8.83	2.55	10.78	2.59	12.07	2.62
	35	8.52	2.91	8.76	2.89	8.84	2.88	9.00	2.87	9.55	2.83	9.92	2.80
	40	8.29	3.06	8.52	3.07	8.60	3.07	8.76	3.08	8.64	2.99	8.91	2.96
	43	7.83	3.06	8.07	3.12	8.15	3.14	8.31	3.19	8.46	3.12	8.55	3.11
	46	7.14	2.99	7.38	3.10	7.46	3.14	7.61	3.18	8.07	3.20	8.38	3.22



Combination (Capacity)	Outdoor Air Temp. °C DB	Indoor Air Temp. °C											
		27/16		27/17.5		27/18		27/19		27/22		27/24	
		Total Q	Input Power	Total Q	Input Power	Total Q	Input Power	Total Q	Input Power	Total Q	Input Power	Total Q	Input Power
2.5 + 4.2 + 7.1	22	6.27	0.89	6.41	0.89	6.46	0.89	6.56	0.89	9.06	1.43	10.73	1.79
	25	7.15	1.50	7.33	1.48	7.40	1.47	7.52	1.46	9.40	1.81	10.64	2.04
	29	8.01	2.17	8.21	2.13	8.28	2.12	8.42	2.10	9.62	2.25	10.43	2.35
	32	8.38	2.55	8.61	2.52	8.68	2.51	8.83	2.49	10.78	2.53	12.07	2.55
	35	8.52	2.84	8.76	2.82	8.84	2.81	9.00	2.80	9.55	2.76	9.92	2.74
	40	8.29	2.98	8.52	2.99	8.60	3.00	8.76	3.00	8.64	2.92	8.91	2.89
	43	7.83	2.98	8.07	3.05	8.15	3.07	8.31	3.11	8.46	3.05	8.55	3.03
	46	7.14	2.92	7.38	3.02	7.46	3.06	7.61	3.10	8.07	3.12	8.38	3.14
2.5 + 5.0 + 5.0	22	6.27	0.84	6.41	0.84	6.46	0.84	6.56	0.84	9.06	1.35	10.73	1.70
	25	7.15	1.42	7.33	1.40	7.40	1.39	7.52	1.38	9.40	1.71	10.64	1.93
	29	8.01	2.05	8.21	2.02	8.28	2.01	8.42	1.99	9.62	2.13	10.43	2.22
	32	8.38	2.42	8.61	2.39	8.68	2.38	8.83	2.36	10.78	2.39	12.07	2.42
	35	8.52	2.69	8.76	2.67	8.84	2.66	9.00	2.65	9.55	2.61	9.92	2.59
	40	8.29	2.82	8.52	2.83	8.60	2.84	8.76	2.84	8.64	2.76	8.91	2.74
	43	7.83	2.82	8.07	2.88	8.15	2.90	8.31	2.94	8.46	2.88	8.55	2.87
	46	7.14	2.76	7.38	2.86	7.46	2.90	7.61	2.94	8.07	2.95	8.38	2.97
2.5 + 5.0 + 6.0	22	6.27	0.84	6.41	0.84	6.46	0.84	6.56	0.84	9.06	1.35	10.73	1.70
	25	7.15	1.42	7.33	1.40	7.40	1.39	7.52	1.38	9.40	1.71	10.64	1.93
	29	8.01	2.05	8.21	2.02	8.28	2.01	8.42	1.99	9.62	2.13	10.43	2.22
	32	8.38	2.42	8.61	2.39	8.68	2.38	8.83	2.36	10.78	2.39	12.07	2.42
	35	8.52	2.69	8.76	2.67	8.84	2.66	9.00	2.65	9.55	2.61	9.92	2.59
	40	8.29	2.82	8.52	2.83	8.60	2.84	8.76	2.84	8.64	2.76	8.91	2.74
	43	7.83	2.82	8.07	2.88	8.15	2.90	8.31	2.94	8.46	2.88	8.55	2.87
	46	7.14	2.76	7.38	2.86	7.46	2.90	7.61	2.94	8.07	2.95	8.38	2.97
2.5 + 5.0 + 7.1	22	6.27	0.84	6.41	0.84	6.46	0.84	6.56	0.84	9.06	1.35	10.73	1.70
	25	7.15	1.42	7.33	1.40	7.40	1.39	7.52	1.38	9.40	1.71	10.64	1.93
	29	8.01	2.05	8.21	2.02	8.28	2.01	8.42	1.99	9.62	2.13	10.43	2.22
	32	8.38	2.42	8.61	2.39	8.68	2.38	8.83	2.36	10.78	2.39	12.07	2.42
	35	8.52	2.69	8.76	2.67	8.84	2.66	9.00	2.65	9.55	2.61	9.92	2.59
	40	8.29	2.82	8.52	2.83	8.60	2.84	8.76	2.84	8.64	2.76	8.91	2.74
	43	7.83	2.82	8.07	2.88	8.15	2.90	8.31	2.94	8.46	2.88	8.55	2.87
	46	7.14	2.76	7.38	2.86	7.46	2.90	7.61	2.94	8.07	2.95	8.38	2.97
2.5 + 6.0 + 6.0	22	6.27	0.84	6.41	0.84	6.46	0.84	6.56	0.84	9.06	1.35	10.73	1.70
	25	7.15	1.42	7.33	1.40	7.40	1.39	7.52	1.38	9.40	1.71	10.64	1.93
	29	8.01	2.05	8.21	2.02	8.28	2.01	8.42	1.99	9.62	2.13	10.43	2.22
	32	8.38	2.42	8.61	2.39	8.68	2.38	8.83	2.36	10.78	2.39	12.07	2.42
	35	8.52	2.69	8.76	2.67	8.84	2.66	9.00	2.65	9.55	2.61	9.92	2.59
	40	8.29	2.82	8.52	2.83	8.60	2.84	8.76	2.84	8.64	2.76	8.91	2.74
	43	7.83	2.82	8.07	2.88	8.15	2.90	8.31	2.94	8.46	2.88	8.55	2.87
	46	7.14	2.76	7.38	2.86	7.46	2.90	7.61	2.94	8.07	2.95	8.38	2.97

Combination (Capacity)	Outdoor Air Temp. °C DB	Indoor Air Temp. °C											
		27/16		27/17.5		27/18		27/19		27/22		27/24	
		Total Q	Input Power	Total Q	Input Power	Total Q	Input Power	Total Q	Input Power	Total Q	Input Power	Total Q	Input Power
3.5 + 3.5 + 3.5	22	6.13	0.96	6.27	0.96	6.32	0.96	6.41	0.96	8.86	1.55	10.49	1.94
	25	6.99	1.63	7.17	1.60	7.23	1.59	7.35	1.58	9.19	1.95	10.41	2.21
	29	7.83	2.35	8.03	2.31	8.10	2.30	8.23	2.28	9.41	2.44	10.20	2.54
	32	8.19	2.76	8.42	2.73	8.49	2.72	8.64	2.69	10.54	2.74	11.80	2.76
	35	8.33	3.08	8.57	3.05	8.64	3.05	8.80	3.03	9.34	2.99	9.70	2.96
	40	8.10	3.23	8.33	3.24	8.41	3.24	8.57	3.25	8.45	3.16	8.71	3.13
	43	7.66	3.23	7.89	3.30	7.97	3.32	8.12	3.37	8.27	3.30	8.36	3.28
	46	6.98	3.16	7.21	3.27	7.29	3.31	7.44	3.36	7.89	3.38	8.19	3.40
3.5 + 3.5 + 4.2	22	6.13	0.96	6.27	0.96	6.32	0.96	6.41	0.96	8.86	1.55	10.49	1.94
	25	6.99	1.63	7.17	1.60	7.23	1.59	7.35	1.58	9.19	1.95	10.41	2.21
	29	7.83	2.35	8.03	2.31	8.10	2.30	8.23	2.28	9.41	2.44	10.20	2.54
	32	8.19	2.76	8.42	2.73	8.49	2.72	8.64	2.69	10.54	2.74	11.80	2.76
	35	8.33	3.08	8.57	3.05	8.64	3.05	8.80	3.03	9.34	2.99	9.70	2.96
	40	8.10	3.23	8.33	3.24	8.41	3.24	8.57	3.25	8.45	3.16	8.71	3.13
	43	7.66	3.23	7.89	3.30	7.97	3.32	8.12	3.37	8.27	3.30	8.36	3.28
	46	6.98	3.16	7.21	3.27	7.29	3.31	7.44	3.36	7.89	3.38	8.19	3.40
3.5 + 3.5 + 5.0	22	6.27	0.91	6.41	0.91	6.46	0.91	6.56	0.91	9.06	1.47	10.73	1.84
	25	7.15	1.54	7.33	1.52	7.40	1.51	7.52	1.50	9.40	1.85	10.64	2.09
	29	8.01	2.22	8.21	2.19	8.28	2.18	8.42	2.16	9.62	2.31	10.43	2.41
	32	8.38	2.62	8.61	2.58	8.68	2.57	8.83	2.55	10.78	2.59	12.07	2.62
	35	8.52	2.91	8.76	2.89	8.84	2.88	9.00	2.87	9.55	2.83	9.92	2.80
	40	8.29	3.06	8.52	3.07	8.60	3.07	8.76	3.08	8.64	2.99	8.91	2.96
	43	7.83	3.06	8.07	3.12	8.15	3.14	8.31	3.19	8.46	3.12	8.55	3.11
	46	7.14	2.99	7.38	3.10	7.46	3.14	7.61	3.18	8.07	3.20	8.38	3.22
3.5 + 3.5 + 6.0	22	6.27	0.91	6.41	0.91	6.46	0.91	6.56	0.91	9.06	1.47	10.73	1.84
	25	7.15	1.54	7.33	1.52	7.40	1.51	7.52	1.50	9.40	1.85	10.64	2.09
	29	8.01	2.22	8.21	2.19	8.28	2.18	8.42	2.16	9.62	2.31	10.43	2.41
	32	8.38	2.62	8.61	2.58	8.68	2.57	8.83	2.55	10.78	2.59	12.07	2.62
	35	8.52	2.91	8.76	2.89	8.84	2.88	9.00	2.87	9.55	2.83	9.92	2.80
	40	8.29	3.06	8.52	3.07	8.60	3.07	8.76	3.08	8.64	2.99	8.91	2.96
	43	7.83	3.06	8.07	3.12	8.15	3.14	8.31	3.19	8.46	3.12	8.55	3.11
	46	7.14	2.99	7.38	3.10	7.46	3.14	7.61	3.18	8.07	3.20	8.38	3.22
3.5 + 3.5 + 7.1	22	6.27	0.89	6.41	0.89	6.46	0.89	6.56	0.89	9.06	1.43	10.73	1.79
	25	7.15	1.50	7.33	1.48	7.40	1.47	7.52	1.46	9.40	1.81	10.64	2.04
	29	8.01	2.17	8.21	2.13	8.28	2.12	8.42	2.10	9.62	2.25	10.43	2.35
	32	8.38	2.55	8.61	2.52	8.68	2.51	8.83	2.49	10.78	2.53	12.07	2.55
	35	8.52	2.84	8.76	2.82	8.84	2.81	9.00	2.80	9.55	2.76	9.92	2.74
	40	8.29	2.98	8.52	2.99	8.60	3.00	8.76	3.00	8.64	2.92	8.91	2.89
	43	7.83	2.98	8.07	3.05	8.15	3.07	8.31	3.11	8.46	3.05	8.55	3.03
	46	7.14	2.92	7.38	3.02	7.46	3.06	7.61	3.10	8.07	3.12	8.38	3.14

Combination (Capacity)	Outdoor Air Temp. °C DB	Indoor Air Temp. °C											
		27/16		27/17.5		27/18		27/19		27/22		27/24	
		Total Q	Input Power	Total Q	Input Power	Total Q	Input Power	Total Q	Input Power	Total Q	Input Power	Total Q	Input Power
3.5 + 4.2 + 4.2	22	6.27	0.99	6.41	0.99	6.46	0.99	6.56	0.99	9.06	1.58	10.73	1.98
	25	7.15	1.66	7.33	1.64	7.40	1.63	7.52	1.62	9.40	2.00	10.64	2.26
	29	8.01	2.40	8.21	2.36	8.28	2.35	8.42	2.33	9.62	2.49	10.43	2.60
	32	8.38	2.83	8.61	2.79	8.68	2.78	8.83	2.76	10.78	2.80	12.07	2.83
	35	8.52	3.15	8.76	3.12	8.84	3.12	9.00	3.10	9.55	3.06	9.92	3.03
	40	8.29	3.30	8.52	3.31	8.60	3.32	8.76	3.33	8.64	3.23	8.91	3.20
	43	7.83	3.30	8.07	3.37	8.15	3.40	8.31	3.44	8.46	3.37	8.55	3.36
	46	7.14	3.23	7.38	3.35	7.46	3.39	7.61	3.44	8.07	3.45	8.38	3.47
3.5 + 4.2 + 5.0	22	6.27	0.89	6.41	0.89	6.46	0.89	6.56	0.89	9.06	1.43	10.73	1.79
	25	7.15	1.50	7.33	1.48	7.40	1.47	7.52	1.46	9.40	1.81	10.64	2.04
	29	8.01	2.17	8.21	2.13	8.28	2.12	8.42	2.10	9.62	2.25	10.43	2.35
	32	8.38	2.55	8.61	2.52	8.68	2.51	8.83	2.49	10.78	2.53	12.07	2.55
	35	8.52	2.84	8.76	2.82	8.84	2.81	9.00	2.80	9.55	2.76	9.92	2.74
	40	8.29	2.98	8.52	2.99	8.60	3.00	8.76	3.00	8.64	2.92	8.91	2.89
	43	7.83	2.98	8.07	3.05	8.15	3.07	8.31	3.11	8.46	3.05	8.55	3.03
	46	7.14	2.92	7.38	3.02	7.46	3.06	7.61	3.10	8.07	3.12	8.38	3.14
3.5 + 4.2 + 6.0	22	6.27	0.89	6.41	0.89	6.46	0.89	6.56	0.89	9.06	1.43	10.73	1.79
	25	7.15	1.50	7.33	1.48	7.40	1.47	7.52	1.46	9.40	1.81	10.64	2.04
	29	8.01	2.17	8.21	2.13	8.28	2.12	8.42	2.10	9.62	2.25	10.43	2.35
	32	8.38	2.55	8.61	2.52	8.68	2.51	8.83	2.49	10.78	2.53	12.07	2.55
	35	8.52	2.84	8.76	2.82	8.84	2.81	9.00	2.80	9.55	2.76	9.92	2.74
	40	8.29	2.98	8.52	2.99	8.60	3.00	8.76	3.00	8.64	2.92	8.91	2.89
	43	7.83	2.98	8.07	3.05	8.15	3.07	8.31	3.11	8.46	3.05	8.55	3.03
	46	7.14	2.92	7.38	3.02	7.46	3.06	7.61	3.10	8.07	3.12	8.38	3.14
3.5 + 5.0 + 5.0	22	6.27	0.84	6.41	0.84	6.46	0.84	6.56	0.84	9.06	1.35	10.73	1.70
	25	7.15	1.42	7.33	1.40	7.40	1.39	7.52	1.38	9.40	1.71	10.64	1.93
	29	8.01	2.05	8.21	2.02	8.28	2.01	8.42	1.99	9.62	2.13	10.43	2.22
	32	8.38	2.42	8.61	2.39	8.68	2.38	8.83	2.36	10.78	2.39	12.07	2.42
	35	8.52	2.69	8.76	2.67	8.84	2.66	9.00	2.65	9.55	2.61	9.92	2.59
	40	8.29	2.82	8.52	2.83	8.60	2.84	8.76	2.84	8.64	2.76	8.91	2.74
	43	7.83	2.82	8.07	2.88	8.15	2.90	8.31	2.94	8.46	2.88	8.55	2.87
	46	7.14	2.76	7.38	2.86	7.46	2.90	7.61	2.94	8.07	2.95	8.38	2.97
3.5 + 5.0 + 6.0	22	6.27	0.84	6.41	0.84	6.46	0.84	6.56	0.84	9.06	1.35	10.73	1.70
	25	7.15	1.42	7.33	1.40	7.40	1.39	7.52	1.38	9.40	1.71	10.64	1.93
	29	8.01	2.05	8.21	2.02	8.28	2.01	8.42	1.99	9.62	2.13	10.43	2.22
	32	8.38	2.42	8.61	2.39	8.68	2.38	8.83	2.36	10.78	2.39	12.07	2.42
	35	8.52	2.69	8.76	2.67	8.84	2.66	9.00	2.65	9.55	2.61	9.92	2.59
	40	8.29	2.82	8.52	2.83	8.60	2.84	8.76	2.84	8.64	2.76	8.91	2.74
	43	7.83	2.82	8.07	2.88	8.15	2.90	8.31	2.94	8.46	2.88	8.55	2.87
	46	7.14	2.76	7.38	2.86	7.46	2.90	7.61	2.94	8.07	2.95	8.38	2.97

Combination (Capacity)	Outdoor Air Temp. °C DB	Indoor Air Temp. °C											
		27/16		27/17.5		27/18		27/19		27/22		27/24	
		Total Q	Input Power	Total Q	Input Power	Total Q	Input Power	Total Q	Input Power	Total Q	Input Power	Total Q	Input Power
4.2 + 4.2 + 4.2	22	6.27	0.99	6.41	0.99	6.46	0.99	6.56	0.99	9.06	1.58	10.73	1.98
	25	7.15	1.66	7.33	1.64	7.40	1.63	7.52	1.62	9.40	2.00	10.64	2.26
	29	8.01	2.40	8.21	2.36	8.28	2.35	8.42	2.33	9.62	2.49	10.43	2.60
	32	8.38	2.83	8.61	2.79	8.68	2.78	8.83	2.76	10.78	2.80	12.07	2.83
	35	8.52	3.15	8.76	3.12	8.84	3.12	9.00	3.10	9.55	3.06	9.92	3.03
	40	8.29	3.30	8.52	3.31	8.60	3.32	8.76	3.33	8.64	3.23	8.91	3.20
	43	7.83	3.30	8.07	3.37	8.15	3.40	8.31	3.44	8.46	3.37	8.55	3.36
	46	7.14	3.23	7.38	3.35	7.46	3.39	7.61	3.44	8.07	3.45	8.38	3.47
4.2 + 4.2 + 5.0	22	6.27	0.89	6.41	0.89	6.46	0.89	6.56	0.89	9.06	1.43	10.73	1.79
	25	7.15	1.50	7.33	1.48	7.40	1.47	7.52	1.46	9.40	1.81	10.64	2.04
	29	8.01	2.17	8.21	2.13	8.28	2.12	8.42	2.10	9.62	2.25	10.43	2.35
	32	8.38	2.55	8.61	2.52	8.68	2.51	8.83	2.49	10.78	2.53	12.07	2.55
	35	8.52	2.84	8.76	2.82	8.84	2.81	9.00	2.80	9.55	2.76	9.92	2.74
	40	8.29	2.98	8.52	2.99	8.60	3.00	8.76	3.00	8.64	2.92	8.91	2.89
	43	7.83	2.98	8.07	3.05	8.15	3.07	8.31	3.11	8.46	3.05	8.55	3.03
	46	7.14	2.92	7.38	3.02	7.46	3.06	7.61	3.10	8.07	3.12	8.38	3.14
4.2 + 4.2 + 6.0	22	6.27	0.89	6.41	0.89	6.46	0.89	6.56	0.89	9.06	1.43	10.73	1.79
	25	7.15	1.50	7.33	1.48	7.40	1.47	7.52	1.46	9.40	1.81	10.64	2.04
	29	8.01	2.17	8.21	2.13	8.28	2.12	8.42	2.10	9.62	2.25	10.43	2.35
	32	8.38	2.55	8.61	2.52	8.68	2.51	8.83	2.49	10.78	2.53	12.07	2.55
	35	8.52	2.84	8.76	2.82	8.84	2.81	9.00	2.80	9.55	2.76	9.92	2.74
	40	8.29	2.98	8.52	2.99	8.60	3.00	8.76	3.00	8.64	2.92	8.91	2.89
	43	7.83	2.98	8.07	3.05	8.15	3.07	8.31	3.11	8.46	3.05	8.55	3.03
	46	7.14	2.92	7.38	3.02	7.46	3.06	7.61	3.10	8.07	3.12	8.38	3.14
4.2 + 5.0 + 5.0	22	6.27	0.84	6.41	0.84	6.46	0.84	6.56	0.84	9.06	1.35	10.73	1.70
	25	7.15	1.42	7.33	1.40	7.40	1.39	7.52	1.38	9.40	1.71	10.64	1.93
	29	8.01	2.05	8.21	2.02	8.28	2.01	8.42	1.99	9.62	2.13	10.43	2.22
	32	8.38	2.42	8.61	2.39	8.68	2.38	8.83	2.36	10.78	2.39	12.07	2.42
	35	8.52	2.69	8.76	2.67	8.84	2.66	9.00	2.65	9.55	2.61	9.92	2.59
	40	8.29	2.82	8.52	2.83	8.60	2.84	8.76	2.84	8.64	2.76	8.91	2.74
	43	7.83	2.82	8.07	2.88	8.15	2.90	8.31	2.94	8.46	2.88	8.55	2.87
	46	7.14	2.76	7.38	2.86	7.46	2.90	7.61	2.94	8.07	2.95	8.38	2.97
1.6 + 1.6 + 1.6 + 1.6	22	8.93	1.35	8.12	1.41	7.84	1.43	7.30	1.47	9.14	1.72	10.36	1.89
	25	9.01	1.88	8.53	1.91	8.37	1.92	8.05	1.93	9.40	2.09	10.30	2.20
	29	9.15	2.44	8.95	2.44	8.89	2.44	8.76	2.44	9.60	2.50	10.15	2.55
	32	9.00	2.76	9.04	2.74	9.05	2.74	9.08	2.73	9.64	2.75	10.01	2.76
	35	8.89	2.99	9.05	2.97	9.10	2.96	9.20	2.95	9.57	2.93	9.82	2.92
	40	8.61	3.17	8.80	3.17	8.87	3.17	9.00	3.16	8.96	3.12	9.20	3.10
	43	8.34	3.16	8.48	3.18	8.53	3.18	8.63	3.19	8.95	3.17	8.92	3.15
	46	8.02	3.06	8.05	3.11	8.06	3.12	8.07	3.15	8.55	3.15	8.65	3.15

Combination (Capacity)	Outdoor Air Temp. °C DB	Indoor Air Temp. °C											
		27/16		27/17.5		27/18		27/19		27/22		27/24	
		Total Q	Input Power	Total Q	Input Power	Total Q	Input Power	Total Q	Input Power	Total Q	Input Power	Total Q	Input Power
1.6 + 1.6 + 1.6 + 2.0	22	8.93	1.32	8.12	1.37	7.84	1.39	7.30	1.43	9.14	1.68	10.36	1.84
	25	9.01	1.83	8.53	1.85	8.37	1.86	8.05	1.88	9.40	2.04	10.30	2.14
	29	9.15	2.37	8.95	2.37	8.89	2.37	8.76	2.37	9.60	2.44	10.15	2.48
	32	9.00	2.68	9.04	2.67	9.05	2.66	9.08	2.65	9.64	2.67	10.01	2.69
	35	8.89	2.91	9.05	2.89	9.10	2.88	9.20	2.87	9.57	2.85	9.82	2.84
	40	8.61	3.09	8.80	3.08	8.87	3.08	9.00	3.08	8.96	3.04	9.20	3.01
	43	8.34	3.07	8.48	3.09	8.53	3.10	8.63	3.11	8.95	3.08	8.92	3.06
	46	8.02	2.98	8.05	3.02	8.06	3.04	8.07	3.07	8.55	3.06	8.65	3.06
1.6 + 1.6 + 1.6 + 2.5	22	8.93	1.32	8.12	1.37	7.84	1.39	7.30	1.43	9.14	1.68	10.36	1.84
	25	9.01	1.83	8.53	1.85	8.37	1.86	8.05	1.88	9.40	2.04	10.30	2.14
	29	9.15	2.37	8.95	2.37	8.89	2.37	8.76	2.37	9.60	2.44	10.15	2.48
	32	9.00	2.68	9.04	2.67	9.05	2.66	9.08	2.65	9.64	2.67	10.01	2.69
	35	8.89	2.91	9.05	2.89	9.10	2.88	9.20	2.87	9.57	2.85	9.82	2.84
	40	8.61	3.09	8.80	3.08	8.87	3.08	9.00	3.08	8.96	3.04	9.20	3.01
	43	8.34	3.07	8.48	3.09	8.53	3.10	8.63	3.11	8.95	3.08	8.92	3.06
	46	8.02	2.98	8.05	3.02	8.06	3.04	8.07	3.07	8.55	3.06	8.65	3.06
1.6 + 1.6 + 1.6 + 3.5	22	8.93	1.32	8.12	1.37	7.84	1.39	7.30	1.43	9.14	1.68	10.36	1.84
	25	9.01	1.83	8.53	1.85	8.37	1.86	8.05	1.88	9.40	2.04	10.30	2.14
	29	9.15	2.37	8.95	2.37	8.89	2.37	8.76	2.37	9.60	2.44	10.15	2.48
	32	9.00	2.68	9.04	2.67	9.05	2.66	9.08	2.65	9.64	2.67	10.01	2.69
	35	8.89	2.91	9.05	2.89	9.10	2.88	9.20	2.87	9.57	2.85	9.82	2.84
	40	8.61	3.09	8.80	3.08	8.87	3.08	9.00	3.08	8.96	3.04	9.20	3.01
	43	8.34	3.07	8.48	3.09	8.53	3.10	8.63	3.11	8.95	3.08	8.92	3.06
	46	8.02	2.98	8.05	3.02	8.06	3.04	8.07	3.07	8.55	3.06	8.65	3.06
1.6 + 1.6 + 1.6 + 4.2	22	8.93	1.32	8.12	1.37	7.84	1.39	7.30	1.43	9.14	1.68	10.36	1.84
	25	9.01	1.83	8.53	1.85	8.37	1.86	8.05	1.88	9.40	2.04	10.30	2.14
	29	9.15	2.37	8.95	2.37	8.89	2.37	8.76	2.37	9.60	2.44	10.15	2.48
	32	9.00	2.68	9.04	2.67	9.05	2.66	9.08	2.65	9.64	2.67	10.01	2.69
	35	8.89	2.91	9.05	2.89	9.10	2.88	9.20	2.87	9.57	2.85	9.82	2.84
	40	8.61	3.09	8.80	3.08	8.87	3.08	9.00	3.08	8.96	3.04	9.20	3.01
	43	8.34	3.07	8.48	3.09	8.53	3.10	8.63	3.11	8.95	3.08	8.92	3.06
	46	8.02	2.98	8.05	3.02	8.06	3.04	8.07	3.07	8.55	3.06	8.65	3.06
1.6 + 1.6 + 1.6 + 5.0	22	8.93	1.25	8.12	1.31	7.84	1.33	7.30	1.36	9.14	1.59	10.36	1.75
	25	9.01	1.74	8.53	1.76	8.37	1.77	8.05	1.79	9.40	1.94	10.30	2.03
	29	9.15	2.26	8.95	2.26	8.89	2.26	8.76	2.26	9.60	2.32	10.15	2.36
	32	9.00	2.55	9.04	2.54	9.05	2.53	9.08	2.52	9.64	2.54	10.01	2.55
	35	8.89	2.76	9.05	2.75	9.10	2.74	9.20	2.73	9.57	2.71	9.82	2.70
	40	8.61	2.94	8.80	2.93	8.87	2.93	9.00	2.93	8.96	2.89	9.20	2.87
	43	8.34	2.92	8.48	2.94	8.53	2.95	8.63	2.96	8.95	2.93	8.92	2.91
	46	8.02	2.83	8.05	2.88	8.06	2.89	8.07	2.92	8.55	2.92	8.65	2.91

Combination (Capacity)	Outdoor Air Temp. °C DB	Indoor Air Temp. °C											
		27/16		27/17.5		27/18		27/19		27/22		27/24	
		Total Q	Input Power	Total Q	Input Power	Total Q	Input Power	Total Q	Input Power	Total Q	Input Power	Total Q	Input Power
1.6 + 1.6 + 1.6 + 6.0	22	8.93	1.25	8.12	1.31	7.84	1.33	7.30	1.36	9.14	1.59	10.36	1.75
	25	9.01	1.74	8.53	1.76	8.37	1.77	8.05	1.79	9.40	1.94	10.30	2.03
	29	9.15	2.26	8.95	2.26	8.89	2.26	8.76	2.26	9.60	2.32	10.15	2.36
	32	9.00	2.55	9.04	2.54	9.05	2.53	9.08	2.52	9.64	2.54	10.01	2.55
	35	8.89	2.76	9.05	2.75	9.10	2.74	9.20	2.73	9.57	2.71	9.82	2.70
	40	8.61	2.94	8.80	2.93	8.87	2.93	9.00	2.93	8.96	2.89	9.20	2.87
	43	8.34	2.92	8.48	2.94	8.53	2.95	8.63	2.96	8.95	2.93	8.92	2.91
	46	8.02	2.83	8.05	2.88	8.06	2.89	8.07	2.92	8.55	2.92	8.65	2.91
1.6 + 1.6 + 1.6 + 7.1	22	8.93	1.22	8.12	1.27	7.84	1.29	7.30	1.33	9.14	1.55	10.36	1.70
	25	9.01	1.69	8.53	1.72	8.37	1.73	8.05	1.74	9.40	1.89	10.30	1.98
	29	9.15	2.20	8.95	2.20	8.89	2.20	8.76	2.20	9.60	2.26	10.15	2.30
	32	9.00	2.49	9.04	2.47	9.05	2.47	9.08	2.46	9.64	2.48	10.01	2.49
	35	8.89	2.69	9.05	2.68	9.10	2.67	9.20	2.66	9.57	2.65	9.82	2.64
	40	8.61	2.86	8.80	2.86	8.87	2.85	9.00	2.85	8.96	2.82	9.20	2.79
	43	8.34	2.85	8.48	2.86	8.53	2.87	8.63	2.88	8.95	2.86	8.92	2.84
	46	8.02	2.76	8.05	2.80	8.06	2.82	8.07	2.84	8.55	2.84	8.65	2.84
1.6 + 1.6 + 2.0 + 2.0	22	8.93	1.32	8.12	1.37	7.84	1.39	7.30	1.43	9.14	1.68	10.36	1.84
	25	9.01	1.83	8.53	1.85	8.37	1.86	8.05	1.88	9.40	2.04	10.30	2.14
	29	9.15	2.37	8.95	2.37	8.89	2.37	8.76	2.37	9.60	2.44	10.15	2.48
	32	9.00	2.68	9.04	2.67	9.05	2.66	9.08	2.65	9.64	2.67	10.01	2.69
	35	8.89	2.91	9.05	2.89	9.10	2.88	9.20	2.87	9.57	2.85	9.82	2.84
	40	8.61	3.09	8.80	3.08	8.87	3.08	9.00	3.08	8.96	3.04	9.20	3.01
	43	8.34	3.07	8.48	3.09	8.53	3.10	8.63	3.11	8.95	3.08	8.92	3.06
	46	8.02	2.98	8.05	3.02	8.06	3.04	8.07	3.07	8.55	3.06	8.65	3.06
1.6 + 1.6 + 2.0 + 2.5	22	8.93	1.32	8.12	1.37	7.84	1.39	7.30	1.43	9.14	1.68	10.36	1.84
	25	9.01	1.83	8.53	1.85	8.37	1.86	8.05	1.88	9.40	2.04	10.30	2.14
	29	9.15	2.37	8.95	2.37	8.89	2.37	8.76	2.37	9.60	2.44	10.15	2.48
	32	9.00	2.68	9.04	2.67	9.05	2.66	9.08	2.65	9.64	2.67	10.01	2.69
	35	8.89	2.91	9.05	2.89	9.10	2.88	9.20	2.87	9.57	2.85	9.82	2.84
	40	8.61	3.09	8.80	3.08	8.87	3.08	9.00	3.08	8.96	3.04	9.20	3.01
	43	8.34	3.07	8.48	3.09	8.53	3.10	8.63	3.11	8.95	3.08	8.92	3.06
	46	8.02	2.98	8.05	3.02	8.06	3.04	8.07	3.07	8.55	3.06	8.65	3.06
1.6 + 1.6 + 2.0 + 3.5	22	8.93	1.32	8.12	1.37	7.84	1.39	7.30	1.43	9.14	1.68	10.36	1.84
	25	9.01	1.83	8.53	1.85	8.37	1.86	8.05	1.88	9.40	2.04	10.30	2.14
	29	9.15	2.37	8.95	2.37	8.89	2.37	8.76	2.37	9.60	2.44	10.15	2.48
	32	9.00	2.68	9.04	2.67	9.05	2.66	9.08	2.65	9.64	2.67	10.01	2.69
	35	8.89	2.91	9.05	2.89	9.10	2.88	9.20	2.87	9.57	2.85	9.82	2.84
	40	8.61	3.09	8.80	3.08	8.87	3.08	9.00	3.08	8.96	3.04	9.20	3.01
	43	8.34	3.07	8.48	3.09	8.53	3.10	8.63	3.11	8.95	3.08	8.92	3.06
	46	8.02	2.98	8.05	3.02	8.06	3.04	8.07	3.07	8.55	3.06	8.65	3.06

Combination (Capacity)	Outdoor Air Temp. °C DB	Indoor Air Temp. °C											
		27/16		27/17.5		27/18		27/19		27/22		27/24	
		Total Q	Input Power	Total Q	Input Power	Total Q	Input Power	Total Q	Input Power	Total Q	Input Power	Total Q	Input Power
1.6 + 1.6 + 2.0 + 4.2	22	8.93	1.32	8.12	1.37	7.84	1.39	7.30	1.43	9.14	1.68	10.36	1.84
	25	9.01	1.83	8.53	1.85	8.37	1.86	8.05	1.88	9.40	2.04	10.30	2.14
	29	9.15	2.37	8.95	2.37	8.89	2.37	8.76	2.37	9.60	2.44	10.15	2.48
	32	9.00	2.68	9.04	2.67	9.05	2.66	9.08	2.65	9.64	2.67	10.01	2.69
	35	8.89	2.91	9.05	2.89	9.10	2.88	9.20	2.87	9.57	2.85	9.82	2.84
	40	8.61	3.09	8.80	3.08	8.87	3.08	9.00	3.08	8.96	3.04	9.20	3.01
	43	8.34	3.07	8.48	3.09	8.53	3.10	8.63	3.11	8.95	3.08	8.92	3.06
	46	8.02	2.98	8.05	3.02	8.06	3.04	8.07	3.07	8.55	3.06	8.65	3.06
1.6 + 1.6 + 2.0 + 5.0	22	8.93	1.22	8.12	1.27	7.84	1.29	7.30	1.32	9.14	1.55	10.36	1.70
	25	9.01	1.69	8.53	1.71	8.37	1.72	8.05	1.74	9.40	1.88	10.30	1.97
	29	9.15	2.19	8.95	2.19	8.89	2.19	8.76	2.19	9.60	2.25	10.15	2.29
	32	9.00	2.48	9.04	2.46	9.05	2.46	9.08	2.45	9.64	2.47	10.01	2.48
	35	8.89	2.68	9.05	2.67	9.10	2.66	9.20	2.65	9.57	2.64	9.82	2.63
	40	8.61	2.85	8.80	2.84	8.87	2.84	9.00	2.84	8.96	2.81	9.20	2.78
	43	8.34	2.84	8.48	2.85	8.53	2.86	8.63	2.87	8.95	2.84	8.92	2.83
	46	8.02	2.75	8.05	2.79	8.06	2.80	8.07	2.83	8.55	2.83	8.65	2.83
1.6 + 1.6 + 2.0 + 6.0	22	8.93	1.22	8.12	1.27	7.84	1.29	7.30	1.32	9.14	1.55	10.36	1.70
	25	9.01	1.69	8.53	1.71	8.37	1.72	8.05	1.74	9.40	1.88	10.30	1.97
	29	9.15	2.19	8.95	2.19	8.89	2.19	8.76	2.19	9.60	2.25	10.15	2.29
	32	9.00	2.48	9.04	2.46	9.05	2.46	9.08	2.45	9.64	2.47	10.01	2.48
	35	8.89	2.68	9.05	2.67	9.10	2.66	9.20	2.65	9.57	2.64	9.82	2.63
	40	8.61	2.85	8.80	2.84	8.87	2.84	9.00	2.84	8.96	2.81	9.20	2.78
	43	8.34	2.84	8.48	2.85	8.53	2.86	8.63	2.87	8.95	2.84	8.92	2.83
	46	8.02	2.75	8.05	2.79	8.06	2.80	8.07	2.83	8.55	2.83	8.65	2.83
1.6 + 1.6 + 2.0 + 7.1	22	8.93	1.22	8.12	1.27	7.84	1.29	7.30	1.33	9.14	1.55	10.36	1.70
	25	9.01	1.69	8.53	1.72	8.37	1.73	8.05	1.74	9.40	1.89	10.30	1.98
	29	9.15	2.20	8.95	2.20	8.89	2.20	8.76	2.20	9.60	2.26	10.15	2.30
	32	9.00	2.49	9.04	2.47	9.05	2.47	9.08	2.46	9.64	2.48	10.01	2.49
	35	8.89	2.69	9.05	2.68	9.10	2.67	9.20	2.66	9.57	2.65	9.82	2.64
	40	8.61	2.86	8.80	2.86	8.87	2.85	9.00	2.85	8.96	2.82	9.20	2.79
	43	8.34	2.85	8.48	2.86	8.53	2.87	8.63	2.88	8.95	2.86	8.92	2.84
	46	8.02	2.76	8.05	2.80	8.06	2.82	8.07	2.84	8.55	2.84	8.65	2.84
1.6 + 1.6 + 2.5 + 2.5	22	8.93	1.32	8.12	1.37	7.84	1.39	7.30	1.43	9.14	1.68	10.36	1.84
	25	9.01	1.83	8.53	1.85	8.37	1.86	8.05	1.88	9.40	2.04	10.30	2.14
	29	9.15	2.37	8.95	2.37	8.89	2.37	8.76	2.37	9.60	2.44	10.15	2.48
	32	9.00	2.68	9.04	2.67	9.05	2.66	9.08	2.65	9.64	2.67	10.01	2.69
	35	8.89	2.91	9.05	2.89	9.10	2.88	9.20	2.87	9.57	2.85	9.82	2.84
	40	8.61	3.09	8.80	3.08	8.87	3.08	9.00	3.08	8.96	3.04	9.20	3.01
	43	8.34	3.07	8.48	3.09	8.53	3.10	8.63	3.11	8.95	3.08	8.92	3.06
	46	8.02	2.98	8.05	3.02	8.06	3.04	8.07	3.07	8.55	3.06	8.65	3.06

Combination (Capacity)	Outdoor Air Temp. °C DB	Indoor Air Temp. °C											
		27/16		27/17.5		27/18		27/19		27/22		27/24	
		Total Q	Input Power	Total Q	Input Power	Total Q	Input Power	Total Q	Input Power	Total Q	Input Power	Total Q	Input Power
1.6 + 1.6 + 2.5 + 3.5	22	8.93	1.32	8.12	1.37	7.84	1.39	7.30	1.43	9.14	1.68	10.36	1.84
	25	9.01	1.83	8.53	1.85	8.37	1.86	8.05	1.88	9.40	2.04	10.30	2.14
	29	9.15	2.37	8.95	2.37	8.89	2.37	8.76	2.37	9.60	2.44	10.15	2.48
	32	9.00	2.68	9.04	2.67	9.05	2.66	9.08	2.65	9.64	2.67	10.01	2.69
	35	8.89	2.91	9.05	2.89	9.10	2.88	9.20	2.87	9.57	2.85	9.82	2.84
	40	8.61	3.09	8.80	3.08	8.87	3.08	9.00	3.08	8.96	3.04	9.20	3.01
	43	8.34	3.07	8.48	3.09	8.53	3.10	8.63	3.11	8.95	3.08	8.92	3.06
	46	8.02	2.98	8.05	3.02	8.06	3.04	8.07	3.07	8.55	3.06	8.65	3.06
1.6 + 1.6 + 2.5 + 4.2	22	8.93	1.32	8.12	1.37	7.84	1.39	7.30	1.43	9.14	1.68	10.36	1.84
	25	9.01	1.83	8.53	1.85	8.37	1.86	8.05	1.88	9.40	2.04	10.30	2.14
	29	9.15	2.37	8.95	2.37	8.89	2.37	8.76	2.37	9.60	2.44	10.15	2.48
	32	9.00	2.68	9.04	2.67	9.05	2.66	9.08	2.65	9.64	2.67	10.01	2.69
	35	8.89	2.91	9.05	2.89	9.10	2.88	9.20	2.87	9.57	2.85	9.82	2.84
	40	8.61	3.09	8.80	3.08	8.87	3.08	9.00	3.08	8.96	3.04	9.20	3.01
	43	8.34	3.07	8.48	3.09	8.53	3.10	8.63	3.11	8.95	3.08	8.92	3.06
	46	8.02	2.98	8.05	3.02	8.06	3.04	8.07	3.07	8.55	3.06	8.65	3.06
1.6 + 1.6 + 2.5 + 5.0	22	8.93	1.22	8.12	1.27	7.84	1.29	7.30	1.32	9.14	1.55	10.36	1.70
	25	9.01	1.69	8.53	1.71	8.37	1.72	8.05	1.74	9.40	1.88	10.30	1.97
	29	9.15	2.19	8.95	2.19	8.89	2.19	8.76	2.19	9.60	2.25	10.15	2.29
	32	9.00	2.48	9.04	2.46	9.05	2.46	9.08	2.45	9.64	2.47	10.01	2.48
	35	8.89	2.68	9.05	2.67	9.10	2.66	9.20	2.65	9.57	2.64	9.82	2.63
	40	8.61	2.85	8.80	2.84	8.87	2.84	9.00	2.84	8.96	2.81	9.20	2.78
	43	8.34	2.84	8.48	2.85	8.53	2.86	8.63	2.87	8.95	2.84	8.92	2.83
	46	8.02	2.75	8.05	2.79	8.06	2.80	8.07	2.83	8.55	2.83	8.65	2.83
1.6 + 1.6 + 2.5 + 6.0	22	8.93	1.22	8.12	1.27	7.84	1.29	7.30	1.32	9.14	1.55	10.36	1.70
	25	9.01	1.69	8.53	1.71	8.37	1.72	8.05	1.74	9.40	1.88	10.30	1.97
	29	9.15	2.19	8.95	2.19	8.89	2.19	8.76	2.19	9.60	2.25	10.15	2.29
	32	9.00	2.48	9.04	2.46	9.05	2.46	9.08	2.45	9.64	2.47	10.01	2.48
	35	8.89	2.68	9.05	2.67	9.10	2.66	9.20	2.65	9.57	2.64	9.82	2.63
	40	8.61	2.85	8.80	2.84	8.87	2.84	9.00	2.84	8.96	2.81	9.20	2.78
	43	8.34	2.84	8.48	2.85	8.53	2.86	8.63	2.87	8.95	2.84	8.92	2.83
	46	8.02	2.75	8.05	2.79	8.06	2.80	8.07	2.83	8.55	2.83	8.65	2.83
1.6 + 1.6 + 2.5 + 7.1	22	8.93	1.22	8.12	1.27	7.84	1.29	7.30	1.33	9.14	1.55	10.36	1.70
	25	9.01	1.69	8.53	1.72	8.37	1.73	8.05	1.74	9.40	1.89	10.30	1.98
	29	9.15	2.20	8.95	2.20	8.89	2.20	8.76	2.20	9.60	2.26	10.15	2.30
	32	9.00	2.49	9.04	2.47	9.05	2.47	9.08	2.46	9.64	2.48	10.01	2.49
	35	8.89	2.69	9.05	2.68	9.10	2.67	9.20	2.66	9.57	2.65	9.82	2.64
	40	8.61	2.86	8.80	2.86	8.87	2.85	9.00	2.85	8.96	2.82	9.20	2.79
	43	8.34	2.85	8.48	2.86	8.53	2.87	8.63	2.88	8.95	2.86	8.92	2.84
	46	8.02	2.76	8.05	2.80	8.06	2.82	8.07	2.84	8.55	2.84	8.65	2.84



Combination (Capacity)	Outdoor Air Temp. °C DB	Indoor Air Temp. °C											
		27/16		27/17.5		27/18		27/19		27/22		27/24	
		Total Q	Input Power	Total Q	Input Power	Total Q	Input Power	Total Q	Input Power	Total Q	Input Power	Total Q	Input Power
1.6 + 1.6 + 3.5 + 3.5	22	8.93	1.28	8.12	1.34	7.84	1.36	7.30	1.40	9.14	1.63	10.36	1.79
	25	9.01	1.78	8.53	1.81	8.37	1.82	8.05	1.84	9.40	1.99	10.30	2.09
	29	9.15	2.31	8.95	2.31	8.89	2.31	8.76	2.31	9.60	2.38	10.15	2.42
	32	9.00	2.62	9.04	2.60	9.05	2.60	9.08	2.59	9.64	2.61	10.01	2.62
	35	8.89	2.84	9.05	2.82	9.10	2.81	9.20	2.80	9.57	2.78	9.82	2.77
	40	8.61	3.01	8.80	3.01	8.87	3.00	9.00	3.00	8.96	2.96	9.20	2.94
	43	8.34	3.00	8.48	3.01	8.53	3.02	8.63	3.03	8.95	3.01	8.92	2.99
	46	8.02	2.91	8.05	2.95	8.06	2.96	8.07	2.99	8.55	2.99	8.65	2.99
1.6 + 1.6 + 3.5 + 4.2	22	8.93	1.28	8.12	1.34	7.84	1.36	7.30	1.40	9.14	1.63	10.36	1.79
	25	9.01	1.78	8.53	1.81	8.37	1.82	8.05	1.84	9.40	1.99	10.30	2.09
	29	9.15	2.31	8.95	2.31	8.89	2.31	8.76	2.31	9.60	2.38	10.15	2.42
	32	9.00	2.62	9.04	2.60	9.05	2.60	9.08	2.59	9.64	2.61	10.01	2.62
	35	8.89	2.84	9.05	2.82	9.10	2.81	9.20	2.80	9.57	2.78	9.82	2.77
	40	8.61	3.01	8.80	3.01	8.87	3.00	9.00	3.00	8.96	2.96	9.20	2.94
	43	8.34	3.00	8.48	3.01	8.53	3.02	8.63	3.03	8.95	3.01	8.92	2.99
	46	8.02	2.91	8.05	2.95	8.06	2.96	8.07	2.99	8.55	2.99	8.65	2.99
1.6 + 1.6 + 3.5 + 5.0	22	8.93	1.22	8.12	1.27	7.84	1.29	7.30	1.33	9.14	1.55	10.36	1.70
	25	9.01	1.69	8.53	1.72	8.37	1.73	8.05	1.74	9.40	1.89	10.30	1.98
	29	9.15	2.20	8.95	2.20	8.89	2.20	8.76	2.20	9.60	2.26	10.15	2.30
	32	9.00	2.49	9.04	2.47	9.05	2.47	9.08	2.46	9.64	2.48	10.01	2.49
	35	8.89	2.69	9.05	2.68	9.10	2.67	9.20	2.66	9.57	2.65	9.82	2.64
	40	8.61	2.86	8.80	2.86	8.87	2.85	9.00	2.85	8.96	2.82	9.20	2.79
	43	8.34	2.85	8.48	2.86	8.53	2.87	8.63	2.88	8.95	2.86	8.92	2.84
	46	8.02	2.76	8.05	2.80	8.06	2.82	8.07	2.84	8.55	2.84	8.65	2.84
1.6 + 1.6 + 3.5 + 6.0	22	8.93	1.22	8.12	1.27	7.84	1.29	7.30	1.33	9.14	1.55	10.36	1.70
	25	9.01	1.69	8.53	1.72	8.37	1.73	8.05	1.74	9.40	1.89	10.30	1.98
	29	9.15	2.20	8.95	2.20	8.89	2.20	8.76	2.20	9.60	2.26	10.15	2.30
	32	9.00	2.49	9.04	2.47	9.05	2.47	9.08	2.46	9.64	2.48	10.01	2.49
	35	8.89	2.69	9.05	2.68	9.10	2.67	9.20	2.66	9.57	2.65	9.82	2.64
	40	8.61	2.86	8.80	2.86	8.87	2.85	9.00	2.85	8.96	2.82	9.20	2.79
	43	8.34	2.85	8.48	2.86	8.53	2.87	8.63	2.88	8.95	2.86	8.92	2.84
	46	8.02	2.76	8.05	2.80	8.06	2.82	8.07	2.84	8.55	2.84	8.65	2.84
1.6 + 1.6 + 3.5 + 7.1	22	8.93	1.22	8.12	1.27	7.84	1.29	7.30	1.33	9.14	1.55	10.36	1.70
	25	9.01	1.69	8.53	1.72	8.37	1.73	8.05	1.74	9.40	1.89	10.30	1.98
	29	9.15	2.20	8.95	2.20	8.89	2.20	8.76	2.20	9.60	2.26	10.15	2.30
	32	9.00	2.49	9.04	2.47	9.05	2.47	9.08	2.46	9.64	2.48	10.01	2.49
	35	8.89	2.69	9.05	2.68	9.10	2.67	9.20	2.66	9.57	2.65	9.82	2.64
	40	8.61	2.86	8.80	2.86	8.87	2.85	9.00	2.85	8.96	2.82	9.20	2.79
	43	8.34	2.85	8.48	2.86	8.53	2.87	8.63	2.88	8.95	2.86	8.92	2.84
	46	8.02	2.76	8.05	2.80	8.06	2.82	8.07	2.84	8.55	2.84	8.65	2.84

Combination (Capacity)	Outdoor Air Temp. °C DB	Indoor Air Temp. °C											
		27/16		27/17.5		27/18		27/19		27/22		27/24	
		Total Q	Input Power	Total Q	Input Power	Total Q	Input Power	Total Q	Input Power	Total Q	Input Power	Total Q	Input Power
1.6 + 1.6 + 4.2 + 4.2	22	8.93	1.28	8.12	1.34	7.84	1.36	7.30	1.40	9.14	1.63	10.36	1.79
	25	9.01	1.78	8.53	1.81	8.37	1.82	8.05	1.84	9.40	1.99	10.30	2.09
	29	9.15	2.31	8.95	2.31	8.89	2.31	8.76	2.31	9.60	2.38	10.15	2.42
	32	9.00	2.62	9.04	2.60	9.05	2.60	9.08	2.59	9.64	2.61	10.01	2.62
	35	8.89	2.84	9.05	2.82	9.10	2.81	9.20	2.80	9.57	2.78	9.82	2.77
	40	8.61	3.01	8.80	3.01	8.87	3.00	9.00	3.00	8.96	2.96	9.20	2.94
	43	8.34	3.00	8.48	3.01	8.53	3.02	8.63	3.03	8.95	3.01	8.92	2.99
	46	8.02	2.91	8.05	2.95	8.06	2.96	8.07	2.99	8.55	2.99	8.65	2.99
1.6 + 1.6 + 4.2 + 5.0	22	8.93	1.22	8.12	1.27	7.84	1.29	7.30	1.33	9.14	1.55	10.36	1.70
	25	9.01	1.69	8.53	1.72	8.37	1.73	8.05	1.74	9.40	1.89	10.30	1.98
	29	9.15	2.20	8.95	2.20	8.89	2.20	8.76	2.20	9.60	2.26	10.15	2.30
	32	9.00	2.49	9.04	2.47	9.05	2.47	9.08	2.46	9.64	2.48	10.01	2.49
	35	8.89	2.69	9.05	2.68	9.10	2.67	9.20	2.66	9.57	2.65	9.82	2.64
	40	8.61	2.86	8.80	2.86	8.87	2.85	9.00	2.85	8.96	2.82	9.20	2.79
	43	8.34	2.85	8.48	2.86	8.53	2.87	8.63	2.88	8.95	2.86	8.92	2.84
	46	8.02	2.76	8.05	2.80	8.06	2.82	8.07	2.84	8.55	2.84	8.65	2.84
1.6 + 1.6 + 4.2 + 6.0	22	8.93	1.22	8.12	1.27	7.84	1.29	7.30	1.33	9.14	1.55	10.36	1.70
	25	9.01	1.69	8.53	1.72	8.37	1.73	8.05	1.74	9.40	1.89	10.30	1.98
	29	9.15	2.20	8.95	2.20	8.89	2.20	8.76	2.20	9.60	2.26	10.15	2.30
	32	9.00	2.49	9.04	2.47	9.05	2.47	9.08	2.46	9.64	2.48	10.01	2.49
	35	8.89	2.69	9.05	2.68	9.10	2.67	9.20	2.66	9.57	2.65	9.82	2.64
	40	8.61	2.86	8.80	2.86	8.87	2.85	9.00	2.85	8.96	2.82	9.20	2.79
	43	8.34	2.85	8.48	2.86	8.53	2.87	8.63	2.88	8.95	2.86	8.92	2.84
	46	8.02	2.76	8.05	2.80	8.06	2.82	8.07	2.84	8.55	2.84	8.65	2.84
1.6 + 1.6 + 4.2 + 7.1	22	8.93	1.22	8.12	1.27	7.84	1.29	7.30	1.33	9.14	1.55	10.36	1.70
	25	9.01	1.69	8.53	1.72	8.37	1.73	8.05	1.74	9.40	1.89	10.30	1.98
	29	9.15	2.20	8.95	2.20	8.89	2.20	8.76	2.20	9.60	2.26	10.15	2.30
	32	9.00	2.49	9.04	2.47	9.05	2.47	9.08	2.46	9.64	2.48	10.01	2.49
	35	8.89	2.69	9.05	2.68	9.10	2.67	9.20	2.66	9.57	2.65	9.82	2.64
	40	8.61	2.86	8.80	2.86	8.87	2.85	9.00	2.85	8.96	2.82	9.20	2.79
	43	8.34	2.85	8.48	2.86	8.53	2.87	8.63	2.88	8.95	2.86	8.92	2.84
	46	8.02	2.76	8.05	2.80	8.06	2.82	8.07	2.84	8.55	2.84	8.65	2.84
1.6 + 1.6 + 5.0 + 5.0	22	8.93	1.19	8.12	1.25	7.84	1.26	7.30	1.30	9.14	1.52	10.36	1.66
	25	9.01	1.66	8.53	1.68	8.37	1.69	8.05	1.70	9.40	1.84	10.30	1.94
	29	9.15	2.15	8.95	2.15	8.89	2.15	8.76	2.15	9.60	2.21	10.15	2.25
	32	9.00	2.43	9.04	2.42	9.05	2.41	9.08	2.40	9.64	2.42	10.01	2.43
	35	8.89	2.63	9.05	2.62	9.10	2.61	9.20	2.60	9.57	2.59	9.82	2.58
	40	8.61	2.80	8.80	2.79	8.87	2.79	9.00	2.79	8.96	2.75	9.20	2.73
	43	8.34	2.78	8.48	2.80	8.53	2.80	8.63	2.82	8.95	2.79	8.92	2.77
	46	8.02	2.70	8.05	2.74	8.06	2.75	8.07	2.78	8.55	2.78	8.65	2.77

Combination (Capacity)	Outdoor Air Temp. °C DB	Indoor Air Temp. °C											
		27/16		27/17.5		27/18		27/19		27/22		27/24	
		Total Q	Input Power	Total Q	Input Power	Total Q	Input Power	Total Q	Input Power	Total Q	Input Power	Total Q	Input Power
1.6 + 1.6 + 5.0 + 6.0	22	8.93	1.19	8.12	1.25	7.84	1.26	7.30	1.30	9.14	1.52	10.36	1.66
	25	9.01	1.66	8.53	1.68	8.37	1.69	8.05	1.70	9.40	1.84	10.30	1.94
	29	9.15	2.15	8.95	2.15	8.89	2.15	8.76	2.15	9.60	2.21	10.15	2.25
	32	9.00	2.43	9.04	2.42	9.05	2.41	9.08	2.40	9.64	2.42	10.01	2.43
	35	8.89	2.63	9.05	2.62	9.10	2.61	9.20	2.60	9.57	2.59	9.82	2.58
	40	8.61	2.80	8.80	2.79	8.87	2.79	9.00	2.79	8.96	2.75	9.20	2.73
	43	8.34	2.78	8.48	2.80	8.53	2.80	8.63	2.82	8.95	2.79	8.92	2.77
	46	8.02	2.70	8.05	2.74	8.06	2.75	8.07	2.78	8.55	2.78	8.65	2.77
1.6 + 2.0 + 2.0 + 2.0	22	8.93	1.32	8.12	1.37	7.84	1.39	7.30	1.43	9.14	1.68	10.36	1.84
	25	9.01	1.83	8.53	1.85	8.37	1.86	8.05	1.88	9.40	2.04	10.30	2.14
	29	9.15	2.37	8.95	2.37	8.89	2.37	8.76	2.37	9.60	2.44	10.15	2.48
	32	9.00	2.68	9.04	2.67	9.05	2.66	9.08	2.65	9.64	2.67	10.01	2.69
	35	8.89	2.91	9.05	2.89	9.10	2.88	9.20	2.87	9.57	2.85	9.82	2.84
	40	8.61	3.09	8.80	3.08	8.87	3.08	9.00	3.08	8.96	3.04	9.20	3.01
	43	8.34	3.07	8.48	3.09	8.53	3.10	8.63	3.11	8.95	3.08	8.92	3.06
	46	8.02	2.98	8.05	3.02	8.06	3.04	8.07	3.07	8.55	3.06	8.65	3.06
1.6 + 2.0 + 2.0 + 2.5	22	8.93	1.32	8.12	1.37	7.84	1.39	7.30	1.43	9.14	1.68	10.36	1.84
	25	9.01	1.83	8.53	1.85	8.37	1.86	8.05	1.88	9.40	2.04	10.30	2.14
	29	9.15	2.37	8.95	2.37	8.89	2.37	8.76	2.37	9.60	2.44	10.15	2.48
	32	9.00	2.68	9.04	2.67	9.05	2.66	9.08	2.65	9.64	2.67	10.01	2.69
	35	8.89	2.91	9.05	2.89	9.10	2.88	9.20	2.87	9.57	2.85	9.82	2.84
	40	8.61	3.09	8.80	3.08	8.87	3.08	9.00	3.08	8.96	3.04	9.20	3.01
	43	8.34	3.07	8.48	3.09	8.53	3.10	8.63	3.11	8.95	3.08	8.92	3.06
	46	8.02	2.98	8.05	3.02	8.06	3.04	8.07	3.07	8.55	3.06	8.65	3.06
1.6 + 2.0 + 2.0 + 3.5	22	8.93	1.28	8.12	1.34	7.84	1.36	7.30	1.40	9.14	1.63	10.36	1.79
	25	9.01	1.78	8.53	1.81	8.37	1.82	8.05	1.84	9.40	1.99	10.30	2.09
	29	9.15	2.31	8.95	2.31	8.89	2.31	8.76	2.31	9.60	2.38	10.15	2.42
	32	9.00	2.62	9.04	2.60	9.05	2.60	9.08	2.59	9.64	2.61	10.01	2.62
	35	8.89	2.84	9.05	2.82	9.10	2.81	9.20	2.80	9.57	2.78	9.82	2.77
	40	8.61	3.01	8.80	3.01	8.87	3.00	9.00	3.00	8.96	2.96	9.20	2.94
	43	8.34	3.00	8.48	3.01	8.53	3.02	8.63	3.03	8.95	3.01	8.92	2.99
	46	8.02	2.91	8.05	2.95	8.06	2.96	8.07	2.99	8.55	2.99	8.65	2.99
1.6 + 2.0 + 2.0 + 4.2	22	8.93	1.28	8.12	1.34	7.84	1.36	7.30	1.40	9.14	1.63	10.36	1.79
	25	9.01	1.78	8.53	1.81	8.37	1.82	8.05	1.84	9.40	1.99	10.30	2.09
	29	9.15	2.31	8.95	2.31	8.89	2.31	8.76	2.31	9.60	2.38	10.15	2.42
	32	9.00	2.62	9.04	2.60	9.05	2.60	9.08	2.59	9.64	2.61	10.01	2.62
	35	8.89	2.84	9.05	2.82	9.10	2.81	9.20	2.80	9.57	2.78	9.82	2.77
	40	8.61	3.01	8.80	3.01	8.87	3.00	9.00	3.00	8.96	2.96	9.20	2.94
	43	8.34	3.00	8.48	3.01	8.53	3.02	8.63	3.03	8.95	3.01	8.92	2.99
	46	8.02	2.91	8.05	2.95	8.06	2.96	8.07	2.99	8.55	2.99	8.65	2.99

Combination (Capacity)	Outdoor Air Temp. °C DB	Indoor Air Temp. °C											
		27/16		27/17.5		27/18		27/19		27/22		27/24	
		Total Q	Input Power	Total Q	Input Power	Total Q	Input Power	Total Q	Input Power	Total Q	Input Power	Total Q	Input Power
1.6 + 2.0 + 2.0 + 5.0	22	8.93	1.22	8.12	1.27	7.84	1.29	7.30	1.32	9.14	1.55	10.36	1.70
	25	9.01	1.69	8.53	1.71	8.37	1.72	8.05	1.74	9.40	1.88	10.30	1.97
	29	9.15	2.19	8.95	2.19	8.89	2.19	8.76	2.19	9.60	2.25	10.15	2.29
	32	9.00	2.48	9.04	2.46	9.05	2.46	9.08	2.45	9.64	2.47	10.01	2.48
	35	8.89	2.68	9.05	2.67	9.10	2.66	9.20	2.65	9.57	2.64	9.82	2.63
	40	8.61	2.85	8.80	2.84	8.87	2.84	9.00	2.84	8.96	2.81	9.20	2.78
	43	8.34	2.84	8.48	2.85	8.53	2.86	8.63	2.87	8.95	2.84	8.92	2.83
	46	8.02	2.75	8.05	2.79	8.06	2.80	8.07	2.83	8.55	2.83	8.65	2.83
1.6 + 2.0 + 2.0 + 6.0	22	8.93	1.22	8.12	1.27	7.84	1.29	7.30	1.32	9.14	1.55	10.36	1.70
	25	9.01	1.69	8.53	1.71	8.37	1.72	8.05	1.74	9.40	1.88	10.30	1.97
	29	9.15	2.19	8.95	2.19	8.89	2.19	8.76	2.19	9.60	2.25	10.15	2.29
	32	9.00	2.48	9.04	2.46	9.05	2.46	9.08	2.45	9.64	2.47	10.01	2.48
	35	8.89	2.68	9.05	2.67	9.10	2.66	9.20	2.65	9.57	2.64	9.82	2.63
	40	8.61	2.85	8.80	2.84	8.87	2.84	9.00	2.84	8.96	2.81	9.20	2.78
	43	8.34	2.84	8.48	2.85	8.53	2.86	8.63	2.87	8.95	2.84	8.92	2.83
	46	8.02	2.75	8.05	2.79	8.06	2.80	8.07	2.83	8.55	2.83	8.65	2.83
1.6 + 2.0 + 2.0 + 7.1	22	8.93	1.22	8.12	1.27	7.84	1.29	7.30	1.33	9.14	1.55	10.36	1.70
	25	9.01	1.69	8.53	1.72	8.37	1.73	8.05	1.74	9.40	1.89	10.30	1.98
	29	9.15	2.20	8.95	2.20	8.89	2.20	8.76	2.20	9.60	2.26	10.15	2.30
	32	9.00	2.49	9.04	2.47	9.05	2.47	9.08	2.46	9.64	2.48	10.01	2.49
	35	8.89	2.69	9.05	2.68	9.10	2.67	9.20	2.66	9.57	2.65	9.82	2.64
	40	8.61	2.86	8.80	2.86	8.87	2.85	9.00	2.85	8.96	2.82	9.20	2.79
	43	8.34	2.85	8.48	2.86	8.53	2.87	8.63	2.88	8.95	2.86	8.92	2.84
	46	8.02	2.76	8.05	2.80	8.06	2.82	8.07	2.84	8.55	2.84	8.65	2.84
1.6 + 2.0 + 2.5 + 2.5	22	8.93	1.32	8.12	1.37	7.84	1.39	7.30	1.43	9.14	1.68	10.36	1.84
	25	9.01	1.83	8.53	1.85	8.37	1.86	8.05	1.88	9.40	2.04	10.30	2.14
	29	9.15	2.37	8.95	2.37	8.89	2.37	8.76	2.37	9.60	2.44	10.15	2.48
	32	9.00	2.68	9.04	2.67	9.05	2.66	9.08	2.65	9.64	2.67	10.01	2.69
	35	8.89	2.91	9.05	2.89	9.10	2.88	9.20	2.87	9.57	2.85	9.82	2.84
	40	8.61	3.09	8.80	3.08	8.87	3.08	9.00	3.08	8.96	3.04	9.20	3.01
	43	8.34	3.07	8.48	3.09	8.53	3.10	8.63	3.11	8.95	3.08	8.92	3.06
	46	8.02	2.98	8.05	3.02	8.06	3.04	8.07	3.07	8.55	3.06	8.65	3.06
1.6 + 2.0 + 2.5 + 3.5	22	8.93	1.28	8.12	1.34	7.84	1.36	7.30	1.40	9.14	1.63	10.36	1.79
	25	9.01	1.78	8.53	1.81	8.37	1.82	8.05	1.84	9.40	1.99	10.30	2.09
	29	9.15	2.31	8.95	2.31	8.89	2.31	8.76	2.31	9.60	2.38	10.15	2.42
	32	9.00	2.62	9.04	2.60	9.05	2.60	9.08	2.59	9.64	2.61	10.01	2.62
	35	8.89	2.84	9.05	2.82	9.10	2.81	9.20	2.80	9.57	2.78	9.82	2.77
	40	8.61	3.01	8.80	3.01	8.87	3.00	9.00	3.00	8.96	2.96	9.20	2.94
	43	8.34	3.00	8.48	3.01	8.53	3.02	8.63	3.03	8.95	3.01	8.92	2.99
	46	8.02	2.91	8.05	2.95	8.06	2.96	8.07	2.99	8.55	2.99	8.65	2.99

Combination (Capacity)	Outdoor Air Temp. °C DB	Indoor Air Temp. °C											
		27/16		27/17.5		27/18		27/19		27/22		27/24	
		Total Q	Input Power	Total Q	Input Power	Total Q	Input Power	Total Q	Input Power	Total Q	Input Power	Total Q	Input Power
1.6 + 2.0 + 2.5 + 4.2	22	8.93	1.28	8.12	1.34	7.84	1.36	7.30	1.40	9.14	1.63	10.36	1.79
	25	9.01	1.78	8.53	1.81	8.37	1.82	8.05	1.84	9.40	1.99	10.30	2.09
	29	9.15	2.31	8.95	2.31	8.89	2.31	8.76	2.31	9.60	2.38	10.15	2.42
	32	9.00	2.62	9.04	2.60	9.05	2.60	9.08	2.59	9.64	2.61	10.01	2.62
	35	8.89	2.84	9.05	2.82	9.10	2.81	9.20	2.80	9.57	2.78	9.82	2.77
	40	8.61	3.01	8.80	3.01	8.87	3.00	9.00	3.00	8.96	2.96	9.20	2.94
	43	8.34	3.00	8.48	3.01	8.53	3.02	8.63	3.03	8.95	3.01	8.92	2.99
	46	8.02	2.91	8.05	2.95	8.06	2.96	8.07	2.99	8.55	2.99	8.65	2.99
1.6 + 2.0 + 2.5 + 5.0	22	8.93	1.22	8.12	1.27	7.84	1.29	7.30	1.32	9.14	1.55	10.36	1.70
	25	9.01	1.69	8.53	1.71	8.37	1.72	8.05	1.74	9.40	1.88	10.30	1.97
	29	9.15	2.19	8.95	2.19	8.89	2.19	8.76	2.19	9.60	2.25	10.15	2.29
	32	9.00	2.48	9.04	2.46	9.05	2.46	9.08	2.45	9.64	2.47	10.01	2.48
	35	8.89	2.68	9.05	2.67	9.10	2.66	9.20	2.65	9.57	2.64	9.82	2.63
	40	8.61	2.85	8.80	2.84	8.87	2.84	9.00	2.84	8.96	2.81	9.20	2.78
	43	8.34	2.84	8.48	2.85	8.53	2.86	8.63	2.87	8.95	2.84	8.92	2.83
	46	8.02	2.75	8.05	2.79	8.06	2.80	8.07	2.83	8.55	2.83	8.65	2.83
1.6 + 2.0 + 2.5 + 6.0	22	8.93	1.22	8.12	1.27	7.84	1.29	7.30	1.32	9.14	1.55	10.36	1.70
	25	9.01	1.69	8.53	1.71	8.37	1.72	8.05	1.74	9.40	1.88	10.30	1.97
	29	9.15	2.19	8.95	2.19	8.89	2.19	8.76	2.19	9.60	2.25	10.15	2.29
	32	9.00	2.48	9.04	2.46	9.05	2.46	9.08	2.45	9.64	2.47	10.01	2.48
	35	8.89	2.68	9.05	2.67	9.10	2.66	9.20	2.65	9.57	2.64	9.82	2.63
	40	8.61	2.85	8.80	2.84	8.87	2.84	9.00	2.84	8.96	2.81	9.20	2.78
	43	8.34	2.84	8.48	2.85	8.53	2.86	8.63	2.87	8.95	2.84	8.92	2.83
	46	8.02	2.75	8.05	2.79	8.06	2.80	8.07	2.83	8.55	2.83	8.65	2.83
1.6 + 2.0 + 2.5 + 7.1	22	8.93	1.22	8.12	1.27	7.84	1.29	7.30	1.33	9.14	1.55	10.36	1.70
	25	9.01	1.69	8.53	1.72	8.37	1.73	8.05	1.74	9.40	1.89	10.30	1.98
	29	9.15	2.20	8.95	2.20	8.89	2.20	8.76	2.20	9.60	2.26	10.15	2.30
	32	9.00	2.49	9.04	2.47	9.05	2.47	9.08	2.46	9.64	2.48	10.01	2.49
	35	8.89	2.69	9.05	2.68	9.10	2.67	9.20	2.66	9.57	2.65	9.82	2.64
	40	8.61	2.86	8.80	2.86	8.87	2.85	9.00	2.85	8.96	2.82	9.20	2.79
	43	8.34	2.85	8.48	2.86	8.53	2.87	8.63	2.88	8.95	2.86	8.92	2.84
	46	8.02	2.76	8.05	2.80	8.06	2.82	8.07	2.84	8.55	2.84	8.65	2.84
1.6 + 2.0 + 3.5 + 3.5	22	8.93	1.28	8.12	1.34	7.84	1.36	7.30	1.40	9.14	1.63	10.36	1.79
	25	9.01	1.78	8.53	1.81	8.37	1.82	8.05	1.84	9.40	1.99	10.30	2.09
	29	9.15	2.31	8.95	2.31	8.89	2.31	8.76	2.31	9.60	2.38	10.15	2.42
	32	9.00	2.62	9.04	2.60	9.05	2.60	9.08	2.59	9.64	2.61	10.01	2.62
	35	8.89	2.84	9.05	2.82	9.10	2.81	9.20	2.80	9.57	2.78	9.82	2.77
	40	8.61	3.01	8.80	3.01	8.87	3.00	9.00	3.00	8.96	2.96	9.20	2.94
	43	8.34	3.00	8.48	3.01	8.53	3.02	8.63	3.03	8.95	3.01	8.92	2.99
	46	8.02	2.91	8.05	2.95	8.06	2.96	8.07	2.99	8.55	2.99	8.65	2.99

Combination (Capacity)	Outdoor Air Temp. °C DB	Indoor Air Temp. °C											
		27/16		27/17.5		27/18		27/19		27/22		27/24	
		Total Q	Input Power	Total Q	Input Power	Total Q	Input Power	Total Q	Input Power	Total Q	Input Power	Total Q	Input Power
1.6 + 2.0 + 3.5 + 4.2	22	8.93	1.28	8.12	1.34	7.84	1.36	7.30	1.40	9.14	1.63	10.36	1.79
	25	9.01	1.78	8.53	1.81	8.37	1.82	8.05	1.84	9.40	1.99	10.30	2.09
	29	9.15	2.31	8.95	2.31	8.89	2.31	8.76	2.31	9.60	2.38	10.15	2.42
	32	9.00	2.62	9.04	2.60	9.05	2.60	9.08	2.59	9.64	2.61	10.01	2.62
	35	8.89	2.84	9.05	2.82	9.10	2.81	9.20	2.80	9.57	2.78	9.82	2.77
	40	8.61	3.01	8.80	3.01	8.87	3.00	9.00	3.00	8.96	2.96	9.20	2.94
	43	8.34	3.00	8.48	3.01	8.53	3.02	8.63	3.03	8.95	3.01	8.92	2.99
	46	8.02	2.91	8.05	2.95	8.06	2.96	8.07	2.99	8.55	2.99	8.65	2.99
1.6 + 2.0 + 3.5 + 5.0	22	8.93	1.22	8.12	1.27	7.84	1.29	7.30	1.33	9.14	1.55	10.36	1.70
	25	9.01	1.69	8.53	1.72	8.37	1.73	8.05	1.74	9.40	1.89	10.30	1.98
	29	9.15	2.20	8.95	2.20	8.89	2.20	8.76	2.20	9.60	2.26	10.15	2.30
	32	9.00	2.49	9.04	2.47	9.05	2.47	9.08	2.46	9.64	2.48	10.01	2.49
	35	8.89	2.69	9.05	2.68	9.10	2.67	9.20	2.66	9.57	2.65	9.82	2.64
	40	8.61	2.86	8.80	2.86	8.87	2.85	9.00	2.85	8.96	2.82	9.20	2.79
	43	8.34	2.85	8.48	2.86	8.53	2.87	8.63	2.88	8.95	2.86	8.92	2.84
	46	8.02	2.76	8.05	2.80	8.06	2.82	8.07	2.84	8.55	2.84	8.65	2.84
1.6 + 2.0 + 3.5 + 6.0	22	8.93	1.22	8.12	1.27	7.84	1.29	7.30	1.33	9.14	1.55	10.36	1.70
	25	9.01	1.69	8.53	1.72	8.37	1.73	8.05	1.74	9.40	1.89	10.30	1.98
	29	9.15	2.20	8.95	2.20	8.89	2.20	8.76	2.20	9.60	2.26	10.15	2.30
	32	9.00	2.49	9.04	2.47	9.05	2.47	9.08	2.46	9.64	2.48	10.01	2.49
	35	8.89	2.69	9.05	2.68	9.10	2.67	9.20	2.66	9.57	2.65	9.82	2.64
	40	8.61	2.86	8.80	2.86	8.87	2.85	9.00	2.85	8.96	2.82	9.20	2.79
	43	8.34	2.85	8.48	2.86	8.53	2.87	8.63	2.88	8.95	2.86	8.92	2.84
	46	8.02	2.76	8.05	2.80	8.06	2.82	8.07	2.84	8.55	2.84	8.65	2.84
1.6 + 2.0 + 3.5 + 7.1	22	8.93	1.22	8.12	1.27	7.84	1.29	7.30	1.33	9.14	1.55	10.36	1.70
	25	9.01	1.69	8.53	1.72	8.37	1.73	8.05	1.74	9.40	1.89	10.30	1.98
	29	9.15	2.20	8.95	2.20	8.89	2.20	8.76	2.20	9.60	2.26	10.15	2.30
	32	9.00	2.49	9.04	2.47	9.05	2.47	9.08	2.46	9.64	2.48	10.01	2.49
	35	8.89	2.69	9.05	2.68	9.10	2.67	9.20	2.66	9.57	2.65	9.82	2.64
	40	8.61	2.86	8.80	2.86	8.87	2.85	9.00	2.85	8.96	2.82	9.20	2.79
	43	8.34	2.85	8.48	2.86	8.53	2.87	8.63	2.88	8.95	2.86	8.92	2.84
	46	8.02	2.76	8.05	2.80	8.06	2.82	8.07	2.84	8.55	2.84	8.65	2.84
1.6 + 2.0 + 4.2 + 4.2	22	8.93	1.28	8.12	1.34	7.84	1.36	7.30	1.40	9.14	1.63	10.36	1.79
	25	9.01	1.78	8.53	1.81	8.37	1.82	8.05	1.84	9.40	1.99	10.30	2.09
	29	9.15	2.31	8.95	2.31	8.89	2.31	8.76	2.31	9.60	2.38	10.15	2.42
	32	9.00	2.62	9.04	2.60	9.05	2.60	9.08	2.59	9.64	2.61	10.01	2.62
	35	8.89	2.84	9.05	2.82	9.10	2.81	9.20	2.80	9.57	2.78	9.82	2.77
	40	8.61	3.01	8.80	3.01	8.87	3.00	9.00	3.00	8.96	2.96	9.20	2.94
	43	8.34	3.00	8.48	3.01	8.53	3.02	8.63	3.03	8.95	3.01	8.92	2.99
	46	8.02	2.91	8.05	2.95	8.06	2.96	8.07	2.99	8.55	2.99	8.65	2.99

Combination (Capacity)	Outdoor Air Temp. °C DB	Indoor Air Temp. °C											
		27/16		27/17.5		27/18		27/19		27/22		27/24	
		Total Q	Input Power	Total Q	Input Power	Total Q	Input Power	Total Q	Input Power	Total Q	Input Power	Total Q	Input Power
1.6 + 2.0 + 4.2 + 5.0	22	8.93	1.22	8.12	1.27	7.84	1.29	7.30	1.33	9.14	1.55	10.36	1.70
	25	9.01	1.69	8.53	1.72	8.37	1.73	8.05	1.74	9.40	1.89	10.30	1.98
	29	9.15	2.20	8.95	2.20	8.89	2.20	8.76	2.20	9.60	2.26	10.15	2.30
	32	9.00	2.49	9.04	2.47	9.05	2.47	9.08	2.46	9.64	2.48	10.01	2.49
	35	8.89	2.69	9.05	2.68	9.10	2.67	9.20	2.66	9.57	2.65	9.82	2.64
	40	8.61	2.86	8.80	2.86	8.87	2.85	9.00	2.85	8.96	2.82	9.20	2.79
	43	8.34	2.85	8.48	2.86	8.53	2.87	8.63	2.88	8.95	2.86	8.92	2.84
	46	8.02	2.76	8.05	2.80	8.06	2.82	8.07	2.84	8.55	2.84	8.65	2.84
1.6 + 2.0 + 4.2 + 6.0	22	8.93	1.22	8.12	1.27	7.84	1.29	7.30	1.33	9.14	1.55	10.36	1.70
	25	9.01	1.69	8.53	1.72	8.37	1.73	8.05	1.74	9.40	1.89	10.30	1.98
	29	9.15	2.20	8.95	2.20	8.89	2.20	8.76	2.20	9.60	2.26	10.15	2.30
	32	9.00	2.49	9.04	2.47	9.05	2.47	9.08	2.46	9.64	2.48	10.01	2.49
	35	8.89	2.69	9.05	2.68	9.10	2.67	9.20	2.66	9.57	2.65	9.82	2.64
	40	8.61	2.86	8.80	2.86	8.87	2.85	9.00	2.85	8.96	2.82	9.20	2.79
	43	8.34	2.85	8.48	2.86	8.53	2.87	8.63	2.88	8.95	2.86	8.92	2.84
	46	8.02	2.76	8.05	2.80	8.06	2.82	8.07	2.84	8.55	2.84	8.65	2.84
1.6 + 2.0 + 5.0 + 5.0	22	8.93	1.19	8.12	1.25	7.84	1.26	7.30	1.30	9.14	1.52	10.36	1.66
	25	9.01	1.66	8.53	1.68	8.37	1.69	8.05	1.70	9.40	1.84	10.30	1.94
	29	9.15	2.15	8.95	2.15	8.89	2.15	8.76	2.15	9.60	2.21	10.15	2.25
	32	9.00	2.43	9.04	2.42	9.05	2.41	9.08	2.40	9.64	2.42	10.01	2.43
	35	8.89	2.63	9.05	2.62	9.10	2.61	9.20	2.60	9.57	2.59	9.82	2.58
	40	8.61	2.80	8.80	2.79	8.87	2.79	9.00	2.79	8.96	2.75	9.20	2.73
	43	8.34	2.78	8.48	2.80	8.53	2.80	8.63	2.82	8.95	2.79	8.92	2.77
	46	8.02	2.70	8.05	2.74	8.06	2.75	8.07	2.78	8.55	2.78	8.65	2.77
1.6 + 2.0 + 5.0 + 6.0	22	8.93	1.19	8.12	1.25	7.84	1.26	7.30	1.30	9.14	1.52	10.36	1.66
	25	9.01	1.66	8.53	1.68	8.37	1.69	8.05	1.70	9.40	1.84	10.30	1.94
	29	9.15	2.15	8.95	2.15	8.89	2.15	8.76	2.15	9.60	2.21	10.15	2.25
	32	9.00	2.43	9.04	2.42	9.05	2.41	9.08	2.40	9.64	2.42	10.01	2.43
	35	8.89	2.63	9.05	2.62	9.10	2.61	9.20	2.60	9.57	2.59	9.82	2.58
	40	8.61	2.80	8.80	2.79	8.87	2.79	9.00	2.79	8.96	2.75	9.20	2.73
	43	8.34	2.78	8.48	2.80	8.53	2.80	8.63	2.82	8.95	2.79	8.92	2.77
	46	8.02	2.70	8.05	2.74	8.06	2.75	8.07	2.78	8.55	2.78	8.65	2.77
1.6 + 2.5 + 2.5 + 2.5	22	8.93	1.32	8.12	1.37	7.84	1.39	7.30	1.43	9.14	1.68	10.36	1.84
	25	9.01	1.83	8.53	1.85	8.37	1.86	8.05	1.88	9.40	2.04	10.30	2.14
	29	9.15	2.37	8.95	2.37	8.89	2.37	8.76	2.37	9.60	2.44	10.15	2.48
	32	9.00	2.68	9.04	2.67	9.05	2.66	9.08	2.65	9.64	2.67	10.01	2.69
	35	8.89	2.91	9.05	2.89	9.10	2.88	9.20	2.87	9.57	2.85	9.82	2.84
	40	8.61	3.09	8.80	3.08	8.87	3.08	9.00	3.08	8.96	3.04	9.20	3.01
	43	8.34	3.07	8.48	3.09	8.53	3.10	8.63	3.11	8.95	3.08	8.92	3.06
	46	8.02	2.98	8.05	3.02	8.06	3.04	8.07	3.07	8.55	3.06	8.65	3.06

Combination (Capacity)	Outdoor Air Temp. °C DB	Indoor Air Temp. °C											
		27/16		27/17.5		27/18		27/19		27/22		27/24	
		Total Q	Input Power	Total Q	Input Power	Total Q	Input Power	Total Q	Input Power	Total Q	Input Power	Total Q	Input Power
1.6 + 2.5 + 2.5 + 3.5	22	8.93	1.28	8.12	1.34	7.84	1.36	7.30	1.40	9.14	1.63	10.36	1.79
	25	9.01	1.78	8.53	1.81	8.37	1.82	8.05	1.84	9.40	1.99	10.30	2.09
	29	9.15	2.31	8.95	2.31	8.89	2.31	8.76	2.31	9.60	2.38	10.15	2.42
	32	9.00	2.62	9.04	2.60	9.05	2.60	9.08	2.59	9.64	2.61	10.01	2.62
	35	8.89	2.84	9.05	2.82	9.10	2.81	9.20	2.80	9.57	2.78	9.82	2.77
	40	8.61	3.01	8.80	3.01	8.87	3.00	9.00	3.00	8.96	2.96	9.20	2.94
	43	8.34	3.00	8.48	3.01	8.53	3.02	8.63	3.03	8.95	3.01	8.92	2.99
	46	8.02	2.91	8.05	2.95	8.06	2.96	8.07	2.99	8.55	2.99	8.65	2.99
1.6 + 2.5 + 2.5 + 4.2	22	8.93	1.28	8.12	1.34	7.84	1.36	7.30	1.40	9.14	1.63	10.36	1.79
	25	9.01	1.78	8.53	1.81	8.37	1.82	8.05	1.84	9.40	1.99	10.30	2.09
	29	9.15	2.31	8.95	2.31	8.89	2.31	8.76	2.31	9.60	2.38	10.15	2.42
	32	9.00	2.62	9.04	2.60	9.05	2.60	9.08	2.59	9.64	2.61	10.01	2.62
	35	8.89	2.84	9.05	2.82	9.10	2.81	9.20	2.80	9.57	2.78	9.82	2.77
	40	8.61	3.01	8.80	3.01	8.87	3.00	9.00	3.00	8.96	2.96	9.20	2.94
	43	8.34	3.00	8.48	3.01	8.53	3.02	8.63	3.03	8.95	3.01	8.92	2.99
	46	8.02	2.91	8.05	2.95	8.06	2.96	8.07	2.99	8.55	2.99	8.65	2.99
1.6 + 2.5 + 2.5 + 5.0	22	8.93	1.22	8.12	1.27	7.84	1.29	7.30	1.32	9.14	1.55	10.36	1.70
	25	9.01	1.69	8.53	1.71	8.37	1.72	8.05	1.74	9.40	1.88	10.30	1.97
	29	9.15	2.19	8.95	2.19	8.89	2.19	8.76	2.19	9.60	2.25	10.15	2.29
	32	9.00	2.48	9.04	2.46	9.05	2.46	9.08	2.45	9.64	2.47	10.01	2.48
	35	8.89	2.68	9.05	2.67	9.10	2.66	9.20	2.65	9.57	2.64	9.82	2.63
	40	8.61	2.85	8.80	2.84	8.87	2.84	9.00	2.84	8.96	2.81	9.20	2.78
	43	8.34	2.84	8.48	2.85	8.53	2.86	8.63	2.87	8.95	2.84	8.92	2.83
	46	8.02	2.75	8.05	2.79	8.06	2.80	8.07	2.83	8.55	2.83	8.65	2.83
1.6 + 2.5 + 2.5 + 6.0	22	8.93	1.22	8.12	1.27	7.84	1.29	7.30	1.32	9.14	1.55	10.36	1.70
	25	9.01	1.69	8.53	1.71	8.37	1.72	8.05	1.74	9.40	1.88	10.30	1.97
	29	9.15	2.19	8.95	2.19	8.89	2.19	8.76	2.19	9.60	2.25	10.15	2.29
	32	9.00	2.48	9.04	2.46	9.05	2.46	9.08	2.45	9.64	2.47	10.01	2.48
	35	8.89	2.68	9.05	2.67	9.10	2.66	9.20	2.65	9.57	2.64	9.82	2.63
	40	8.61	2.85	8.80	2.84	8.87	2.84	9.00	2.84	8.96	2.81	9.20	2.78
	43	8.34	2.84	8.48	2.85	8.53	2.86	8.63	2.87	8.95	2.84	8.92	2.83
	46	8.02	2.75	8.05	2.79	8.06	2.80	8.07	2.83	8.55	2.83	8.65	2.83
1.6 + 2.5 + 2.5 + 7.1	22	8.93	1.22	8.12	1.27	7.84	1.29	7.30	1.33	9.14	1.55	10.36	1.70
	25	9.01	1.69	8.53	1.72	8.37	1.73	8.05	1.74	9.40	1.89	10.30	1.98
	29	9.15	2.20	8.95	2.20	8.89	2.20	8.76	2.20	9.60	2.26	10.15	2.30
	32	9.00	2.49	9.04	2.47	9.05	2.47	9.08	2.46	9.64	2.48	10.01	2.49
	35	8.89	2.69	9.05	2.68	9.10	2.67	9.20	2.66	9.57	2.65	9.82	2.64
	40	8.61	2.86	8.80	2.86	8.87	2.85	9.00	2.85	8.96	2.82	9.20	2.79
	43	8.34	2.85	8.48	2.86	8.53	2.87	8.63	2.88	8.95	2.86	8.92	2.84
	46	8.02	2.76	8.05	2.80	8.06	2.82	8.07	2.84	8.55	2.84	8.65	2.84



Combination (Capacity)	Outdoor Air Temp. °C DB	Indoor Air Temp. °C											
		27/16		27/17.5		27/18		27/19		27/22		27/24	
		Total Q	Input Power	Total Q	Input Power	Total Q	Input Power	Total Q	Input Power	Total Q	Input Power	Total Q	Input Power
1.6 + 2.5 + 3.5 + 3.5	22	8.93	1.28	8.12	1.34	7.84	1.36	7.30	1.40	9.14	1.63	10.36	1.79
	25	9.01	1.78	8.53	1.81	8.37	1.82	8.05	1.84	9.40	1.99	10.30	2.09
	29	9.15	2.31	8.95	2.31	8.89	2.31	8.76	2.31	9.60	2.38	10.15	2.42
	32	9.00	2.62	9.04	2.60	9.05	2.60	9.08	2.59	9.64	2.61	10.01	2.62
	35	8.89	2.84	9.05	2.82	9.10	2.81	9.20	2.80	9.57	2.78	9.82	2.77
	40	8.61	3.01	8.80	3.01	8.87	3.00	9.00	3.00	8.96	2.96	9.20	2.94
	43	8.34	3.00	8.48	3.01	8.53	3.02	8.63	3.03	8.95	3.01	8.92	2.99
	46	8.02	2.91	8.05	2.95	8.06	2.96	8.07	2.99	8.55	2.99	8.65	2.99
1.6 + 2.5 + 3.5 + 4.2	22	8.93	1.28	8.12	1.34	7.84	1.36	7.30	1.40	9.14	1.63	10.36	1.79
	25	9.01	1.78	8.53	1.81	8.37	1.82	8.05	1.84	9.40	1.99	10.30	2.09
	29	9.15	2.31	8.95	2.31	8.89	2.31	8.76	2.31	9.60	2.38	10.15	2.42
	32	9.00	2.62	9.04	2.60	9.05	2.60	9.08	2.59	9.64	2.61	10.01	2.62
	35	8.89	2.84	9.05	2.82	9.10	2.81	9.20	2.80	9.57	2.78	9.82	2.77
	40	8.61	3.01	8.80	3.01	8.87	3.00	9.00	3.00	8.96	2.96	9.20	2.94
	43	8.34	3.00	8.48	3.01	8.53	3.02	8.63	3.03	8.95	3.01	8.92	2.99
	46	8.02	2.91	8.05	2.95	8.06	2.96	8.07	2.99	8.55	2.99	8.65	2.99
1.6 + 2.5 + 3.5 + 5.0	22	8.93	1.22	8.12	1.27	7.84	1.29	7.30	1.33	9.14	1.55	10.36	1.70
	25	9.01	1.69	8.53	1.72	8.37	1.73	8.05	1.74	9.40	1.89	10.30	1.98
	29	9.15	2.20	8.95	2.20	8.89	2.20	8.76	2.20	9.60	2.26	10.15	2.30
	32	9.00	2.49	9.04	2.47	9.05	2.47	9.08	2.46	9.64	2.48	10.01	2.49
	35	8.89	2.69	9.05	2.68	9.10	2.67	9.20	2.66	9.57	2.65	9.82	2.64
	40	8.61	2.86	8.80	2.86	8.87	2.85	9.00	2.85	8.96	2.82	9.20	2.79
	43	8.34	2.85	8.48	2.86	8.53	2.87	8.63	2.88	8.95	2.86	8.92	2.84
	46	8.02	2.76	8.05	2.80	8.06	2.82	8.07	2.84	8.55	2.84	8.65	2.84
1.6 + 2.5 + 3.5 + 6.0	22	8.93	1.22	8.12	1.27	7.84	1.29	7.30	1.33	9.14	1.55	10.36	1.70
	25	9.01	1.69	8.53	1.72	8.37	1.73	8.05	1.74	9.40	1.89	10.30	1.98
	29	9.15	2.20	8.95	2.20	8.89	2.20	8.76	2.20	9.60	2.26	10.15	2.30
	32	9.00	2.49	9.04	2.47	9.05	2.47	9.08	2.46	9.64	2.48	10.01	2.49
	35	8.89	2.69	9.05	2.68	9.10	2.67	9.20	2.66	9.57	2.65	9.82	2.64
	40	8.61	2.86	8.80	2.86	8.87	2.85	9.00	2.85	8.96	2.82	9.20	2.79
	43	8.34	2.85	8.48	2.86	8.53	2.87	8.63	2.88	8.95	2.86	8.92	2.84
	46	8.02	2.76	8.05	2.80	8.06	2.82	8.07	2.84	8.55	2.84	8.65	2.84
1.6 + 2.5 + 3.5 + 7.1	22	8.93	1.22	8.12	1.27	7.84	1.29	7.30	1.33	9.14	1.55	10.36	1.70
	25	9.01	1.69	8.53	1.72	8.37	1.73	8.05	1.74	9.40	1.89	10.30	1.98
	29	9.15	2.20	8.95	2.20	8.89	2.20	8.76	2.20	9.60	2.26	10.15	2.30
	32	9.00	2.49	9.04	2.47	9.05	2.47	9.08	2.46	9.64	2.48	10.01	2.49
	35	8.89	2.69	9.05	2.68	9.10	2.67	9.20	2.66	9.57	2.65	9.82	2.64
	40	8.61	2.86	8.80	2.86	8.87	2.85	9.00	2.85	8.96	2.82	9.20	2.79
	43	8.34	2.85	8.48	2.86	8.53	2.87	8.63	2.88	8.95	2.86	8.92	2.84
	46	8.02	2.76	8.05	2.80	8.06	2.82	8.07	2.84	8.55	2.84	8.65	2.84

Combination (Capacity)	Outdoor Air Temp. °C DB	Indoor Air Temp. °C											
		27/16		27/17.5		27/18		27/19		27/22		27/24	
		Total Q	Input Power	Total Q	Input Power	Total Q	Input Power	Total Q	Input Power	Total Q	Input Power	Total Q	Input Power
1.6 + 2.5 + 4.2 + 4.2	22	8.93	1.28	8.12	1.34	7.84	1.36	7.30	1.40	9.14	1.63	10.36	1.79
	25	9.01	1.78	8.53	1.81	8.37	1.82	8.05	1.84	9.40	1.99	10.30	2.09
	29	9.15	2.31	8.95	2.31	8.89	2.31	8.76	2.31	9.60	2.38	10.15	2.42
	32	9.00	2.62	9.04	2.60	9.05	2.60	9.08	2.59	9.64	2.61	10.01	2.62
	35	8.89	2.84	9.05	2.82	9.10	2.81	9.20	2.80	9.57	2.78	9.82	2.77
	40	8.61	3.01	8.80	3.01	8.87	3.00	9.00	3.00	8.96	2.96	9.20	2.94
	43	8.34	3.00	8.48	3.01	8.53	3.02	8.63	3.03	8.95	3.01	8.92	2.99
	46	8.02	2.91	8.05	2.95	8.06	2.96	8.07	2.99	8.55	2.99	8.65	2.99
1.6 + 2.5 + 4.2 + 5.0	22	8.93	1.22	8.12	1.27	7.84	1.29	7.30	1.33	9.14	1.55	10.36	1.70
	25	9.01	1.69	8.53	1.72	8.37	1.73	8.05	1.74	9.40	1.89	10.30	1.98
	29	9.15	2.20	8.95	2.20	8.89	2.20	8.76	2.20	9.60	2.26	10.15	2.30
	32	9.00	2.49	9.04	2.47	9.05	2.47	9.08	2.46	9.64	2.48	10.01	2.49
	35	8.89	2.69	9.05	2.68	9.10	2.67	9.20	2.66	9.57	2.65	9.82	2.64
	40	8.61	2.86	8.80	2.86	8.87	2.85	9.00	2.85	8.96	2.82	9.20	2.79
	43	8.34	2.85	8.48	2.86	8.53	2.87	8.63	2.88	8.95	2.86	8.92	2.84
	46	8.02	2.76	8.05	2.80	8.06	2.82	8.07	2.84	8.55	2.84	8.65	2.84
1.6 + 2.5 + 4.2 + 6.0	22	8.93	1.22	8.12	1.27	7.84	1.29	7.30	1.33	9.14	1.55	10.36	1.70
	25	9.01	1.69	8.53	1.72	8.37	1.73	8.05	1.74	9.40	1.89	10.30	1.98
	29	9.15	2.20	8.95	2.20	8.89	2.20	8.76	2.20	9.60	2.26	10.15	2.30
	32	9.00	2.49	9.04	2.47	9.05	2.47	9.08	2.46	9.64	2.48	10.01	2.49
	35	8.89	2.69	9.05	2.68	9.10	2.67	9.20	2.66	9.57	2.65	9.82	2.64
	40	8.61	2.86	8.80	2.86	8.87	2.85	9.00	2.85	8.96	2.82	9.20	2.79
	43	8.34	2.85	8.48	2.86	8.53	2.87	8.63	2.88	8.95	2.86	8.92	2.84
	46	8.02	2.76	8.05	2.80	8.06	2.82	8.07	2.84	8.55	2.84	8.65	2.84
1.6 + 2.5 + 5.0 + 5.0	22	8.93	1.19	8.12	1.25	7.84	1.26	7.30	1.30	9.14	1.52	10.36	1.66
	25	9.01	1.66	8.53	1.68	8.37	1.69	8.05	1.70	9.40	1.84	10.30	1.94
	29	9.15	2.15	8.95	2.15	8.89	2.15	8.76	2.15	9.60	2.21	10.15	2.25
	32	9.00	2.43	9.04	2.42	9.05	2.41	9.08	2.40	9.64	2.42	10.01	2.43
	35	8.89	2.63	9.05	2.62	9.10	2.61	9.20	2.60	9.57	2.59	9.82	2.58
	40	8.61	2.80	8.80	2.79	8.87	2.79	9.00	2.79	8.96	2.75	9.20	2.73
	43	8.34	2.78	8.48	2.80	8.53	2.80	8.63	2.82	8.95	2.79	8.92	2.77
	46	8.02	2.70	8.05	2.74	8.06	2.75	8.07	2.78	8.55	2.78	8.65	2.77
1.6 + 3.5 + 3.5 + 3.5	22	8.93	1.28	8.12	1.34	7.84	1.36	7.30	1.40	9.14	1.63	10.36	1.79
	25	9.01	1.78	8.53	1.81	8.37	1.82	8.05	1.84	9.40	1.99	10.30	2.09
	29	9.15	2.31	8.95	2.31	8.89	2.31	8.76	2.31	9.60	2.38	10.15	2.42
	32	9.00	2.62	9.04	2.60	9.05	2.60	9.08	2.59	9.64	2.61	10.01	2.62
	35	8.89	2.84	9.05	2.82	9.10	2.81	9.20	2.80	9.57	2.78	9.82	2.77
	40	8.61	3.01	8.80	3.01	8.87	3.00	9.00	3.00	8.96	2.96	9.20	2.94
	43	8.34	3.00	8.48	3.01	8.53	3.02	8.63	3.03	8.95	3.01	8.92	2.99
	46	8.02	2.91	8.05	2.95	8.06	2.96	8.07	2.99	8.55	2.99	8.65	2.99

Combination (Capacity)	Outdoor Air Temp. °C DB	Indoor Air Temp. °C											
		27/16		27/17.5		27/18		27/19		27/22		27/24	
		Total Q	Input Power	Total Q	Input Power	Total Q	Input Power	Total Q	Input Power	Total Q	Input Power	Total Q	Input Power
1.6 + 3.5 + 3.5 + 4.2	22	8.93	1.25	8.12	1.30	7.84	1.32	7.30	1.36	9.14	1.59	10.36	1.74
	25	9.01	1.73	8.53	1.76	8.37	1.77	8.05	1.78	9.40	1.93	10.30	2.03
	29	9.15	2.25	8.95	2.25	8.89	2.25	8.76	2.25	9.60	2.31	10.15	2.35
	32	9.00	2.54	9.04	2.53	9.05	2.52	9.08	2.52	9.64	2.53	10.01	2.55
	35	8.89	2.75	9.05	2.74	9.10	2.73	9.20	2.72	9.57	2.70	9.82	2.69
	40	8.61	2.92	8.80	2.92	8.87	2.92	9.00	2.92	8.96	2.88	9.20	2.86
	43	8.34	2.91	8.48	2.93	8.53	2.93	8.63	2.95	8.95	2.92	8.92	2.90
	46	8.02	2.82	8.05	2.86	8.06	2.88	8.07	2.91	8.55	2.90	8.65	2.90
1.6 + 3.5 + 3.5 + 5.0	22	8.93	1.22	8.12	1.27	7.84	1.29	7.30	1.33	9.14	1.55	10.36	1.70
	25	9.01	1.69	8.53	1.72	8.37	1.73	8.05	1.74	9.40	1.89	10.30	1.98
	29	9.15	2.20	8.95	2.20	8.89	2.20	8.76	2.20	9.60	2.26	10.15	2.30
	32	9.00	2.49	9.04	2.47	9.05	2.47	9.08	2.46	9.64	2.48	10.01	2.49
	35	8.89	2.69	9.05	2.68	9.10	2.67	9.20	2.66	9.57	2.65	9.82	2.64
	40	8.61	2.86	8.80	2.86	8.87	2.85	9.00	2.85	8.96	2.82	9.20	2.79
	43	8.34	2.85	8.48	2.86	8.53	2.87	8.63	2.88	8.95	2.86	8.92	2.84
	46	8.02	2.76	8.05	2.80	8.06	2.82	8.07	2.84	8.55	2.84	8.65	2.84
1.6 + 3.5 + 3.5 + 6.0	22	8.93	1.22	8.12	1.27	7.84	1.29	7.30	1.33	9.14	1.55	10.36	1.70
	25	9.01	1.69	8.53	1.72	8.37	1.73	8.05	1.74	9.40	1.89	10.30	1.98
	29	9.15	2.20	8.95	2.20	8.89	2.20	8.76	2.20	9.60	2.26	10.15	2.30
	32	9.00	2.49	9.04	2.47	9.05	2.47	9.08	2.46	9.64	2.48	10.01	2.49
	35	8.89	2.69	9.05	2.68	9.10	2.67	9.20	2.66	9.57	2.65	9.82	2.64
	40	8.61	2.86	8.80	2.86	8.87	2.85	9.00	2.85	8.96	2.82	9.20	2.79
	43	8.34	2.85	8.48	2.86	8.53	2.87	8.63	2.88	8.95	2.86	8.92	2.84
	46	8.02	2.76	8.05	2.80	8.06	2.82	8.07	2.84	8.55	2.84	8.65	2.84
1.6 + 3.5 + 4.2 + 4.2	22	8.93	1.25	8.12	1.30	7.84	1.32	7.30	1.36	9.14	1.59	10.36	1.74
	25	9.01	1.73	8.53	1.76	8.37	1.77	8.05	1.78	9.40	1.93	10.30	2.03
	29	9.15	2.25	8.95	2.25	8.89	2.25	8.76	2.25	9.60	2.31	10.15	2.35
	32	9.00	2.54	9.04	2.53	9.05	2.52	9.08	2.52	9.64	2.53	10.01	2.55
	35	8.89	2.75	9.05	2.74	9.10	2.73	9.20	2.72	9.57	2.70	9.82	2.69
	40	8.61	2.92	8.80	2.92	8.87	2.92	9.00	2.92	8.96	2.88	9.20	2.86
	43	8.34	2.91	8.48	2.93	8.53	2.93	8.63	2.95	8.95	2.92	8.92	2.90
	46	8.02	2.82	8.05	2.86	8.06	2.88	8.07	2.91	8.55	2.90	8.65	2.90
1.6 + 3.5 + 4.2 + 5.0	22	8.93	1.22	8.12	1.27	7.84	1.29	7.30	1.33	9.14	1.55	10.36	1.70
	25	9.01	1.69	8.53	1.72	8.37	1.73	8.05	1.74	9.40	1.89	10.30	1.98
	29	9.15	2.20	8.95	2.20	8.89	2.20	8.76	2.20	9.60	2.26	10.15	2.30
	32	9.00	2.49	9.04	2.47	9.05	2.47	9.08	2.46	9.64	2.48	10.01	2.49
	35	8.89	2.69	9.05	2.68	9.10	2.67	9.20	2.66	9.57	2.65	9.82	2.64
	40	8.61	2.86	8.80	2.86	8.87	2.85	9.00	2.85	8.96	2.82	9.20	2.79
	43	8.34	2.85	8.48	2.86	8.53	2.87	8.63	2.88	8.95	2.86	8.92	2.84
	46	8.02	2.76	8.05	2.80	8.06	2.82	8.07	2.84	8.55	2.84	8.65	2.84

Combination (Capacity)	Outdoor Air Temp. °C DB	Indoor Air Temp. °C											
		27/16		27/17.5		27/18		27/19		27/22		27/24	
		Total Q	Input Power	Total Q	Input Power	Total Q	Input Power	Total Q	Input Power	Total Q	Input Power	Total Q	Input Power
1.6 + 4.2 + 4.2 + 4.2	22	8.93	1.25	8.12	1.30	7.84	1.32	7.30	1.36	9.14	1.59	10.36	1.74
	25	9.01	1.73	8.53	1.76	8.37	1.77	8.05	1.78	9.40	1.93	10.30	2.03
	29	9.15	2.25	8.95	2.25	8.89	2.25	8.76	2.25	9.60	2.31	10.15	2.35
	32	9.00	2.54	9.04	2.53	9.05	2.52	9.08	2.52	9.64	2.53	10.01	2.55
	35	8.89	2.75	9.05	2.74	9.10	2.73	9.20	2.72	9.57	2.70	9.82	2.69
	40	8.61	2.92	8.80	2.92	8.87	2.92	9.00	2.92	8.96	2.88	9.20	2.86
	43	8.34	2.91	8.48	2.93	8.53	2.93	8.63	2.95	8.95	2.92	8.92	2.90
	46	8.02	2.82	8.05	2.86	8.06	2.88	8.07	2.91	8.55	2.90	8.65	2.90
2.0 + 2.0 + 2.0 + 2.0	22	8.93	1.32	8.12	1.37	7.84	1.39	7.30	1.43	9.14	1.68	10.36	1.84
	25	9.01	1.83	8.53	1.85	8.37	1.86	8.05	1.88	9.40	2.04	10.30	2.14
	29	9.15	2.37	8.95	2.37	8.89	2.37	8.76	2.37	9.60	2.44	10.15	2.48
	32	9.00	2.68	9.04	2.67	9.05	2.66	9.08	2.65	9.64	2.67	10.01	2.69
	35	8.89	2.91	9.05	2.89	9.10	2.88	9.20	2.87	9.57	2.85	9.82	2.84
	40	8.61	3.09	8.80	3.08	8.87	3.08	9.00	3.08	8.96	3.04	9.20	3.01
	43	8.34	3.07	8.48	3.09	8.53	3.10	8.63	3.11	8.95	3.08	8.92	3.06
	46	8.02	2.98	8.05	3.02	8.06	3.04	8.07	3.07	8.55	3.06	8.65	3.06
2.0 + 2.0 + 2.0 + 2.5	22	8.93	1.32	8.12	1.37	7.84	1.39	7.30	1.43	9.14	1.68	10.36	1.84
	25	9.01	1.83	8.53	1.85	8.37	1.86	8.05	1.88	9.40	2.04	10.30	2.14
	29	9.15	2.37	8.95	2.37	8.89	2.37	8.76	2.37	9.60	2.44	10.15	2.48
	32	9.00	2.68	9.04	2.67	9.05	2.66	9.08	2.65	9.64	2.67	10.01	2.69
	35	8.89	2.91	9.05	2.89	9.10	2.88	9.20	2.87	9.57	2.85	9.82	2.84
	40	8.61	3.09	8.80	3.08	8.87	3.08	9.00	3.08	8.96	3.04	9.20	3.01
	43	8.34	3.07	8.48	3.09	8.53	3.10	8.63	3.11	8.95	3.08	8.92	3.06
	46	8.02	2.98	8.05	3.02	8.06	3.04	8.07	3.07	8.55	3.06	8.65	3.06
2.0 + 2.0 + 2.0 + 3.5	22	8.93	1.28	8.12	1.34	7.84	1.36	7.30	1.40	9.14	1.63	10.36	1.79
	25	9.01	1.78	8.53	1.81	8.37	1.82	8.05	1.84	9.40	1.99	10.30	2.09
	29	9.15	2.31	8.95	2.31	8.89	2.31	8.76	2.31	9.60	2.38	10.15	2.42
	32	9.00	2.62	9.04	2.60	9.05	2.60	9.08	2.59	9.64	2.61	10.01	2.62
	35	8.89	2.84	9.05	2.82	9.10	2.81	9.20	2.80	9.57	2.78	9.82	2.77
	40	8.61	3.01	8.80	3.01	8.87	3.00	9.00	3.00	8.96	2.96	9.20	2.94
	43	8.34	3.00	8.48	3.01	8.53	3.02	8.63	3.03	8.95	3.01	8.92	2.99
	46	8.02	2.91	8.05	2.95	8.06	2.96	8.07	2.99	8.55	2.99	8.65	2.99
2.0 + 2.0 + 2.0 + 4.2	22	8.93	1.28	8.12	1.34	7.84	1.36	7.30	1.40	9.14	1.63	10.36	1.79
	25	9.01	1.78	8.53	1.81	8.37	1.82	8.05	1.84	9.40	1.99	10.30	2.09
	29	9.15	2.31	8.95	2.31	8.89	2.31	8.76	2.31	9.60	2.38	10.15	2.42
	32	9.00	2.62	9.04	2.60	9.05	2.60	9.08	2.59	9.64	2.61	10.01	2.62
	35	8.89	2.84	9.05	2.82	9.10	2.81	9.20	2.80	9.57	2.78	9.82	2.77
	40	8.61	3.01	8.80	3.01	8.87	3.00	9.00	3.00	8.96	2.96	9.20	2.94
	43	8.34	3.00	8.48	3.01	8.53	3.02	8.63	3.03	8.95	3.01	8.92	2.99
	46	8.02	2.91	8.05	2.95	8.06	2.96	8.07	2.99	8.55	2.99	8.65	2.99

Combination (Capacity)	Outdoor Air Temp. °C DB	Indoor Air Temp. °C											
		27/16		27/17.5		27/18		27/19		27/22		27/24	
		Total Q	Input Power	Total Q	Input Power	Total Q	Input Power	Total Q	Input Power	Total Q	Input Power	Total Q	Input Power
2.0 + 2.0 + 2.0 + 5.0	22	8.93	1.22	8.12	1.27	7.84	1.29	7.30	1.32	9.14	1.55	10.36	1.70
	25	9.01	1.69	8.53	1.71	8.37	1.72	8.05	1.74	9.40	1.88	10.30	1.97
	29	9.15	2.19	8.95	2.19	8.89	2.19	8.76	2.19	9.60	2.25	10.15	2.29
	32	9.00	2.48	9.04	2.46	9.05	2.46	9.08	2.45	9.64	2.47	10.01	2.48
	35	8.89	2.68	9.05	2.67	9.10	2.66	9.20	2.65	9.57	2.64	9.82	2.63
	40	8.61	2.85	8.80	2.84	8.87	2.84	9.00	2.84	8.96	2.81	9.20	2.78
	43	8.34	2.84	8.48	2.85	8.53	2.86	8.63	2.87	8.95	2.84	8.92	2.83
	46	8.02	2.75	8.05	2.79	8.06	2.80	8.07	2.83	8.55	2.83	8.65	2.83
2.0 + 2.0 + 2.0 + 6.0	22	8.93	1.22	8.12	1.27	7.84	1.29	7.30	1.32	9.14	1.55	10.36	1.70
	25	9.01	1.69	8.53	1.71	8.37	1.72	8.05	1.74	9.40	1.88	10.30	1.97
	29	9.15	2.19	8.95	2.19	8.89	2.19	8.76	2.19	9.60	2.25	10.15	2.29
	32	9.00	2.48	9.04	2.46	9.05	2.46	9.08	2.45	9.64	2.47	10.01	2.48
	35	8.89	2.68	9.05	2.67	9.10	2.66	9.20	2.65	9.57	2.64	9.82	2.63
	40	8.61	2.85	8.80	2.84	8.87	2.84	9.00	2.84	8.96	2.81	9.20	2.78
	43	8.34	2.84	8.48	2.85	8.53	2.86	8.63	2.87	8.95	2.84	8.92	2.83
	46	8.02	2.75	8.05	2.79	8.06	2.80	8.07	2.83	8.55	2.83	8.65	2.83
2.0 + 2.0 + 2.0 + 7.1	22	8.93	1.22	8.12	1.27	7.84	1.29	7.30	1.33	9.14	1.55	10.36	1.70
	25	9.01	1.69	8.53	1.72	8.37	1.73	8.05	1.74	9.40	1.89	10.30	1.98
	29	9.15	2.20	8.95	2.20	8.89	2.20	8.76	2.20	9.60	2.26	10.15	2.30
	32	9.00	2.49	9.04	2.47	9.05	2.47	9.08	2.46	9.64	2.48	10.01	2.49
	35	8.89	2.69	9.05	2.68	9.10	2.67	9.20	2.66	9.57	2.65	9.82	2.64
	40	8.61	2.86	8.80	2.86	8.87	2.85	9.00	2.85	8.96	2.82	9.20	2.79
	43	8.34	2.85	8.48	2.86	8.53	2.87	8.63	2.88	8.95	2.86	8.92	2.84
	46	8.02	2.76	8.05	2.80	8.06	2.82	8.07	2.84	8.55	2.84	8.65	2.84
2.0 + 2.0 + 2.5 + 2.5	22	8.93	1.32	8.12	1.37	7.84	1.39	7.30	1.43	9.14	1.68	10.36	1.84
	25	9.01	1.83	8.53	1.85	8.37	1.86	8.05	1.88	9.40	2.04	10.30	2.14
	29	9.15	2.37	8.95	2.37	8.89	2.37	8.76	2.37	9.60	2.44	10.15	2.48
	32	9.00	2.68	9.04	2.67	9.05	2.66	9.08	2.65	9.64	2.67	10.01	2.69
	35	8.89	2.91	9.05	2.89	9.10	2.88	9.20	2.87	9.57	2.85	9.82	2.84
	40	8.61	3.09	8.80	3.08	8.87	3.08	9.00	3.08	8.96	3.04	9.20	3.01
	43	8.34	3.07	8.48	3.09	8.53	3.10	8.63	3.11	8.95	3.08	8.92	3.06
	46	8.02	2.98	8.05	3.02	8.06	3.04	8.07	3.07	8.55	3.06	8.65	3.06
2.0 + 2.0 + 2.5 + 3.5	22	8.93	1.28	8.12	1.34	7.84	1.36	7.30	1.40	9.14	1.63	10.36	1.79
	25	9.01	1.78	8.53	1.81	8.37	1.82	8.05	1.84	9.40	1.99	10.30	2.09
	29	9.15	2.31	8.95	2.31	8.89	2.31	8.76	2.31	9.60	2.38	10.15	2.42
	32	9.00	2.62	9.04	2.60	9.05	2.60	9.08	2.59	9.64	2.61	10.01	2.62
	35	8.89	2.84	9.05	2.82	9.10	2.81	9.20	2.80	9.57	2.78	9.82	2.77
	40	8.61	3.01	8.80	3.01	8.87	3.00	9.00	3.00	8.96	2.96	9.20	2.94
	43	8.34	3.00	8.48	3.01	8.53	3.02	8.63	3.03	8.95	3.01	8.92	2.99
	46	8.02	2.91	8.05	2.95	8.06	2.96	8.07	2.99	8.55	2.99	8.65	2.99

Combination (Capacity)	Outdoor Air Temp. °C DB	Indoor Air Temp. °C											
		27/16		27/17.5		27/18		27/19		27/22		27/24	
		Total Q	Input Power	Total Q	Input Power	Total Q	Input Power	Total Q	Input Power	Total Q	Input Power	Total Q	Input Power
2.0 + 2.0 + 2.5 + 4.2	22	8.93	1.28	8.12	1.34	7.84	1.36	7.30	1.40	9.14	1.63	10.36	1.79
	25	9.01	1.78	8.53	1.81	8.37	1.82	8.05	1.84	9.40	1.99	10.30	2.09
	29	9.15	2.31	8.95	2.31	8.89	2.31	8.76	2.31	9.60	2.38	10.15	2.42
	32	9.00	2.62	9.04	2.60	9.05	2.60	9.08	2.59	9.64	2.61	10.01	2.62
	35	8.89	2.84	9.05	2.82	9.10	2.81	9.20	2.80	9.57	2.78	9.82	2.77
	40	8.61	3.01	8.80	3.01	8.87	3.00	9.00	3.00	8.96	2.96	9.20	2.94
	43	8.34	3.00	8.48	3.01	8.53	3.02	8.63	3.03	8.95	3.01	8.92	2.99
	46	8.02	2.91	8.05	2.95	8.06	2.96	8.07	2.99	8.55	2.99	8.65	2.99
2.0 + 2.0 + 2.5 + 5.0	22	8.93	1.22	8.12	1.27	7.84	1.29	7.30	1.32	9.14	1.55	10.36	1.70
	25	9.01	1.69	8.53	1.71	8.37	1.72	8.05	1.74	9.40	1.88	10.30	1.97
	29	9.15	2.19	8.95	2.19	8.89	2.19	8.76	2.19	9.60	2.25	10.15	2.29
	32	9.00	2.48	9.04	2.46	9.05	2.46	9.08	2.45	9.64	2.47	10.01	2.48
	35	8.89	2.68	9.05	2.67	9.10	2.66	9.20	2.65	9.57	2.64	9.82	2.63
	40	8.61	2.85	8.80	2.84	8.87	2.84	9.00	2.84	8.96	2.81	9.20	2.78
	43	8.34	2.84	8.48	2.85	8.53	2.86	8.63	2.87	8.95	2.84	8.92	2.83
	46	8.02	2.75	8.05	2.79	8.06	2.80	8.07	2.83	8.55	2.83	8.65	2.83
2.0 + 2.0 + 2.5 + 6.0	22	8.93	1.22	8.12	1.27	7.84	1.29	7.30	1.32	9.14	1.55	10.36	1.70
	25	9.01	1.69	8.53	1.71	8.37	1.72	8.05	1.74	9.40	1.88	10.30	1.97
	29	9.15	2.19	8.95	2.19	8.89	2.19	8.76	2.19	9.60	2.25	10.15	2.29
	32	9.00	2.48	9.04	2.46	9.05	2.46	9.08	2.45	9.64	2.47	10.01	2.48
	35	8.89	2.68	9.05	2.67	9.10	2.66	9.20	2.65	9.57	2.64	9.82	2.63
	40	8.61	2.85	8.80	2.84	8.87	2.84	9.00	2.84	8.96	2.81	9.20	2.78
	43	8.34	2.84	8.48	2.85	8.53	2.86	8.63	2.87	8.95	2.84	8.92	2.83
	46	8.02	2.75	8.05	2.79	8.06	2.80	8.07	2.83	8.55	2.83	8.65	2.83
2.0 + 2.0 + 2.5 + 7.1	22	8.93	1.22	8.12	1.27	7.84	1.29	7.30	1.33	9.14	1.55	10.36	1.70
	25	9.01	1.69	8.53	1.72	8.37	1.73	8.05	1.74	9.40	1.89	10.30	1.98
	29	9.15	2.20	8.95	2.20	8.89	2.20	8.76	2.20	9.60	2.26	10.15	2.30
	32	9.00	2.49	9.04	2.47	9.05	2.47	9.08	2.46	9.64	2.48	10.01	2.49
	35	8.89	2.69	9.05	2.68	9.10	2.67	9.20	2.66	9.57	2.65	9.82	2.64
	40	8.61	2.86	8.80	2.86	8.87	2.85	9.00	2.85	8.96	2.82	9.20	2.79
	43	8.34	2.85	8.48	2.86	8.53	2.87	8.63	2.88	8.95	2.86	8.92	2.84
	46	8.02	2.76	8.05	2.80	8.06	2.82	8.07	2.84	8.55	2.84	8.65	2.84
2.0 + 2.0 + 3.5 + 3.5	22	8.93	1.28	8.12	1.34	7.84	1.36	7.30	1.40	9.14	1.63	10.36	1.79
	25	9.01	1.78	8.53	1.81	8.37	1.82	8.05	1.84	9.40	1.99	10.30	2.09
	29	9.15	2.31	8.95	2.31	8.89	2.31	8.76	2.31	9.60	2.38	10.15	2.42
	32	9.00	2.62	9.04	2.60	9.05	2.60	9.08	2.59	9.64	2.61	10.01	2.62
	35	8.89	2.84	9.05	2.82	9.10	2.81	9.20	2.80	9.57	2.78	9.82	2.77
	40	8.61	3.01	8.80	3.01	8.87	3.00	9.00	3.00	8.96	2.96	9.20	2.94
	43	8.34	3.00	8.48	3.01	8.53	3.02	8.63	3.03	8.95	3.01	8.92	2.99
	46	8.02	2.91	8.05	2.95	8.06	2.96	8.07	2.99	8.55	2.99	8.65	2.99

Combination (Capacity)	Outdoor Air Temp. °C DB	Indoor Air Temp. °C											
		27/16		27/17.5		27/18		27/19		27/22		27/24	
		Total Q	Input Power	Total Q	Input Power	Total Q	Input Power	Total Q	Input Power	Total Q	Input Power	Total Q	Input Power
2.0 + 2.0 + 3.5 + 4.2	22	8.93	1.28	8.12	1.34	7.84	1.36	7.30	1.40	9.14	1.63	10.36	1.79
	25	9.01	1.78	8.53	1.81	8.37	1.82	8.05	1.84	9.40	1.99	10.30	2.09
	29	9.15	2.31	8.95	2.31	8.89	2.31	8.76	2.31	9.60	2.38	10.15	2.42
	32	9.00	2.62	9.04	2.60	9.05	2.60	9.08	2.59	9.64	2.61	10.01	2.62
	35	8.89	2.84	9.05	2.82	9.10	2.81	9.20	2.80	9.57	2.78	9.82	2.77
	40	8.61	3.01	8.80	3.01	8.87	3.00	9.00	3.00	8.96	2.96	9.20	2.94
	43	8.34	3.00	8.48	3.01	8.53	3.02	8.63	3.03	8.95	3.01	8.92	2.99
	46	8.02	2.91	8.05	2.95	8.06	2.96	8.07	2.99	8.55	2.99	8.65	2.99
2.0 + 2.0 + 3.5 + 5.0	22	8.93	1.22	8.12	1.27	7.84	1.29	7.30	1.33	9.14	1.55	10.36	1.70
	25	9.01	1.69	8.53	1.72	8.37	1.73	8.05	1.74	9.40	1.89	10.30	1.98
	29	9.15	2.20	8.95	2.20	8.89	2.20	8.76	2.20	9.60	2.26	10.15	2.30
	32	9.00	2.49	9.04	2.47	9.05	2.47	9.08	2.46	9.64	2.48	10.01	2.49
	35	8.89	2.69	9.05	2.68	9.10	2.67	9.20	2.66	9.57	2.65	9.82	2.64
	40	8.61	2.86	8.80	2.86	8.87	2.85	9.00	2.85	8.96	2.82	9.20	2.79
	43	8.34	2.85	8.48	2.86	8.53	2.87	8.63	2.88	8.95	2.86	8.92	2.84
	46	8.02	2.76	8.05	2.80	8.06	2.82	8.07	2.84	8.55	2.84	8.65	2.84
2.0 + 2.0 + 3.5 + 6.0	22	8.93	1.22	8.12	1.27	7.84	1.29	7.30	1.33	9.14	1.55	10.36	1.70
	25	9.01	1.69	8.53	1.72	8.37	1.73	8.05	1.74	9.40	1.89	10.30	1.98
	29	9.15	2.20	8.95	2.20	8.89	2.20	8.76	2.20	9.60	2.26	10.15	2.30
	32	9.00	2.49	9.04	2.47	9.05	2.47	9.08	2.46	9.64	2.48	10.01	2.49
	35	8.89	2.69	9.05	2.68	9.10	2.67	9.20	2.66	9.57	2.65	9.82	2.64
	40	8.61	2.86	8.80	2.86	8.87	2.85	9.00	2.85	8.96	2.82	9.20	2.79
	43	8.34	2.85	8.48	2.86	8.53	2.87	8.63	2.88	8.95	2.86	8.92	2.84
	46	8.02	2.76	8.05	2.80	8.06	2.82	8.07	2.84	8.55	2.84	8.65	2.84
2.0 + 2.0 + 3.5 + 7.1	22	8.93	1.22	8.12	1.27	7.84	1.29	7.30	1.33	9.14	1.55	10.36	1.70
	25	9.01	1.69	8.53	1.72	8.37	1.73	8.05	1.74	9.40	1.89	10.30	1.98
	29	9.15	2.20	8.95	2.20	8.89	2.20	8.76	2.20	9.60	2.26	10.15	2.30
	32	9.00	2.49	9.04	2.47	9.05	2.47	9.08	2.46	9.64	2.48	10.01	2.49
	35	8.89	2.69	9.05	2.68	9.10	2.67	9.20	2.66	9.57	2.65	9.82	2.64
	40	8.61	2.86	8.80	2.86	8.87	2.85	9.00	2.85	8.96	2.82	9.20	2.79
	43	8.34	2.85	8.48	2.86	8.53	2.87	8.63	2.88	8.95	2.86	8.92	2.84
	46	8.02	2.76	8.05	2.80	8.06	2.82	8.07	2.84	8.55	2.84	8.65	2.84
2.0 + 2.0 + 4.2 + 4.2	22	8.93	1.28	8.12	1.34	7.84	1.36	7.30	1.40	9.14	1.63	10.36	1.79
	25	9.01	1.78	8.53	1.81	8.37	1.82	8.05	1.84	9.40	1.99	10.30	2.09
	29	9.15	2.31	8.95	2.31	8.89	2.31	8.76	2.31	9.60	2.38	10.15	2.42
	32	9.00	2.62	9.04	2.60	9.05	2.60	9.08	2.59	9.64	2.61	10.01	2.62
	35	8.89	2.84	9.05	2.82	9.10	2.81	9.20	2.80	9.57	2.78	9.82	2.77
	40	8.61	3.01	8.80	3.01	8.87	3.00	9.00	3.00	8.96	2.96	9.20	2.94
	43	8.34	3.00	8.48	3.01	8.53	3.02	8.63	3.03	8.95	3.01	8.92	2.99
	46	8.02	2.91	8.05	2.95	8.06	2.96	8.07	2.99	8.55	2.99	8.65	2.99

Combination (Capacity)	Outdoor Air Temp. °C DB	Indoor Air Temp. °C											
		27/16		27/17.5		27/18		27/19		27/22		27/24	
		Total Q	Input Power	Total Q	Input Power	Total Q	Input Power	Total Q	Input Power	Total Q	Input Power	Total Q	Input Power
2.0 + 2.0 + 4.2 + 5.0	22	8.93	1.22	8.12	1.27	7.84	1.29	7.30	1.33	9.14	1.55	10.36	1.70
	25	9.01	1.69	8.53	1.72	8.37	1.73	8.05	1.74	9.40	1.89	10.30	1.98
	29	9.15	2.20	8.95	2.20	8.89	2.20	8.76	2.20	9.60	2.26	10.15	2.30
	32	9.00	2.49	9.04	2.47	9.05	2.47	9.08	2.46	9.64	2.48	10.01	2.49
	35	8.89	2.69	9.05	2.68	9.10	2.67	9.20	2.66	9.57	2.65	9.82	2.64
	40	8.61	2.86	8.80	2.86	8.87	2.85	9.00	2.85	8.96	2.82	9.20	2.79
	43	8.34	2.85	8.48	2.86	8.53	2.87	8.63	2.88	8.95	2.86	8.92	2.84
	46	8.02	2.76	8.05	2.80	8.06	2.82	8.07	2.84	8.55	2.84	8.65	2.84
2.0 + 2.0 + 4.2 + 6.0	22	8.93	1.22	8.12	1.27	7.84	1.29	7.30	1.33	9.14	1.55	10.36	1.70
	25	9.01	1.69	8.53	1.72	8.37	1.73	8.05	1.74	9.40	1.89	10.30	1.98
	29	9.15	2.20	8.95	2.20	8.89	2.20	8.76	2.20	9.60	2.26	10.15	2.30
	32	9.00	2.49	9.04	2.47	9.05	2.47	9.08	2.46	9.64	2.48	10.01	2.49
	35	8.89	2.69	9.05	2.68	9.10	2.67	9.20	2.66	9.57	2.65	9.82	2.64
	40	8.61	2.86	8.80	2.86	8.87	2.85	9.00	2.85	8.96	2.82	9.20	2.79
	43	8.34	2.85	8.48	2.86	8.53	2.87	8.63	2.88	8.95	2.86	8.92	2.84
	46	8.02	2.76	8.05	2.80	8.06	2.82	8.07	2.84	8.55	2.84	8.65	2.84
2.0 + 2.0 + 5.0 + 5.0	22	8.93	1.19	8.12	1.25	7.84	1.26	7.30	1.30	9.14	1.52	10.36	1.66
	25	9.01	1.66	8.53	1.68	8.37	1.69	8.05	1.70	9.40	1.84	10.30	1.94
	29	9.15	2.15	8.95	2.15	8.89	2.15	8.76	2.15	9.60	2.21	10.15	2.25
	32	9.00	2.43	9.04	2.42	9.05	2.41	9.08	2.40	9.64	2.42	10.01	2.43
	35	8.89	2.63	9.05	2.62	9.10	2.61	9.20	2.60	9.57	2.59	9.82	2.58
	40	8.61	2.80	8.80	2.79	8.87	2.79	9.00	2.79	8.96	2.75	9.20	2.73
	43	8.34	2.78	8.48	2.80	8.53	2.80	8.63	2.82	8.95	2.79	8.92	2.77
	46	8.02	2.70	8.05	2.74	8.06	2.75	8.07	2.78	8.55	2.78	8.65	2.77
2.0 + 2.5 + 2.5 + 2.5	22	8.93	1.32	8.12	1.37	7.84	1.39	7.30	1.43	9.14	1.68	10.36	1.84
	25	9.01	1.83	8.53	1.85	8.37	1.86	8.05	1.88	9.40	2.04	10.30	2.14
	29	9.15	2.37	8.95	2.37	8.89	2.37	8.76	2.37	9.60	2.44	10.15	2.48
	32	9.00	2.68	9.04	2.67	9.05	2.66	9.08	2.65	9.64	2.67	10.01	2.69
	35	8.89	2.91	9.05	2.89	9.10	2.88	9.20	2.87	9.57	2.85	9.82	2.84
	40	8.61	3.09	8.80	3.08	8.87	3.08	9.00	3.08	8.96	3.04	9.20	3.01
	43	8.34	3.07	8.48	3.09	8.53	3.10	8.63	3.11	8.95	3.08	8.92	3.06
	46	8.02	2.98	8.05	3.02	8.06	3.04	8.07	3.07	8.55	3.06	8.65	3.06
2.0 + 2.5 + 2.5 + 3.5	22	8.93	1.28	8.12	1.34	7.84	1.36	7.30	1.40	9.14	1.63	10.36	1.79
	25	9.01	1.78	8.53	1.81	8.37	1.82	8.05	1.84	9.40	1.99	10.30	2.09
	29	9.15	2.31	8.95	2.31	8.89	2.31	8.76	2.31	9.60	2.38	10.15	2.42
	32	9.00	2.62	9.04	2.60	9.05	2.60	9.08	2.59	9.64	2.61	10.01	2.62
	35	8.89	2.84	9.05	2.82	9.10	2.81	9.20	2.80	9.57	2.78	9.82	2.77
	40	8.61	3.01	8.80	3.01	8.87	3.00	9.00	3.00	8.96	2.96	9.20	2.94
	43	8.34	3.00	8.48	3.01	8.53	3.02	8.63	3.03	8.95	3.01	8.92	2.99
	46	8.02	2.91	8.05	2.95	8.06	2.96	8.07	2.99	8.55	2.99	8.65	2.99



Combination (Capacity)	Outdoor Air Temp. °C DB	Indoor Air Temp. °C											
		27/16		27/17.5		27/18		27/19		27/22		27/24	
		Total Q	Input Power	Total Q	Input Power	Total Q	Input Power	Total Q	Input Power	Total Q	Input Power	Total Q	Input Power
2.0 + 2.5 + 2.5 + 4.2	22	8.93	1.28	8.12	1.34	7.84	1.36	7.30	1.40	9.14	1.63	10.36	1.79
	25	9.01	1.78	8.53	1.81	8.37	1.82	8.05	1.84	9.40	1.99	10.30	2.09
	29	9.15	2.31	8.95	2.31	8.89	2.31	8.76	2.31	9.60	2.38	10.15	2.42
	32	9.00	2.62	9.04	2.60	9.05	2.60	9.08	2.59	9.64	2.61	10.01	2.62
	35	8.89	2.84	9.05	2.82	9.10	2.81	9.20	2.80	9.57	2.78	9.82	2.77
	40	8.61	3.01	8.80	3.01	8.87	3.00	9.00	3.00	8.96	2.96	9.20	2.94
	43	8.34	3.00	8.48	3.01	8.53	3.02	8.63	3.03	8.95	3.01	8.92	2.99
	46	8.02	2.91	8.05	2.95	8.06	2.96	8.07	2.99	8.55	2.99	8.65	2.99
2.0 + 2.5 + 2.5 + 5.0	22	8.93	1.22	8.12	1.27	7.84	1.29	7.30	1.32	9.14	1.55	10.36	1.70
	25	9.01	1.69	8.53	1.71	8.37	1.72	8.05	1.74	9.40	1.88	10.30	1.97
	29	9.15	2.19	8.95	2.19	8.89	2.19	8.76	2.19	9.60	2.25	10.15	2.29
	32	9.00	2.48	9.04	2.46	9.05	2.46	9.08	2.45	9.64	2.47	10.01	2.48
	35	8.89	2.68	9.05	2.67	9.10	2.66	9.20	2.65	9.57	2.64	9.82	2.63
	40	8.61	2.85	8.80	2.84	8.87	2.84	9.00	2.84	8.96	2.81	9.20	2.78
	43	8.34	2.84	8.48	2.85	8.53	2.86	8.63	2.87	8.95	2.84	8.92	2.83
	46	8.02	2.75	8.05	2.79	8.06	2.80	8.07	2.83	8.55	2.83	8.65	2.83
2.0 + 2.5 + 2.5 + 6.0	22	8.93	1.22	8.12	1.27	7.84	1.29	7.30	1.32	9.14	1.55	10.36	1.70
	25	9.01	1.69	8.53	1.71	8.37	1.72	8.05	1.74	9.40	1.88	10.30	1.97
	29	9.15	2.19	8.95	2.19	8.89	2.19	8.76	2.19	9.60	2.25	10.15	2.29
	32	9.00	2.48	9.04	2.46	9.05	2.46	9.08	2.45	9.64	2.47	10.01	2.48
	35	8.89	2.68	9.05	2.67	9.10	2.66	9.20	2.65	9.57	2.64	9.82	2.63
	40	8.61	2.85	8.80	2.84	8.87	2.84	9.00	2.84	8.96	2.81	9.20	2.78
	43	8.34	2.84	8.48	2.85	8.53	2.86	8.63	2.87	8.95	2.84	8.92	2.83
	46	8.02	2.75	8.05	2.79	8.06	2.80	8.07	2.83	8.55	2.83	8.65	2.83
2.0 + 2.5 + 2.5 + 7.1	22	8.93	1.22	8.12	1.27	7.84	1.29	7.30	1.33	9.14	1.55	10.36	1.70
	25	9.01	1.69	8.53	1.72	8.37	1.73	8.05	1.74	9.40	1.89	10.30	1.98
	29	9.15	2.20	8.95	2.20	8.89	2.20	8.76	2.20	9.60	2.26	10.15	2.30
	32	9.00	2.49	9.04	2.47	9.05	2.47	9.08	2.46	9.64	2.48	10.01	2.49
	35	8.89	2.69	9.05	2.68	9.10	2.67	9.20	2.66	9.57	2.65	9.82	2.64
	40	8.61	2.86	8.80	2.86	8.87	2.85	9.00	2.85	8.96	2.82	9.20	2.79
	43	8.34	2.85	8.48	2.86	8.53	2.87	8.63	2.88	8.95	2.86	8.92	2.84
	46	8.02	2.76	8.05	2.80	8.06	2.82	8.07	2.84	8.55	2.84	8.65	2.84
2.0 + 2.5 + 3.5 + 3.5	22	8.93	1.28	8.12	1.34	7.84	1.36	7.30	1.40	9.14	1.63	10.36	1.79
	25	9.01	1.78	8.53	1.81	8.37	1.82	8.05	1.84	9.40	1.99	10.30	2.09
	29	9.15	2.31	8.95	2.31	8.89	2.31	8.76	2.31	9.60	2.38	10.15	2.42
	32	9.00	2.62	9.04	2.60	9.05	2.60	9.08	2.59	9.64	2.61	10.01	2.62
	35	8.89	2.84	9.05	2.82	9.10	2.81	9.20	2.80	9.57	2.78	9.82	2.77
	40	8.61	3.01	8.80	3.01	8.87	3.00	9.00	3.00	8.96	2.96	9.20	2.94
	43	8.34	3.00	8.48	3.01	8.53	3.02	8.63	3.03	8.95	3.01	8.92	2.99
	46	8.02	2.91	8.05	2.95	8.06	2.96	8.07	2.99	8.55	2.99	8.65	2.99

Combination (Capacity)	Outdoor Air Temp. °C DB	Indoor Air Temp. °C											
		27/16		27/17.5		27/18		27/19		27/22		27/24	
		Total Q	Input Power	Total Q	Input Power	Total Q	Input Power	Total Q	Input Power	Total Q	Input Power	Total Q	Input Power
2.0 + 2.5 + 3.5 + 4.2	22	8.93	1.28	8.12	1.34	7.84	1.36	7.30	1.40	9.14	1.63	10.36	1.79
	25	9.01	1.78	8.53	1.81	8.37	1.82	8.05	1.84	9.40	1.99	10.30	2.09
	29	9.15	2.31	8.95	2.31	8.89	2.31	8.76	2.31	9.60	2.38	10.15	2.42
	32	9.00	2.62	9.04	2.60	9.05	2.60	9.08	2.59	9.64	2.61	10.01	2.62
	35	8.89	2.84	9.05	2.82	9.10	2.81	9.20	2.80	9.57	2.78	9.82	2.77
	40	8.61	3.01	8.80	3.01	8.87	3.00	9.00	3.00	8.96	2.96	9.20	2.94
	43	8.34	3.00	8.48	3.01	8.53	3.02	8.63	3.03	8.95	3.01	8.92	2.99
	46	8.02	2.91	8.05	2.95	8.06	2.96	8.07	2.99	8.55	2.99	8.65	2.99
2.0 + 2.5 + 3.5 + 5.0	22	8.93	1.22	8.12	1.27	7.84	1.29	7.30	1.33	9.14	1.55	10.36	1.70
	25	9.01	1.69	8.53	1.72	8.37	1.73	8.05	1.74	9.40	1.89	10.30	1.98
	29	9.15	2.20	8.95	2.20	8.89	2.20	8.76	2.20	9.60	2.26	10.15	2.30
	32	9.00	2.49	9.04	2.47	9.05	2.47	9.08	2.46	9.64	2.48	10.01	2.49
	35	8.89	2.69	9.05	2.68	9.10	2.67	9.20	2.66	9.57	2.65	9.82	2.64
	40	8.61	2.86	8.80	2.86	8.87	2.85	9.00	2.85	8.96	2.82	9.20	2.79
	43	8.34	2.85	8.48	2.86	8.53	2.87	8.63	2.88	8.95	2.86	8.92	2.84
	46	8.02	2.76	8.05	2.80	8.06	2.82	8.07	2.84	8.55	2.84	8.65	2.84
2.0 + 2.5 + 3.5 + 6.0	22	8.93	1.22	8.12	1.27	7.84	1.29	7.30	1.33	9.14	1.55	10.36	1.70
	25	9.01	1.69	8.53	1.72	8.37	1.73	8.05	1.74	9.40	1.89	10.30	1.98
	29	9.15	2.20	8.95	2.20	8.89	2.20	8.76	2.20	9.60	2.26	10.15	2.30
	32	9.00	2.49	9.04	2.47	9.05	2.47	9.08	2.46	9.64	2.48	10.01	2.49
	35	8.89	2.69	9.05	2.68	9.10	2.67	9.20	2.66	9.57	2.65	9.82	2.64
	40	8.61	2.86	8.80	2.86	8.87	2.85	9.00	2.85	8.96	2.82	9.20	2.79
	43	8.34	2.85	8.48	2.86	8.53	2.87	8.63	2.88	8.95	2.86	8.92	2.84
	46	8.02	2.76	8.05	2.80	8.06	2.82	8.07	2.84	8.55	2.84	8.65	2.84
2.0 + 2.5 + 4.2 + 4.2	22	8.93	1.28	8.12	1.34	7.84	1.36	7.30	1.40	9.14	1.63	10.36	1.79
	25	9.01	1.78	8.53	1.81	8.37	1.82	8.05	1.84	9.40	1.99	10.30	2.09
	29	9.15	2.31	8.95	2.31	8.89	2.31	8.76	2.31	9.60	2.38	10.15	2.42
	32	9.00	2.62	9.04	2.60	9.05	2.60	9.08	2.59	9.64	2.61	10.01	2.62
	35	8.89	2.84	9.05	2.82	9.10	2.81	9.20	2.80	9.57	2.78	9.82	2.77
	40	8.61	3.01	8.80	3.01	8.87	3.00	9.00	3.00	8.96	2.96	9.20	2.94
	43	8.34	3.00	8.48	3.01	8.53	3.02	8.63	3.03	8.95	3.01	8.92	2.99
	46	8.02	2.91	8.05	2.95	8.06	2.96	8.07	2.99	8.55	2.99	8.65	2.99
2.0 + 2.5 + 4.2 + 5.0	22	8.93	1.22	8.12	1.27	7.84	1.29	7.30	1.33	9.14	1.55	10.36	1.70
	25	9.01	1.69	8.53	1.72	8.37	1.73	8.05	1.74	9.40	1.89	10.30	1.98
	29	9.15	2.20	8.95	2.20	8.89	2.20	8.76	2.20	9.60	2.26	10.15	2.30
	32	9.00	2.49	9.04	2.47	9.05	2.47	9.08	2.46	9.64	2.48	10.01	2.49
	35	8.89	2.69	9.05	2.68	9.10	2.67	9.20	2.66	9.57	2.65	9.82	2.64
	40	8.61	2.86	8.80	2.86	8.87	2.85	9.00	2.85	8.96	2.82	9.20	2.79
	43	8.34	2.85	8.48	2.86	8.53	2.87	8.63	2.88	8.95	2.86	8.92	2.84
	46	8.02	2.76	8.05	2.80	8.06	2.82	8.07	2.84	8.55	2.84	8.65	2.84

Combination (Capacity)	Outdoor Air Temp. °C DB	Indoor Air Temp. °C											
		27/16		27/17.5		27/18		27/19		27/22		27/24	
		Total Q	Input Power	Total Q	Input Power	Total Q	Input Power	Total Q	Input Power	Total Q	Input Power	Total Q	Input Power
2.0 + 2.5 + 4.2 + 6.0	22	8.93	1.22	8.12	1.27	7.84	1.29	7.30	1.33	9.14	1.55	10.36	1.70
	25	9.01	1.69	8.53	1.72	8.37	1.73	8.05	1.74	9.40	1.89	10.30	1.98
	29	9.15	2.20	8.95	2.20	8.89	2.20	8.76	2.20	9.60	2.26	10.15	2.30
	32	9.00	2.49	9.04	2.47	9.05	2.47	9.08	2.46	9.64	2.48	10.01	2.49
	35	8.89	2.69	9.05	2.68	9.10	2.67	9.20	2.66	9.57	2.65	9.82	2.64
	40	8.61	2.86	8.80	2.86	8.87	2.85	9.00	2.85	8.96	2.82	9.20	2.79
	43	8.34	2.85	8.48	2.86	8.53	2.87	8.63	2.88	8.95	2.86	8.92	2.84
	46	8.02	2.76	8.05	2.80	8.06	2.82	8.07	2.84	8.55	2.84	8.65	2.84
2.0 + 2.5 + 5.0 + 5.0	22	8.93	1.19	8.12	1.25	7.84	1.26	7.30	1.30	9.14	1.52	10.36	1.66
	25	9.01	1.66	8.53	1.68	8.37	1.69	8.05	1.70	9.40	1.84	10.30	1.94
	29	9.15	2.15	8.95	2.15	8.89	2.15	8.76	2.15	9.60	2.21	10.15	2.25
	32	9.00	2.43	9.04	2.42	9.05	2.41	9.08	2.40	9.64	2.42	10.01	2.43
	35	8.89	2.63	9.05	2.62	9.10	2.61	9.20	2.60	9.57	2.59	9.82	2.58
	40	8.61	2.80	8.80	2.79	8.87	2.79	9.00	2.79	8.96	2.75	9.20	2.73
	43	8.34	2.78	8.48	2.80	8.53	2.80	8.63	2.82	8.95	2.79	8.92	2.77
	46	8.02	2.70	8.05	2.74	8.06	2.75	8.07	2.78	8.55	2.78	8.65	2.77
2.0 + 3.5 + 3.5 + 3.5	22	8.93	1.25	8.12	1.30	7.84	1.32	7.30	1.36	9.14	1.59	10.36	1.74
	25	9.01	1.73	8.53	1.76	8.37	1.77	8.05	1.78	9.40	1.93	10.30	2.03
	29	9.15	2.25	8.95	2.25	8.89	2.25	8.76	2.25	9.60	2.31	10.15	2.35
	32	9.00	2.54	9.04	2.53	9.05	2.52	9.08	2.52	9.64	2.53	10.01	2.55
	35	8.89	2.75	9.05	2.74	9.10	2.73	9.20	2.72	9.57	2.70	9.82	2.69
	40	8.61	2.92	8.80	2.92	8.87	2.92	9.00	2.92	8.96	2.88	9.20	2.86
	43	8.34	2.91	8.48	2.93	8.53	2.93	8.63	2.95	8.95	2.92	8.92	2.90
	46	8.02	2.82	8.05	2.86	8.06	2.88	8.07	2.91	8.55	2.90	8.65	2.90
2.0 + 3.5 + 3.5 + 4.2	22	8.93	1.25	8.12	1.30	7.84	1.32	7.30	1.36	9.14	1.59	10.36	1.74
	25	9.01	1.73	8.53	1.76	8.37	1.77	8.05	1.78	9.40	1.93	10.30	2.03
	29	9.15	2.25	8.95	2.25	8.89	2.25	8.76	2.25	9.60	2.31	10.15	2.35
	32	9.00	2.54	9.04	2.53	9.05	2.52	9.08	2.52	9.64	2.53	10.01	2.55
	35	8.89	2.75	9.05	2.74	9.10	2.73	9.20	2.72	9.57	2.70	9.82	2.69
	40	8.61	2.92	8.80	2.92	8.87	2.92	9.00	2.92	8.96	2.88	9.20	2.86
	43	8.34	2.91	8.48	2.93	8.53	2.93	8.63	2.95	8.95	2.92	8.92	2.90
	46	8.02	2.82	8.05	2.86	8.06	2.88	8.07	2.91	8.55	2.90	8.65	2.90
2.0 + 3.5 + 3.5 + 5.0	22	8.93	1.22	8.12	1.27	7.84	1.29	7.30	1.33	9.14	1.55	10.36	1.70
	25	9.01	1.69	8.53	1.72	8.37	1.73	8.05	1.74	9.40	1.89	10.30	1.98
	29	9.15	2.20	8.95	2.20	8.89	2.20	8.76	2.20	9.60	2.26	10.15	2.30
	32	9.00	2.49	9.04	2.47	9.05	2.47	9.08	2.46	9.64	2.48	10.01	2.49
	35	8.89	2.69	9.05	2.68	9.10	2.67	9.20	2.66	9.57	2.65	9.82	2.64
	40	8.61	2.86	8.80	2.86	8.87	2.85	9.00	2.85	8.96	2.82	9.20	2.79
	43	8.34	2.85	8.48	2.86	8.53	2.87	8.63	2.88	8.95	2.86	8.92	2.84
	46	8.02	2.76	8.05	2.80	8.06	2.82	8.07	2.84	8.55	2.84	8.65	2.84

Combination (Capacity)	Outdoor Air Temp. °C DB	Indoor Air Temp. °C											
		27/16		27/17.5		27/18		27/19		27/22		27/24	
		Total Q	Input Power	Total Q	Input Power	Total Q	Input Power	Total Q	Input Power	Total Q	Input Power	Total Q	Input Power
2.0 + 3.5 + 4.2 + 4.2	22	8.93	1.25	8.12	1.30	7.84	1.32	7.30	1.36	9.14	1.59	10.36	1.74
	25	9.01	1.73	8.53	1.76	8.37	1.77	8.05	1.78	9.40	1.93	10.30	2.03
	29	9.15	2.25	8.95	2.25	8.89	2.25	8.76	2.25	9.60	2.31	10.15	2.35
	32	9.00	2.54	9.04	2.53	9.05	2.52	9.08	2.52	9.64	2.53	10.01	2.55
	35	8.89	2.75	9.05	2.74	9.10	2.73	9.20	2.72	9.57	2.70	9.82	2.69
	40	8.61	2.92	8.80	2.92	8.87	2.92	9.00	2.92	8.96	2.88	9.20	2.86
	43	8.34	2.91	8.48	2.93	8.53	2.93	8.63	2.95	8.95	2.92	8.92	2.90
	46	8.02	2.82	8.05	2.86	8.06	2.88	8.07	2.91	8.55	2.90	8.65	2.90
2.0 + 3.5 + 4.2 + 5.0	22	8.93	1.22	8.12	1.27	7.84	1.29	7.30	1.33	9.14	1.55	10.36	1.70
	25	9.01	1.69	8.53	1.72	8.37	1.73	8.05	1.74	9.40	1.89	10.30	1.98
	29	9.15	2.20	8.95	2.20	8.89	2.20	8.76	2.20	9.60	2.26	10.15	2.30
	32	9.00	2.49	9.04	2.47	9.05	2.47	9.08	2.46	9.64	2.48	10.01	2.49
	35	8.89	2.69	9.05	2.68	9.10	2.67	9.20	2.66	9.57	2.65	9.82	2.64
	40	8.61	2.86	8.80	2.86	8.87	2.85	9.00	2.85	8.96	2.82	9.20	2.79
	43	8.34	2.85	8.48	2.86	8.53	2.87	8.63	2.88	8.95	2.86	8.92	2.84
	46	8.02	2.76	8.05	2.80	8.06	2.82	8.07	2.84	8.55	2.84	8.65	2.84
2.0 + 4.2 + 4.2 + 4.2	22	8.93	1.25	8.12	1.30	7.84	1.32	7.30	1.36	9.14	1.59	10.36	1.74
	25	9.01	1.73	8.53	1.76	8.37	1.77	8.05	1.78	9.40	1.93	10.30	2.03
	29	9.15	2.25	8.95	2.25	8.89	2.25	8.76	2.25	9.60	2.31	10.15	2.35
	32	9.00	2.54	9.04	2.53	9.05	2.52	9.08	2.52	9.64	2.53	10.01	2.55
	35	8.89	2.75	9.05	2.74	9.10	2.73	9.20	2.72	9.57	2.70	9.82	2.69
	40	8.61	2.92	8.80	2.92	8.87	2.92	9.00	2.92	8.96	2.88	9.20	2.86
	43	8.34	2.91	8.48	2.93	8.53	2.93	8.63	2.95	8.95	2.92	8.92	2.90
	46	8.02	2.82	8.05	2.86	8.06	2.88	8.07	2.91	8.55	2.90	8.65	2.90
2.5 + 2.5 + 2.5 + 2.5	22	8.93	1.32	8.12	1.37	7.84	1.39	7.30	1.43	9.14	1.68	10.36	1.84
	25	9.01	1.83	8.53	1.85	8.37	1.86	8.05	1.88	9.40	2.04	10.30	2.14
	29	9.15	2.37	8.95	2.37	8.89	2.37	8.76	2.37	9.60	2.44	10.15	2.48
	32	9.00	2.68	9.04	2.67	9.05	2.66	9.08	2.65	9.64	2.67	10.01	2.69
	35	8.89	2.91	9.05	2.89	9.10	2.88	9.20	2.87	9.57	2.85	9.82	2.84
	40	8.61	3.09	8.80	3.08	8.87	3.08	9.00	3.08	8.96	3.04	9.20	3.01
	43	8.34	3.07	8.48	3.09	8.53	3.10	8.63	3.11	8.95	3.08	8.92	3.06
	46	8.02	2.98	8.05	3.02	8.06	3.04	8.07	3.07	8.55	3.06	8.65	3.06
2.5 + 2.5 + 2.5 + 3.5	22	8.93	1.28	8.12	1.34	7.84	1.36	7.30	1.40	9.14	1.63	10.36	1.79
	25	9.01	1.78	8.53	1.81	8.37	1.82	8.05	1.84	9.40	1.99	10.30	2.09
	29	9.15	2.31	8.95	2.31	8.89	2.31	8.76	2.31	9.60	2.38	10.15	2.42
	32	9.00	2.62	9.04	2.60	9.05	2.60	9.08	2.59	9.64	2.61	10.01	2.62
	35	8.89	2.84	9.05	2.82	9.10	2.81	9.20	2.80	9.57	2.78	9.82	2.77
	40	8.61	3.01	8.80	3.01	8.87	3.00	9.00	3.00	8.96	2.96	9.20	2.94
	43	8.34	3.00	8.48	3.01	8.53	3.02	8.63	3.03	8.95	3.01	8.92	2.99
	46	8.02	2.91	8.05	2.95	8.06	2.96	8.07	2.99	8.55	2.99	8.65	2.99

Combination (Capacity)	Outdoor Air Temp. °C DB	Indoor Air Temp. °C											
		27/16		27/17.5		27/18		27/19		27/22		27/24	
		Total Q	Input Power	Total Q	Input Power	Total Q	Input Power	Total Q	Input Power	Total Q	Input Power	Total Q	Input Power
2.5 + 2.5 + 2.5 + 4.2	22	8.93	1.28	8.12	1.34	7.84	1.36	7.30	1.40	9.14	1.63	10.36	1.79
	25	9.01	1.78	8.53	1.81	8.37	1.82	8.05	1.84	9.40	1.99	10.30	2.09
	29	9.15	2.31	8.95	2.31	8.89	2.31	8.76	2.31	9.60	2.38	10.15	2.42
	32	9.00	2.62	9.04	2.60	9.05	2.60	9.08	2.59	9.64	2.61	10.01	2.62
	35	8.89	2.84	9.05	2.82	9.10	2.81	9.20	2.80	9.57	2.78	9.82	2.77
	40	8.61	3.01	8.80	3.01	8.87	3.00	9.00	3.00	8.96	2.96	9.20	2.94
	43	8.34	3.00	8.48	3.01	8.53	3.02	8.63	3.03	8.95	3.01	8.92	2.99
	46	8.02	2.91	8.05	2.95	8.06	2.96	8.07	2.99	8.55	2.99	8.65	2.99
2.5 + 2.5 + 2.5 + 5.0	22	8.93	1.22	8.12	1.27	7.84	1.29	7.30	1.32	9.14	1.55	10.36	1.70
	25	9.01	1.69	8.53	1.71	8.37	1.72	8.05	1.74	9.40	1.88	10.30	1.97
	29	9.15	2.19	8.95	2.19	8.89	2.19	8.76	2.19	9.60	2.25	10.15	2.29
	32	9.00	2.48	9.04	2.46	9.05	2.46	9.08	2.45	9.64	2.47	10.01	2.48
	35	8.89	2.68	9.05	2.67	9.10	2.66	9.20	2.65	9.57	2.64	9.82	2.63
	40	8.61	2.85	8.80	2.84	8.87	2.84	9.00	2.84	8.96	2.81	9.20	2.78
	43	8.34	2.84	8.48	2.85	8.53	2.86	8.63	2.87	8.95	2.84	8.92	2.83
	46	8.02	2.75	8.05	2.79	8.06	2.80	8.07	2.83	8.55	2.83	8.65	2.83
2.5 + 2.5 + 2.5 + 6.0	22	8.93	1.22	8.12	1.27	7.84	1.29	7.30	1.32	9.14	1.55	10.36	1.70
	25	9.01	1.69	8.53	1.71	8.37	1.72	8.05	1.74	9.40	1.88	10.30	1.97
	29	9.15	2.19	8.95	2.19	8.89	2.19	8.76	2.19	9.60	2.25	10.15	2.29
	32	9.00	2.48	9.04	2.46	9.05	2.46	9.08	2.45	9.64	2.47	10.01	2.48
	35	8.89	2.68	9.05	2.67	9.10	2.66	9.20	2.65	9.57	2.64	9.82	2.63
	40	8.61	2.85	8.80	2.84	8.87	2.84	9.00	2.84	8.96	2.81	9.20	2.78
	43	8.34	2.84	8.48	2.85	8.53	2.86	8.63	2.87	8.95	2.84	8.92	2.83
	46	8.02	2.75	8.05	2.79	8.06	2.80	8.07	2.83	8.55	2.83	8.65	2.83
2.5 + 2.5 + 2.5 + 7.1	22	8.93	1.22	8.12	1.27	7.84	1.29	7.30	1.33	9.14	1.55	10.36	1.70
	25	9.01	1.69	8.53	1.72	8.37	1.73	8.05	1.74	9.40	1.89	10.30	1.98
	29	9.15	2.20	8.95	2.20	8.89	2.20	8.76	2.20	9.60	2.26	10.15	2.30
	32	9.00	2.49	9.04	2.47	9.05	2.47	9.08	2.46	9.64	2.48	10.01	2.49
	35	8.89	2.69	9.05	2.68	9.10	2.67	9.20	2.66	9.57	2.65	9.82	2.64
	40	8.61	2.86	8.80	2.86	8.87	2.85	9.00	2.85	8.96	2.82	9.20	2.79
	43	8.34	2.85	8.48	2.86	8.53	2.87	8.63	2.88	8.95	2.86	8.92	2.84
	46	8.02	2.76	8.05	2.80	8.06	2.82	8.07	2.84	8.55	2.84	8.65	2.84
2.5 + 2.5 + 3.5 + 3.5	22	8.93	1.28	8.12	1.34	7.84	1.36	7.30	1.40	9.14	1.63	10.36	1.79
	25	9.01	1.78	8.53	1.81	8.37	1.82	8.05	1.84	9.40	1.99	10.30	2.09
	29	9.15	2.31	8.95	2.31	8.89	2.31	8.76	2.31	9.60	2.38	10.15	2.42
	32	9.00	2.62	9.04	2.60	9.05	2.60	9.08	2.59	9.64	2.61	10.01	2.62
	35	8.89	2.84	9.05	2.82	9.10	2.81	9.20	2.80	9.57	2.78	9.82	2.77
	40	8.61	3.01	8.80	3.01	8.87	3.00	9.00	3.00	8.96	2.96	9.20	2.94
	43	8.34	3.00	8.48	3.01	8.53	3.02	8.63	3.03	8.95	3.01	8.92	2.99
	46	8.02	2.91	8.05	2.95	8.06	2.96	8.07	2.99	8.55	2.99	8.65	2.99

Combination (Capacity)	Outdoor Air Temp. °C DB	Indoor Air Temp. °C											
		27/16		27/17.5		27/18		27/19		27/22		27/24	
		Total Q	Input Power	Total Q	Input Power	Total Q	Input Power	Total Q	Input Power	Total Q	Input Power	Total Q	Input Power
2.5 + 2.5 + 3.5 + 4.2	22	8.93	1.28	8.12	1.34	7.84	1.36	7.30	1.40	9.14	1.63	10.36	1.79
	25	9.01	1.78	8.53	1.81	8.37	1.82	8.05	1.84	9.40	1.99	10.30	2.09
	29	9.15	2.31	8.95	2.31	8.89	2.31	8.76	2.31	9.60	2.38	10.15	2.42
	32	9.00	2.62	9.04	2.60	9.05	2.60	9.08	2.59	9.64	2.61	10.01	2.62
	35	8.89	2.84	9.05	2.82	9.10	2.81	9.20	2.80	9.57	2.78	9.82	2.77
	40	8.61	3.01	8.80	3.01	8.87	3.00	9.00	3.00	8.96	2.96	9.20	2.94
	43	8.34	3.00	8.48	3.01	8.53	3.02	8.63	3.03	8.95	3.01	8.92	2.99
	46	8.02	2.91	8.05	2.95	8.06	2.96	8.07	2.99	8.55	2.99	8.65	2.99
2.5 + 2.5 + 3.5 + 5.0	22	8.93	1.22	8.12	1.27	7.84	1.29	7.30	1.33	9.14	1.55	10.36	1.70
	25	9.01	1.69	8.53	1.72	8.37	1.73	8.05	1.74	9.40	1.89	10.30	1.98
	29	9.15	2.20	8.95	2.20	8.89	2.20	8.76	2.20	9.60	2.26	10.15	2.30
	32	9.00	2.49	9.04	2.47	9.05	2.47	9.08	2.46	9.64	2.48	10.01	2.49
	35	8.89	2.69	9.05	2.68	9.10	2.67	9.20	2.66	9.57	2.65	9.82	2.64
	40	8.61	2.86	8.80	2.86	8.87	2.85	9.00	2.85	8.96	2.82	9.20	2.79
	43	8.34	2.85	8.48	2.86	8.53	2.87	8.63	2.88	8.95	2.86	8.92	2.84
	46	8.02	2.76	8.05	2.80	8.06	2.82	8.07	2.84	8.55	2.84	8.65	2.84
2.5 + 2.5 + 3.5 + 6.0	22	8.93	1.22	8.12	1.27	7.84	1.29	7.30	1.33	9.14	1.55	10.36	1.70
	25	9.01	1.69	8.53	1.72	8.37	1.73	8.05	1.74	9.40	1.89	10.30	1.98
	29	9.15	2.20	8.95	2.20	8.89	2.20	8.76	2.20	9.60	2.26	10.15	2.30
	32	9.00	2.49	9.04	2.47	9.05	2.47	9.08	2.46	9.64	2.48	10.01	2.49
	35	8.89	2.69	9.05	2.68	9.10	2.67	9.20	2.66	9.57	2.65	9.82	2.64
	40	8.61	2.86	8.80	2.86	8.87	2.85	9.00	2.85	8.96	2.82	9.20	2.79
	43	8.34	2.85	8.48	2.86	8.53	2.87	8.63	2.88	8.95	2.86	8.92	2.84
	46	8.02	2.76	8.05	2.80	8.06	2.82	8.07	2.84	8.55	2.84	8.65	2.84
2.5 + 2.5 + 4.2 + 4.2	22	8.93	1.28	8.12	1.34	7.84	1.36	7.30	1.40	9.14	1.63	10.36	1.79
	25	9.01	1.78	8.53	1.81	8.37	1.82	8.05	1.84	9.40	1.99	10.30	2.09
	29	9.15	2.31	8.95	2.31	8.89	2.31	8.76	2.31	9.60	2.38	10.15	2.42
	32	9.00	2.62	9.04	2.60	9.05	2.60	9.08	2.59	9.64	2.61	10.01	2.62
	35	8.89	2.84	9.05	2.82	9.10	2.81	9.20	2.80	9.57	2.78	9.82	2.77
	40	8.61	3.01	8.80	3.01	8.87	3.00	9.00	3.00	8.96	2.96	9.20	2.94
	43	8.34	3.00	8.48	3.01	8.53	3.02	8.63	3.03	8.95	3.01	8.92	2.99
	46	8.02	2.91	8.05	2.95	8.06	2.96	8.07	2.99	8.55	2.99	8.65	2.99
2.5 + 2.5 + 4.2 + 5.0	22	8.93	1.22	8.12	1.27	7.84	1.29	7.30	1.33	9.14	1.55	10.36	1.70
	25	9.01	1.69	8.53	1.72	8.37	1.73	8.05	1.74	9.40	1.89	10.30	1.98
	29	9.15	2.20	8.95	2.20	8.89	2.20	8.76	2.20	9.60	2.26	10.15	2.30
	32	9.00	2.49	9.04	2.47	9.05	2.47	9.08	2.46	9.64	2.48	10.01	2.49
	35	8.89	2.69	9.05	2.68	9.10	2.67	9.20	2.66	9.57	2.65	9.82	2.64
	40	8.61	2.86	8.80	2.86	8.87	2.85	9.00	2.85	8.96	2.82	9.20	2.79
	43	8.34	2.85	8.48	2.86	8.53	2.87	8.63	2.88	8.95	2.86	8.92	2.84
	46	8.02	2.76	8.05	2.80	8.06	2.82	8.07	2.84	8.55	2.84	8.65	2.84

Combination (Capacity)	Outdoor Air Temp. °C DB	Indoor Air Temp. °C											
		27/16		27/17.5		27/18		27/19		27/22		27/24	
		Total Q	Input Power	Total Q	Input Power	Total Q	Input Power	Total Q	Input Power	Total Q	Input Power	Total Q	Input Power
2.5 + 3.5 + 3.5 + 3.5	22	8.93	1.25	8.12	1.30	7.84	1.32	7.30	1.36	9.14	1.59	10.36	1.74
	25	9.01	1.73	8.53	1.76	8.37	1.77	8.05	1.78	9.40	1.93	10.30	2.03
	29	9.15	2.25	8.95	2.25	8.89	2.25	8.76	2.25	9.60	2.31	10.15	2.35
	32	9.00	2.54	9.04	2.53	9.05	2.52	9.08	2.52	9.64	2.53	10.01	2.55
	35	8.89	2.75	9.05	2.74	9.10	2.73	9.20	2.72	9.57	2.70	9.82	2.69
	40	8.61	2.92	8.80	2.92	8.87	2.92	9.00	2.92	8.96	2.88	9.20	2.86
	43	8.34	2.91	8.48	2.93	8.53	2.93	8.63	2.95	8.95	2.92	8.92	2.90
	46	8.02	2.82	8.05	2.86	8.06	2.88	8.07	2.91	8.55	2.90	8.65	2.90
2.5 + 3.5 + 3.5 + 4.2	22	8.93	1.25	8.12	1.30	7.84	1.32	7.30	1.36	9.14	1.59	10.36	1.74
	25	9.01	1.73	8.53	1.76	8.37	1.77	8.05	1.78	9.40	1.93	10.30	2.03
	29	9.15	2.25	8.95	2.25	8.89	2.25	8.76	2.25	9.60	2.31	10.15	2.35
	32	9.00	2.54	9.04	2.53	9.05	2.52	9.08	2.52	9.64	2.53	10.01	2.55
	35	8.89	2.75	9.05	2.74	9.10	2.73	9.20	2.72	9.57	2.70	9.82	2.69
	40	8.61	2.92	8.80	2.92	8.87	2.92	9.00	2.92	8.96	2.88	9.20	2.86
	43	8.34	2.91	8.48	2.93	8.53	2.93	8.63	2.95	8.95	2.92	8.92	2.90
	46	8.02	2.82	8.05	2.86	8.06	2.88	8.07	2.91	8.55	2.90	8.65	2.90
2.5 + 3.5 + 3.5 + 5.0	22	8.93	1.22	8.12	1.27	7.84	1.29	7.30	1.33	9.14	1.55	10.36	1.70
	25	9.01	1.69	8.53	1.72	8.37	1.73	8.05	1.74	9.40	1.89	10.30	1.98
	29	9.15	2.20	8.95	2.20	8.89	2.20	8.76	2.20	9.60	2.26	10.15	2.30
	32	9.00	2.49	9.04	2.47	9.05	2.47	9.08	2.46	9.64	2.48	10.01	2.49
	35	8.89	2.69	9.05	2.68	9.10	2.67	9.20	2.66	9.57	2.65	9.82	2.64
	40	8.61	2.86	8.80	2.86	8.87	2.85	9.00	2.85	8.96	2.82	9.20	2.79
	43	8.34	2.85	8.48	2.86	8.53	2.87	8.63	2.88	8.95	2.86	8.92	2.84
	46	8.02	2.76	8.05	2.80	8.06	2.82	8.07	2.84	8.55	2.84	8.65	2.84
2.5 + 3.5 + 4.2 + 4.2	22	8.93	1.25	8.12	1.30	7.84	1.32	7.30	1.36	9.14	1.59	10.36	1.74
	25	9.01	1.73	8.53	1.76	8.37	1.77	8.05	1.78	9.40	1.93	10.30	2.03
	29	9.15	2.25	8.95	2.25	8.89	2.25	8.76	2.25	9.60	2.31	10.15	2.35
	32	9.00	2.54	9.04	2.53	9.05	2.52	9.08	2.52	9.64	2.53	10.01	2.55
	35	8.89	2.75	9.05	2.74	9.10	2.73	9.20	2.72	9.57	2.70	9.82	2.69
	40	8.61	2.92	8.80	2.92	8.87	2.92	9.00	2.92	8.96	2.88	9.20	2.86
	43	8.34	2.91	8.48	2.93	8.53	2.93	8.63	2.95	8.95	2.92	8.92	2.90
	46	8.02	2.82	8.05	2.86	8.06	2.88	8.07	2.91	8.55	2.90	8.65	2.90
3.5 + 3.5 + 3.5 + 3.5	22	8.93	1.25	8.12	1.30	7.84	1.32	7.30	1.36	9.14	1.59	10.36	1.74
	25	9.01	1.73	8.53	1.76	8.37	1.77	8.05	1.78	9.40	1.93	10.30	2.03
	29	9.15	2.25	8.95	2.25	8.89	2.25	8.76	2.25	9.60	2.31	10.15	2.35
	32	9.00	2.54	9.04	2.53	9.05	2.52	9.08	2.52	9.64	2.53	10.01	2.55
	35	8.89	2.75	9.05	2.74	9.10	2.73	9.20	2.72	9.57	2.70	9.82	2.69
	40	8.61	2.92	8.80	2.92	8.87	2.92	9.00	2.92	8.96	2.88	9.20	2.86
	43	8.34	2.91	8.48	2.93	8.53	2.93	8.63	2.95	8.95	2.92	8.92	2.90
	46	8.02	2.82	8.05	2.86	8.06	2.88	8.07	2.91	8.55	2.90	8.65	2.90

Combination (Capacity)	Outdoor Air Temp. °C DB	Indoor Air Temp. °C											
		27/16		27/17.5		27/18		27/19		27/22		27/24	
		Total Q	Input Power	Total Q	Input Power	Total Q	Input Power	Total Q	Input Power	Total Q	Input Power	Total Q	Input Power
3.5 + 3.5 + 3.5 + 4.2	22	8.93	1.25	8.12	1.30	7.84	1.32	7.30	1.36	9.14	1.59	10.36	1.74
	25	9.01	1.73	8.53	1.76	8.37	1.77	8.05	1.78	9.40	1.93	10.30	2.03
	29	9.15	2.25	8.95	2.25	8.89	2.25	8.76	2.25	9.60	2.31	10.15	2.35
	32	9.00	2.54	9.04	2.53	9.05	2.52	9.08	2.52	9.64	2.53	10.01	2.55
	35	8.89	2.75	9.05	2.74	9.10	2.73	9.20	2.72	9.57	2.70	9.82	2.69
	40	8.61	2.92	8.80	2.92	8.87	2.92	9.00	2.92	8.96	2.88	9.20	2.86
	43	8.34	2.91	8.48	2.93	8.53	2.93	8.63	2.95	8.95	2.92	8.92	2.90
	46	8.02	2.82	8.05	2.86	8.06	2.88	8.07	2.91	8.55	2.90	8.65	2.90

Total Q: Total Cooling Capacity (kW)

Input Power (kW)



## 18.1.2 CU-5Z90TBE

Combination (Capacity)	Outdoor Air Temp. °C DB	Indoor Air Temp. °C											
		27/16		27/17.5		27/18		27/19		27/22		27/24	
		Total Q	Input Power	Total Q	Input Power	Total Q	Input Power	Total Q	Input Power	Total Q	Input Power	Total Q	Input Power
1.6	22	2.15	0.35	2.17	0.33	2.18	0.33	2.20	0.32	2.73	0.35	3.09	0.38
	25	2.21	0.43	2.24	0.41	2.25	0.41	2.27	0.40	2.76	0.43	3.09	0.45
	29	2.23	0.56	2.27	0.53	2.29	0.52	2.31	0.49	2.75	0.53	3.04	0.55
	32	2.22	0.63	2.27	0.60	2.29	0.59	2.32	0.57	2.71	0.60	2.97	0.62
	35	2.18	0.69	2.24	0.66	2.26	0.66	2.30	0.64	2.65	0.66	2.88	0.67
	40	2.08	0.79	2.14	0.77	2.16	0.76	2.20	0.75	2.48	0.76	2.66	0.76
	43	1.98	0.83	2.05	0.83	2.07	0.83	2.11	0.83	2.34	0.82	2.49	0.81
	46	1.87	0.88	1.93	0.88	1.95	0.88	1.99	0.88	2.17	0.86	2.29	0.85
2.0	22	2.71	0.44	2.74	0.42	2.75	0.41	2.77	0.40	3.45	0.45	3.90	0.48
	25	2.79	0.54	2.82	0.52	2.84	0.52	2.86	0.50	3.48	0.55	3.90	0.57
	29	2.81	0.71	2.86	0.67	2.88	0.65	2.92	0.63	3.47	0.67	3.83	0.70
	32	2.80	0.80	2.86	0.76	2.88	0.75	2.93	0.72	3.42	0.75	3.75	0.78
	35	2.75	0.87	2.82	0.84	2.85	0.83	2.90	0.81	3.34	0.83	3.63	0.85
	40	2.63	0.99	2.70	0.97	2.73	0.97	2.78	0.95	3.12	0.96	3.35	0.96
	43	2.50	1.05	2.58	1.05	2.61	1.05	2.66	1.05	2.95	1.03	3.14	1.03
	46	2.35	1.12	2.43	1.12	2.45	1.12	2.50	1.12	2.73	1.09	2.88	1.08
2.5	22	2.71	0.44	2.74	0.42	2.75	0.41	2.77	0.40	3.45	0.45	3.90	0.48
	25	2.79	0.54	2.82	0.52	2.84	0.52	2.86	0.50	3.48	0.55	3.90	0.57
	29	2.81	0.71	2.86	0.67	2.88	0.65	2.92	0.63	3.47	0.67	3.83	0.70
	32	2.80	0.80	2.86	0.76	2.88	0.75	2.93	0.72	3.42	0.75	3.75	0.78
	35	2.75	0.87	2.82	0.84	2.85	0.83	2.90	0.81	3.34	0.83	3.63	0.85
	40	2.63	0.99	2.70	0.97	2.73	0.97	2.78	0.95	3.12	0.96	3.35	0.96
	43	2.50	1.05	2.58	1.05	2.61	1.05	2.66	1.05	2.95	1.03	3.14	1.03
	46	2.35	1.12	2.43	1.12	2.45	1.12	2.50	1.12	2.73	1.09	2.88	1.08
3.5	22	3.83	0.74	3.87	0.71	3.89	0.69	3.91	0.67	4.87	0.75	5.51	0.81
	25	3.94	0.91	3.99	0.88	4.01	0.87	4.05	0.84	4.93	0.92	5.51	0.96
	29	3.97	1.19	4.05	1.12	4.07	1.10	4.13	1.05	4.90	1.12	5.42	1.17
	32	3.95	1.34	4.05	1.27	4.08	1.25	4.14	1.21	4.83	1.27	5.30	1.31
	35	3.89	1.46	3.99	1.41	4.03	1.39	4.10	1.36	4.72	1.40	5.13	1.43
	40	3.71	1.67	3.82	1.64	3.86	1.62	3.93	1.60	4.41	1.61	4.74	1.62
	43	3.53	1.76	3.65	1.76	3.69	1.76	3.77	1.76	4.17	1.74	4.43	1.72
	46	3.33	1.88	3.43	1.88	3.47	1.88	3.54	1.88	3.86	1.84	4.07	1.81

Combination (Capacity)	Outdoor Air Temp. °C DB	Indoor Air Temp. °C											
		27/16		27/17.5		27/18		27/19		27/22		27/24	
		Total Q	Input Power	Total Q	Input Power	Total Q	Input Power	Total Q	Input Power	Total Q	Input Power	Total Q	Input Power
4.2	22	4.21	1.08	4.25	1.03	4.27	1.02	4.30	0.98	5.35	1.10	6.05	1.18
	25	4.32	1.34	4.38	1.28	4.40	1.27	4.44	1.23	5.41	1.34	6.05	1.41
	29	4.35	1.74	4.44	1.64	4.47	1.60	4.53	1.54	5.38	1.64	5.95	1.71
	32	4.34	1.96	4.44	1.86	4.48	1.83	4.54	1.76	5.31	1.85	5.81	1.91
	35	4.27	2.14	4.38	2.07	4.42	2.04	4.50	1.99	5.18	2.05	5.63	2.09
	40	4.08	2.44	4.19	2.39	4.23	2.38	4.31	2.34	4.84	2.36	5.20	2.37
	43	3.87	2.57	4.00	2.57	4.05	2.57	4.13	2.57	4.57	2.54	4.87	2.52
	46	3.65	2.75	3.77	2.75	3.81	2.75	3.89	2.75	4.24	2.69	4.47	2.64
5.0	22	5.33	1.16	5.39	1.11	5.40	1.09	5.44	1.05	6.77	1.18	7.66	1.27
	25	5.48	1.43	5.55	1.38	5.58	1.36	5.63	1.32	6.85	1.43	7.66	1.51
	29	5.51	1.86	5.63	1.75	5.66	1.72	5.74	1.64	6.81	1.76	7.53	1.83
	32	5.50	2.10	5.63	2.00	5.67	1.96	5.76	1.89	6.72	1.98	7.37	2.05
	35	5.40	2.29	5.55	2.21	5.60	2.18	5.70	2.13	6.56	2.19	7.13	2.24
	40	5.16	2.62	5.31	2.56	5.36	2.54	5.46	2.51	6.14	2.52	6.59	2.53
	43	4.90	2.75	5.07	2.75	5.13	2.75	5.24	2.75	5.79	2.72	6.16	2.70
	46	4.63	2.94	4.77	2.94	4.82	2.94	4.92	2.94	5.37	2.87	5.66	2.83
6.0	22	5.80	1.27	5.86	1.21	5.88	1.19	5.92	1.15	7.37	1.29	8.33	1.39
	25	5.96	1.56	6.04	1.50	6.07	1.48	6.12	1.45	7.45	1.57	8.33	1.65
	29	6.00	2.04	6.12	1.92	6.16	1.88	6.24	1.80	7.41	1.92	8.19	2.01
	32	5.98	2.30	6.12	2.18	6.17	2.14	6.26	2.06	7.31	2.17	8.01	2.24
	35	5.88	2.51	6.04	2.42	6.09	2.39	6.20	2.33	7.13	2.40	7.75	2.45
	40	5.62	2.86	5.78	2.80	5.83	2.78	5.94	2.74	6.68	2.76	7.17	2.77
	43	5.33	3.01	5.52	3.01	5.58	3.01	5.70	3.01	6.30	2.97	6.70	2.95
	46	5.03	3.21	5.19	3.21	5.25	3.21	5.35	3.21	5.84	3.14	6.16	3.10
7.1	22	6.73	1.51	6.80	1.44	6.83	1.41	6.87	1.37	8.56	1.54	9.68	1.65
	25	6.92	1.86	7.01	1.79	7.04	1.76	7.11	1.72	8.65	1.87	9.68	1.96
	29	6.97	2.42	7.11	2.28	7.15	2.23	7.25	2.14	8.61	2.29	9.51	2.38
	32	6.94	2.73	7.11	2.59	7.16	2.55	7.27	2.45	8.49	2.58	9.30	2.66
	35	6.83	2.98	7.01	2.88	7.08	2.84	7.20	2.77	8.28	2.85	9.00	2.91
	40	6.52	3.40	6.71	3.33	6.77	3.31	6.90	3.26	7.75	3.28	8.32	3.30
	43	6.19	3.58	6.41	3.58	6.48	3.58	6.62	3.58	7.32	3.53	7.78	3.51
	46	5.84	3.82	6.03	3.82	6.09	3.82	6.22	3.82	6.78	3.74	7.15	3.68
1.6 + 1.6	22	4.04	0.55	4.13	0.55	4.16	0.55	4.23	0.55	5.84	0.89	6.91	1.11
	25	4.61	0.93	4.73	0.92	4.77	0.92	4.85	0.91	6.05	1.12	6.86	1.27
	29	5.16	1.35	5.29	1.33	5.34	1.32	5.43	1.31	6.20	1.40	6.72	1.46
	32	5.40	1.59	5.55	1.57	5.60	1.56	5.69	1.55	6.94	1.57	7.78	1.59
	35	5.49	1.77	5.65	1.75	5.70	1.75	5.80	1.74	6.16	1.72	6.39	1.70
	40	5.34	1.85	5.49	1.86	5.54	1.86	5.65	1.87	5.57	1.81	5.74	1.80
	43	5.05	1.85	5.20	1.89	5.25	1.91	5.35	1.93	5.45	1.89	5.51	1.88
	46	4.60	1.81	4.75	1.88	4.80	1.90	4.91	1.93	5.20	1.94	5.40	1.95

Combination (Capacity)	Outdoor Air Temp. °C DB	Indoor Air Temp. °C											
		27/16		27/17.5		27/18		27/19		27/22		27/24	
		Total Q	Input Power	Total Q	Input Power	Total Q	Input Power	Total Q	Input Power	Total Q	Input Power	Total Q	Input Power
1.6 + 2.0	22	4.04	0.55	4.13	0.55	4.16	0.55	4.23	0.55	5.84	0.89	6.91	1.11
	25	4.61	0.93	4.73	0.92	4.77	0.92	4.85	0.91	6.05	1.12	6.86	1.27
	29	5.16	1.35	5.29	1.33	5.34	1.32	5.43	1.31	6.20	1.40	6.72	1.46
	32	5.40	1.59	5.55	1.57	5.60	1.56	5.69	1.55	6.94	1.57	7.78	1.59
	35	5.49	1.77	5.65	1.75	5.70	1.75	5.80	1.74	6.16	1.72	6.39	1.70
	40	5.34	1.85	5.49	1.86	5.54	1.86	5.65	1.87	5.57	1.81	5.74	1.80
	43	5.05	1.85	5.20	1.89	5.25	1.91	5.35	1.93	5.45	1.89	5.51	1.88
	46	4.60	1.81	4.75	1.88	4.80	1.90	4.91	1.93	5.20	1.94	5.40	1.95
1.6 + 2.5	22	4.04	0.55	4.13	0.55	4.16	0.55	4.23	0.55	5.84	0.89	6.91	1.11
	25	4.61	0.93	4.73	0.92	4.77	0.92	4.85	0.91	6.05	1.12	6.86	1.27
	29	5.16	1.35	5.29	1.33	5.34	1.32	5.43	1.31	6.20	1.40	6.72	1.46
	32	5.40	1.59	5.55	1.57	5.60	1.56	5.69	1.55	6.94	1.57	7.78	1.59
	35	5.49	1.77	5.65	1.75	5.70	1.75	5.80	1.74	6.16	1.72	6.39	1.70
	40	5.34	1.85	5.49	1.86	5.54	1.86	5.65	1.87	5.57	1.81	5.74	1.80
	43	5.05	1.85	5.20	1.89	5.25	1.91	5.35	1.93	5.45	1.89	5.51	1.88
	46	4.60	1.81	4.75	1.88	4.80	1.90	4.91	1.93	5.20	1.94	5.40	1.95
1.6 + 3.5	22	4.04	0.53	4.13	0.53	4.16	0.53	4.23	0.53	5.84	0.86	6.91	1.07
	25	4.61	0.90	4.73	0.89	4.77	0.88	4.85	0.88	6.05	1.08	6.86	1.22
	29	5.16	1.30	5.29	1.28	5.34	1.27	5.43	1.26	6.20	1.35	6.72	1.41
	32	5.40	1.53	5.55	1.51	5.60	1.51	5.69	1.49	6.94	1.52	7.78	1.53
	35	5.49	1.71	5.65	1.69	5.70	1.69	5.80	1.68	6.16	1.66	6.39	1.64
	40	5.34	1.79	5.49	1.80	5.54	1.80	5.65	1.80	5.57	1.75	5.74	1.74
	43	5.05	1.79	5.20	1.83	5.25	1.84	5.35	1.87	5.45	1.83	5.51	1.82
	46	4.60	1.75	4.75	1.81	4.80	1.84	4.91	1.86	5.20	1.87	5.40	1.88
1.6 + 4.2	22	4.67	0.68	4.77	0.68	4.81	0.68	4.88	0.68	6.74	1.09	7.99	1.36
	25	5.32	1.14	5.46	1.13	5.51	1.12	5.60	1.11	6.99	1.37	7.92	1.55
	29	5.96	1.65	6.11	1.62	6.17	1.62	6.27	1.60	7.17	1.71	7.76	1.79
	32	6.24	1.94	6.41	1.92	6.46	1.91	6.58	1.89	8.02	1.92	8.98	1.94
	35	6.35	2.16	6.52	2.15	6.58	2.14	6.70	2.13	7.11	2.10	7.39	2.08
	40	6.17	2.27	6.35	2.28	6.40	2.28	6.52	2.28	6.43	2.22	6.63	2.20
	43	5.83	2.27	6.01	2.32	6.07	2.33	6.18	2.37	6.30	2.32	6.37	2.31
	46	5.31	2.22	5.49	2.30	5.55	2.33	5.67	2.36	6.01	2.37	6.24	2.39
1.6 + 5.0	22	5.02	0.68	5.13	0.68	5.17	0.68	5.25	0.68	7.25	1.09	8.58	1.36
	25	5.72	1.14	5.87	1.13	5.92	1.12	6.02	1.11	7.52	1.37	8.52	1.55
	29	6.41	1.65	6.57	1.62	6.63	1.62	6.74	1.60	7.70	1.71	8.34	1.79
	32	6.70	1.94	6.89	1.92	6.95	1.91	7.07	1.89	8.62	1.92	9.66	1.94
	35	6.82	2.16	7.01	2.15	7.07	2.14	7.20	2.13	7.64	2.10	7.94	2.08
	40	6.63	2.27	6.82	2.28	6.88	2.28	7.01	2.28	6.91	2.22	7.13	2.20
	43	6.26	2.27	6.46	2.32	6.52	2.33	6.65	2.37	6.77	2.32	6.84	2.31
	46	5.71	2.22	5.90	2.30	5.96	2.33	6.09	2.36	6.46	2.37	6.70	2.39

Combination (Capacity)	Outdoor Air Temp. °C DB	Indoor Air Temp. °C											
		27/16		27/17.5		27/18		27/19		27/22		27/24	
		Total Q	Input Power	Total Q	Input Power	Total Q	Input Power	Total Q	Input Power	Total Q	Input Power	Total Q	Input Power
1.6 + 6.0	22	5.99	0.98	6.13	0.98	6.17	0.98	6.27	0.98	8.66	1.57	10.25	1.97
	25	6.83	1.65	7.01	1.63	7.07	1.62	7.19	1.60	8.98	1.99	10.17	2.24
	29	7.65	2.38	7.85	2.35	7.91	2.34	8.05	2.31	9.20	2.48	9.96	2.58
	32	8.01	2.81	8.22	2.77	8.30	2.76	8.44	2.74	10.30	2.78	11.53	2.81
	35	8.15	3.13	8.37	3.10	8.45	3.10	8.60	3.08	9.13	3.04	9.48	3.01
	40	7.92	3.28	8.15	3.29	8.22	3.30	8.37	3.30	8.26	3.21	8.51	3.18
	43	7.48	3.28	7.71	3.35	7.79	3.37	7.94	3.42	8.08	3.35	8.17	3.33
	46	6.82	3.21	7.05	3.33	7.12	3.37	7.28	3.41	7.71	3.43	8.01	3.45
1.6 + 7.1	22	6.34	1.00	6.49	1.00	6.53	1.00	6.63	1.00	9.16	1.62	10.85	2.02
	25	7.23	1.70	7.42	1.67	7.48	1.66	7.60	1.65	9.50	2.04	10.76	2.30
	29	8.10	2.45	8.31	2.41	8.37	2.40	8.51	2.37	9.73	2.54	10.54	2.65
	32	8.47	2.88	8.70	2.85	8.78	2.83	8.93	2.81	10.90	2.85	12.20	2.88
	35	8.62	3.21	8.86	3.18	8.94	3.18	9.10	3.16	9.66	3.12	10.03	3.09
	40	8.38	3.37	8.62	3.38	8.70	3.38	8.86	3.39	8.74	3.29	9.01	3.26
	43	7.92	3.37	8.16	3.44	8.24	3.46	8.40	3.51	8.55	3.44	8.65	3.42
	46	7.22	3.29	7.46	3.41	7.54	3.45	7.70	3.50	8.16	3.52	8.47	3.54
2.0 + 2.0	22	4.04	0.53	4.13	0.53	4.16	0.53	4.23	0.53	5.84	0.86	6.91	1.07
	25	4.61	0.90	4.73	0.89	4.77	0.88	4.85	0.88	6.05	1.08	6.86	1.22
	29	5.16	1.30	5.29	1.28	5.34	1.27	5.43	1.26	6.20	1.35	6.72	1.41
	32	5.40	1.53	5.55	1.51	5.60	1.51	5.69	1.49	6.94	1.52	7.78	1.53
	35	5.49	1.71	5.65	1.69	5.70	1.69	5.80	1.68	6.16	1.66	6.39	1.64
	40	5.34	1.79	5.49	1.80	5.54	1.80	5.65	1.80	5.57	1.75	5.74	1.74
	43	5.05	1.79	5.20	1.83	5.25	1.84	5.35	1.87	5.45	1.83	5.51	1.82
	46	4.60	1.75	4.75	1.81	4.80	1.84	4.91	1.86	5.20	1.87	5.40	1.88
2.0 + 2.5	22	4.04	0.53	4.13	0.53	4.16	0.53	4.23	0.53	5.84	0.86	6.91	1.07
	25	4.61	0.90	4.73	0.89	4.77	0.88	4.85	0.88	6.05	1.08	6.86	1.22
	29	5.16	1.30	5.29	1.28	5.34	1.27	5.43	1.26	6.20	1.35	6.72	1.41
	32	5.40	1.53	5.55	1.51	5.60	1.51	5.69	1.49	6.94	1.52	7.78	1.53
	35	5.49	1.71	5.65	1.69	5.70	1.69	5.80	1.68	6.16	1.66	6.39	1.64
	40	5.34	1.79	5.49	1.80	5.54	1.80	5.65	1.80	5.57	1.75	5.74	1.74
	43	5.05	1.79	5.20	1.83	5.25	1.84	5.35	1.87	5.45	1.83	5.51	1.82
	46	4.60	1.75	4.75	1.81	4.80	1.84	4.91	1.86	5.20	1.87	5.40	1.88
2.0 + 3.5	22	4.04	0.52	4.13	0.52	4.16	0.52	4.23	0.52	5.84	0.83	6.91	1.04
	25	4.61	0.87	4.73	0.86	4.77	0.86	4.85	0.85	6.05	1.05	6.86	1.19
	29	5.16	1.26	5.29	1.24	5.34	1.24	5.43	1.22	6.20	1.31	6.72	1.37
	32	5.40	1.49	5.55	1.47	5.60	1.46	5.69	1.45	6.94	1.47	7.78	1.49
	35	5.49	1.65	5.65	1.64	5.70	1.64	5.80	1.63	6.16	1.61	6.39	1.59
	40	5.34	1.74	5.49	1.74	5.54	1.74	5.65	1.75	5.57	1.70	5.74	1.68
	43	5.05	1.74	5.20	1.77	5.25	1.79	5.35	1.81	5.45	1.77	5.51	1.76
	46	4.60	1.70	4.75	1.76	4.80	1.78	4.91	1.81	5.20	1.82	5.40	1.83

Combination (Capacity)	Outdoor Air Temp. °C DB	Indoor Air Temp. °C											
		27/16		27/17.5		27/18		27/19		27/22		27/24	
		Total Q	Input Power	Total Q	Input Power	Total Q	Input Power	Total Q	Input Power	Total Q	Input Power	Total Q	Input Power
2.0 + 4.2	22	5.02	0.79	5.13	0.79	5.17	0.79	5.25	0.79	7.25	1.27	8.58	1.59
	25	5.72	1.34	5.87	1.32	5.92	1.31	6.02	1.30	7.52	1.61	8.52	1.81
	29	6.41	1.93	6.57	1.90	6.63	1.89	6.74	1.87	7.70	2.00	8.34	2.09
	32	6.70	2.27	6.89	2.24	6.95	2.23	7.07	2.21	8.62	2.25	9.66	2.27
	35	6.82	2.53	7.01	2.51	7.07	2.50	7.20	2.49	7.64	2.46	7.94	2.43
	40	6.63	2.65	6.82	2.66	6.88	2.66	7.01	2.67	6.91	2.60	7.13	2.57
	43	6.26	2.65	6.46	2.71	6.52	2.73	6.65	2.77	6.77	2.71	6.84	2.70
	46	5.71	2.59	5.90	2.69	5.96	2.72	6.09	2.76	6.46	2.77	6.70	2.79
2.0 + 5.0	22	5.64	0.83	5.77	0.83	5.82	0.83	5.90	0.83	8.15	1.33	9.65	1.67
	25	6.43	1.40	6.60	1.38	6.66	1.37	6.77	1.36	8.46	1.68	9.58	1.90
	29	7.21	2.02	7.39	1.99	7.45	1.98	7.58	1.96	8.66	2.10	9.38	2.19
	32	7.54	2.38	7.75	2.35	7.81	2.34	7.95	2.32	9.70	2.36	10.86	2.38
	35	7.67	2.65	7.89	2.63	7.96	2.62	8.10	2.61	8.60	2.57	8.93	2.55
	40	7.46	2.78	7.67	2.79	7.74	2.79	7.89	2.80	7.78	2.72	8.02	2.70
	43	7.05	2.78	7.26	2.84	7.33	2.86	7.48	2.90	7.61	2.84	7.70	2.83
	46	6.42	2.72	6.64	2.82	6.71	2.85	6.85	2.89	7.27	2.91	7.54	2.93
2.0 + 6.0	22	5.99	0.96	6.13	0.96	6.17	0.96	6.27	0.96	8.66	1.54	10.25	1.93
	25	6.83	1.61	7.01	1.59	7.07	1.58	7.19	1.57	8.98	1.94	10.17	2.19
	29	7.65	2.33	7.85	2.29	7.91	2.28	8.05	2.26	9.20	2.42	9.96	2.53
	32	8.01	2.74	8.22	2.71	8.30	2.70	8.44	2.68	10.30	2.72	11.53	2.74
	35	8.15	3.06	8.37	3.03	8.45	3.03	8.60	3.01	9.13	2.97	9.48	2.94
	40	7.92	3.21	8.15	3.22	8.22	3.22	8.37	3.23	8.26	3.14	8.51	3.11
	43	7.48	3.21	7.71	3.27	7.79	3.30	7.94	3.34	8.08	3.27	8.17	3.26
	46	6.82	3.14	7.05	3.25	7.12	3.29	7.28	3.34	7.71	3.35	8.01	3.37
2.0 + 7.1	22	6.97	1.28	7.13	1.28	7.18	1.28	7.29	1.28	10.07	2.06	11.92	2.58
	25	7.94	2.16	8.15	2.13	8.22	2.12	8.36	2.10	10.44	2.60	11.83	2.93
	29	8.90	3.12	9.13	3.07	9.20	3.06	9.36	3.03	10.69	3.24	11.59	3.38
	32	9.31	3.67	9.56	3.63	9.65	3.61	9.82	3.58	11.97	3.64	13.41	3.67
	35	9.47	4.09	9.74	4.06	9.82	4.05	10.00	4.03	10.61	3.97	11.02	3.94
	40	9.21	4.29	9.47	4.31	9.56	4.31	9.74	4.32	9.60	4.20	9.90	4.16
	43	8.70	4.29	8.97	4.38	9.05	4.42	9.23	4.48	9.40	4.38	9.50	4.36
	46	7.93	4.20	8.20	4.35	8.28	4.40	8.46	4.47	8.97	4.49	9.31	4.52
2.5 + 2.5	22	4.04	0.53	4.13	0.53	4.16	0.53	4.23	0.53	5.84	0.86	6.91	1.07
	25	4.61	0.90	4.73	0.89	4.77	0.88	4.85	0.88	6.05	1.08	6.86	1.22
	29	5.16	1.30	5.29	1.28	5.34	1.27	5.43	1.26	6.20	1.35	6.72	1.41
	32	5.40	1.53	5.55	1.51	5.60	1.51	5.69	1.49	6.94	1.52	7.78	1.53
	35	5.49	1.71	5.65	1.69	5.70	1.69	5.80	1.68	6.16	1.66	6.39	1.64
	40	5.34	1.79	5.49	1.80	5.54	1.80	5.65	1.80	5.57	1.75	5.74	1.74
	43	5.05	1.79	5.20	1.83	5.25	1.84	5.35	1.87	5.45	1.83	5.51	1.82
	46	4.60	1.75	4.75	1.81	4.80	1.84	4.91	1.86	5.20	1.87	5.40	1.88

Combination (Capacity)	Outdoor Air Temp. °C DB	Indoor Air Temp. °C											
		27/16		27/17.5		27/18		27/19		27/22		27/24	
		Total Q	Input Power	Total Q	Input Power	Total Q	Input Power	Total Q	Input Power	Total Q	Input Power	Total Q	Input Power
2.5 + 3.5	22	4.67	0.68	4.77	0.68	4.81	0.68	4.88	0.68	6.74	1.09	7.99	1.36
	25	5.32	1.14	5.46	1.13	5.51	1.12	5.60	1.11	6.99	1.37	7.92	1.55
	29	5.96	1.65	6.11	1.62	6.17	1.62	6.27	1.60	7.17	1.71	7.76	1.79
	32	6.24	1.94	6.41	1.92	6.46	1.91	6.58	1.89	8.02	1.92	8.98	1.94
	35	6.35	2.16	6.52	2.15	6.58	2.14	6.70	2.13	7.11	2.10	7.39	2.08
	40	6.17	2.27	6.35	2.28	6.40	2.28	6.52	2.28	6.43	2.22	6.63	2.20
	43	5.83	2.27	6.01	2.32	6.07	2.33	6.18	2.37	6.30	2.32	6.37	2.31
	46	5.31	2.22	5.49	2.30	5.55	2.33	5.67	2.36	6.01	2.37	6.24	2.39
2.5 + 4.2	22	5.02	0.79	5.13	0.79	5.17	0.79	5.25	0.79	7.25	1.27	8.58	1.59
	25	5.72	1.34	5.87	1.32	5.92	1.31	6.02	1.30	7.52	1.61	8.52	1.81
	29	6.41	1.93	6.57	1.90	6.63	1.89	6.74	1.87	7.70	2.00	8.34	2.09
	32	6.70	2.27	6.89	2.24	6.95	2.23	7.07	2.21	8.62	2.25	9.66	2.27
	35	6.82	2.53	7.01	2.51	7.07	2.50	7.20	2.49	7.64	2.46	7.94	2.43
	40	6.63	2.65	6.82	2.66	6.88	2.66	7.01	2.67	6.91	2.60	7.13	2.57
	43	6.26	2.65	6.46	2.71	6.52	2.73	6.65	2.77	6.77	2.71	6.84	2.70
	46	5.71	2.59	5.90	2.69	5.96	2.72	6.09	2.76	6.46	2.77	6.70	2.79
2.5 + 5.0	22	5.99	0.96	6.13	0.96	6.17	0.96	6.27	0.96	8.66	1.54	10.25	1.93
	25	6.83	1.61	7.01	1.59	7.07	1.58	7.19	1.57	8.98	1.94	10.17	2.19
	29	7.65	2.33	7.85	2.29	7.91	2.28	8.05	2.26	9.20	2.42	9.96	2.53
	32	8.01	2.74	8.22	2.71	8.30	2.70	8.44	2.68	10.30	2.72	11.53	2.74
	35	8.15	3.06	8.37	3.03	8.45	3.03	8.60	3.01	9.13	2.97	9.48	2.94
	40	7.92	3.21	8.15	3.22	8.22	3.22	8.37	3.23	8.26	3.14	8.51	3.11
	43	7.48	3.21	7.71	3.27	7.79	3.30	7.94	3.34	8.08	3.27	8.17	3.26
	46	6.82	3.14	7.05	3.25	7.12	3.29	7.28	3.34	7.71	3.35	8.01	3.37
2.5 + 6.0	22	6.34	1.05	6.49	1.05	6.53	1.05	6.63	1.05	9.16	1.68	10.85	2.11
	25	7.23	1.76	7.42	1.74	7.48	1.73	7.60	1.71	9.50	2.12	10.76	2.40
	29	8.10	2.55	8.31	2.51	8.37	2.50	8.51	2.47	9.73	2.64	10.54	2.76
	32	8.47	3.00	8.70	2.96	8.78	2.95	8.93	2.92	10.90	2.97	12.20	3.00
	35	8.62	3.34	8.86	3.32	8.94	3.31	9.10	3.29	9.66	3.24	10.03	3.21
	40	8.38	3.50	8.62	3.52	8.70	3.52	8.86	3.53	8.74	3.43	9.01	3.40
	43	7.92	3.50	8.16	3.58	8.24	3.60	8.40	3.65	8.55	3.58	8.65	3.56
	46	7.22	3.43	7.46	3.55	7.54	3.60	7.70	3.65	8.16	3.67	8.47	3.69
2.5 + 7.1	22	7.04	1.33	7.20	1.33	7.25	1.33	7.36	1.33	10.17	2.14	12.04	2.67
	25	8.02	2.24	8.23	2.21	8.30	2.20	8.44	2.18	10.54	2.70	11.95	3.04
	29	8.99	3.24	9.22	3.19	9.30	3.17	9.45	3.14	10.80	3.36	11.70	3.51
	32	9.40	3.81	9.66	3.76	9.74	3.75	9.91	3.72	12.09	3.77	13.54	3.81
	35	9.57	4.24	9.83	4.21	9.92	4.20	10.10	4.18	10.72	4.12	11.13	4.08
	40	9.30	4.45	9.57	4.47	9.65	4.47	9.83	4.48	9.70	4.36	10.00	4.32
	43	8.79	4.45	9.06	4.55	9.14	4.58	9.32	4.64	9.49	4.55	9.60	4.53
	46	8.01	4.36	8.28	4.52	8.37	4.57	8.54	4.63	9.06	4.66	9.40	4.69

Combination (Capacity)	Outdoor Air Temp. °C DB	Indoor Air Temp. °C											
		27/16		27/17.5		27/18		27/19		27/22		27/24	
		Total Q	Input Power	Total Q	Input Power	Total Q	Input Power	Total Q	Input Power	Total Q	Input Power	Total Q	Input Power
3.5 + 3.5	22	5.64	0.97	5.77	0.97	5.82	0.97	5.90	0.97	8.15	1.56	9.65	1.96
	25	6.43	1.64	6.60	1.62	6.66	1.61	6.77	1.59	8.46	1.97	9.58	2.23
	29	7.21	2.37	7.39	2.33	7.45	2.32	7.58	2.30	8.66	2.46	9.38	2.57
	32	7.54	2.79	7.75	2.76	7.81	2.74	7.95	2.72	9.70	2.76	10.86	2.79
	35	7.67	3.11	7.89	3.08	7.96	3.08	8.10	3.06	8.60	3.02	8.93	2.99
	40	7.46	3.26	7.67	3.27	7.74	3.27	7.89	3.28	7.78	3.19	8.02	3.16
	43	7.05	3.26	7.26	3.33	7.33	3.35	7.48	3.40	7.61	3.33	7.70	3.31
	46	6.42	3.19	6.64	3.31	6.71	3.34	6.85	3.39	7.27	3.41	7.54	3.43
3.5 + 4.2	22	5.99	1.13	6.13	1.13	6.17	1.13	6.27	1.13	8.66	1.81	10.25	2.27
	25	6.83	1.90	7.01	1.88	7.07	1.87	7.19	1.85	8.98	2.29	10.17	2.58
	29	7.65	2.75	7.85	2.71	7.91	2.69	8.05	2.67	9.20	2.85	9.96	2.98
	32	8.01	3.24	8.22	3.20	8.30	3.18	8.44	3.16	10.30	3.20	11.53	3.24
	35	8.15	3.60	8.37	3.58	8.45	3.57	8.60	3.55	9.13	3.50	9.48	3.47
	40	7.92	3.78	8.15	3.79	8.22	3.80	8.37	3.81	8.26	3.70	8.51	3.67
	43	7.48	3.78	7.71	3.86	7.79	3.89	7.94	3.94	8.08	3.86	8.17	3.84
	46	6.82	3.70	7.05	3.83	7.12	3.88	7.28	3.94	7.71	3.95	8.01	3.98
3.5 + 5.0	22	6.34	1.00	6.49	1.00	6.53	1.00	6.63	1.00	9.16	1.62	10.85	2.02
	25	7.23	1.70	7.42	1.67	7.48	1.66	7.60	1.65	9.50	2.04	10.76	2.30
	29	8.10	2.45	8.31	2.41	8.37	2.40	8.51	2.37	9.73	2.54	10.54	2.65
	32	8.47	2.88	8.70	2.85	8.78	2.83	8.93	2.81	10.90	2.85	12.20	2.88
	35	8.62	3.21	8.86	3.18	8.94	3.18	9.10	3.16	9.66	3.12	10.03	3.09
	40	8.38	3.37	8.62	3.38	8.70	3.38	8.86	3.39	8.74	3.29	9.01	3.26
	43	7.92	3.37	8.16	3.44	8.24	3.46	8.40	3.51	8.55	3.44	8.65	3.42
	46	7.22	3.29	7.46	3.41	7.54	3.45	7.70	3.50	8.16	3.52	8.47	3.54
3.5 + 6.0	22	7.04	1.33	7.20	1.33	7.25	1.33	7.36	1.33	10.17	2.14	12.04	2.67
	25	8.02	2.24	8.23	2.21	8.30	2.20	8.44	2.18	10.54	2.70	11.95	3.04
	29	8.99	3.24	9.22	3.19	9.30	3.17	9.45	3.14	10.80	3.36	11.70	3.51
	32	9.40	3.81	9.66	3.76	9.74	3.75	9.91	3.72	12.09	3.77	13.54	3.81
	35	9.57	4.24	9.83	4.21	9.92	4.20	10.10	4.18	10.72	4.12	11.13	4.08
	40	9.30	4.45	9.57	4.47	9.65	4.47	9.83	4.48	9.70	4.36	10.00	4.32
	43	8.79	4.45	9.06	4.55	9.14	4.58	9.32	4.64	9.49	4.55	9.60	4.53
	46	8.01	4.36	8.28	4.52	8.37	4.57	8.54	4.63	9.06	4.66	9.40	4.69
3.5 + 7.1	22	7.24	1.38	7.41	1.38	7.47	1.38	7.58	1.38	10.47	2.22	12.40	2.78
	25	8.26	2.33	8.48	2.29	8.55	2.28	8.69	2.26	10.86	2.80	12.30	3.16
	29	9.25	3.36	9.49	3.31	9.57	3.29	9.73	3.26	11.12	3.49	12.05	3.64
	32	9.68	3.96	9.95	3.91	10.03	3.89	10.21	3.86	12.45	3.92	13.95	3.96
	35	9.85	4.41	10.13	4.37	10.22	4.36	10.40	4.34	11.04	4.28	11.46	4.24
	40	9.58	4.62	9.85	4.64	9.94	4.64	10.13	4.66	9.98	4.53	10.30	4.48
	43	9.05	4.62	9.32	4.72	9.42	4.75	9.60	4.82	9.78	4.72	9.88	4.70
	46	8.25	4.52	8.52	4.69	8.61	4.74	8.80	4.81	9.33	4.83	9.68	4.84

Combination (Capacity)	Outdoor Air Temp. °C DB	Indoor Air Temp. °C											
		27/16		27/17.5		27/18		27/19		27/22		27/24	
		Total Q	Input Power	Total Q	Input Power	Total Q	Input Power	Total Q	Input Power	Total Q	Input Power	Total Q	Input Power
4.2 + 4.2	22	6.34	1.26	6.49	1.26	6.53	1.26	6.63	1.26	9.16	2.02	10.85	2.53
	25	7.23	2.12	7.42	2.09	7.48	2.08	7.60	2.06	9.50	2.56	10.76	2.88
	29	8.10	3.06	8.31	3.02	8.37	3.00	8.51	2.97	9.73	3.18	10.54	3.32
	32	8.47	3.61	8.70	3.57	8.78	3.55	8.93	3.52	10.90	3.57	12.20	3.61
	35	8.62	4.02	8.86	3.99	8.94	3.98	9.10	3.96	9.66	3.91	10.03	3.87
	40	8.38	4.22	8.62	4.23	8.70	4.24	8.86	4.25	8.74	4.13	9.01	4.09
	43	7.92	4.22	8.16	4.31	8.24	4.34	8.40	4.40	8.55	4.31	8.65	4.29
	46	7.22	4.13	7.46	4.28	7.54	4.33	7.70	4.39	8.16	4.41	8.47	4.44
4.2 + 5.0	22	6.97	1.28	7.13	1.28	7.18	1.28	7.29	1.28	10.07	2.06	11.92	2.58
	25	7.94	2.16	8.15	2.13	8.22	2.12	8.36	2.10	10.44	2.60	11.83	2.93
	29	8.90	3.12	9.13	3.07	9.20	3.06	9.36	3.03	10.69	3.24	11.59	3.38
	32	9.31	3.67	9.56	3.63	9.65	3.61	9.82	3.58	11.97	3.64	13.41	3.67
	35	9.47	4.09	9.74	4.06	9.82	4.05	10.00	4.03	10.61	3.97	11.02	3.94
	40	9.21	4.29	9.47	4.31	9.56	4.31	9.74	4.32	9.60	4.20	9.90	4.16
	43	8.70	4.29	8.97	4.38	9.05	4.42	9.23	4.48	9.40	4.38	9.50	4.36
	46	7.93	4.20	8.20	4.35	8.28	4.40	8.46	4.47	8.97	4.49	9.31	4.52
4.2 + 6.0	22	7.24	1.38	7.41	1.38	7.47	1.38	7.58	1.38	10.47	2.21	12.40	2.77
	25	8.26	2.32	8.48	2.29	8.55	2.28	8.69	2.26	10.86	2.79	12.30	3.15
	29	9.25	3.35	9.49	3.30	9.57	3.28	9.73	3.25	11.12	3.48	12.05	3.63
	32	9.68	3.95	9.95	3.90	10.03	3.88	10.21	3.85	12.45	3.91	13.95	3.95
	35	9.85	4.40	10.13	4.36	10.22	4.35	10.40	4.33	11.04	4.27	11.46	4.23
	40	9.58	4.61	9.85	4.63	9.94	4.63	10.13	4.64	9.98	4.51	10.30	4.47
	43	9.05	4.61	9.32	4.71	9.42	4.74	9.60	4.81	9.78	4.71	9.88	4.69
	46	8.25	4.51	8.52	4.68	8.61	4.73	8.80	4.80	9.33	4.82	9.68	4.84
4.2 + 7.1	22	7.24	1.38	7.41	1.38	7.47	1.38	7.58	1.38	10.47	2.22	12.40	2.78
	25	8.26	2.33	8.48	2.29	8.55	2.28	8.69	2.26	10.86	2.80	12.30	3.16
	29	9.25	3.36	9.49	3.31	9.57	3.29	9.73	3.26	11.12	3.49	12.05	3.64
	32	9.68	3.96	9.95	3.91	10.03	3.89	10.21	3.86	12.45	3.92	13.95	3.96
	35	9.85	4.41	10.13	4.37	10.22	4.36	10.40	4.34	11.04	4.28	11.46	4.24
	40	9.58	4.62	9.85	4.64	9.94	4.64	10.13	4.66	9.98	4.53	10.30	4.48
	43	9.05	4.62	9.32	4.72	9.42	4.75	9.60	4.82	9.78	4.72	9.88	4.70
	46	8.25	4.52	8.52	4.69	8.61	4.74	8.80	4.81	9.33	4.83	9.68	4.84
5.0 + 5.0	22	7.24	1.15	7.41	1.15	7.47	1.15	7.58	1.15	10.47	1.85	12.40	2.31
	25	8.26	1.94	8.48	1.91	8.55	1.90	8.69	1.88	10.86	2.33	12.30	2.63
	29	9.25	2.79	9.49	2.75	9.57	2.74	9.73	2.71	11.12	2.90	12.05	3.03
	32	9.68	3.29	9.95	3.25	10.03	3.24	10.21	3.21	12.45	3.26	13.95	3.29
	35	9.85	3.67	10.13	3.64	10.22	3.63	10.40	3.61	11.04	3.56	11.46	3.53
	40	9.58	3.84	9.85	3.86	9.94	3.86	10.13	3.87	9.98	3.76	10.30	3.73
	43	9.05	3.84	9.32	3.93	9.42	3.96	9.60	4.01	9.78	3.93	9.88	3.91
	46	8.25	3.76	8.52	3.90	8.61	3.95	8.80	4.00	9.33	4.02	9.68	4.05



Combination (Capacity)	Outdoor Air Temp. °C DB	Indoor Air Temp. °C											
		27/16		27/17.5		27/18		27/19		27/22		27/24	
		Total Q	Input Power	Total Q	Input Power	Total Q	Input Power	Total Q	Input Power	Total Q	Input Power	Total Q	Input Power
5.0 + 6.0	22	7.24	1.15	7.41	1.15	7.47	1.15	7.58	1.15	10.47	1.85	12.40	2.31
	25	8.26	1.94	8.48	1.91	8.55	1.90	8.69	1.88	10.86	2.33	12.30	2.63
	29	9.25	2.79	9.49	2.75	9.57	2.74	9.73	2.71	11.12	2.90	12.05	3.03
	32	9.68	3.29	9.95	3.25	10.03	3.24	10.21	3.21	12.45	3.26	13.95	3.29
	35	9.85	3.67	10.13	3.64	10.22	3.63	10.40	3.61	11.04	3.56	11.46	3.53
	40	9.58	3.84	9.85	3.86	9.94	3.86	10.13	3.87	9.98	3.76	10.30	3.73
	43	9.05	3.84	9.32	3.93	9.42	3.96	9.60	4.01	9.78	3.93	9.88	3.91
	46	8.25	3.76	8.52	3.90	8.61	3.95	8.80	4.00	9.33	4.02	9.68	4.05
5.0 + 7.1	22	7.24	1.11	7.41	1.11	7.47	1.11	7.58	1.11	10.47	1.78	12.40	2.23
	25	8.26	1.87	8.48	1.84	8.55	1.83	8.69	1.81	10.86	2.25	12.30	2.53
	29	9.25	2.69	9.49	2.65	9.57	2.64	9.73	2.61	11.12	2.80	12.05	2.92
	32	9.68	3.17	9.95	3.13	10.03	3.12	10.21	3.09	12.45	3.14	13.95	3.17
	35	9.85	3.53	10.13	3.51	10.22	3.50	10.40	3.48	11.04	3.43	11.46	3.40
	40	9.58	3.71	9.85	3.72	9.94	3.72	10.13	3.73	9.98	3.63	10.30	3.59
	43	9.05	3.71	9.32	3.79	9.42	3.81	9.60	3.87	9.78	3.79	9.88	3.77
	46	8.25	3.63	8.52	3.76	8.61	3.80	8.80	3.86	9.33	3.88	9.68	3.90
6.0 + 6.0	22	7.24	1.15	7.41	1.15	7.47	1.15	7.58	1.15	10.47	1.85	12.40	2.31
	25	8.26	1.94	8.48	1.91	8.55	1.90	8.69	1.88	10.86	2.33	12.30	2.63
	29	9.25	2.79	9.49	2.75	9.57	2.74	9.73	2.71	11.12	2.90	12.05	3.03
	32	9.68	3.29	9.95	3.25	10.03	3.24	10.21	3.21	12.45	3.26	13.95	3.29
	35	9.85	3.67	10.13	3.64	10.22	3.63	10.40	3.61	11.04	3.56	11.46	3.53
	40	9.58	3.84	9.85	3.86	9.94	3.86	10.13	3.87	9.98	3.76	10.30	3.73
	43	9.05	3.84	9.32	3.93	9.42	3.96	9.60	4.01	9.78	3.93	9.88	3.91
	46	8.25	3.76	8.52	3.90	8.61	3.95	8.80	4.00	9.33	4.02	9.68	4.05
6.0 + 7.1	22	7.24	1.11	7.41	1.11	7.47	1.11	7.58	1.11	10.47	1.78	12.40	2.23
	25	8.26	1.87	8.48	1.84	8.55	1.83	8.69	1.81	10.86	2.25	12.30	2.53
	29	9.25	2.69	9.49	2.65	9.57	2.64	9.73	2.61	11.12	2.80	12.05	2.92
	32	9.68	3.17	9.95	3.13	10.03	3.12	10.21	3.09	12.45	3.14	13.95	3.17
	35	9.85	3.53	10.13	3.51	10.22	3.50	10.40	3.48	11.04	3.43	11.46	3.40
	40	9.58	3.71	9.85	3.72	9.94	3.72	10.13	3.73	9.98	3.63	10.30	3.59
	43	9.05	3.71	9.32	3.79	9.42	3.81	9.60	3.87	9.78	3.79	9.88	3.77
	46	8.25	3.63	8.52	3.76	8.61	3.80	8.80	3.86	9.33	3.88	9.68	3.90
7.1 + 7.1	22	7.24	1.06	7.41	1.06	7.47	1.06	7.58	1.06	10.47	1.71	12.40	2.14
	25	8.26	1.79	8.48	1.77	8.55	1.76	8.69	1.74	10.86	2.16	12.30	2.43
	29	9.25	2.58	9.49	2.55	9.57	2.53	9.73	2.51	11.12	2.68	12.05	2.80
	32	9.68	3.05	9.95	3.01	10.03	2.99	10.21	2.97	12.45	3.01	13.95	3.05
	35	9.85	3.39	10.13	3.37	10.22	3.36	10.40	3.34	11.04	3.29	11.46	3.26
	40	9.58	3.56	9.85	3.57	9.94	3.57	10.13	3.58	9.98	3.48	10.30	3.45
	43	9.05	3.56	9.32	3.63	9.42	3.66	9.60	3.71	9.78	3.63	9.88	3.62
	46	8.25	3.48	8.52	3.61	8.61	3.65	8.80	3.70	9.33	3.72	9.68	3.74

Combination (Capacity)	Outdoor Air Temp. °C DB	Indoor Air Temp. °C											
		27/16		27/17.5		27/18		27/19		27/22		27/24	
		Total Q	Input Power	Total Q	Input Power	Total Q	Input Power	Total Q	Input Power	Total Q	Input Power	Total Q	Input Power
1.6 + 1.6 + 1.6	22	5.92	0.83	6.06	0.83	6.10	0.83	6.19	0.83	8.56	1.34	10.13	1.68
	25	6.75	1.41	6.93	1.39	6.99	1.38	7.10	1.37	8.87	1.69	10.05	1.91
	29	7.56	2.03	7.76	2.00	7.82	1.99	7.95	1.97	9.09	2.11	9.85	2.20
	32	7.91	2.39	8.13	2.36	8.20	2.35	8.34	2.33	10.18	2.37	11.40	2.39
	35	8.05	2.66	8.28	2.64	8.35	2.63	8.50	2.62	9.02	2.58	9.37	2.56
	40	7.83	2.79	8.05	2.80	8.13	2.80	8.28	2.81	8.16	2.73	8.42	2.71
	43	7.40	2.79	7.62	2.85	7.70	2.87	7.85	2.91	7.99	2.85	8.08	2.84
	46	6.74	2.73	6.97	2.83	7.04	2.86	7.19	2.90	7.62	2.92	7.91	2.94
1.6 + 1.6 + 2.0	22	5.92	0.83	6.06	0.83	6.10	0.83	6.19	0.83	8.56	1.34	10.13	1.68
	25	6.75	1.41	6.93	1.39	6.99	1.38	7.10	1.37	8.87	1.69	10.05	1.91
	29	7.56	2.03	7.76	2.00	7.82	1.99	7.95	1.97	9.09	2.11	9.85	2.20
	32	7.91	2.39	8.13	2.36	8.20	2.35	8.34	2.33	10.18	2.37	11.40	2.39
	35	8.05	2.66	8.28	2.64	8.35	2.63	8.50	2.62	9.02	2.58	9.37	2.56
	40	7.83	2.79	8.05	2.80	8.13	2.80	8.28	2.81	8.16	2.73	8.42	2.71
	43	7.40	2.79	7.62	2.85	7.70	2.87	7.85	2.91	7.99	2.85	8.08	2.84
	46	6.74	2.73	6.97	2.83	7.04	2.86	7.19	2.90	7.62	2.92	7.91	2.94
1.6 + 1.6 + 2.5	22	5.92	0.83	6.06	0.83	6.10	0.83	6.19	0.83	8.56	1.34	10.13	1.68
	25	6.75	1.41	6.93	1.39	6.99	1.38	7.10	1.37	8.87	1.69	10.05	1.91
	29	7.56	2.03	7.76	2.00	7.82	1.99	7.95	1.97	9.09	2.11	9.85	2.20
	32	7.91	2.39	8.13	2.36	8.20	2.35	8.34	2.33	10.18	2.37	11.40	2.39
	35	8.05	2.66	8.28	2.64	8.35	2.63	8.50	2.62	9.02	2.58	9.37	2.56
	40	7.83	2.79	8.05	2.80	8.13	2.80	8.28	2.81	8.16	2.73	8.42	2.71
	43	7.40	2.79	7.62	2.85	7.70	2.87	7.85	2.91	7.99	2.85	8.08	2.84
	46	6.74	2.73	6.97	2.83	7.04	2.86	7.19	2.90	7.62	2.92	7.91	2.94
1.6 + 1.6 + 3.5	22	5.92	0.81	6.06	0.81	6.10	0.81	6.19	0.81	8.56	1.30	10.13	1.63
	25	6.75	1.37	6.93	1.35	6.99	1.34	7.10	1.33	8.87	1.65	10.05	1.86
	29	7.56	1.97	7.76	1.94	7.82	1.93	7.95	1.91	9.09	2.05	9.85	2.14
	32	7.91	2.33	8.13	2.30	8.20	2.29	8.34	2.27	10.18	2.30	11.40	2.33
	35	8.05	2.59	8.28	2.57	8.35	2.56	8.50	2.55	9.02	2.51	9.37	2.49
	40	7.83	2.72	8.05	2.73	8.13	2.73	8.28	2.74	8.16	2.66	8.42	2.63
	43	7.40	2.72	7.62	2.77	7.70	2.79	7.85	2.83	7.99	2.77	8.08	2.76
	46	6.74	2.66	6.97	2.75	7.04	2.79	7.19	2.83	7.62	2.84	7.91	2.86
1.6 + 1.6 + 4.2	22	5.92	0.79	6.06	0.79	6.10	0.79	6.19	0.79	8.56	1.27	10.13	1.59
	25	6.75	1.34	6.93	1.32	6.99	1.31	7.10	1.30	8.87	1.61	10.05	1.81
	29	7.56	1.93	7.76	1.90	7.82	1.89	7.95	1.87	9.09	2.00	9.85	2.09
	32	7.91	2.27	8.13	2.24	8.20	2.23	8.34	2.21	10.18	2.25	11.40	2.27
	35	8.05	2.53	8.28	2.51	8.35	2.50	8.50	2.49	9.02	2.46	9.37	2.43
	40	7.83	2.65	8.05	2.66	8.13	2.66	8.28	2.67	8.16	2.60	8.42	2.57
	43	7.40	2.65	7.62	2.71	7.70	2.73	7.85	2.77	7.99	2.71	8.08	2.70
	46	6.74	2.59	6.97	2.69	7.04	2.72	7.19	2.76	7.62	2.77	7.91	2.79

Combination (Capacity)	Outdoor Air Temp. °C DB	Indoor Air Temp. °C											
		27/16		27/17.5		27/18		27/19		27/22		27/24	
		Total Q	Input Power	Total Q	Input Power	Total Q	Input Power	Total Q	Input Power	Total Q	Input Power	Total Q	Input Power
1.6 + 1.6 + 5.0	22	6.06	0.73	6.20	0.73	6.25	0.73	6.34	0.73	8.76	1.17	10.37	1.47
	25	6.91	1.23	7.09	1.21	7.15	1.20	7.27	1.19	9.08	1.48	10.29	1.67
	29	7.74	1.77	7.94	1.75	8.01	1.74	8.14	1.72	9.30	1.84	10.08	1.92
	32	8.10	2.09	8.32	2.06	8.39	2.05	8.54	2.04	10.42	2.07	11.67	2.09
	35	8.24	2.33	8.47	2.31	8.55	2.30	8.70	2.29	9.23	2.26	9.59	2.24
	40	8.01	2.44	8.24	2.45	8.32	2.45	8.47	2.46	8.35	2.39	8.61	2.37
	43	7.57	2.44	7.80	2.49	7.88	2.51	8.03	2.54	8.18	2.49	8.27	2.48
	46	6.90	2.39	7.13	2.47	7.21	2.50	7.36	2.54	7.80	2.55	8.10	2.57
1.6 + 1.6 + 6.0	22	7.04	0.95	7.20	0.95	7.25	0.95	7.36	0.95	10.17	1.53	12.04	1.92
	25	8.02	1.61	8.23	1.59	8.30	1.58	8.44	1.56	10.54	1.94	11.95	2.18
	29	8.99	2.32	9.22	2.29	9.30	2.28	9.45	2.25	10.80	2.41	11.70	2.52
	32	9.40	2.74	9.66	2.70	9.74	2.69	9.91	2.67	12.09	2.71	13.54	2.74
	35	9.57	3.05	9.83	3.02	9.92	3.02	10.10	3.00	10.72	2.96	11.13	2.93
	40	9.30	3.19	9.57	3.21	9.65	3.21	9.83	3.22	9.70	3.13	10.00	3.10
	43	8.79	3.19	9.06	3.26	9.14	3.29	9.32	3.33	9.49	3.26	9.60	3.25
	46	8.01	3.13	8.28	3.24	8.37	3.28	8.54	3.33	9.06	3.34	9.40	3.36
1.6 + 1.6 + 7.1	22	7.45	1.06	7.63	1.06	7.68	1.06	7.80	1.06	10.77	1.71	12.75	2.14
	25	8.50	1.79	8.72	1.77	8.79	1.76	8.94	1.74	11.17	2.16	12.66	2.43
	29	9.52	2.58	9.77	2.55	9.85	2.53	10.01	2.51	11.44	2.68	12.40	2.80
	32	9.96	3.05	10.23	3.01	10.32	2.99	10.50	2.97	12.81	3.01	14.35	3.05
	35	10.13	3.39	10.42	3.37	10.51	3.36	10.70	3.34	11.36	3.29	11.79	3.26
	40	9.85	3.56	10.13	3.57	10.23	3.57	10.42	3.58	10.27	3.48	10.59	3.45
	43	9.31	3.56	9.59	3.63	9.69	3.66	9.88	3.71	10.06	3.63	10.17	3.62
	46	8.49	3.48	8.77	3.61	8.86	3.65	9.05	3.70	9.60	3.72	9.96	3.74
1.6 + 2.0 + 2.0	22	5.92	0.81	6.06	0.81	6.10	0.81	6.19	0.81	8.56	1.30	10.13	1.63
	25	6.75	1.37	6.93	1.35	6.99	1.34	7.10	1.33	8.87	1.65	10.05	1.86
	29	7.56	1.97	7.76	1.94	7.82	1.93	7.95	1.91	9.09	2.05	9.85	2.14
	32	7.91	2.33	8.13	2.30	8.20	2.29	8.34	2.27	10.18	2.30	11.40	2.33
	35	8.05	2.59	8.28	2.57	8.35	2.56	8.50	2.55	9.02	2.51	9.37	2.49
	40	7.83	2.72	8.05	2.73	8.13	2.73	8.28	2.74	8.16	2.66	8.42	2.63
	43	7.40	2.72	7.62	2.77	7.70	2.79	7.85	2.83	7.99	2.77	8.08	2.76
	46	6.74	2.66	6.97	2.75	7.04	2.79	7.19	2.83	7.62	2.84	7.91	2.86
1.6 + 2.0 + 2.5	22	5.92	0.81	6.06	0.81	6.10	0.81	6.19	0.81	8.56	1.30	10.13	1.63
	25	6.75	1.37	6.93	1.35	6.99	1.34	7.10	1.33	8.87	1.65	10.05	1.86
	29	7.56	1.97	7.76	1.94	7.82	1.93	7.95	1.91	9.09	2.05	9.85	2.14
	32	7.91	2.33	8.13	2.30	8.20	2.29	8.34	2.27	10.18	2.30	11.40	2.33
	35	8.05	2.59	8.28	2.57	8.35	2.56	8.50	2.55	9.02	2.51	9.37	2.49
	40	7.83	2.72	8.05	2.73	8.13	2.73	8.28	2.74	8.16	2.66	8.42	2.63
	43	7.40	2.72	7.62	2.77	7.70	2.79	7.85	2.83	7.99	2.77	8.08	2.76
	46	6.74	2.66	6.97	2.75	7.04	2.79	7.19	2.83	7.62	2.84	7.91	2.86

Combination (Capacity)	Outdoor Air Temp. °C DB	Indoor Air Temp. °C											
		27/16		27/17.5		27/18		27/19		27/22		27/24	
		Total Q	Input Power	Total Q	Input Power	Total Q	Input Power	Total Q	Input Power	Total Q	Input Power	Total Q	Input Power
1.6 + 2.0 + 3.5	22	5.92	0.79	6.06	0.79	6.10	0.79	6.19	0.79	8.56	1.27	10.13	1.59
	25	6.75	1.34	6.93	1.32	6.99	1.31	7.10	1.30	8.87	1.61	10.05	1.81
	29	7.56	1.93	7.76	1.90	7.82	1.89	7.95	1.87	9.09	2.00	9.85	2.09
	32	7.91	2.27	8.13	2.24	8.20	2.23	8.34	2.21	10.18	2.25	11.40	2.27
	35	8.05	2.53	8.28	2.51	8.35	2.50	8.50	2.49	9.02	2.46	9.37	2.43
	40	7.83	2.65	8.05	2.66	8.13	2.66	8.28	2.67	8.16	2.60	8.42	2.57
	43	7.40	2.65	7.62	2.71	7.70	2.73	7.85	2.77	7.99	2.71	8.08	2.70
	46	6.74	2.59	6.97	2.69	7.04	2.72	7.19	2.76	7.62	2.77	7.91	2.79
1.6 + 2.0 + 4.2	22	5.92	0.79	6.06	0.79	6.10	0.79	6.19	0.79	8.56	1.27	10.13	1.59
	25	6.75	1.34	6.93	1.32	6.99	1.31	7.10	1.30	8.87	1.61	10.05	1.81
	29	7.56	1.93	7.76	1.90	7.82	1.89	7.95	1.87	9.09	2.00	9.85	2.09
	32	7.91	2.27	8.13	2.24	8.20	2.23	8.34	2.21	10.18	2.25	11.40	2.27
	35	8.05	2.53	8.28	2.51	8.35	2.50	8.50	2.49	9.02	2.46	9.37	2.43
	40	7.83	2.65	8.05	2.66	8.13	2.66	8.28	2.67	8.16	2.60	8.42	2.57
	43	7.40	2.65	7.62	2.71	7.70	2.73	7.85	2.77	7.99	2.71	8.08	2.70
	46	6.74	2.59	6.97	2.69	7.04	2.72	7.19	2.76	7.62	2.77	7.91	2.79
1.6 + 2.0 + 5.0	22	6.69	0.83	6.84	0.83	6.89	0.83	7.00	0.83	9.66	1.34	11.44	1.68
	25	7.62	1.41	7.82	1.39	7.89	1.38	8.02	1.37	10.02	1.69	11.35	1.91
	29	8.54	2.03	8.76	2.00	8.83	1.99	8.98	1.97	10.27	2.11	11.12	2.20
	32	8.94	2.39	9.18	2.36	9.26	2.35	9.42	2.33	11.49	2.37	12.87	2.39
	35	9.09	2.66	9.35	2.64	9.43	2.63	9.60	2.62	10.19	2.58	10.58	2.56
	40	8.84	2.79	9.09	2.80	9.18	2.80	9.35	2.81	9.22	2.73	9.50	2.71
	43	8.35	2.79	8.61	2.85	8.69	2.87	8.86	2.91	9.02	2.85	9.12	2.84
	46	7.61	2.73	7.87	2.83	7.95	2.86	8.12	2.90	8.61	2.92	8.94	2.94
1.6 + 2.0 + 6.0	22	7.04	0.93	7.20	0.93	7.25	0.93	7.36	0.93	10.17	1.50	12.04	1.88
	25	8.02	1.58	8.23	1.55	8.30	1.55	8.44	1.53	10.54	1.90	11.95	2.14
	29	8.99	2.28	9.22	2.24	9.30	2.23	9.45	2.21	10.80	2.36	11.70	2.47
	32	9.40	2.68	9.66	2.65	9.74	2.64	9.91	2.61	12.09	2.65	13.54	2.68
	35	9.57	2.99	9.83	2.96	9.92	2.96	10.10	2.94	10.72	2.90	11.13	2.87
	40	9.30	3.13	9.57	3.14	9.65	3.15	9.83	3.15	9.70	3.07	10.00	3.04
	43	8.79	3.13	9.06	3.20	9.14	3.22	9.32	3.27	9.49	3.20	9.60	3.18
	46	8.01	3.06	8.28	3.18	8.37	3.21	8.54	3.26	9.06	3.28	9.40	3.30
1.6 + 2.0 + 7.1	22	7.45	1.06	7.63	1.06	7.68	1.06	7.80	1.06	10.77	1.71	12.75	2.14
	25	8.50	1.79	8.72	1.77	8.79	1.76	8.94	1.74	11.17	2.16	12.66	2.43
	29	9.52	2.58	9.77	2.55	9.85	2.53	10.01	2.51	11.44	2.68	12.40	2.80
	32	9.96	3.05	10.23	3.01	10.32	2.99	10.50	2.97	12.81	3.01	14.35	3.05
	35	10.13	3.39	10.42	3.37	10.51	3.36	10.70	3.34	11.36	3.29	11.79	3.26
	40	9.85	3.56	10.13	3.57	10.23	3.57	10.42	3.58	10.27	3.48	10.59	3.45
	43	9.31	3.56	9.59	3.63	9.69	3.66	9.88	3.71	10.06	3.63	10.17	3.62
	46	8.49	3.48	8.77	3.61	8.86	3.65	9.05	3.70	9.60	3.72	9.96	3.74

Combination (Capacity)	Outdoor Air Temp. °C DB	Indoor Air Temp. °C											
		27/16		27/17.5		27/18		27/19		27/22		27/24	
		Total Q	Input Power	Total Q	Input Power	Total Q	Input Power	Total Q	Input Power	Total Q	Input Power	Total Q	Input Power
1.6 + 2.5 + 2.5	22	5.92	0.81	6.06	0.81	6.10	0.81	6.19	0.81	8.56	1.30	10.13	1.63
	25	6.75	1.37	6.93	1.35	6.99	1.34	7.10	1.33	8.87	1.65	10.05	1.86
	29	7.56	1.97	7.76	1.94	7.82	1.93	7.95	1.91	9.09	2.05	9.85	2.14
	32	7.91	2.33	8.13	2.30	8.20	2.29	8.34	2.27	10.18	2.30	11.40	2.33
	35	8.05	2.59	8.28	2.57	8.35	2.56	8.50	2.55	9.02	2.51	9.37	2.49
	40	7.83	2.72	8.05	2.73	8.13	2.73	8.28	2.74	8.16	2.66	8.42	2.63
	43	7.40	2.72	7.62	2.77	7.70	2.79	7.85	2.83	7.99	2.77	8.08	2.76
	46	6.74	2.66	6.97	2.75	7.04	2.79	7.19	2.83	7.62	2.84	7.91	2.86
1.6 + 2.5 + 3.5	22	5.92	0.79	6.06	0.79	6.10	0.79	6.19	0.79	8.56	1.27	10.13	1.59
	25	6.75	1.34	6.93	1.32	6.99	1.31	7.10	1.30	8.87	1.61	10.05	1.81
	29	7.56	1.93	7.76	1.90	7.82	1.89	7.95	1.87	9.09	2.00	9.85	2.09
	32	7.91	2.27	8.13	2.24	8.20	2.23	8.34	2.21	10.18	2.25	11.40	2.27
	35	8.05	2.53	8.28	2.51	8.35	2.50	8.50	2.49	9.02	2.46	9.37	2.43
	40	7.83	2.65	8.05	2.66	8.13	2.66	8.28	2.67	8.16	2.60	8.42	2.57
	43	7.40	2.65	7.62	2.71	7.70	2.73	7.85	2.77	7.99	2.71	8.08	2.70
	46	6.74	2.59	6.97	2.69	7.04	2.72	7.19	2.76	7.62	2.77	7.91	2.79
1.6 + 2.5 + 4.2	22	6.06	0.81	6.20	0.81	6.25	0.81	6.34	0.81	8.76	1.30	10.37	1.63
	25	6.91	1.36	7.09	1.34	7.15	1.34	7.27	1.32	9.08	1.64	10.29	1.85
	29	7.74	1.97	7.94	1.94	8.01	1.93	8.14	1.91	9.30	2.04	10.08	2.13
	32	8.10	2.32	8.32	2.29	8.39	2.28	8.54	2.26	10.42	2.29	11.67	2.32
	35	8.24	2.58	8.47	2.56	8.55	2.55	8.70	2.54	9.23	2.50	9.59	2.48
	40	8.01	2.70	8.24	2.71	8.32	2.72	8.47	2.72	8.35	2.65	8.61	2.62
	43	7.57	2.70	7.80	2.76	7.88	2.78	8.03	2.82	8.18	2.76	8.27	2.75
	46	6.90	2.65	7.13	2.74	7.21	2.78	7.36	2.82	7.80	2.83	8.10	2.85
1.6 + 2.5 + 5.0	22	7.04	0.93	7.20	0.93	7.25	0.93	7.36	0.93	10.17	1.50	12.04	1.88
	25	8.02	1.58	8.23	1.55	8.30	1.55	8.44	1.53	10.54	1.90	11.95	2.14
	29	8.99	2.28	9.22	2.24	9.30	2.23	9.45	2.21	10.80	2.36	11.70	2.47
	32	9.40	2.68	9.66	2.65	9.74	2.64	9.91	2.61	12.09	2.65	13.54	2.68
	35	9.57	2.99	9.83	2.96	9.92	2.96	10.10	2.94	10.72	2.90	11.13	2.87
	40	9.30	3.13	9.57	3.14	9.65	3.15	9.83	3.15	9.70	3.07	10.00	3.04
	43	8.79	3.13	9.06	3.20	9.14	3.22	9.32	3.27	9.49	3.20	9.60	3.18
	46	8.01	3.06	8.28	3.18	8.37	3.21	8.54	3.26	9.06	3.28	9.40	3.30
1.6 + 2.5 + 6.0	22	7.45	1.11	7.63	1.11	7.68	1.11	7.80	1.11	10.77	1.78	12.75	2.23
	25	8.50	1.87	8.72	1.84	8.79	1.83	8.94	1.81	11.17	2.25	12.66	2.53
	29	9.52	2.69	9.77	2.65	9.85	2.64	10.01	2.61	11.44	2.80	12.40	2.92
	32	9.96	3.17	10.23	3.13	10.32	3.12	10.50	3.09	12.81	3.14	14.35	3.17
	35	10.13	3.53	10.42	3.51	10.51	3.50	10.70	3.48	11.36	3.43	11.79	3.40
	40	9.85	3.71	10.13	3.72	10.23	3.72	10.42	3.73	10.27	3.63	10.59	3.59
	43	9.31	3.71	9.59	3.79	9.69	3.81	9.88	3.87	10.06	3.79	10.17	3.77
	46	8.49	3.63	8.77	3.76	8.86	3.80	9.05	3.86	9.60	3.88	9.96	3.90

Combination (Capacity)	Outdoor Air Temp. °C DB	Indoor Air Temp. °C											
		27/16		27/17.5		27/18		27/19		27/22		27/24	
		Total Q	Input Power	Total Q	Input Power	Total Q	Input Power	Total Q	Input Power	Total Q	Input Power	Total Q	Input Power
1.6 + 2.5 + 7.1	22	7.45	1.06	7.63	1.06	7.68	1.06	7.80	1.06	10.77	1.71	12.75	2.14
	25	8.50	1.79	8.72	1.77	8.79	1.76	8.94	1.74	11.17	2.16	12.66	2.43
	29	9.52	2.58	9.77	2.55	9.85	2.53	10.01	2.51	11.44	2.68	12.40	2.80
	32	9.96	3.05	10.23	3.01	10.32	2.99	10.50	2.97	12.81	3.01	14.35	3.05
	35	10.13	3.39	10.42	3.37	10.51	3.36	10.70	3.34	11.36	3.29	11.79	3.26
	40	9.85	3.56	10.13	3.57	10.23	3.57	10.42	3.58	10.27	3.48	10.59	3.45
	43	9.31	3.56	9.59	3.63	9.69	3.66	9.88	3.71	10.06	3.63	10.17	3.62
	46	8.49	3.48	8.77	3.61	8.86	3.65	9.05	3.70	9.60	3.72	9.96	3.74
1.6 + 3.5 + 3.5	22	6.69	0.93	6.84	0.93	6.89	0.93	7.00	0.93	9.66	1.50	11.44	1.87
	25	7.62	1.57	7.82	1.55	7.89	1.54	8.02	1.53	10.02	1.89	11.35	2.13
	29	8.54	2.27	8.76	2.23	8.83	2.22	8.98	2.20	10.27	2.36	11.12	2.46
	32	8.94	2.67	9.18	2.64	9.26	2.63	9.42	2.60	11.49	2.64	12.87	2.67
	35	9.09	2.97	9.35	2.95	9.43	2.94	9.60	2.93	10.19	2.89	10.58	2.86
	40	8.84	3.12	9.09	3.13	9.18	3.14	9.35	3.14	9.22	3.06	9.50	3.03
	43	8.35	3.12	8.61	3.19	8.69	3.21	8.86	3.25	9.02	3.19	9.12	3.17
	46	7.61	3.05	7.87	3.17	7.95	3.20	8.12	3.25	8.61	3.26	8.94	3.28
1.6 + 3.5 + 4.2	22	7.04	1.06	7.20	1.06	7.25	1.06	7.36	1.06	10.17	1.70	12.04	2.13
	25	8.02	1.79	8.23	1.76	8.30	1.75	8.44	1.74	10.54	2.15	11.95	2.42
	29	8.99	2.58	9.22	2.54	9.30	2.53	9.45	2.50	10.80	2.68	11.70	2.79
	32	9.40	3.04	9.66	3.00	9.74	2.99	9.91	2.96	12.09	3.01	13.54	3.04
	35	9.57	3.38	9.83	3.36	9.92	3.35	10.10	3.33	10.72	3.28	11.13	3.25
	40	9.30	3.55	9.57	3.56	9.65	3.56	9.83	3.57	9.70	3.47	10.00	3.44
	43	8.79	3.55	9.06	3.62	9.14	3.65	9.32	3.70	9.49	3.62	9.60	3.61
	46	8.01	3.47	8.28	3.60	8.37	3.64	8.54	3.69	9.06	3.71	9.40	3.73
1.6 + 3.5 + 5.0	22	7.45	1.06	7.63	1.06	7.68	1.06	7.80	1.06	10.77	1.71	12.75	2.14
	25	8.50	1.79	8.72	1.77	8.79	1.76	8.94	1.74	11.17	2.16	12.66	2.43
	29	9.52	2.58	9.77	2.55	9.85	2.53	10.01	2.51	11.44	2.68	12.40	2.80
	32	9.96	3.05	10.23	3.01	10.32	2.99	10.50	2.97	12.81	3.01	14.35	3.05
	35	10.13	3.39	10.42	3.37	10.51	3.36	10.70	3.34	11.36	3.29	11.79	3.26
	40	9.85	3.56	10.13	3.57	10.23	3.57	10.42	3.58	10.27	3.48	10.59	3.45
	43	9.31	3.56	9.59	3.63	9.69	3.66	9.88	3.71	10.06	3.63	10.17	3.62
	46	8.49	3.48	8.77	3.61	8.86	3.65	9.05	3.70	9.60	3.72	9.96	3.74
1.6 + 3.5 + 6.0	22	7.45	1.06	7.63	1.06	7.68	1.06	7.80	1.06	10.77	1.71	12.75	2.14
	25	8.50	1.79	8.72	1.77	8.79	1.76	8.94	1.74	11.17	2.16	12.66	2.43
	29	9.52	2.58	9.77	2.55	9.85	2.53	10.01	2.51	11.44	2.68	12.40	2.80
	32	9.96	3.05	10.23	3.01	10.32	2.99	10.50	2.97	12.81	3.01	14.35	3.05
	35	10.13	3.39	10.42	3.37	10.51	3.36	10.70	3.34	11.36	3.29	11.79	3.26
	40	9.85	3.56	10.13	3.57	10.23	3.57	10.42	3.58	10.27	3.48	10.59	3.45
	43	9.31	3.56	9.59	3.63	9.69	3.66	9.88	3.71	10.06	3.63	10.17	3.62
	46	8.49	3.48	8.77	3.61	8.86	3.65	9.05	3.70	9.60	3.72	9.96	3.74

Combination (Capacity)	Outdoor Air Temp. °C DB	Indoor Air Temp. °C											
		27/16		27/17.5		27/18		27/19		27/22		27/24	
		Total Q	Input Power	Total Q	Input Power	Total Q	Input Power	Total Q	Input Power	Total Q	Input Power	Total Q	Input Power
1.6 + 3.5 + 7.1	22	7.45	1.02	7.63	1.02	7.68	1.02	7.80	1.02	10.77	1.64	12.75	2.05
	25	8.50	1.72	8.72	1.69	8.79	1.68	8.94	1.67	11.17	2.06	12.66	2.33
	29	9.52	2.48	9.77	2.44	9.85	2.43	10.01	2.40	11.44	2.57	12.40	2.69
	32	9.96	2.92	10.23	2.88	10.32	2.87	10.50	2.84	12.81	2.89	14.35	2.92
	35	10.13	3.25	10.42	3.22	10.51	3.22	10.70	3.20	11.36	3.16	11.79	3.13
	40	9.85	3.41	10.13	3.42	10.23	3.42	10.42	3.43	10.27	3.34	10.59	3.30
	43	9.31	3.41	9.59	3.48	9.69	3.51	9.88	3.55	10.06	3.48	10.17	3.46
	46	8.49	3.33	8.77	3.46	8.86	3.50	9.05	3.55	9.60	3.56	9.96	3.59
1.6 + 4.2 + 4.2	22	7.45	1.24	7.63	1.24	7.68	1.24	7.80	1.24	10.77	2.00	12.75	2.50
	25	8.50	2.10	8.72	2.07	8.79	2.06	8.94	2.04	11.17	2.52	12.66	2.85
	29	9.52	3.03	9.77	2.98	9.85	2.97	10.01	2.94	11.44	3.14	12.40	3.28
	32	9.96	3.57	10.23	3.52	10.32	3.51	10.50	3.48	12.81	3.53	14.35	3.57
	35	10.13	3.97	10.42	3.94	10.51	3.93	10.70	3.91	11.36	3.86	11.79	3.82
	40	9.85	4.16	10.13	4.18	10.23	4.18	10.42	4.19	10.27	4.08	10.59	4.04
	43	9.31	4.16	9.59	4.25	9.69	4.28	9.88	4.34	10.06	4.25	10.17	4.23
	46	8.49	4.07	8.77	4.22	8.86	4.27	9.05	4.33	9.60	4.36	9.96	4.38
1.6 + 4.2 + 5.0	22	7.45	1.06	7.63	1.06	7.68	1.06	7.80	1.06	10.77	1.71	12.75	2.14
	25	8.50	1.79	8.72	1.77	8.79	1.76	8.94	1.74	11.17	2.16	12.66	2.43
	29	9.52	2.58	9.77	2.55	9.85	2.53	10.01	2.51	11.44	2.68	12.40	2.80
	32	9.96	3.05	10.23	3.01	10.32	2.99	10.50	2.97	12.81	3.01	14.35	3.05
	35	10.13	3.39	10.42	3.37	10.51	3.36	10.70	3.34	11.36	3.29	11.79	3.26
	40	9.85	3.56	10.13	3.57	10.23	3.57	10.42	3.58	10.27	3.48	10.59	3.45
	43	9.31	3.56	9.59	3.63	9.69	3.66	9.88	3.71	10.06	3.63	10.17	3.62
	46	8.49	3.48	8.77	3.61	8.86	3.65	9.05	3.70	9.60	3.72	9.96	3.74
1.6 + 4.2 + 6.0	22	7.45	1.06	7.63	1.06	7.68	1.06	7.80	1.06	10.77	1.71	12.75	2.14
	25	8.50	1.79	8.72	1.77	8.79	1.76	8.94	1.74	11.17	2.16	12.66	2.43
	29	9.52	2.58	9.77	2.55	9.85	2.53	10.01	2.51	11.44	2.68	12.40	2.80
	32	9.96	3.05	10.23	3.01	10.32	2.99	10.50	2.97	12.81	3.01	14.35	3.05
	35	10.13	3.39	10.42	3.37	10.51	3.36	10.70	3.34	11.36	3.29	11.79	3.26
	40	9.85	3.56	10.13	3.57	10.23	3.57	10.42	3.58	10.27	3.48	10.59	3.45
	43	9.31	3.56	9.59	3.63	9.69	3.66	9.88	3.71	10.06	3.63	10.17	3.62
	46	8.49	3.48	8.77	3.61	8.86	3.65	9.05	3.70	9.60	3.72	9.96	3.74
1.6 + 4.2 + 7.1	22	7.45	1.02	7.63	1.02	7.68	1.02	7.80	1.02	10.77	1.64	12.75	2.05
	25	8.50	1.72	8.72	1.69	8.79	1.68	8.94	1.67	11.17	2.06	12.66	2.33
	29	9.52	2.48	9.77	2.44	9.85	2.43	10.01	2.40	11.44	2.57	12.40	2.69
	32	9.96	2.92	10.23	2.88	10.32	2.87	10.50	2.84	12.81	2.89	14.35	2.92
	35	10.13	3.25	10.42	3.22	10.51	3.22	10.70	3.20	11.36	3.16	11.79	3.13
	40	9.85	3.41	10.13	3.42	10.23	3.42	10.42	3.43	10.27	3.34	10.59	3.30
	43	9.31	3.41	9.59	3.48	9.69	3.51	9.88	3.55	10.06	3.48	10.17	3.46
	46	8.49	3.33	8.77	3.46	8.86	3.50	9.05	3.55	9.60	3.56	9.96	3.59

Combination (Capacity)	Outdoor Air Temp. °C DB	Indoor Air Temp. °C											
		27/16		27/17.5		27/18		27/19		27/22		27/24	
		Total Q	Input Power	Total Q	Input Power	Total Q	Input Power	Total Q	Input Power	Total Q	Input Power	Total Q	Input Power
1.6 + 5.0 + 5.0	22	7.45	0.93	7.63	0.93	7.68	0.93	7.80	0.93	10.77	1.50	12.75	1.88
	25	8.50	1.58	8.72	1.55	8.79	1.55	8.94	1.53	11.17	1.90	12.66	2.14
	29	9.52	2.28	9.77	2.24	9.85	2.23	10.01	2.21	11.44	2.36	12.40	2.47
	32	9.96	2.68	10.23	2.65	10.32	2.64	10.50	2.61	12.81	2.65	14.35	2.68
	35	10.13	2.99	10.42	2.96	10.51	2.96	10.70	2.94	11.36	2.90	11.79	2.87
	40	9.85	3.13	10.13	3.14	10.23	3.15	10.42	3.15	10.27	3.07	10.59	3.04
	43	9.31	3.13	9.59	3.20	9.69	3.22	9.88	3.27	10.06	3.20	10.17	3.18
	46	8.49	3.06	8.77	3.18	8.86	3.21	9.05	3.26	9.60	3.28	9.96	3.30
1.6 + 5.0 + 6.0	22	7.45	0.93	7.63	0.93	7.68	0.93	7.80	0.93	10.77	1.50	12.75	1.88
	25	8.50	1.58	8.72	1.55	8.79	1.55	8.94	1.53	11.17	1.90	12.66	2.14
	29	9.52	2.28	9.77	2.24	9.85	2.23	10.01	2.21	11.44	2.36	12.40	2.47
	32	9.96	2.68	10.23	2.65	10.32	2.64	10.50	2.61	12.81	2.65	14.35	2.68
	35	10.13	2.99	10.42	2.96	10.51	2.96	10.70	2.94	11.36	2.90	11.79	2.87
	40	9.85	3.13	10.13	3.14	10.23	3.15	10.42	3.15	10.27	3.07	10.59	3.04
	43	9.31	3.13	9.59	3.20	9.69	3.22	9.88	3.27	10.06	3.20	10.17	3.18
	46	8.49	3.06	8.77	3.18	8.86	3.21	9.05	3.26	9.60	3.28	9.96	3.30
1.6 + 5.0 + 7.1	22	7.45	0.91	7.63	0.91	7.68	0.91	7.80	0.91	10.77	1.47	12.75	1.84
	25	8.50	1.54	8.72	1.52	8.79	1.51	8.94	1.50	11.17	1.85	12.66	2.09
	29	9.52	2.22	9.77	2.19	9.85	2.18	10.01	2.16	11.44	2.31	12.40	2.41
	32	9.96	2.62	10.23	2.58	10.32	2.57	10.50	2.55	12.81	2.59	14.35	2.62
	35	10.13	2.91	10.42	2.89	10.51	2.88	10.70	2.87	11.36	2.83	11.79	2.80
	40	9.85	3.06	10.13	3.07	10.23	3.07	10.42	3.08	10.27	2.99	10.59	2.96
	43	9.31	3.06	9.59	3.12	9.69	3.14	9.88	3.19	10.06	3.12	10.17	3.11
	46	8.49	2.99	8.77	3.10	8.86	3.14	9.05	3.18	9.60	3.20	9.96	3.22
1.6 + 6.0 + 6.0	22	7.45	0.93	7.63	0.93	7.68	0.93	7.80	0.93	10.77	1.50	12.75	1.88
	25	8.50	1.58	8.72	1.55	8.79	1.55	8.94	1.53	11.17	1.90	12.66	2.14
	29	9.52	2.28	9.77	2.24	9.85	2.23	10.01	2.21	11.44	2.36	12.40	2.47
	32	9.96	2.68	10.23	2.65	10.32	2.64	10.50	2.61	12.81	2.65	14.35	2.68
	35	10.13	2.99	10.42	2.96	10.51	2.96	10.70	2.94	11.36	2.90	11.79	2.87
	40	9.85	3.13	10.13	3.14	10.23	3.15	10.42	3.15	10.27	3.07	10.59	3.04
	43	9.31	3.13	9.59	3.20	9.69	3.22	9.88	3.27	10.06	3.20	10.17	3.18
	46	8.49	3.06	8.77	3.18	8.86	3.21	9.05	3.26	9.60	3.28	9.96	3.30
1.6 + 6.0 + 7.1	22	7.45	0.91	7.63	0.91	7.68	0.91	7.80	0.91	10.77	1.47	12.75	1.84
	25	8.50	1.54	8.72	1.52	8.79	1.51	8.94	1.50	11.17	1.85	12.66	2.09
	29	9.52	2.22	9.77	2.19	9.85	2.18	10.01	2.16	11.44	2.31	12.40	2.41
	32	9.96	2.62	10.23	2.58	10.32	2.57	10.50	2.55	12.81	2.59	14.35	2.62
	35	10.13	2.91	10.42	2.89	10.51	2.88	10.70	2.87	11.36	2.83	11.79	2.80
	40	9.85	3.06	10.13	3.07	10.23	3.07	10.42	3.08	10.27	2.99	10.59	2.96
	43	9.31	3.06	9.59	3.12	9.69	3.14	9.88	3.19	10.06	3.12	10.17	3.11
	46	8.49	2.99	8.77	3.10	8.86	3.14	9.05	3.18	9.60	3.20	9.96	3.22



Combination (Capacity)	Outdoor Air Temp. °C DB	Indoor Air Temp. °C											
		27/16		27/17.5		27/18		27/19		27/22		27/24	
		Total Q	Input Power	Total Q	Input Power	Total Q	Input Power	Total Q	Input Power	Total Q	Input Power	Total Q	Input Power
1.6 + 7.1 + 7.1	22	7.45	0.89	7.63	0.89	7.68	0.89	7.80	0.89	10.77	1.44	12.75	1.80
	25	8.50	1.51	8.72	1.49	8.79	1.48	8.94	1.46	11.17	1.81	12.66	2.05
	29	9.52	2.17	9.77	2.14	9.85	2.13	10.01	2.11	11.44	2.26	12.40	2.36
	32	9.96	2.56	10.23	2.53	10.32	2.52	10.50	2.50	12.81	2.54	14.35	2.56
	35	10.13	2.85	10.42	2.83	10.51	2.82	10.70	2.81	11.36	2.77	11.79	2.75
	40	9.85	2.99	10.13	3.00	10.23	3.01	10.42	3.01	10.27	2.93	10.59	2.90
	43	9.31	2.99	9.59	3.06	9.69	3.08	9.88	3.12	10.06	3.06	10.17	3.04
	46	8.49	2.93	8.77	3.04	8.86	3.07	9.05	3.12	9.60	3.13	9.96	3.15
2.0 + 2.0 + 2.0	22	5.92	0.81	6.06	0.81	6.10	0.81	6.19	0.81	8.56	1.30	10.13	1.63
	25	6.75	1.37	6.93	1.35	6.99	1.34	7.10	1.33	8.87	1.65	10.05	1.86
	29	7.56	1.97	7.76	1.94	7.82	1.93	7.95	1.91	9.09	2.05	9.85	2.14
	32	7.91	2.33	8.13	2.30	8.20	2.29	8.34	2.27	10.18	2.30	11.40	2.33
	35	8.05	2.59	8.28	2.57	8.35	2.56	8.50	2.55	9.02	2.51	9.37	2.49
	40	7.83	2.72	8.05	2.73	8.13	2.73	8.28	2.74	8.16	2.66	8.42	2.63
	43	7.40	2.72	7.62	2.77	7.70	2.79	7.85	2.83	7.99	2.77	8.08	2.76
	46	6.74	2.66	6.97	2.75	7.04	2.79	7.19	2.83	7.62	2.84	7.91	2.86
2.0 + 2.0 + 2.5	22	5.92	0.81	6.06	0.81	6.10	0.81	6.19	0.81	8.56	1.30	10.13	1.63
	25	6.75	1.37	6.93	1.35	6.99	1.34	7.10	1.33	8.87	1.65	10.05	1.86
	29	7.56	1.97	7.76	1.94	7.82	1.93	7.95	1.91	9.09	2.05	9.85	2.14
	32	7.91	2.33	8.13	2.30	8.20	2.29	8.34	2.27	10.18	2.30	11.40	2.33
	35	8.05	2.59	8.28	2.57	8.35	2.56	8.50	2.55	9.02	2.51	9.37	2.49
	40	7.83	2.72	8.05	2.73	8.13	2.73	8.28	2.74	8.16	2.66	8.42	2.63
	43	7.40	2.72	7.62	2.77	7.70	2.79	7.85	2.83	7.99	2.77	8.08	2.76
	46	6.74	2.66	6.97	2.75	7.04	2.79	7.19	2.83	7.62	2.84	7.91	2.86
2.0 + 2.0 + 3.5	22	5.92	0.79	6.06	0.79	6.10	0.79	6.19	0.79	8.56	1.27	10.13	1.59
	25	6.75	1.34	6.93	1.32	6.99	1.31	7.10	1.30	8.87	1.61	10.05	1.81
	29	7.56	1.93	7.76	1.90	7.82	1.89	7.95	1.87	9.09	2.00	9.85	2.09
	32	7.91	2.27	8.13	2.24	8.20	2.23	8.34	2.21	10.18	2.25	11.40	2.27
	35	8.05	2.53	8.28	2.51	8.35	2.50	8.50	2.49	9.02	2.46	9.37	2.43
	40	7.83	2.65	8.05	2.66	8.13	2.66	8.28	2.67	8.16	2.60	8.42	2.57
	43	7.40	2.65	7.62	2.71	7.70	2.73	7.85	2.77	7.99	2.71	8.08	2.70
	46	6.74	2.59	6.97	2.69	7.04	2.72	7.19	2.76	7.62	2.77	7.91	2.79
2.0 + 2.0 + 4.2	22	6.06	0.81	6.20	0.81	6.25	0.81	6.34	0.81	8.76	1.30	10.37	1.63
	25	6.91	1.36	7.09	1.34	7.15	1.34	7.27	1.32	9.08	1.64	10.29	1.85
	29	7.74	1.97	7.94	1.94	8.01	1.93	8.14	1.91	9.30	2.04	10.08	2.13
	32	8.10	2.32	8.32	2.29	8.39	2.28	8.54	2.26	10.42	2.29	11.67	2.32
	35	8.24	2.58	8.47	2.56	8.55	2.55	8.70	2.54	9.23	2.50	9.59	2.48
	40	8.01	2.70	8.24	2.71	8.32	2.72	8.47	2.72	8.35	2.65	8.61	2.62
	43	7.57	2.70	7.80	2.76	7.88	2.78	8.03	2.82	8.18	2.76	8.27	2.75
	46	6.90	2.65	7.13	2.74	7.21	2.78	7.36	2.82	7.80	2.83	8.10	2.85

Combination (Capacity)	Outdoor Air Temp. °C DB	Indoor Air Temp. °C											
		27/16		27/17.5		27/18		27/19		27/22		27/24	
		Total Q	Input Power	Total Q	Input Power	Total Q	Input Power	Total Q	Input Power	Total Q	Input Power	Total Q	Input Power
2.0 + 2.0 + 5.0	22	6.69	0.83	6.84	0.83	6.89	0.83	7.00	0.83	9.66	1.34	11.44	1.68
	25	7.62	1.41	7.82	1.39	7.89	1.38	8.02	1.37	10.02	1.69	11.35	1.91
	29	8.54	2.03	8.76	2.00	8.83	1.99	8.98	1.97	10.27	2.11	11.12	2.20
	32	8.94	2.39	9.18	2.36	9.26	2.35	9.42	2.33	11.49	2.37	12.87	2.39
	35	9.09	2.66	9.35	2.64	9.43	2.63	9.60	2.62	10.19	2.58	10.58	2.56
	40	8.84	2.79	9.09	2.80	9.18	2.80	9.35	2.81	9.22	2.73	9.50	2.71
	43	8.35	2.79	8.61	2.85	8.69	2.87	8.86	2.91	9.02	2.85	9.12	2.84
	46	7.61	2.73	7.87	2.83	7.95	2.86	8.12	2.90	8.61	2.92	8.94	2.94
2.0 + 2.0 + 6.0	22	7.45	1.08	7.63	1.08	7.68	1.08	7.80	1.08	10.77	1.74	12.75	2.18
	25	8.50	1.83	8.72	1.80	8.79	1.79	8.94	1.78	11.17	2.20	12.66	2.48
	29	9.52	2.64	9.77	2.60	9.85	2.59	10.01	2.56	11.44	2.74	12.40	2.86
	32	9.96	3.11	10.23	3.07	10.32	3.06	10.50	3.03	12.81	3.08	14.35	3.11
	35	10.13	3.46	10.42	3.44	10.51	3.43	10.70	3.41	11.36	3.36	11.79	3.33
	40	9.85	3.63	10.13	3.64	10.23	3.65	10.42	3.66	10.27	3.56	10.59	3.52
	43	9.31	3.63	9.59	3.71	9.69	3.74	9.88	3.79	10.06	3.71	10.17	3.69
	46	8.49	3.55	8.77	3.68	8.86	3.73	9.05	3.78	9.60	3.80	9.96	3.82
2.0 + 2.0 + 7.1	22	7.45	1.04	7.63	1.04	7.68	1.04	7.80	1.04	10.77	1.67	12.75	2.09
	25	8.50	1.75	8.72	1.73	8.79	1.72	8.94	1.70	11.17	2.11	12.66	2.38
	29	9.52	2.53	9.77	2.49	9.85	2.48	10.01	2.46	11.44	2.63	12.40	2.74
	32	9.96	2.98	10.23	2.94	10.32	2.93	10.50	2.91	12.81	2.95	14.35	2.98
	35	10.13	3.32	10.42	3.30	10.51	3.29	10.70	3.27	11.36	3.22	11.79	3.19
	40	9.85	3.48	10.13	3.49	10.23	3.50	10.42	3.51	10.27	3.41	10.59	3.38
	43	9.31	3.48	9.59	3.56	9.69	3.58	9.88	3.63	10.06	3.56	10.17	3.54
	46	8.49	3.41	8.77	3.53	8.86	3.57	9.05	3.63	9.60	3.64	9.96	3.67
2.0 + 2.5 + 2.5	22	5.92	0.81	6.06	0.81	6.10	0.81	6.19	0.81	8.56	1.30	10.13	1.63
	25	6.75	1.37	6.93	1.35	6.99	1.34	7.10	1.33	8.87	1.65	10.05	1.86
	29	7.56	1.97	7.76	1.94	7.82	1.93	7.95	1.91	9.09	2.05	9.85	2.14
	32	7.91	2.33	8.13	2.30	8.20	2.29	8.34	2.27	10.18	2.30	11.40	2.33
	35	8.05	2.59	8.28	2.57	8.35	2.56	8.50	2.55	9.02	2.51	9.37	2.49
	40	7.83	2.72	8.05	2.73	8.13	2.73	8.28	2.74	8.16	2.66	8.42	2.63
	43	7.40	2.72	7.62	2.77	7.70	2.79	7.85	2.83	7.99	2.77	8.08	2.76
	46	6.74	2.66	6.97	2.75	7.04	2.79	7.19	2.83	7.62	2.84	7.91	2.86
2.0 + 2.5 + 3.5	22	5.92	0.79	6.06	0.79	6.10	0.79	6.19	0.79	8.56	1.27	10.13	1.59
	25	6.75	1.34	6.93	1.32	6.99	1.31	7.10	1.30	8.87	1.61	10.05	1.81
	29	7.56	1.93	7.76	1.90	7.82	1.89	7.95	1.87	9.09	2.00	9.85	2.09
	32	7.91	2.27	8.13	2.24	8.20	2.23	8.34	2.21	10.18	2.25	11.40	2.27
	35	8.05	2.53	8.28	2.51	8.35	2.50	8.50	2.49	9.02	2.46	9.37	2.43
	40	7.83	2.65	8.05	2.66	8.13	2.66	8.28	2.67	8.16	2.60	8.42	2.57
	43	7.40	2.65	7.62	2.71	7.70	2.73	7.85	2.77	7.99	2.71	8.08	2.70
	46	6.74	2.59	6.97	2.69	7.04	2.72	7.19	2.76	7.62	2.77	7.91	2.79

Combination (Capacity)	Outdoor Air Temp. °C DB	Indoor Air Temp. °C											
		27/16		27/17.5		27/18		27/19		27/22		27/24	
		Total Q	Input Power	Total Q	Input Power	Total Q	Input Power	Total Q	Input Power	Total Q	Input Power	Total Q	Input Power
2.0 + 2.5 + 4.2	22	6.69	0.95	6.84	0.95	6.89	0.95	7.00	0.95	9.66	1.53	11.44	1.92
	25	7.62	1.61	7.82	1.59	7.89	1.58	8.02	1.56	10.02	1.94	11.35	2.18
	29	8.54	2.32	8.76	2.29	8.83	2.28	8.98	2.25	10.27	2.41	11.12	2.52
	32	8.94	2.74	9.18	2.70	9.26	2.69	9.42	2.67	11.49	2.71	12.87	2.74
	35	9.09	3.05	9.35	3.02	9.43	3.02	9.60	3.00	10.19	2.96	10.58	2.93
	40	8.84	3.19	9.09	3.21	9.18	3.21	9.35	3.22	9.22	3.13	9.50	3.10
	43	8.35	3.19	8.61	3.26	8.69	3.29	8.86	3.33	9.02	3.26	9.12	3.25
	46	7.61	3.13	7.87	3.24	7.95	3.28	8.12	3.33	8.61	3.34	8.94	3.36
2.0 + 2.5 + 5.0	22	7.04	0.93	7.20	0.93	7.25	0.93	7.36	0.93	10.17	1.50	12.04	1.88
	25	8.02	1.58	8.23	1.55	8.30	1.55	8.44	1.53	10.54	1.90	11.95	2.14
	29	8.99	2.28	9.22	2.24	9.30	2.23	9.45	2.21	10.80	2.36	11.70	2.47
	32	9.40	2.68	9.66	2.65	9.74	2.64	9.91	2.61	12.09	2.65	13.54	2.68
	35	9.57	2.99	9.83	2.96	9.92	2.96	10.10	2.94	10.72	2.90	11.13	2.87
	40	9.30	3.13	9.57	3.14	9.65	3.15	9.83	3.15	9.70	3.07	10.00	3.04
	43	8.79	3.13	9.06	3.20	9.14	3.22	9.32	3.27	9.49	3.20	9.60	3.18
	46	8.01	3.06	8.28	3.18	8.37	3.21	8.54	3.26	9.06	3.28	9.40	3.30
2.0 + 2.5 + 6.0	22	7.45	1.08	7.63	1.08	7.68	1.08	7.80	1.08	10.77	1.74	12.75	2.18
	25	8.50	1.83	8.72	1.80	8.79	1.79	8.94	1.78	11.17	2.20	12.66	2.48
	29	9.52	2.64	9.77	2.60	9.85	2.59	10.01	2.56	11.44	2.74	12.40	2.86
	32	9.96	3.11	10.23	3.07	10.32	3.06	10.50	3.03	12.81	3.08	14.35	3.11
	35	10.13	3.46	10.42	3.44	10.51	3.43	10.70	3.41	11.36	3.36	11.79	3.33
	40	9.85	3.63	10.13	3.64	10.23	3.65	10.42	3.66	10.27	3.56	10.59	3.52
	43	9.31	3.63	9.59	3.71	9.69	3.74	9.88	3.79	10.06	3.71	10.17	3.69
	46	8.49	3.55	8.77	3.68	8.86	3.73	9.05	3.78	9.60	3.80	9.96	3.82
2.0 + 2.5 + 7.1	22	7.45	1.04	7.63	1.04	7.68	1.04	7.80	1.04	10.77	1.67	12.75	2.09
	25	8.50	1.75	8.72	1.73	8.79	1.72	8.94	1.70	11.17	2.11	12.66	2.38
	29	9.52	2.53	9.77	2.49	9.85	2.48	10.01	2.46	11.44	2.63	12.40	2.74
	32	9.96	2.98	10.23	2.94	10.32	2.93	10.50	2.91	12.81	2.95	14.35	2.98
	35	10.13	3.32	10.42	3.30	10.51	3.29	10.70	3.27	11.36	3.22	11.79	3.19
	40	9.85	3.48	10.13	3.49	10.23	3.50	10.42	3.51	10.27	3.41	10.59	3.38
	43	9.31	3.48	9.59	3.56	9.69	3.58	9.88	3.63	10.06	3.56	10.17	3.54
	46	8.49	3.41	8.77	3.53	8.86	3.57	9.05	3.63	9.60	3.64	9.96	3.67
2.0 + 3.5 + 3.5	22	6.69	0.93	6.84	0.93	6.89	0.93	7.00	0.93	9.66	1.50	11.44	1.87
	25	7.62	1.57	7.82	1.55	7.89	1.54	8.02	1.53	10.02	1.89	11.35	2.13
	29	8.54	2.27	8.76	2.23	8.83	2.22	8.98	2.20	10.27	2.36	11.12	2.46
	32	8.94	2.67	9.18	2.64	9.26	2.63	9.42	2.60	11.49	2.64	12.87	2.67
	35	9.09	2.97	9.35	2.95	9.43	2.94	9.60	2.93	10.19	2.89	10.58	2.86
	40	8.84	3.12	9.09	3.13	9.18	3.14	9.35	3.14	9.22	3.06	9.50	3.03
	43	8.35	3.12	8.61	3.19	8.69	3.21	8.86	3.25	9.02	3.19	9.12	3.17
	46	7.61	3.05	7.87	3.17	7.95	3.20	8.12	3.25	8.61	3.26	8.94	3.28

Combination (Capacity)	Outdoor Air Temp. °C DB	Indoor Air Temp. °C											
		27/16		27/17.5		27/18		27/19		27/22		27/24	
		Total Q	Input Power	Total Q	Input Power	Total Q	Input Power	Total Q	Input Power	Total Q	Input Power	Total Q	Input Power
2.0 + 3.5 + 4.2	22	7.45	1.24	7.63	1.24	7.68	1.24	7.80	1.24	10.77	2.00	12.75	2.50
	25	8.50	2.10	8.72	2.07	8.79	2.06	8.94	2.04	11.17	2.52	12.66	2.85
	29	9.52	3.03	9.77	2.98	9.85	2.97	10.01	2.94	11.44	3.14	12.40	3.28
	32	9.96	3.57	10.23	3.52	10.32	3.51	10.50	3.48	12.81	3.53	14.35	3.57
	35	10.13	3.97	10.42	3.94	10.51	3.93	10.70	3.91	11.36	3.86	11.79	3.82
	40	9.85	4.16	10.13	4.18	10.23	4.18	10.42	4.19	10.27	4.08	10.59	4.04
	43	9.31	4.16	9.59	4.25	9.69	4.28	9.88	4.34	10.06	4.25	10.17	4.23
	46	8.49	4.07	8.77	4.22	8.86	4.27	9.05	4.33	9.60	4.36	9.96	4.38
2.0 + 3.5 + 5.0	22	7.45	1.06	7.63	1.06	7.68	1.06	7.80	1.06	10.77	1.71	12.75	2.14
	25	8.50	1.79	8.72	1.77	8.79	1.76	8.94	1.74	11.17	2.16	12.66	2.43
	29	9.52	2.58	9.77	2.55	9.85	2.53	10.01	2.51	11.44	2.68	12.40	2.80
	32	9.96	3.05	10.23	3.01	10.32	2.99	10.50	2.97	12.81	3.01	14.35	3.05
	35	10.13	3.39	10.42	3.37	10.51	3.36	10.70	3.34	11.36	3.29	11.79	3.26
	40	9.85	3.56	10.13	3.57	10.23	3.57	10.42	3.58	10.27	3.48	10.59	3.45
	43	9.31	3.56	9.59	3.63	9.69	3.66	9.88	3.71	10.06	3.63	10.17	3.62
	46	8.49	3.48	8.77	3.61	8.86	3.65	9.05	3.70	9.60	3.72	9.96	3.74
2.0 + 3.5 + 6.0	22	7.45	1.06	7.63	1.06	7.68	1.06	7.80	1.06	10.77	1.71	12.75	2.14
	25	8.50	1.79	8.72	1.77	8.79	1.76	8.94	1.74	11.17	2.16	12.66	2.43
	29	9.52	2.58	9.77	2.55	9.85	2.53	10.01	2.51	11.44	2.68	12.40	2.80
	32	9.96	3.05	10.23	3.01	10.32	2.99	10.50	2.97	12.81	3.01	14.35	3.05
	35	10.13	3.39	10.42	3.37	10.51	3.36	10.70	3.34	11.36	3.29	11.79	3.26
	40	9.85	3.56	10.13	3.57	10.23	3.57	10.42	3.58	10.27	3.48	10.59	3.45
	43	9.31	3.56	9.59	3.63	9.69	3.66	9.88	3.71	10.06	3.63	10.17	3.62
	46	8.49	3.48	8.77	3.61	8.86	3.65	9.05	3.70	9.60	3.72	9.96	3.74
2.0 + 3.5 + 7.1	22	7.45	1.02	7.63	1.02	7.68	1.02	7.80	1.02	10.77	1.64	12.75	2.05
	25	8.50	1.72	8.72	1.69	8.79	1.68	8.94	1.67	11.17	2.06	12.66	2.33
	29	9.52	2.48	9.77	2.44	9.85	2.43	10.01	2.40	11.44	2.57	12.40	2.69
	32	9.96	2.92	10.23	2.88	10.32	2.87	10.50	2.84	12.81	2.89	14.35	2.92
	35	10.13	3.25	10.42	3.22	10.51	3.22	10.70	3.20	11.36	3.16	11.79	3.13
	40	9.85	3.41	10.13	3.42	10.23	3.42	10.42	3.43	10.27	3.34	10.59	3.30
	43	9.31	3.41	9.59	3.48	9.69	3.51	9.88	3.55	10.06	3.48	10.17	3.46
	46	8.49	3.33	8.77	3.46	8.86	3.50	9.05	3.55	9.60	3.56	9.96	3.59
2.0 + 4.2 + 4.2	22	7.45	1.24	7.63	1.24	7.68	1.24	7.80	1.24	10.77	2.00	12.75	2.50
	25	8.50	2.10	8.72	2.07	8.79	2.06	8.94	2.04	11.17	2.52	12.66	2.85
	29	9.52	3.03	9.77	2.98	9.85	2.97	10.01	2.94	11.44	3.14	12.40	3.28
	32	9.96	3.57	10.23	3.52	10.32	3.51	10.50	3.48	12.81	3.53	14.35	3.57
	35	10.13	3.97	10.42	3.94	10.51	3.93	10.70	3.91	11.36	3.86	11.79	3.82
	40	9.85	4.16	10.13	4.18	10.23	4.18	10.42	4.19	10.27	4.08	10.59	4.04
	43	9.31	4.16	9.59	4.25	9.69	4.28	9.88	4.34	10.06	4.25	10.17	4.23
	46	8.49	4.07	8.77	4.22	8.86	4.27	9.05	4.33	9.60	4.36	9.96	4.38

Combination (Capacity)	Outdoor Air Temp. °C DB	Indoor Air Temp. °C											
		27/16		27/17.5		27/18		27/19		27/22		27/24	
		Total Q	Input Power	Total Q	Input Power	Total Q	Input Power	Total Q	Input Power	Total Q	Input Power	Total Q	Input Power
2.0 + 4.2 + 5.0	22	7.45	1.04	7.63	1.04	7.68	1.04	7.80	1.04	10.77	1.67	12.75	2.09
	25	8.50	1.75	8.72	1.73	8.79	1.72	8.94	1.70	11.17	2.11	12.66	2.38
	29	9.52	2.53	9.77	2.49	9.85	2.48	10.01	2.46	11.44	2.63	12.40	2.74
	32	9.96	2.98	10.23	2.94	10.32	2.93	10.50	2.91	12.81	2.95	14.35	2.98
	35	10.13	3.32	10.42	3.30	10.51	3.29	10.70	3.27	11.36	3.22	11.79	3.19
	40	9.85	3.48	10.13	3.49	10.23	3.50	10.42	3.51	10.27	3.41	10.59	3.38
	43	9.31	3.48	9.59	3.56	9.69	3.58	9.88	3.63	10.06	3.56	10.17	3.54
	46	8.49	3.41	8.77	3.53	8.86	3.57	9.05	3.63	9.60	3.64	9.96	3.67
2.0 + 4.2 + 6.0	22	7.45	1.04	7.63	1.04	7.68	1.04	7.80	1.04	10.77	1.67	12.75	2.09
	25	8.50	1.75	8.72	1.73	8.79	1.72	8.94	1.70	11.17	2.11	12.66	2.38
	29	9.52	2.53	9.77	2.49	9.85	2.48	10.01	2.46	11.44	2.63	12.40	2.74
	32	9.96	2.98	10.23	2.94	10.32	2.93	10.50	2.91	12.81	2.95	14.35	2.98
	35	10.13	3.32	10.42	3.30	10.51	3.29	10.70	3.27	11.36	3.22	11.79	3.19
	40	9.85	3.48	10.13	3.49	10.23	3.50	10.42	3.51	10.27	3.41	10.59	3.38
	43	9.31	3.48	9.59	3.56	9.69	3.58	9.88	3.63	10.06	3.56	10.17	3.54
	46	8.49	3.41	8.77	3.53	8.86	3.57	9.05	3.63	9.60	3.64	9.96	3.67
2.0 + 4.2 + 7.1	22	7.45	1.02	7.63	1.02	7.68	1.02	7.80	1.02	10.77	1.64	12.75	2.05
	25	8.50	1.72	8.72	1.69	8.79	1.68	8.94	1.67	11.17	2.06	12.66	2.33
	29	9.52	2.48	9.77	2.44	9.85	2.43	10.01	2.40	11.44	2.57	12.40	2.69
	32	9.96	2.92	10.23	2.88	10.32	2.87	10.50	2.84	12.81	2.89	14.35	2.92
	35	10.13	3.25	10.42	3.22	10.51	3.22	10.70	3.20	11.36	3.16	11.79	3.13
	40	9.85	3.41	10.13	3.42	10.23	3.42	10.42	3.43	10.27	3.34	10.59	3.30
	43	9.31	3.41	9.59	3.48	9.69	3.51	9.88	3.55	10.06	3.48	10.17	3.46
	46	8.49	3.33	8.77	3.46	8.86	3.50	9.05	3.55	9.60	3.56	9.96	3.59
2.0 + 5.0 + 5.0	22	7.45	0.93	7.63	0.93	7.68	0.93	7.80	0.93	10.77	1.50	12.75	1.88
	25	8.50	1.58	8.72	1.55	8.79	1.55	8.94	1.53	11.17	1.90	12.66	2.14
	29	9.52	2.28	9.77	2.24	9.85	2.23	10.01	2.21	11.44	2.36	12.40	2.47
	32	9.96	2.68	10.23	2.65	10.32	2.64	10.50	2.61	12.81	2.65	14.35	2.68
	35	10.13	2.99	10.42	2.96	10.51	2.96	10.70	2.94	11.36	2.90	11.79	2.87
	40	9.85	3.13	10.13	3.14	10.23	3.15	10.42	3.15	10.27	3.07	10.59	3.04
	43	9.31	3.13	9.59	3.20	9.69	3.22	9.88	3.27	10.06	3.20	10.17	3.18
	46	8.49	3.06	8.77	3.18	8.86	3.21	9.05	3.26	9.60	3.28	9.96	3.30
2.0 + 5.0 + 6.0	22	7.45	0.93	7.63	0.93	7.68	0.93	7.80	0.93	10.77	1.50	12.75	1.88
	25	8.50	1.58	8.72	1.55	8.79	1.55	8.94	1.53	11.17	1.90	12.66	2.14
	29	9.52	2.28	9.77	2.24	9.85	2.23	10.01	2.21	11.44	2.36	12.40	2.47
	32	9.96	2.68	10.23	2.65	10.32	2.64	10.50	2.61	12.81	2.65	14.35	2.68
	35	10.13	2.99	10.42	2.96	10.51	2.96	10.70	2.94	11.36	2.90	11.79	2.87
	40	9.85	3.13	10.13	3.14	10.23	3.15	10.42	3.15	10.27	3.07	10.59	3.04
	43	9.31	3.13	9.59	3.20	9.69	3.22	9.88	3.27	10.06	3.20	10.17	3.18
	46	8.49	3.06	8.77	3.18	8.86	3.21	9.05	3.26	9.60	3.28	9.96	3.30

Combination (Capacity)	Outdoor Air Temp. °C DB	Indoor Air Temp. °C											
		27/16		27/17.5		27/18		27/19		27/22		27/24	
		Total Q	Input Power	Total Q	Input Power	Total Q	Input Power	Total Q	Input Power	Total Q	Input Power	Total Q	Input Power
2.0 + 5.0 + 7.1	22	7.45	0.91	7.63	0.91	7.68	0.91	7.80	0.91	10.77	1.47	12.75	1.84
	25	8.50	1.54	8.72	1.52	8.79	1.51	8.94	1.50	11.17	1.85	12.66	2.09
	29	9.52	2.22	9.77	2.19	9.85	2.18	10.01	2.16	11.44	2.31	12.40	2.41
	32	9.96	2.62	10.23	2.58	10.32	2.57	10.50	2.55	12.81	2.59	14.35	2.62
	35	10.13	2.91	10.42	2.89	10.51	2.88	10.70	2.87	11.36	2.83	11.79	2.80
	40	9.85	3.06	10.13	3.07	10.23	3.07	10.42	3.08	10.27	2.99	10.59	2.96
	43	9.31	3.06	9.59	3.12	9.69	3.14	9.88	3.19	10.06	3.12	10.17	3.11
	46	8.49	2.99	8.77	3.10	8.86	3.14	9.05	3.18	9.60	3.20	9.96	3.22
2.0 + 6.0 + 6.0	22	7.45	0.93	7.63	0.93	7.68	0.93	7.80	0.93	10.77	1.50	12.75	1.88
	25	8.50	1.58	8.72	1.55	8.79	1.55	8.94	1.53	11.17	1.90	12.66	2.14
	29	9.52	2.28	9.77	2.24	9.85	2.23	10.01	2.21	11.44	2.36	12.40	2.47
	32	9.96	2.68	10.23	2.65	10.32	2.64	10.50	2.61	12.81	2.65	14.35	2.68
	35	10.13	2.99	10.42	2.96	10.51	2.96	10.70	2.94	11.36	2.90	11.79	2.87
	40	9.85	3.13	10.13	3.14	10.23	3.15	10.42	3.15	10.27	3.07	10.59	3.04
	43	9.31	3.13	9.59	3.20	9.69	3.22	9.88	3.27	10.06	3.20	10.17	3.18
	46	8.49	3.06	8.77	3.18	8.86	3.21	9.05	3.26	9.60	3.28	9.96	3.30
2.0 + 6.0 + 7.1	22	7.45	0.91	7.63	0.91	7.68	0.91	7.80	0.91	10.77	1.47	12.75	1.84
	25	8.50	1.54	8.72	1.52	8.79	1.51	8.94	1.50	11.17	1.85	12.66	2.09
	29	9.52	2.22	9.77	2.19	9.85	2.18	10.01	2.16	11.44	2.31	12.40	2.41
	32	9.96	2.62	10.23	2.58	10.32	2.57	10.50	2.55	12.81	2.59	14.35	2.62
	35	10.13	2.91	10.42	2.89	10.51	2.88	10.70	2.87	11.36	2.83	11.79	2.80
	40	9.85	3.06	10.13	3.07	10.23	3.07	10.42	3.08	10.27	2.99	10.59	2.96
	43	9.31	3.06	9.59	3.12	9.69	3.14	9.88	3.19	10.06	3.12	10.17	3.11
	46	8.49	2.99	8.77	3.10	8.86	3.14	9.05	3.18	9.60	3.20	9.96	3.22
2.0 + 7.1 + 7.1	22	7.45	0.89	7.63	0.89	7.68	0.89	7.80	0.89	10.77	1.44	12.75	1.80
	25	8.50	1.51	8.72	1.49	8.79	1.48	8.94	1.46	11.17	1.81	12.66	2.05
	29	9.52	2.17	9.77	2.14	9.85	2.13	10.01	2.11	11.44	2.26	12.40	2.36
	32	9.96	2.56	10.23	2.53	10.32	2.52	10.50	2.50	12.81	2.54	14.35	2.56
	35	10.13	2.85	10.42	2.83	10.51	2.82	10.70	2.81	11.36	2.77	11.79	2.75
	40	9.85	2.99	10.13	3.00	10.23	3.01	10.42	3.01	10.27	2.93	10.59	2.90
	43	9.31	2.99	9.59	3.06	9.69	3.08	9.88	3.12	10.06	3.06	10.17	3.04
	46	8.49	2.93	8.77	3.04	8.86	3.07	9.05	3.12	9.60	3.13	9.96	3.15
2.5 + 2.5 + 2.5	22	5.92	0.81	6.06	0.81	6.10	0.81	6.19	0.81	8.56	1.30	10.13	1.63
	25	6.75	1.37	6.93	1.35	6.99	1.34	7.10	1.33	8.87	1.65	10.05	1.86
	29	7.56	1.97	7.76	1.94	7.82	1.93	7.95	1.91	9.09	2.05	9.85	2.14
	32	7.91	2.33	8.13	2.30	8.20	2.29	8.34	2.27	10.18	2.30	11.40	2.33
	35	8.05	2.59	8.28	2.57	8.35	2.56	8.50	2.55	9.02	2.51	9.37	2.49
	40	7.83	2.72	8.05	2.73	8.13	2.73	8.28	2.74	8.16	2.66	8.42	2.63
	43	7.40	2.72	7.62	2.77	7.70	2.79	7.85	2.83	7.99	2.77	8.08	2.76
	46	6.74	2.66	6.97	2.75	7.04	2.79	7.19	2.83	7.62	2.84	7.91	2.86

Combination (Capacity)	Outdoor Air Temp. °C DB	Indoor Air Temp. °C											
		27/16		27/17.5		27/18		27/19		27/22		27/24	
		Total Q	Input Power	Total Q	Input Power	Total Q	Input Power	Total Q	Input Power	Total Q	Input Power	Total Q	Input Power
2.5 + 2.5 + 3.5	22	6.69	0.95	6.84	0.95	6.89	0.95	7.00	0.95	9.66	1.53	11.44	1.92
	25	7.62	1.61	7.82	1.59	7.89	1.58	8.02	1.56	10.02	1.94	11.35	2.18
	29	8.54	2.32	8.76	2.29	8.83	2.28	8.98	2.25	10.27	2.41	11.12	2.52
	32	8.94	2.74	9.18	2.70	9.26	2.69	9.42	2.67	11.49	2.71	12.87	2.74
	35	9.09	3.05	9.35	3.02	9.43	3.02	9.60	3.00	10.19	2.96	10.58	2.93
	40	8.84	3.19	9.09	3.21	9.18	3.21	9.35	3.22	9.22	3.13	9.50	3.10
	43	8.35	3.19	8.61	3.26	8.69	3.29	8.86	3.33	9.02	3.26	9.12	3.25
	46	7.61	3.13	7.87	3.24	7.95	3.28	8.12	3.33	8.61	3.34	8.94	3.36
2.5 + 2.5 + 4.2	22	7.04	1.08	7.20	1.08	7.25	1.08	7.36	1.08	10.17	1.74	12.04	2.18
	25	8.02	1.82	8.23	1.80	8.30	1.79	8.44	1.77	10.54	2.19	11.95	2.48
	29	8.99	2.63	9.22	2.59	9.30	2.58	9.45	2.55	10.80	2.73	11.70	2.85
	32	9.40	3.10	9.66	3.06	9.74	3.05	9.91	3.02	12.09	3.07	13.54	3.10
	35	9.57	3.45	9.83	3.43	9.92	3.42	10.10	3.40	10.72	3.35	11.13	3.32
	40	9.30	3.62	9.57	3.63	9.65	3.64	9.83	3.65	9.70	3.55	10.00	3.51
	43	8.79	3.62	9.06	3.70	9.14	3.73	9.32	3.78	9.49	3.70	9.60	3.68
	46	8.01	3.54	8.28	3.67	8.37	3.72	8.54	3.77	9.06	3.79	9.40	3.81
2.5 + 2.5 + 5.0	22	7.45	1.08	7.63	1.08	7.68	1.08	7.80	1.08	10.77	1.74	12.75	2.18
	25	8.50	1.83	8.72	1.80	8.79	1.79	8.94	1.78	11.17	2.20	12.66	2.48
	29	9.52	2.64	9.77	2.60	9.85	2.59	10.01	2.56	11.44	2.74	12.40	2.86
	32	9.96	3.11	10.23	3.07	10.32	3.06	10.50	3.03	12.81	3.08	14.35	3.11
	35	10.13	3.46	10.42	3.44	10.51	3.43	10.70	3.41	11.36	3.36	11.79	3.33
	40	9.85	3.63	10.13	3.64	10.23	3.65	10.42	3.66	10.27	3.56	10.59	3.52
	43	9.31	3.63	9.59	3.71	9.69	3.74	9.88	3.79	10.06	3.71	10.17	3.69
	46	8.49	3.55	8.77	3.68	8.86	3.73	9.05	3.78	9.60	3.80	9.96	3.82
2.5 + 2.5 + 6.0	22	7.45	1.08	7.63	1.08	7.68	1.08	7.80	1.08	10.77	1.74	12.75	2.18
	25	8.50	1.83	8.72	1.80	8.79	1.79	8.94	1.78	11.17	2.20	12.66	2.48
	29	9.52	2.64	9.77	2.60	9.85	2.59	10.01	2.56	11.44	2.74	12.40	2.86
	32	9.96	3.11	10.23	3.07	10.32	3.06	10.50	3.03	12.81	3.08	14.35	3.11
	35	10.13	3.46	10.42	3.44	10.51	3.43	10.70	3.41	11.36	3.36	11.79	3.33
	40	9.85	3.63	10.13	3.64	10.23	3.65	10.42	3.66	10.27	3.56	10.59	3.52
	43	9.31	3.63	9.59	3.71	9.69	3.74	9.88	3.79	10.06	3.71	10.17	3.69
	46	8.49	3.55	8.77	3.68	8.86	3.73	9.05	3.78	9.60	3.80	9.96	3.82
2.5 + 2.5 + 7.1	22	7.45	1.04	7.63	1.04	7.68	1.04	7.80	1.04	10.77	1.67	12.75	2.09
	25	8.50	1.75	8.72	1.73	8.79	1.72	8.94	1.70	11.17	2.11	12.66	2.38
	29	9.52	2.53	9.77	2.49	9.85	2.48	10.01	2.46	11.44	2.63	12.40	2.74
	32	9.96	2.98	10.23	2.94	10.32	2.93	10.50	2.91	12.81	2.95	14.35	2.98
	35	10.13	3.32	10.42	3.30	10.51	3.29	10.70	3.27	11.36	3.22	11.79	3.19
	40	9.85	3.48	10.13	3.49	10.23	3.50	10.42	3.51	10.27	3.41	10.59	3.38
	43	9.31	3.48	9.59	3.56	9.69	3.58	9.88	3.63	10.06	3.56	10.17	3.54
	46	8.49	3.41	8.77	3.53	8.86	3.57	9.05	3.63	9.60	3.64	9.96	3.67

Combination (Capacity)	Outdoor Air Temp. °C DB	Indoor Air Temp. °C											
		27/16		27/17.5		27/18		27/19		27/22		27/24	
		Total Q	Input Power	Total Q	Input Power	Total Q	Input Power	Total Q	Input Power	Total Q	Input Power	Total Q	Input Power
2.5 + 3.5 + 3.5	22	7.04	1.06	7.20	1.06	7.25	1.06	7.36	1.06	10.17	1.70	12.04	2.13
	25	8.02	1.79	8.23	1.76	8.30	1.75	8.44	1.74	10.54	2.15	11.95	2.42
	29	8.99	2.58	9.22	2.54	9.30	2.53	9.45	2.50	10.80	2.68	11.70	2.79
	32	9.40	3.04	9.66	3.00	9.74	2.99	9.91	2.96	12.09	3.01	13.54	3.04
	35	9.57	3.38	9.83	3.36	9.92	3.35	10.10	3.33	10.72	3.28	11.13	3.25
	40	9.30	3.55	9.57	3.56	9.65	3.56	9.83	3.57	9.70	3.47	10.00	3.44
	43	8.79	3.55	9.06	3.62	9.14	3.65	9.32	3.70	9.49	3.62	9.60	3.61
	46	8.01	3.47	8.28	3.60	8.37	3.64	8.54	3.69	9.06	3.71	9.40	3.73
2.5 + 3.5 + 4.2	22	7.45	1.24	7.63	1.24	7.68	1.24	7.80	1.24	10.77	2.00	12.75	2.50
	25	8.50	2.10	8.72	2.07	8.79	2.06	8.94	2.04	11.17	2.52	12.66	2.85
	29	9.52	3.03	9.77	2.98	9.85	2.97	10.01	2.94	11.44	3.14	12.40	3.28
	32	9.96	3.57	10.23	3.52	10.32	3.51	10.50	3.48	12.81	3.53	14.35	3.57
	35	10.13	3.97	10.42	3.94	10.51	3.93	10.70	3.91	11.36	3.86	11.79	3.82
	40	9.85	4.16	10.13	4.18	10.23	4.18	10.42	4.19	10.27	4.08	10.59	4.04
	43	9.31	4.16	9.59	4.25	9.69	4.28	9.88	4.34	10.06	4.25	10.17	4.23
	46	8.49	4.07	8.77	4.22	8.86	4.27	9.05	4.33	9.60	4.36	9.96	4.38
2.5 + 3.5 + 5.0	22	7.45	1.06	7.63	1.06	7.68	1.06	7.80	1.06	10.77	1.71	12.75	2.14
	25	8.50	1.79	8.72	1.77	8.79	1.76	8.94	1.74	11.17	2.16	12.66	2.43
	29	9.52	2.58	9.77	2.55	9.85	2.53	10.01	2.51	11.44	2.68	12.40	2.80
	32	9.96	3.05	10.23	3.01	10.32	2.99	10.50	2.97	12.81	3.01	14.35	3.05
	35	10.13	3.39	10.42	3.37	10.51	3.36	10.70	3.34	11.36	3.29	11.79	3.26
	40	9.85	3.56	10.13	3.57	10.23	3.57	10.42	3.58	10.27	3.48	10.59	3.45
	43	9.31	3.56	9.59	3.63	9.69	3.66	9.88	3.71	10.06	3.63	10.17	3.62
	46	8.49	3.48	8.77	3.61	8.86	3.65	9.05	3.70	9.60	3.72	9.96	3.74
2.5 + 3.5 + 6.0	22	7.45	1.06	7.63	1.06	7.68	1.06	7.80	1.06	10.77	1.71	12.75	2.14
	25	8.50	1.79	8.72	1.77	8.79	1.76	8.94	1.74	11.17	2.16	12.66	2.43
	29	9.52	2.58	9.77	2.55	9.85	2.53	10.01	2.51	11.44	2.68	12.40	2.80
	32	9.96	3.05	10.23	3.01	10.32	2.99	10.50	2.97	12.81	3.01	14.35	3.05
	35	10.13	3.39	10.42	3.37	10.51	3.36	10.70	3.34	11.36	3.29	11.79	3.26
	40	9.85	3.56	10.13	3.57	10.23	3.57	10.42	3.58	10.27	3.48	10.59	3.45
	43	9.31	3.56	9.59	3.63	9.69	3.66	9.88	3.71	10.06	3.63	10.17	3.62
	46	8.49	3.48	8.77	3.61	8.86	3.65	9.05	3.70	9.60	3.72	9.96	3.74
2.5 + 3.5 + 7.1	22	7.45	1.02	7.63	1.02	7.68	1.02	7.80	1.02	10.77	1.64	12.75	2.05
	25	8.50	1.72	8.72	1.69	8.79	1.68	8.94	1.67	11.17	2.06	12.66	2.33
	29	9.52	2.48	9.77	2.44	9.85	2.43	10.01	2.40	11.44	2.57	12.40	2.69
	32	9.96	2.92	10.23	2.88	10.32	2.87	10.50	2.84	12.81	2.89	14.35	2.92
	35	10.13	3.25	10.42	3.22	10.51	3.22	10.70	3.20	11.36	3.16	11.79	3.13
	40	9.85	3.41	10.13	3.42	10.23	3.42	10.42	3.43	10.27	3.34	10.59	3.30
	43	9.31	3.41	9.59	3.48	9.69	3.51	9.88	3.55	10.06	3.48	10.17	3.46
	46	8.49	3.33	8.77	3.46	8.86	3.50	9.05	3.55	9.60	3.56	9.96	3.59



Combination (Capacity)	Outdoor Air Temp. °C DB	Indoor Air Temp. °C											
		27/16		27/17.5		27/18		27/19		27/22		27/24	
		Total Q	Input Power	Total Q	Input Power	Total Q	Input Power	Total Q	Input Power	Total Q	Input Power	Total Q	Input Power
2.5 + 4.2 + 4.2	22	7.45	1.24	7.63	1.24	7.68	1.24	7.80	1.24	10.77	2.00	12.75	2.50
	25	8.50	2.10	8.72	2.07	8.79	2.06	8.94	2.04	11.17	2.52	12.66	2.85
	29	9.52	3.03	9.77	2.98	9.85	2.97	10.01	2.94	11.44	3.14	12.40	3.28
	32	9.96	3.57	10.23	3.52	10.32	3.51	10.50	3.48	12.81	3.53	14.35	3.57
	35	10.13	3.97	10.42	3.94	10.51	3.93	10.70	3.91	11.36	3.86	11.79	3.82
	40	9.85	4.16	10.13	4.18	10.23	4.18	10.42	4.19	10.27	4.08	10.59	4.04
	43	9.31	4.16	9.59	4.25	9.69	4.28	9.88	4.34	10.06	4.25	10.17	4.23
	46	8.49	4.07	8.77	4.22	8.86	4.27	9.05	4.33	9.60	4.36	9.96	4.38
2.5 + 4.2 + 5.0	22	7.45	1.04	7.63	1.04	7.68	1.04	7.80	1.04	10.77	1.67	12.75	2.09
	25	8.50	1.75	8.72	1.73	8.79	1.72	8.94	1.70	11.17	2.11	12.66	2.38
	29	9.52	2.53	9.77	2.49	9.85	2.48	10.01	2.46	11.44	2.63	12.40	2.74
	32	9.96	2.98	10.23	2.94	10.32	2.93	10.50	2.91	12.81	2.95	14.35	2.98
	35	10.13	3.32	10.42	3.30	10.51	3.29	10.70	3.27	11.36	3.22	11.79	3.19
	40	9.85	3.48	10.13	3.49	10.23	3.50	10.42	3.51	10.27	3.41	10.59	3.38
	43	9.31	3.48	9.59	3.56	9.69	3.58	9.88	3.63	10.06	3.56	10.17	3.54
	46	8.49	3.41	8.77	3.53	8.86	3.57	9.05	3.63	9.60	3.64	9.96	3.67
2.5 + 4.2 + 6.0	22	7.45	1.04	7.63	1.04	7.68	1.04	7.80	1.04	10.77	1.67	12.75	2.09
	25	8.50	1.75	8.72	1.73	8.79	1.72	8.94	1.70	11.17	2.11	12.66	2.38
	29	9.52	2.53	9.77	2.49	9.85	2.48	10.01	2.46	11.44	2.63	12.40	2.74
	32	9.96	2.98	10.23	2.94	10.32	2.93	10.50	2.91	12.81	2.95	14.35	2.98
	35	10.13	3.32	10.42	3.30	10.51	3.29	10.70	3.27	11.36	3.22	11.79	3.19
	40	9.85	3.48	10.13	3.49	10.23	3.50	10.42	3.51	10.27	3.41	10.59	3.38
	43	9.31	3.48	9.59	3.56	9.69	3.58	9.88	3.63	10.06	3.56	10.17	3.54
	46	8.49	3.41	8.77	3.53	8.86	3.57	9.05	3.63	9.60	3.64	9.96	3.67
2.5 + 4.2 + 7.1	22	7.45	1.02	7.63	1.02	7.68	1.02	7.80	1.02	10.77	1.64	12.75	2.05
	25	8.50	1.72	8.72	1.69	8.79	1.68	8.94	1.67	11.17	2.06	12.66	2.33
	29	9.52	2.48	9.77	2.44	9.85	2.43	10.01	2.40	11.44	2.57	12.40	2.69
	32	9.96	2.92	10.23	2.88	10.32	2.87	10.50	2.84	12.81	2.89	14.35	2.92
	35	10.13	3.25	10.42	3.22	10.51	3.22	10.70	3.20	11.36	3.16	11.79	3.13
	40	9.85	3.41	10.13	3.42	10.23	3.42	10.42	3.43	10.27	3.34	10.59	3.30
	43	9.31	3.41	9.59	3.48	9.69	3.51	9.88	3.55	10.06	3.48	10.17	3.46
	46	8.49	3.33	8.77	3.46	8.86	3.50	9.05	3.55	9.60	3.56	9.96	3.59
2.5 + 5.0 + 5.0	22	7.45	0.93	7.63	0.93	7.68	0.93	7.80	0.93	10.77	1.50	12.75	1.88
	25	8.50	1.58	8.72	1.55	8.79	1.55	8.94	1.53	11.17	1.90	12.66	2.14
	29	9.52	2.28	9.77	2.24	9.85	2.23	10.01	2.21	11.44	2.36	12.40	2.47
	32	9.96	2.68	10.23	2.65	10.32	2.64	10.50	2.61	12.81	2.65	14.35	2.68
	35	10.13	2.99	10.42	2.96	10.51	2.96	10.70	2.94	11.36	2.90	11.79	2.87
	40	9.85	3.13	10.13	3.14	10.23	3.15	10.42	3.15	10.27	3.07	10.59	3.04
	43	9.31	3.13	9.59	3.20	9.69	3.22	9.88	3.27	10.06	3.20	10.17	3.18
	46	8.49	3.06	8.77	3.18	8.86	3.21	9.05	3.26	9.60	3.28	9.96	3.30

Combination (Capacity)	Outdoor Air Temp. °C DB	Indoor Air Temp. °C											
		27/16		27/17.5		27/18		27/19		27/22		27/24	
		Total Q	Input Power	Total Q	Input Power	Total Q	Input Power	Total Q	Input Power	Total Q	Input Power	Total Q	Input Power
2.5 + 5.0 + 6.0	22	7.45	0.93	7.63	0.93	7.68	0.93	7.80	0.93	10.77	1.50	12.75	1.88
	25	8.50	1.58	8.72	1.55	8.79	1.55	8.94	1.53	11.17	1.90	12.66	2.14
	29	9.52	2.28	9.77	2.24	9.85	2.23	10.01	2.21	11.44	2.36	12.40	2.47
	32	9.96	2.68	10.23	2.65	10.32	2.64	10.50	2.61	12.81	2.65	14.35	2.68
	35	10.13	2.99	10.42	2.96	10.51	2.96	10.70	2.94	11.36	2.90	11.79	2.87
	40	9.85	3.13	10.13	3.14	10.23	3.15	10.42	3.15	10.27	3.07	10.59	3.04
	43	9.31	3.13	9.59	3.20	9.69	3.22	9.88	3.27	10.06	3.20	10.17	3.18
	46	8.49	3.06	8.77	3.18	8.86	3.21	9.05	3.26	9.60	3.28	9.96	3.30
2.5 + 5.0 + 7.1	22	7.45	0.91	7.63	0.91	7.68	0.91	7.80	0.91	10.77	1.47	12.75	1.84
	25	8.50	1.54	8.72	1.52	8.79	1.51	8.94	1.50	11.17	1.85	12.66	2.09
	29	9.52	2.22	9.77	2.19	9.85	2.18	10.01	2.16	11.44	2.31	12.40	2.41
	32	9.96	2.62	10.23	2.58	10.32	2.57	10.50	2.55	12.81	2.59	14.35	2.62
	35	10.13	2.91	10.42	2.89	10.51	2.88	10.70	2.87	11.36	2.83	11.79	2.80
	40	9.85	3.06	10.13	3.07	10.23	3.07	10.42	3.08	10.27	2.99	10.59	2.96
	43	9.31	3.06	9.59	3.12	9.69	3.14	9.88	3.19	10.06	3.12	10.17	3.11
	46	8.49	2.99	8.77	3.10	8.86	3.14	9.05	3.18	9.60	3.20	9.96	3.22
2.5 + 6.0 + 6.0	22	7.45	0.93	7.63	0.93	7.68	0.93	7.80	0.93	10.77	1.50	12.75	1.88
	25	8.50	1.58	8.72	1.55	8.79	1.55	8.94	1.53	11.17	1.90	12.66	2.14
	29	9.52	2.28	9.77	2.24	9.85	2.23	10.01	2.21	11.44	2.36	12.40	2.47
	32	9.96	2.68	10.23	2.65	10.32	2.64	10.50	2.61	12.81	2.65	14.35	2.68
	35	10.13	2.99	10.42	2.96	10.51	2.96	10.70	2.94	11.36	2.90	11.79	2.87
	40	9.85	3.13	10.13	3.14	10.23	3.15	10.42	3.15	10.27	3.07	10.59	3.04
	43	9.31	3.13	9.59	3.20	9.69	3.22	9.88	3.27	10.06	3.20	10.17	3.18
	46	8.49	3.06	8.77	3.18	8.86	3.21	9.05	3.26	9.60	3.28	9.96	3.30
2.5 + 6.0 + 7.1	22	7.45	0.91	7.63	0.91	7.68	0.91	7.80	0.91	10.77	1.47	12.75	1.84
	25	8.50	1.54	8.72	1.52	8.79	1.51	8.94	1.50	11.17	1.85	12.66	2.09
	29	9.52	2.22	9.77	2.19	9.85	2.18	10.01	2.16	11.44	2.31	12.40	2.41
	32	9.96	2.62	10.23	2.58	10.32	2.57	10.50	2.55	12.81	2.59	14.35	2.62
	35	10.13	2.91	10.42	2.89	10.51	2.88	10.70	2.87	11.36	2.83	11.79	2.80
	40	9.85	3.06	10.13	3.07	10.23	3.07	10.42	3.08	10.27	2.99	10.59	2.96
	43	9.31	3.06	9.59	3.12	9.69	3.14	9.88	3.19	10.06	3.12	10.17	3.11
	46	8.49	2.99	8.77	3.10	8.86	3.14	9.05	3.18	9.60	3.20	9.96	3.22
2.5 + 7.1 + 7.1	22	7.45	0.89	7.63	0.89	7.68	0.89	7.80	0.89	10.77	1.44	12.75	1.80
	25	8.50	1.51	8.72	1.49	8.79	1.48	8.94	1.46	11.17	1.81	12.66	2.05
	29	9.52	2.17	9.77	2.14	9.85	2.13	10.01	2.11	11.44	2.26	12.40	2.36
	32	9.96	2.56	10.23	2.53	10.32	2.52	10.50	2.50	12.81	2.54	14.35	2.56
	35	10.13	2.85	10.42	2.83	10.51	2.82	10.70	2.81	11.36	2.77	11.79	2.75
	40	9.85	2.99	10.13	3.00	10.23	3.01	10.42	3.01	10.27	2.93	10.59	2.90
	43	9.31	2.99	9.59	3.06	9.69	3.08	9.88	3.12	10.06	3.06	10.17	3.04
	46	8.49	2.93	8.77	3.04	8.86	3.07	9.05	3.12	9.60	3.13	9.96	3.15

Combination (Capacity)	Outdoor Air Temp. °C DB	Indoor Air Temp. °C											
		27/16		27/17.5		27/18		27/19		27/22		27/24	
		Total Q	Input Power	Total Q	Input Power	Total Q	Input Power	Total Q	Input Power	Total Q	Input Power	Total Q	Input Power
3.5 + 3.5 + 3.5	22	7.45	1.22	7.63	1.22	7.68	1.22	7.80	1.22	10.77	1.96	12.75	2.45
	25	8.50	2.05	8.72	2.03	8.79	2.02	8.94	2.00	11.17	2.47	12.66	2.79
	29	9.52	2.96	9.77	2.92	9.85	2.91	10.01	2.88	11.44	3.08	12.40	3.21
	32	9.96	3.49	10.23	3.45	10.32	3.43	10.50	3.40	12.81	3.46	14.35	3.49
	35	10.13	3.89	10.42	3.86	10.51	3.85	10.70	3.83	11.36	3.78	11.79	3.74
	40	9.85	4.08	10.13	4.09	10.23	4.10	10.42	4.11	10.27	3.99	10.59	3.96
	43	9.31	4.08	9.59	4.17	9.69	4.20	9.88	4.25	10.06	4.17	10.17	4.15
	46	8.49	3.99	8.77	4.14	8.86	4.19	9.05	4.25	9.60	4.27	9.96	4.29
3.5 + 3.5 + 4.2	22	7.45	1.20	7.63	1.20	7.68	1.20	7.80	1.20	10.77	1.92	12.75	2.41
	25	8.50	2.02	8.72	1.99	8.79	1.98	8.94	1.96	11.17	2.43	12.66	2.74
	29	9.52	2.91	9.77	2.87	9.85	2.85	10.01	2.82	11.44	3.02	12.40	3.15
	32	9.96	3.43	10.23	3.39	10.32	3.37	10.50	3.34	12.81	3.39	14.35	3.43
	35	10.13	3.82	10.42	3.79	10.51	3.78	10.70	3.76	11.36	3.71	11.79	3.67
	40	9.85	4.00	10.13	4.02	10.23	4.02	10.42	4.03	10.27	3.92	10.59	3.88
	43	9.31	4.00	9.59	4.09	9.69	4.12	9.88	4.18	10.06	4.09	10.17	4.07
	46	8.49	3.92	8.77	4.06	8.86	4.11	9.05	4.17	9.60	4.19	9.96	4.21
3.5 + 3.5 + 5.0	22	7.45	1.02	7.63	1.02	7.68	1.02	7.80	1.02	10.77	1.64	12.75	2.05
	25	8.50	1.72	8.72	1.69	8.79	1.68	8.94	1.67	11.17	2.06	12.66	2.33
	29	9.52	2.48	9.77	2.44	9.85	2.43	10.01	2.40	11.44	2.57	12.40	2.69
	32	9.96	2.92	10.23	2.88	10.32	2.87	10.50	2.84	12.81	2.89	14.35	2.92
	35	10.13	3.25	10.42	3.22	10.51	3.22	10.70	3.20	11.36	3.16	11.79	3.13
	40	9.85	3.41	10.13	3.42	10.23	3.42	10.42	3.43	10.27	3.34	10.59	3.30
	43	9.31	3.41	9.59	3.48	9.69	3.51	9.88	3.55	10.06	3.48	10.17	3.46
	46	8.49	3.33	8.77	3.46	8.86	3.50	9.05	3.55	9.60	3.56	9.96	3.59
3.5 + 3.5 + 6.0	22	7.45	1.02	7.63	1.02	7.68	1.02	7.80	1.02	10.77	1.64	12.75	2.05
	25	8.50	1.72	8.72	1.69	8.79	1.68	8.94	1.67	11.17	2.06	12.66	2.33
	29	9.52	2.48	9.77	2.44	9.85	2.43	10.01	2.40	11.44	2.57	12.40	2.69
	32	9.96	2.92	10.23	2.88	10.32	2.87	10.50	2.84	12.81	2.89	14.35	2.92
	35	10.13	3.25	10.42	3.22	10.51	3.22	10.70	3.20	11.36	3.16	11.79	3.13
	40	9.85	3.41	10.13	3.42	10.23	3.42	10.42	3.43	10.27	3.34	10.59	3.30
	43	9.31	3.41	9.59	3.48	9.69	3.51	9.88	3.55	10.06	3.48	10.17	3.46
	46	8.49	3.33	8.77	3.46	8.86	3.50	9.05	3.55	9.60	3.56	9.96	3.59
3.5 + 3.5 + 7.1	22	7.45	1.00	7.63	1.00	7.68	1.00	7.80	1.00	10.77	1.60	12.75	2.01
	25	8.50	1.68	8.72	1.66	8.79	1.65	8.94	1.64	11.17	2.03	12.66	2.29
	29	9.52	2.43	9.77	2.39	9.85	2.38	10.01	2.36	11.44	2.52	12.40	2.63
	32	9.96	2.86	10.23	2.83	10.32	2.82	10.50	2.79	12.81	2.83	14.35	2.86
	35	10.13	3.19	10.42	3.16	10.51	3.16	10.70	3.14	11.36	3.10	11.79	3.07
	40	9.85	3.34	10.13	3.36	10.23	3.36	10.42	3.37	10.27	3.27	10.59	3.24
	43	9.31	3.34	9.59	3.42	9.69	3.44	9.88	3.49	10.06	3.42	10.17	3.40
	46	8.49	3.27	8.77	3.39	8.86	3.43	9.05	3.48	9.60	3.50	9.96	3.52

Combination (Capacity)	Outdoor Air Temp. °C DB	Indoor Air Temp. °C											
		27/16		27/17.5		27/18		27/19		27/22		27/24	
		Total Q	Input Power	Total Q	Input Power	Total Q	Input Power	Total Q	Input Power	Total Q	Input Power	Total Q	Input Power
3.5 + 4.2 + 4.2	22	7.45	1.20	7.63	1.20	7.68	1.20	7.80	1.20	10.77	1.92	12.75	2.41
	25	8.50	2.02	8.72	1.99	8.79	1.98	8.94	1.96	11.17	2.43	12.66	2.74
	29	9.52	2.91	9.77	2.87	9.85	2.85	10.01	2.82	11.44	3.02	12.40	3.15
	32	9.96	3.43	10.23	3.39	10.32	3.37	10.50	3.34	12.81	3.39	14.35	3.43
	35	10.13	3.82	10.42	3.79	10.51	3.78	10.70	3.76	11.36	3.71	11.79	3.67
	40	9.85	4.00	10.13	4.02	10.23	4.02	10.42	4.03	10.27	3.92	10.59	3.88
	43	9.31	4.00	9.59	4.09	9.69	4.12	9.88	4.18	10.06	4.09	10.17	4.07
	46	8.49	3.92	8.77	4.06	8.86	4.11	9.05	4.17	9.60	4.19	9.96	4.21
3.5 + 4.2 + 5.0	22	7.45	1.02	7.63	1.02	7.68	1.02	7.80	1.02	10.77	1.64	12.75	2.05
	25	8.50	1.72	8.72	1.69	8.79	1.68	8.94	1.67	11.17	2.06	12.66	2.33
	29	9.52	2.48	9.77	2.44	9.85	2.43	10.01	2.40	11.44	2.57	12.40	2.69
	32	9.96	2.92	10.23	2.88	10.32	2.87	10.50	2.84	12.81	2.89	14.35	2.92
	35	10.13	3.25	10.42	3.22	10.51	3.22	10.70	3.20	11.36	3.16	11.79	3.13
	40	9.85	3.41	10.13	3.42	10.23	3.42	10.42	3.43	10.27	3.34	10.59	3.30
	43	9.31	3.41	9.59	3.48	9.69	3.51	9.88	3.55	10.06	3.48	10.17	3.46
	46	8.49	3.33	8.77	3.46	8.86	3.50	9.05	3.55	9.60	3.56	9.96	3.59
3.5 + 4.2 + 6.0	22	7.45	1.02	7.63	1.02	7.68	1.02	7.80	1.02	10.77	1.64	12.75	2.05
	25	8.50	1.72	8.72	1.69	8.79	1.68	8.94	1.67	11.17	2.06	12.66	2.33
	29	9.52	2.48	9.77	2.44	9.85	2.43	10.01	2.40	11.44	2.57	12.40	2.69
	32	9.96	2.92	10.23	2.88	10.32	2.87	10.50	2.84	12.81	2.89	14.35	2.92
	35	10.13	3.25	10.42	3.22	10.51	3.22	10.70	3.20	11.36	3.16	11.79	3.13
	40	9.85	3.41	10.13	3.42	10.23	3.42	10.42	3.43	10.27	3.34	10.59	3.30
	43	9.31	3.41	9.59	3.48	9.69	3.51	9.88	3.55	10.06	3.48	10.17	3.46
	46	8.49	3.33	8.77	3.46	8.86	3.50	9.05	3.55	9.60	3.56	9.96	3.59
3.5 + 4.2 + 7.1	22	7.45	1.00	7.63	1.00	7.68	1.00	7.80	1.00	10.77	1.60	12.75	2.01
	25	8.50	1.68	8.72	1.66	8.79	1.65	8.94	1.64	11.17	2.03	12.66	2.29
	29	9.52	2.43	9.77	2.39	9.85	2.38	10.01	2.36	11.44	2.52	12.40	2.63
	32	9.96	2.86	10.23	2.83	10.32	2.82	10.50	2.79	12.81	2.83	14.35	2.86
	35	10.13	3.19	10.42	3.16	10.51	3.16	10.70	3.14	11.36	3.10	11.79	3.07
	40	9.85	3.34	10.13	3.36	10.23	3.36	10.42	3.37	10.27	3.27	10.59	3.24
	43	9.31	3.34	9.59	3.42	9.69	3.44	9.88	3.49	10.06	3.42	10.17	3.40
	46	8.49	3.27	8.77	3.39	8.86	3.43	9.05	3.48	9.60	3.50	9.96	3.52
3.5 + 5.0 + 5.0	22	7.45	0.91	7.63	0.91	7.68	0.91	7.80	0.91	10.77	1.47	12.75	1.84
	25	8.50	1.54	8.72	1.52	8.79	1.51	8.94	1.50	11.17	1.85	12.66	2.09
	29	9.52	2.22	9.77	2.19	9.85	2.18	10.01	2.16	11.44	2.31	12.40	2.41
	32	9.96	2.62	10.23	2.58	10.32	2.57	10.50	2.55	12.81	2.59	14.35	2.62
	35	10.13	2.91	10.42	2.89	10.51	2.88	10.70	2.87	11.36	2.83	11.79	2.80
	40	9.85	3.06	10.13	3.07	10.23	3.07	10.42	3.08	10.27	2.99	10.59	2.96
	43	9.31	3.06	9.59	3.12	9.69	3.14	9.88	3.19	10.06	3.12	10.17	3.11
	46	8.49	2.99	8.77	3.10	8.86	3.14	9.05	3.18	9.60	3.20	9.96	3.22

Combination (Capacity)	Outdoor Air Temp. °C DB	Indoor Air Temp. °C											
		27/16		27/17.5		27/18		27/19		27/22		27/24	
		Total Q	Input Power	Total Q	Input Power	Total Q	Input Power	Total Q	Input Power	Total Q	Input Power	Total Q	Input Power
3.5 + 5.0 + 6.0	22	7.45	0.91	7.63	0.91	7.68	0.91	7.80	0.91	10.77	1.47	12.75	1.84
	25	8.50	1.54	8.72	1.52	8.79	1.51	8.94	1.50	11.17	1.85	12.66	2.09
	29	9.52	2.22	9.77	2.19	9.85	2.18	10.01	2.16	11.44	2.31	12.40	2.41
	32	9.96	2.62	10.23	2.58	10.32	2.57	10.50	2.55	12.81	2.59	14.35	2.62
	35	10.13	2.91	10.42	2.89	10.51	2.88	10.70	2.87	11.36	2.83	11.79	2.80
	40	9.85	3.06	10.13	3.07	10.23	3.07	10.42	3.08	10.27	2.99	10.59	2.96
	43	9.31	3.06	9.59	3.12	9.69	3.14	9.88	3.19	10.06	3.12	10.17	3.11
	46	8.49	2.99	8.77	3.10	8.86	3.14	9.05	3.18	9.60	3.20	9.96	3.22
3.5 + 5.0 + 7.1	22	7.45	0.89	7.63	0.89	7.68	0.89	7.80	0.89	10.77	1.44	12.75	1.80
	25	8.50	1.51	8.72	1.49	8.79	1.48	8.94	1.46	11.17	1.81	12.66	2.05
	29	9.52	2.17	9.77	2.14	9.85	2.13	10.01	2.11	11.44	2.26	12.40	2.36
	32	9.96	2.56	10.23	2.53	10.32	2.52	10.50	2.50	12.81	2.54	14.35	2.56
	35	10.13	2.85	10.42	2.83	10.51	2.82	10.70	2.81	11.36	2.77	11.79	2.75
	40	9.85	2.99	10.13	3.00	10.23	3.01	10.42	3.01	10.27	2.93	10.59	2.90
	43	9.31	2.99	9.59	3.06	9.69	3.08	9.88	3.12	10.06	3.06	10.17	3.04
	46	8.49	2.93	8.77	3.04	8.86	3.07	9.05	3.12	9.60	3.13	9.96	3.15
3.5 + 6.0 + 6.0	22	7.45	0.91	7.63	0.91	7.68	0.91	7.80	0.91	10.77	1.47	12.75	1.84
	25	8.50	1.54	8.72	1.52	8.79	1.51	8.94	1.50	11.17	1.85	12.66	2.09
	29	9.52	2.22	9.77	2.19	9.85	2.18	10.01	2.16	11.44	2.31	12.40	2.41
	32	9.96	2.62	10.23	2.58	10.32	2.57	10.50	2.55	12.81	2.59	14.35	2.62
	35	10.13	2.91	10.42	2.89	10.51	2.88	10.70	2.87	11.36	2.83	11.79	2.80
	40	9.85	3.06	10.13	3.07	10.23	3.07	10.42	3.08	10.27	2.99	10.59	2.96
	43	9.31	3.06	9.59	3.12	9.69	3.14	9.88	3.19	10.06	3.12	10.17	3.11
	46	8.49	2.99	8.77	3.10	8.86	3.14	9.05	3.18	9.60	3.20	9.96	3.22
3.5 + 6.0 + 7.1	22	7.45	0.89	7.63	0.89	7.68	0.89	7.80	0.89	10.77	1.44	12.75	1.80
	25	8.50	1.51	8.72	1.49	8.79	1.48	8.94	1.46	11.17	1.81	12.66	2.05
	29	9.52	2.17	9.77	2.14	9.85	2.13	10.01	2.11	11.44	2.26	12.40	2.36
	32	9.96	2.56	10.23	2.53	10.32	2.52	10.50	2.50	12.81	2.54	14.35	2.56
	35	10.13	2.85	10.42	2.83	10.51	2.82	10.70	2.81	11.36	2.77	11.79	2.75
	40	9.85	2.99	10.13	3.00	10.23	3.01	10.42	3.01	10.27	2.93	10.59	2.90
	43	9.31	2.99	9.59	3.06	9.69	3.08	9.88	3.12	10.06	3.06	10.17	3.04
	46	8.49	2.93	8.77	3.04	8.86	3.07	9.05	3.12	9.60	3.13	9.96	3.15
3.5 + 7.1 + 7.1	22	7.45	0.89	7.63	0.89	7.68	0.89	7.80	0.89	10.77	1.44	12.75	1.80
	25	8.50	1.51	8.72	1.49	8.79	1.48	8.94	1.46	11.17	1.81	12.66	2.05
	29	9.52	2.17	9.77	2.14	9.85	2.13	10.01	2.11	11.44	2.26	12.40	2.36
	32	9.96	2.56	10.23	2.53	10.32	2.52	10.50	2.50	12.81	2.54	14.35	2.56
	35	10.13	2.85	10.42	2.83	10.51	2.82	10.70	2.81	11.36	2.77	11.79	2.75
	40	9.85	2.99	10.13	3.00	10.23	3.01	10.42	3.01	10.27	2.93	10.59	2.90
	43	9.31	2.99	9.59	3.06	9.69	3.08	9.88	3.12	10.06	3.06	10.17	3.04
	46	8.49	2.93	8.77	3.04	8.86	3.07	9.05	3.12	9.60	3.13	9.96	3.15

Combination (Capacity)	Outdoor Air Temp. °C DB	Indoor Air Temp. °C											
		27/16		27/17.5		27/18		27/19		27/22		27/24	
		Total Q	Input Power	Total Q	Input Power	Total Q	Input Power	Total Q	Input Power	Total Q	Input Power	Total Q	Input Power
4.2 + 4.2 + 4.2	22	7.45	1.17	7.63	1.17	7.68	1.17	7.80	1.17	10.77	1.89	12.75	2.36
	25	8.50	1.98	8.72	1.95	8.79	1.94	8.94	1.92	11.17	2.38	12.66	2.69
	29	9.52	2.86	9.77	2.81	9.85	2.80	10.01	2.77	11.44	2.97	12.40	3.10
	32	9.96	3.36	10.23	3.32	10.32	3.31	10.50	3.28	12.81	3.33	14.35	3.36
	35	10.13	3.75	10.42	3.72	10.51	3.71	10.70	3.69	11.36	3.64	11.79	3.61
	40	9.85	3.93	10.13	3.94	10.23	3.95	10.42	3.96	10.27	3.85	10.59	3.81
	43	9.31	3.93	9.59	4.01	9.69	4.04	9.88	4.10	10.06	4.01	10.17	3.99
	46	8.49	3.84	8.77	3.99	8.86	4.03	9.05	4.09	9.60	4.11	9.96	4.14
4.2 + 4.2 + 5.0	22	7.45	1.02	7.63	1.02	7.68	1.02	7.80	1.02	10.77	1.64	12.75	2.05
	25	8.50	1.72	8.72	1.69	8.79	1.68	8.94	1.67	11.17	2.06	12.66	2.33
	29	9.52	2.48	9.77	2.44	9.85	2.43	10.01	2.40	11.44	2.57	12.40	2.69
	32	9.96	2.92	10.23	2.88	10.32	2.87	10.50	2.84	12.81	2.89	14.35	2.92
	35	10.13	3.25	10.42	3.22	10.51	3.22	10.70	3.20	11.36	3.16	11.79	3.13
	40	9.85	3.41	10.13	3.42	10.23	3.42	10.42	3.43	10.27	3.34	10.59	3.30
	43	9.31	3.41	9.59	3.48	9.69	3.51	9.88	3.55	10.06	3.48	10.17	3.46
	46	8.49	3.33	8.77	3.46	8.86	3.50	9.05	3.55	9.60	3.56	9.96	3.59
4.2 + 4.2 + 6.0	22	7.45	1.02	7.63	1.02	7.68	1.02	7.80	1.02	10.77	1.64	12.75	2.05
	25	8.50	1.72	8.72	1.69	8.79	1.68	8.94	1.67	11.17	2.06	12.66	2.33
	29	9.52	2.48	9.77	2.44	9.85	2.43	10.01	2.40	11.44	2.57	12.40	2.69
	32	9.96	2.92	10.23	2.88	10.32	2.87	10.50	2.84	12.81	2.89	14.35	2.92
	35	10.13	3.25	10.42	3.22	10.51	3.22	10.70	3.20	11.36	3.16	11.79	3.13
	40	9.85	3.41	10.13	3.42	10.23	3.42	10.42	3.43	10.27	3.34	10.59	3.30
	43	9.31	3.41	9.59	3.48	9.69	3.51	9.88	3.55	10.06	3.48	10.17	3.46
	46	8.49	3.33	8.77	3.46	8.86	3.50	9.05	3.55	9.60	3.56	9.96	3.59
4.2 + 4.2 + 7.1	22	7.45	0.98	7.63	0.98	7.68	0.98	7.80	0.98	10.77	1.57	12.75	1.96
	25	8.50	1.65	8.72	1.62	8.79	1.62	8.94	1.60	11.17	1.98	12.66	2.23
	29	9.52	2.38	9.77	2.34	9.85	2.33	10.01	2.31	11.44	2.47	12.40	2.58
	32	9.96	2.80	10.23	2.76	10.32	2.75	10.50	2.73	12.81	2.77	14.35	2.80
	35	10.13	3.12	10.42	3.09	10.51	3.09	10.70	3.07	11.36	3.03	11.79	3.00
	40	9.85	3.27	10.13	3.28	10.23	3.29	10.42	3.29	10.27	3.20	10.59	3.17
	43	9.31	3.27	9.59	3.34	9.69	3.36	9.88	3.41	10.06	3.34	10.17	3.32
	46	8.49	3.20	8.77	3.32	8.86	3.36	9.05	3.40	9.60	3.42	9.96	3.44
4.2 + 5.0 + 5.0	22	7.45	0.91	7.63	0.91	7.68	0.91	7.80	0.91	10.77	1.47	12.75	1.84
	25	8.50	1.54	8.72	1.52	8.79	1.51	8.94	1.50	11.17	1.85	12.66	2.09
	29	9.52	2.22	9.77	2.19	9.85	2.18	10.01	2.16	11.44	2.31	12.40	2.41
	32	9.96	2.62	10.23	2.58	10.32	2.57	10.50	2.55	12.81	2.59	14.35	2.62
	35	10.13	2.91	10.42	2.89	10.51	2.88	10.70	2.87	11.36	2.83	11.79	2.80
	40	9.85	3.06	10.13	3.07	10.23	3.07	10.42	3.08	10.27	2.99	10.59	2.96
	43	9.31	3.06	9.59	3.12	9.69	3.14	9.88	3.19	10.06	3.12	10.17	3.11
	46	8.49	2.99	8.77	3.10	8.86	3.14	9.05	3.18	9.60	3.20	9.96	3.22

Combination (Capacity)	Outdoor Air Temp. °C DB	Indoor Air Temp. °C											
		27/16		27/17.5		27/18		27/19		27/22		27/24	
		Total Q	Input Power	Total Q	Input Power	Total Q	Input Power	Total Q	Input Power	Total Q	Input Power	Total Q	Input Power
4.2 + 5.0 + 6.0	22	7.45	0.91	7.63	0.91	7.68	0.91	7.80	0.91	10.77	1.47	12.75	1.84
	25	8.50	1.54	8.72	1.52	8.79	1.51	8.94	1.50	11.17	1.85	12.66	2.09
	29	9.52	2.22	9.77	2.19	9.85	2.18	10.01	2.16	11.44	2.31	12.40	2.41
	32	9.96	2.62	10.23	2.58	10.32	2.57	10.50	2.55	12.81	2.59	14.35	2.62
	35	10.13	2.91	10.42	2.89	10.51	2.88	10.70	2.87	11.36	2.83	11.79	2.80
	40	9.85	3.06	10.13	3.07	10.23	3.07	10.42	3.08	10.27	2.99	10.59	2.96
	43	9.31	3.06	9.59	3.12	9.69	3.14	9.88	3.19	10.06	3.12	10.17	3.11
	46	8.49	2.99	8.77	3.10	8.86	3.14	9.05	3.18	9.60	3.20	9.96	3.22
4.2 + 5.0 + 7.1	22	7.45	0.89	7.63	0.89	7.68	0.89	7.80	0.89	10.77	1.44	12.75	1.80
	25	8.50	1.51	8.72	1.49	8.79	1.48	8.94	1.46	11.17	1.81	12.66	2.05
	29	9.52	2.17	9.77	2.14	9.85	2.13	10.01	2.11	11.44	2.26	12.40	2.36
	32	9.96	2.56	10.23	2.53	10.32	2.52	10.50	2.50	12.81	2.54	14.35	2.56
	35	10.13	2.85	10.42	2.83	10.51	2.82	10.70	2.81	11.36	2.77	11.79	2.75
	40	9.85	2.99	10.13	3.00	10.23	3.01	10.42	3.01	10.27	2.93	10.59	2.90
	43	9.31	2.99	9.59	3.06	9.69	3.08	9.88	3.12	10.06	3.06	10.17	3.04
	46	8.49	2.93	8.77	3.04	8.86	3.07	9.05	3.12	9.60	3.13	9.96	3.15
4.2 + 6.0 + 6.0	22	7.45	0.91	7.63	0.91	7.68	0.91	7.80	0.91	10.77	1.47	12.75	1.84
	25	8.50	1.54	8.72	1.52	8.79	1.51	8.94	1.50	11.17	1.85	12.66	2.09
	29	9.52	2.22	9.77	2.19	9.85	2.18	10.01	2.16	11.44	2.31	12.40	2.41
	32	9.96	2.62	10.23	2.58	10.32	2.57	10.50	2.55	12.81	2.59	14.35	2.62
	35	10.13	2.91	10.42	2.89	10.51	2.88	10.70	2.87	11.36	2.83	11.79	2.80
	40	9.85	3.06	10.13	3.07	10.23	3.07	10.42	3.08	10.27	2.99	10.59	2.96
	43	9.31	3.06	9.59	3.12	9.69	3.14	9.88	3.19	10.06	3.12	10.17	3.11
	46	8.49	2.99	8.77	3.10	8.86	3.14	9.05	3.18	9.60	3.20	9.96	3.22
4.2 + 6.0 + 7.1	22	7.45	0.89	7.63	0.89	7.68	0.89	7.80	0.89	10.77	1.44	12.75	1.80
	25	8.50	1.51	8.72	1.49	8.79	1.48	8.94	1.46	11.17	1.81	12.66	2.05
	29	9.52	2.17	9.77	2.14	9.85	2.13	10.01	2.11	11.44	2.26	12.40	2.36
	32	9.96	2.56	10.23	2.53	10.32	2.52	10.50	2.50	12.81	2.54	14.35	2.56
	35	10.13	2.85	10.42	2.83	10.51	2.82	10.70	2.81	11.36	2.77	11.79	2.75
	40	9.85	2.99	10.13	3.00	10.23	3.01	10.42	3.01	10.27	2.93	10.59	2.90
	43	9.31	2.99	9.59	3.06	9.69	3.08	9.88	3.12	10.06	3.06	10.17	3.04
	46	8.49	2.93	8.77	3.04	8.86	3.07	9.05	3.12	9.60	3.13	9.96	3.15
5.0 + 5.0 + 5.0	22	7.45	0.85	7.63	0.85	7.68	0.85	7.80	0.85	10.77	1.37	12.75	1.71
	25	8.50	1.44	8.72	1.42	8.79	1.41	8.94	1.40	11.17	1.73	12.66	1.95
	29	9.52	2.07	9.77	2.04	9.85	2.03	10.01	2.01	11.44	2.15	12.40	2.25
	32	9.96	2.44	10.23	2.41	10.32	2.40	10.50	2.38	12.81	2.42	14.35	2.44
	35	10.13	2.72	10.42	2.70	10.51	2.69	10.70	2.68	11.36	2.64	11.79	2.62
	40	9.85	2.85	10.13	2.86	10.23	2.87	10.42	2.87	10.27	2.79	10.59	2.77
	43	9.31	2.85	9.59	2.92	9.69	2.94	9.88	2.98	10.06	2.92	10.17	2.90
	46	8.49	2.79	8.77	2.90	8.86	2.93	9.05	2.97	9.60	2.99	9.96	3.00

Combination (Capacity)	Outdoor Air Temp. °C DB	Indoor Air Temp. °C											
		27/16		27/17.5		27/18		27/19		27/22		27/24	
		Total Q	Input Power	Total Q	Input Power	Total Q	Input Power	Total Q	Input Power	Total Q	Input Power	Total Q	Input Power
5.0 + 5.0 + 6.0	22	7.45	0.85	7.63	0.85	7.68	0.85	7.80	0.85	10.77	1.37	12.75	1.71
	25	8.50	1.44	8.72	1.42	8.79	1.41	8.94	1.40	11.17	1.73	12.66	1.95
	29	9.52	2.07	9.77	2.04	9.85	2.03	10.01	2.01	11.44	2.15	12.40	2.25
	32	9.96	2.44	10.23	2.41	10.32	2.40	10.50	2.38	12.81	2.42	14.35	2.44
	35	10.13	2.72	10.42	2.70	10.51	2.69	10.70	2.68	11.36	2.64	11.79	2.62
	40	9.85	2.85	10.13	2.86	10.23	2.87	10.42	2.87	10.27	2.79	10.59	2.77
	43	9.31	2.85	9.59	2.92	9.69	2.94	9.88	2.98	10.06	2.92	10.17	2.90
	46	8.49	2.79	8.77	2.90	8.86	2.93	9.05	2.97	9.60	2.99	9.96	3.00
5.0 + 5.0 + 7.1	22	7.45	0.86	7.63	0.86	7.68	0.86	7.80	0.86	10.77	1.37	12.75	1.72
	25	8.50	1.44	8.72	1.42	8.79	1.42	8.94	1.40	11.17	1.74	12.66	1.96
	29	9.52	2.08	9.77	2.05	9.85	2.04	10.01	2.02	11.44	2.16	12.40	2.26
	32	9.96	2.45	10.23	2.42	10.32	2.41	10.50	2.39	12.81	2.43	14.35	2.45
	35	10.13	2.73	10.42	2.71	10.51	2.70	10.70	2.69	11.36	2.65	11.79	2.63
	40	9.85	2.86	10.13	2.88	10.23	2.88	10.42	2.89	10.27	2.80	10.59	2.78
	43	9.31	2.86	9.59	2.93	9.69	2.95	9.88	2.99	10.06	2.93	10.17	2.91
	46	8.49	2.80	8.77	2.91	8.86	2.94	9.05	2.98	9.60	3.00	9.96	3.02
5.0 + 6.0 + 6.0	22	7.45	0.85	7.63	0.85	7.68	0.85	7.80	0.85	10.77	1.37	12.75	1.71
	25	8.50	1.44	8.72	1.42	8.79	1.41	8.94	1.40	11.17	1.73	12.66	1.95
	29	9.52	2.07	9.77	2.04	9.85	2.03	10.01	2.01	11.44	2.15	12.40	2.25
	32	9.96	2.44	10.23	2.41	10.32	2.40	10.50	2.38	12.81	2.42	14.35	2.44
	35	10.13	2.72	10.42	2.70	10.51	2.69	10.70	2.68	11.36	2.64	11.79	2.62
	40	9.85	2.85	10.13	2.86	10.23	2.87	10.42	2.87	10.27	2.79	10.59	2.77
	43	9.31	2.85	9.59	2.92	9.69	2.94	9.88	2.98	10.06	2.92	10.17	2.90
	46	8.49	2.79	8.77	2.90	8.86	2.93	9.05	2.97	9.60	2.99	9.96	3.00
5.0 + 6.0 + 7.1	22	7.45	0.86	7.63	0.86	7.68	0.86	7.80	0.86	10.77	1.37	12.75	1.72
	25	8.50	1.44	8.72	1.42	8.79	1.42	8.94	1.40	11.17	1.74	12.66	1.96
	29	9.52	2.08	9.77	2.05	9.85	2.04	10.01	2.02	11.44	2.16	12.40	2.26
	32	9.96	2.45	10.23	2.42	10.32	2.41	10.50	2.39	12.81	2.43	14.35	2.45
	35	10.13	2.73	10.42	2.71	10.51	2.70	10.70	2.69	11.36	2.65	11.79	2.63
	40	9.85	2.86	10.13	2.88	10.23	2.88	10.42	2.89	10.27	2.80	10.59	2.78
	43	9.31	2.86	9.59	2.93	9.69	2.95	9.88	2.99	10.06	2.93	10.17	2.91
	46	8.49	2.80	8.77	2.91	8.86	2.94	9.05	2.98	9.60	3.00	9.96	3.02
6.0 + 6.0 + 6.0	22	7.45	0.85	7.63	0.85	7.68	0.85	7.80	0.85	10.77	1.37	12.75	1.71
	25	8.50	1.44	8.72	1.42	8.79	1.41	8.94	1.40	11.17	1.73	12.66	1.95
	29	9.52	2.07	9.77	2.04	9.85	2.03	10.01	2.01	11.44	2.15	12.40	2.25
	32	9.96	2.44	10.23	2.41	10.32	2.40	10.50	2.38	12.81	2.42	14.35	2.44
	35	10.13	2.72	10.42	2.70	10.51	2.69	10.70	2.68	11.36	2.64	11.79	2.62
	40	9.85	2.85	10.13	2.86	10.23	2.87	10.42	2.87	10.27	2.79	10.59	2.77
	43	9.31	2.85	9.59	2.92	9.69	2.94	9.88	2.98	10.06	2.92	10.17	2.90
	46	8.49	2.79	8.77	2.90	8.86	2.93	9.05	2.97	9.60	2.99	9.96	3.00



Combination (Capacity)	Outdoor Air Temp. °C DB	Indoor Air Temp. °C											
		27/16		27/17.5		27/18		27/19		27/22		27/24	
		Total Q	Input Power	Total Q	Input Power	Total Q	Input Power	Total Q	Input Power	Total Q	Input Power	Total Q	Input Power
1.6 + 1.6 + 1.6 + 1.6	22	10.29	1.60	9.35	1.67	9.04	1.69	8.41	1.74	10.53	2.03	11.94	2.23
	25	10.38	2.22	9.83	2.25	9.64	2.26	9.28	2.28	10.83	2.47	11.87	2.59
	29	10.54	2.88	10.32	2.88	10.24	2.88	10.09	2.88	11.06	2.95	11.70	3.01
	32	10.36	3.25	10.41	3.23	10.43	3.23	10.46	3.22	11.10	3.24	11.53	3.26
	35	10.25	3.52	10.42	3.50	10.48	3.49	10.60	3.48	11.03	3.46	11.32	3.45
	40	9.92	3.74	10.14	3.74	10.21	3.73	10.36	3.73	10.32	3.68	10.60	3.65
	43	9.61	3.73	9.77	3.75	9.83	3.75	9.94	3.77	10.31	3.74	10.28	3.71
	46	9.24	3.61	9.27	3.67	9.28	3.68	9.30	3.72	9.85	3.72	9.96	3.71
1.6 + 1.6 + 1.6 + 2.0	22	10.29	1.60	9.35	1.67	9.04	1.69	8.41	1.74	10.53	2.03	11.94	2.23
	25	10.38	2.22	9.83	2.25	9.64	2.26	9.28	2.28	10.83	2.47	11.87	2.59
	29	10.54	2.88	10.32	2.88	10.24	2.88	10.09	2.88	11.06	2.95	11.70	3.01
	32	10.36	3.25	10.41	3.23	10.43	3.23	10.46	3.22	11.10	3.24	11.53	3.26
	35	10.25	3.52	10.42	3.50	10.48	3.49	10.60	3.48	11.03	3.46	11.32	3.45
	40	9.92	3.74	10.14	3.74	10.21	3.73	10.36	3.73	10.32	3.68	10.60	3.65
	43	9.61	3.73	9.77	3.75	9.83	3.75	9.94	3.77	10.31	3.74	10.28	3.71
	46	9.24	3.61	9.27	3.67	9.28	3.68	9.30	3.72	9.85	3.72	9.96	3.71
1.6 + 1.6 + 1.6 + 2.5	22	10.29	1.60	9.35	1.67	9.04	1.69	8.41	1.74	10.53	2.03	11.94	2.23
	25	10.38	2.22	9.83	2.25	9.64	2.26	9.28	2.28	10.83	2.47	11.87	2.59
	29	10.54	2.88	10.32	2.88	10.24	2.88	10.09	2.88	11.06	2.95	11.70	3.01
	32	10.36	3.25	10.41	3.23	10.43	3.23	10.46	3.22	11.10	3.24	11.53	3.26
	35	10.25	3.52	10.42	3.50	10.48	3.49	10.60	3.48	11.03	3.46	11.32	3.45
	40	9.92	3.74	10.14	3.74	10.21	3.73	10.36	3.73	10.32	3.68	10.60	3.65
	43	9.61	3.73	9.77	3.75	9.83	3.75	9.94	3.77	10.31	3.74	10.28	3.71
	46	9.24	3.61	9.27	3.67	9.28	3.68	9.30	3.72	9.85	3.72	9.96	3.71
1.6 + 1.6 + 1.6 + 3.5	22	10.29	1.56	9.35	1.63	9.04	1.65	8.41	1.70	10.53	1.98	11.94	2.18
	25	10.38	2.17	9.83	2.20	9.64	2.21	9.28	2.23	10.83	2.41	11.87	2.53
	29	10.54	2.81	10.32	2.81	10.24	2.81	10.09	2.81	11.06	2.89	11.70	2.94
	32	10.36	3.18	10.41	3.16	10.43	3.16	10.46	3.14	11.10	3.17	11.53	3.18
	35	10.25	3.44	10.42	3.42	10.48	3.41	10.60	3.40	11.03	3.38	11.32	3.37
	40	9.92	3.66	10.14	3.65	10.21	3.65	10.36	3.64	10.32	3.60	10.60	3.57
	43	9.61	3.64	9.77	3.66	9.83	3.67	9.94	3.68	10.31	3.65	10.28	3.63
	46	9.24	3.53	9.27	3.58	9.28	3.60	9.30	3.63	9.85	3.63	9.96	3.63
1.6 + 1.6 + 1.6 + 4.2	22	10.29	1.56	9.35	1.63	9.04	1.65	8.41	1.70	10.53	1.98	11.94	2.18
	25	10.38	2.17	9.83	2.20	9.64	2.21	9.28	2.23	10.83	2.41	11.87	2.53
	29	10.54	2.81	10.32	2.81	10.24	2.81	10.09	2.81	11.06	2.89	11.70	2.94
	32	10.36	3.18	10.41	3.16	10.43	3.16	10.46	3.14	11.10	3.17	11.53	3.18
	35	10.25	3.44	10.42	3.42	10.48	3.41	10.60	3.40	11.03	3.38	11.32	3.37
	40	9.92	3.66	10.14	3.65	10.21	3.65	10.36	3.64	10.32	3.60	10.60	3.57
	43	9.61	3.64	9.77	3.66	9.83	3.67	9.94	3.68	10.31	3.65	10.28	3.63
	46	9.24	3.53	9.27	3.58	9.28	3.60	9.30	3.63	9.85	3.63	9.96	3.63

Combination (Capacity)	Outdoor Air Temp. °C DB	Indoor Air Temp. °C											
		27/16		27/17.5		27/18		27/19		27/22		27/24	
		Total Q	Input Power	Total Q	Input Power	Total Q	Input Power	Total Q	Input Power	Total Q	Input Power	Total Q	Input Power
1.6 + 1.6 + 1.6 + 5.0	22	10.29	1.43	9.35	1.49	9.04	1.51	8.41	1.55	10.53	1.82	11.94	1.99
	25	10.38	1.98	9.83	2.01	9.64	2.02	9.28	2.04	10.83	2.21	11.87	2.32
	29	10.54	2.57	10.32	2.57	10.24	2.57	10.09	2.57	11.06	2.64	11.70	2.69
	32	10.36	2.91	10.41	2.89	10.43	2.89	10.46	2.88	11.10	2.90	11.53	2.91
	35	10.25	3.15	10.42	3.13	10.48	3.12	10.60	3.11	11.03	3.09	11.32	3.08
	40	9.92	3.34	10.14	3.34	10.21	3.34	10.36	3.33	10.32	3.29	10.60	3.27
	43	9.61	3.33	9.77	3.35	9.83	3.35	9.94	3.37	10.31	3.34	10.28	3.32
	46	9.24	3.23	9.27	3.28	9.28	3.29	9.30	3.32	9.85	3.32	9.96	3.32
1.6 + 1.6 + 1.6 + 6.0	22	10.29	1.43	9.35	1.49	9.04	1.51	8.41	1.55	10.53	1.82	11.94	1.99
	25	10.38	1.98	9.83	2.01	9.64	2.02	9.28	2.04	10.83	2.21	11.87	2.32
	29	10.54	2.57	10.32	2.57	10.24	2.57	10.09	2.57	11.06	2.64	11.70	2.69
	32	10.36	2.91	10.41	2.89	10.43	2.89	10.46	2.88	11.10	2.90	11.53	2.91
	35	10.25	3.15	10.42	3.13	10.48	3.12	10.60	3.11	11.03	3.09	11.32	3.08
	40	9.92	3.34	10.14	3.34	10.21	3.34	10.36	3.33	10.32	3.29	10.60	3.27
	43	9.61	3.33	9.77	3.35	9.83	3.35	9.94	3.37	10.31	3.34	10.28	3.32
	46	9.24	3.23	9.27	3.28	9.28	3.29	9.30	3.32	9.85	3.32	9.96	3.32
1.6 + 1.6 + 1.6 + 7.1	22	10.29	1.39	9.35	1.46	9.04	1.48	8.41	1.52	10.53	1.77	11.94	1.95
	25	10.38	1.94	9.83	1.96	9.64	1.97	9.28	1.99	10.83	2.16	11.87	2.26
	29	10.54	2.51	10.32	2.51	10.24	2.51	10.09	2.51	11.06	2.58	11.70	2.63
	32	10.36	2.84	10.41	2.83	10.43	2.82	10.46	2.81	11.10	2.83	11.53	2.84
	35	10.25	3.08	10.42	3.06	10.48	3.05	10.60	3.04	11.03	3.02	11.32	3.01
	40	9.92	3.27	10.14	3.26	10.21	3.26	10.36	3.26	10.32	3.22	10.60	3.19
	43	9.61	3.25	9.77	3.27	9.83	3.28	9.94	3.29	10.31	3.26	10.28	3.24
	46	9.24	3.15	9.27	3.20	9.28	3.22	9.30	3.25	9.85	3.25	9.96	3.24
1.6 + 1.6 + 2.0 + 2.0	22	10.29	1.56	9.35	1.63	9.04	1.65	8.41	1.70	10.53	1.98	11.94	2.18
	25	10.38	2.17	9.83	2.20	9.64	2.21	9.28	2.23	10.83	2.41	11.87	2.53
	29	10.54	2.81	10.32	2.81	10.24	2.81	10.09	2.81	11.06	2.89	11.70	2.94
	32	10.36	3.18	10.41	3.16	10.43	3.16	10.46	3.14	11.10	3.17	11.53	3.18
	35	10.25	3.44	10.42	3.42	10.48	3.41	10.60	3.40	11.03	3.38	11.32	3.37
	40	9.92	3.66	10.14	3.65	10.21	3.65	10.36	3.64	10.32	3.60	10.60	3.57
	43	9.61	3.64	9.77	3.66	9.83	3.67	9.94	3.68	10.31	3.65	10.28	3.63
	46	9.24	3.53	9.27	3.58	9.28	3.60	9.30	3.63	9.85	3.63	9.96	3.63
1.6 + 1.6 + 2.0 + 2.5	22	10.29	1.56	9.35	1.63	9.04	1.65	8.41	1.70	10.53	1.98	11.94	2.18
	25	10.38	2.17	9.83	2.20	9.64	2.21	9.28	2.23	10.83	2.41	11.87	2.53
	29	10.54	2.81	10.32	2.81	10.24	2.81	10.09	2.81	11.06	2.89	11.70	2.94
	32	10.36	3.18	10.41	3.16	10.43	3.16	10.46	3.14	11.10	3.17	11.53	3.18
	35	10.25	3.44	10.42	3.42	10.48	3.41	10.60	3.40	11.03	3.38	11.32	3.37
	40	9.92	3.66	10.14	3.65	10.21	3.65	10.36	3.64	10.32	3.60	10.60	3.57
	43	9.61	3.64	9.77	3.66	9.83	3.67	9.94	3.68	10.31	3.65	10.28	3.63
	46	9.24	3.53	9.27	3.58	9.28	3.60	9.30	3.63	9.85	3.63	9.96	3.63

Combination (Capacity)	Outdoor Air Temp. °C DB	Indoor Air Temp. °C											
		27/16		27/17.5		27/18		27/19		27/22		27/24	
		Total Q	Input Power	Total Q	Input Power	Total Q	Input Power	Total Q	Input Power	Total Q	Input Power	Total Q	Input Power
1.6 + 1.6 + 2.0 + 3.5	22	10.29	1.53	9.35	1.59	9.04	1.62	8.41	1.66	10.53	1.94	11.94	2.13
	25	10.38	2.12	9.83	2.15	9.64	2.16	9.28	2.18	10.83	2.36	11.87	2.48
	29	10.54	2.75	10.32	2.75	10.24	2.75	10.09	2.75	11.06	2.83	11.70	2.88
	32	10.36	3.11	10.41	3.10	10.43	3.09	10.46	3.08	11.10	3.10	11.53	3.12
	35	10.25	3.37	10.42	3.35	10.48	3.34	10.60	3.33	11.03	3.31	11.32	3.30
	40	9.92	3.58	10.14	3.57	10.21	3.57	10.36	3.57	10.32	3.53	10.60	3.50
	43	9.61	3.56	9.77	3.59	9.83	3.59	9.94	3.61	10.31	3.57	10.28	3.55
	46	9.24	3.46	9.27	3.51	9.28	3.52	9.30	3.56	9.85	3.56	9.96	3.55
1.6 + 1.6 + 2.0 + 4.2	22	10.29	1.53	9.35	1.59	9.04	1.62	8.41	1.66	10.53	1.94	11.94	2.13
	25	10.38	2.12	9.83	2.15	9.64	2.16	9.28	2.18	10.83	2.36	11.87	2.48
	29	10.54	2.75	10.32	2.75	10.24	2.75	10.09	2.75	11.06	2.83	11.70	2.88
	32	10.36	3.11	10.41	3.10	10.43	3.09	10.46	3.08	11.10	3.10	11.53	3.12
	35	10.25	3.37	10.42	3.35	10.48	3.34	10.60	3.33	11.03	3.31	11.32	3.30
	40	9.92	3.58	10.14	3.57	10.21	3.57	10.36	3.57	10.32	3.53	10.60	3.50
	43	9.61	3.56	9.77	3.59	9.83	3.59	9.94	3.61	10.31	3.57	10.28	3.55
	46	9.24	3.46	9.27	3.51	9.28	3.52	9.30	3.56	9.85	3.56	9.96	3.55
1.6 + 1.6 + 2.0 + 5.0	22	10.29	1.43	9.35	1.49	9.04	1.51	8.41	1.55	10.53	1.82	11.94	1.99
	25	10.38	1.98	9.83	2.01	9.64	2.02	9.28	2.04	10.83	2.21	11.87	2.32
	29	10.54	2.57	10.32	2.57	10.24	2.57	10.09	2.57	11.06	2.64	11.70	2.69
	32	10.36	2.91	10.41	2.89	10.43	2.89	10.46	2.88	11.10	2.90	11.53	2.91
	35	10.25	3.15	10.42	3.13	10.48	3.12	10.60	3.11	11.03	3.09	11.32	3.08
	40	9.92	3.34	10.14	3.34	10.21	3.34	10.36	3.33	10.32	3.29	10.60	3.27
	43	9.61	3.33	9.77	3.35	9.83	3.35	9.94	3.37	10.31	3.34	10.28	3.32
	46	9.24	3.23	9.27	3.28	9.28	3.29	9.30	3.32	9.85	3.32	9.96	3.32
1.6 + 1.6 + 2.0 + 6.0	22	10.29	1.43	9.35	1.49	9.04	1.51	8.41	1.55	10.53	1.82	11.94	1.99
	25	10.38	1.98	9.83	2.01	9.64	2.02	9.28	2.04	10.83	2.21	11.87	2.32
	29	10.54	2.57	10.32	2.57	10.24	2.57	10.09	2.57	11.06	2.64	11.70	2.69
	32	10.36	2.91	10.41	2.89	10.43	2.89	10.46	2.88	11.10	2.90	11.53	2.91
	35	10.25	3.15	10.42	3.13	10.48	3.12	10.60	3.11	11.03	3.09	11.32	3.08
	40	9.92	3.34	10.14	3.34	10.21	3.34	10.36	3.33	10.32	3.29	10.60	3.27
	43	9.61	3.33	9.77	3.35	9.83	3.35	9.94	3.37	10.31	3.34	10.28	3.32
	46	9.24	3.23	9.27	3.28	9.28	3.29	9.30	3.32	9.85	3.32	9.96	3.32
1.6 + 1.6 + 2.0 + 7.1	22	10.48	1.46	9.53	1.52	9.21	1.54	8.57	1.59	10.73	1.86	12.16	2.04
	25	10.57	2.03	10.01	2.06	9.83	2.07	9.45	2.09	11.04	2.26	12.09	2.37
	29	10.74	2.63	10.51	2.63	10.44	2.63	10.28	2.63	11.26	2.70	11.92	2.75
	32	10.56	2.97	10.61	2.96	10.62	2.95	10.66	2.94	11.31	2.96	11.75	2.98
	35	10.44	3.22	10.62	3.20	10.68	3.19	10.80	3.18	11.24	3.16	11.53	3.15
	40	10.10	3.42	10.33	3.41	10.41	3.41	10.56	3.41	10.52	3.37	10.80	3.34
	43	9.79	3.40	9.96	3.42	10.02	3.43	10.13	3.44	10.51	3.41	10.48	3.39
	46	9.42	3.30	9.45	3.35	9.46	3.37	9.48	3.40	10.03	3.40	10.15	3.39

Combination (Capacity)	Outdoor Air Temp. °C DB	Indoor Air Temp. °C											
		27/16		27/17.5		27/18		27/19		27/22		27/24	
		Total Q	Input Power	Total Q	Input Power	Total Q	Input Power	Total Q	Input Power	Total Q	Input Power	Total Q	Input Power
1.6 + 1.6 + 2.5 + 2.5	22	10.29	1.56	9.35	1.63	9.04	1.65	8.41	1.70	10.53	1.98	11.94	2.18
	25	10.38	2.17	9.83	2.20	9.64	2.21	9.28	2.23	10.83	2.41	11.87	2.53
	29	10.54	2.81	10.32	2.81	10.24	2.81	10.09	2.81	11.06	2.89	11.70	2.94
	32	10.36	3.18	10.41	3.16	10.43	3.16	10.46	3.14	11.10	3.17	11.53	3.18
	35	10.25	3.44	10.42	3.42	10.48	3.41	10.60	3.40	11.03	3.38	11.32	3.37
	40	9.92	3.66	10.14	3.65	10.21	3.65	10.36	3.64	10.32	3.60	10.60	3.57
	43	9.61	3.64	9.77	3.66	9.83	3.67	9.94	3.68	10.31	3.65	10.28	3.63
	46	9.24	3.53	9.27	3.58	9.28	3.60	9.30	3.63	9.85	3.63	9.96	3.63
1.6 + 1.6 + 2.5 + 3.5	22	10.29	1.53	9.35	1.59	9.04	1.62	8.41	1.66	10.53	1.94	11.94	2.13
	25	10.38	2.12	9.83	2.15	9.64	2.16	9.28	2.18	10.83	2.36	11.87	2.48
	29	10.54	2.75	10.32	2.75	10.24	2.75	10.09	2.75	11.06	2.83	11.70	2.88
	32	10.36	3.11	10.41	3.10	10.43	3.09	10.46	3.08	11.10	3.10	11.53	3.12
	35	10.25	3.37	10.42	3.35	10.48	3.34	10.60	3.33	11.03	3.31	11.32	3.30
	40	9.92	3.58	10.14	3.57	10.21	3.57	10.36	3.57	10.32	3.53	10.60	3.50
	43	9.61	3.56	9.77	3.59	9.83	3.59	9.94	3.61	10.31	3.57	10.28	3.55
	46	9.24	3.46	9.27	3.51	9.28	3.52	9.30	3.56	9.85	3.56	9.96	3.55
1.6 + 1.6 + 2.5 + 4.2	22	10.29	1.53	9.35	1.59	9.04	1.62	8.41	1.66	10.53	1.94	11.94	2.13
	25	10.38	2.12	9.83	2.15	9.64	2.16	9.28	2.18	10.83	2.36	11.87	2.48
	29	10.54	2.75	10.32	2.75	10.24	2.75	10.09	2.75	11.06	2.83	11.70	2.88
	32	10.36	3.11	10.41	3.10	10.43	3.09	10.46	3.08	11.10	3.10	11.53	3.12
	35	10.25	3.37	10.42	3.35	10.48	3.34	10.60	3.33	11.03	3.31	11.32	3.30
	40	9.92	3.58	10.14	3.57	10.21	3.57	10.36	3.57	10.32	3.53	10.60	3.50
	43	9.61	3.56	9.77	3.59	9.83	3.59	9.94	3.61	10.31	3.57	10.28	3.55
	46	9.24	3.46	9.27	3.51	9.28	3.52	9.30	3.56	9.85	3.56	9.96	3.55
1.6 + 1.6 + 2.5 + 5.0	22	10.29	1.43	9.35	1.49	9.04	1.51	8.41	1.55	10.53	1.82	11.94	1.99
	25	10.38	1.98	9.83	2.01	9.64	2.02	9.28	2.04	10.83	2.21	11.87	2.32
	29	10.54	2.57	10.32	2.57	10.24	2.57	10.09	2.57	11.06	2.64	11.70	2.69
	32	10.36	2.91	10.41	2.89	10.43	2.89	10.46	2.88	11.10	2.90	11.53	2.91
	35	10.25	3.15	10.42	3.13	10.48	3.12	10.60	3.11	11.03	3.09	11.32	3.08
	40	9.92	3.34	10.14	3.34	10.21	3.34	10.36	3.33	10.32	3.29	10.60	3.27
	43	9.61	3.33	9.77	3.35	9.83	3.35	9.94	3.37	10.31	3.34	10.28	3.32
	46	9.24	3.23	9.27	3.28	9.28	3.29	9.30	3.32	9.85	3.32	9.96	3.32
1.6 + 1.6 + 2.5 + 6.0	22	10.29	1.43	9.35	1.49	9.04	1.51	8.41	1.55	10.53	1.82	11.94	1.99
	25	10.38	1.98	9.83	2.01	9.64	2.02	9.28	2.04	10.83	2.21	11.87	2.32
	29	10.54	2.57	10.32	2.57	10.24	2.57	10.09	2.57	11.06	2.64	11.70	2.69
	32	10.36	2.91	10.41	2.89	10.43	2.89	10.46	2.88	11.10	2.90	11.53	2.91
	35	10.25	3.15	10.42	3.13	10.48	3.12	10.60	3.11	11.03	3.09	11.32	3.08
	40	9.92	3.34	10.14	3.34	10.21	3.34	10.36	3.33	10.32	3.29	10.60	3.27
	43	9.61	3.33	9.77	3.35	9.83	3.35	9.94	3.37	10.31	3.34	10.28	3.32
	46	9.24	3.23	9.27	3.28	9.28	3.29	9.30	3.32	9.85	3.32	9.96	3.32

Combination (Capacity)	Outdoor Air Temp. °C DB	Indoor Air Temp. °C											
		27/16		27/17.5		27/18		27/19		27/22		27/24	
		Total Q	Input Power	Total Q	Input Power	Total Q	Input Power	Total Q	Input Power	Total Q	Input Power	Total Q	Input Power
1.6 + 1.6 + 2.5 + 7.1	22	10.48	1.46	9.53	1.52	9.21	1.54	8.57	1.59	10.73	1.86	12.16	2.04
	25	10.57	2.03	10.01	2.06	9.83	2.07	9.45	2.09	11.04	2.26	12.09	2.37
	29	10.74	2.63	10.51	2.63	10.44	2.63	10.28	2.63	11.26	2.70	11.92	2.75
	32	10.56	2.97	10.61	2.96	10.62	2.95	10.66	2.94	11.31	2.96	11.75	2.98
	35	10.44	3.22	10.62	3.20	10.68	3.19	10.80	3.18	11.24	3.16	11.53	3.15
	40	10.10	3.42	10.33	3.41	10.41	3.41	10.56	3.41	10.52	3.37	10.80	3.34
	43	9.79	3.40	9.96	3.42	10.02	3.43	10.13	3.44	10.51	3.41	10.48	3.39
	46	9.42	3.30	9.45	3.35	9.46	3.37	9.48	3.40	10.03	3.40	10.15	3.39
1.6 + 1.6 + 3.5 + 3.5	22	10.29	1.53	9.35	1.59	9.04	1.62	8.41	1.66	10.53	1.94	11.94	2.13
	25	10.38	2.12	9.83	2.15	9.64	2.16	9.28	2.18	10.83	2.36	11.87	2.48
	29	10.54	2.75	10.32	2.75	10.24	2.75	10.09	2.75	11.06	2.83	11.70	2.88
	32	10.36	3.11	10.41	3.10	10.43	3.09	10.46	3.08	11.10	3.10	11.53	3.12
	35	10.25	3.37	10.42	3.35	10.48	3.34	10.60	3.33	11.03	3.31	11.32	3.30
	40	9.92	3.58	10.14	3.57	10.21	3.57	10.36	3.57	10.32	3.53	10.60	3.50
	43	9.61	3.56	9.77	3.59	9.83	3.59	9.94	3.61	10.31	3.57	10.28	3.55
	46	9.24	3.46	9.27	3.51	9.28	3.52	9.30	3.56	9.85	3.56	9.96	3.55
1.6 + 1.6 + 3.5 + 4.2	22	10.29	1.49	9.35	1.56	9.04	1.58	8.41	1.62	10.53	1.90	11.94	2.08
	25	10.38	2.07	9.83	2.10	9.64	2.11	9.28	2.13	10.83	2.31	11.87	2.42
	29	10.54	2.69	10.32	2.69	10.24	2.69	10.09	2.69	11.06	2.76	11.70	2.81
	32	10.36	3.04	10.41	3.02	10.43	3.02	10.46	3.01	11.10	3.03	11.53	3.04
	35	10.25	3.29	10.42	3.27	10.48	3.26	10.60	3.25	11.03	3.23	11.32	3.22
	40	9.92	3.49	10.14	3.49	10.21	3.49	10.36	3.48	10.32	3.44	10.60	3.41
	43	9.61	3.48	9.77	3.50	9.83	3.51	9.94	3.52	10.31	3.49	10.28	3.47
	46	9.24	3.37	9.27	3.42	9.28	3.44	9.30	3.47	9.85	3.47	9.96	3.47
1.6 + 1.6 + 3.5 + 5.0	22	10.29	1.39	9.35	1.46	9.04	1.48	8.41	1.52	10.53	1.77	11.94	1.95
	25	10.38	1.94	9.83	1.96	9.64	1.97	9.28	1.99	10.83	2.16	11.87	2.26
	29	10.54	2.51	10.32	2.51	10.24	2.51	10.09	2.51	11.06	2.58	11.70	2.63
	32	10.36	2.84	10.41	2.83	10.43	2.82	10.46	2.81	11.10	2.83	11.53	2.84
	35	10.25	3.08	10.42	3.06	10.48	3.05	10.60	3.04	11.03	3.02	11.32	3.01
	40	9.92	3.27	10.14	3.26	10.21	3.26	10.36	3.26	10.32	3.22	10.60	3.19
	43	9.61	3.25	9.77	3.27	9.83	3.28	9.94	3.29	10.31	3.26	10.28	3.24
	46	9.24	3.15	9.27	3.20	9.28	3.22	9.30	3.25	9.85	3.25	9.96	3.24
1.6 + 1.6 + 3.5 + 6.0	22	10.48	1.46	9.53	1.52	9.21	1.54	8.57	1.59	10.73	1.86	12.16	2.04
	25	10.57	2.03	10.01	2.06	9.83	2.07	9.45	2.09	11.04	2.26	12.09	2.37
	29	10.74	2.63	10.51	2.63	10.44	2.63	10.28	2.63	11.26	2.70	11.92	2.75
	32	10.56	2.97	10.61	2.96	10.62	2.95	10.66	2.94	11.31	2.96	11.75	2.98
	35	10.44	3.22	10.62	3.20	10.68	3.19	10.80	3.18	11.24	3.16	11.53	3.15
	40	10.10	3.42	10.33	3.41	10.41	3.41	10.56	3.41	10.52	3.37	10.80	3.34
	43	9.79	3.40	9.96	3.42	10.02	3.43	10.13	3.44	10.51	3.41	10.48	3.39
	46	9.42	3.30	9.45	3.35	9.46	3.37	9.48	3.40	10.03	3.40	10.15	3.39

Combination (Capacity)	Outdoor Air Temp. °C DB	Indoor Air Temp. °C											
		27/16		27/17.5		27/18		27/19		27/22		27/24	
		Total Q	Input Power	Total Q	Input Power	Total Q	Input Power	Total Q	Input Power	Total Q	Input Power	Total Q	Input Power
1.6 + 1.6 + 3.5 + 7.1	22	10.48	1.43	9.53	1.49	9.21	1.51	8.57	1.55	10.73	1.82	12.16	1.99
	25	10.57	1.98	10.01	2.01	9.83	2.02	9.45	2.04	11.04	2.21	12.09	2.32
	29	10.74	2.57	10.51	2.57	10.44	2.57	10.28	2.57	11.26	2.64	11.92	2.69
	32	10.56	2.91	10.61	2.89	10.62	2.89	10.66	2.88	11.31	2.90	11.75	2.91
	35	10.44	3.15	10.62	3.13	10.68	3.12	10.80	3.11	11.24	3.09	11.53	3.08
	40	10.10	3.34	10.33	3.34	10.41	3.34	10.56	3.33	10.52	3.29	10.80	3.27
	43	9.79	3.33	9.96	3.35	10.02	3.35	10.13	3.37	10.51	3.34	10.48	3.32
	46	9.42	3.23	9.45	3.28	9.46	3.29	9.48	3.32	10.03	3.32	10.15	3.32
1.6 + 1.6 + 4.2 + 4.2	22	10.29	1.49	9.35	1.56	9.04	1.58	8.41	1.62	10.53	1.90	11.94	2.08
	25	10.38	2.07	9.83	2.10	9.64	2.11	9.28	2.13	10.83	2.31	11.87	2.42
	29	10.54	2.69	10.32	2.69	10.24	2.69	10.09	2.69	11.06	2.76	11.70	2.81
	32	10.36	3.04	10.41	3.02	10.43	3.02	10.46	3.01	11.10	3.03	11.53	3.04
	35	10.25	3.29	10.42	3.27	10.48	3.26	10.60	3.25	11.03	3.23	11.32	3.22
	40	9.92	3.49	10.14	3.49	10.21	3.49	10.36	3.48	10.32	3.44	10.60	3.41
	43	9.61	3.48	9.77	3.50	9.83	3.51	9.94	3.52	10.31	3.49	10.28	3.47
	46	9.24	3.37	9.27	3.42	9.28	3.44	9.30	3.47	9.85	3.47	9.96	3.47
1.6 + 1.6 + 4.2 + 5.0	22	10.48	1.46	9.53	1.52	9.21	1.54	8.57	1.59	10.73	1.86	12.16	2.04
	25	10.57	2.03	10.01	2.06	9.83	2.07	9.45	2.09	11.04	2.26	12.09	2.37
	29	10.74	2.63	10.51	2.63	10.44	2.63	10.28	2.63	11.26	2.70	11.92	2.75
	32	10.56	2.97	10.61	2.96	10.62	2.95	10.66	2.94	11.31	2.96	11.75	2.98
	35	10.44	3.22	10.62	3.20	10.68	3.19	10.80	3.18	11.24	3.16	11.53	3.15
	40	10.10	3.42	10.33	3.41	10.41	3.41	10.56	3.41	10.52	3.37	10.80	3.34
	43	9.79	3.40	9.96	3.42	10.02	3.43	10.13	3.44	10.51	3.41	10.48	3.39
	46	9.42	3.30	9.45	3.35	9.46	3.37	9.48	3.40	10.03	3.40	10.15	3.39
1.6 + 1.6 + 4.2 + 6.0	22	10.48	1.46	9.53	1.52	9.21	1.54	8.57	1.59	10.73	1.86	12.16	2.04
	25	10.57	2.03	10.01	2.06	9.83	2.07	9.45	2.09	11.04	2.26	12.09	2.37
	29	10.74	2.63	10.51	2.63	10.44	2.63	10.28	2.63	11.26	2.70	11.92	2.75
	32	10.56	2.97	10.61	2.96	10.62	2.95	10.66	2.94	11.31	2.96	11.75	2.98
	35	10.44	3.22	10.62	3.20	10.68	3.19	10.80	3.18	11.24	3.16	11.53	3.15
	40	10.10	3.42	10.33	3.41	10.41	3.41	10.56	3.41	10.52	3.37	10.80	3.34
	43	9.79	3.40	9.96	3.42	10.02	3.43	10.13	3.44	10.51	3.41	10.48	3.39
	46	9.42	3.30	9.45	3.35	9.46	3.37	9.48	3.40	10.03	3.40	10.15	3.39
1.6 + 1.6 + 4.2 + 7.1	22	10.68	1.49	9.70	1.56	9.38	1.58	8.73	1.63	10.93	1.90	12.39	2.09
	25	10.77	2.08	10.20	2.11	10.01	2.12	9.63	2.14	11.24	2.31	12.32	2.43
	29	10.94	2.69	10.71	2.69	10.63	2.69	10.47	2.69	11.47	2.77	12.14	2.82
	32	10.76	3.05	10.80	3.03	10.82	3.03	10.85	3.02	11.52	3.04	11.97	3.05
	35	10.63	3.30	10.82	3.28	10.88	3.27	11.00	3.26	11.45	3.24	11.75	3.23
	40	10.29	3.50	10.52	3.50	10.60	3.50	10.76	3.49	10.71	3.45	11.00	3.42
	43	9.97	3.49	10.14	3.51	10.20	3.52	10.31	3.53	10.70	3.50	10.67	3.48
	46	9.59	3.38	9.62	3.43	9.63	3.45	9.65	3.48	10.22	3.48	10.34	3.48

Combination (Capacity)	Outdoor Air Temp. °C DB	Indoor Air Temp. °C											
		27/16		27/17.5		27/18		27/19		27/22		27/24	
		Total Q	Input Power	Total Q	Input Power	Total Q	Input Power	Total Q	Input Power	Total Q	Input Power	Total Q	Input Power
1.6 + 1.6 + 5.0 + 5.0	22	10.48	1.37	9.53	1.43	9.21	1.45	8.57	1.49	10.73	1.74	12.16	1.91
	25	10.57	1.90	10.01	1.93	9.83	1.94	9.45	1.95	11.04	2.11	12.09	2.22
	29	10.74	2.46	10.51	2.46	10.44	2.46	10.28	2.46	11.26	2.53	11.92	2.57
	32	10.56	2.78	10.61	2.77	10.62	2.77	10.66	2.76	11.31	2.78	11.75	2.79
	35	10.44	3.02	10.62	3.00	10.68	2.99	10.80	2.98	11.24	2.96	11.53	2.95
	40	10.10	3.20	10.33	3.20	10.41	3.20	10.56	3.19	10.52	3.16	10.80	3.13
	43	9.79	3.19	9.96	3.21	10.02	3.21	10.13	3.23	10.51	3.20	10.48	3.18
	46	9.42	3.09	9.45	3.14	9.46	3.15	9.48	3.19	10.03	3.18	10.15	3.18
1.6 + 1.6 + 5.0 + 6.0	22	10.68	1.43	9.70	1.49	9.38	1.52	8.73	1.56	10.93	1.82	12.39	2.00
	25	10.77	1.99	10.20	2.02	10.01	2.03	9.63	2.05	11.24	2.21	12.32	2.32
	29	10.94	2.58	10.71	2.58	10.63	2.58	10.47	2.58	11.47	2.65	12.14	2.70
	32	10.76	2.91	10.80	2.90	10.82	2.90	10.85	2.89	11.52	2.91	11.97	2.92
	35	10.63	3.16	10.82	3.14	10.88	3.13	11.00	3.12	11.45	3.10	11.75	3.09
	40	10.29	3.35	10.52	3.35	10.60	3.35	10.76	3.34	10.71	3.30	11.00	3.28
	43	9.97	3.34	10.14	3.36	10.20	3.37	10.31	3.38	10.70	3.35	10.67	3.33
	46	9.59	3.24	9.62	3.29	9.63	3.30	9.65	3.33	10.22	3.33	10.34	3.33
1.6 + 1.6 + 5.0 + 7.1	22	10.68	1.43	9.70	1.49	9.38	1.52	8.73	1.56	10.93	1.82	12.39	2.00
	25	10.77	1.99	10.20	2.02	10.01	2.03	9.63	2.05	11.24	2.21	12.32	2.32
	29	10.94	2.58	10.71	2.58	10.63	2.58	10.47	2.58	11.47	2.65	12.14	2.70
	32	10.76	2.91	10.80	2.90	10.82	2.90	10.85	2.89	11.52	2.91	11.97	2.92
	35	10.63	3.16	10.82	3.14	10.88	3.13	11.00	3.12	11.45	3.10	11.75	3.09
	40	10.29	3.35	10.52	3.35	10.60	3.35	10.76	3.34	10.71	3.30	11.00	3.28
	43	9.97	3.34	10.14	3.36	10.20	3.37	10.31	3.38	10.70	3.35	10.67	3.33
	46	9.59	3.24	9.62	3.29	9.63	3.30	9.65	3.33	10.22	3.33	10.34	3.33
1.6 + 1.6 + 6.0 + 6.0	22	10.68	1.43	9.70	1.49	9.38	1.52	8.73	1.56	10.93	1.82	12.39	2.00
	25	10.77	1.99	10.20	2.02	10.01	2.03	9.63	2.05	11.24	2.21	12.32	2.32
	29	10.94	2.58	10.71	2.58	10.63	2.58	10.47	2.58	11.47	2.65	12.14	2.70
	32	10.76	2.91	10.80	2.90	10.82	2.90	10.85	2.89	11.52	2.91	11.97	2.92
	35	10.63	3.16	10.82	3.14	10.88	3.13	11.00	3.12	11.45	3.10	11.75	3.09
	40	10.29	3.35	10.52	3.35	10.60	3.35	10.76	3.34	10.71	3.30	11.00	3.28
	43	9.97	3.34	10.14	3.36	10.20	3.37	10.31	3.38	10.70	3.35	10.67	3.33
	46	9.59	3.24	9.62	3.29	9.63	3.30	9.65	3.33	10.22	3.33	10.34	3.33
1.6 + 1.6 + 6.0 + 7.1	22	10.87	1.47	9.88	1.53	9.55	1.55	8.89	1.60	11.12	1.87	12.61	2.05
	25	10.96	2.04	10.38	2.07	10.19	2.08	9.80	2.10	11.45	2.27	12.54	2.38
	29	11.14	2.64	10.90	2.64	10.82	2.64	10.66	2.64	11.68	2.72	12.36	2.76
	32	10.95	2.99	11.00	2.97	11.02	2.97	11.05	2.96	11.73	2.98	12.18	2.99
	35	10.83	3.24	11.01	3.22	11.08	3.21	11.20	3.20	11.66	3.18	11.96	3.17
	40	10.48	3.44	10.71	3.44	10.79	3.43	10.95	3.43	10.91	3.39	11.20	3.36
	43	10.15	3.43	10.33	3.45	10.39	3.45	10.50	3.47	10.90	3.44	10.86	3.42
	46	9.77	3.32	9.80	3.37	9.81	3.39	9.83	3.42	10.41	3.42	10.53	3.42

Combination (Capacity)	Outdoor Air Temp. °C DB	Indoor Air Temp. °C											
		27/16		27/17.5		27/18		27/19		27/22		27/24	
		Total Q	Input Power	Total Q	Input Power	Total Q	Input Power	Total Q	Input Power	Total Q	Input Power	Total Q	Input Power
1.6 + 1.6 + 7.1 + 7.1	22	10.87	1.47	9.88	1.53	9.55	1.55	8.89	1.60	11.12	1.87	12.61	2.05
	25	10.96	2.04	10.38	2.07	10.19	2.08	9.80	2.10	11.45	2.27	12.54	2.38
	29	11.14	2.64	10.90	2.64	10.82	2.64	10.66	2.64	11.68	2.72	12.36	2.76
	32	10.95	2.99	11.00	2.97	11.02	2.97	11.05	2.96	11.73	2.98	12.18	2.99
	35	10.83	3.24	11.01	3.22	11.08	3.21	11.20	3.20	11.66	3.18	11.96	3.17
	40	10.48	3.44	10.71	3.44	10.79	3.43	10.95	3.43	10.91	3.39	11.20	3.36
	43	10.15	3.43	10.33	3.45	10.39	3.45	10.50	3.47	10.90	3.44	10.86	3.42
	46	9.77	3.32	9.80	3.37	9.81	3.39	9.83	3.42	10.41	3.42	10.53	3.42
1.6 + 2.0 + 2.0 + 2.0	22	10.29	1.56	9.35	1.63	9.04	1.65	8.41	1.70	10.53	1.98	11.94	2.18
	25	10.38	2.17	9.83	2.20	9.64	2.21	9.28	2.23	10.83	2.41	11.87	2.53
	29	10.54	2.81	10.32	2.81	10.24	2.81	10.09	2.81	11.06	2.89	11.70	2.94
	32	10.36	3.18	10.41	3.16	10.43	3.16	10.46	3.14	11.10	3.17	11.53	3.18
	35	10.25	3.44	10.42	3.42	10.48	3.41	10.60	3.40	11.03	3.38	11.32	3.37
	40	9.92	3.66	10.14	3.65	10.21	3.65	10.36	3.64	10.32	3.60	10.60	3.57
	43	9.61	3.64	9.77	3.66	9.83	3.67	9.94	3.68	10.31	3.65	10.28	3.63
	46	9.24	3.53	9.27	3.58	9.28	3.60	9.30	3.63	9.85	3.63	9.96	3.63
1.6 + 2.0 + 2.0 + 2.5	22	10.29	1.56	9.35	1.63	9.04	1.65	8.41	1.70	10.53	1.98	11.94	2.18
	25	10.38	2.17	9.83	2.20	9.64	2.21	9.28	2.23	10.83	2.41	11.87	2.53
	29	10.54	2.81	10.32	2.81	10.24	2.81	10.09	2.81	11.06	2.89	11.70	2.94
	32	10.36	3.18	10.41	3.16	10.43	3.16	10.46	3.14	11.10	3.17	11.53	3.18
	35	10.25	3.44	10.42	3.42	10.48	3.41	10.60	3.40	11.03	3.38	11.32	3.37
	40	9.92	3.66	10.14	3.65	10.21	3.65	10.36	3.64	10.32	3.60	10.60	3.57
	43	9.61	3.64	9.77	3.66	9.83	3.67	9.94	3.68	10.31	3.65	10.28	3.63
	46	9.24	3.53	9.27	3.58	9.28	3.60	9.30	3.63	9.85	3.63	9.96	3.63
1.6 + 2.0 + 2.0 + 3.5	22	10.29	1.53	9.35	1.59	9.04	1.62	8.41	1.66	10.53	1.94	11.94	2.13
	25	10.38	2.12	9.83	2.15	9.64	2.16	9.28	2.18	10.83	2.36	11.87	2.48
	29	10.54	2.75	10.32	2.75	10.24	2.75	10.09	2.75	11.06	2.83	11.70	2.88
	32	10.36	3.11	10.41	3.10	10.43	3.09	10.46	3.08	11.10	3.10	11.53	3.12
	35	10.25	3.37	10.42	3.35	10.48	3.34	10.60	3.33	11.03	3.31	11.32	3.30
	40	9.92	3.58	10.14	3.57	10.21	3.57	10.36	3.57	10.32	3.53	10.60	3.50
	43	9.61	3.56	9.77	3.59	9.83	3.59	9.94	3.61	10.31	3.57	10.28	3.55
	46	9.24	3.46	9.27	3.51	9.28	3.52	9.30	3.56	9.85	3.56	9.96	3.55
1.6 + 2.0 + 2.0 + 4.2	22	10.29	1.53	9.35	1.59	9.04	1.62	8.41	1.66	10.53	1.94	11.94	2.13
	25	10.38	2.12	9.83	2.15	9.64	2.16	9.28	2.18	10.83	2.36	11.87	2.48
	29	10.54	2.75	10.32	2.75	10.24	2.75	10.09	2.75	11.06	2.83	11.70	2.88
	32	10.36	3.11	10.41	3.10	10.43	3.09	10.46	3.08	11.10	3.10	11.53	3.12
	35	10.25	3.37	10.42	3.35	10.48	3.34	10.60	3.33	11.03	3.31	11.32	3.30
	40	9.92	3.58	10.14	3.57	10.21	3.57	10.36	3.57	10.32	3.53	10.60	3.50
	43	9.61	3.56	9.77	3.59	9.83	3.59	9.94	3.61	10.31	3.57	10.28	3.55
	46	9.24	3.46	9.27	3.51	9.28	3.52	9.30	3.56	9.85	3.56	9.96	3.55



Combination (Capacity)	Outdoor Air Temp. °C DB	Indoor Air Temp. °C											
		27/16		27/17.5		27/18		27/19		27/22		27/24	
		Total Q	Input Power	Total Q	Input Power	Total Q	Input Power	Total Q	Input Power	Total Q	Input Power	Total Q	Input Power
1.6 + 2.0 + 2.0 + 5.0	22	10.29	1.39	9.35	1.46	9.04	1.48	8.41	1.52	10.53	1.77	11.94	1.95
	25	10.38	1.94	9.83	1.96	9.64	1.97	9.28	1.99	10.83	2.16	11.87	2.26
	29	10.54	2.51	10.32	2.51	10.24	2.51	10.09	2.51	11.06	2.58	11.70	2.63
	32	10.36	2.84	10.41	2.83	10.43	2.82	10.46	2.81	11.10	2.83	11.53	2.84
	35	10.25	3.08	10.42	3.06	10.48	3.05	10.60	3.04	11.03	3.02	11.32	3.01
	40	9.92	3.27	10.14	3.26	10.21	3.26	10.36	3.26	10.32	3.22	10.60	3.19
	43	9.61	3.25	9.77	3.27	9.83	3.28	9.94	3.29	10.31	3.26	10.28	3.24
	46	9.24	3.15	9.27	3.20	9.28	3.22	9.30	3.25	9.85	3.25	9.96	3.24
1.6 + 2.0 + 2.0 + 6.0	22	10.29	1.39	9.35	1.46	9.04	1.48	8.41	1.52	10.53	1.77	11.94	1.95
	25	10.38	1.94	9.83	1.96	9.64	1.97	9.28	1.99	10.83	2.16	11.87	2.26
	29	10.54	2.51	10.32	2.51	10.24	2.51	10.09	2.51	11.06	2.58	11.70	2.63
	32	10.36	2.84	10.41	2.83	10.43	2.82	10.46	2.81	11.10	2.83	11.53	2.84
	35	10.25	3.08	10.42	3.06	10.48	3.05	10.60	3.04	11.03	3.02	11.32	3.01
	40	9.92	3.27	10.14	3.26	10.21	3.26	10.36	3.26	10.32	3.22	10.60	3.19
	43	9.61	3.25	9.77	3.27	9.83	3.28	9.94	3.29	10.31	3.26	10.28	3.24
	46	9.24	3.15	9.27	3.20	9.28	3.22	9.30	3.25	9.85	3.25	9.96	3.24
1.6 + 2.0 + 2.0 + 7.1	22	10.48	1.43	9.53	1.49	9.21	1.51	8.57	1.55	10.73	1.82	12.16	1.99
	25	10.57	1.98	10.01	2.01	9.83	2.02	9.45	2.04	11.04	2.21	12.09	2.32
	29	10.74	2.57	10.51	2.57	10.44	2.57	10.28	2.57	11.26	2.64	11.92	2.69
	32	10.56	2.91	10.61	2.89	10.62	2.89	10.66	2.88	11.31	2.90	11.75	2.91
	35	10.44	3.15	10.62	3.13	10.68	3.12	10.80	3.11	11.24	3.09	11.53	3.08
	40	10.10	3.34	10.33	3.34	10.41	3.34	10.56	3.33	10.52	3.29	10.80	3.27
	43	9.79	3.33	9.96	3.35	10.02	3.35	10.13	3.37	10.51	3.34	10.48	3.32
	46	9.42	3.23	9.45	3.28	9.46	3.29	9.48	3.32	10.03	3.32	10.15	3.32
1.6 + 2.0 + 2.5 + 2.5	22	10.29	1.56	9.35	1.63	9.04	1.65	8.41	1.70	10.53	1.98	11.94	2.18
	25	10.38	2.17	9.83	2.20	9.64	2.21	9.28	2.23	10.83	2.41	11.87	2.53
	29	10.54	2.81	10.32	2.81	10.24	2.81	10.09	2.81	11.06	2.89	11.70	2.94
	32	10.36	3.18	10.41	3.16	10.43	3.16	10.46	3.14	11.10	3.17	11.53	3.18
	35	10.25	3.44	10.42	3.42	10.48	3.41	10.60	3.40	11.03	3.38	11.32	3.37
	40	9.92	3.66	10.14	3.65	10.21	3.65	10.36	3.64	10.32	3.60	10.60	3.57
	43	9.61	3.64	9.77	3.66	9.83	3.67	9.94	3.68	10.31	3.65	10.28	3.63
	46	9.24	3.53	9.27	3.58	9.28	3.60	9.30	3.63	9.85	3.63	9.96	3.63
1.6 + 2.0 + 2.5 + 3.5	22	10.29	1.53	9.35	1.59	9.04	1.62	8.41	1.66	10.53	1.94	11.94	2.13
	25	10.38	2.12	9.83	2.15	9.64	2.16	9.28	2.18	10.83	2.36	11.87	2.48
	29	10.54	2.75	10.32	2.75	10.24	2.75	10.09	2.75	11.06	2.83	11.70	2.88
	32	10.36	3.11	10.41	3.10	10.43	3.09	10.46	3.08	11.10	3.10	11.53	3.12
	35	10.25	3.37	10.42	3.35	10.48	3.34	10.60	3.33	11.03	3.31	11.32	3.30
	40	9.92	3.58	10.14	3.57	10.21	3.57	10.36	3.57	10.32	3.53	10.60	3.50
	43	9.61	3.56	9.77	3.59	9.83	3.59	9.94	3.61	10.31	3.57	10.28	3.55
	46	9.24	3.46	9.27	3.51	9.28	3.52	9.30	3.56	9.85	3.56	9.96	3.55

Combination (Capacity)	Outdoor Air Temp. °C DB	Indoor Air Temp. °C											
		27/16		27/17.5		27/18		27/19		27/22		27/24	
		Total Q	Input Power	Total Q	Input Power	Total Q	Input Power	Total Q	Input Power	Total Q	Input Power	Total Q	Input Power
1.6 + 2.0 + 2.5 + 4.2	22	10.29	1.53	9.35	1.59	9.04	1.62	8.41	1.66	10.53	1.94	11.94	2.13
	25	10.38	2.12	9.83	2.15	9.64	2.16	9.28	2.18	10.83	2.36	11.87	2.48
	29	10.54	2.75	10.32	2.75	10.24	2.75	10.09	2.75	11.06	2.83	11.70	2.88
	32	10.36	3.11	10.41	3.10	10.43	3.09	10.46	3.08	11.10	3.10	11.53	3.12
	35	10.25	3.37	10.42	3.35	10.48	3.34	10.60	3.33	11.03	3.31	11.32	3.30
	40	9.92	3.58	10.14	3.57	10.21	3.57	10.36	3.57	10.32	3.53	10.60	3.50
	43	9.61	3.56	9.77	3.59	9.83	3.59	9.94	3.61	10.31	3.57	10.28	3.55
	46	9.24	3.46	9.27	3.51	9.28	3.52	9.30	3.56	9.85	3.56	9.96	3.55
1.6 + 2.0 + 2.5 + 5.0	22	10.29	1.39	9.35	1.46	9.04	1.48	8.41	1.52	10.53	1.77	11.94	1.95
	25	10.38	1.94	9.83	1.96	9.64	1.97	9.28	1.99	10.83	2.16	11.87	2.26
	29	10.54	2.51	10.32	2.51	10.24	2.51	10.09	2.51	11.06	2.58	11.70	2.63
	32	10.36	2.84	10.41	2.83	10.43	2.82	10.46	2.81	11.10	2.83	11.53	2.84
	35	10.25	3.08	10.42	3.06	10.48	3.05	10.60	3.04	11.03	3.02	11.32	3.01
	40	9.92	3.27	10.14	3.26	10.21	3.26	10.36	3.26	10.32	3.22	10.60	3.19
	43	9.61	3.25	9.77	3.27	9.83	3.28	9.94	3.29	10.31	3.26	10.28	3.24
	46	9.24	3.15	9.27	3.20	9.28	3.22	9.30	3.25	9.85	3.25	9.96	3.24
1.6 + 2.0 + 2.5 + 6.0	22	10.48	1.46	9.53	1.52	9.21	1.54	8.57	1.59	10.73	1.86	12.16	2.04
	25	10.57	2.03	10.01	2.06	9.83	2.07	9.45	2.09	11.04	2.26	12.09	2.37
	29	10.74	2.63	10.51	2.63	10.44	2.63	10.28	2.63	11.26	2.70	11.92	2.75
	32	10.56	2.97	10.61	2.96	10.62	2.95	10.66	2.94	11.31	2.96	11.75	2.98
	35	10.44	3.22	10.62	3.20	10.68	3.19	10.80	3.18	11.24	3.16	11.53	3.15
	40	10.10	3.42	10.33	3.41	10.41	3.41	10.56	3.41	10.52	3.37	10.80	3.34
	43	9.79	3.40	9.96	3.42	10.02	3.43	10.13	3.44	10.51	3.41	10.48	3.39
	46	9.42	3.30	9.45	3.35	9.46	3.37	9.48	3.40	10.03	3.40	10.15	3.39
1.6 + 2.0 + 2.5 + 7.1	22	10.48	1.43	9.53	1.49	9.21	1.51	8.57	1.55	10.73	1.82	12.16	1.99
	25	10.57	1.98	10.01	2.01	9.83	2.02	9.45	2.04	11.04	2.21	12.09	2.32
	29	10.74	2.57	10.51	2.57	10.44	2.57	10.28	2.57	11.26	2.64	11.92	2.69
	32	10.56	2.91	10.61	2.89	10.62	2.89	10.66	2.88	11.31	2.90	11.75	2.91
	35	10.44	3.15	10.62	3.13	10.68	3.12	10.80	3.11	11.24	3.09	11.53	3.08
	40	10.10	3.34	10.33	3.34	10.41	3.34	10.56	3.33	10.52	3.29	10.80	3.27
	43	9.79	3.33	9.96	3.35	10.02	3.35	10.13	3.37	10.51	3.34	10.48	3.32
	46	9.42	3.23	9.45	3.28	9.46	3.29	9.48	3.32	10.03	3.32	10.15	3.32
1.6 + 2.0 + 3.5 + 3.5	22	10.29	1.49	9.35	1.56	9.04	1.58	8.41	1.62	10.53	1.90	11.94	2.08
	25	10.38	2.07	9.83	2.10	9.64	2.11	9.28	2.13	10.83	2.31	11.87	2.42
	29	10.54	2.69	10.32	2.69	10.24	2.69	10.09	2.69	11.06	2.76	11.70	2.81
	32	10.36	3.04	10.41	3.02	10.43	3.02	10.46	3.01	11.10	3.03	11.53	3.04
	35	10.25	3.29	10.42	3.27	10.48	3.26	10.60	3.25	11.03	3.23	11.32	3.22
	40	9.92	3.49	10.14	3.49	10.21	3.49	10.36	3.48	10.32	3.44	10.60	3.41
	43	9.61	3.48	9.77	3.50	9.83	3.51	9.94	3.52	10.31	3.49	10.28	3.47
	46	9.24	3.37	9.27	3.42	9.28	3.44	9.30	3.47	9.85	3.47	9.96	3.47

Combination (Capacity)	Outdoor Air Temp. °C DB	Indoor Air Temp. °C											
		27/16		27/17.5		27/18		27/19		27/22		27/24	
		Total Q	Input Power	Total Q	Input Power	Total Q	Input Power	Total Q	Input Power	Total Q	Input Power	Total Q	Input Power
1.6 + 2.0 + 3.5 + 4.2	22	10.29	1.49	9.35	1.56	9.04	1.58	8.41	1.62	10.53	1.90	11.94	2.08
	25	10.38	2.07	9.83	2.10	9.64	2.11	9.28	2.13	10.83	2.31	11.87	2.42
	29	10.54	2.69	10.32	2.69	10.24	2.69	10.09	2.69	11.06	2.76	11.70	2.81
	32	10.36	3.04	10.41	3.02	10.43	3.02	10.46	3.01	11.10	3.03	11.53	3.04
	35	10.25	3.29	10.42	3.27	10.48	3.26	10.60	3.25	11.03	3.23	11.32	3.22
	40	9.92	3.49	10.14	3.49	10.21	3.49	10.36	3.48	10.32	3.44	10.60	3.41
	43	9.61	3.48	9.77	3.50	9.83	3.51	9.94	3.52	10.31	3.49	10.28	3.47
	46	9.24	3.37	9.27	3.42	9.28	3.44	9.30	3.47	9.85	3.47	9.96	3.47
1.6 + 2.0 + 3.5 + 5.0	22	10.48	1.46	9.53	1.52	9.21	1.54	8.57	1.59	10.73	1.86	12.16	2.04
	25	10.57	2.03	10.01	2.06	9.83	2.07	9.45	2.09	11.04	2.26	12.09	2.37
	29	10.74	2.63	10.51	2.63	10.44	2.63	10.28	2.63	11.26	2.70	11.92	2.75
	32	10.56	2.97	10.61	2.96	10.62	2.95	10.66	2.94	11.31	2.96	11.75	2.98
	35	10.44	3.22	10.62	3.20	10.68	3.19	10.80	3.18	11.24	3.16	11.53	3.15
	40	10.10	3.42	10.33	3.41	10.41	3.41	10.56	3.41	10.52	3.37	10.80	3.34
	43	9.79	3.40	9.96	3.42	10.02	3.43	10.13	3.44	10.51	3.41	10.48	3.39
	46	9.42	3.30	9.45	3.35	9.46	3.37	9.48	3.40	10.03	3.40	10.15	3.39
1.6 + 2.0 + 3.5 + 6.0	22	10.48	1.46	9.53	1.52	9.21	1.54	8.57	1.59	10.73	1.86	12.16	2.04
	25	10.57	2.03	10.01	2.06	9.83	2.07	9.45	2.09	11.04	2.26	12.09	2.37
	29	10.74	2.63	10.51	2.63	10.44	2.63	10.28	2.63	11.26	2.70	11.92	2.75
	32	10.56	2.97	10.61	2.96	10.62	2.95	10.66	2.94	11.31	2.96	11.75	2.98
	35	10.44	3.22	10.62	3.20	10.68	3.19	10.80	3.18	11.24	3.16	11.53	3.15
	40	10.10	3.42	10.33	3.41	10.41	3.41	10.56	3.41	10.52	3.37	10.80	3.34
	43	9.79	3.40	9.96	3.42	10.02	3.43	10.13	3.44	10.51	3.41	10.48	3.39
	46	9.42	3.30	9.45	3.35	9.46	3.37	9.48	3.40	10.03	3.40	10.15	3.39
1.6 + 2.0 + 3.5 + 7.1	22	10.68	1.49	9.70	1.56	9.38	1.58	8.73	1.63	10.93	1.90	12.39	2.09
	25	10.77	2.08	10.20	2.11	10.01	2.12	9.63	2.14	11.24	2.31	12.32	2.43
	29	10.94	2.69	10.71	2.69	10.63	2.69	10.47	2.69	11.47	2.77	12.14	2.82
	32	10.76	3.05	10.80	3.03	10.82	3.03	10.85	3.02	11.52	3.04	11.97	3.05
	35	10.63	3.30	10.82	3.28	10.88	3.27	11.00	3.26	11.45	3.24	11.75	3.23
	40	10.29	3.50	10.52	3.50	10.60	3.50	10.76	3.49	10.71	3.45	11.00	3.42
	43	9.97	3.49	10.14	3.51	10.20	3.52	10.31	3.53	10.70	3.50	10.67	3.48
	46	9.59	3.38	9.62	3.43	9.63	3.45	9.65	3.48	10.22	3.48	10.34	3.48
1.6 + 2.0 + 4.2 + 4.2	22	10.29	1.49	9.35	1.56	9.04	1.58	8.41	1.62	10.53	1.90	11.94	2.08
	25	10.38	2.07	9.83	2.10	9.64	2.11	9.28	2.13	10.83	2.31	11.87	2.42
	29	10.54	2.69	10.32	2.69	10.24	2.69	10.09	2.69	11.06	2.76	11.70	2.81
	32	10.36	3.04	10.41	3.02	10.43	3.02	10.46	3.01	11.10	3.03	11.53	3.04
	35	10.25	3.29	10.42	3.27	10.48	3.26	10.60	3.25	11.03	3.23	11.32	3.22
	40	9.92	3.49	10.14	3.49	10.21	3.49	10.36	3.48	10.32	3.44	10.60	3.41
	43	9.61	3.48	9.77	3.50	9.83	3.51	9.94	3.52	10.31	3.49	10.28	3.47
	46	9.24	3.37	9.27	3.42	9.28	3.44	9.30	3.47	9.85	3.47	9.96	3.47

Combination (Capacity)	Outdoor Air Temp. °C DB	Indoor Air Temp. °C											
		27/16		27/17.5		27/18		27/19		27/22		27/24	
		Total Q	Input Power	Total Q	Input Power	Total Q	Input Power	Total Q	Input Power	Total Q	Input Power	Total Q	Input Power
1.6 + 2.0 + 4.2 + 5.0	22	10.48	1.43	9.53	1.49	9.21	1.51	8.57	1.55	10.73	1.82	12.16	1.99
	25	10.57	1.98	10.01	2.01	9.83	2.02	9.45	2.04	11.04	2.21	12.09	2.32
	29	10.74	2.57	10.51	2.57	10.44	2.57	10.28	2.57	11.26	2.64	11.92	2.69
	32	10.56	2.91	10.61	2.89	10.62	2.89	10.66	2.88	11.31	2.90	11.75	2.91
	35	10.44	3.15	10.62	3.13	10.68	3.12	10.80	3.11	11.24	3.09	11.53	3.08
	40	10.10	3.34	10.33	3.34	10.41	3.34	10.56	3.33	10.52	3.29	10.80	3.27
	43	9.79	3.33	9.96	3.35	10.02	3.35	10.13	3.37	10.51	3.34	10.48	3.32
	46	9.42	3.23	9.45	3.28	9.46	3.29	9.48	3.32	10.03	3.32	10.15	3.32
1.6 + 2.0 + 4.2 + 6.0	22	10.48	1.43	9.53	1.49	9.21	1.51	8.57	1.55	10.73	1.82	12.16	1.99
	25	10.57	1.98	10.01	2.01	9.83	2.02	9.45	2.04	11.04	2.21	12.09	2.32
	29	10.74	2.57	10.51	2.57	10.44	2.57	10.28	2.57	11.26	2.64	11.92	2.69
	32	10.56	2.91	10.61	2.89	10.62	2.89	10.66	2.88	11.31	2.90	11.75	2.91
	35	10.44	3.15	10.62	3.13	10.68	3.12	10.80	3.11	11.24	3.09	11.53	3.08
	40	10.10	3.34	10.33	3.34	10.41	3.34	10.56	3.33	10.52	3.29	10.80	3.27
	43	9.79	3.33	9.96	3.35	10.02	3.35	10.13	3.37	10.51	3.34	10.48	3.32
	46	9.42	3.23	9.45	3.28	9.46	3.29	9.48	3.32	10.03	3.32	10.15	3.32
1.6 + 2.0 + 4.2 + 7.1	22	10.68	1.46	9.70	1.53	9.38	1.55	8.73	1.59	10.93	1.86	12.39	2.04
	25	10.77	2.03	10.20	2.06	10.01	2.07	9.63	2.09	11.24	2.26	12.32	2.38
	29	10.94	2.64	10.71	2.64	10.63	2.64	10.47	2.64	11.47	2.71	12.14	2.76
	32	10.76	2.98	10.80	2.97	10.82	2.96	10.85	2.95	11.52	2.97	11.97	2.99
	35	10.63	3.23	10.82	3.21	10.88	3.20	11.00	3.19	11.45	3.17	11.75	3.16
	40	10.29	3.43	10.52	3.42	10.60	3.42	10.76	3.42	10.71	3.38	11.00	3.35
	43	9.97	3.41	10.14	3.43	10.20	3.44	10.31	3.45	10.70	3.42	10.67	3.40
	46	9.59	3.31	9.62	3.36	9.63	3.38	9.65	3.41	10.22	3.41	10.34	3.40
1.6 + 2.0 + 5.0 + 5.0	22	10.48	1.37	9.53	1.43	9.21	1.45	8.57	1.49	10.73	1.74	12.16	1.91
	25	10.57	1.90	10.01	1.93	9.83	1.94	9.45	1.95	11.04	2.11	12.09	2.22
	29	10.74	2.46	10.51	2.46	10.44	2.46	10.28	2.46	11.26	2.53	11.92	2.57
	32	10.56	2.78	10.61	2.77	10.62	2.77	10.66	2.76	11.31	2.78	11.75	2.79
	35	10.44	3.02	10.62	3.00	10.68	2.99	10.80	2.98	11.24	2.96	11.53	2.95
	40	10.10	3.20	10.33	3.20	10.41	3.20	10.56	3.19	10.52	3.16	10.80	3.13
	43	9.79	3.19	9.96	3.21	10.02	3.21	10.13	3.23	10.51	3.20	10.48	3.18
	46	9.42	3.09	9.45	3.14	9.46	3.15	9.48	3.19	10.03	3.18	10.15	3.18
1.6 + 2.0 + 5.0 + 6.0	22	10.68	1.43	9.70	1.49	9.38	1.52	8.73	1.56	10.93	1.82	12.39	2.00
	25	10.77	1.99	10.20	2.02	10.01	2.03	9.63	2.05	11.24	2.21	12.32	2.32
	29	10.94	2.58	10.71	2.58	10.63	2.58	10.47	2.58	11.47	2.65	12.14	2.70
	32	10.76	2.91	10.80	2.90	10.82	2.90	10.85	2.89	11.52	2.91	11.97	2.92
	35	10.63	3.16	10.82	3.14	10.88	3.13	11.00	3.12	11.45	3.10	11.75	3.09
	40	10.29	3.35	10.52	3.35	10.60	3.35	10.76	3.34	10.71	3.30	11.00	3.28
	43	9.97	3.34	10.14	3.36	10.20	3.37	10.31	3.38	10.70	3.35	10.67	3.33
	46	9.59	3.24	9.62	3.29	9.63	3.30	9.65	3.33	10.22	3.33	10.34	3.33

Combination (Capacity)	Outdoor Air Temp. °C DB	Indoor Air Temp. °C											
		27/16		27/17.5		27/18		27/19		27/22		27/24	
		Total Q	Input Power	Total Q	Input Power	Total Q	Input Power	Total Q	Input Power	Total Q	Input Power	Total Q	Input Power
1.6 + 2.0 + 5.0 + 7.1	22	10.68	1.40	9.70	1.46	9.38	1.48	8.73	1.52	10.93	1.78	12.39	1.95
	25	10.77	1.94	10.20	1.97	10.01	1.98	9.63	2.00	11.24	2.16	12.32	2.27
	29	10.94	2.52	10.71	2.52	10.63	2.52	10.47	2.52	11.47	2.59	12.14	2.63
	32	10.76	2.85	10.80	2.84	10.82	2.83	10.85	2.82	11.52	2.84	11.97	2.85
	35	10.63	3.09	10.82	3.07	10.88	3.06	11.00	3.05	11.45	3.03	11.75	3.02
	40	10.29	3.28	10.52	3.27	10.60	3.27	10.76	3.27	10.71	3.23	11.00	3.20
	43	9.97	3.26	10.14	3.28	10.20	3.29	10.31	3.30	10.70	3.27	10.67	3.26
	46	9.59	3.16	9.62	3.21	9.63	3.23	9.65	3.26	10.22	3.26	10.34	3.26
1.6 + 2.0 + 6.0 + 6.0	22	10.68	1.43	9.70	1.49	9.38	1.52	8.73	1.56	10.93	1.82	12.39	2.00
	25	10.77	1.99	10.20	2.02	10.01	2.03	9.63	2.05	11.24	2.21	12.32	2.32
	29	10.94	2.58	10.71	2.58	10.63	2.58	10.47	2.58	11.47	2.65	12.14	2.70
	32	10.76	2.91	10.80	2.90	10.82	2.90	10.85	2.89	11.52	2.91	11.97	2.92
	35	10.63	3.16	10.82	3.14	10.88	3.13	11.00	3.12	11.45	3.10	11.75	3.09
	40	10.29	3.35	10.52	3.35	10.60	3.35	10.76	3.34	10.71	3.30	11.00	3.28
	43	9.97	3.34	10.14	3.36	10.20	3.37	10.31	3.38	10.70	3.35	10.67	3.33
	46	9.59	3.24	9.62	3.29	9.63	3.30	9.65	3.33	10.22	3.33	10.34	3.33
1.6 + 2.0 + 6.0 + 7.1	22	10.87	1.47	9.88	1.53	9.55	1.55	8.89	1.60	11.12	1.87	12.61	2.05
	25	10.96	2.04	10.38	2.07	10.19	2.08	9.80	2.10	11.45	2.27	12.54	2.38
	29	11.14	2.64	10.90	2.64	10.82	2.64	10.66	2.64	11.68	2.72	12.36	2.76
	32	10.95	2.99	11.00	2.97	11.02	2.97	11.05	2.96	11.73	2.98	12.18	2.99
	35	10.83	3.24	11.01	3.22	11.08	3.21	11.20	3.20	11.66	3.18	11.96	3.17
	40	10.48	3.44	10.71	3.44	10.79	3.43	10.95	3.43	10.91	3.39	11.20	3.36
	43	10.15	3.43	10.33	3.45	10.39	3.45	10.50	3.47	10.90	3.44	10.86	3.42
	46	9.77	3.32	9.80	3.37	9.81	3.39	9.83	3.42	10.41	3.42	10.53	3.42
1.6 + 2.0 + 7.1 + 7.1	22	10.87	1.47	9.88	1.53	9.55	1.55	8.89	1.60	11.12	1.87	12.61	2.05
	25	10.96	2.04	10.38	2.07	10.19	2.08	9.80	2.10	11.45	2.27	12.54	2.38
	29	11.14	2.64	10.90	2.64	10.82	2.64	10.66	2.64	11.68	2.72	12.36	2.76
	32	10.95	2.99	11.00	2.97	11.02	2.97	11.05	2.96	11.73	2.98	12.18	2.99
	35	10.83	3.24	11.01	3.22	11.08	3.21	11.20	3.20	11.66	3.18	11.96	3.17
	40	10.48	3.44	10.71	3.44	10.79	3.43	10.95	3.43	10.91	3.39	11.20	3.36
	43	10.15	3.43	10.33	3.45	10.39	3.45	10.50	3.47	10.90	3.44	10.86	3.42
	46	9.77	3.32	9.80	3.37	9.81	3.39	9.83	3.42	10.41	3.42	10.53	3.42
1.6 + 2.5 + 2.5 + 2.5	22	10.29	1.56	9.35	1.63	9.04	1.65	8.41	1.70	10.53	1.98	11.94	2.18
	25	10.38	2.17	9.83	2.20	9.64	2.21	9.28	2.23	10.83	2.41	11.87	2.53
	29	10.54	2.81	10.32	2.81	10.24	2.81	10.09	2.81	11.06	2.89	11.70	2.94
	32	10.36	3.18	10.41	3.16	10.43	3.16	10.46	3.14	11.10	3.17	11.53	3.18
	35	10.25	3.44	10.42	3.42	10.48	3.41	10.60	3.40	11.03	3.38	11.32	3.37
	40	9.92	3.66	10.14	3.65	10.21	3.65	10.36	3.64	10.32	3.60	10.60	3.57
	43	9.61	3.64	9.77	3.66	9.83	3.67	9.94	3.68	10.31	3.65	10.28	3.63
	46	9.24	3.53	9.27	3.58	9.28	3.60	9.30	3.63	9.85	3.63	9.96	3.63

Combination (Capacity)	Outdoor Air Temp. °C DB	Indoor Air Temp. °C											
		27/16		27/17.5		27/18		27/19		27/22		27/24	
		Total Q	Input Power	Total Q	Input Power	Total Q	Input Power	Total Q	Input Power	Total Q	Input Power	Total Q	Input Power
1.6 + 2.5 + 2.5 + 3.5	22	10.29	1.53	9.35	1.59	9.04	1.62	8.41	1.66	10.53	1.94	11.94	2.13
	25	10.38	2.12	9.83	2.15	9.64	2.16	9.28	2.18	10.83	2.36	11.87	2.48
	29	10.54	2.75	10.32	2.75	10.24	2.75	10.09	2.75	11.06	2.83	11.70	2.88
	32	10.36	3.11	10.41	3.10	10.43	3.09	10.46	3.08	11.10	3.10	11.53	3.12
	35	10.25	3.37	10.42	3.35	10.48	3.34	10.60	3.33	11.03	3.31	11.32	3.30
	40	9.92	3.58	10.14	3.57	10.21	3.57	10.36	3.57	10.32	3.53	10.60	3.50
	43	9.61	3.56	9.77	3.59	9.83	3.59	9.94	3.61	10.31	3.57	10.28	3.55
	46	9.24	3.46	9.27	3.51	9.28	3.52	9.30	3.56	9.85	3.56	9.96	3.55
1.6 + 2.5 + 2.5 + 4.2	22	10.29	1.53	9.35	1.59	9.04	1.62	8.41	1.66	10.53	1.94	11.94	2.13
	25	10.38	2.12	9.83	2.15	9.64	2.16	9.28	2.18	10.83	2.36	11.87	2.48
	29	10.54	2.75	10.32	2.75	10.24	2.75	10.09	2.75	11.06	2.83	11.70	2.88
	32	10.36	3.11	10.41	3.10	10.43	3.09	10.46	3.08	11.10	3.10	11.53	3.12
	35	10.25	3.37	10.42	3.35	10.48	3.34	10.60	3.33	11.03	3.31	11.32	3.30
	40	9.92	3.58	10.14	3.57	10.21	3.57	10.36	3.57	10.32	3.53	10.60	3.50
	43	9.61	3.56	9.77	3.59	9.83	3.59	9.94	3.61	10.31	3.57	10.28	3.55
	46	9.24	3.46	9.27	3.51	9.28	3.52	9.30	3.56	9.85	3.56	9.96	3.55
1.6 + 2.5 + 2.5 + 5.0	22	10.29	1.39	9.35	1.46	9.04	1.48	8.41	1.52	10.53	1.77	11.94	1.95
	25	10.38	1.94	9.83	1.96	9.64	1.97	9.28	1.99	10.83	2.16	11.87	2.26
	29	10.54	2.51	10.32	2.51	10.24	2.51	10.09	2.51	11.06	2.58	11.70	2.63
	32	10.36	2.84	10.41	2.83	10.43	2.82	10.46	2.81	11.10	2.83	11.53	2.84
	35	10.25	3.08	10.42	3.06	10.48	3.05	10.60	3.04	11.03	3.02	11.32	3.01
	40	9.92	3.27	10.14	3.26	10.21	3.26	10.36	3.26	10.32	3.22	10.60	3.19
	43	9.61	3.25	9.77	3.27	9.83	3.28	9.94	3.29	10.31	3.26	10.28	3.24
	46	9.24	3.15	9.27	3.20	9.28	3.22	9.30	3.25	9.85	3.25	9.96	3.24
1.6 + 2.5 + 2.5 + 6.0	22	10.48	1.46	9.53	1.52	9.21	1.54	8.57	1.59	10.73	1.86	12.16	2.04
	25	10.57	2.03	10.01	2.06	9.83	2.07	9.45	2.09	11.04	2.26	12.09	2.37
	29	10.74	2.63	10.51	2.63	10.44	2.63	10.28	2.63	11.26	2.70	11.92	2.75
	32	10.56	2.97	10.61	2.96	10.62	2.95	10.66	2.94	11.31	2.96	11.75	2.98
	35	10.44	3.22	10.62	3.20	10.68	3.19	10.80	3.18	11.24	3.16	11.53	3.15
	40	10.10	3.42	10.33	3.41	10.41	3.41	10.56	3.41	10.52	3.37	10.80	3.34
	43	9.79	3.40	9.96	3.42	10.02	3.43	10.13	3.44	10.51	3.41	10.48	3.39
	46	9.42	3.30	9.45	3.35	9.46	3.37	9.48	3.40	10.03	3.40	10.15	3.39
1.6 + 2.5 + 2.5 + 7.1	22	10.48	1.43	9.53	1.49	9.21	1.51	8.57	1.55	10.73	1.82	12.16	1.99
	25	10.57	1.98	10.01	2.01	9.83	2.02	9.45	2.04	11.04	2.21	12.09	2.32
	29	10.74	2.57	10.51	2.57	10.44	2.57	10.28	2.57	11.26	2.64	11.92	2.69
	32	10.56	2.91	10.61	2.89	10.62	2.89	10.66	2.88	11.31	2.90	11.75	2.91
	35	10.44	3.15	10.62	3.13	10.68	3.12	10.80	3.11	11.24	3.09	11.53	3.08
	40	10.10	3.34	10.33	3.34	10.41	3.34	10.56	3.33	10.52	3.29	10.80	3.27
	43	9.79	3.33	9.96	3.35	10.02	3.35	10.13	3.37	10.51	3.34	10.48	3.32
	46	9.42	3.23	9.45	3.28	9.46	3.29	9.48	3.32	10.03	3.32	10.15	3.32

Combination (Capacity)	Outdoor Air Temp. °C DB	Indoor Air Temp. °C											
		27/16		27/17.5		27/18		27/19		27/22		27/24	
		Total Q	Input Power	Total Q	Input Power	Total Q	Input Power	Total Q	Input Power	Total Q	Input Power	Total Q	Input Power
1.6 + 2.5 + 3.5 + 3.5	22	10.29	1.49	9.35	1.56	9.04	1.58	8.41	1.62	10.53	1.90	11.94	2.08
	25	10.38	2.07	9.83	2.10	9.64	2.11	9.28	2.13	10.83	2.31	11.87	2.42
	29	10.54	2.69	10.32	2.69	10.24	2.69	10.09	2.69	11.06	2.76	11.70	2.81
	32	10.36	3.04	10.41	3.02	10.43	3.02	10.46	3.01	11.10	3.03	11.53	3.04
	35	10.25	3.29	10.42	3.27	10.48	3.26	10.60	3.25	11.03	3.23	11.32	3.22
	40	9.92	3.49	10.14	3.49	10.21	3.49	10.36	3.48	10.32	3.44	10.60	3.41
	43	9.61	3.48	9.77	3.50	9.83	3.51	9.94	3.52	10.31	3.49	10.28	3.47
	46	9.24	3.37	9.27	3.42	9.28	3.44	9.30	3.47	9.85	3.47	9.96	3.47
1.6 + 2.5 + 3.5 + 4.2	22	10.29	1.49	9.35	1.56	9.04	1.58	8.41	1.62	10.53	1.90	11.94	2.08
	25	10.38	2.07	9.83	2.10	9.64	2.11	9.28	2.13	10.83	2.31	11.87	2.42
	29	10.54	2.69	10.32	2.69	10.24	2.69	10.09	2.69	11.06	2.76	11.70	2.81
	32	10.36	3.04	10.41	3.02	10.43	3.02	10.46	3.01	11.10	3.03	11.53	3.04
	35	10.25	3.29	10.42	3.27	10.48	3.26	10.60	3.25	11.03	3.23	11.32	3.22
	40	9.92	3.49	10.14	3.49	10.21	3.49	10.36	3.48	10.32	3.44	10.60	3.41
	43	9.61	3.48	9.77	3.50	9.83	3.51	9.94	3.52	10.31	3.49	10.28	3.47
	46	9.24	3.37	9.27	3.42	9.28	3.44	9.30	3.47	9.85	3.47	9.96	3.47
1.6 + 2.5 + 3.5 + 5.0	22	10.48	1.46	9.53	1.52	9.21	1.54	8.57	1.59	10.73	1.86	12.16	2.04
	25	10.57	2.03	10.01	2.06	9.83	2.07	9.45	2.09	11.04	2.26	12.09	2.37
	29	10.74	2.63	10.51	2.63	10.44	2.63	10.28	2.63	11.26	2.70	11.92	2.75
	32	10.56	2.97	10.61	2.96	10.62	2.95	10.66	2.94	11.31	2.96	11.75	2.98
	35	10.44	3.22	10.62	3.20	10.68	3.19	10.80	3.18	11.24	3.16	11.53	3.15
	40	10.10	3.42	10.33	3.41	10.41	3.41	10.56	3.41	10.52	3.37	10.80	3.34
	43	9.79	3.40	9.96	3.42	10.02	3.43	10.13	3.44	10.51	3.41	10.48	3.39
	46	9.42	3.30	9.45	3.35	9.46	3.37	9.48	3.40	10.03	3.40	10.15	3.39
1.6 + 2.5 + 3.5 + 6.0	22	10.48	1.46	9.53	1.52	9.21	1.54	8.57	1.59	10.73	1.86	12.16	2.04
	25	10.57	2.03	10.01	2.06	9.83	2.07	9.45	2.09	11.04	2.26	12.09	2.37
	29	10.74	2.63	10.51	2.63	10.44	2.63	10.28	2.63	11.26	2.70	11.92	2.75
	32	10.56	2.97	10.61	2.96	10.62	2.95	10.66	2.94	11.31	2.96	11.75	2.98
	35	10.44	3.22	10.62	3.20	10.68	3.19	10.80	3.18	11.24	3.16	11.53	3.15
	40	10.10	3.42	10.33	3.41	10.41	3.41	10.56	3.41	10.52	3.37	10.80	3.34
	43	9.79	3.40	9.96	3.42	10.02	3.43	10.13	3.44	10.51	3.41	10.48	3.39
	46	9.42	3.30	9.45	3.35	9.46	3.37	9.48	3.40	10.03	3.40	10.15	3.39
1.6 + 2.5 + 3.5 + 7.1	22	10.68	1.49	9.70	1.56	9.38	1.58	8.73	1.63	10.93	1.90	12.39	2.09
	25	10.77	2.08	10.20	2.11	10.01	2.12	9.63	2.14	11.24	2.31	12.32	2.43
	29	10.94	2.69	10.71	2.69	10.63	2.69	10.47	2.69	11.47	2.77	12.14	2.82
	32	10.76	3.05	10.80	3.03	10.82	3.03	10.85	3.02	11.52	3.04	11.97	3.05
	35	10.63	3.30	10.82	3.28	10.88	3.27	11.00	3.26	11.45	3.24	11.75	3.23
	40	10.29	3.50	10.52	3.50	10.60	3.50	10.76	3.49	10.71	3.45	11.00	3.42
	43	9.97	3.49	10.14	3.51	10.20	3.52	10.31	3.53	10.70	3.50	10.67	3.48
	46	9.59	3.38	9.62	3.43	9.63	3.45	9.65	3.48	10.22	3.48	10.34	3.48

Combination (Capacity)	Outdoor Air Temp. °C DB	Indoor Air Temp. °C											
		27/16		27/17.5		27/18		27/19		27/22		27/24	
		Total Q	Input Power	Total Q	Input Power	Total Q	Input Power	Total Q	Input Power	Total Q	Input Power	Total Q	Input Power
1.6 + 2.5 + 4.2 + 4.2	22	10.48	1.56	9.53	1.63	9.21	1.65	8.57	1.70	10.73	1.98	12.16	2.18
	25	10.57	2.17	10.01	2.20	9.83	2.21	9.45	2.23	11.04	2.41	12.09	2.53
	29	10.74	2.81	10.51	2.81	10.44	2.81	10.28	2.81	11.26	2.89	11.92	2.94
	32	10.56	3.18	10.61	3.16	10.62	3.16	10.66	3.14	11.31	3.17	11.75	3.18
	35	10.44	3.44	10.62	3.42	10.68	3.41	10.80	3.40	11.24	3.38	11.53	3.37
	40	10.10	3.66	10.33	3.65	10.41	3.65	10.56	3.64	10.52	3.60	10.80	3.57
	43	9.79	3.64	9.96	3.66	10.02	3.67	10.13	3.68	10.51	3.65	10.48	3.63
	46	9.42	3.53	9.45	3.58	9.46	3.60	9.48	3.63	10.03	3.63	10.15	3.63
1.6 + 2.5 + 4.2 + 5.0	22	10.48	1.43	9.53	1.49	9.21	1.51	8.57	1.55	10.73	1.82	12.16	1.99
	25	10.57	1.98	10.01	2.01	9.83	2.02	9.45	2.04	11.04	2.21	12.09	2.32
	29	10.74	2.57	10.51	2.57	10.44	2.57	10.28	2.57	11.26	2.64	11.92	2.69
	32	10.56	2.91	10.61	2.89	10.62	2.89	10.66	2.88	11.31	2.90	11.75	2.91
	35	10.44	3.15	10.62	3.13	10.68	3.12	10.80	3.11	11.24	3.09	11.53	3.08
	40	10.10	3.34	10.33	3.34	10.41	3.34	10.56	3.33	10.52	3.29	10.80	3.27
	43	9.79	3.33	9.96	3.35	10.02	3.35	10.13	3.37	10.51	3.34	10.48	3.32
	46	9.42	3.23	9.45	3.28	9.46	3.29	9.48	3.32	10.03	3.32	10.15	3.32
1.6 + 2.5 + 4.2 + 6.0	22	10.68	1.49	9.70	1.56	9.38	1.58	8.73	1.63	10.93	1.90	12.39	2.09
	25	10.77	2.08	10.20	2.11	10.01	2.12	9.63	2.14	11.24	2.31	12.32	2.43
	29	10.94	2.69	10.71	2.69	10.63	2.69	10.47	2.69	11.47	2.77	12.14	2.82
	32	10.76	3.05	10.80	3.03	10.82	3.03	10.85	3.02	11.52	3.04	11.97	3.05
	35	10.63	3.30	10.82	3.28	10.88	3.27	11.00	3.26	11.45	3.24	11.75	3.23
	40	10.29	3.50	10.52	3.50	10.60	3.50	10.76	3.49	10.71	3.45	11.00	3.42
	43	9.97	3.49	10.14	3.51	10.20	3.52	10.31	3.53	10.70	3.50	10.67	3.48
	46	9.59	3.38	9.62	3.43	9.63	3.45	9.65	3.48	10.22	3.48	10.34	3.48
1.6 + 2.5 + 4.2 + 7.1	22	10.68	1.46	9.70	1.53	9.38	1.55	8.73	1.59	10.93	1.86	12.39	2.04
	25	10.77	2.03	10.20	2.06	10.01	2.07	9.63	2.09	11.24	2.26	12.32	2.38
	29	10.94	2.64	10.71	2.64	10.63	2.64	10.47	2.64	11.47	2.71	12.14	2.76
	32	10.76	2.98	10.80	2.97	10.82	2.96	10.85	2.95	11.52	2.97	11.97	2.99
	35	10.63	3.23	10.82	3.21	10.88	3.20	11.00	3.19	11.45	3.17	11.75	3.16
	40	10.29	3.43	10.52	3.42	10.60	3.42	10.76	3.42	10.71	3.38	11.00	3.35
	43	9.97	3.41	10.14	3.43	10.20	3.44	10.31	3.45	10.70	3.42	10.67	3.40
	46	9.59	3.31	9.62	3.36	9.63	3.38	9.65	3.41	10.22	3.41	10.34	3.40
1.6 + 2.5 + 5.0 + 5.0	22	10.48	1.37	9.53	1.43	9.21	1.45	8.57	1.49	10.73	1.74	12.16	1.91
	25	10.57	1.90	10.01	1.93	9.83	1.94	9.45	1.95	11.04	2.11	12.09	2.22
	29	10.74	2.46	10.51	2.46	10.44	2.46	10.28	2.46	11.26	2.53	11.92	2.57
	32	10.56	2.78	10.61	2.77	10.62	2.77	10.66	2.76	11.31	2.78	11.75	2.79
	35	10.44	3.02	10.62	3.00	10.68	2.99	10.80	2.98	11.24	2.96	11.53	2.95
	40	10.10	3.20	10.33	3.20	10.41	3.20	10.56	3.19	10.52	3.16	10.80	3.13
	43	9.79	3.19	9.96	3.21	10.02	3.21	10.13	3.23	10.51	3.20	10.48	3.18
	46	9.42	3.09	9.45	3.14	9.46	3.15	9.48	3.19	10.03	3.18	10.15	3.18



Combination (Capacity)	Outdoor Air Temp. °C DB	Indoor Air Temp. °C											
		27/16		27/17.5		27/18		27/19		27/22		27/24	
		Total Q	Input Power	Total Q	Input Power	Total Q	Input Power	Total Q	Input Power	Total Q	Input Power	Total Q	Input Power
1.6 + 2.5 + 5.0 + 6.0	22	10.68	1.43	9.70	1.49	9.38	1.52	8.73	1.56	10.93	1.82	12.39	2.00
	25	10.77	1.99	10.20	2.02	10.01	2.03	9.63	2.05	11.24	2.21	12.32	2.32
	29	10.94	2.58	10.71	2.58	10.63	2.58	10.47	2.58	11.47	2.65	12.14	2.70
	32	10.76	2.91	10.80	2.90	10.82	2.90	10.85	2.89	11.52	2.91	11.97	2.92
	35	10.63	3.16	10.82	3.14	10.88	3.13	11.00	3.12	11.45	3.10	11.75	3.09
	40	10.29	3.35	10.52	3.35	10.60	3.35	10.76	3.34	10.71	3.30	11.00	3.28
	43	9.97	3.34	10.14	3.36	10.20	3.37	10.31	3.38	10.70	3.35	10.67	3.33
	46	9.59	3.24	9.62	3.29	9.63	3.30	9.65	3.33	10.22	3.33	10.34	3.33
1.6 + 2.5 + 5.0 + 7.1	22	10.87	1.47	9.88	1.53	9.55	1.55	8.89	1.60	11.12	1.87	12.61	2.05
	25	10.96	2.04	10.38	2.07	10.19	2.08	9.80	2.10	11.45	2.27	12.54	2.38
	29	11.14	2.64	10.90	2.64	10.82	2.64	10.66	2.64	11.68	2.72	12.36	2.76
	32	10.95	2.99	11.00	2.97	11.02	2.97	11.05	2.96	11.73	2.98	12.18	2.99
	35	10.83	3.24	11.01	3.22	11.08	3.21	11.20	3.20	11.66	3.18	11.96	3.17
	40	10.48	3.44	10.71	3.44	10.79	3.43	10.95	3.43	10.91	3.39	11.20	3.36
	43	10.15	3.43	10.33	3.45	10.39	3.45	10.50	3.47	10.90	3.44	10.86	3.42
	46	9.77	3.32	9.80	3.37	9.81	3.39	9.83	3.42	10.41	3.42	10.53	3.42
1.6 + 2.5 + 6.0 + 6.0	22	10.87	1.46	9.88	1.53	9.55	1.55	8.89	1.59	11.12	1.86	12.61	2.04
	25	10.96	2.03	10.38	2.06	10.19	2.07	9.80	2.09	11.45	2.26	12.54	2.38
	29	11.14	2.64	10.90	2.64	10.82	2.64	10.66	2.64	11.68	2.71	12.36	2.76
	32	10.95	2.98	11.00	2.97	11.02	2.96	11.05	2.95	11.73	2.97	12.18	2.99
	35	10.83	3.23	11.01	3.21	11.08	3.20	11.20	3.19	11.66	3.17	11.96	3.16
	40	10.48	3.43	10.71	3.42	10.79	3.42	10.95	3.42	10.91	3.38	11.20	3.35
	43	10.15	3.41	10.33	3.43	10.39	3.44	10.50	3.45	10.90	3.42	10.86	3.40
	46	9.77	3.31	9.80	3.36	9.81	3.38	9.83	3.41	10.41	3.41	10.53	3.40
1.6 + 2.5 + 6.0 + 7.1	22	10.87	1.47	9.88	1.53	9.55	1.55	8.89	1.60	11.12	1.87	12.61	2.05
	25	10.96	2.04	10.38	2.07	10.19	2.08	9.80	2.10	11.45	2.27	12.54	2.38
	29	11.14	2.64	10.90	2.64	10.82	2.64	10.66	2.64	11.68	2.72	12.36	2.76
	32	10.95	2.99	11.00	2.97	11.02	2.97	11.05	2.96	11.73	2.98	12.18	2.99
	35	10.83	3.24	11.01	3.22	11.08	3.21	11.20	3.20	11.66	3.18	11.96	3.17
	40	10.48	3.44	10.71	3.44	10.79	3.43	10.95	3.43	10.91	3.39	11.20	3.36
	43	10.15	3.43	10.33	3.45	10.39	3.45	10.50	3.47	10.90	3.44	10.86	3.42
	46	9.77	3.32	9.80	3.37	9.81	3.39	9.83	3.42	10.41	3.42	10.53	3.42
1.6 + 2.5 + 7.1 + 7.1	22	10.87	1.47	9.88	1.53	9.55	1.55	8.89	1.60	11.12	1.87	12.61	2.05
	25	10.96	2.04	10.38	2.07	10.19	2.08	9.80	2.10	11.45	2.27	12.54	2.38
	29	11.14	2.64	10.90	2.64	10.82	2.64	10.66	2.64	11.68	2.72	12.36	2.76
	32	10.95	2.99	11.00	2.97	11.02	2.97	11.05	2.96	11.73	2.98	12.18	2.99
	35	10.83	3.24	11.01	3.22	11.08	3.21	11.20	3.20	11.66	3.18	11.96	3.17
	40	10.48	3.44	10.71	3.44	10.79	3.43	10.95	3.43	10.91	3.39	11.20	3.36
	43	10.15	3.43	10.33	3.45	10.39	3.45	10.50	3.47	10.90	3.44	10.86	3.42
	46	9.77	3.32	9.80	3.37	9.81	3.39	9.83	3.42	10.41	3.42	10.53	3.42

Combination (Capacity)	Outdoor Air Temp. °C DB	Indoor Air Temp. °C											
		27/16		27/17.5		27/18		27/19		27/22		27/24	
		Total Q	Input Power	Total Q	Input Power	Total Q	Input Power	Total Q	Input Power	Total Q	Input Power	Total Q	Input Power
1.6 + 3.5 + 3.5 + 3.5	22	10.48	1.53	9.53	1.59	9.21	1.62	8.57	1.66	10.73	1.94	12.16	2.13
	25	10.57	2.12	10.01	2.15	9.83	2.16	9.45	2.18	11.04	2.36	12.09	2.48
	29	10.74	2.75	10.51	2.75	10.44	2.75	10.28	2.75	11.26	2.83	11.92	2.88
	32	10.56	3.11	10.61	3.10	10.62	3.09	10.66	3.08	11.31	3.10	11.75	3.12
	35	10.44	3.37	10.62	3.35	10.68	3.34	10.80	3.33	11.24	3.31	11.53	3.30
	40	10.10	3.58	10.33	3.57	10.41	3.57	10.56	3.57	10.52	3.53	10.80	3.50
	43	9.79	3.56	9.96	3.59	10.02	3.59	10.13	3.61	10.51	3.57	10.48	3.55
	46	9.42	3.46	9.45	3.51	9.46	3.52	9.48	3.56	10.03	3.56	10.15	3.55
1.6 + 3.5 + 3.5 + 4.2	22	10.48	1.53	9.53	1.59	9.21	1.62	8.57	1.66	10.73	1.94	12.16	2.13
	25	10.57	2.12	10.01	2.15	9.83	2.16	9.45	2.18	11.04	2.36	12.09	2.48
	29	10.74	2.75	10.51	2.75	10.44	2.75	10.28	2.75	11.26	2.83	11.92	2.88
	32	10.56	3.11	10.61	3.10	10.62	3.09	10.66	3.08	11.31	3.10	11.75	3.12
	35	10.44	3.37	10.62	3.35	10.68	3.34	10.80	3.33	11.24	3.31	11.53	3.30
	40	10.10	3.58	10.33	3.57	10.41	3.57	10.56	3.57	10.52	3.53	10.80	3.50
	43	9.79	3.56	9.96	3.59	10.02	3.59	10.13	3.61	10.51	3.57	10.48	3.55
	46	9.42	3.46	9.45	3.51	9.46	3.52	9.48	3.56	10.03	3.56	10.15	3.55
1.6 + 3.5 + 3.5 + 5.0	22	10.48	1.43	9.53	1.49	9.21	1.51	8.57	1.55	10.73	1.82	12.16	1.99
	25	10.57	1.98	10.01	2.01	9.83	2.02	9.45	2.04	11.04	2.21	12.09	2.32
	29	10.74	2.57	10.51	2.57	10.44	2.57	10.28	2.57	11.26	2.64	11.92	2.69
	32	10.56	2.91	10.61	2.89	10.62	2.89	10.66	2.88	11.31	2.90	11.75	2.91
	35	10.44	3.15	10.62	3.13	10.68	3.12	10.80	3.11	11.24	3.09	11.53	3.08
	40	10.10	3.34	10.33	3.34	10.41	3.34	10.56	3.33	10.52	3.29	10.80	3.27
	43	9.79	3.33	9.96	3.35	10.02	3.35	10.13	3.37	10.51	3.34	10.48	3.32
	46	9.42	3.23	9.45	3.28	9.46	3.29	9.48	3.32	10.03	3.32	10.15	3.32
1.6 + 3.5 + 3.5 + 6.0	22	10.68	1.49	9.70	1.56	9.38	1.58	8.73	1.63	10.93	1.90	12.39	2.09
	25	10.77	2.08	10.20	2.11	10.01	2.12	9.63	2.14	11.24	2.31	12.32	2.43
	29	10.94	2.69	10.71	2.69	10.63	2.69	10.47	2.69	11.47	2.77	12.14	2.82
	32	10.76	3.05	10.80	3.03	10.82	3.03	10.85	3.02	11.52	3.04	11.97	3.05
	35	10.63	3.30	10.82	3.28	10.88	3.27	11.00	3.26	11.45	3.24	11.75	3.23
	40	10.29	3.50	10.52	3.50	10.60	3.50	10.76	3.49	10.71	3.45	11.00	3.42
	43	9.97	3.49	10.14	3.51	10.20	3.52	10.31	3.53	10.70	3.50	10.67	3.48
	46	9.59	3.38	9.62	3.43	9.63	3.45	9.65	3.48	10.22	3.48	10.34	3.48
1.6 + 3.5 + 3.5 + 7.1	22	10.68	1.46	9.70	1.53	9.38	1.55	8.73	1.59	10.93	1.86	12.39	2.04
	25	10.77	2.03	10.20	2.06	10.01	2.07	9.63	2.09	11.24	2.26	12.32	2.38
	29	10.94	2.64	10.71	2.64	10.63	2.64	10.47	2.64	11.47	2.71	12.14	2.76
	32	10.76	2.98	10.80	2.97	10.82	2.96	10.85	2.95	11.52	2.97	11.97	2.99
	35	10.63	3.23	10.82	3.21	10.88	3.20	11.00	3.19	11.45	3.17	11.75	3.16
	40	10.29	3.43	10.52	3.42	10.60	3.42	10.76	3.42	10.71	3.38	11.00	3.35
	43	9.97	3.41	10.14	3.43	10.20	3.44	10.31	3.45	10.70	3.42	10.67	3.40
	46	9.59	3.31	9.62	3.36	9.63	3.38	9.65	3.41	10.22	3.41	10.34	3.40

Combination (Capacity)	Outdoor Air Temp. °C DB	Indoor Air Temp. °C											
		27/16		27/17.5		27/18		27/19		27/22		27/24	
		Total Q	Input Power	Total Q	Input Power	Total Q	Input Power	Total Q	Input Power	Total Q	Input Power	Total Q	Input Power
1.6 + 3.5 + 4.2 + 4.2	22	10.48	1.53	9.53	1.59	9.21	1.62	8.57	1.66	10.73	1.94	12.16	2.13
	25	10.57	2.12	10.01	2.15	9.83	2.16	9.45	2.18	11.04	2.36	12.09	2.48
	29	10.74	2.75	10.51	2.75	10.44	2.75	10.28	2.75	11.26	2.83	11.92	2.88
	32	10.56	3.11	10.61	3.10	10.62	3.09	10.66	3.08	11.31	3.10	11.75	3.12
	35	10.44	3.37	10.62	3.35	10.68	3.34	10.80	3.33	11.24	3.31	11.53	3.30
	40	10.10	3.58	10.33	3.57	10.41	3.57	10.56	3.57	10.52	3.53	10.80	3.50
	43	9.79	3.56	9.96	3.59	10.02	3.59	10.13	3.61	10.51	3.57	10.48	3.55
	46	9.42	3.46	9.45	3.51	9.46	3.52	9.48	3.56	10.03	3.56	10.15	3.55
1.6 + 3.5 + 4.2 + 5.0	22	10.68	1.49	9.70	1.56	9.38	1.58	8.73	1.63	10.93	1.90	12.39	2.09
	25	10.77	2.08	10.20	2.11	10.01	2.12	9.63	2.14	11.24	2.31	12.32	2.43
	29	10.94	2.69	10.71	2.69	10.63	2.69	10.47	2.69	11.47	2.77	12.14	2.82
	32	10.76	3.05	10.80	3.03	10.82	3.03	10.85	3.02	11.52	3.04	11.97	3.05
	35	10.63	3.30	10.82	3.28	10.88	3.27	11.00	3.26	11.45	3.24	11.75	3.23
	40	10.29	3.50	10.52	3.50	10.60	3.50	10.76	3.49	10.71	3.45	11.00	3.42
	43	9.97	3.49	10.14	3.51	10.20	3.52	10.31	3.53	10.70	3.50	10.67	3.48
	46	9.59	3.38	9.62	3.43	9.63	3.45	9.65	3.48	10.22	3.48	10.34	3.48
1.6 + 3.5 + 4.2 + 6.0	22	10.68	1.49	9.70	1.56	9.38	1.58	8.73	1.63	10.93	1.90	12.39	2.09
	25	10.77	2.08	10.20	2.11	10.01	2.12	9.63	2.14	11.24	2.31	12.32	2.43
	29	10.94	2.69	10.71	2.69	10.63	2.69	10.47	2.69	11.47	2.77	12.14	2.82
	32	10.76	3.05	10.80	3.03	10.82	3.03	10.85	3.02	11.52	3.04	11.97	3.05
	35	10.63	3.30	10.82	3.28	10.88	3.27	11.00	3.26	11.45	3.24	11.75	3.23
	40	10.29	3.50	10.52	3.50	10.60	3.50	10.76	3.49	10.71	3.45	11.00	3.42
	43	9.97	3.49	10.14	3.51	10.20	3.52	10.31	3.53	10.70	3.50	10.67	3.48
	46	9.59	3.38	9.62	3.43	9.63	3.45	9.65	3.48	10.22	3.48	10.34	3.48
1.6 + 3.5 + 4.2 + 7.1	22	10.87	1.53	9.88	1.59	9.55	1.62	8.89	1.66	11.12	1.94	12.61	2.13
	25	10.96	2.12	10.38	2.15	10.19	2.16	9.80	2.18	11.45	2.36	12.54	2.48
	29	11.14	2.75	10.90	2.75	10.82	2.75	10.66	2.75	11.68	2.83	12.36	2.88
	32	10.95	3.11	11.00	3.10	11.02	3.09	11.05	3.08	11.73	3.10	12.18	3.12
	35	10.83	3.37	11.01	3.35	11.08	3.34	11.20	3.33	11.66	3.31	11.96	3.30
	40	10.48	3.58	10.71	3.57	10.79	3.57	10.95	3.57	10.91	3.53	11.20	3.50
	43	10.15	3.56	10.33	3.59	10.39	3.59	10.50	3.61	10.90	3.57	10.86	3.55
	46	9.77	3.46	9.80	3.51	9.81	3.52	9.83	3.56	10.41	3.56	10.53	3.55
1.6 + 3.5 + 5.0 + 5.0	22	10.68	1.40	9.70	1.46	9.38	1.48	8.73	1.52	10.93	1.78	12.39	1.95
	25	10.77	1.94	10.20	1.97	10.01	1.98	9.63	2.00	11.24	2.16	12.32	2.27
	29	10.94	2.52	10.71	2.52	10.63	2.52	10.47	2.52	11.47	2.59	12.14	2.63
	32	10.76	2.85	10.80	2.84	10.82	2.83	10.85	2.82	11.52	2.84	11.97	2.85
	35	10.63	3.09	10.82	3.07	10.88	3.06	11.00	3.05	11.45	3.03	11.75	3.02
	40	10.29	3.28	10.52	3.27	10.60	3.27	10.76	3.27	10.71	3.23	11.00	3.20
	43	9.97	3.26	10.14	3.28	10.20	3.29	10.31	3.30	10.70	3.27	10.67	3.26
	46	9.59	3.16	9.62	3.21	9.63	3.23	9.65	3.26	10.22	3.26	10.34	3.26

Combination (Capacity)	Outdoor Air Temp. °C DB	Indoor Air Temp. °C											
		27/16		27/17.5		27/18		27/19		27/22		27/24	
		Total Q	Input Power	Total Q	Input Power	Total Q	Input Power	Total Q	Input Power	Total Q	Input Power	Total Q	Input Power
1.6 + 3.5 + 5.0 + 6.0	22	10.87	1.47	9.88	1.53	9.55	1.55	8.89	1.60	11.12	1.87	12.61	2.05
	25	10.96	2.04	10.38	2.07	10.19	2.08	9.80	2.10	11.45	2.27	12.54	2.38
	29	11.14	2.64	10.90	2.64	10.82	2.64	10.66	2.64	11.68	2.72	12.36	2.76
	32	10.95	2.99	11.00	2.97	11.02	2.97	11.05	2.96	11.73	2.98	12.18	2.99
	35	10.83	3.24	11.01	3.22	11.08	3.21	11.20	3.20	11.66	3.18	11.96	3.17
	40	10.48	3.44	10.71	3.44	10.79	3.43	10.95	3.43	10.91	3.39	11.20	3.36
	43	10.15	3.43	10.33	3.45	10.39	3.45	10.50	3.47	10.90	3.44	10.86	3.42
	46	9.77	3.32	9.80	3.37	9.81	3.39	9.83	3.42	10.41	3.42	10.53	3.42
1.6 + 3.5 + 5.0 + 7.1	22	10.87	1.47	9.88	1.53	9.55	1.55	8.89	1.60	11.12	1.87	12.61	2.05
	25	10.96	2.04	10.38	2.07	10.19	2.08	9.80	2.10	11.45	2.27	12.54	2.38
	29	11.14	2.64	10.90	2.64	10.82	2.64	10.66	2.64	11.68	2.72	12.36	2.76
	32	10.95	2.99	11.00	2.97	11.02	2.97	11.05	2.96	11.73	2.98	12.18	2.99
	35	10.83	3.24	11.01	3.22	11.08	3.21	11.20	3.20	11.66	3.18	11.96	3.17
	40	10.48	3.44	10.71	3.44	10.79	3.43	10.95	3.43	10.91	3.39	11.20	3.36
	43	10.15	3.43	10.33	3.45	10.39	3.45	10.50	3.47	10.90	3.44	10.86	3.42
	46	9.77	3.32	9.80	3.37	9.81	3.39	9.83	3.42	10.41	3.42	10.53	3.42
1.6 + 3.5 + 6.0 + 6.0	22	10.87	1.47	9.88	1.53	9.55	1.55	8.89	1.60	11.12	1.87	12.61	2.05
	25	10.96	2.04	10.38	2.07	10.19	2.08	9.80	2.10	11.45	2.27	12.54	2.38
	29	11.14	2.64	10.90	2.64	10.82	2.64	10.66	2.64	11.68	2.72	12.36	2.76
	32	10.95	2.99	11.00	2.97	11.02	2.97	11.05	2.96	11.73	2.98	12.18	2.99
	35	10.83	3.24	11.01	3.22	11.08	3.21	11.20	3.20	11.66	3.18	11.96	3.17
	40	10.48	3.44	10.71	3.44	10.79	3.43	10.95	3.43	10.91	3.39	11.20	3.36
	43	10.15	3.43	10.33	3.45	10.39	3.45	10.50	3.47	10.90	3.44	10.86	3.42
	46	9.77	3.32	9.80	3.37	9.81	3.39	9.83	3.42	10.41	3.42	10.53	3.42
1.6 + 3.5 + 6.0 + 7.1	22	10.87	1.47	9.88	1.53	9.55	1.55	8.89	1.60	11.12	1.87	12.61	2.05
	25	10.96	2.04	10.38	2.07	10.19	2.08	9.80	2.10	11.45	2.27	12.54	2.38
	29	11.14	2.64	10.90	2.64	10.82	2.64	10.66	2.64	11.68	2.72	12.36	2.76
	32	10.95	2.99	11.00	2.97	11.02	2.97	11.05	2.96	11.73	2.98	12.18	2.99
	35	10.83	3.24	11.01	3.22	11.08	3.21	11.20	3.20	11.66	3.18	11.96	3.17
	40	10.48	3.44	10.71	3.44	10.79	3.43	10.95	3.43	10.91	3.39	11.20	3.36
	43	10.15	3.43	10.33	3.45	10.39	3.45	10.50	3.47	10.90	3.44	10.86	3.42
	46	9.77	3.32	9.80	3.37	9.81	3.39	9.83	3.42	10.41	3.42	10.53	3.42
1.6 + 4.2 + 4.2 + 4.2	22	10.68	1.60	9.70	1.67	9.38	1.69	8.73	1.74	10.93	2.03	12.39	2.23
	25	10.77	2.22	10.20	2.25	10.01	2.26	9.63	2.28	11.24	2.47	12.32	2.59
	29	10.94	2.88	10.71	2.88	10.63	2.88	10.47	2.88	11.47	2.95	12.14	3.01
	32	10.76	3.25	10.80	3.23	10.82	3.23	10.85	3.22	11.52	3.24	11.97	3.26
	35	10.63	3.52	10.82	3.50	10.88	3.49	11.00	3.48	11.45	3.46	11.75	3.45
	40	10.29	3.74	10.52	3.74	10.60	3.73	10.76	3.73	10.71	3.68	11.00	3.65
	43	9.97	3.73	10.14	3.75	10.20	3.75	10.31	3.77	10.70	3.74	10.67	3.71
	46	9.59	3.61	9.62	3.67	9.63	3.68	9.65	3.72	10.22	3.72	10.34	3.71

Combination (Capacity)	Outdoor Air Temp. °C DB	Indoor Air Temp. °C											
		27/16		27/17.5		27/18		27/19		27/22		27/24	
		Total Q	Input Power	Total Q	Input Power	Total Q	Input Power	Total Q	Input Power	Total Q	Input Power	Total Q	Input Power
1.6 + 4.2 + 4.2 + 5.0	22	10.68	1.46	9.70	1.53	9.38	1.55	8.73	1.59	10.93	1.86	12.39	2.04
	25	10.77	2.03	10.20	2.06	10.01	2.07	9.63	2.09	11.24	2.26	12.32	2.38
	29	10.94	2.64	10.71	2.64	10.63	2.64	10.47	2.64	11.47	2.71	12.14	2.76
	32	10.76	2.98	10.80	2.97	10.82	2.96	10.85	2.95	11.52	2.97	11.97	2.99
	35	10.63	3.23	10.82	3.21	10.88	3.20	11.00	3.19	11.45	3.17	11.75	3.16
	40	10.29	3.43	10.52	3.42	10.60	3.42	10.76	3.42	10.71	3.38	11.00	3.35
	43	9.97	3.41	10.14	3.43	10.20	3.44	10.31	3.45	10.70	3.42	10.67	3.40
	46	9.59	3.31	9.62	3.36	9.63	3.38	9.65	3.41	10.22	3.41	10.34	3.40
1.6 + 4.2 + 4.2 + 6.0	22	10.87	1.53	9.88	1.59	9.55	1.62	8.89	1.66	11.12	1.94	12.61	2.13
	25	10.96	2.12	10.38	2.15	10.19	2.16	9.80	2.18	11.45	2.36	12.54	2.48
	29	11.14	2.75	10.90	2.75	10.82	2.75	10.66	2.75	11.68	2.83	12.36	2.88
	32	10.95	3.11	11.00	3.10	11.02	3.09	11.05	3.08	11.73	3.10	12.18	3.12
	35	10.83	3.37	11.01	3.35	11.08	3.34	11.20	3.33	11.66	3.31	11.96	3.30
	40	10.48	3.58	10.71	3.57	10.79	3.57	10.95	3.57	10.91	3.53	11.20	3.50
	43	10.15	3.56	10.33	3.59	10.39	3.59	10.50	3.61	10.90	3.57	10.86	3.55
	46	9.77	3.46	9.80	3.51	9.81	3.52	9.83	3.56	10.41	3.56	10.53	3.55
1.6 + 4.2 + 4.2 + 7.1	22	10.87	1.53	9.88	1.60	9.55	1.62	8.89	1.67	11.12	1.95	12.61	2.14
	25	10.96	2.13	10.38	2.16	10.19	2.17	9.80	2.19	11.45	2.37	12.54	2.49
	29	11.14	2.76	10.90	2.76	10.82	2.76	10.66	2.76	11.68	2.84	12.36	2.89
	32	10.95	3.12	11.00	3.10	11.02	3.10	11.05	3.09	11.73	3.11	12.18	3.13
	35	10.83	3.38	11.01	3.36	11.08	3.35	11.20	3.34	11.66	3.32	11.96	3.31
	40	10.48	3.59	10.71	3.59	10.79	3.58	10.95	3.58	10.91	3.54	11.20	3.51
	43	10.15	3.58	10.33	3.60	10.39	3.60	10.50	3.62	10.90	3.59	10.86	3.56
	46	9.77	3.47	9.80	3.52	9.81	3.54	9.83	3.57	10.41	3.57	10.53	3.56
1.6 + 4.2 + 5.0 + 5.0	22	10.87	1.47	9.88	1.53	9.55	1.55	8.89	1.60	11.12	1.87	12.61	2.05
	25	10.96	2.04	10.38	2.07	10.19	2.08	9.80	2.10	11.45	2.27	12.54	2.38
	29	11.14	2.64	10.90	2.64	10.82	2.64	10.66	2.64	11.68	2.72	12.36	2.76
	32	10.95	2.99	11.00	2.97	11.02	2.97	11.05	2.96	11.73	2.98	12.18	2.99
	35	10.83	3.24	11.01	3.22	11.08	3.21	11.20	3.20	11.66	3.18	11.96	3.17
	40	10.48	3.44	10.71	3.44	10.79	3.43	10.95	3.43	10.91	3.39	11.20	3.36
	43	10.15	3.43	10.33	3.45	10.39	3.45	10.50	3.47	10.90	3.44	10.86	3.42
	46	9.77	3.32	9.80	3.37	9.81	3.39	9.83	3.42	10.41	3.42	10.53	3.42
1.6 + 4.2 + 5.0 + 6.0	22	10.87	1.47	9.88	1.53	9.55	1.55	8.89	1.60	11.12	1.87	12.61	2.05
	25	10.96	2.04	10.38	2.07	10.19	2.08	9.80	2.10	11.45	2.27	12.54	2.38
	29	11.14	2.64	10.90	2.64	10.82	2.64	10.66	2.64	11.68	2.72	12.36	2.76
	32	10.95	2.99	11.00	2.97	11.02	2.97	11.05	2.96	11.73	2.98	12.18	2.99
	35	10.83	3.24	11.01	3.22	11.08	3.21	11.20	3.20	11.66	3.18	11.96	3.17
	40	10.48	3.44	10.71	3.44	10.79	3.43	10.95	3.43	10.91	3.39	11.20	3.36
	43	10.15	3.43	10.33	3.45	10.39	3.45	10.50	3.47	10.90	3.44	10.86	3.42
	46	9.77	3.32	9.80	3.37	9.81	3.39	9.83	3.42	10.41	3.42	10.53	3.42

Combination (Capacity)	Outdoor Air Temp. °C DB	Indoor Air Temp. °C											
		27/16		27/17.5		27/18		27/19		27/22		27/24	
		Total Q	Input Power	Total Q	Input Power	Total Q	Input Power	Total Q	Input Power	Total Q	Input Power	Total Q	Input Power
1.6 + 4.2 + 5.0 + 7.1	22	10.87	1.47	9.88	1.53	9.55	1.55	8.89	1.60	11.12	1.87	12.61	2.05
	25	10.96	2.04	10.38	2.07	10.19	2.08	9.80	2.10	11.45	2.27	12.54	2.38
	29	11.14	2.64	10.90	2.64	10.82	2.64	10.66	2.64	11.68	2.72	12.36	2.76
	32	10.95	2.99	11.00	2.97	11.02	2.97	11.05	2.96	11.73	2.98	12.18	2.99
	35	10.83	3.24	11.01	3.22	11.08	3.21	11.20	3.20	11.66	3.18	11.96	3.17
	40	10.48	3.44	10.71	3.44	10.79	3.43	10.95	3.43	10.91	3.39	11.20	3.36
	43	10.15	3.43	10.33	3.45	10.39	3.45	10.50	3.47	10.90	3.44	10.86	3.42
	46	9.77	3.32	9.80	3.37	9.81	3.39	9.83	3.42	10.41	3.42	10.53	3.42
1.6 + 4.2 + 6.0 + 6.0	22	10.87	1.47	9.88	1.53	9.55	1.55	8.89	1.60	11.12	1.87	12.61	2.05
	25	10.96	2.04	10.38	2.07	10.19	2.08	9.80	2.10	11.45	2.27	12.54	2.38
	29	11.14	2.64	10.90	2.64	10.82	2.64	10.66	2.64	11.68	2.72	12.36	2.76
	32	10.95	2.99	11.00	2.97	11.02	2.97	11.05	2.96	11.73	2.98	12.18	2.99
	35	10.83	3.24	11.01	3.22	11.08	3.21	11.20	3.20	11.66	3.18	11.96	3.17
	40	10.48	3.44	10.71	3.44	10.79	3.43	10.95	3.43	10.91	3.39	11.20	3.36
	43	10.15	3.43	10.33	3.45	10.39	3.45	10.50	3.47	10.90	3.44	10.86	3.42
	46	9.77	3.32	9.80	3.37	9.81	3.39	9.83	3.42	10.41	3.42	10.53	3.42
1.6 + 5.0 + 5.0 + 5.0	22	10.87	1.44	9.88	1.50	9.55	1.52	8.89	1.57	11.12	1.83	12.61	2.01
	25	10.96	2.00	10.38	2.03	10.19	2.04	9.80	2.06	11.45	2.23	12.54	2.34
	29	11.14	2.59	10.90	2.59	10.82	2.59	10.66	2.59	11.68	2.67	12.36	2.71
	32	10.95	2.93	11.00	2.92	11.02	2.91	11.05	2.90	11.73	2.92	12.18	2.94
	35	10.83	3.18	11.01	3.16	11.08	3.15	11.20	3.14	11.66	3.12	11.96	3.11
	40	10.48	3.38	10.71	3.37	10.79	3.37	10.95	3.37	10.91	3.32	11.20	3.30
	43	10.15	3.36	10.33	3.38	10.39	3.39	10.50	3.40	10.90	3.37	10.86	3.35
	46	9.77	3.26	9.80	3.31	9.81	3.32	9.83	3.36	10.41	3.35	10.53	3.35
1.6 + 5.0 + 5.0 + 6.0	22	10.87	1.44	9.88	1.50	9.55	1.52	8.89	1.57	11.12	1.83	12.61	2.01
	25	10.96	2.00	10.38	2.03	10.19	2.04	9.80	2.06	11.45	2.23	12.54	2.34
	29	11.14	2.59	10.90	2.59	10.82	2.59	10.66	2.59	11.68	2.67	12.36	2.71
	32	10.95	2.93	11.00	2.92	11.02	2.91	11.05	2.90	11.73	2.92	12.18	2.94
	35	10.83	3.18	11.01	3.16	11.08	3.15	11.20	3.14	11.66	3.12	11.96	3.11
	40	10.48	3.38	10.71	3.37	10.79	3.37	10.95	3.37	10.91	3.32	11.20	3.30
	43	10.15	3.36	10.33	3.38	10.39	3.39	10.50	3.40	10.90	3.37	10.86	3.35
	46	9.77	3.26	9.80	3.31	9.81	3.32	9.83	3.36	10.41	3.35	10.53	3.35
2.0 + 2.0 + 2.0 + 2.0	22	10.29	1.56	9.35	1.63	9.04	1.65	8.41	1.70	10.53	1.98	11.94	2.18
	25	10.38	2.17	9.83	2.20	9.64	2.21	9.28	2.23	10.83	2.41	11.87	2.53
	29	10.54	2.81	10.32	2.81	10.24	2.81	10.09	2.81	11.06	2.89	11.70	2.94
	32	10.36	3.18	10.41	3.16	10.43	3.16	10.46	3.14	11.10	3.17	11.53	3.18
	35	10.25	3.44	10.42	3.42	10.48	3.41	10.60	3.40	11.03	3.38	11.32	3.37
	40	9.92	3.66	10.14	3.65	10.21	3.65	10.36	3.64	10.32	3.60	10.60	3.57
	43	9.61	3.64	9.77	3.66	9.83	3.67	9.94	3.68	10.31	3.65	10.28	3.63
	46	9.24	3.53	9.27	3.58	9.28	3.60	9.30	3.63	9.85	3.63	9.96	3.63

Combination (Capacity)	Outdoor Air Temp. °C DB	Indoor Air Temp. °C											
		27/16		27/17.5		27/18		27/19		27/22		27/24	
		Total Q	Input Power	Total Q	Input Power	Total Q	Input Power	Total Q	Input Power	Total Q	Input Power	Total Q	Input Power
2.0 + 2.0 + 2.0 + 2.5	22	10.29	1.56	9.35	1.63	9.04	1.65	8.41	1.70	10.53	1.98	11.94	2.18
	25	10.38	2.17	9.83	2.20	9.64	2.21	9.28	2.23	10.83	2.41	11.87	2.53
	29	10.54	2.81	10.32	2.81	10.24	2.81	10.09	2.81	11.06	2.89	11.70	2.94
	32	10.36	3.18	10.41	3.16	10.43	3.16	10.46	3.14	11.10	3.17	11.53	3.18
	35	10.25	3.44	10.42	3.42	10.48	3.41	10.60	3.40	11.03	3.38	11.32	3.37
	40	9.92	3.66	10.14	3.65	10.21	3.65	10.36	3.64	10.32	3.60	10.60	3.57
	43	9.61	3.64	9.77	3.66	9.83	3.67	9.94	3.68	10.31	3.65	10.28	3.63
	46	9.24	3.53	9.27	3.58	9.28	3.60	9.30	3.63	9.85	3.63	9.96	3.63
2.0 + 2.0 + 2.0 + 3.5	22	10.29	1.53	9.35	1.59	9.04	1.62	8.41	1.66	10.53	1.94	11.94	2.13
	25	10.38	2.12	9.83	2.15	9.64	2.16	9.28	2.18	10.83	2.36	11.87	2.48
	29	10.54	2.75	10.32	2.75	10.24	2.75	10.09	2.75	11.06	2.83	11.70	2.88
	32	10.36	3.11	10.41	3.10	10.43	3.09	10.46	3.08	11.10	3.10	11.53	3.12
	35	10.25	3.37	10.42	3.35	10.48	3.34	10.60	3.33	11.03	3.31	11.32	3.30
	40	9.92	3.58	10.14	3.57	10.21	3.57	10.36	3.57	10.32	3.53	10.60	3.50
	43	9.61	3.56	9.77	3.59	9.83	3.59	9.94	3.61	10.31	3.57	10.28	3.55
	46	9.24	3.46	9.27	3.51	9.28	3.52	9.30	3.56	9.85	3.56	9.96	3.55
2.0 + 2.0 + 2.0 + 4.2	22	10.29	1.53	9.35	1.59	9.04	1.62	8.41	1.66	10.53	1.94	11.94	2.13
	25	10.38	2.12	9.83	2.15	9.64	2.16	9.28	2.18	10.83	2.36	11.87	2.48
	29	10.54	2.75	10.32	2.75	10.24	2.75	10.09	2.75	11.06	2.83	11.70	2.88
	32	10.36	3.11	10.41	3.10	10.43	3.09	10.46	3.08	11.10	3.10	11.53	3.12
	35	10.25	3.37	10.42	3.35	10.48	3.34	10.60	3.33	11.03	3.31	11.32	3.30
	40	9.92	3.58	10.14	3.57	10.21	3.57	10.36	3.57	10.32	3.53	10.60	3.50
	43	9.61	3.56	9.77	3.59	9.83	3.59	9.94	3.61	10.31	3.57	10.28	3.55
	46	9.24	3.46	9.27	3.51	9.28	3.52	9.30	3.56	9.85	3.56	9.96	3.55
2.0 + 2.0 + 2.0 + 5.0	22	10.29	1.39	9.35	1.46	9.04	1.48	8.41	1.52	10.53	1.77	11.94	1.95
	25	10.38	1.94	9.83	1.96	9.64	1.97	9.28	1.99	10.83	2.16	11.87	2.26
	29	10.54	2.51	10.32	2.51	10.24	2.51	10.09	2.51	11.06	2.58	11.70	2.63
	32	10.36	2.84	10.41	2.83	10.43	2.82	10.46	2.81	11.10	2.83	11.53	2.84
	35	10.25	3.08	10.42	3.06	10.48	3.05	10.60	3.04	11.03	3.02	11.32	3.01
	40	9.92	3.27	10.14	3.26	10.21	3.26	10.36	3.26	10.32	3.22	10.60	3.19
	43	9.61	3.25	9.77	3.27	9.83	3.28	9.94	3.29	10.31	3.26	10.28	3.24
	46	9.24	3.15	9.27	3.20	9.28	3.22	9.30	3.25	9.85	3.25	9.96	3.24
2.0 + 2.0 + 2.0 + 6.0	22	10.29	1.39	9.35	1.46	9.04	1.48	8.41	1.52	10.53	1.77	11.94	1.95
	25	10.38	1.94	9.83	1.96	9.64	1.97	9.28	1.99	10.83	2.16	11.87	2.26
	29	10.54	2.51	10.32	2.51	10.24	2.51	10.09	2.51	11.06	2.58	11.70	2.63
	32	10.36	2.84	10.41	2.83	10.43	2.82	10.46	2.81	11.10	2.83	11.53	2.84
	35	10.25	3.08	10.42	3.06	10.48	3.05	10.60	3.04	11.03	3.02	11.32	3.01
	40	9.92	3.27	10.14	3.26	10.21	3.26	10.36	3.26	10.32	3.22	10.60	3.19
	43	9.61	3.25	9.77	3.27	9.83	3.28	9.94	3.29	10.31	3.26	10.28	3.24
	46	9.24	3.15	9.27	3.20	9.28	3.22	9.30	3.25	9.85	3.25	9.96	3.24

Combination (Capacity)	Outdoor Air Temp. °C DB	Indoor Air Temp. °C											
		27/16		27/17.5		27/18		27/19		27/22		27/24	
		Total Q	Input Power	Total Q	Input Power	Total Q	Input Power	Total Q	Input Power	Total Q	Input Power	Total Q	Input Power
2.0 + 2.0 + 2.0 + 7.1	22	10.48	1.43	9.53	1.49	9.21	1.51	8.57	1.55	10.73	1.82	12.16	1.99
	25	10.57	1.98	10.01	2.01	9.83	2.02	9.45	2.04	11.04	2.21	12.09	2.32
	29	10.74	2.57	10.51	2.57	10.44	2.57	10.28	2.57	11.26	2.64	11.92	2.69
	32	10.56	2.91	10.61	2.89	10.62	2.89	10.66	2.88	11.31	2.90	11.75	2.91
	35	10.44	3.15	10.62	3.13	10.68	3.12	10.80	3.11	11.24	3.09	11.53	3.08
	40	10.10	3.34	10.33	3.34	10.41	3.34	10.56	3.33	10.52	3.29	10.80	3.27
	43	9.79	3.33	9.96	3.35	10.02	3.35	10.13	3.37	10.51	3.34	10.48	3.32
	46	9.42	3.23	9.45	3.28	9.46	3.29	9.48	3.32	10.03	3.32	10.15	3.32
2.0 + 2.0 + 2.5 + 2.5	22	10.29	1.56	9.35	1.63	9.04	1.65	8.41	1.70	10.53	1.98	11.94	2.18
	25	10.38	2.17	9.83	2.20	9.64	2.21	9.28	2.23	10.83	2.41	11.87	2.53
	29	10.54	2.81	10.32	2.81	10.24	2.81	10.09	2.81	11.06	2.89	11.70	2.94
	32	10.36	3.18	10.41	3.16	10.43	3.16	10.46	3.14	11.10	3.17	11.53	3.18
	35	10.25	3.44	10.42	3.42	10.48	3.41	10.60	3.40	11.03	3.38	11.32	3.37
	40	9.92	3.66	10.14	3.65	10.21	3.65	10.36	3.64	10.32	3.60	10.60	3.57
	43	9.61	3.64	9.77	3.66	9.83	3.67	9.94	3.68	10.31	3.65	10.28	3.63
	46	9.24	3.53	9.27	3.58	9.28	3.60	9.30	3.63	9.85	3.63	9.96	3.63
2.0 + 2.0 + 2.5 + 3.5	22	10.29	1.53	9.35	1.59	9.04	1.62	8.41	1.66	10.53	1.94	11.94	2.13
	25	10.38	2.12	9.83	2.15	9.64	2.16	9.28	2.18	10.83	2.36	11.87	2.48
	29	10.54	2.75	10.32	2.75	10.24	2.75	10.09	2.75	11.06	2.83	11.70	2.88
	32	10.36	3.11	10.41	3.10	10.43	3.09	10.46	3.08	11.10	3.10	11.53	3.12
	35	10.25	3.37	10.42	3.35	10.48	3.34	10.60	3.33	11.03	3.31	11.32	3.30
	40	9.92	3.58	10.14	3.57	10.21	3.57	10.36	3.57	10.32	3.53	10.60	3.50
	43	9.61	3.56	9.77	3.59	9.83	3.59	9.94	3.61	10.31	3.57	10.28	3.55
	46	9.24	3.46	9.27	3.51	9.28	3.52	9.30	3.56	9.85	3.56	9.96	3.55
2.0 + 2.0 + 2.5 + 4.2	22	10.29	1.53	9.35	1.59	9.04	1.62	8.41	1.66	10.53	1.94	11.94	2.13
	25	10.38	2.12	9.83	2.15	9.64	2.16	9.28	2.18	10.83	2.36	11.87	2.48
	29	10.54	2.75	10.32	2.75	10.24	2.75	10.09	2.75	11.06	2.83	11.70	2.88
	32	10.36	3.11	10.41	3.10	10.43	3.09	10.46	3.08	11.10	3.10	11.53	3.12
	35	10.25	3.37	10.42	3.35	10.48	3.34	10.60	3.33	11.03	3.31	11.32	3.30
	40	9.92	3.58	10.14	3.57	10.21	3.57	10.36	3.57	10.32	3.53	10.60	3.50
	43	9.61	3.56	9.77	3.59	9.83	3.59	9.94	3.61	10.31	3.57	10.28	3.55
	46	9.24	3.46	9.27	3.51	9.28	3.52	9.30	3.56	9.85	3.56	9.96	3.55
2.0 + 2.0 + 2.5 + 5.0	22	10.29	1.39	9.35	1.46	9.04	1.48	8.41	1.52	10.53	1.77	11.94	1.95
	25	10.38	1.94	9.83	1.96	9.64	1.97	9.28	1.99	10.83	2.16	11.87	2.26
	29	10.54	2.51	10.32	2.51	10.24	2.51	10.09	2.51	11.06	2.58	11.70	2.63
	32	10.36	2.84	10.41	2.83	10.43	2.82	10.46	2.81	11.10	2.83	11.53	2.84
	35	10.25	3.08	10.42	3.06	10.48	3.05	10.60	3.04	11.03	3.02	11.32	3.01
	40	9.92	3.27	10.14	3.26	10.21	3.26	10.36	3.26	10.32	3.22	10.60	3.19
	43	9.61	3.25	9.77	3.27	9.83	3.28	9.94	3.29	10.31	3.26	10.28	3.24
	46	9.24	3.15	9.27	3.20	9.28	3.22	9.30	3.25	9.85	3.25	9.96	3.24



Combination (Capacity)	Outdoor Air Temp. °C DB	Indoor Air Temp. °C											
		27/16		27/17.5		27/18		27/19		27/22		27/24	
		Total Q	Input Power	Total Q	Input Power	Total Q	Input Power	Total Q	Input Power	Total Q	Input Power	Total Q	Input Power
2.0 + 2.0 + 2.5 + 6.0	22	10.48	1.46	9.53	1.52	9.21	1.54	8.57	1.59	10.73	1.86	12.16	2.04
	25	10.57	2.03	10.01	2.06	9.83	2.07	9.45	2.09	11.04	2.26	12.09	2.37
	29	10.74	2.63	10.51	2.63	10.44	2.63	10.28	2.63	11.26	2.70	11.92	2.75
	32	10.56	2.97	10.61	2.96	10.62	2.95	10.66	2.94	11.31	2.96	11.75	2.98
	35	10.44	3.22	10.62	3.20	10.68	3.19	10.80	3.18	11.24	3.16	11.53	3.15
	40	10.10	3.42	10.33	3.41	10.41	3.41	10.56	3.41	10.52	3.37	10.80	3.34
	43	9.79	3.40	9.96	3.42	10.02	3.43	10.13	3.44	10.51	3.41	10.48	3.39
	46	9.42	3.30	9.45	3.35	9.46	3.37	9.48	3.40	10.03	3.40	10.15	3.39
2.0 + 2.0 + 2.5 + 7.1	22	10.48	1.43	9.53	1.49	9.21	1.51	8.57	1.55	10.73	1.82	12.16	1.99
	25	10.57	1.98	10.01	2.01	9.83	2.02	9.45	2.04	11.04	2.21	12.09	2.32
	29	10.74	2.57	10.51	2.57	10.44	2.57	10.28	2.57	11.26	2.64	11.92	2.69
	32	10.56	2.91	10.61	2.89	10.62	2.89	10.66	2.88	11.31	2.90	11.75	2.91
	35	10.44	3.15	10.62	3.13	10.68	3.12	10.80	3.11	11.24	3.09	11.53	3.08
	40	10.10	3.34	10.33	3.34	10.41	3.34	10.56	3.33	10.52	3.29	10.80	3.27
	43	9.79	3.33	9.96	3.35	10.02	3.35	10.13	3.37	10.51	3.34	10.48	3.32
	46	9.42	3.23	9.45	3.28	9.46	3.29	9.48	3.32	10.03	3.32	10.15	3.32
2.0 + 2.0 + + 3.5 + 3.5	22	10.29	1.49	9.35	1.56	9.04	1.58	8.41	1.62	10.53	1.90	11.94	2.08
	25	10.38	2.07	9.83	2.10	9.64	2.11	9.28	2.13	10.83	2.31	11.87	2.42
	29	10.54	2.69	10.32	2.69	10.24	2.69	10.09	2.69	11.06	2.76	11.70	2.81
	32	10.36	3.04	10.41	3.02	10.43	3.02	10.46	3.01	11.10	3.03	11.53	3.04
	35	10.25	3.29	10.42	3.27	10.48	3.26	10.60	3.25	11.03	3.23	11.32	3.22
	40	9.92	3.49	10.14	3.49	10.21	3.49	10.36	3.48	10.32	3.44	10.60	3.41
	43	9.61	3.48	9.77	3.50	9.83	3.51	9.94	3.52	10.31	3.49	10.28	3.47
	46	9.24	3.37	9.27	3.42	9.28	3.44	9.30	3.47	9.85	3.47	9.96	3.47
2.0 + 2.0 + 3.5 + 4.2	22	10.29	1.49	9.35	1.56	9.04	1.58	8.41	1.62	10.53	1.90	11.94	2.08
	25	10.38	2.07	9.83	2.10	9.64	2.11	9.28	2.13	10.83	2.31	11.87	2.42
	29	10.54	2.69	10.32	2.69	10.24	2.69	10.09	2.69	11.06	2.76	11.70	2.81
	32	10.36	3.04	10.41	3.02	10.43	3.02	10.46	3.01	11.10	3.03	11.53	3.04
	35	10.25	3.29	10.42	3.27	10.48	3.26	10.60	3.25	11.03	3.23	11.32	3.22
	40	9.92	3.49	10.14	3.49	10.21	3.49	10.36	3.48	10.32	3.44	10.60	3.41
	43	9.61	3.48	9.77	3.50	9.83	3.51	9.94	3.52	10.31	3.49	10.28	3.47
	46	9.24	3.37	9.27	3.42	9.28	3.44	9.30	3.47	9.85	3.47	9.96	3.47
2.0 + 2.0 + 3.5 + 5.0	22	10.48	1.43	9.53	1.49	9.21	1.51	8.57	1.55	10.73	1.82	12.16	1.99
	25	10.57	1.98	10.01	2.01	9.83	2.02	9.45	2.04	11.04	2.21	12.09	2.32
	29	10.74	2.57	10.51	2.57	10.44	2.57	10.28	2.57	11.26	2.64	11.92	2.69
	32	10.56	2.91	10.61	2.89	10.62	2.89	10.66	2.88	11.31	2.90	11.75	2.91
	35	10.44	3.15	10.62	3.13	10.68	3.12	10.80	3.11	11.24	3.09	11.53	3.08
	40	10.10	3.34	10.33	3.34	10.41	3.34	10.56	3.33	10.52	3.29	10.80	3.27
	43	9.79	3.33	9.96	3.35	10.02	3.35	10.13	3.37	10.51	3.34	10.48	3.32
	46	9.42	3.23	9.45	3.28	9.46	3.29	9.48	3.32	10.03	3.32	10.15	3.32

Combination (Capacity)	Outdoor Air Temp. °C DB	Indoor Air Temp. °C											
		27/16		27/17.5		27/18		27/19		27/22		27/24	
		Total Q	Input Power	Total Q	Input Power	Total Q	Input Power	Total Q	Input Power	Total Q	Input Power	Total Q	Input Power
2.0 + 2.0 + 3.5 + 6.0	22	10.48	1.43	9.53	1.49	9.21	1.51	8.57	1.55	10.73	1.82	12.16	1.99
	25	10.57	1.98	10.01	2.01	9.83	2.02	9.45	2.04	11.04	2.21	12.09	2.32
	29	10.74	2.57	10.51	2.57	10.44	2.57	10.28	2.57	11.26	2.64	11.92	2.69
	32	10.56	2.91	10.61	2.89	10.62	2.89	10.66	2.88	11.31	2.90	11.75	2.91
	35	10.44	3.15	10.62	3.13	10.68	3.12	10.80	3.11	11.24	3.09	11.53	3.08
	40	10.10	3.34	10.33	3.34	10.41	3.34	10.56	3.33	10.52	3.29	10.80	3.27
	43	9.79	3.33	9.96	3.35	10.02	3.35	10.13	3.37	10.51	3.34	10.48	3.32
	46	9.42	3.23	9.45	3.28	9.46	3.29	9.48	3.32	10.03	3.32	10.15	3.32
2.0 + 2.0 + 3.5 + 7.1	22	10.68	1.46	9.70	1.53	9.38	1.55	8.73	1.59	10.93	1.86	12.39	2.04
	25	10.77	2.03	10.20	2.06	10.01	2.07	9.63	2.09	11.24	2.26	12.32	2.38
	29	10.94	2.64	10.71	2.64	10.63	2.64	10.47	2.64	11.47	2.71	12.14	2.76
	32	10.76	2.98	10.80	2.97	10.82	2.96	10.85	2.95	11.52	2.97	11.97	2.99
	35	10.63	3.23	10.82	3.21	10.88	3.20	11.00	3.19	11.45	3.17	11.75	3.16
	40	10.29	3.43	10.52	3.42	10.60	3.42	10.76	3.42	10.71	3.38	11.00	3.35
	43	9.97	3.41	10.14	3.43	10.20	3.44	10.31	3.45	10.70	3.42	10.67	3.40
	46	9.59	3.31	9.62	3.36	9.63	3.38	9.65	3.41	10.22	3.41	10.34	3.40
2.0 + 2.0 + 4.2 + 4.2	22	10.48	1.56	9.53	1.63	9.21	1.65	8.57	1.70	10.73	1.98	12.16	2.18
	25	10.57	2.17	10.01	2.20	9.83	2.21	9.45	2.23	11.04	2.41	12.09	2.53
	29	10.74	2.81	10.51	2.81	10.44	2.81	10.28	2.81	11.26	2.89	11.92	2.94
	32	10.56	3.18	10.61	3.16	10.62	3.16	10.66	3.14	11.31	3.17	11.75	3.18
	35	10.44	3.44	10.62	3.42	10.68	3.41	10.80	3.40	11.24	3.38	11.53	3.37
	40	10.10	3.66	10.33	3.65	10.41	3.65	10.56	3.64	10.52	3.60	10.80	3.57
	43	9.79	3.64	9.96	3.66	10.02	3.67	10.13	3.68	10.51	3.65	10.48	3.63
	46	9.42	3.53	9.45	3.58	9.46	3.60	9.48	3.63	10.03	3.63	10.15	3.63
2.0 + 2.0 + 4.2 + 5.0	22	10.48	1.43	9.53	1.49	9.21	1.51	8.57	1.55	10.73	1.82	12.16	1.99
	25	10.57	1.98	10.01	2.01	9.83	2.02	9.45	2.04	11.04	2.21	12.09	2.32
	29	10.74	2.57	10.51	2.57	10.44	2.57	10.28	2.57	11.26	2.64	11.92	2.69
	32	10.56	2.91	10.61	2.89	10.62	2.89	10.66	2.88	11.31	2.90	11.75	2.91
	35	10.44	3.15	10.62	3.13	10.68	3.12	10.80	3.11	11.24	3.09	11.53	3.08
	40	10.10	3.34	10.33	3.34	10.41	3.34	10.56	3.33	10.52	3.29	10.80	3.27
	43	9.79	3.33	9.96	3.35	10.02	3.35	10.13	3.37	10.51	3.34	10.48	3.32
	46	9.42	3.23	9.45	3.28	9.46	3.29	9.48	3.32	10.03	3.32	10.15	3.32
2.0 + 2.0 + 4.2 + 6.0	22	10.68	1.49	9.70	1.56	9.38	1.58	8.73	1.63	10.93	1.90	12.39	2.09
	25	10.77	2.08	10.20	2.11	10.01	2.12	9.63	2.14	11.24	2.31	12.32	2.43
	29	10.94	2.69	10.71	2.69	10.63	2.69	10.47	2.69	11.47	2.77	12.14	2.82
	32	10.76	3.05	10.80	3.03	10.82	3.03	10.85	3.02	11.52	3.04	11.97	3.05
	35	10.63	3.30	10.82	3.28	10.88	3.27	11.00	3.26	11.45	3.24	11.75	3.23
	40	10.29	3.50	10.52	3.50	10.60	3.50	10.76	3.49	10.71	3.45	11.00	3.42
	43	9.97	3.49	10.14	3.51	10.20	3.52	10.31	3.53	10.70	3.50	10.67	3.48
	46	9.59	3.38	9.62	3.43	9.63	3.45	9.65	3.48	10.22	3.48	10.34	3.48

Combination (Capacity)	Outdoor Air Temp. °C DB	Indoor Air Temp. °C											
		27/16		27/17.5		27/18		27/19		27/22		27/24	
		Total Q	Input Power	Total Q	Input Power	Total Q	Input Power	Total Q	Input Power	Total Q	Input Power	Total Q	Input Power
2.0 + 2.0 + 4.2 + 7.1	22	10.68	1.46	9.70	1.53	9.38	1.55	8.73	1.59	10.93	1.86	12.39	2.04
	25	10.77	2.03	10.20	2.06	10.01	2.07	9.63	2.09	11.24	2.26	12.32	2.38
	29	10.94	2.64	10.71	2.64	10.63	2.64	10.47	2.64	11.47	2.71	12.14	2.76
	32	10.76	2.98	10.80	2.97	10.82	2.96	10.85	2.95	11.52	2.97	11.97	2.99
	35	10.63	3.23	10.82	3.21	10.88	3.20	11.00	3.19	11.45	3.17	11.75	3.16
	40	10.29	3.43	10.52	3.42	10.60	3.42	10.76	3.42	10.71	3.38	11.00	3.35
	43	9.97	3.41	10.14	3.43	10.20	3.44	10.31	3.45	10.70	3.42	10.67	3.40
	46	9.59	3.31	9.62	3.36	9.63	3.38	9.65	3.41	10.22	3.41	10.34	3.40
2.0 + 2.0 + 5.0 + 5.0	22	10.48	1.37	9.53	1.43	9.21	1.45	8.57	1.49	10.73	1.74	12.16	1.91
	25	10.57	1.90	10.01	1.93	9.83	1.94	9.45	1.95	11.04	2.11	12.09	2.22
	29	10.74	2.46	10.51	2.46	10.44	2.46	10.28	2.46	11.26	2.53	11.92	2.57
	32	10.56	2.78	10.61	2.77	10.62	2.77	10.66	2.76	11.31	2.78	11.75	2.79
	35	10.44	3.02	10.62	3.00	10.68	2.99	10.80	2.98	11.24	2.96	11.53	2.95
	40	10.10	3.20	10.33	3.20	10.41	3.20	10.56	3.19	10.52	3.16	10.80	3.13
	43	9.79	3.19	9.96	3.21	10.02	3.21	10.13	3.23	10.51	3.20	10.48	3.18
	46	9.42	3.09	9.45	3.14	9.46	3.15	9.48	3.19	10.03	3.18	10.15	3.18
2.0 + 2.0 + 5.0 + 6.0	22	10.68	1.43	9.70	1.49	9.38	1.52	8.73	1.56	10.93	1.82	12.39	2.00
	25	10.77	1.99	10.20	2.02	10.01	2.03	9.63	2.05	11.24	2.21	12.32	2.32
	29	10.94	2.58	10.71	2.58	10.63	2.58	10.47	2.58	11.47	2.65	12.14	2.70
	32	10.76	2.91	10.80	2.90	10.82	2.90	10.85	2.89	11.52	2.91	11.97	2.92
	35	10.63	3.16	10.82	3.14	10.88	3.13	11.00	3.12	11.45	3.10	11.75	3.09
	40	10.29	3.35	10.52	3.35	10.60	3.35	10.76	3.34	10.71	3.30	11.00	3.28
	43	9.97	3.34	10.14	3.36	10.20	3.37	10.31	3.38	10.70	3.35	10.67	3.33
	46	9.59	3.24	9.62	3.29	9.63	3.30	9.65	3.33	10.22	3.33	10.34	3.33
2.0 + 2.0 + 5.0 + 7.1	22	10.87	1.47	9.88	1.53	9.55	1.55	8.89	1.60	11.12	1.87	12.61	2.05
	25	10.96	2.04	10.38	2.07	10.19	2.08	9.80	2.10	11.45	2.27	12.54	2.38
	29	11.14	2.64	10.90	2.64	10.82	2.64	10.66	2.64	11.68	2.72	12.36	2.76
	32	10.95	2.99	11.00	2.97	11.02	2.97	11.05	2.96	11.73	2.98	12.18	2.99
	35	10.83	3.24	11.01	3.22	11.08	3.21	11.20	3.20	11.66	3.18	11.96	3.17
	40	10.48	3.44	10.71	3.44	10.79	3.43	10.95	3.43	10.91	3.39	11.20	3.36
	43	10.15	3.43	10.33	3.45	10.39	3.45	10.50	3.47	10.90	3.44	10.86	3.42
	46	9.77	3.32	9.80	3.37	9.81	3.39	9.83	3.42	10.41	3.42	10.53	3.42
2.0 + 2.0 + 6.0 + 6.0	22	10.87	1.46	9.88	1.53	9.55	1.55	8.89	1.59	11.12	1.86	12.61	2.04
	25	10.96	2.03	10.38	2.06	10.19	2.07	9.80	2.09	11.45	2.26	12.54	2.38
	29	11.14	2.64	10.90	2.64	10.82	2.64	10.66	2.64	11.68	2.71	12.36	2.76
	32	10.95	2.98	11.00	2.97	11.02	2.96	11.05	2.95	11.73	2.97	12.18	2.99
	35	10.83	3.23	11.01	3.21	11.08	3.20	11.20	3.19	11.66	3.17	11.96	3.16
	40	10.48	3.43	10.71	3.42	10.79	3.42	10.95	3.42	10.91	3.38	11.20	3.35
	43	10.15	3.41	10.33	3.43	10.39	3.44	10.50	3.45	10.90	3.42	10.86	3.40
	46	9.77	3.31	9.80	3.36	9.81	3.38	9.83	3.41	10.41	3.41	10.53	3.40

Combination (Capacity)	Outdoor Air Temp. °C DB	Indoor Air Temp. °C											
		27/16		27/17.5		27/18		27/19		27/22		27/24	
		Total Q	Input Power	Total Q	Input Power	Total Q	Input Power	Total Q	Input Power	Total Q	Input Power	Total Q	Input Power
2.0 + 2.0 + 6.0 + 7.1	22	10.87	1.47	9.88	1.53	9.55	1.55	8.89	1.60	11.12	1.87	12.61	2.05
	25	10.96	2.04	10.38	2.07	10.19	2.08	9.80	2.10	11.45	2.27	12.54	2.38
	29	11.14	2.64	10.90	2.64	10.82	2.64	10.66	2.64	11.68	2.72	12.36	2.76
	32	10.95	2.99	11.00	2.97	11.02	2.97	11.05	2.96	11.73	2.98	12.18	2.99
	35	10.83	3.24	11.01	3.22	11.08	3.21	11.20	3.20	11.66	3.18	11.96	3.17
	40	10.48	3.44	10.71	3.44	10.79	3.43	10.95	3.43	10.91	3.39	11.20	3.36
	43	10.15	3.43	10.33	3.45	10.39	3.45	10.50	3.47	10.90	3.44	10.86	3.42
	46	9.77	3.32	9.80	3.37	9.81	3.39	9.83	3.42	10.41	3.42	10.53	3.42
2.0 + 2.0 + 7.1 + 7.1	22	10.87	1.44	9.88	1.50	9.55	1.52	8.89	1.56	11.12	1.83	12.61	2.00
	25	10.96	1.99	10.38	2.02	10.19	2.03	9.80	2.05	11.45	2.22	12.54	2.33
	29	11.14	2.59	10.90	2.59	10.82	2.59	10.66	2.59	11.68	2.66	12.36	2.70
	32	10.95	2.92	11.00	2.91	11.02	2.90	11.05	2.89	11.73	2.92	12.18	2.93
	35	10.83	3.17	11.01	3.15	11.08	3.14	11.20	3.13	11.66	3.11	11.96	3.10
	40	10.48	3.37	10.71	3.36	10.79	3.36	10.95	3.36	10.91	3.31	11.20	3.29
	43	10.15	3.35	10.33	3.37	10.39	3.38	10.50	3.39	10.90	3.36	10.86	3.34
	46	9.77	3.25	9.80	3.30	9.81	3.31	9.83	3.35	10.41	3.34	10.53	3.34
2.0 + 2.5 + 2.5 + 2.5	22	10.29	1.56	9.35	1.63	9.04	1.65	8.41	1.70	10.53	1.98	11.94	2.18
	25	10.38	2.17	9.83	2.20	9.64	2.21	9.28	2.23	10.83	2.41	11.87	2.53
	29	10.54	2.81	10.32	2.81	10.24	2.81	10.09	2.81	11.06	2.89	11.70	2.94
	32	10.36	3.18	10.41	3.16	10.43	3.16	10.46	3.14	11.10	3.17	11.53	3.18
	35	10.25	3.44	10.42	3.42	10.48	3.41	10.60	3.40	11.03	3.38	11.32	3.37
	40	9.92	3.66	10.14	3.65	10.21	3.65	10.36	3.64	10.32	3.60	10.60	3.57
	43	9.61	3.64	9.77	3.66	9.83	3.67	9.94	3.68	10.31	3.65	10.28	3.63
	46	9.24	3.53	9.27	3.58	9.28	3.60	9.30	3.63	9.85	3.63	9.96	3.63
2.0 + 2.5 + 2.5 + 3.5	22	10.29	1.53	9.35	1.59	9.04	1.62	8.41	1.66	10.53	1.94	11.94	2.13
	25	10.38	2.12	9.83	2.15	9.64	2.16	9.28	2.18	10.83	2.36	11.87	2.48
	29	10.54	2.75	10.32	2.75	10.24	2.75	10.09	2.75	11.06	2.83	11.70	2.88
	32	10.36	3.11	10.41	3.10	10.43	3.09	10.46	3.08	11.10	3.10	11.53	3.12
	35	10.25	3.37	10.42	3.35	10.48	3.34	10.60	3.33	11.03	3.31	11.32	3.30
	40	9.92	3.58	10.14	3.57	10.21	3.57	10.36	3.57	10.32	3.53	10.60	3.50
	43	9.61	3.56	9.77	3.59	9.83	3.59	9.94	3.61	10.31	3.57	10.28	3.55
	46	9.24	3.46	9.27	3.51	9.28	3.52	9.30	3.56	9.85	3.56	9.96	3.55
2.0 + 2.5 + 2.5 + 4.2	22	10.29	1.53	9.35	1.59	9.04	1.62	8.41	1.66	10.53	1.94	11.94	2.13
	25	10.38	2.12	9.83	2.15	9.64	2.16	9.28	2.18	10.83	2.36	11.87	2.48
	29	10.54	2.75	10.32	2.75	10.24	2.75	10.09	2.75	11.06	2.83	11.70	2.88
	32	10.36	3.11	10.41	3.10	10.43	3.09	10.46	3.08	11.10	3.10	11.53	3.12
	35	10.25	3.37	10.42	3.35	10.48	3.34	10.60	3.33	11.03	3.31	11.32	3.30
	40	9.92	3.58	10.14	3.57	10.21	3.57	10.36	3.57	10.32	3.53	10.60	3.50
	43	9.61	3.56	9.77	3.59	9.83	3.59	9.94	3.61	10.31	3.57	10.28	3.55
	46	9.24	3.46	9.27	3.51	9.28	3.52	9.30	3.56	9.85	3.56	9.96	3.55

Combination (Capacity)	Outdoor Air Temp. °C DB	Indoor Air Temp. °C											
		27/16		27/17.5		27/18		27/19		27/22		27/24	
		Total Q	Input Power	Total Q	Input Power	Total Q	Input Power	Total Q	Input Power	Total Q	Input Power	Total Q	Input Power
2.0 + 2.5 + 2.5 + 5.0	22	10.29	1.39	9.35	1.46	9.04	1.48	8.41	1.52	10.53	1.77	11.94	1.95
	25	10.38	1.94	9.83	1.96	9.64	1.97	9.28	1.99	10.83	2.16	11.87	2.26
	29	10.54	2.51	10.32	2.51	10.24	2.51	10.09	2.51	11.06	2.58	11.70	2.63
	32	10.36	2.84	10.41	2.83	10.43	2.82	10.46	2.81	11.10	2.83	11.53	2.84
	35	10.25	3.08	10.42	3.06	10.48	3.05	10.60	3.04	11.03	3.02	11.32	3.01
	40	9.92	3.27	10.14	3.26	10.21	3.26	10.36	3.26	10.32	3.22	10.60	3.19
	43	9.61	3.25	9.77	3.27	9.83	3.28	9.94	3.29	10.31	3.26	10.28	3.24
	46	9.24	3.15	9.27	3.20	9.28	3.22	9.30	3.25	9.85	3.25	9.96	3.24
2.0 + 2.5 + 2.5 + 6.0	22	10.48	1.46	9.53	1.52	9.21	1.54	8.57	1.59	10.73	1.86	12.16	2.04
	25	10.57	2.03	10.01	2.06	9.83	2.07	9.45	2.09	11.04	2.26	12.09	2.37
	29	10.74	2.63	10.51	2.63	10.44	2.63	10.28	2.63	11.26	2.70	11.92	2.75
	32	10.56	2.97	10.61	2.96	10.62	2.95	10.66	2.94	11.31	2.96	11.75	2.98
	35	10.44	3.22	10.62	3.20	10.68	3.19	10.80	3.18	11.24	3.16	11.53	3.15
	40	10.10	3.42	10.33	3.41	10.41	3.41	10.56	3.41	10.52	3.37	10.80	3.34
	43	9.79	3.40	9.96	3.42	10.02	3.43	10.13	3.44	10.51	3.41	10.48	3.39
	46	9.42	3.30	9.45	3.35	9.46	3.37	9.48	3.40	10.03	3.40	10.15	3.39
2.0 + 2.5 + 2.5 + 7.1	22	10.48	1.43	9.53	1.49	9.21	1.51	8.57	1.55	10.73	1.82	12.16	1.99
	25	10.57	1.98	10.01	2.01	9.83	2.02	9.45	2.04	11.04	2.21	12.09	2.32
	29	10.74	2.57	10.51	2.57	10.44	2.57	10.28	2.57	11.26	2.64	11.92	2.69
	32	10.56	2.91	10.61	2.89	10.62	2.89	10.66	2.88	11.31	2.90	11.75	2.91
	35	10.44	3.15	10.62	3.13	10.68	3.12	10.80	3.11	11.24	3.09	11.53	3.08
	40	10.10	3.34	10.33	3.34	10.41	3.34	10.56	3.33	10.52	3.29	10.80	3.27
	43	9.79	3.33	9.96	3.35	10.02	3.35	10.13	3.37	10.51	3.34	10.48	3.32
	46	9.42	3.23	9.45	3.28	9.46	3.29	9.48	3.32	10.03	3.32	10.15	3.32
2.0 + 2.5 + 3.5 + 3.5	22	10.29	1.49	9.35	1.56	9.04	1.58	8.41	1.62	10.53	1.90	11.94	2.08
	25	10.38	2.07	9.83	2.10	9.64	2.11	9.28	2.13	10.83	2.31	11.87	2.42
	29	10.54	2.69	10.32	2.69	10.24	2.69	10.09	2.69	11.06	2.76	11.70	2.81
	32	10.36	3.04	10.41	3.02	10.43	3.02	10.46	3.01	11.10	3.03	11.53	3.04
	35	10.25	3.29	10.42	3.27	10.48	3.26	10.60	3.25	11.03	3.23	11.32	3.22
	40	9.92	3.49	10.14	3.49	10.21	3.49	10.36	3.48	10.32	3.44	10.60	3.41
	43	9.61	3.48	9.77	3.50	9.83	3.51	9.94	3.52	10.31	3.49	10.28	3.47
	46	9.24	3.37	9.27	3.42	9.28	3.44	9.30	3.47	9.85	3.47	9.96	3.47
2.0 + 2.5 + 3.5 + 4.2	22	10.48	1.56	9.53	1.63	9.21	1.65	8.57	1.70	10.73	1.98	12.16	2.18
	25	10.57	2.17	10.01	2.20	9.83	2.21	9.45	2.23	11.04	2.41	12.09	2.53
	29	10.74	2.81	10.51	2.81	10.44	2.81	10.28	2.81	11.26	2.89	11.92	2.94
	32	10.56	3.18	10.61	3.16	10.62	3.16	10.66	3.14	11.31	3.17	11.75	3.18
	35	10.44	3.44	10.62	3.42	10.68	3.41	10.80	3.40	11.24	3.38	11.53	3.37
	40	10.10	3.66	10.33	3.65	10.41	3.65	10.56	3.64	10.52	3.60	10.80	3.57
	43	9.79	3.64	9.96	3.66	10.02	3.67	10.13	3.68	10.51	3.65	10.48	3.63
	46	9.42	3.53	9.45	3.58	9.46	3.60	9.48	3.63	10.03	3.63	10.15	3.63

Combination (Capacity)	Outdoor Air Temp. °C DB	Indoor Air Temp. °C											
		27/16		27/17.5		27/18		27/19		27/22		27/24	
		Total Q	Input Power	Total Q	Input Power	Total Q	Input Power	Total Q	Input Power	Total Q	Input Power	Total Q	Input Power
2.0 + 2.5 + 3.5 + 5.0	22	10.48	1.43	9.53	1.49	9.21	1.51	8.57	1.55	10.73	1.82	12.16	1.99
	25	10.57	1.98	10.01	2.01	9.83	2.02	9.45	2.04	11.04	2.21	12.09	2.32
	29	10.74	2.57	10.51	2.57	10.44	2.57	10.28	2.57	11.26	2.64	11.92	2.69
	32	10.56	2.91	10.61	2.89	10.62	2.89	10.66	2.88	11.31	2.90	11.75	2.91
	35	10.44	3.15	10.62	3.13	10.68	3.12	10.80	3.11	11.24	3.09	11.53	3.08
	40	10.10	3.34	10.33	3.34	10.41	3.34	10.56	3.33	10.52	3.29	10.80	3.27
	43	9.79	3.33	9.96	3.35	10.02	3.35	10.13	3.37	10.51	3.34	10.48	3.32
	46	9.42	3.23	9.45	3.28	9.46	3.29	9.48	3.32	10.03	3.32	10.15	3.32
2.0 + 2.5 + 3.5 + 6.0	22	10.48	1.43	9.53	1.49	9.21	1.51	8.57	1.55	10.73	1.82	12.16	1.99
	25	10.57	1.98	10.01	2.01	9.83	2.02	9.45	2.04	11.04	2.21	12.09	2.32
	29	10.74	2.57	10.51	2.57	10.44	2.57	10.28	2.57	11.26	2.64	11.92	2.69
	32	10.56	2.91	10.61	2.89	10.62	2.89	10.66	2.88	11.31	2.90	11.75	2.91
	35	10.44	3.15	10.62	3.13	10.68	3.12	10.80	3.11	11.24	3.09	11.53	3.08
	40	10.10	3.34	10.33	3.34	10.41	3.34	10.56	3.33	10.52	3.29	10.80	3.27
	43	9.79	3.33	9.96	3.35	10.02	3.35	10.13	3.37	10.51	3.34	10.48	3.32
	46	9.42	3.23	9.45	3.28	9.46	3.29	9.48	3.32	10.03	3.32	10.15	3.32
2.0 + 2.5 + 3.5 + 7.1	22	10.68	1.46	9.70	1.53	9.38	1.55	8.73	1.59	10.93	1.86	12.39	2.04
	25	10.77	2.03	10.20	2.06	10.01	2.07	9.63	2.09	11.24	2.26	12.32	2.38
	29	10.94	2.64	10.71	2.64	10.63	2.64	10.47	2.64	11.47	2.71	12.14	2.76
	32	10.76	2.98	10.80	2.97	10.82	2.96	10.85	2.95	11.52	2.97	11.97	2.99
	35	10.63	3.23	10.82	3.21	10.88	3.20	11.00	3.19	11.45	3.17	11.75	3.16
	40	10.29	3.43	10.52	3.42	10.60	3.42	10.76	3.42	10.71	3.38	11.00	3.35
	43	9.97	3.41	10.14	3.43	10.20	3.44	10.31	3.45	10.70	3.42	10.67	3.40
	46	9.59	3.31	9.62	3.36	9.63	3.38	9.65	3.41	10.22	3.41	10.34	3.40
2.0 + 2.5 + 4.2 + 4.2	22	10.48	1.56	9.53	1.63	9.21	1.65	8.57	1.70	10.73	1.98	12.16	2.18
	25	10.57	2.17	10.01	2.20	9.83	2.21	9.45	2.23	11.04	2.41	12.09	2.53
	29	10.74	2.81	10.51	2.81	10.44	2.81	10.28	2.81	11.26	2.89	11.92	2.94
	32	10.56	3.18	10.61	3.16	10.62	3.16	10.66	3.14	11.31	3.17	11.75	3.18
	35	10.44	3.44	10.62	3.42	10.68	3.41	10.80	3.40	11.24	3.38	11.53	3.37
	40	10.10	3.66	10.33	3.65	10.41	3.65	10.56	3.64	10.52	3.60	10.80	3.57
	43	9.79	3.64	9.96	3.66	10.02	3.67	10.13	3.68	10.51	3.65	10.48	3.63
	46	9.42	3.53	9.45	3.58	9.46	3.60	9.48	3.63	10.03	3.63	10.15	3.63
2.0 + 2.5 + 4.2 + 5.0	22	10.48	1.43	9.53	1.49	9.21	1.51	8.57	1.55	10.73	1.82	12.16	1.99
	25	10.57	1.98	10.01	2.01	9.83	2.02	9.45	2.04	11.04	2.21	12.09	2.32
	29	10.74	2.57	10.51	2.57	10.44	2.57	10.28	2.57	11.26	2.64	11.92	2.69
	32	10.56	2.91	10.61	2.89	10.62	2.89	10.66	2.88	11.31	2.90	11.75	2.91
	35	10.44	3.15	10.62	3.13	10.68	3.12	10.80	3.11	11.24	3.09	11.53	3.08
	40	10.10	3.34	10.33	3.34	10.41	3.34	10.56	3.33	10.52	3.29	10.80	3.27
	43	9.79	3.33	9.96	3.35	10.02	3.35	10.13	3.37	10.51	3.34	10.48	3.32
	46	9.42	3.23	9.45	3.28	9.46	3.29	9.48	3.32	10.03	3.32	10.15	3.32

Combination (Capacity)	Outdoor Air Temp. °C DB	Indoor Air Temp. °C											
		27/16		27/17.5		27/18		27/19		27/22		27/24	
		Total Q	Input Power	Total Q	Input Power	Total Q	Input Power	Total Q	Input Power	Total Q	Input Power	Total Q	Input Power
2.0 + 2.5 + 4.2 + 6.0	22	10.68	1.49	9.70	1.56	9.38	1.58	8.73	1.63	10.93	1.90	12.39	2.09
	25	10.77	2.08	10.20	2.11	10.01	2.12	9.63	2.14	11.24	2.31	12.32	2.43
	29	10.94	2.69	10.71	2.69	10.63	2.69	10.47	2.69	11.47	2.77	12.14	2.82
	32	10.76	3.05	10.80	3.03	10.82	3.03	10.85	3.02	11.52	3.04	11.97	3.05
	35	10.63	3.30	10.82	3.28	10.88	3.27	11.00	3.26	11.45	3.24	11.75	3.23
	40	10.29	3.50	10.52	3.50	10.60	3.50	10.76	3.49	10.71	3.45	11.00	3.42
	43	9.97	3.49	10.14	3.51	10.20	3.52	10.31	3.53	10.70	3.50	10.67	3.48
	46	9.59	3.38	9.62	3.43	9.63	3.45	9.65	3.48	10.22	3.48	10.34	3.48
2.0 + 2.5 + 4.2 + 7.1	22	10.87	1.53	9.88	1.59	9.55	1.62	8.89	1.66	11.12	1.94	12.61	2.13
	25	10.96	2.12	10.38	2.15	10.19	2.16	9.80	2.18	11.45	2.36	12.54	2.48
	29	11.14	2.75	10.90	2.75	10.82	2.75	10.66	2.75	11.68	2.83	12.36	2.88
	32	10.95	3.11	11.00	3.10	11.02	3.09	11.05	3.08	11.73	3.10	12.18	3.12
	35	10.83	3.37	11.01	3.35	11.08	3.34	11.20	3.33	11.66	3.31	11.96	3.30
	40	10.48	3.58	10.71	3.57	10.79	3.57	10.95	3.57	10.91	3.53	11.20	3.50
	43	10.15	3.56	10.33	3.59	10.39	3.59	10.50	3.61	10.90	3.57	10.86	3.55
	46	9.77	3.46	9.80	3.51	9.81	3.52	9.83	3.56	10.41	3.56	10.53	3.55
2.0 + 2.5 + 5.0 + 5.0	22	10.68	1.43	9.70	1.49	9.38	1.52	8.73	1.56	10.93	1.82	12.39	2.00
	25	10.77	1.99	10.20	2.02	10.01	2.03	9.63	2.05	11.24	2.21	12.32	2.32
	29	10.94	2.58	10.71	2.58	10.63	2.58	10.47	2.58	11.47	2.65	12.14	2.70
	32	10.76	2.91	10.80	2.90	10.82	2.90	10.85	2.89	11.52	2.91	11.97	2.92
	35	10.63	3.16	10.82	3.14	10.88	3.13	11.00	3.12	11.45	3.10	11.75	3.09
	40	10.29	3.35	10.52	3.35	10.60	3.35	10.76	3.34	10.71	3.30	11.00	3.28
	43	9.97	3.34	10.14	3.36	10.20	3.37	10.31	3.38	10.70	3.35	10.67	3.33
	46	9.59	3.24	9.62	3.29	9.63	3.30	9.65	3.33	10.22	3.33	10.34	3.33
2.0 + 2.5 + 5.0 + 6.0	22	10.68	1.43	9.70	1.49	9.38	1.52	8.73	1.56	10.93	1.82	12.39	2.00
	25	10.77	1.99	10.20	2.02	10.01	2.03	9.63	2.05	11.24	2.21	12.32	2.32
	29	10.94	2.58	10.71	2.58	10.63	2.58	10.47	2.58	11.47	2.65	12.14	2.70
	32	10.76	2.91	10.80	2.90	10.82	2.90	10.85	2.89	11.52	2.91	11.97	2.92
	35	10.63	3.16	10.82	3.14	10.88	3.13	11.00	3.12	11.45	3.10	11.75	3.09
	40	10.29	3.35	10.52	3.35	10.60	3.35	10.76	3.34	10.71	3.30	11.00	3.28
	43	9.97	3.34	10.14	3.36	10.20	3.37	10.31	3.38	10.70	3.35	10.67	3.33
	46	9.59	3.24	9.62	3.29	9.63	3.30	9.65	3.33	10.22	3.33	10.34	3.33
2.0 + 2.5 + 5.0 + 7.1	22	10.87	1.47	9.88	1.53	9.55	1.55	8.89	1.60	11.12	1.87	12.61	2.05
	25	10.96	2.04	10.38	2.07	10.19	2.08	9.80	2.10	11.45	2.27	12.54	2.38
	29	11.14	2.64	10.90	2.64	10.82	2.64	10.66	2.64	11.68	2.72	12.36	2.76
	32	10.95	2.99	11.00	2.97	11.02	2.97	11.05	2.96	11.73	2.98	12.18	2.99
	35	10.83	3.24	11.01	3.22	11.08	3.21	11.20	3.20	11.66	3.18	11.96	3.17
	40	10.48	3.44	10.71	3.44	10.79	3.43	10.95	3.43	10.91	3.39	11.20	3.36
	43	10.15	3.43	10.33	3.45	10.39	3.45	10.50	3.47	10.90	3.44	10.86	3.42
	46	9.77	3.32	9.80	3.37	9.81	3.39	9.83	3.42	10.41	3.42	10.53	3.42

Combination (Capacity)	Outdoor Air Temp. °C DB	Indoor Air Temp. °C											
		27/16		27/17.5		27/18		27/19		27/22		27/24	
		Total Q	Input Power	Total Q	Input Power	Total Q	Input Power	Total Q	Input Power	Total Q	Input Power	Total Q	Input Power
2.0 + 2.5 + 6.0 + 6.0	22	10.87	1.46	9.88	1.53	9.55	1.55	8.89	1.59	11.12	1.86	12.61	2.04
	25	10.96	2.03	10.38	2.06	10.19	2.07	9.80	2.09	11.45	2.26	12.54	2.38
	29	11.14	2.64	10.90	2.64	10.82	2.64	10.66	2.64	11.68	2.71	12.36	2.76
	32	10.95	2.98	11.00	2.97	11.02	2.96	11.05	2.95	11.73	2.97	12.18	2.99
	35	10.83	3.23	11.01	3.21	11.08	3.20	11.20	3.19	11.66	3.17	11.96	3.16
	40	10.48	3.43	10.71	3.42	10.79	3.42	10.95	3.42	10.91	3.38	11.20	3.35
	43	10.15	3.41	10.33	3.43	10.39	3.44	10.50	3.45	10.90	3.42	10.86	3.40
	46	9.77	3.31	9.80	3.36	9.81	3.38	9.83	3.41	10.41	3.41	10.53	3.40
2.0 + 2.5 + 6.0 + 7.1	22	10.87	1.47	9.88	1.53	9.55	1.55	8.89	1.60	11.12	1.87	12.61	2.05
	25	10.96	2.04	10.38	2.07	10.19	2.08	9.80	2.10	11.45	2.27	12.54	2.38
	29	11.14	2.64	10.90	2.64	10.82	2.64	10.66	2.64	11.68	2.72	12.36	2.76
	32	10.95	2.99	11.00	2.97	11.02	2.97	11.05	2.96	11.73	2.98	12.18	2.99
	35	10.83	3.24	11.01	3.22	11.08	3.21	11.20	3.20	11.66	3.18	11.96	3.17
	40	10.48	3.44	10.71	3.44	10.79	3.43	10.95	3.43	10.91	3.39	11.20	3.36
	43	10.15	3.43	10.33	3.45	10.39	3.45	10.50	3.47	10.90	3.44	10.86	3.42
	46	9.77	3.32	9.80	3.37	9.81	3.39	9.83	3.42	10.41	3.42	10.53	3.42
2.0 + 3.5 + 3.5 + 3.5	22	10.48	1.53	9.53	1.59	9.21	1.62	8.57	1.66	10.73	1.94	12.16	2.13
	25	10.57	2.12	10.01	2.15	9.83	2.16	9.45	2.18	11.04	2.36	12.09	2.48
	29	10.74	2.75	10.51	2.75	10.44	2.75	10.28	2.75	11.26	2.83	11.92	2.88
	32	10.56	3.11	10.61	3.10	10.62	3.09	10.66	3.08	11.31	3.10	11.75	3.12
	35	10.44	3.37	10.62	3.35	10.68	3.34	10.80	3.33	11.24	3.31	11.53	3.30
	40	10.10	3.58	10.33	3.57	10.41	3.57	10.56	3.57	10.52	3.53	10.80	3.50
	43	9.79	3.56	9.96	3.59	10.02	3.59	10.13	3.61	10.51	3.57	10.48	3.55
	46	9.42	3.46	9.45	3.51	9.46	3.52	9.48	3.56	10.03	3.56	10.15	3.55
2.0 + 3.5 + 3.5 + 4.2	22	10.48	1.53	9.53	1.59	9.21	1.62	8.57	1.66	10.73	1.94	12.16	2.13
	25	10.57	2.12	10.01	2.15	9.83	2.16	9.45	2.18	11.04	2.36	12.09	2.48
	29	10.74	2.75	10.51	2.75	10.44	2.75	10.28	2.75	11.26	2.83	11.92	2.88
	32	10.56	3.11	10.61	3.10	10.62	3.09	10.66	3.08	11.31	3.10	11.75	3.12
	35	10.44	3.37	10.62	3.35	10.68	3.34	10.80	3.33	11.24	3.31	11.53	3.30
	40	10.10	3.58	10.33	3.57	10.41	3.57	10.56	3.57	10.52	3.53	10.80	3.50
	43	9.79	3.56	9.96	3.59	10.02	3.59	10.13	3.61	10.51	3.57	10.48	3.55
	46	9.42	3.46	9.45	3.51	9.46	3.52	9.48	3.56	10.03	3.56	10.15	3.55
2.0 + 3.5 + 3.5 + 5.0	22	10.48	1.43	9.53	1.49	9.21	1.51	8.57	1.55	10.73	1.82	12.16	1.99
	25	10.57	1.98	10.01	2.01	9.83	2.02	9.45	2.04	11.04	2.21	12.09	2.32
	29	10.74	2.57	10.51	2.57	10.44	2.57	10.28	2.57	11.26	2.64	11.92	2.69
	32	10.56	2.91	10.61	2.89	10.62	2.89	10.66	2.88	11.31	2.90	11.75	2.91
	35	10.44	3.15	10.62	3.13	10.68	3.12	10.80	3.11	11.24	3.09	11.53	3.08
	40	10.10	3.34	10.33	3.34	10.41	3.34	10.56	3.33	10.52	3.29	10.80	3.27
	43	9.79	3.33	9.96	3.35	10.02	3.35	10.13	3.37	10.51	3.34	10.48	3.32
	46	9.42	3.23	9.45	3.28	9.46	3.29	9.48	3.32	10.03	3.32	10.15	3.32



Combination (Capacity)	Outdoor Air Temp. °C DB	Indoor Air Temp. °C											
		27/16		27/17.5		27/18		27/19		27/22		27/24	
		Total Q	Input Power	Total Q	Input Power	Total Q	Input Power	Total Q	Input Power	Total Q	Input Power	Total Q	Input Power
2.0 + 3.5 + 3.5 + 6.0	22	10.68	1.49	9.70	1.56	9.38	1.58	8.73	1.63	10.93	1.90	12.39	2.09
	25	10.77	2.08	10.20	2.11	10.01	2.12	9.63	2.14	11.24	2.31	12.32	2.43
	29	10.94	2.69	10.71	2.69	10.63	2.69	10.47	2.69	11.47	2.77	12.14	2.82
	32	10.76	3.05	10.80	3.03	10.82	3.03	10.85	3.02	11.52	3.04	11.97	3.05
	35	10.63	3.30	10.82	3.28	10.88	3.27	11.00	3.26	11.45	3.24	11.75	3.23
	40	10.29	3.50	10.52	3.50	10.60	3.50	10.76	3.49	10.71	3.45	11.00	3.42
	43	9.97	3.49	10.14	3.51	10.20	3.52	10.31	3.53	10.70	3.50	10.67	3.48
	46	9.59	3.38	9.62	3.43	9.63	3.45	9.65	3.48	10.22	3.48	10.34	3.48
2.0 + 3.5 + 3.5 + 7.1	22	10.87	1.53	9.88	1.59	9.55	1.62	8.89	1.66	11.12	1.94	12.61	2.13
	25	10.96	2.12	10.38	2.15	10.19	2.16	9.80	2.18	11.45	2.36	12.54	2.48
	29	11.14	2.75	10.90	2.75	10.82	2.75	10.66	2.75	11.68	2.83	12.36	2.88
	32	10.95	3.11	11.00	3.10	11.02	3.09	11.05	3.08	11.73	3.10	12.18	3.12
	35	10.83	3.37	11.01	3.35	11.08	3.34	11.20	3.33	11.66	3.31	11.96	3.30
	40	10.48	3.58	10.71	3.57	10.79	3.57	10.95	3.57	10.91	3.53	11.20	3.50
	43	10.15	3.56	10.33	3.59	10.39	3.59	10.50	3.61	10.90	3.57	10.86	3.55
	46	9.77	3.46	9.80	3.51	9.81	3.52	9.83	3.56	10.41	3.56	10.53	3.55
2.0 + 3.5 + 4.2 + 4.2	22	10.48	1.53	9.53	1.59	9.21	1.62	8.57	1.66	10.73	1.94	12.16	2.13
	25	10.57	2.12	10.01	2.15	9.83	2.16	9.45	2.18	11.04	2.36	12.09	2.48
	29	10.74	2.75	10.51	2.75	10.44	2.75	10.28	2.75	11.26	2.83	11.92	2.88
	32	10.56	3.11	10.61	3.10	10.62	3.09	10.66	3.08	11.31	3.10	11.75	3.12
	35	10.44	3.37	10.62	3.35	10.68	3.34	10.80	3.33	11.24	3.31	11.53	3.30
	40	10.10	3.58	10.33	3.57	10.41	3.57	10.56	3.57	10.52	3.53	10.80	3.50
	43	9.79	3.56	9.96	3.59	10.02	3.59	10.13	3.61	10.51	3.57	10.48	3.55
	46	9.42	3.46	9.45	3.51	9.46	3.52	9.48	3.56	10.03	3.56	10.15	3.55
2.0 + 3.5 + 4.2 + 5.0	22	10.68	1.46	9.70	1.53	9.38	1.55	8.73	1.59	10.93	1.86	12.39	2.04
	25	10.77	2.03	10.20	2.06	10.01	2.07	9.63	2.09	11.24	2.26	12.32	2.38
	29	10.94	2.64	10.71	2.64	10.63	2.64	10.47	2.64	11.47	2.71	12.14	2.76
	32	10.76	2.98	10.80	2.97	10.82	2.96	10.85	2.95	11.52	2.97	11.97	2.99
	35	10.63	3.23	10.82	3.21	10.88	3.20	11.00	3.19	11.45	3.17	11.75	3.16
	40	10.29	3.43	10.52	3.42	10.60	3.42	10.76	3.42	10.71	3.38	11.00	3.35
	43	9.97	3.41	10.14	3.43	10.20	3.44	10.31	3.45	10.70	3.42	10.67	3.40
	46	9.59	3.31	9.62	3.36	9.63	3.38	9.65	3.41	10.22	3.41	10.34	3.40
2.0 + 3.5 + 4.2 + 6.0	22	10.68	1.46	9.70	1.53	9.38	1.55	8.73	1.59	10.93	1.86	12.39	2.04
	25	10.77	2.03	10.20	2.06	10.01	2.07	9.63	2.09	11.24	2.26	12.32	2.38
	29	10.94	2.64	10.71	2.64	10.63	2.64	10.47	2.64	11.47	2.71	12.14	2.76
	32	10.76	2.98	10.80	2.97	10.82	2.96	10.85	2.95	11.52	2.97	11.97	2.99
	35	10.63	3.23	10.82	3.21	10.88	3.20	11.00	3.19	11.45	3.17	11.75	3.16
	40	10.29	3.43	10.52	3.42	10.60	3.42	10.76	3.42	10.71	3.38	11.00	3.35
	43	9.97	3.41	10.14	3.43	10.20	3.44	10.31	3.45	10.70	3.42	10.67	3.40
	46	9.59	3.31	9.62	3.36	9.63	3.38	9.65	3.41	10.22	3.41	10.34	3.40

Combination (Capacity)	Outdoor Air Temp. °C DB	Indoor Air Temp. °C											
		27/16		27/17.5		27/18		27/19		27/22		27/24	
		Total Q	Input Power	Total Q	Input Power	Total Q	Input Power	Total Q	Input Power	Total Q	Input Power	Total Q	Input Power
2.0 + 3.5 + 4.2 + 7.1	22	10.87	1.53	9.88	1.60	9.55	1.62	8.89	1.67	11.12	1.95	12.61	2.14
	25	10.96	2.13	10.38	2.16	10.19	2.17	9.80	2.19	11.45	2.37	12.54	2.49
	29	11.14	2.76	10.90	2.76	10.82	2.76	10.66	2.76	11.68	2.84	12.36	2.89
	32	10.95	3.12	11.00	3.10	11.02	3.10	11.05	3.09	11.73	3.11	12.18	3.13
	35	10.83	3.38	11.01	3.36	11.08	3.35	11.20	3.34	11.66	3.32	11.96	3.31
	40	10.48	3.59	10.71	3.59	10.79	3.58	10.95	3.58	10.91	3.54	11.20	3.51
	43	10.15	3.58	10.33	3.60	10.39	3.60	10.50	3.62	10.90	3.59	10.86	3.56
	46	9.77	3.47	9.80	3.52	9.81	3.54	9.83	3.57	10.41	3.57	10.53	3.56
2.0 + 3.5 + 5.0 + 5.0	22	10.68	1.40	9.70	1.46	9.38	1.48	8.73	1.52	10.93	1.78	12.39	1.95
	25	10.77	1.94	10.20	1.97	10.01	1.98	9.63	2.00	11.24	2.16	12.32	2.27
	29	10.94	2.52	10.71	2.52	10.63	2.52	10.47	2.52	11.47	2.59	12.14	2.63
	32	10.76	2.85	10.80	2.84	10.82	2.83	10.85	2.82	11.52	2.84	11.97	2.85
	35	10.63	3.09	10.82	3.07	10.88	3.06	11.00	3.05	11.45	3.03	11.75	3.02
	40	10.29	3.28	10.52	3.27	10.60	3.27	10.76	3.27	10.71	3.23	11.00	3.20
	43	9.97	3.26	10.14	3.28	10.20	3.29	10.31	3.30	10.70	3.27	10.67	3.26
	46	9.59	3.16	9.62	3.21	9.63	3.23	9.65	3.26	10.22	3.26	10.34	3.26
2.0 + 3.5 + 5.0 + 6.0	22	10.87	1.47	9.88	1.53	9.55	1.55	8.89	1.60	11.12	1.87	12.61	2.05
	25	10.96	2.04	10.38	2.07	10.19	2.08	9.80	2.10	11.45	2.27	12.54	2.38
	29	11.14	2.64	10.90	2.64	10.82	2.64	10.66	2.64	11.68	2.72	12.36	2.76
	32	10.95	2.99	11.00	2.97	11.02	2.97	11.05	2.96	11.73	2.98	12.18	2.99
	35	10.83	3.24	11.01	3.22	11.08	3.21	11.20	3.20	11.66	3.18	11.96	3.17
	40	10.48	3.44	10.71	3.44	10.79	3.43	10.95	3.43	10.91	3.39	11.20	3.36
	43	10.15	3.43	10.33	3.45	10.39	3.45	10.50	3.47	10.90	3.44	10.86	3.42
	46	9.77	3.32	9.80	3.37	9.81	3.39	9.83	3.42	10.41	3.42	10.53	3.42
2.0 + 3.5 + 5.0 + 7.1	22	10.87	1.47	9.88	1.53	9.55	1.55	8.89	1.60	11.12	1.87	12.61	2.05
	25	10.96	2.04	10.38	2.07	10.19	2.08	9.80	2.10	11.45	2.27	12.54	2.38
	29	11.14	2.64	10.90	2.64	10.82	2.64	10.66	2.64	11.68	2.72	12.36	2.76
	32	10.95	2.99	11.00	2.97	11.02	2.97	11.05	2.96	11.73	2.98	12.18	2.99
	35	10.83	3.24	11.01	3.22	11.08	3.21	11.20	3.20	11.66	3.18	11.96	3.17
	40	10.48	3.44	10.71	3.44	10.79	3.43	10.95	3.43	10.91	3.39	11.20	3.36
	43	10.15	3.43	10.33	3.45	10.39	3.45	10.50	3.47	10.90	3.44	10.86	3.42
	46	9.77	3.32	9.80	3.37	9.81	3.39	9.83	3.42	10.41	3.42	10.53	3.42
2.0 + 3.5 + 6.0 + 6.0	22	10.87	1.47	9.88	1.53	9.55	1.55	8.89	1.60	11.12	1.87	12.61	2.05
	25	10.96	2.04	10.38	2.07	10.19	2.08	9.80	2.10	11.45	2.27	12.54	2.38
	29	11.14	2.64	10.90	2.64	10.82	2.64	10.66	2.64	11.68	2.72	12.36	2.76
	32	10.95	2.99	11.00	2.97	11.02	2.97	11.05	2.96	11.73	2.98	12.18	2.99
	35	10.83	3.24	11.01	3.22	11.08	3.21	11.20	3.20	11.66	3.18	11.96	3.17
	40	10.48	3.44	10.71	3.44	10.79	3.43	10.95	3.43	10.91	3.39	11.20	3.36
	43	10.15	3.43	10.33	3.45	10.39	3.45	10.50	3.47	10.90	3.44	10.86	3.42
	46	9.77	3.32	9.80	3.37	9.81	3.39	9.83	3.42	10.41	3.42	10.53	3.42

Combination (Capacity)	Outdoor Air Temp. °C DB	Indoor Air Temp. °C											
		27/16		27/17.5		27/18		27/19		27/22		27/24	
		Total Q	Input Power	Total Q	Input Power	Total Q	Input Power	Total Q	Input Power	Total Q	Input Power	Total Q	Input Power
2.0 + 4.2 + 4.2 + 4.2	22	10.68	1.56	9.70	1.63	9.38	1.65	8.73	1.70	10.93	1.98	12.39	2.18
	25	10.77	2.17	10.20	2.20	10.01	2.21	9.63	2.23	11.24	2.41	12.32	2.53
	29	10.94	2.81	10.71	2.81	10.63	2.81	10.47	2.81	11.47	2.89	12.14	2.94
	32	10.76	3.18	10.80	3.16	10.82	3.16	10.85	3.14	11.52	3.17	11.97	3.18
	35	10.63	3.44	10.82	3.42	10.88	3.41	11.00	3.40	11.45	3.38	11.75	3.37
	40	10.29	3.66	10.52	3.65	10.60	3.65	10.76	3.64	10.71	3.60	11.00	3.57
	43	9.97	3.64	10.14	3.66	10.20	3.67	10.31	3.68	10.70	3.65	10.67	3.63
	46	9.59	3.53	9.62	3.58	9.63	3.60	9.65	3.63	10.22	3.63	10.34	3.63
2.0 + 4.2 + 4.2 + 5.0	22	10.68	1.46	9.70	1.53	9.38	1.55	8.73	1.59	10.93	1.86	12.39	2.04
	25	10.77	2.03	10.20	2.06	10.01	2.07	9.63	2.09	11.24	2.26	12.32	2.38
	29	10.94	2.64	10.71	2.64	10.63	2.64	10.47	2.64	11.47	2.71	12.14	2.76
	32	10.76	2.98	10.80	2.97	10.82	2.96	10.85	2.95	11.52	2.97	11.97	2.99
	35	10.63	3.23	10.82	3.21	10.88	3.20	11.00	3.19	11.45	3.17	11.75	3.16
	40	10.29	3.43	10.52	3.42	10.60	3.42	10.76	3.42	10.71	3.38	11.00	3.35
	43	9.97	3.41	10.14	3.43	10.20	3.44	10.31	3.45	10.70	3.42	10.67	3.40
	46	9.59	3.31	9.62	3.36	9.63	3.38	9.65	3.41	10.22	3.41	10.34	3.40
2.0 + 4.2 + 4.2 + 6.0	22	10.87	1.53	9.88	1.59	9.55	1.62	8.89	1.66	11.12	1.94	12.61	2.13
	25	10.96	2.12	10.38	2.15	10.19	2.16	9.80	2.18	11.45	2.36	12.54	2.48
	29	11.14	2.75	10.90	2.75	10.82	2.75	10.66	2.75	11.68	2.83	12.36	2.88
	32	10.95	3.11	11.00	3.10	11.02	3.09	11.05	3.08	11.73	3.10	12.18	3.12
	35	10.83	3.37	11.01	3.35	11.08	3.34	11.20	3.33	11.66	3.31	11.96	3.30
	40	10.48	3.58	10.71	3.57	10.79	3.57	10.95	3.57	10.91	3.53	11.20	3.50
	43	10.15	3.56	10.33	3.59	10.39	3.59	10.50	3.61	10.90	3.57	10.86	3.55
	46	9.77	3.46	9.80	3.51	9.81	3.52	9.83	3.56	10.41	3.56	10.53	3.55
2.0 + 4.2 + 4.2 + 7.1	22	10.87	1.49	9.88	1.56	9.55	1.58	8.89	1.63	11.12	1.90	12.61	2.09
	25	10.96	2.08	10.38	2.11	10.19	2.12	9.80	2.14	11.45	2.31	12.54	2.43
	29	11.14	2.69	10.90	2.69	10.82	2.69	10.66	2.69	11.68	2.77	12.36	2.82
	32	10.95	3.05	11.00	3.03	11.02	3.03	11.05	3.02	11.73	3.04	12.18	3.05
	35	10.83	3.30	11.01	3.28	11.08	3.27	11.20	3.26	11.66	3.24	11.96	3.23
	40	10.48	3.50	10.71	3.50	10.79	3.50	10.95	3.49	10.91	3.45	11.20	3.42
	43	10.15	3.49	10.33	3.51	10.39	3.52	10.50	3.53	10.90	3.50	10.86	3.48
	46	9.77	3.38	9.80	3.43	9.81	3.45	9.83	3.48	10.41	3.48	10.53	3.48
2.0 + 4.2 + 5.0 + 5.0	22	10.87	1.47	9.88	1.53	9.55	1.55	8.89	1.60	11.12	1.87	12.61	2.05
	25	10.96	2.04	10.38	2.07	10.19	2.08	9.80	2.10	11.45	2.27	12.54	2.38
	29	11.14	2.64	10.90	2.64	10.82	2.64	10.66	2.64	11.68	2.72	12.36	2.76
	32	10.95	2.99	11.00	2.97	11.02	2.97	11.05	2.96	11.73	2.98	12.18	2.99
	35	10.83	3.24	11.01	3.22	11.08	3.21	11.20	3.20	11.66	3.18	11.96	3.17
	40	10.48	3.44	10.71	3.44	10.79	3.43	10.95	3.43	10.91	3.39	11.20	3.36
	43	10.15	3.43	10.33	3.45	10.39	3.45	10.50	3.47	10.90	3.44	10.86	3.42
	46	9.77	3.32	9.80	3.37	9.81	3.39	9.83	3.42	10.41	3.42	10.53	3.42

Combination (Capacity)	Outdoor Air Temp. °C DB	Indoor Air Temp. °C											
		27/16		27/17.5		27/18		27/19		27/22		27/24	
		Total Q	Input Power	Total Q	Input Power	Total Q	Input Power	Total Q	Input Power	Total Q	Input Power	Total Q	Input Power
2.0 + 4.2 + 5.0 + 6.0	22	10.87	1.47	9.88	1.53	9.55	1.55	8.89	1.60	11.12	1.87	12.61	2.05
	25	10.96	2.04	10.38	2.07	10.19	2.08	9.80	2.10	11.45	2.27	12.54	2.38
	29	11.14	2.64	10.90	2.64	10.82	2.64	10.66	2.64	11.68	2.72	12.36	2.76
	32	10.95	2.99	11.00	2.97	11.02	2.97	11.05	2.96	11.73	2.98	12.18	2.99
	35	10.83	3.24	11.01	3.22	11.08	3.21	11.20	3.20	11.66	3.18	11.96	3.17
	40	10.48	3.44	10.71	3.44	10.79	3.43	10.95	3.43	10.91	3.39	11.20	3.36
	43	10.15	3.43	10.33	3.45	10.39	3.45	10.50	3.47	10.90	3.44	10.86	3.42
	46	9.77	3.32	9.80	3.37	9.81	3.39	9.83	3.42	10.41	3.42	10.53	3.42
2.0 + 4.2 + 5.0 + 7.1	22	10.87	1.44	9.88	1.50	9.55	1.52	8.89	1.56	11.12	1.83	12.61	2.00
	25	10.96	1.99	10.38	2.02	10.19	2.03	9.80	2.05	11.45	2.22	12.54	2.33
	29	11.14	2.59	10.90	2.59	10.82	2.59	10.66	2.59	11.68	2.66	12.36	2.70
	32	10.95	2.92	11.00	2.91	11.02	2.90	11.05	2.89	11.73	2.92	12.18	2.93
	35	10.83	3.17	11.01	3.15	11.08	3.14	11.20	3.13	11.66	3.11	11.96	3.10
	40	10.48	3.37	10.71	3.36	10.79	3.36	10.95	3.36	10.91	3.31	11.20	3.29
	43	10.15	3.35	10.33	3.37	10.39	3.38	10.50	3.39	10.90	3.36	10.86	3.34
	46	9.77	3.25	9.80	3.30	9.81	3.31	9.83	3.35	10.41	3.34	10.53	3.34
2.0 + 4.2 + 6.0 + 6.0	22	10.87	1.47	9.88	1.53	9.55	1.55	8.89	1.60	11.12	1.87	12.61	2.05
	25	10.96	2.04	10.38	2.07	10.19	2.08	9.80	2.10	11.45	2.27	12.54	2.38
	29	11.14	2.64	10.90	2.64	10.82	2.64	10.66	2.64	11.68	2.72	12.36	2.76
	32	10.95	2.99	11.00	2.97	11.02	2.97	11.05	2.96	11.73	2.98	12.18	2.99
	35	10.83	3.24	11.01	3.22	11.08	3.21	11.20	3.20	11.66	3.18	11.96	3.17
	40	10.48	3.44	10.71	3.44	10.79	3.43	10.95	3.43	10.91	3.39	11.20	3.36
	43	10.15	3.43	10.33	3.45	10.39	3.45	10.50	3.47	10.90	3.44	10.86	3.42
	46	9.77	3.32	9.80	3.37	9.81	3.39	9.83	3.42	10.41	3.42	10.53	3.42
2.0 + 5.0 + 5.0 + 5.0	22	10.87	1.44	9.88	1.50	9.55	1.52	8.89	1.57	11.12	1.83	12.61	2.01
	25	10.96	2.00	10.38	2.03	10.19	2.04	9.80	2.06	11.45	2.23	12.54	2.34
	29	11.14	2.59	10.90	2.59	10.82	2.59	10.66	2.59	11.68	2.67	12.36	2.71
	32	10.95	2.93	11.00	2.92	11.02	2.91	11.05	2.90	11.73	2.92	12.18	2.94
	35	10.83	3.18	11.01	3.16	11.08	3.15	11.20	3.14	11.66	3.12	11.96	3.11
	40	10.48	3.38	10.71	3.37	10.79	3.37	10.95	3.37	10.91	3.32	11.20	3.30
	43	10.15	3.36	10.33	3.38	10.39	3.39	10.50	3.40	10.90	3.37	10.86	3.35
	46	9.77	3.26	9.80	3.31	9.81	3.32	9.83	3.36	10.41	3.35	10.53	3.35
2.0 + 5.0 + 5.0 + 6.0	22	10.87	1.44	9.88	1.50	9.55	1.52	8.89	1.57	11.12	1.83	12.61	2.01
	25	10.96	2.00	10.38	2.03	10.19	2.04	9.80	2.06	11.45	2.23	12.54	2.34
	29	11.14	2.59	10.90	2.59	10.82	2.59	10.66	2.59	11.68	2.67	12.36	2.71
	32	10.95	2.93	11.00	2.92	11.02	2.91	11.05	2.90	11.73	2.92	12.18	2.94
	35	10.83	3.18	11.01	3.16	11.08	3.15	11.20	3.14	11.66	3.12	11.96	3.11
	40	10.48	3.38	10.71	3.37	10.79	3.37	10.95	3.37	10.91	3.32	11.20	3.30
	43	10.15	3.36	10.33	3.38	10.39	3.39	10.50	3.40	10.90	3.37	10.86	3.35
	46	9.77	3.26	9.80	3.31	9.81	3.32	9.83	3.36	10.41	3.35	10.53	3.35

Combination (Capacity)	Outdoor Air Temp. °C DB	Indoor Air Temp. °C											
		27/16		27/17.5		27/18		27/19		27/22		27/24	
		Total Q	Input Power	Total Q	Input Power	Total Q	Input Power	Total Q	Input Power	Total Q	Input Power	Total Q	Input Power
2.5 + 2.5 + 2.5 + 2.5	22	10.29	1.56	9.35	1.63	9.04	1.65	8.41	1.70	10.53	1.98	11.94	2.18
	25	10.38	2.17	9.83	2.20	9.64	2.21	9.28	2.23	10.83	2.41	11.87	2.53
	29	10.54	2.81	10.32	2.81	10.24	2.81	10.09	2.81	11.06	2.89	11.70	2.94
	32	10.36	3.18	10.41	3.16	10.43	3.16	10.46	3.14	11.10	3.17	11.53	3.18
	35	10.25	3.44	10.42	3.42	10.48	3.41	10.60	3.40	11.03	3.38	11.32	3.37
	40	9.92	3.66	10.14	3.65	10.21	3.65	10.36	3.64	10.32	3.60	10.60	3.57
	43	9.61	3.64	9.77	3.66	9.83	3.67	9.94	3.68	10.31	3.65	10.28	3.63
	46	9.24	3.53	9.27	3.58	9.28	3.60	9.30	3.63	9.85	3.63	9.96	3.63
2.5 + 2.5 + 2.5 + 3.5	22	10.29	1.53	9.35	1.59	9.04	1.62	8.41	1.66	10.53	1.94	11.94	2.13
	25	10.38	2.12	9.83	2.15	9.64	2.16	9.28	2.18	10.83	2.36	11.87	2.48
	29	10.54	2.75	10.32	2.75	10.24	2.75	10.09	2.75	11.06	2.83	11.70	2.88
	32	10.36	3.11	10.41	3.10	10.43	3.09	10.46	3.08	11.10	3.10	11.53	3.12
	35	10.25	3.37	10.42	3.35	10.48	3.34	10.60	3.33	11.03	3.31	11.32	3.30
	40	9.92	3.58	10.14	3.57	10.21	3.57	10.36	3.57	10.32	3.53	10.60	3.50
	43	9.61	3.56	9.77	3.59	9.83	3.59	9.94	3.61	10.31	3.57	10.28	3.55
	46	9.24	3.46	9.27	3.51	9.28	3.52	9.30	3.56	9.85	3.56	9.96	3.55
2.5 + 2.5 + 2.5 + 4.2	22	10.29	1.53	9.35	1.59	9.04	1.62	8.41	1.66	10.53	1.94	11.94	2.13
	25	10.38	2.12	9.83	2.15	9.64	2.16	9.28	2.18	10.83	2.36	11.87	2.48
	29	10.54	2.75	10.32	2.75	10.24	2.75	10.09	2.75	11.06	2.83	11.70	2.88
	32	10.36	3.11	10.41	3.10	10.43	3.09	10.46	3.08	11.10	3.10	11.53	3.12
	35	10.25	3.37	10.42	3.35	10.48	3.34	10.60	3.33	11.03	3.31	11.32	3.30
	40	9.92	3.58	10.14	3.57	10.21	3.57	10.36	3.57	10.32	3.53	10.60	3.50
	43	9.61	3.56	9.77	3.59	9.83	3.59	9.94	3.61	10.31	3.57	10.28	3.55
	46	9.24	3.46	9.27	3.51	9.28	3.52	9.30	3.56	9.85	3.56	9.96	3.55
2.5 + 2.5 + 2.5 + 5.0	22	10.48	1.46	9.53	1.52	9.21	1.54	8.57	1.59	10.73	1.86	12.16	2.04
	25	10.57	2.03	10.01	2.06	9.83	2.07	9.45	2.09	11.04	2.26	12.09	2.37
	29	10.74	2.63	10.51	2.63	10.44	2.63	10.28	2.63	11.26	2.70	11.92	2.75
	32	10.56	2.97	10.61	2.96	10.62	2.95	10.66	2.94	11.31	2.96	11.75	2.98
	35	10.44	3.22	10.62	3.20	10.68	3.19	10.80	3.18	11.24	3.16	11.53	3.15
	40	10.10	3.42	10.33	3.41	10.41	3.41	10.56	3.41	10.52	3.37	10.80	3.34
	43	9.79	3.40	9.96	3.42	10.02	3.43	10.13	3.44	10.51	3.41	10.48	3.39
	46	9.42	3.30	9.45	3.35	9.46	3.37	9.48	3.40	10.03	3.40	10.15	3.39
2.5 + 2.5 + 2.5 + 6.0	22	10.48	1.46	9.53	1.52	9.21	1.54	8.57	1.59	10.73	1.86	12.16	2.04
	25	10.57	2.03	10.01	2.06	9.83	2.07	9.45	2.09	11.04	2.26	12.09	2.37
	29	10.74	2.63	10.51	2.63	10.44	2.63	10.28	2.63	11.26	2.70	11.92	2.75
	32	10.56	2.97	10.61	2.96	10.62	2.95	10.66	2.94	11.31	2.96	11.75	2.98
	35	10.44	3.22	10.62	3.20	10.68	3.19	10.80	3.18	11.24	3.16	11.53	3.15
	40	10.10	3.42	10.33	3.41	10.41	3.41	10.56	3.41	10.52	3.37	10.80	3.34
	43	9.79	3.40	9.96	3.42	10.02	3.43	10.13	3.44	10.51	3.41	10.48	3.39
	46	9.42	3.30	9.45	3.35	9.46	3.37	9.48	3.40	10.03	3.40	10.15	3.39

Combination (Capacity)	Outdoor Air Temp. °C DB	Indoor Air Temp. °C											
		27/16		27/17.5		27/18		27/19		27/22		27/24	
		Total Q	Input Power	Total Q	Input Power	Total Q	Input Power	Total Q	Input Power	Total Q	Input Power	Total Q	Input Power
2.5 + 2.5 + 2.5 + 7.1	22	10.68	1.49	9.70	1.56	9.38	1.58	8.73	1.63	10.93	1.90	12.39	2.09
	25	10.77	2.08	10.20	2.11	10.01	2.12	9.63	2.14	11.24	2.31	12.32	2.43
	29	10.94	2.69	10.71	2.69	10.63	2.69	10.47	2.69	11.47	2.77	12.14	2.82
	32	10.76	3.05	10.80	3.03	10.82	3.03	10.85	3.02	11.52	3.04	11.97	3.05
	35	10.63	3.30	10.82	3.28	10.88	3.27	11.00	3.26	11.45	3.24	11.75	3.23
	40	10.29	3.50	10.52	3.50	10.60	3.50	10.76	3.49	10.71	3.45	11.00	3.42
	43	9.97	3.49	10.14	3.51	10.20	3.52	10.31	3.53	10.70	3.50	10.67	3.48
	46	9.59	3.38	9.62	3.43	9.63	3.45	9.65	3.48	10.22	3.48	10.34	3.48
2.5 + 2.5 + 3.5 + 3.5	22	10.29	1.49	9.35	1.56	9.04	1.58	8.41	1.62	10.53	1.90	11.94	2.08
	25	10.38	2.07	9.83	2.10	9.64	2.11	9.28	2.13	10.83	2.31	11.87	2.42
	29	10.54	2.69	10.32	2.69	10.24	2.69	10.09	2.69	11.06	2.76	11.70	2.81
	32	10.36	3.04	10.41	3.02	10.43	3.02	10.46	3.01	11.10	3.03	11.53	3.04
	35	10.25	3.29	10.42	3.27	10.48	3.26	10.60	3.25	11.03	3.23	11.32	3.22
	40	9.92	3.49	10.14	3.49	10.21	3.49	10.36	3.48	10.32	3.44	10.60	3.41
	43	9.61	3.48	9.77	3.50	9.83	3.51	9.94	3.52	10.31	3.49	10.28	3.47
	46	9.24	3.37	9.27	3.42	9.28	3.44	9.30	3.47	9.85	3.47	9.96	3.47
2.5 + 2.5 + 3.5 + 4.2	22	10.48	1.56	9.53	1.63	9.21	1.65	8.57	1.70	10.73	1.98	12.16	2.18
	25	10.57	2.17	10.01	2.20	9.83	2.21	9.45	2.23	11.04	2.41	12.09	2.53
	29	10.74	2.81	10.51	2.81	10.44	2.81	10.28	2.81	11.26	2.89	11.92	2.94
	32	10.56	3.18	10.61	3.16	10.62	3.16	10.66	3.14	11.31	3.17	11.75	3.18
	35	10.44	3.44	10.62	3.42	10.68	3.41	10.80	3.40	11.24	3.38	11.53	3.37
	40	10.10	3.66	10.33	3.65	10.41	3.65	10.56	3.64	10.52	3.60	10.80	3.57
	43	9.79	3.64	9.96	3.66	10.02	3.67	10.13	3.68	10.51	3.65	10.48	3.63
	46	9.42	3.53	9.45	3.58	9.46	3.60	9.48	3.63	10.03	3.63	10.15	3.63
2.5 + 2.5 + 3.5 + 5.0	22	10.48	1.43	9.53	1.49	9.21	1.51	8.57	1.55	10.73	1.82	12.16	1.99
	25	10.57	1.98	10.01	2.01	9.83	2.02	9.45	2.04	11.04	2.21	12.09	2.32
	29	10.74	2.57	10.51	2.57	10.44	2.57	10.28	2.57	11.26	2.64	11.92	2.69
	32	10.56	2.91	10.61	2.89	10.62	2.89	10.66	2.88	11.31	2.90	11.75	2.91
	35	10.44	3.15	10.62	3.13	10.68	3.12	10.80	3.11	11.24	3.09	11.53	3.08
	40	10.10	3.34	10.33	3.34	10.41	3.34	10.56	3.33	10.52	3.29	10.80	3.27
	43	9.79	3.33	9.96	3.35	10.02	3.35	10.13	3.37	10.51	3.34	10.48	3.32
	46	9.42	3.23	9.45	3.28	9.46	3.29	9.48	3.32	10.03	3.32	10.15	3.32
2.5 + 2.5 + 3.5 + 6.0	22	10.68	1.49	9.70	1.56	9.38	1.58	8.73	1.63	10.93	1.90	12.39	2.09
	25	10.77	2.08	10.20	2.11	10.01	2.12	9.63	2.14	11.24	2.31	12.32	2.43
	29	10.94	2.69	10.71	2.69	10.63	2.69	10.47	2.69	11.47	2.77	12.14	2.82
	32	10.76	3.05	10.80	3.03	10.82	3.03	10.85	3.02	11.52	3.04	11.97	3.05
	35	10.63	3.30	10.82	3.28	10.88	3.27	11.00	3.26	11.45	3.24	11.75	3.23
	40	10.29	3.50	10.52	3.50	10.60	3.50	10.76	3.49	10.71	3.45	11.00	3.42
	43	9.97	3.49	10.14	3.51	10.20	3.52	10.31	3.53	10.70	3.50	10.67	3.48
	46	9.59	3.38	9.62	3.43	9.63	3.45	9.65	3.48	10.22	3.48	10.34	3.48

Combination (Capacity)	Outdoor Air Temp. °C DB	Indoor Air Temp. °C											
		27/16		27/17.5		27/18		27/19		27/22		27/24	
		Total Q	Input Power	Total Q	Input Power	Total Q	Input Power	Total Q	Input Power	Total Q	Input Power	Total Q	Input Power
2.5 + 2.5 + 3.5 + 7.1	22	10.68	1.46	9.70	1.53	9.38	1.55	8.73	1.59	10.93	1.86	12.39	2.04
	25	10.77	2.03	10.20	2.06	10.01	2.07	9.63	2.09	11.24	2.26	12.32	2.38
	29	10.94	2.64	10.71	2.64	10.63	2.64	10.47	2.64	11.47	2.71	12.14	2.76
	32	10.76	2.98	10.80	2.97	10.82	2.96	10.85	2.95	11.52	2.97	11.97	2.99
	35	10.63	3.23	10.82	3.21	10.88	3.20	11.00	3.19	11.45	3.17	11.75	3.16
	40	10.29	3.43	10.52	3.42	10.60	3.42	10.76	3.42	10.71	3.38	11.00	3.35
	43	9.97	3.41	10.14	3.43	10.20	3.44	10.31	3.45	10.70	3.42	10.67	3.40
	46	9.59	3.31	9.62	3.36	9.63	3.38	9.65	3.41	10.22	3.41	10.34	3.40
2.5 + 2.5 + 4.2 + 4.2	22	10.48	1.56	9.53	1.63	9.21	1.65	8.57	1.70	10.73	1.98	12.16	2.18
	25	10.57	2.17	10.01	2.20	9.83	2.21	9.45	2.23	11.04	2.41	12.09	2.53
	29	10.74	2.81	10.51	2.81	10.44	2.81	10.28	2.81	11.26	2.89	11.92	2.94
	32	10.56	3.18	10.61	3.16	10.62	3.16	10.66	3.14	11.31	3.17	11.75	3.18
	35	10.44	3.44	10.62	3.42	10.68	3.41	10.80	3.40	11.24	3.38	11.53	3.37
	40	10.10	3.66	10.33	3.65	10.41	3.65	10.56	3.64	10.52	3.60	10.80	3.57
	43	9.79	3.64	9.96	3.66	10.02	3.67	10.13	3.68	10.51	3.65	10.48	3.63
	46	9.42	3.53	9.45	3.58	9.46	3.60	9.48	3.63	10.03	3.63	10.15	3.63
2.5 + 2.5 + 4.2 + 5.0	22	10.68	1.49	9.70	1.56	9.38	1.58	8.73	1.63	10.93	1.90	12.39	2.09
	25	10.77	2.08	10.20	2.11	10.01	2.12	9.63	2.14	11.24	2.31	12.32	2.43
	29	10.94	2.69	10.71	2.69	10.63	2.69	10.47	2.69	11.47	2.77	12.14	2.82
	32	10.76	3.05	10.80	3.03	10.82	3.03	10.85	3.02	11.52	3.04	11.97	3.05
	35	10.63	3.30	10.82	3.28	10.88	3.27	11.00	3.26	11.45	3.24	11.75	3.23
	40	10.29	3.50	10.52	3.50	10.60	3.50	10.76	3.49	10.71	3.45	11.00	3.42
	43	9.97	3.49	10.14	3.51	10.20	3.52	10.31	3.53	10.70	3.50	10.67	3.48
	46	9.59	3.38	9.62	3.43	9.63	3.45	9.65	3.48	10.22	3.48	10.34	3.48
2.5 + 2.5 + 4.2 + 6.0	22	10.68	1.49	9.70	1.56	9.38	1.58	8.73	1.63	10.93	1.90	12.39	2.09
	25	10.77	2.08	10.20	2.11	10.01	2.12	9.63	2.14	11.24	2.31	12.32	2.43
	29	10.94	2.69	10.71	2.69	10.63	2.69	10.47	2.69	11.47	2.77	12.14	2.82
	32	10.76	3.05	10.80	3.03	10.82	3.03	10.85	3.02	11.52	3.04	11.97	3.05
	35	10.63	3.30	10.82	3.28	10.88	3.27	11.00	3.26	11.45	3.24	11.75	3.23
	40	10.29	3.50	10.52	3.50	10.60	3.50	10.76	3.49	10.71	3.45	11.00	3.42
	43	9.97	3.49	10.14	3.51	10.20	3.52	10.31	3.53	10.70	3.50	10.67	3.48
	46	9.59	3.38	9.62	3.43	9.63	3.45	9.65	3.48	10.22	3.48	10.34	3.48
2.5 + 2.5 + 4.2 + 7.1	22	10.87	1.53	9.88	1.59	9.55	1.62	8.89	1.66	11.12	1.94	12.61	2.13
	25	10.96	2.12	10.38	2.15	10.19	2.16	9.80	2.18	11.45	2.36	12.54	2.48
	29	11.14	2.75	10.90	2.75	10.82	2.75	10.66	2.75	11.68	2.83	12.36	2.88
	32	10.95	3.11	11.00	3.10	11.02	3.09	11.05	3.08	11.73	3.10	12.18	3.12
	35	10.83	3.37	11.01	3.35	11.08	3.34	11.20	3.33	11.66	3.31	11.96	3.30
	40	10.48	3.58	10.71	3.57	10.79	3.57	10.95	3.57	10.91	3.53	11.20	3.50
	43	10.15	3.56	10.33	3.59	10.39	3.59	10.50	3.61	10.90	3.57	10.86	3.55
	46	9.77	3.46	9.80	3.51	9.81	3.52	9.83	3.56	10.41	3.56	10.53	3.55

Combination (Capacity)	Outdoor Air Temp. °C DB	Indoor Air Temp. °C											
		27/16		27/17.5		27/18		27/19		27/22		27/24	
		Total Q	Input Power	Total Q	Input Power	Total Q	Input Power	Total Q	Input Power	Total Q	Input Power	Total Q	Input Power
2.5 + 2.5 + 5.0 + 5.0	22	10.68	1.43	9.70	1.49	9.38	1.52	8.73	1.56	10.93	1.82	12.39	2.00
	25	10.77	1.99	10.20	2.02	10.01	2.03	9.63	2.05	11.24	2.21	12.32	2.32
	29	10.94	2.58	10.71	2.58	10.63	2.58	10.47	2.58	11.47	2.65	12.14	2.70
	32	10.76	2.91	10.80	2.90	10.82	2.90	10.85	2.89	11.52	2.91	11.97	2.92
	35	10.63	3.16	10.82	3.14	10.88	3.13	11.00	3.12	11.45	3.10	11.75	3.09
	40	10.29	3.35	10.52	3.35	10.60	3.35	10.76	3.34	10.71	3.30	11.00	3.28
	43	9.97	3.34	10.14	3.36	10.20	3.37	10.31	3.38	10.70	3.35	10.67	3.33
	46	9.59	3.24	9.62	3.29	9.63	3.30	9.65	3.33	10.22	3.33	10.34	3.33
2.5 + 2.5 + 5.0 + 6.0	22	10.87	1.46	9.88	1.53	9.55	1.55	8.89	1.59	11.12	1.86	12.61	2.04
	25	10.96	2.03	10.38	2.06	10.19	2.07	9.80	2.09	11.45	2.26	12.54	2.38
	29	11.14	2.64	10.90	2.64	10.82	2.64	10.66	2.64	11.68	2.71	12.36	2.76
	32	10.95	2.98	11.00	2.97	11.02	2.96	11.05	2.95	11.73	2.97	12.18	2.99
	35	10.83	3.23	11.01	3.21	11.08	3.20	11.20	3.19	11.66	3.17	11.96	3.16
	40	10.48	3.43	10.71	3.42	10.79	3.42	10.95	3.42	10.91	3.38	11.20	3.35
	43	10.15	3.41	10.33	3.43	10.39	3.44	10.50	3.45	10.90	3.42	10.86	3.40
	46	9.77	3.31	9.80	3.36	9.81	3.38	9.83	3.41	10.41	3.41	10.53	3.40
2.5 + 2.5 + 5.0 + 7.1	22	10.87	1.47	9.88	1.53	9.55	1.55	8.89	1.60	11.12	1.87	12.61	2.05
	25	10.96	2.04	10.38	2.07	10.19	2.08	9.80	2.10	11.45	2.27	12.54	2.38
	29	11.14	2.64	10.90	2.64	10.82	2.64	10.66	2.64	11.68	2.72	12.36	2.76
	32	10.95	2.99	11.00	2.97	11.02	2.97	11.05	2.96	11.73	2.98	12.18	2.99
	35	10.83	3.24	11.01	3.22	11.08	3.21	11.20	3.20	11.66	3.18	11.96	3.17
	40	10.48	3.44	10.71	3.44	10.79	3.43	10.95	3.43	10.91	3.39	11.20	3.36
	43	10.15	3.43	10.33	3.45	10.39	3.45	10.50	3.47	10.90	3.44	10.86	3.42
	46	9.77	3.32	9.80	3.37	9.81	3.39	9.83	3.42	10.41	3.42	10.53	3.42
2.5 + 2.5 + 6.0 + 6.0	22	10.87	1.46	9.88	1.53	9.55	1.55	8.89	1.59	11.12	1.86	12.61	2.04
	25	10.96	2.03	10.38	2.06	10.19	2.07	9.80	2.09	11.45	2.26	12.54	2.38
	29	11.14	2.64	10.90	2.64	10.82	2.64	10.66	2.64	11.68	2.71	12.36	2.76
	32	10.95	2.98	11.00	2.97	11.02	2.96	11.05	2.95	11.73	2.97	12.18	2.99
	35	10.83	3.23	11.01	3.21	11.08	3.20	11.20	3.19	11.66	3.17	11.96	3.16
	40	10.48	3.43	10.71	3.42	10.79	3.42	10.95	3.42	10.91	3.38	11.20	3.35
	43	10.15	3.41	10.33	3.43	10.39	3.44	10.50	3.45	10.90	3.42	10.86	3.40
	46	9.77	3.31	9.80	3.36	9.81	3.38	9.83	3.41	10.41	3.41	10.53	3.40
2.5 + 2.5 + 6.0 + 7.1	22	10.87	1.47	9.88	1.53	9.55	1.55	8.89	1.60	11.12	1.87	12.61	2.05
	25	10.96	2.04	10.38	2.07	10.19	2.08	9.80	2.10	11.45	2.27	12.54	2.38
	29	11.14	2.64	10.90	2.64	10.82	2.64	10.66	2.64	11.68	2.72	12.36	2.76
	32	10.95	2.99	11.00	2.97	11.02	2.97	11.05	2.96	11.73	2.98	12.18	2.99
	35	10.83	3.24	11.01	3.22	11.08	3.21	11.20	3.20	11.66	3.18	11.96	3.17
	40	10.48	3.44	10.71	3.44	10.79	3.43	10.95	3.43	10.91	3.39	11.20	3.36
	43	10.15	3.43	10.33	3.45	10.39	3.45	10.50	3.47	10.90	3.44	10.86	3.42
	46	9.77	3.32	9.80	3.37	9.81	3.39	9.83	3.42	10.41	3.42	10.53	3.42



Combination (Capacity)	Outdoor Air Temp. °C DB	Indoor Air Temp. °C											
		27/16		27/17.5		27/18		27/19		27/22		27/24	
		Total Q	Input Power	Total Q	Input Power	Total Q	Input Power	Total Q	Input Power	Total Q	Input Power	Total Q	Input Power
2.5 + 3.5 + 3.5 + 3.5	22	10.48	1.53	9.53	1.59	9.21	1.62	8.57	1.66	10.73	1.94	12.16	2.13
	25	10.57	2.12	10.01	2.15	9.83	2.16	9.45	2.18	11.04	2.36	12.09	2.48
	29	10.74	2.75	10.51	2.75	10.44	2.75	10.28	2.75	11.26	2.83	11.92	2.88
	32	10.56	3.11	10.61	3.10	10.62	3.09	10.66	3.08	11.31	3.10	11.75	3.12
	35	10.44	3.37	10.62	3.35	10.68	3.34	10.80	3.33	11.24	3.31	11.53	3.30
	40	10.10	3.58	10.33	3.57	10.41	3.57	10.56	3.57	10.52	3.53	10.80	3.50
	43	9.79	3.56	9.96	3.59	10.02	3.59	10.13	3.61	10.51	3.57	10.48	3.55
	46	9.42	3.46	9.45	3.51	9.46	3.52	9.48	3.56	10.03	3.56	10.15	3.55
2.5 + 3.5 + 3.5 + 4.2	22	10.48	1.53	9.53	1.59	9.21	1.62	8.57	1.66	10.73	1.94	12.16	2.13
	25	10.57	2.12	10.01	2.15	9.83	2.16	9.45	2.18	11.04	2.36	12.09	2.48
	29	10.74	2.75	10.51	2.75	10.44	2.75	10.28	2.75	11.26	2.83	11.92	2.88
	32	10.56	3.11	10.61	3.10	10.62	3.09	10.66	3.08	11.31	3.10	11.75	3.12
	35	10.44	3.37	10.62	3.35	10.68	3.34	10.80	3.33	11.24	3.31	11.53	3.30
	40	10.10	3.58	10.33	3.57	10.41	3.57	10.56	3.57	10.52	3.53	10.80	3.50
	43	9.79	3.56	9.96	3.59	10.02	3.59	10.13	3.61	10.51	3.57	10.48	3.55
	46	9.42	3.46	9.45	3.51	9.46	3.52	9.48	3.56	10.03	3.56	10.15	3.55
2.5 + 3.5 + 3.5 + 5.0	22	10.68	1.49	9.70	1.56	9.38	1.58	8.73	1.63	10.93	1.90	12.39	2.09
	25	10.77	2.08	10.20	2.11	10.01	2.12	9.63	2.14	11.24	2.31	12.32	2.43
	29	10.94	2.69	10.71	2.69	10.63	2.69	10.47	2.69	11.47	2.77	12.14	2.82
	32	10.76	3.05	10.80	3.03	10.82	3.03	10.85	3.02	11.52	3.04	11.97	3.05
	35	10.63	3.30	10.82	3.28	10.88	3.27	11.00	3.26	11.45	3.24	11.75	3.23
	40	10.29	3.50	10.52	3.50	10.60	3.50	10.76	3.49	10.71	3.45	11.00	3.42
	43	9.97	3.49	10.14	3.51	10.20	3.52	10.31	3.53	10.70	3.50	10.67	3.48
	46	9.59	3.38	9.62	3.43	9.63	3.45	9.65	3.48	10.22	3.48	10.34	3.48
2.5 + 3.5 + 3.5 + 6.0	22	10.68	1.49	9.70	1.56	9.38	1.58	8.73	1.63	10.93	1.90	12.39	2.09
	25	10.77	2.08	10.20	2.11	10.01	2.12	9.63	2.14	11.24	2.31	12.32	2.43
	29	10.94	2.69	10.71	2.69	10.63	2.69	10.47	2.69	11.47	2.77	12.14	2.82
	32	10.76	3.05	10.80	3.03	10.82	3.03	10.85	3.02	11.52	3.04	11.97	3.05
	35	10.63	3.30	10.82	3.28	10.88	3.27	11.00	3.26	11.45	3.24	11.75	3.23
	40	10.29	3.50	10.52	3.50	10.60	3.50	10.76	3.49	10.71	3.45	11.00	3.42
	43	9.97	3.49	10.14	3.51	10.20	3.52	10.31	3.53	10.70	3.50	10.67	3.48
	46	9.59	3.38	9.62	3.43	9.63	3.45	9.65	3.48	10.22	3.48	10.34	3.48
2.5 + 3.5 + 3.5 + 7.1	22	10.87	1.53	9.88	1.59	9.55	1.62	8.89	1.66	11.12	1.94	12.61	2.13
	25	10.96	2.12	10.38	2.15	10.19	2.16	9.80	2.18	11.45	2.36	12.54	2.48
	29	11.14	2.75	10.90	2.75	10.82	2.75	10.66	2.75	11.68	2.83	12.36	2.88
	32	10.95	3.11	11.00	3.10	11.02	3.09	11.05	3.08	11.73	3.10	12.18	3.12
	35	10.83	3.37	11.01	3.35	11.08	3.34	11.20	3.33	11.66	3.31	11.96	3.30
	40	10.48	3.58	10.71	3.57	10.79	3.57	10.95	3.57	10.91	3.53	11.20	3.50
	43	10.15	3.56	10.33	3.59	10.39	3.59	10.50	3.61	10.90	3.57	10.86	3.55
	46	9.77	3.46	9.80	3.51	9.81	3.52	9.83	3.56	10.41	3.56	10.53	3.55

Combination (Capacity)	Outdoor Air Temp. °C DB	Indoor Air Temp. °C											
		27/16		27/17.5		27/18		27/19		27/22		27/24	
		Total Q	Input Power	Total Q	Input Power	Total Q	Input Power	Total Q	Input Power	Total Q	Input Power	Total Q	Input Power
2.5 + 3.5 + 4.2 + 4.2	22	10.68	1.60	9.70	1.67	9.38	1.69	8.73	1.74	10.93	2.03	12.39	2.23
	25	10.77	2.22	10.20	2.25	10.01	2.26	9.63	2.28	11.24	2.47	12.32	2.59
	29	10.94	2.88	10.71	2.88	10.63	2.88	10.47	2.88	11.47	2.95	12.14	3.01
	32	10.76	3.25	10.80	3.23	10.82	3.23	10.85	3.22	11.52	3.24	11.97	3.26
	35	10.63	3.52	10.82	3.50	10.88	3.49	11.00	3.48	11.45	3.46	11.75	3.45
	40	10.29	3.74	10.52	3.74	10.60	3.73	10.76	3.73	10.71	3.68	11.00	3.65
	43	9.97	3.73	10.14	3.75	10.20	3.75	10.31	3.77	10.70	3.74	10.67	3.71
	46	9.59	3.61	9.62	3.67	9.63	3.68	9.65	3.72	10.22	3.72	10.34	3.71
2.5 + 3.5 + 4.2 + 5.0	22	10.68	1.46	9.70	1.53	9.38	1.55	8.73	1.59	10.93	1.86	12.39	2.04
	25	10.77	2.03	10.20	2.06	10.01	2.07	9.63	2.09	11.24	2.26	12.32	2.38
	29	10.94	2.64	10.71	2.64	10.63	2.64	10.47	2.64	11.47	2.71	12.14	2.76
	32	10.76	2.98	10.80	2.97	10.82	2.96	10.85	2.95	11.52	2.97	11.97	2.99
	35	10.63	3.23	10.82	3.21	10.88	3.20	11.00	3.19	11.45	3.17	11.75	3.16
	40	10.29	3.43	10.52	3.42	10.60	3.42	10.76	3.42	10.71	3.38	11.00	3.35
	43	9.97	3.41	10.14	3.43	10.20	3.44	10.31	3.45	10.70	3.42	10.67	3.40
	46	9.59	3.31	9.62	3.36	9.63	3.38	9.65	3.41	10.22	3.41	10.34	3.40
2.5 + 3.5 + 4.2 + 6.0	22	10.87	1.53	9.88	1.59	9.55	1.62	8.89	1.66	11.12	1.94	12.61	2.13
	25	10.96	2.12	10.38	2.15	10.19	2.16	9.80	2.18	11.45	2.36	12.54	2.48
	29	11.14	2.75	10.90	2.75	10.82	2.75	10.66	2.75	11.68	2.83	12.36	2.88
	32	10.95	3.11	11.00	3.10	11.02	3.09	11.05	3.08	11.73	3.10	12.18	3.12
	35	10.83	3.37	11.01	3.35	11.08	3.34	11.20	3.33	11.66	3.31	11.96	3.30
	40	10.48	3.58	10.71	3.57	10.79	3.57	10.95	3.57	10.91	3.53	11.20	3.50
	43	10.15	3.56	10.33	3.59	10.39	3.59	10.50	3.61	10.90	3.57	10.86	3.55
	46	9.77	3.46	9.80	3.51	9.81	3.52	9.83	3.56	10.41	3.56	10.53	3.55
2.5 + 3.5 + 4.2 + 7.1	22	10.87	1.53	9.88	1.60	9.55	1.62	8.89	1.67	11.12	1.95	12.61	2.14
	25	10.96	2.13	10.38	2.16	10.19	2.17	9.80	2.19	11.45	2.37	12.54	2.49
	29	11.14	2.76	10.90	2.76	10.82	2.76	10.66	2.76	11.68	2.84	12.36	2.89
	32	10.95	3.12	11.00	3.10	11.02	3.10	11.05	3.09	11.73	3.11	12.18	3.13
	35	10.83	3.38	11.01	3.36	11.08	3.35	11.20	3.34	11.66	3.32	11.96	3.31
	40	10.48	3.59	10.71	3.59	10.79	3.58	10.95	3.58	10.91	3.54	11.20	3.51
	43	10.15	3.58	10.33	3.60	10.39	3.60	10.50	3.62	10.90	3.59	10.86	3.56
	46	9.77	3.47	9.80	3.52	9.81	3.54	9.83	3.57	10.41	3.57	10.53	3.56
2.5 + 3.5 + 5.0 + 5.0	22	10.87	1.47	9.88	1.53	9.55	1.55	8.89	1.60	11.12	1.87	12.61	2.05
	25	10.96	2.04	10.38	2.07	10.19	2.08	9.80	2.10	11.45	2.27	12.54	2.38
	29	11.14	2.64	10.90	2.64	10.82	2.64	10.66	2.64	11.68	2.72	12.36	2.76
	32	10.95	2.99	11.00	2.97	11.02	2.97	11.05	2.96	11.73	2.98	12.18	2.99
	35	10.83	3.24	11.01	3.22	11.08	3.21	11.20	3.20	11.66	3.18	11.96	3.17
	40	10.48	3.44	10.71	3.44	10.79	3.43	10.95	3.43	10.91	3.39	11.20	3.36
	43	10.15	3.43	10.33	3.45	10.39	3.45	10.50	3.47	10.90	3.44	10.86	3.42
	46	9.77	3.32	9.80	3.37	9.81	3.39	9.83	3.42	10.41	3.42	10.53	3.42

Combination (Capacity)	Outdoor Air Temp. °C DB	Indoor Air Temp. °C											
		27/16		27/17.5		27/18		27/19		27/22		27/24	
		Total Q	Input Power	Total Q	Input Power	Total Q	Input Power	Total Q	Input Power	Total Q	Input Power	Total Q	Input Power
2.5 + 3.5 + 5.0 + 6.0	22	10.87	1.47	9.88	1.53	9.55	1.55	8.89	1.60	11.12	1.87	12.61	2.05
	25	10.96	2.04	10.38	2.07	10.19	2.08	9.80	2.10	11.45	2.27	12.54	2.38
	29	11.14	2.64	10.90	2.64	10.82	2.64	10.66	2.64	11.68	2.72	12.36	2.76
	32	10.95	2.99	11.00	2.97	11.02	2.97	11.05	2.96	11.73	2.98	12.18	2.99
	35	10.83	3.24	11.01	3.22	11.08	3.21	11.20	3.20	11.66	3.18	11.96	3.17
	40	10.48	3.44	10.71	3.44	10.79	3.43	10.95	3.43	10.91	3.39	11.20	3.36
	43	10.15	3.43	10.33	3.45	10.39	3.45	10.50	3.47	10.90	3.44	10.86	3.42
	46	9.77	3.32	9.80	3.37	9.81	3.39	9.83	3.42	10.41	3.42	10.53	3.42
2.5 + 3.5 + 5.0 + 7.1	22	10.87	1.47	9.88	1.53	9.55	1.55	8.89	1.60	11.12	1.87	12.61	2.05
	25	10.96	2.04	10.38	2.07	10.19	2.08	9.80	2.10	11.45	2.27	12.54	2.38
	29	11.14	2.64	10.90	2.64	10.82	2.64	10.66	2.64	11.68	2.72	12.36	2.76
	32	10.95	2.99	11.00	2.97	11.02	2.97	11.05	2.96	11.73	2.98	12.18	2.99
	35	10.83	3.24	11.01	3.22	11.08	3.21	11.20	3.20	11.66	3.18	11.96	3.17
	40	10.48	3.44	10.71	3.44	10.79	3.43	10.95	3.43	10.91	3.39	11.20	3.36
	43	10.15	3.43	10.33	3.45	10.39	3.45	10.50	3.47	10.90	3.44	10.86	3.42
	46	9.77	3.32	9.80	3.37	9.81	3.39	9.83	3.42	10.41	3.42	10.53	3.42
2.5 + 3.5 + 6.0 + 6.0	22	10.87	1.47	9.88	1.53	9.55	1.55	8.89	1.60	11.12	1.87	12.61	2.05
	25	10.96	2.04	10.38	2.07	10.19	2.08	9.80	2.10	11.45	2.27	12.54	2.38
	29	11.14	2.64	10.90	2.64	10.82	2.64	10.66	2.64	11.68	2.72	12.36	2.76
	32	10.95	2.99	11.00	2.97	11.02	2.97	11.05	2.96	11.73	2.98	12.18	2.99
	35	10.83	3.24	11.01	3.22	11.08	3.21	11.20	3.20	11.66	3.18	11.96	3.17
	40	10.48	3.44	10.71	3.44	10.79	3.43	10.95	3.43	10.91	3.39	11.20	3.36
	43	10.15	3.43	10.33	3.45	10.39	3.45	10.50	3.47	10.90	3.44	10.86	3.42
	46	9.77	3.32	9.80	3.37	9.81	3.39	9.83	3.42	10.41	3.42	10.53	3.42
2.5 + 4.2 + 4.2 + 4.2	22	10.68	1.56	9.70	1.63	9.38	1.65	8.73	1.70	10.93	1.98	12.39	2.18
	25	10.77	2.17	10.20	2.20	10.01	2.21	9.63	2.23	11.24	2.41	12.32	2.53
	29	10.94	2.81	10.71	2.81	10.63	2.81	10.47	2.81	11.47	2.89	12.14	2.94
	32	10.76	3.18	10.80	3.16	10.82	3.16	10.85	3.14	11.52	3.17	11.97	3.18
	35	10.63	3.44	10.82	3.42	10.88	3.41	11.00	3.40	11.45	3.38	11.75	3.37
	40	10.29	3.66	10.52	3.65	10.60	3.65	10.76	3.64	10.71	3.60	11.00	3.57
	43	9.97	3.64	10.14	3.66	10.20	3.67	10.31	3.68	10.70	3.65	10.67	3.63
	46	9.59	3.53	9.62	3.58	9.63	3.60	9.65	3.63	10.22	3.63	10.34	3.63
2.5 + 4.2 + 4.2 + 5.0	22	10.87	1.53	9.88	1.59	9.55	1.62	8.89	1.66	11.12	1.94	12.61	2.13
	25	10.96	2.12	10.38	2.15	10.19	2.16	9.80	2.18	11.45	2.36	12.54	2.48
	29	11.14	2.75	10.90	2.75	10.82	2.75	10.66	2.75	11.68	2.83	12.36	2.88
	32	10.95	3.11	11.00	3.10	11.02	3.09	11.05	3.08	11.73	3.10	12.18	3.12
	35	10.83	3.37	11.01	3.35	11.08	3.34	11.20	3.33	11.66	3.31	11.96	3.30
	40	10.48	3.58	10.71	3.57	10.79	3.57	10.95	3.57	10.91	3.53	11.20	3.50
	43	10.15	3.56	10.33	3.59	10.39	3.59	10.50	3.61	10.90	3.57	10.86	3.55
	46	9.77	3.46	9.80	3.51	9.81	3.52	9.83	3.56	10.41	3.56	10.53	3.55

Combination (Capacity)	Outdoor Air Temp. °C DB	Indoor Air Temp. °C											
		27/16		27/17.5		27/18		27/19		27/22		27/24	
		Total Q	Input Power	Total Q	Input Power	Total Q	Input Power	Total Q	Input Power	Total Q	Input Power	Total Q	Input Power
2.5 + 4.2 + 4.2 + 6.0	22	10.87	1.53	9.88	1.59	9.55	1.62	8.89	1.66	11.12	1.94	12.61	2.13
	25	10.96	2.12	10.38	2.15	10.19	2.16	9.80	2.18	11.45	2.36	12.54	2.48
	29	11.14	2.75	10.90	2.75	10.82	2.75	10.66	2.75	11.68	2.83	12.36	2.88
	32	10.95	3.11	11.00	3.10	11.02	3.09	11.05	3.08	11.73	3.10	12.18	3.12
	35	10.83	3.37	11.01	3.35	11.08	3.34	11.20	3.33	11.66	3.31	11.96	3.30
	40	10.48	3.58	10.71	3.57	10.79	3.57	10.95	3.57	10.91	3.53	11.20	3.50
	43	10.15	3.56	10.33	3.59	10.39	3.59	10.50	3.61	10.90	3.57	10.86	3.55
	46	9.77	3.46	9.80	3.51	9.81	3.52	9.83	3.56	10.41	3.56	10.53	3.55
2.5 + 4.2 + 4.2 + 7.1	22	10.87	1.49	9.88	1.56	9.55	1.58	8.89	1.63	11.12	1.90	12.61	2.09
	25	10.96	2.08	10.38	2.11	10.19	2.12	9.80	2.14	11.45	2.31	12.54	2.43
	29	11.14	2.69	10.90	2.69	10.82	2.69	10.66	2.69	11.68	2.77	12.36	2.82
	32	10.95	3.05	11.00	3.03	11.02	3.03	11.05	3.02	11.73	3.04	12.18	3.05
	35	10.83	3.30	11.01	3.28	11.08	3.27	11.20	3.26	11.66	3.24	11.96	3.23
	40	10.48	3.50	10.71	3.50	10.79	3.50	10.95	3.49	10.91	3.45	11.20	3.42
	43	10.15	3.49	10.33	3.51	10.39	3.52	10.50	3.53	10.90	3.50	10.86	3.48
	46	9.77	3.38	9.80	3.43	9.81	3.45	9.83	3.48	10.41	3.48	10.53	3.48
2.5 + 4.2 + 5.0 + 5.0	22	10.87	1.47	9.88	1.53	9.55	1.55	8.89	1.60	11.12	1.87	12.61	2.05
	25	10.96	2.04	10.38	2.07	10.19	2.08	9.80	2.10	11.45	2.27	12.54	2.38
	29	11.14	2.64	10.90	2.64	10.82	2.64	10.66	2.64	11.68	2.72	12.36	2.76
	32	10.95	2.99	11.00	2.97	11.02	2.97	11.05	2.96	11.73	2.98	12.18	2.99
	35	10.83	3.24	11.01	3.22	11.08	3.21	11.20	3.20	11.66	3.18	11.96	3.17
	40	10.48	3.44	10.71	3.44	10.79	3.43	10.95	3.43	10.91	3.39	11.20	3.36
	43	10.15	3.43	10.33	3.45	10.39	3.45	10.50	3.47	10.90	3.44	10.86	3.42
	46	9.77	3.32	9.80	3.37	9.81	3.39	9.83	3.42	10.41	3.42	10.53	3.42
2.5 + 4.2 + 5.0 + 6.0	22	10.87	1.47	9.88	1.53	9.55	1.55	8.89	1.60	11.12	1.87	12.61	2.05
	25	10.96	2.04	10.38	2.07	10.19	2.08	9.80	2.10	11.45	2.27	12.54	2.38
	29	11.14	2.64	10.90	2.64	10.82	2.64	10.66	2.64	11.68	2.72	12.36	2.76
	32	10.95	2.99	11.00	2.97	11.02	2.97	11.05	2.96	11.73	2.98	12.18	2.99
	35	10.83	3.24	11.01	3.22	11.08	3.21	11.20	3.20	11.66	3.18	11.96	3.17
	40	10.48	3.44	10.71	3.44	10.79	3.43	10.95	3.43	10.91	3.39	11.20	3.36
	43	10.15	3.43	10.33	3.45	10.39	3.45	10.50	3.47	10.90	3.44	10.86	3.42
	46	9.77	3.32	9.80	3.37	9.81	3.39	9.83	3.42	10.41	3.42	10.53	3.42
2.5 + 5.0 + 5.0 + 5.0	22	10.87	1.44	9.88	1.50	9.55	1.52	8.89	1.57	11.12	1.83	12.61	2.01
	25	10.96	2.00	10.38	2.03	10.19	2.04	9.80	2.06	11.45	2.23	12.54	2.34
	29	11.14	2.59	10.90	2.59	10.82	2.59	10.66	2.59	11.68	2.67	12.36	2.71
	32	10.95	2.93	11.00	2.92	11.02	2.91	11.05	2.90	11.73	2.92	12.18	2.94
	35	10.83	3.18	11.01	3.16	11.08	3.15	11.20	3.14	11.66	3.12	11.96	3.11
	40	10.48	3.38	10.71	3.37	10.79	3.37	10.95	3.37	10.91	3.32	11.20	3.30
	43	10.15	3.36	10.33	3.38	10.39	3.39	10.50	3.40	10.90	3.37	10.86	3.35
	46	9.77	3.26	9.80	3.31	9.81	3.32	9.83	3.36	10.41	3.35	10.53	3.35

Combination (Capacity)	Outdoor Air Temp. °C DB	Indoor Air Temp. °C											
		27/16		27/17.5		27/18		27/19		27/22		27/24	
		Total Q	Input Power	Total Q	Input Power	Total Q	Input Power	Total Q	Input Power	Total Q	Input Power	Total Q	Input Power
3.5 + 3.5 + 3.5 + 3.5	22	10.48	1.49	9.53	1.56	9.21	1.58	8.57	1.62	10.73	1.90	12.16	2.08
	25	10.57	2.07	10.01	2.10	9.83	2.11	9.45	2.13	11.04	2.31	12.09	2.42
	29	10.74	2.69	10.51	2.69	10.44	2.69	10.28	2.69	11.26	2.76	11.92	2.81
	32	10.56	3.04	10.61	3.02	10.62	3.02	10.66	3.01	11.31	3.03	11.75	3.04
	35	10.44	3.29	10.62	3.27	10.68	3.26	10.80	3.25	11.24	3.23	11.53	3.22
	40	10.10	3.49	10.33	3.49	10.41	3.49	10.56	3.48	10.52	3.44	10.80	3.41
	43	9.79	3.48	9.96	3.50	10.02	3.51	10.13	3.52	10.51	3.49	10.48	3.47
	46	9.42	3.37	9.45	3.42	9.46	3.44	9.48	3.47	10.03	3.47	10.15	3.47
3.5 + 3.5 + 3.5 + 4.2	22	10.68	1.56	9.70	1.63	9.38	1.65	8.73	1.70	10.93	1.98	12.39	2.18
	25	10.77	2.17	10.20	2.20	10.01	2.21	9.63	2.23	11.24	2.41	12.32	2.53
	29	10.94	2.81	10.71	2.81	10.63	2.81	10.47	2.81	11.47	2.89	12.14	2.94
	32	10.76	3.18	10.80	3.16	10.82	3.16	10.85	3.14	11.52	3.17	11.97	3.18
	35	10.63	3.44	10.82	3.42	10.88	3.41	11.00	3.40	11.45	3.38	11.75	3.37
	40	10.29	3.66	10.52	3.65	10.60	3.65	10.76	3.64	10.71	3.60	11.00	3.57
	43	9.97	3.64	10.14	3.66	10.20	3.67	10.31	3.68	10.70	3.65	10.67	3.63
	46	9.59	3.53	9.62	3.58	9.63	3.60	9.65	3.63	10.22	3.63	10.34	3.63
3.5 + 3.5 + 3.5 + 5.0	22	10.68	1.46	9.70	1.53	9.38	1.55	8.73	1.59	10.93	1.86	12.39	2.04
	25	10.77	2.03	10.20	2.06	10.01	2.07	9.63	2.09	11.24	2.26	12.32	2.38
	29	10.94	2.64	10.71	2.64	10.63	2.64	10.47	2.64	11.47	2.71	12.14	2.76
	32	10.76	2.98	10.80	2.97	10.82	2.96	10.85	2.95	11.52	2.97	11.97	2.99
	35	10.63	3.23	10.82	3.21	10.88	3.20	11.00	3.19	11.45	3.17	11.75	3.16
	40	10.29	3.43	10.52	3.42	10.60	3.42	10.76	3.42	10.71	3.38	11.00	3.35
	43	9.97	3.41	10.14	3.43	10.20	3.44	10.31	3.45	10.70	3.42	10.67	3.40
	46	9.59	3.31	9.62	3.36	9.63	3.38	9.65	3.41	10.22	3.41	10.34	3.40
3.5 + 3.5 + 3.5 + 6.0	22	10.87	1.53	9.88	1.59	9.55	1.62	8.89	1.66	11.12	1.94	12.61	2.13
	25	10.96	2.12	10.38	2.15	10.19	2.16	9.80	2.18	11.45	2.36	12.54	2.48
	29	11.14	2.75	10.90	2.75	10.82	2.75	10.66	2.75	11.68	2.83	12.36	2.88
	32	10.95	3.11	11.00	3.10	11.02	3.09	11.05	3.08	11.73	3.10	12.18	3.12
	35	10.83	3.37	11.01	3.35	11.08	3.34	11.20	3.33	11.66	3.31	11.96	3.30
	40	10.48	3.58	10.71	3.57	10.79	3.57	10.95	3.57	10.91	3.53	11.20	3.50
	43	10.15	3.56	10.33	3.59	10.39	3.59	10.50	3.61	10.90	3.57	10.86	3.55
	46	9.77	3.46	9.80	3.51	9.81	3.52	9.83	3.56	10.41	3.56	10.53	3.55
3.5 + 3.5 + 3.5 + 7.1	22	10.87	1.49	9.88	1.56	9.55	1.58	8.89	1.63	11.12	1.90	12.61	2.09
	25	10.96	2.08	10.38	2.11	10.19	2.12	9.80	2.14	11.45	2.31	12.54	2.43
	29	11.14	2.69	10.90	2.69	10.82	2.69	10.66	2.69	11.68	2.77	12.36	2.82
	32	10.95	3.05	11.00	3.03	11.02	3.03	11.05	3.02	11.73	3.04	12.18	3.05
	35	10.83	3.30	11.01	3.28	11.08	3.27	11.20	3.26	11.66	3.24	11.96	3.23
	40	10.48	3.50	10.71	3.50	10.79	3.50	10.95	3.49	10.91	3.45	11.20	3.42
	43	10.15	3.49	10.33	3.51	10.39	3.52	10.50	3.53	10.90	3.50	10.86	3.48
	46	9.77	3.38	9.80	3.43	9.81	3.45	9.83	3.48	10.41	3.48	10.53	3.48

Combination (Capacity)	Outdoor Air Temp. °C DB	Indoor Air Temp. °C											
		27/16		27/17.5		27/18		27/19		27/22		27/24	
		Total Q	Input Power	Total Q	Input Power	Total Q	Input Power	Total Q	Input Power	Total Q	Input Power	Total Q	Input Power
3.5 + 3.5 + 4.2 + 4.2	22	10.68	1.56	9.70	1.63	9.38	1.65	8.73	1.70	10.93	1.98	12.39	2.18
	25	10.77	2.17	10.20	2.20	10.01	2.21	9.63	2.23	11.24	2.41	12.32	2.53
	29	10.94	2.81	10.71	2.81	10.63	2.81	10.47	2.81	11.47	2.89	12.14	2.94
	32	10.76	3.18	10.80	3.16	10.82	3.16	10.85	3.14	11.52	3.17	11.97	3.18
	35	10.63	3.44	10.82	3.42	10.88	3.41	11.00	3.40	11.45	3.38	11.75	3.37
	40	10.29	3.66	10.52	3.65	10.60	3.65	10.76	3.64	10.71	3.60	11.00	3.57
	43	9.97	3.64	10.14	3.66	10.20	3.67	10.31	3.68	10.70	3.65	10.67	3.63
	46	9.59	3.53	9.62	3.58	9.63	3.60	9.65	3.63	10.22	3.63	10.34	3.63
3.5 + 3.5 + 4.2 + 5.0	22	10.87	1.53	9.88	1.59	9.55	1.62	8.89	1.66	11.12	1.94	12.61	2.13
	25	10.96	2.12	10.38	2.15	10.19	2.16	9.80	2.18	11.45	2.36	12.54	2.48
	29	11.14	2.75	10.90	2.75	10.82	2.75	10.66	2.75	11.68	2.83	12.36	2.88
	32	10.95	3.11	11.00	3.10	11.02	3.09	11.05	3.08	11.73	3.10	12.18	3.12
	35	10.83	3.37	11.01	3.35	11.08	3.34	11.20	3.33	11.66	3.31	11.96	3.30
	40	10.48	3.58	10.71	3.57	10.79	3.57	10.95	3.57	10.91	3.53	11.20	3.50
	43	10.15	3.56	10.33	3.59	10.39	3.59	10.50	3.61	10.90	3.57	10.86	3.55
	46	9.77	3.46	9.80	3.51	9.81	3.52	9.83	3.56	10.41	3.56	10.53	3.55
3.5 + 3.5 + 4.2 + 6.0	22	10.87	1.53	9.88	1.59	9.55	1.62	8.89	1.66	11.12	1.94	12.61	2.13
	25	10.96	2.12	10.38	2.15	10.19	2.16	9.80	2.18	11.45	2.36	12.54	2.48
	29	11.14	2.75	10.90	2.75	10.82	2.75	10.66	2.75	11.68	2.83	12.36	2.88
	32	10.95	3.11	11.00	3.10	11.02	3.09	11.05	3.08	11.73	3.10	12.18	3.12
	35	10.83	3.37	11.01	3.35	11.08	3.34	11.20	3.33	11.66	3.31	11.96	3.30
	40	10.48	3.58	10.71	3.57	10.79	3.57	10.95	3.57	10.91	3.53	11.20	3.50
	43	10.15	3.56	10.33	3.59	10.39	3.59	10.50	3.61	10.90	3.57	10.86	3.55
	46	9.77	3.46	9.80	3.51	9.81	3.52	9.83	3.56	10.41	3.56	10.53	3.55
3.5 + 3.5 + 4.2 + 7.1	22	10.87	1.49	9.88	1.56	9.55	1.58	8.89	1.63	11.12	1.90	12.61	2.09
	25	10.96	2.08	10.38	2.11	10.19	2.12	9.80	2.14	11.45	2.31	12.54	2.43
	29	11.14	2.69	10.90	2.69	10.82	2.69	10.66	2.69	11.68	2.77	12.36	2.82
	32	10.95	3.05	11.00	3.03	11.02	3.03	11.05	3.02	11.73	3.04	12.18	3.05
	35	10.83	3.30	11.01	3.28	11.08	3.27	11.20	3.26	11.66	3.24	11.96	3.23
	40	10.48	3.50	10.71	3.50	10.79	3.50	10.95	3.49	10.91	3.45	11.20	3.42
	43	10.15	3.49	10.33	3.51	10.39	3.52	10.50	3.53	10.90	3.50	10.86	3.48
	46	9.77	3.38	9.80	3.43	9.81	3.45	9.83	3.48	10.41	3.48	10.53	3.48
3.5 + 3.5 + 5.0 + 5.0	22	10.87	1.47	9.88	1.53	9.55	1.55	8.89	1.60	11.12	1.87	12.61	2.05
	25	10.96	2.04	10.38	2.07	10.19	2.08	9.80	2.10	11.45	2.27	12.54	2.38
	29	11.14	2.64	10.90	2.64	10.82	2.64	10.66	2.64	11.68	2.72	12.36	2.76
	32	10.95	2.99	11.00	2.97	11.02	2.97	11.05	2.96	11.73	2.98	12.18	2.99
	35	10.83	3.24	11.01	3.22	11.08	3.21	11.20	3.20	11.66	3.18	11.96	3.17
	40	10.48	3.44	10.71	3.44	10.79	3.43	10.95	3.43	10.91	3.39	11.20	3.36
	43	10.15	3.43	10.33	3.45	10.39	3.45	10.50	3.47	10.90	3.44	10.86	3.42
	46	9.77	3.32	9.80	3.37	9.81	3.39	9.83	3.42	10.41	3.42	10.53	3.42

Combination (Capacity)	Outdoor Air Temp. °C DB	Indoor Air Temp. °C											
		27/16		27/17.5		27/18		27/19		27/22		27/24	
		Total Q	Input Power	Total Q	Input Power	Total Q	Input Power	Total Q	Input Power	Total Q	Input Power	Total Q	Input Power
3.5 + 3.5 + 5.0 + 6.0	22	10.87	1.47	9.88	1.53	9.55	1.55	8.89	1.60	11.12	1.87	12.61	2.05
	25	10.96	2.04	10.38	2.07	10.19	2.08	9.80	2.10	11.45	2.27	12.54	2.38
	29	11.14	2.64	10.90	2.64	10.82	2.64	10.66	2.64	11.68	2.72	12.36	2.76
	32	10.95	2.99	11.00	2.97	11.02	2.97	11.05	2.96	11.73	2.98	12.18	2.99
	35	10.83	3.24	11.01	3.22	11.08	3.21	11.20	3.20	11.66	3.18	11.96	3.17
	40	10.48	3.44	10.71	3.44	10.79	3.43	10.95	3.43	10.91	3.39	11.20	3.36
	43	10.15	3.43	10.33	3.45	10.39	3.45	10.50	3.47	10.90	3.44	10.86	3.42
	46	9.77	3.32	9.80	3.37	9.81	3.39	9.83	3.42	10.41	3.42	10.53	3.42
3.5 + 4.2 + 4.2 + 4.2	22	10.87	1.63	9.88	1.70	9.55	1.73	8.89	1.78	11.12	2.08	12.61	2.28
	25	10.96	2.27	10.38	2.30	10.19	2.31	9.80	2.33	11.45	2.52	12.54	2.65
	29	11.14	2.94	10.90	2.94	10.82	2.94	10.66	2.94	11.68	3.02	12.36	3.08
	32	10.95	3.33	11.00	3.31	11.02	3.30	11.05	3.29	11.73	3.32	12.18	3.33
	35	10.83	3.60	11.01	3.58	11.08	3.57	11.20	3.56	11.66	3.54	11.96	3.53
	40	10.48	3.83	10.71	3.82	10.79	3.82	10.95	3.82	10.91	3.77	11.20	3.74
	43	10.15	3.81	10.33	3.83	10.39	3.84	10.50	3.86	10.90	3.82	10.86	3.80
	46	9.77	3.69	9.80	3.75	9.81	3.77	9.83	3.81	10.41	3.80	10.53	3.80
3.5 + 4.2 + 4.2 + 5.0	22	10.87	1.53	9.88	1.60	9.55	1.62	8.89	1.67	11.12	1.95	12.61	2.14
	25	10.96	2.13	10.38	2.16	10.19	2.17	9.80	2.19	11.45	2.37	12.54	2.49
	29	11.14	2.76	10.90	2.76	10.82	2.76	10.66	2.76	11.68	2.84	12.36	2.89
	32	10.95	3.12	11.00	3.10	11.02	3.10	11.05	3.09	11.73	3.11	12.18	3.13
	35	10.83	3.38	11.01	3.36	11.08	3.35	11.20	3.34	11.66	3.32	11.96	3.31
	40	10.48	3.59	10.71	3.59	10.79	3.58	10.95	3.58	10.91	3.54	11.20	3.51
	43	10.15	3.58	10.33	3.60	10.39	3.60	10.50	3.62	10.90	3.59	10.86	3.56
	46	9.77	3.47	9.80	3.52	9.81	3.54	9.83	3.57	10.41	3.57	10.53	3.56
3.5 + 4.2 + 4.2 + 6.0	22	10.87	1.53	9.88	1.60	9.55	1.62	8.89	1.67	11.12	1.95	12.61	2.14
	25	10.96	2.13	10.38	2.16	10.19	2.17	9.80	2.19	11.45	2.37	12.54	2.49
	29	11.14	2.76	10.90	2.76	10.82	2.76	10.66	2.76	11.68	2.84	12.36	2.89
	32	10.95	3.12	11.00	3.10	11.02	3.10	11.05	3.09	11.73	3.11	12.18	3.13
	35	10.83	3.38	11.01	3.36	11.08	3.35	11.20	3.34	11.66	3.32	11.96	3.31
	40	10.48	3.59	10.71	3.59	10.79	3.58	10.95	3.58	10.91	3.54	11.20	3.51
	43	10.15	3.58	10.33	3.60	10.39	3.60	10.50	3.62	10.90	3.59	10.86	3.56
	46	9.77	3.47	9.80	3.52	9.81	3.54	9.83	3.57	10.41	3.57	10.53	3.56
3.5 + 4.2 + 5.0 + 5.0	22	10.87	1.47	9.88	1.53	9.55	1.55	8.89	1.60	11.12	1.87	12.61	2.05
	25	10.96	2.04	10.38	2.07	10.19	2.08	9.80	2.10	11.45	2.27	12.54	2.38
	29	11.14	2.64	10.90	2.64	10.82	2.64	10.66	2.64	11.68	2.72	12.36	2.76
	32	10.95	2.99	11.00	2.97	11.02	2.97	11.05	2.96	11.73	2.98	12.18	2.99
	35	10.83	3.24	11.01	3.22	11.08	3.21	11.20	3.20	11.66	3.18	11.96	3.17
	40	10.48	3.44	10.71	3.44	10.79	3.43	10.95	3.43	10.91	3.39	11.20	3.36
	43	10.15	3.43	10.33	3.45	10.39	3.45	10.50	3.47	10.90	3.44	10.86	3.42
	46	9.77	3.32	9.80	3.37	9.81	3.39	9.83	3.42	10.41	3.42	10.53	3.42

Combination (Capacity)	Outdoor Air Temp. °C DB	Indoor Air Temp. °C											
		27/16		27/17.5		27/18		27/19		27/22		27/24	
		Total Q	Input Power	Total Q	Input Power	Total Q	Input Power	Total Q	Input Power	Total Q	Input Power	Total Q	Input Power
4.2 + 4.2 + 4.2 + 4.2	22	10.87	1.60	9.88	1.67	9.55	1.69	8.89	1.74	11.12	2.03	12.61	2.23
	25	10.96	2.22	10.38	2.25	10.19	2.26	9.80	2.28	11.45	2.47	12.54	2.59
	29	11.14	2.88	10.90	2.88	10.82	2.88	10.66	2.88	11.68	2.95	12.36	3.01
	32	10.95	3.25	11.00	3.23	11.02	3.23	11.05	3.22	11.73	3.24	12.18	3.26
	35	10.83	3.52	11.01	3.50	11.08	3.49	11.20	3.48	11.66	3.46	11.96	3.45
	40	10.48	3.74	10.71	3.74	10.79	3.73	10.95	3.73	10.91	3.68	11.20	3.65
	43	10.15	3.73	10.33	3.75	10.39	3.75	10.50	3.77	10.90	3.74	10.86	3.71
	46	9.77	3.61	9.80	3.67	9.81	3.68	9.83	3.72	10.41	3.72	10.53	3.71
4.2 + 4.2 + 4.2 + 5.0	22	10.87	1.49	9.88	1.56	9.55	1.58	8.89	1.63	11.12	1.90	12.61	2.09
	25	10.96	2.08	10.38	2.11	10.19	2.12	9.80	2.14	11.45	2.31	12.54	2.43
	29	11.14	2.69	10.90	2.69	10.82	2.69	10.66	2.69	11.68	2.77	12.36	2.82
	32	10.95	3.05	11.00	3.03	11.02	3.03	11.05	3.02	11.73	3.04	12.18	3.05
	35	10.83	3.30	11.01	3.28	11.08	3.27	11.20	3.26	11.66	3.24	11.96	3.23
	40	10.48	3.50	10.71	3.50	10.79	3.50	10.95	3.49	10.91	3.45	11.20	3.42
	43	10.15	3.49	10.33	3.51	10.39	3.52	10.50	3.53	10.90	3.50	10.86	3.48
	46	9.77	3.38	9.80	3.43	9.81	3.45	9.83	3.48	10.41	3.48	10.53	3.48
1.6 + 1.6 + 1.6 + 1.6 + 1.6	22	14.11	1.98	11.97	2.10	11.26	2.14	9.83	2.22	11.28	2.26	12.24	2.28
	25	13.25	2.51	11.87	2.59	11.41	2.62	10.50	2.67	11.51	2.68	12.19	2.69
	29	12.57	3.07	11.85	3.10	11.61	3.11	11.13	3.13	11.71	3.13	12.09	3.14
	32	11.75	3.38	11.57	3.38	11.52	3.38	11.40	3.38	11.77	3.39	12.01	3.39
	35	11.33	3.60	11.41	3.58	11.44	3.57	11.50	3.56	11.75	3.56	11.91	3.56
	40	10.92	3.73	11.10	3.71	11.17	3.70	11.29	3.69	11.54	3.69	11.71	3.68
	43	10.82	3.70	10.88	3.68	10.90	3.68	10.94	3.66	11.32	3.66	11.57	3.66
	46	10.88	3.56	10.66	3.56	10.58	3.56	10.43	3.56	11.03	3.57	11.43	3.57
1.6 + 1.6 + 1.6 + 1.6 + 2.0	22	14.11	1.98	11.97	2.10	11.26	2.14	9.83	2.22	11.28	2.26	12.24	2.28
	25	13.25	2.51	11.87	2.59	11.41	2.62	10.50	2.67	11.51	2.68	12.19	2.69
	29	12.57	3.07	11.85	3.10	11.61	3.11	11.13	3.13	11.71	3.13	12.09	3.14
	32	11.75	3.38	11.57	3.38	11.52	3.38	11.40	3.38	11.77	3.39	12.01	3.39
	35	11.33	3.60	11.41	3.58	11.44	3.57	11.50	3.56	11.75	3.56	11.91	3.56
	40	10.92	3.73	11.10	3.71	11.17	3.70	11.29	3.69	11.54	3.69	11.71	3.68
	43	10.82	3.70	10.88	3.68	10.90	3.68	10.94	3.66	11.32	3.66	11.57	3.66
	46	10.88	3.56	10.66	3.56	10.58	3.56	10.43	3.56	11.03	3.57	11.43	3.57
1.6 + 1.6 + 1.6 + 1.6 + 2.5	22	14.11	1.98	11.97	2.10	11.26	2.14	9.83	2.22	11.28	2.26	12.24	2.28
	25	13.25	2.51	11.87	2.59	11.41	2.62	10.50	2.67	11.51	2.68	12.19	2.69
	29	12.57	3.07	11.85	3.10	11.61	3.11	11.13	3.13	11.71	3.13	12.09	3.14
	32	11.75	3.38	11.57	3.38	11.52	3.38	11.40	3.38	11.77	3.39	12.01	3.39
	35	11.33	3.60	11.41	3.58	11.44	3.57	11.50	3.56	11.75	3.56	11.91	3.56
	40	10.92	3.73	11.10	3.71	11.17	3.70	11.29	3.69	11.54	3.69	11.71	3.68
	43	10.82	3.70	10.88	3.68	10.90	3.68	10.94	3.66	11.32	3.66	11.57	3.66
	46	10.88	3.56	10.66	3.56	10.58	3.56	10.43	3.56	11.03	3.57	11.43	3.57



Combination (Capacity)	Outdoor Air Temp. °C DB	Indoor Air Temp. °C											
		27/16		27/17.5		27/18		27/19		27/22		27/24	
		Total Q	Input Power	Total Q	Input Power	Total Q	Input Power	Total Q	Input Power	Total Q	Input Power	Total Q	Input Power
1.6 + 1.6 + 1.6 + 1.6 + 3.5	22	14.11	1.94	11.97	2.06	11.26	2.10	9.83	2.18	11.28	2.21	12.24	2.23
	25	13.25	2.47	11.87	2.54	11.41	2.56	10.50	2.61	11.51	2.63	12.19	2.64
	29	12.57	3.01	11.85	3.04	11.61	3.05	11.13	3.07	11.71	3.07	12.09	3.07
	32	11.75	3.31	11.57	3.31	11.52	3.31	11.40	3.31	11.77	3.32	12.01	3.32
	35	11.33	3.53	11.41	3.51	11.44	3.50	11.50	3.49	11.75	3.49	11.91	3.49
	40	10.92	3.66	11.10	3.64	11.17	3.63	11.29	3.62	11.54	3.61	11.71	3.61
	43	10.82	3.63	10.88	3.61	10.90	3.60	10.94	3.59	11.32	3.59	11.57	3.59
	46	10.88	3.49	10.66	3.49	10.58	3.49	10.43	3.49	11.03	3.50	11.43	3.50
1.6 + 1.6 + 1.6 + 1.6 + 4.2	22	14.11	1.94	11.97	2.06	11.26	2.10	9.83	2.18	11.28	2.21	12.24	2.23
	25	13.25	2.47	11.87	2.54	11.41	2.56	10.50	2.61	11.51	2.63	12.19	2.64
	29	12.57	3.01	11.85	3.04	11.61	3.05	11.13	3.07	11.71	3.07	12.09	3.07
	32	11.75	3.31	11.57	3.31	11.52	3.31	11.40	3.31	11.77	3.32	12.01	3.32
	35	11.33	3.53	11.41	3.51	11.44	3.50	11.50	3.49	11.75	3.49	11.91	3.49
	40	10.92	3.66	11.10	3.64	11.17	3.63	11.29	3.62	11.54	3.61	11.71	3.61
	43	10.82	3.63	10.88	3.61	10.90	3.60	10.94	3.59	11.32	3.59	11.57	3.59
	46	10.88	3.49	10.66	3.49	10.58	3.49	10.43	3.49	11.03	3.50	11.43	3.50
1.6 + 1.6 + 1.6 + 1.6 + 5.0	22	14.11	1.86	11.97	1.98	11.26	2.01	9.83	2.09	11.28	2.12	12.24	2.14
	25	13.25	2.37	11.87	2.44	11.41	2.46	10.50	2.51	11.51	2.52	12.19	2.53
	29	12.57	2.89	11.85	2.92	11.61	2.92	11.13	2.94	11.71	2.95	12.09	2.95
	32	11.75	3.18	11.57	3.18	11.52	3.18	11.40	3.18	11.77	3.19	12.01	3.19
	35	11.33	3.39	11.41	3.37	11.44	3.36	11.50	3.35	11.75	3.35	11.91	3.35
	40	10.92	3.51	11.10	3.49	11.17	3.49	11.29	3.47	11.54	3.47	11.71	3.47
	43	10.82	3.48	10.88	3.47	10.90	3.46	10.94	3.45	11.32	3.45	11.57	3.45
	46	10.88	3.35	10.66	3.35	10.58	3.35	10.43	3.35	11.03	3.36	11.43	3.36
1.6 + 1.6 + 1.6 + 1.6 + 6.0	22	14.11	1.86	11.97	1.98	11.26	2.01	9.83	2.09	11.28	2.12	12.24	2.14
	25	13.25	2.37	11.87	2.44	11.41	2.46	10.50	2.51	11.51	2.52	12.19	2.53
	29	12.57	2.89	11.85	2.92	11.61	2.92	11.13	2.94	11.71	2.95	12.09	2.95
	32	11.75	3.18	11.57	3.18	11.52	3.18	11.40	3.18	11.77	3.19	12.01	3.19
	35	11.33	3.39	11.41	3.37	11.44	3.36	11.50	3.35	11.75	3.35	11.91	3.35
	40	10.92	3.51	11.10	3.49	11.17	3.49	11.29	3.47	11.54	3.47	11.71	3.47
	43	10.82	3.48	10.88	3.47	10.90	3.46	10.94	3.45	11.32	3.45	11.57	3.45
	46	10.88	3.35	10.66	3.35	10.58	3.35	10.43	3.35	11.03	3.36	11.43	3.36
1.6 + 1.6 + 1.6 + 1.6 + 7.1	22	14.11	1.82	11.97	1.94	11.26	1.97	9.83	2.05	11.28	2.08	12.24	2.10
	25	13.25	2.32	11.87	2.39	11.41	2.41	10.50	2.46	11.51	2.47	12.19	2.48
	29	12.57	2.83	11.85	2.85	11.61	2.86	11.13	2.88	11.71	2.89	12.09	2.89
	32	11.75	3.12	11.57	3.12	11.52	3.12	11.40	3.12	11.77	3.12	12.01	3.12
	35	11.33	3.31	11.41	3.30	11.44	3.29	11.50	3.28	11.75	3.28	11.91	3.28
	40	10.92	3.44	11.10	3.42	11.17	3.41	11.29	3.40	11.54	3.40	11.71	3.39
	43	10.82	3.41	10.88	3.39	10.90	3.39	10.94	3.38	11.32	3.38	11.57	3.38
	46	10.88	3.28	10.66	3.28	10.58	3.28	10.43	3.28	11.03	3.29	11.43	3.29

Combination (Capacity)	Outdoor Air Temp. °C DB	Indoor Air Temp. °C											
		27/16		27/17.5		27/18		27/19		27/22		27/24	
		Total Q	Input Power	Total Q	Input Power	Total Q	Input Power	Total Q	Input Power	Total Q	Input Power	Total Q	Input Power
1.6 + 1.6 + 1.6 + 2.0 + 2.0	22	14.11	1.93	11.97	2.05	11.26	2.09	9.83	2.17	11.28	2.21	12.24	2.23
	25	13.25	2.46	11.87	2.53	11.41	2.56	10.50	2.61	11.51	2.62	12.19	2.63
	29	12.57	3.00	11.85	3.03	11.61	3.04	11.13	3.06	11.71	3.06	12.09	3.07
	32	11.75	3.31	11.57	3.31	11.52	3.31	11.40	3.31	11.77	3.31	12.01	3.31
	35	11.33	3.52	11.41	3.50	11.44	3.49	11.50	3.48	11.75	3.48	11.91	3.48
	40	10.92	3.65	11.10	3.63	11.17	3.62	11.29	3.61	11.54	3.60	11.71	3.60
	43	10.82	3.62	10.88	3.60	10.90	3.59	10.94	3.58	11.32	3.58	11.57	3.58
	46	10.88	3.48	10.66	3.48	10.58	3.48	10.43	3.48	11.03	3.49	11.43	3.49
1.6 + 1.6 + 1.6 + 2.0 + 2.5	22	14.11	1.93	11.97	2.05	11.26	2.09	9.83	2.17	11.28	2.21	12.24	2.23
	25	13.25	2.46	11.87	2.53	11.41	2.56	10.50	2.61	11.51	2.62	12.19	2.63
	29	12.57	3.00	11.85	3.03	11.61	3.04	11.13	3.06	11.71	3.06	12.09	3.07
	32	11.75	3.31	11.57	3.31	11.52	3.31	11.40	3.31	11.77	3.31	12.01	3.31
	35	11.33	3.52	11.41	3.50	11.44	3.49	11.50	3.48	11.75	3.48	11.91	3.48
	40	10.92	3.65	11.10	3.63	11.17	3.62	11.29	3.61	11.54	3.60	11.71	3.60
	43	10.82	3.62	10.88	3.60	10.90	3.59	10.94	3.58	11.32	3.58	11.57	3.58
	46	10.88	3.48	10.66	3.48	10.58	3.48	10.43	3.48	11.03	3.49	11.43	3.49
1.6 + 1.6 + 1.6 + 2.0 + 3.5	22	14.11	1.94	11.97	2.06	11.26	2.10	9.83	2.18	11.28	2.21	12.24	2.23
	25	13.25	2.47	11.87	2.54	11.41	2.56	10.50	2.61	11.51	2.63	12.19	2.64
	29	12.57	3.01	11.85	3.04	11.61	3.05	11.13	3.07	11.71	3.07	12.09	3.07
	32	11.75	3.31	11.57	3.31	11.52	3.31	11.40	3.31	11.77	3.32	12.01	3.32
	35	11.33	3.53	11.41	3.51	11.44	3.50	11.50	3.49	11.75	3.49	11.91	3.49
	40	10.92	3.66	11.10	3.64	11.17	3.63	11.29	3.62	11.54	3.61	11.71	3.61
	43	10.82	3.63	10.88	3.61	10.90	3.60	10.94	3.59	11.32	3.59	11.57	3.59
	46	10.88	3.49	10.66	3.49	10.58	3.49	10.43	3.49	11.03	3.50	11.43	3.50
1.6 + 1.6 + 1.6 + 2.0 + 4.2	22	14.11	1.94	11.97	2.06	11.26	2.10	9.83	2.18	11.28	2.21	12.24	2.23
	25	13.25	2.47	11.87	2.54	11.41	2.56	10.50	2.61	11.51	2.63	12.19	2.64
	29	12.57	3.01	11.85	3.04	11.61	3.05	11.13	3.07	11.71	3.07	12.09	3.07
	32	11.75	3.31	11.57	3.31	11.52	3.31	11.40	3.31	11.77	3.32	12.01	3.32
	35	11.33	3.53	11.41	3.51	11.44	3.50	11.50	3.49	11.75	3.49	11.91	3.49
	40	10.92	3.66	11.10	3.64	11.17	3.63	11.29	3.62	11.54	3.61	11.71	3.61
	43	10.82	3.63	10.88	3.61	10.90	3.60	10.94	3.59	11.32	3.59	11.57	3.59
	46	10.88	3.49	10.66	3.49	10.58	3.49	10.43	3.49	11.03	3.50	11.43	3.50
1.6 + 1.6 + 1.6 + 2.0 + 5.0	22	14.11	1.86	11.97	1.98	11.26	2.01	9.83	2.09	11.28	2.12	12.24	2.14
	25	13.25	2.37	11.87	2.44	11.41	2.46	10.50	2.51	11.51	2.52	12.19	2.53
	29	12.57	2.89	11.85	2.92	11.61	2.92	11.13	2.94	11.71	2.95	12.09	2.95
	32	11.75	3.18	11.57	3.18	11.52	3.18	11.40	3.18	11.77	3.19	12.01	3.19
	35	11.33	3.39	11.41	3.37	11.44	3.36	11.50	3.35	11.75	3.35	11.91	3.35
	40	10.92	3.51	11.10	3.49	11.17	3.49	11.29	3.47	11.54	3.47	11.71	3.47
	43	10.82	3.48	10.88	3.47	10.90	3.46	10.94	3.45	11.32	3.45	11.57	3.45
	46	10.88	3.35	10.66	3.35	10.58	3.35	10.43	3.35	11.03	3.36	11.43	3.36

Combination (Capacity)	Outdoor Air Temp. °C DB	Indoor Air Temp. °C											
		27/16		27/17.5		27/18		27/19		27/22		27/24	
		Total Q	Input Power	Total Q	Input Power	Total Q	Input Power	Total Q	Input Power	Total Q	Input Power	Total Q	Input Power
1.6 + 1.6 + 1.6 + 2.0 + 6.0	22	14.11	1.86	11.97	1.98	11.26	2.01	9.83	2.09	11.28	2.12	12.24	2.14
	25	13.25	2.37	11.87	2.44	11.41	2.46	10.50	2.51	11.51	2.52	12.19	2.53
	29	12.57	2.89	11.85	2.92	11.61	2.92	11.13	2.94	11.71	2.95	12.09	2.95
	32	11.75	3.18	11.57	3.18	11.52	3.18	11.40	3.18	11.77	3.19	12.01	3.19
	35	11.33	3.39	11.41	3.37	11.44	3.36	11.50	3.35	11.75	3.35	11.91	3.35
	40	10.92	3.51	11.10	3.49	11.17	3.49	11.29	3.47	11.54	3.47	11.71	3.47
	43	10.82	3.48	10.88	3.47	10.90	3.46	10.94	3.45	11.32	3.45	11.57	3.45
	46	10.88	3.35	10.66	3.35	10.58	3.35	10.43	3.35	11.03	3.36	11.43	3.36
1.6 + 1.6 + 1.6 + 2.0 + 7.1	22	14.11	1.82	11.97	1.94	11.26	1.97	9.83	2.05	11.28	2.08	12.24	2.10
	25	13.25	2.32	11.87	2.39	11.41	2.41	10.50	2.46	11.51	2.47	12.19	2.48
	29	12.57	2.83	11.85	2.85	11.61	2.86	11.13	2.88	11.71	2.89	12.09	2.89
	32	11.75	3.12	11.57	3.12	11.52	3.12	11.40	3.12	11.77	3.12	12.01	3.12
	35	11.33	3.31	11.41	3.30	11.44	3.29	11.50	3.28	11.75	3.28	11.91	3.28
	40	10.92	3.44	11.10	3.42	11.17	3.41	11.29	3.40	11.54	3.40	11.71	3.39
	43	10.82	3.41	10.88	3.39	10.90	3.39	10.94	3.38	11.32	3.38	11.57	3.38
	46	10.88	3.28	10.66	3.28	10.58	3.28	10.43	3.28	11.03	3.29	11.43	3.29
1.6 + 1.6 + 1.6 + 2.5 + 2.5	22	14.11	1.93	11.97	2.05	11.26	2.09	9.83	2.17	11.28	2.21	12.24	2.23
	25	13.25	2.46	11.87	2.53	11.41	2.56	10.50	2.61	11.51	2.62	12.19	2.63
	29	12.57	3.00	11.85	3.03	11.61	3.04	11.13	3.06	11.71	3.06	12.09	3.07
	32	11.75	3.31	11.57	3.31	11.52	3.31	11.40	3.31	11.77	3.31	12.01	3.31
	35	11.33	3.52	11.41	3.50	11.44	3.49	11.50	3.48	11.75	3.48	11.91	3.48
	40	10.92	3.65	11.10	3.63	11.17	3.62	11.29	3.61	11.54	3.60	11.71	3.60
	43	10.82	3.62	10.88	3.60	10.90	3.59	10.94	3.58	11.32	3.58	11.57	3.58
	46	10.88	3.48	10.66	3.48	10.58	3.48	10.43	3.48	11.03	3.49	11.43	3.49
1.6 + 1.6 + 1.6 + 2.5 + 3.5	22	14.11	1.94	11.97	2.06	11.26	2.10	9.83	2.18	11.28	2.21	12.24	2.23
	25	13.25	2.47	11.87	2.54	11.41	2.56	10.50	2.61	11.51	2.63	12.19	2.64
	29	12.57	3.01	11.85	3.04	11.61	3.05	11.13	3.07	11.71	3.07	12.09	3.07
	32	11.75	3.31	11.57	3.31	11.52	3.31	11.40	3.31	11.77	3.32	12.01	3.32
	35	11.33	3.53	11.41	3.51	11.44	3.50	11.50	3.49	11.75	3.49	11.91	3.49
	40	10.92	3.66	11.10	3.64	11.17	3.63	11.29	3.62	11.54	3.61	11.71	3.61
	43	10.82	3.63	10.88	3.61	10.90	3.60	10.94	3.59	11.32	3.59	11.57	3.59
	46	10.88	3.49	10.66	3.49	10.58	3.49	10.43	3.49	11.03	3.50	11.43	3.50
1.6 + 1.6 + 1.6 + 2.5 + 4.2	22	14.11	1.94	11.97	2.06	11.26	2.10	9.83	2.18	11.28	2.21	12.24	2.23
	25	13.25	2.47	11.87	2.54	11.41	2.56	10.50	2.61	11.51	2.63	12.19	2.64
	29	12.57	3.01	11.85	3.04	11.61	3.05	11.13	3.07	11.71	3.07	12.09	3.07
	32	11.75	3.31	11.57	3.31	11.52	3.31	11.40	3.31	11.77	3.32	12.01	3.32
	35	11.33	3.53	11.41	3.51	11.44	3.50	11.50	3.49	11.75	3.49	11.91	3.49
	40	10.92	3.66	11.10	3.64	11.17	3.63	11.29	3.62	11.54	3.61	11.71	3.61
	43	10.82	3.63	10.88	3.61	10.90	3.60	10.94	3.59	11.32	3.59	11.57	3.59
	46	10.88	3.49	10.66	3.49	10.58	3.49	10.43	3.49	11.03	3.50	11.43	3.50

Combination (Capacity)	Outdoor Air Temp. °C DB	Indoor Air Temp. °C											
		27/16		27/17.5		27/18		27/19		27/22		27/24	
		Total Q	Input Power	Total Q	Input Power	Total Q	Input Power	Total Q	Input Power	Total Q	Input Power	Total Q	Input Power
1.6 + 1.6 + 1.6 + 2.5 + 5.0	22	14.11	1.86	11.97	1.98	11.26	2.01	9.83	2.09	11.28	2.12	12.24	2.14
	25	13.25	2.37	11.87	2.44	11.41	2.46	10.50	2.51	11.51	2.52	12.19	2.53
	29	12.57	2.89	11.85	2.92	11.61	2.92	11.13	2.94	11.71	2.95	12.09	2.95
	32	11.75	3.18	11.57	3.18	11.52	3.18	11.40	3.18	11.77	3.19	12.01	3.19
	35	11.33	3.39	11.41	3.37	11.44	3.36	11.50	3.35	11.75	3.35	11.91	3.35
	40	10.92	3.51	11.10	3.49	11.17	3.49	11.29	3.47	11.54	3.47	11.71	3.47
	43	10.82	3.48	10.88	3.47	10.90	3.46	10.94	3.45	11.32	3.45	11.57	3.45
	46	10.88	3.35	10.66	3.35	10.58	3.35	10.43	3.35	11.03	3.36	11.43	3.36
1.6 + 1.6 + 1.6 + 2.5 + 6.0	22	14.11	1.86	11.97	1.98	11.26	2.01	9.83	2.09	11.28	2.12	12.24	2.14
	25	13.25	2.37	11.87	2.44	11.41	2.46	10.50	2.51	11.51	2.52	12.19	2.53
	29	12.57	2.89	11.85	2.92	11.61	2.92	11.13	2.94	11.71	2.95	12.09	2.95
	32	11.75	3.18	11.57	3.18	11.52	3.18	11.40	3.18	11.77	3.19	12.01	3.19
	35	11.33	3.39	11.41	3.37	11.44	3.36	11.50	3.35	11.75	3.35	11.91	3.35
	40	10.92	3.51	11.10	3.49	11.17	3.49	11.29	3.47	11.54	3.47	11.71	3.47
	43	10.82	3.48	10.88	3.47	10.90	3.46	10.94	3.45	11.32	3.45	11.57	3.45
	46	10.88	3.35	10.66	3.35	10.58	3.35	10.43	3.35	11.03	3.36	11.43	3.36
1.6 + 1.6 + 1.6 + 2.5 + 7.1	22	14.11	1.82	11.97	1.94	11.26	1.97	9.83	2.05	11.28	2.08	12.24	2.10
	25	13.25	2.32	11.87	2.39	11.41	2.41	10.50	2.46	11.51	2.47	12.19	2.48
	29	12.57	2.83	11.85	2.85	11.61	2.86	11.13	2.88	11.71	2.89	12.09	2.89
	32	11.75	3.12	11.57	3.12	11.52	3.12	11.40	3.12	11.77	3.12	12.01	3.12
	35	11.33	3.31	11.41	3.30	11.44	3.29	11.50	3.28	11.75	3.28	11.91	3.28
	40	10.92	3.44	11.10	3.42	11.17	3.41	11.29	3.40	11.54	3.40	11.71	3.39
	43	10.82	3.41	10.88	3.39	10.90	3.39	10.94	3.38	11.32	3.38	11.57	3.38
	46	10.88	3.28	10.66	3.28	10.58	3.28	10.43	3.28	11.03	3.29	11.43	3.29
1.6 + 1.6 + 1.6 + 3.5 + 3.5	22	14.11	1.89	11.97	2.01	11.26	2.05	9.83	2.13	11.28	2.16	12.24	2.18
	25	13.25	2.41	11.87	2.48	11.41	2.50	10.50	2.55	11.51	2.57	12.19	2.58
	29	12.57	2.94	11.85	2.97	11.61	2.98	11.13	3.00	11.71	3.00	12.09	3.00
	32	11.75	3.24	11.57	3.24	11.52	3.24	11.40	3.24	11.77	3.24	12.01	3.25
	35	11.33	3.45	11.41	3.43	11.44	3.42	11.50	3.41	11.75	3.41	11.91	3.41
	40	10.92	3.57	11.10	3.55	11.17	3.55	11.29	3.54	11.54	3.53	11.71	3.53
	43	10.82	3.55	10.88	3.53	10.90	3.52	10.94	3.51	11.32	3.51	11.57	3.51
	46	10.88	3.41	10.66	3.41	10.58	3.41	10.43	3.41	11.03	3.42	11.43	3.42
1.6 + 1.6 + 1.6 + 3.5 + 4.2	22	14.11	1.89	11.97	2.01	11.26	2.05	9.83	2.13	11.28	2.16	12.24	2.18
	25	13.25	2.41	11.87	2.48	11.41	2.50	10.50	2.55	11.51	2.57	12.19	2.58
	29	12.57	2.94	11.85	2.97	11.61	2.98	11.13	3.00	11.71	3.00	12.09	3.00
	32	11.75	3.24	11.57	3.24	11.52	3.24	11.40	3.24	11.77	3.24	12.01	3.25
	35	11.33	3.45	11.41	3.43	11.44	3.42	11.50	3.41	11.75	3.41	11.91	3.41
	40	10.92	3.57	11.10	3.55	11.17	3.55	11.29	3.54	11.54	3.53	11.71	3.53
	43	10.82	3.55	10.88	3.53	10.90	3.52	10.94	3.51	11.32	3.51	11.57	3.51
	46	10.88	3.41	10.66	3.41	10.58	3.41	10.43	3.41	11.03	3.42	11.43	3.42

Combination (Capacity)	Outdoor Air Temp. °C DB	Indoor Air Temp. °C											
		27/16		27/17.5		27/18		27/19		27/22		27/24	
		Total Q	Input Power	Total Q	Input Power	Total Q	Input Power	Total Q	Input Power	Total Q	Input Power	Total Q	Input Power
1.6 + 1.6 + 1.6 + 3.5 + 5.0	22	14.11	1.82	11.97	1.94	11.26	1.97	9.83	2.05	11.28	2.08	12.24	2.10
	25	13.25	2.32	11.87	2.39	11.41	2.41	10.50	2.46	11.51	2.47	12.19	2.48
	29	12.57	2.83	11.85	2.85	11.61	2.86	11.13	2.88	11.71	2.89	12.09	2.89
	32	11.75	3.12	11.57	3.12	11.52	3.12	11.40	3.12	11.77	3.12	12.01	3.12
	35	11.33	3.31	11.41	3.30	11.44	3.29	11.50	3.28	11.75	3.28	11.91	3.28
	40	10.92	3.44	11.10	3.42	11.17	3.41	11.29	3.40	11.54	3.40	11.71	3.39
	43	10.82	3.41	10.88	3.39	10.90	3.39	10.94	3.38	11.32	3.38	11.57	3.38
	46	10.88	3.28	10.66	3.28	10.58	3.28	10.43	3.28	11.03	3.29	11.43	3.29
1.6 + 1.6 + 1.6 + 3.5 + 6.0	22	14.11	1.82	11.97	1.94	11.26	1.97	9.83	2.05	11.28	2.08	12.24	2.10
	25	13.25	2.32	11.87	2.39	11.41	2.41	10.50	2.46	11.51	2.47	12.19	2.48
	29	12.57	2.83	11.85	2.85	11.61	2.86	11.13	2.88	11.71	2.89	12.09	2.89
	32	11.75	3.12	11.57	3.12	11.52	3.12	11.40	3.12	11.77	3.12	12.01	3.12
	35	11.33	3.31	11.41	3.30	11.44	3.29	11.50	3.28	11.75	3.28	11.91	3.28
	40	10.92	3.44	11.10	3.42	11.17	3.41	11.29	3.40	11.54	3.40	11.71	3.39
	43	10.82	3.41	10.88	3.39	10.90	3.39	10.94	3.38	11.32	3.38	11.57	3.38
	46	10.88	3.28	10.66	3.28	10.58	3.28	10.43	3.28	11.03	3.29	11.43	3.29
1.6 + 1.6 + 1.6 + 3.5 + 7.1	22	14.11	1.82	11.97	1.94	11.26	1.97	9.83	2.05	11.28	2.08	12.24	2.10
	25	13.25	2.32	11.87	2.39	11.41	2.41	10.50	2.46	11.51	2.47	12.19	2.48
	29	12.57	2.83	11.85	2.85	11.61	2.86	11.13	2.88	11.71	2.89	12.09	2.89
	32	11.75	3.12	11.57	3.12	11.52	3.12	11.40	3.12	11.77	3.12	12.01	3.12
	35	11.33	3.31	11.41	3.30	11.44	3.29	11.50	3.28	11.75	3.28	11.91	3.28
	40	10.92	3.44	11.10	3.42	11.17	3.41	11.29	3.40	11.54	3.40	11.71	3.39
	43	10.82	3.41	10.88	3.39	10.90	3.39	10.94	3.38	11.32	3.38	11.57	3.38
	46	10.88	3.28	10.66	3.28	10.58	3.28	10.43	3.28	11.03	3.29	11.43	3.29
1.6 + 1.6 + 1.6 + 4.2 + 4.2	22	14.11	1.89	11.97	2.01	11.26	2.05	9.83	2.13	11.28	2.16	12.24	2.18
	25	13.25	2.41	11.87	2.48	11.41	2.50	10.50	2.55	11.51	2.57	12.19	2.58
	29	12.57	2.94	11.85	2.97	11.61	2.98	11.13	3.00	11.71	3.00	12.09	3.00
	32	11.75	3.24	11.57	3.24	11.52	3.24	11.40	3.24	11.77	3.24	12.01	3.25
	35	11.33	3.45	11.41	3.43	11.44	3.42	11.50	3.41	11.75	3.41	11.91	3.41
	40	10.92	3.57	11.10	3.55	11.17	3.55	11.29	3.54	11.54	3.53	11.71	3.53
	43	10.82	3.55	10.88	3.53	10.90	3.52	10.94	3.51	11.32	3.51	11.57	3.51
	46	10.88	3.41	10.66	3.41	10.58	3.41	10.43	3.41	11.03	3.42	11.43	3.42
1.6 + 1.6 + 1.6 + 4.2 + 5.0	22	14.11	1.82	11.97	1.94	11.26	1.97	9.83	2.05	11.28	2.08	12.24	2.10
	25	13.25	2.32	11.87	2.39	11.41	2.41	10.50	2.46	11.51	2.47	12.19	2.48
	29	12.57	2.83	11.85	2.85	11.61	2.86	11.13	2.88	11.71	2.89	12.09	2.89
	32	11.75	3.12	11.57	3.12	11.52	3.12	11.40	3.12	11.77	3.12	12.01	3.12
	35	11.33	3.31	11.41	3.30	11.44	3.29	11.50	3.28	11.75	3.28	11.91	3.28
	40	10.92	3.44	11.10	3.42	11.17	3.41	11.29	3.40	11.54	3.40	11.71	3.39
	43	10.82	3.41	10.88	3.39	10.90	3.39	10.94	3.38	11.32	3.38	11.57	3.38
	46	10.88	3.28	10.66	3.28	10.58	3.28	10.43	3.28	11.03	3.29	11.43	3.29

Combination (Capacity)	Outdoor Air Temp. °C DB	Indoor Air Temp. °C											
		27/16		27/17.5		27/18		27/19		27/22		27/24	
		Total Q	Input Power	Total Q	Input Power	Total Q	Input Power	Total Q	Input Power	Total Q	Input Power	Total Q	Input Power
1.6 + 1.6 + 1.6 + 4.2 + 6.0	22	14.11	1.82	11.97	1.94	11.26	1.97	9.83	2.05	11.28	2.08	12.24	2.10
	25	13.25	2.32	11.87	2.39	11.41	2.41	10.50	2.46	11.51	2.47	12.19	2.48
	29	12.57	2.83	11.85	2.85	11.61	2.86	11.13	2.88	11.71	2.89	12.09	2.89
	32	11.75	3.12	11.57	3.12	11.52	3.12	11.40	3.12	11.77	3.12	12.01	3.12
	35	11.33	3.31	11.41	3.30	11.44	3.29	11.50	3.28	11.75	3.28	11.91	3.28
	40	10.92	3.44	11.10	3.42	11.17	3.41	11.29	3.40	11.54	3.40	11.71	3.39
	43	10.82	3.41	10.88	3.39	10.90	3.39	10.94	3.38	11.32	3.38	11.57	3.38
	46	10.88	3.28	10.66	3.28	10.58	3.28	10.43	3.28	11.03	3.29	11.43	3.29
1.6 + 1.6 + 1.6 + 4.2 + 7.1	22	14.11	1.83	11.97	1.94	11.26	1.98	9.83	2.05	11.28	2.09	12.24	2.11
	25	13.25	2.32	11.87	2.39	11.41	2.42	10.50	2.46	11.51	2.48	12.19	2.49
	29	12.57	2.84	11.85	2.86	11.61	2.87	11.13	2.89	11.71	2.89	12.09	2.90
	32	11.75	3.12	11.57	3.12	11.52	3.12	11.40	3.12	11.77	3.13	12.01	3.13
	35	11.33	3.32	11.41	3.31	11.44	3.30	11.50	3.29	11.75	3.29	11.91	3.29
	40	10.92	3.45	11.10	3.43	11.17	3.42	11.29	3.41	11.54	3.41	11.71	3.40
	43	10.82	3.42	10.88	3.40	10.90	3.40	10.94	3.39	11.32	3.39	11.57	3.39
	46	10.88	3.29	10.66	3.29	10.58	3.29	10.43	3.29	11.03	3.30	11.43	3.30
1.6 + 1.6 + 1.6 + 5.0 + 5.0	22	14.11	1.79	11.97	1.91	11.26	1.94	9.83	2.02	11.28	2.05	12.24	2.07
	25	13.25	2.28	11.87	2.35	11.41	2.37	10.50	2.42	11.51	2.43	12.19	2.44
	29	12.57	2.79	11.85	2.81	11.61	2.82	11.13	2.84	11.71	2.84	12.09	2.85
	32	11.75	3.07	11.57	3.07	11.52	3.07	11.40	3.07	11.77	3.07	12.01	3.08
	35	11.33	3.26	11.41	3.25	11.44	3.24	11.50	3.23	11.75	3.23	11.91	3.23
	40	10.92	3.38	11.10	3.37	11.17	3.36	11.29	3.35	11.54	3.34	11.71	3.34
	43	10.82	3.36	10.88	3.34	10.90	3.34	10.94	3.32	11.32	3.32	11.57	3.32
	46	10.88	3.23	10.66	3.23	10.58	3.23	10.43	3.23	11.03	3.24	11.43	3.24
1.6 + 1.6 + 1.6 + 5.0 + 6.0	22	14.11	1.79	11.97	1.91	11.26	1.94	9.83	2.02	11.28	2.05	12.24	2.07
	25	13.25	2.28	11.87	2.35	11.41	2.37	10.50	2.42	11.51	2.43	12.19	2.44
	29	12.57	2.79	11.85	2.81	11.61	2.82	11.13	2.84	11.71	2.84	12.09	2.85
	32	11.75	3.07	11.57	3.07	11.52	3.07	11.40	3.07	11.77	3.07	12.01	3.08
	35	11.33	3.26	11.41	3.25	11.44	3.24	11.50	3.23	11.75	3.23	11.91	3.23
	40	10.92	3.38	11.10	3.37	11.17	3.36	11.29	3.35	11.54	3.34	11.71	3.34
	43	10.82	3.36	10.88	3.34	10.90	3.34	10.94	3.32	11.32	3.32	11.57	3.32
	46	10.88	3.23	10.66	3.23	10.58	3.23	10.43	3.23	11.03	3.24	11.43	3.24
1.6 + 1.6 + 1.6 + 5.0 + 7.1	22	14.11	1.80	11.97	1.91	11.26	1.95	9.83	2.02	11.28	2.05	12.24	2.07
	25	13.25	2.29	11.87	2.36	11.41	2.38	10.50	2.43	11.51	2.44	12.19	2.45
	29	12.57	2.79	11.85	2.82	11.61	2.83	11.13	2.85	11.71	2.85	12.09	2.85
	32	11.75	3.08	11.57	3.08	11.52	3.08	11.40	3.08	11.77	3.08	12.01	3.09
	35	11.33	3.27	11.41	3.26	11.44	3.25	11.50	3.24	11.75	3.24	11.91	3.24
	40	10.92	3.39	11.10	3.38	11.17	3.37	11.29	3.36	11.54	3.35	11.71	3.35
	43	10.82	3.37	10.88	3.35	10.90	3.35	10.94	3.33	11.32	3.33	11.57	3.33
	46	10.88	3.24	10.66	3.24	10.58	3.24	10.43	3.24	11.03	3.25	11.43	3.25

Combination (Capacity)	Outdoor Air Temp. °C DB	Indoor Air Temp. °C											
		27/16		27/17.5		27/18		27/19		27/22		27/24	
		Total Q	Input Power	Total Q	Input Power	Total Q	Input Power	Total Q	Input Power	Total Q	Input Power	Total Q	Input Power
1.6 + 1.6 + 1.6 + 6.0 + 6.0	22	14.11	1.79	11.97	1.91	11.26	1.94	9.83	2.02	11.28	2.05	12.24	2.07
	25	13.25	2.28	11.87	2.35	11.41	2.37	10.50	2.42	11.51	2.43	12.19	2.44
	29	12.57	2.79	11.85	2.81	11.61	2.82	11.13	2.84	11.71	2.84	12.09	2.85
	32	11.75	3.07	11.57	3.07	11.52	3.07	11.40	3.07	11.77	3.07	12.01	3.08
	35	11.33	3.26	11.41	3.25	11.44	3.24	11.50	3.23	11.75	3.23	11.91	3.23
	40	10.92	3.38	11.10	3.37	11.17	3.36	11.29	3.35	11.54	3.34	11.71	3.34
	43	10.82	3.36	10.88	3.34	10.90	3.34	10.94	3.32	11.32	3.32	11.57	3.32
	46	10.88	3.23	10.66	3.23	10.58	3.23	10.43	3.23	11.03	3.24	11.43	3.24
1.6 + 1.6 + 1.6 + 6.0 + 7.1	22	14.11	1.80	11.97	1.91	11.26	1.95	9.83	2.02	11.28	2.05	12.24	2.07
	25	13.25	2.29	11.87	2.36	11.41	2.38	10.50	2.43	11.51	2.44	12.19	2.45
	29	12.57	2.79	11.85	2.82	11.61	2.83	11.13	2.85	11.71	2.85	12.09	2.85
	32	11.75	3.08	11.57	3.08	11.52	3.08	11.40	3.08	11.77	3.08	12.01	3.09
	35	11.33	3.27	11.41	3.26	11.44	3.25	11.50	3.24	11.75	3.24	11.91	3.24
	40	10.92	3.39	11.10	3.38	11.17	3.37	11.29	3.36	11.54	3.35	11.71	3.35
	43	10.82	3.37	10.88	3.35	10.90	3.35	10.94	3.33	11.32	3.33	11.57	3.33
	46	10.88	3.24	10.66	3.24	10.58	3.24	10.43	3.24	11.03	3.25	11.43	3.25
1.6 + 1.6 + 2.0 + 2.0 + 2.0	22	14.11	1.94	11.97	2.06	11.26	2.10	9.83	2.18	11.28	2.21	12.24	2.23
	25	13.25	2.47	11.87	2.54	11.41	2.56	10.50	2.61	11.51	2.63	12.19	2.64
	29	12.57	3.01	11.85	3.04	11.61	3.05	11.13	3.07	11.71	3.07	12.09	3.07
	32	11.75	3.31	11.57	3.31	11.52	3.31	11.40	3.31	11.77	3.32	12.01	3.32
	35	11.33	3.53	11.41	3.51	11.44	3.50	11.50	3.49	11.75	3.49	11.91	3.49
	40	10.92	3.66	11.10	3.64	11.17	3.63	11.29	3.62	11.54	3.61	11.71	3.61
	43	10.82	3.63	10.88	3.61	10.90	3.60	10.94	3.59	11.32	3.59	11.57	3.59
	46	10.88	3.49	10.66	3.49	10.58	3.49	10.43	3.49	11.03	3.50	11.43	3.50
1.6 + 1.6 + 2.0 + 2.0 + 2.5	22	14.11	1.94	11.97	2.06	11.26	2.10	9.83	2.18	11.28	2.21	12.24	2.23
	25	13.25	2.47	11.87	2.54	11.41	2.56	10.50	2.61	11.51	2.63	12.19	2.64
	29	12.57	3.01	11.85	3.04	11.61	3.05	11.13	3.07	11.71	3.07	12.09	3.07
	32	11.75	3.31	11.57	3.31	11.52	3.31	11.40	3.31	11.77	3.32	12.01	3.32
	35	11.33	3.53	11.41	3.51	11.44	3.50	11.50	3.49	11.75	3.49	11.91	3.49
	40	10.92	3.66	11.10	3.64	11.17	3.63	11.29	3.62	11.54	3.61	11.71	3.61
	43	10.82	3.63	10.88	3.61	10.90	3.60	10.94	3.59	11.32	3.59	11.57	3.59
	46	10.88	3.49	10.66	3.49	10.58	3.49	10.43	3.49	11.03	3.50	11.43	3.50
1.6 + 1.6 + 2.0 + 2.0 + 3.5	22	14.11	1.94	11.97	2.06	11.26	2.10	9.83	2.18	11.28	2.21	12.24	2.23
	25	13.25	2.47	11.87	2.54	11.41	2.56	10.50	2.61	11.51	2.63	12.19	2.64
	29	12.57	3.01	11.85	3.04	11.61	3.05	11.13	3.07	11.71	3.07	12.09	3.07
	32	11.75	3.31	11.57	3.31	11.52	3.31	11.40	3.31	11.77	3.32	12.01	3.32
	35	11.33	3.53	11.41	3.51	11.44	3.50	11.50	3.49	11.75	3.49	11.91	3.49
	40	10.92	3.66	11.10	3.64	11.17	3.63	11.29	3.62	11.54	3.61	11.71	3.61
	43	10.82	3.63	10.88	3.61	10.90	3.60	10.94	3.59	11.32	3.59	11.57	3.59
	46	10.88	3.49	10.66	3.49	10.58	3.49	10.43	3.49	11.03	3.50	11.43	3.50

Combination (Capacity)	Outdoor Air Temp. °C DB	Indoor Air Temp. °C											
		27/16		27/17.5		27/18		27/19		27/22		27/24	
		Total Q	Input Power	Total Q	Input Power	Total Q	Input Power	Total Q	Input Power	Total Q	Input Power	Total Q	Input Power
1.6 + 1.6 + 2.0 + 2.0 + 4.2	22	14.11	1.89	11.97	2.01	11.26	2.05	9.83	2.13	11.28	2.16	12.24	2.18
	25	13.25	2.41	11.87	2.48	11.41	2.50	10.50	2.55	11.51	2.57	12.19	2.58
	29	12.57	2.94	11.85	2.97	11.61	2.98	11.13	3.00	11.71	3.00	12.09	3.00
	32	11.75	3.24	11.57	3.24	11.52	3.24	11.40	3.24	11.77	3.24	12.01	3.25
	35	11.33	3.45	11.41	3.43	11.44	3.42	11.50	3.41	11.75	3.41	11.91	3.41
	40	10.92	3.57	11.10	3.55	11.17	3.55	11.29	3.54	11.54	3.53	11.71	3.53
	43	10.82	3.55	10.88	3.53	10.90	3.52	10.94	3.51	11.32	3.51	11.57	3.51
	46	10.88	3.41	10.66	3.41	10.58	3.41	10.43	3.41	11.03	3.42	11.43	3.42
1.6 + 1.6 + 2.0 + 2.0 + 5.0	22	14.11	1.82	11.97	1.94	11.26	1.97	9.83	2.05	11.28	2.08	12.24	2.10
	25	13.25	2.32	11.87	2.39	11.41	2.41	10.50	2.46	11.51	2.47	12.19	2.48
	29	12.57	2.83	11.85	2.85	11.61	2.86	11.13	2.88	11.71	2.89	12.09	2.89
	32	11.75	3.12	11.57	3.12	11.52	3.12	11.40	3.12	11.77	3.12	12.01	3.12
	35	11.33	3.31	11.41	3.30	11.44	3.29	11.50	3.28	11.75	3.28	11.91	3.28
	40	10.92	3.44	11.10	3.42	11.17	3.41	11.29	3.40	11.54	3.40	11.71	3.39
	43	10.82	3.41	10.88	3.39	10.90	3.39	10.94	3.38	11.32	3.38	11.57	3.38
	46	10.88	3.28	10.66	3.28	10.58	3.28	10.43	3.28	11.03	3.29	11.43	3.29
1.6 + 1.6 + 2.0 + 2.0 + 6.0	22	14.11	1.82	11.97	1.94	11.26	1.97	9.83	2.05	11.28	2.08	12.24	2.10
	25	13.25	2.32	11.87	2.39	11.41	2.41	10.50	2.46	11.51	2.47	12.19	2.48
	29	12.57	2.83	11.85	2.85	11.61	2.86	11.13	2.88	11.71	2.89	12.09	2.89
	32	11.75	3.12	11.57	3.12	11.52	3.12	11.40	3.12	11.77	3.12	12.01	3.12
	35	11.33	3.31	11.41	3.30	11.44	3.29	11.50	3.28	11.75	3.28	11.91	3.28
	40	10.92	3.44	11.10	3.42	11.17	3.41	11.29	3.40	11.54	3.40	11.71	3.39
	43	10.82	3.41	10.88	3.39	10.90	3.39	10.94	3.38	11.32	3.38	11.57	3.38
	46	10.88	3.28	10.66	3.28	10.58	3.28	10.43	3.28	11.03	3.29	11.43	3.29
1.6 + 1.6 + 2.0 + 2.0 + 7.1	22	14.11	1.82	11.97	1.94	11.26	1.97	9.83	2.05	11.28	2.08	12.24	2.10
	25	13.25	2.32	11.87	2.39	11.41	2.41	10.50	2.46	11.51	2.47	12.19	2.48
	29	12.57	2.83	11.85	2.85	11.61	2.86	11.13	2.88	11.71	2.89	12.09	2.89
	32	11.75	3.12	11.57	3.12	11.52	3.12	11.40	3.12	11.77	3.12	12.01	3.12
	35	11.33	3.31	11.41	3.30	11.44	3.29	11.50	3.28	11.75	3.28	11.91	3.28
	40	10.92	3.44	11.10	3.42	11.17	3.41	11.29	3.40	11.54	3.40	11.71	3.39
	43	10.82	3.41	10.88	3.39	10.90	3.39	10.94	3.38	11.32	3.38	11.57	3.38
	46	10.88	3.28	10.66	3.28	10.58	3.28	10.43	3.28	11.03	3.29	11.43	3.29
1.6 + 1.6 + 2.0 + 2.5 + 2.5	22	14.11	1.94	11.97	2.06	11.26	2.10	9.83	2.18	11.28	2.21	12.24	2.23
	25	13.25	2.47	11.87	2.54	11.41	2.56	10.50	2.61	11.51	2.63	12.19	2.64
	29	12.57	3.01	11.85	3.04	11.61	3.05	11.13	3.07	11.71	3.07	12.09	3.07
	32	11.75	3.31	11.57	3.31	11.52	3.31	11.40	3.31	11.77	3.32	12.01	3.32
	35	11.33	3.53	11.41	3.51	11.44	3.50	11.50	3.49	11.75	3.49	11.91	3.49
	40	10.92	3.66	11.10	3.64	11.17	3.63	11.29	3.62	11.54	3.61	11.71	3.61
	43	10.82	3.63	10.88	3.61	10.90	3.60	10.94	3.59	11.32	3.59	11.57	3.59
	46	10.88	3.49	10.66	3.49	10.58	3.49	10.43	3.49	11.03	3.50	11.43	3.50



Combination (Capacity)	Outdoor Air Temp. °C DB	Indoor Air Temp. °C											
		27/16		27/17.5		27/18		27/19		27/22		27/24	
		Total Q	Input Power	Total Q	Input Power	Total Q	Input Power	Total Q	Input Power	Total Q	Input Power	Total Q	Input Power
1.6 + 1.6 + 2.0 + 2.5 + 3.5	22	14.11	1.94	11.97	2.06	11.26	2.10	9.83	2.18	11.28	2.21	12.24	2.23
	25	13.25	2.47	11.87	2.54	11.41	2.56	10.50	2.61	11.51	2.63	12.19	2.64
	29	12.57	3.01	11.85	3.04	11.61	3.05	11.13	3.07	11.71	3.07	12.09	3.07
	32	11.75	3.31	11.57	3.31	11.52	3.31	11.40	3.31	11.77	3.32	12.01	3.32
	35	11.33	3.53	11.41	3.51	11.44	3.50	11.50	3.49	11.75	3.49	11.91	3.49
	40	10.92	3.66	11.10	3.64	11.17	3.63	11.29	3.62	11.54	3.61	11.71	3.61
	43	10.82	3.63	10.88	3.61	10.90	3.60	10.94	3.59	11.32	3.59	11.57	3.59
	46	10.88	3.49	10.66	3.49	10.58	3.49	10.43	3.49	11.03	3.50	11.43	3.50
1.6 + 1.6 + 2.0 + 2.5 + 4.2	22	14.11	1.89	11.97	2.01	11.26	2.05	9.83	2.13	11.28	2.16	12.24	2.18
	25	13.25	2.41	11.87	2.48	11.41	2.50	10.50	2.55	11.51	2.57	12.19	2.58
	29	12.57	2.94	11.85	2.97	11.61	2.98	11.13	3.00	11.71	3.00	12.09	3.00
	32	11.75	3.24	11.57	3.24	11.52	3.24	11.40	3.24	11.77	3.24	12.01	3.25
	35	11.33	3.45	11.41	3.43	11.44	3.42	11.50	3.41	11.75	3.41	11.91	3.41
	40	10.92	3.57	11.10	3.55	11.17	3.55	11.29	3.54	11.54	3.53	11.71	3.53
	43	10.82	3.55	10.88	3.53	10.90	3.52	10.94	3.51	11.32	3.51	11.57	3.51
	46	10.88	3.41	10.66	3.41	10.58	3.41	10.43	3.41	11.03	3.42	11.43	3.42
1.6 + 1.6 + 2.0 + 2.5 + 5.0	22	14.11	1.82	11.97	1.94	11.26	1.97	9.83	2.05	11.28	2.08	12.24	2.10
	25	13.25	2.32	11.87	2.39	11.41	2.41	10.50	2.46	11.51	2.47	12.19	2.48
	29	12.57	2.83	11.85	2.85	11.61	2.86	11.13	2.88	11.71	2.89	12.09	2.89
	32	11.75	3.12	11.57	3.12	11.52	3.12	11.40	3.12	11.77	3.12	12.01	3.12
	35	11.33	3.31	11.41	3.30	11.44	3.29	11.50	3.28	11.75	3.28	11.91	3.28
	40	10.92	3.44	11.10	3.42	11.17	3.41	11.29	3.40	11.54	3.40	11.71	3.39
	43	10.82	3.41	10.88	3.39	10.90	3.39	10.94	3.38	11.32	3.38	11.57	3.38
	46	10.88	3.28	10.66	3.28	10.58	3.28	10.43	3.28	11.03	3.29	11.43	3.29
1.6 + 1.6 + 2.0 + 2.5 + 6.0	22	14.11	1.82	11.97	1.94	11.26	1.97	9.83	2.05	11.28	2.08	12.24	2.10
	25	13.25	2.32	11.87	2.39	11.41	2.41	10.50	2.46	11.51	2.47	12.19	2.48
	29	12.57	2.83	11.85	2.85	11.61	2.86	11.13	2.88	11.71	2.89	12.09	2.89
	32	11.75	3.12	11.57	3.12	11.52	3.12	11.40	3.12	11.77	3.12	12.01	3.12
	35	11.33	3.31	11.41	3.30	11.44	3.29	11.50	3.28	11.75	3.28	11.91	3.28
	40	10.92	3.44	11.10	3.42	11.17	3.41	11.29	3.40	11.54	3.40	11.71	3.39
	43	10.82	3.41	10.88	3.39	10.90	3.39	10.94	3.38	11.32	3.38	11.57	3.38
	46	10.88	3.28	10.66	3.28	10.58	3.28	10.43	3.28	11.03	3.29	11.43	3.29
1.6 + 1.6 + 2.0 + 2.5 + 7.1	22	14.11	1.82	11.97	1.94	11.26	1.97	9.83	2.05	11.28	2.08	12.24	2.10
	25	13.25	2.32	11.87	2.39	11.41	2.41	10.50	2.46	11.51	2.47	12.19	2.48
	29	12.57	2.83	11.85	2.85	11.61	2.86	11.13	2.88	11.71	2.89	12.09	2.89
	32	11.75	3.12	11.57	3.12	11.52	3.12	11.40	3.12	11.77	3.12	12.01	3.12
	35	11.33	3.31	11.41	3.30	11.44	3.29	11.50	3.28	11.75	3.28	11.91	3.28
	40	10.92	3.44	11.10	3.42	11.17	3.41	11.29	3.40	11.54	3.40	11.71	3.39
	43	10.82	3.41	10.88	3.39	10.90	3.39	10.94	3.38	11.32	3.38	11.57	3.38
	46	10.88	3.28	10.66	3.28	10.58	3.28	10.43	3.28	11.03	3.29	11.43	3.29

Combination (Capacity)	Outdoor Air Temp. °C DB	Indoor Air Temp. °C											
		27/16		27/17.5		27/18		27/19		27/22		27/24	
		Total Q	Input Power	Total Q	Input Power	Total Q	Input Power	Total Q	Input Power	Total Q	Input Power	Total Q	Input Power
1.6 + 1.6 + 2.0 + 3.5 + 3.5	22	14.11	1.89	11.97	2.01	11.26	2.05	9.83	2.13	11.28	2.16	12.24	2.18
	25	13.25	2.41	11.87	2.48	11.41	2.50	10.50	2.55	11.51	2.57	12.19	2.58
	29	12.57	2.94	11.85	2.97	11.61	2.98	11.13	3.00	11.71	3.00	12.09	3.00
	32	11.75	3.24	11.57	3.24	11.52	3.24	11.40	3.24	11.77	3.24	12.01	3.25
	35	11.33	3.45	11.41	3.43	11.44	3.42	11.50	3.41	11.75	3.41	11.91	3.41
	40	10.92	3.57	11.10	3.55	11.17	3.55	11.29	3.54	11.54	3.53	11.71	3.53
	43	10.82	3.55	10.88	3.53	10.90	3.52	10.94	3.51	11.32	3.51	11.57	3.51
	46	10.88	3.41	10.66	3.41	10.58	3.41	10.43	3.41	11.03	3.42	11.43	3.42
1.6 + 1.6 + 2.0 + 3.5 + 4.2	22	14.11	1.89	11.97	2.01	11.26	2.05	9.83	2.13	11.28	2.16	12.24	2.18
	25	13.25	2.41	11.87	2.48	11.41	2.50	10.50	2.55	11.51	2.57	12.19	2.58
	29	12.57	2.94	11.85	2.97	11.61	2.98	11.13	3.00	11.71	3.00	12.09	3.00
	32	11.75	3.24	11.57	3.24	11.52	3.24	11.40	3.24	11.77	3.24	12.01	3.25
	35	11.33	3.45	11.41	3.43	11.44	3.42	11.50	3.41	11.75	3.41	11.91	3.41
	40	10.92	3.57	11.10	3.55	11.17	3.55	11.29	3.54	11.54	3.53	11.71	3.53
	43	10.82	3.55	10.88	3.53	10.90	3.52	10.94	3.51	11.32	3.51	11.57	3.51
	46	10.88	3.41	10.66	3.41	10.58	3.41	10.43	3.41	11.03	3.42	11.43	3.42
1.6 + 1.6 + 2.0 + 3.5 + 5.0	22	14.11	1.82	11.97	1.94	11.26	1.97	9.83	2.05	11.28	2.08	12.24	2.10
	25	13.25	2.32	11.87	2.39	11.41	2.41	10.50	2.46	11.51	2.47	12.19	2.48
	29	12.57	2.83	11.85	2.85	11.61	2.86	11.13	2.88	11.71	2.89	12.09	2.89
	32	11.75	3.12	11.57	3.12	11.52	3.12	11.40	3.12	11.77	3.12	12.01	3.12
	35	11.33	3.31	11.41	3.30	11.44	3.29	11.50	3.28	11.75	3.28	11.91	3.28
	40	10.92	3.44	11.10	3.42	11.17	3.41	11.29	3.40	11.54	3.40	11.71	3.39
	43	10.82	3.41	10.88	3.39	10.90	3.39	10.94	3.38	11.32	3.38	11.57	3.38
	46	10.88	3.28	10.66	3.28	10.58	3.28	10.43	3.28	11.03	3.29	11.43	3.29
1.6 + 1.6 + 2.0 + 3.5 + 6.0	22	14.11	1.82	11.97	1.94	11.26	1.97	9.83	2.05	11.28	2.08	12.24	2.10
	25	13.25	2.32	11.87	2.39	11.41	2.41	10.50	2.46	11.51	2.47	12.19	2.48
	29	12.57	2.83	11.85	2.85	11.61	2.86	11.13	2.88	11.71	2.89	12.09	2.89
	32	11.75	3.12	11.57	3.12	11.52	3.12	11.40	3.12	11.77	3.12	12.01	3.12
	35	11.33	3.31	11.41	3.30	11.44	3.29	11.50	3.28	11.75	3.28	11.91	3.28
	40	10.92	3.44	11.10	3.42	11.17	3.41	11.29	3.40	11.54	3.40	11.71	3.39
	43	10.82	3.41	10.88	3.39	10.90	3.39	10.94	3.38	11.32	3.38	11.57	3.38
	46	10.88	3.28	10.66	3.28	10.58	3.28	10.43	3.28	11.03	3.29	11.43	3.29
1.6 + 1.6 + 2.0 + 3.5 + 7.1	22	14.11	1.83	11.97	1.94	11.26	1.98	9.83	2.05	11.28	2.09	12.24	2.11
	25	13.25	2.32	11.87	2.39	11.41	2.42	10.50	2.46	11.51	2.48	12.19	2.49
	29	12.57	2.84	11.85	2.86	11.61	2.87	11.13	2.89	11.71	2.89	12.09	2.90
	32	11.75	3.12	11.57	3.12	11.52	3.12	11.40	3.12	11.77	3.13	12.01	3.13
	35	11.33	3.32	11.41	3.31	11.44	3.30	11.50	3.29	11.75	3.29	11.91	3.29
	40	10.92	3.45	11.10	3.43	11.17	3.42	11.29	3.41	11.54	3.41	11.71	3.40
	43	10.82	3.42	10.88	3.40	10.90	3.40	10.94	3.39	11.32	3.39	11.57	3.39
	46	10.88	3.29	10.66	3.29	10.58	3.29	10.43	3.29	11.03	3.30	11.43	3.30

Combination (Capacity)	Outdoor Air Temp. °C DB	Indoor Air Temp. °C											
		27/16		27/17.5		27/18		27/19		27/22		27/24	
		Total Q	Input Power	Total Q	Input Power	Total Q	Input Power	Total Q	Input Power	Total Q	Input Power	Total Q	Input Power
1.6 + 1.6 + 2.0 + 4.2 + 4.2	22	14.11	1.90	11.97	2.02	11.26	2.06	9.83	2.14	11.28	2.17	12.24	2.19
	25	13.25	2.42	11.87	2.49	11.41	2.51	10.50	2.56	11.51	2.58	12.19	2.59
	29	12.57	2.95	11.85	2.98	11.61	2.99	11.13	3.00	11.71	3.01	12.09	3.01
	32	11.75	3.25	11.57	3.25	11.52	3.25	11.40	3.25	11.77	3.25	12.01	3.26
	35	11.33	3.46	11.41	3.44	11.44	3.43	11.50	3.42	11.75	3.42	11.91	3.42
	40	10.92	3.58	11.10	3.56	11.17	3.56	11.29	3.55	11.54	3.54	11.71	3.54
	43	10.82	3.56	10.88	3.54	10.90	3.53	10.94	3.52	11.32	3.52	11.57	3.52
	46	10.88	3.42	10.66	3.42	10.58	3.42	10.43	3.42	11.03	3.43	11.43	3.43
1.6 + 1.6 + 2.0 + 4.2 + 5.0	22	14.11	1.82	11.97	1.94	11.26	1.97	9.83	2.05	11.28	2.08	12.24	2.10
	25	13.25	2.32	11.87	2.39	11.41	2.41	10.50	2.46	11.51	2.47	12.19	2.48
	29	12.57	2.83	11.85	2.85	11.61	2.86	11.13	2.88	11.71	2.89	12.09	2.89
	32	11.75	3.12	11.57	3.12	11.52	3.12	11.40	3.12	11.77	3.12	12.01	3.12
	35	11.33	3.31	11.41	3.30	11.44	3.29	11.50	3.28	11.75	3.28	11.91	3.28
	40	10.92	3.44	11.10	3.42	11.17	3.41	11.29	3.40	11.54	3.40	11.71	3.39
	43	10.82	3.41	10.88	3.39	10.90	3.39	10.94	3.38	11.32	3.38	11.57	3.38
	46	10.88	3.28	10.66	3.28	10.58	3.28	10.43	3.28	11.03	3.29	11.43	3.29
1.6 + 1.6 + 2.0 + 4.2 + 6.0	22	14.11	1.82	11.97	1.94	11.26	1.97	9.83	2.05	11.28	2.08	12.24	2.10
	25	13.25	2.32	11.87	2.39	11.41	2.41	10.50	2.46	11.51	2.47	12.19	2.48
	29	12.57	2.83	11.85	2.85	11.61	2.86	11.13	2.88	11.71	2.89	12.09	2.89
	32	11.75	3.12	11.57	3.12	11.52	3.12	11.40	3.12	11.77	3.12	12.01	3.12
	35	11.33	3.31	11.41	3.30	11.44	3.29	11.50	3.28	11.75	3.28	11.91	3.28
	40	10.92	3.44	11.10	3.42	11.17	3.41	11.29	3.40	11.54	3.40	11.71	3.39
	43	10.82	3.41	10.88	3.39	10.90	3.39	10.94	3.38	11.32	3.38	11.57	3.38
	46	10.88	3.28	10.66	3.28	10.58	3.28	10.43	3.28	11.03	3.29	11.43	3.29
1.6 + 1.6 + 2.0 + 4.2 + 7.1	22	14.11	1.83	11.97	1.94	11.26	1.98	9.83	2.05	11.28	2.09	12.24	2.11
	25	13.25	2.32	11.87	2.39	11.41	2.42	10.50	2.46	11.51	2.48	12.19	2.49
	29	12.57	2.84	11.85	2.86	11.61	2.87	11.13	2.89	11.71	2.89	12.09	2.90
	32	11.75	3.12	11.57	3.12	11.52	3.12	11.40	3.12	11.77	3.13	12.01	3.13
	35	11.33	3.32	11.41	3.31	11.44	3.30	11.50	3.29	11.75	3.29	11.91	3.29
	40	10.92	3.45	11.10	3.43	11.17	3.42	11.29	3.41	11.54	3.41	11.71	3.40
	43	10.82	3.42	10.88	3.40	10.90	3.40	10.94	3.39	11.32	3.39	11.57	3.39
	46	10.88	3.29	10.66	3.29	10.58	3.29	10.43	3.29	11.03	3.30	11.43	3.30
1.6 + 1.6 + 2.0 + 5.0 + 5.0	22	14.11	1.79	11.97	1.91	11.26	1.94	9.83	2.02	11.28	2.05	12.24	2.07
	25	13.25	2.28	11.87	2.35	11.41	2.37	10.50	2.42	11.51	2.43	12.19	2.44
	29	12.57	2.79	11.85	2.81	11.61	2.82	11.13	2.84	11.71	2.84	12.09	2.85
	32	11.75	3.07	11.57	3.07	11.52	3.07	11.40	3.07	11.77	3.07	12.01	3.08
	35	11.33	3.26	11.41	3.25	11.44	3.24	11.50	3.23	11.75	3.23	11.91	3.23
	40	10.92	3.38	11.10	3.37	11.17	3.36	11.29	3.35	11.54	3.34	11.71	3.34
	43	10.82	3.36	10.88	3.34	10.90	3.34	10.94	3.32	11.32	3.32	11.57	3.32
	46	10.88	3.23	10.66	3.23	10.58	3.23	10.43	3.23	11.03	3.24	11.43	3.24

Combination (Capacity)	Outdoor Air Temp. °C DB	Indoor Air Temp. °C											
		27/16		27/17.5		27/18		27/19		27/22		27/24	
		Total Q	Input Power	Total Q	Input Power	Total Q	Input Power	Total Q	Input Power	Total Q	Input Power	Total Q	Input Power
1.6 + 1.6 + 2.0 + 5.0 + 6.0	22	14.11	1.79	11.97	1.91	11.26	1.94	9.83	2.02	11.28	2.05	12.24	2.07
	25	13.25	2.28	11.87	2.35	11.41	2.37	10.50	2.42	11.51	2.43	12.19	2.44
	29	12.57	2.79	11.85	2.81	11.61	2.82	11.13	2.84	11.71	2.84	12.09	2.85
	32	11.75	3.07	11.57	3.07	11.52	3.07	11.40	3.07	11.77	3.07	12.01	3.08
	35	11.33	3.26	11.41	3.25	11.44	3.24	11.50	3.23	11.75	3.23	11.91	3.23
	40	10.92	3.38	11.10	3.37	11.17	3.36	11.29	3.35	11.54	3.34	11.71	3.34
	43	10.82	3.36	10.88	3.34	10.90	3.34	10.94	3.32	11.32	3.32	11.57	3.32
	46	10.88	3.23	10.66	3.23	10.58	3.23	10.43	3.23	11.03	3.24	11.43	3.24
1.6 + 1.6 + 2.0 + 5.0 + 7.1	22	14.11	1.80	11.97	1.91	11.26	1.95	9.83	2.02	11.28	2.05	12.24	2.07
	25	13.25	2.29	11.87	2.36	11.41	2.38	10.50	2.43	11.51	2.44	12.19	2.45
	29	12.57	2.79	11.85	2.82	11.61	2.83	11.13	2.85	11.71	2.85	12.09	2.85
	32	11.75	3.08	11.57	3.08	11.52	3.08	11.40	3.08	11.77	3.08	12.01	3.09
	35	11.33	3.27	11.41	3.26	11.44	3.25	11.50	3.24	11.75	3.24	11.91	3.24
	40	10.92	3.39	11.10	3.38	11.17	3.37	11.29	3.36	11.54	3.35	11.71	3.35
	43	10.82	3.37	10.88	3.35	10.90	3.35	10.94	3.33	11.32	3.33	11.57	3.33
	46	10.88	3.24	10.66	3.24	10.58	3.24	10.43	3.24	11.03	3.25	11.43	3.25
1.6 + 1.6 + 2.0 + 6.0 + 6.0	22	14.11	1.79	11.97	1.91	11.26	1.94	9.83	2.02	11.28	2.05	12.24	2.07
	25	13.25	2.28	11.87	2.35	11.41	2.37	10.50	2.42	11.51	2.43	12.19	2.44
	29	12.57	2.79	11.85	2.81	11.61	2.82	11.13	2.84	11.71	2.84	12.09	2.85
	32	11.75	3.07	11.57	3.07	11.52	3.07	11.40	3.07	11.77	3.07	12.01	3.08
	35	11.33	3.26	11.41	3.25	11.44	3.24	11.50	3.23	11.75	3.23	11.91	3.23
	40	10.92	3.38	11.10	3.37	11.17	3.36	11.29	3.35	11.54	3.34	11.71	3.34
	43	10.82	3.36	10.88	3.34	10.90	3.34	10.94	3.32	11.32	3.32	11.57	3.32
	46	10.88	3.23	10.66	3.23	10.58	3.23	10.43	3.23	11.03	3.24	11.43	3.24
1.6 + 1.6 + 2.0 + 6.0 + 7.1	22	14.11	1.80	11.97	1.91	11.26	1.95	9.83	2.02	11.28	2.05	12.24	2.07
	25	13.25	2.29	11.87	2.36	11.41	2.38	10.50	2.43	11.51	2.44	12.19	2.45
	29	12.57	2.79	11.85	2.82	11.61	2.83	11.13	2.85	11.71	2.85	12.09	2.85
	32	11.75	3.08	11.57	3.08	11.52	3.08	11.40	3.08	11.77	3.08	12.01	3.09
	35	11.33	3.27	11.41	3.26	11.44	3.25	11.50	3.24	11.75	3.24	11.91	3.24
	40	10.92	3.39	11.10	3.38	11.17	3.37	11.29	3.36	11.54	3.35	11.71	3.35
	43	10.82	3.37	10.88	3.35	10.90	3.35	10.94	3.33	11.32	3.33	11.57	3.33
	46	10.88	3.24	10.66	3.24	10.58	3.24	10.43	3.24	11.03	3.25	11.43	3.25
1.6 + 1.6 + 2.5 + 2.5 + 2.5	22	14.11	1.94	11.97	2.06	11.26	2.10	9.83	2.18	11.28	2.21	12.24	2.23
	25	13.25	2.47	11.87	2.54	11.41	2.56	10.50	2.61	11.51	2.63	12.19	2.64
	29	12.57	3.01	11.85	3.04	11.61	3.05	11.13	3.07	11.71	3.07	12.09	3.07
	32	11.75	3.31	11.57	3.31	11.52	3.31	11.40	3.31	11.77	3.32	12.01	3.32
	35	11.33	3.53	11.41	3.51	11.44	3.50	11.50	3.49	11.75	3.49	11.91	3.49
	40	10.92	3.66	11.10	3.64	11.17	3.63	11.29	3.62	11.54	3.61	11.71	3.61
	43	10.82	3.63	10.88	3.61	10.90	3.60	10.94	3.59	11.32	3.59	11.57	3.59
	46	10.88	3.49	10.66	3.49	10.58	3.49	10.43	3.49	11.03	3.50	11.43	3.50

Combination (Capacity)	Outdoor Air Temp. °C DB	Indoor Air Temp. °C											
		27/16		27/17.5		27/18		27/19		27/22		27/24	
		Total Q	Input Power	Total Q	Input Power	Total Q	Input Power	Total Q	Input Power	Total Q	Input Power	Total Q	Input Power
1.6 + 1.6 + 2.5 + 2.5 + 3.5	22	14.11	1.94	11.97	2.06	11.26	2.10	9.83	2.18	11.28	2.21	12.24	2.23
	25	13.25	2.47	11.87	2.54	11.41	2.56	10.50	2.61	11.51	2.63	12.19	2.64
	29	12.57	3.01	11.85	3.04	11.61	3.05	11.13	3.07	11.71	3.07	12.09	3.07
	32	11.75	3.31	11.57	3.31	11.52	3.31	11.40	3.31	11.77	3.32	12.01	3.32
	35	11.33	3.53	11.41	3.51	11.44	3.50	11.50	3.49	11.75	3.49	11.91	3.49
	40	10.92	3.66	11.10	3.64	11.17	3.63	11.29	3.62	11.54	3.61	11.71	3.61
	43	10.82	3.63	10.88	3.61	10.90	3.60	10.94	3.59	11.32	3.59	11.57	3.59
	46	10.88	3.49	10.66	3.49	10.58	3.49	10.43	3.49	11.03	3.50	11.43	3.50
1.6 + 1.6 + 2.5 + 2.5 + 4.2	22	14.11	1.89	11.97	2.01	11.26	2.05	9.83	2.13	11.28	2.16	12.24	2.18
	25	13.25	2.41	11.87	2.48	11.41	2.50	10.50	2.55	11.51	2.57	12.19	2.58
	29	12.57	2.94	11.85	2.97	11.61	2.98	11.13	3.00	11.71	3.00	12.09	3.00
	32	11.75	3.24	11.57	3.24	11.52	3.24	11.40	3.24	11.77	3.24	12.01	3.25
	35	11.33	3.45	11.41	3.43	11.44	3.42	11.50	3.41	11.75	3.41	11.91	3.41
	40	10.92	3.57	11.10	3.55	11.17	3.55	11.29	3.54	11.54	3.53	11.71	3.53
	43	10.82	3.55	10.88	3.53	10.90	3.52	10.94	3.51	11.32	3.51	11.57	3.51
	46	10.88	3.41	10.66	3.41	10.58	3.41	10.43	3.41	11.03	3.42	11.43	3.42
1.6 + 1.6 + 2.5 + 2.5 + 5.0	22	14.11	1.82	11.97	1.94	11.26	1.97	9.83	2.05	11.28	2.08	12.24	2.10
	25	13.25	2.32	11.87	2.39	11.41	2.41	10.50	2.46	11.51	2.47	12.19	2.48
	29	12.57	2.83	11.85	2.85	11.61	2.86	11.13	2.88	11.71	2.89	12.09	2.89
	32	11.75	3.12	11.57	3.12	11.52	3.12	11.40	3.12	11.77	3.12	12.01	3.12
	35	11.33	3.31	11.41	3.30	11.44	3.29	11.50	3.28	11.75	3.28	11.91	3.28
	40	10.92	3.44	11.10	3.42	11.17	3.41	11.29	3.40	11.54	3.40	11.71	3.39
	43	10.82	3.41	10.88	3.39	10.90	3.39	10.94	3.38	11.32	3.38	11.57	3.38
	46	10.88	3.28	10.66	3.28	10.58	3.28	10.43	3.28	11.03	3.29	11.43	3.29
1.6 + 1.6 + 2.5 + 2.5 + 6.0	22	14.11	1.82	11.97	1.94	11.26	1.97	9.83	2.05	11.28	2.08	12.24	2.10
	25	13.25	2.32	11.87	2.39	11.41	2.41	10.50	2.46	11.51	2.47	12.19	2.48
	29	12.57	2.83	11.85	2.85	11.61	2.86	11.13	2.88	11.71	2.89	12.09	2.89
	32	11.75	3.12	11.57	3.12	11.52	3.12	11.40	3.12	11.77	3.12	12.01	3.12
	35	11.33	3.31	11.41	3.30	11.44	3.29	11.50	3.28	11.75	3.28	11.91	3.28
	40	10.92	3.44	11.10	3.42	11.17	3.41	11.29	3.40	11.54	3.40	11.71	3.39
	43	10.82	3.41	10.88	3.39	10.90	3.39	10.94	3.38	11.32	3.38	11.57	3.38
	46	10.88	3.28	10.66	3.28	10.58	3.28	10.43	3.28	11.03	3.29	11.43	3.29
1.6 + 1.6 + 2.5 + 2.5 + 7.1	22	14.11	1.82	11.97	1.94	11.26	1.97	9.83	2.05	11.28	2.08	12.24	2.10
	25	13.25	2.32	11.87	2.39	11.41	2.41	10.50	2.46	11.51	2.47	12.19	2.48
	29	12.57	2.83	11.85	2.85	11.61	2.86	11.13	2.88	11.71	2.89	12.09	2.89
	32	11.75	3.12	11.57	3.12	11.52	3.12	11.40	3.12	11.77	3.12	12.01	3.12
	35	11.33	3.31	11.41	3.30	11.44	3.29	11.50	3.28	11.75	3.28	11.91	3.28
	40	10.92	3.44	11.10	3.42	11.17	3.41	11.29	3.40	11.54	3.40	11.71	3.39
	43	10.82	3.41	10.88	3.39	10.90	3.39	10.94	3.38	11.32	3.38	11.57	3.38
	46	10.88	3.28	10.66	3.28	10.58	3.28	10.43	3.28	11.03	3.29	11.43	3.29

Combination (Capacity)	Outdoor Air Temp. °C DB	Indoor Air Temp. °C											
		27/16		27/17.5		27/18		27/19		27/22		27/24	
		Total Q	Input Power	Total Q	Input Power	Total Q	Input Power	Total Q	Input Power	Total Q	Input Power	Total Q	Input Power
1.6 + 1.6 + 2.5 + 3.5 + 3.5	22	14.11	1.89	11.97	2.01	11.26	2.05	9.83	2.13	11.28	2.16	12.24	2.18
	25	13.25	2.41	11.87	2.48	11.41	2.50	10.50	2.55	11.51	2.57	12.19	2.58
	29	12.57	2.94	11.85	2.97	11.61	2.98	11.13	3.00	11.71	3.00	12.09	3.00
	32	11.75	3.24	11.57	3.24	11.52	3.24	11.40	3.24	11.77	3.24	12.01	3.25
	35	11.33	3.45	11.41	3.43	11.44	3.42	11.50	3.41	11.75	3.41	11.91	3.41
	40	10.92	3.57	11.10	3.55	11.17	3.55	11.29	3.54	11.54	3.53	11.71	3.53
	43	10.82	3.55	10.88	3.53	10.90	3.52	10.94	3.51	11.32	3.51	11.57	3.51
	46	10.88	3.41	10.66	3.41	10.58	3.41	10.43	3.41	11.03	3.42	11.43	3.42
1.6 + 1.6 + 2.5 + 3.5 + 4.2	22	14.11	1.89	11.97	2.01	11.26	2.05	9.83	2.13	11.28	2.16	12.24	2.18
	25	13.25	2.41	11.87	2.48	11.41	2.50	10.50	2.55	11.51	2.57	12.19	2.58
	29	12.57	2.94	11.85	2.97	11.61	2.98	11.13	3.00	11.71	3.00	12.09	3.00
	32	11.75	3.24	11.57	3.24	11.52	3.24	11.40	3.24	11.77	3.24	12.01	3.25
	35	11.33	3.45	11.41	3.43	11.44	3.42	11.50	3.41	11.75	3.41	11.91	3.41
	40	10.92	3.57	11.10	3.55	11.17	3.55	11.29	3.54	11.54	3.53	11.71	3.53
	43	10.82	3.55	10.88	3.53	10.90	3.52	10.94	3.51	11.32	3.51	11.57	3.51
	46	10.88	3.41	10.66	3.41	10.58	3.41	10.43	3.41	11.03	3.42	11.43	3.42
1.6 + 1.6 + 2.5 + 3.5 + 5.0	22	14.11	1.82	11.97	1.94	11.26	1.97	9.83	2.05	11.28	2.08	12.24	2.10
	25	13.25	2.32	11.87	2.39	11.41	2.41	10.50	2.46	11.51	2.47	12.19	2.48
	29	12.57	2.83	11.85	2.85	11.61	2.86	11.13	2.88	11.71	2.89	12.09	2.89
	32	11.75	3.12	11.57	3.12	11.52	3.12	11.40	3.12	11.77	3.12	12.01	3.12
	35	11.33	3.31	11.41	3.30	11.44	3.29	11.50	3.28	11.75	3.28	11.91	3.28
	40	10.92	3.44	11.10	3.42	11.17	3.41	11.29	3.40	11.54	3.40	11.71	3.39
	43	10.82	3.41	10.88	3.39	10.90	3.39	10.94	3.38	11.32	3.38	11.57	3.38
	46	10.88	3.28	10.66	3.28	10.58	3.28	10.43	3.28	11.03	3.29	11.43	3.29
1.6 + 1.6 + 2.5 + 3.5 + 6.0	22	14.11	1.82	11.97	1.94	11.26	1.97	9.83	2.05	11.28	2.08	12.24	2.10
	25	13.25	2.32	11.87	2.39	11.41	2.41	10.50	2.46	11.51	2.47	12.19	2.48
	29	12.57	2.83	11.85	2.85	11.61	2.86	11.13	2.88	11.71	2.89	12.09	2.89
	32	11.75	3.12	11.57	3.12	11.52	3.12	11.40	3.12	11.77	3.12	12.01	3.12
	35	11.33	3.31	11.41	3.30	11.44	3.29	11.50	3.28	11.75	3.28	11.91	3.28
	40	10.92	3.44	11.10	3.42	11.17	3.41	11.29	3.40	11.54	3.40	11.71	3.39
	43	10.82	3.41	10.88	3.39	10.90	3.39	10.94	3.38	11.32	3.38	11.57	3.38
	46	10.88	3.28	10.66	3.28	10.58	3.28	10.43	3.28	11.03	3.29	11.43	3.29
1.6 + 1.6 + 2.5 + 3.5 + 7.1	22	14.11	1.83	11.97	1.94	11.26	1.98	9.83	2.05	11.28	2.09	12.24	2.11
	25	13.25	2.32	11.87	2.39	11.41	2.42	10.50	2.46	11.51	2.48	12.19	2.49
	29	12.57	2.84	11.85	2.86	11.61	2.87	11.13	2.89	11.71	2.89	12.09	2.90
	32	11.75	3.12	11.57	3.12	11.52	3.12	11.40	3.12	11.77	3.13	12.01	3.13
	35	11.33	3.32	11.41	3.31	11.44	3.30	11.50	3.29	11.75	3.29	11.91	3.29
	40	10.92	3.45	11.10	3.43	11.17	3.42	11.29	3.41	11.54	3.41	11.71	3.40
	43	10.82	3.42	10.88	3.40	10.90	3.40	10.94	3.39	11.32	3.39	11.57	3.39
	46	10.88	3.29	10.66	3.29	10.58	3.29	10.43	3.29	11.03	3.30	11.43	3.30

Combination (Capacity)	Outdoor Air Temp. °C DB	Indoor Air Temp. °C											
		27/16		27/17.5		27/18		27/19		27/22		27/24	
		Total Q	Input Power	Total Q	Input Power	Total Q	Input Power	Total Q	Input Power	Total Q	Input Power	Total Q	Input Power
1.6 + 1.6 + 2.5 + 4.2 + 4.2	22	14.11	1.90	11.97	2.02	11.26	2.06	9.83	2.14	11.28	2.17	12.24	2.19
	25	13.25	2.42	11.87	2.49	11.41	2.51	10.50	2.56	11.51	2.58	12.19	2.59
	29	12.57	2.95	11.85	2.98	11.61	2.99	11.13	3.00	11.71	3.01	12.09	3.01
	32	11.75	3.25	11.57	3.25	11.52	3.25	11.40	3.25	11.77	3.25	12.01	3.26
	35	11.33	3.46	11.41	3.44	11.44	3.43	11.50	3.42	11.75	3.42	11.91	3.42
	40	10.92	3.58	11.10	3.56	11.17	3.56	11.29	3.55	11.54	3.54	11.71	3.54
	43	10.82	3.56	10.88	3.54	10.90	3.53	10.94	3.52	11.32	3.52	11.57	3.52
	46	10.88	3.42	10.66	3.42	10.58	3.42	10.43	3.42	11.03	3.43	11.43	3.43
1.6 + 1.6 + 2.5 + 4.2 + 5.0	22	14.11	1.82	11.97	1.94	11.26	1.97	9.83	2.05	11.28	2.08	12.24	2.10
	25	13.25	2.32	11.87	2.39	11.41	2.41	10.50	2.46	11.51	2.47	12.19	2.48
	29	12.57	2.83	11.85	2.85	11.61	2.86	11.13	2.88	11.71	2.89	12.09	2.89
	32	11.75	3.12	11.57	3.12	11.52	3.12	11.40	3.12	11.77	3.12	12.01	3.12
	35	11.33	3.31	11.41	3.30	11.44	3.29	11.50	3.28	11.75	3.28	11.91	3.28
	40	10.92	3.44	11.10	3.42	11.17	3.41	11.29	3.40	11.54	3.40	11.71	3.39
	43	10.82	3.41	10.88	3.39	10.90	3.39	10.94	3.38	11.32	3.38	11.57	3.38
	46	10.88	3.28	10.66	3.28	10.58	3.28	10.43	3.28	11.03	3.29	11.43	3.29
1.6 + 1.6 + 2.5 + 4.2 + 6.0	22	14.11	1.82	11.97	1.94	11.26	1.97	9.83	2.05	11.28	2.08	12.24	2.10
	25	13.25	2.32	11.87	2.39	11.41	2.41	10.50	2.46	11.51	2.47	12.19	2.48
	29	12.57	2.83	11.85	2.85	11.61	2.86	11.13	2.88	11.71	2.89	12.09	2.89
	32	11.75	3.12	11.57	3.12	11.52	3.12	11.40	3.12	11.77	3.12	12.01	3.12
	35	11.33	3.31	11.41	3.30	11.44	3.29	11.50	3.28	11.75	3.28	11.91	3.28
	40	10.92	3.44	11.10	3.42	11.17	3.41	11.29	3.40	11.54	3.40	11.71	3.39
	43	10.82	3.41	10.88	3.39	10.90	3.39	10.94	3.38	11.32	3.38	11.57	3.38
	46	10.88	3.28	10.66	3.28	10.58	3.28	10.43	3.28	11.03	3.29	11.43	3.29
1.6 + 1.6 + 2.5 + 4.2 + 7.1	22	14.11	1.83	11.97	1.94	11.26	1.98	9.83	2.05	11.28	2.09	12.24	2.11
	25	13.25	2.32	11.87	2.39	11.41	2.42	10.50	2.46	11.51	2.48	12.19	2.49
	29	12.57	2.84	11.85	2.86	11.61	2.87	11.13	2.89	11.71	2.89	12.09	2.90
	32	11.75	3.12	11.57	3.12	11.52	3.12	11.40	3.12	11.77	3.13	12.01	3.13
	35	11.33	3.32	11.41	3.31	11.44	3.30	11.50	3.29	11.75	3.29	11.91	3.29
	40	10.92	3.45	11.10	3.43	11.17	3.42	11.29	3.41	11.54	3.41	11.71	3.40
	43	10.82	3.42	10.88	3.40	10.90	3.40	10.94	3.39	11.32	3.39	11.57	3.39
	46	10.88	3.29	10.66	3.29	10.58	3.29	10.43	3.29	11.03	3.30	11.43	3.30
1.6 + 1.6 + 2.5 + 5.0 + 5.0	22	14.11	1.79	11.97	1.91	11.26	1.94	9.83	2.02	11.28	2.05	12.24	2.07
	25	13.25	2.28	11.87	2.35	11.41	2.37	10.50	2.42	11.51	2.43	12.19	2.44
	29	12.57	2.79	11.85	2.81	11.61	2.82	11.13	2.84	11.71	2.84	12.09	2.85
	32	11.75	3.07	11.57	3.07	11.52	3.07	11.40	3.07	11.77	3.07	12.01	3.08
	35	11.33	3.26	11.41	3.25	11.44	3.24	11.50	3.23	11.75	3.23	11.91	3.23
	40	10.92	3.38	11.10	3.37	11.17	3.36	11.29	3.35	11.54	3.34	11.71	3.34
	43	10.82	3.36	10.88	3.34	10.90	3.34	10.94	3.32	11.32	3.32	11.57	3.32
	46	10.88	3.23	10.66	3.23	10.58	3.23	10.43	3.23	11.03	3.24	11.43	3.24

Combination (Capacity)	Outdoor Air Temp. °C DB	Indoor Air Temp. °C											
		27/16		27/17.5		27/18		27/19		27/22		27/24	
		Total Q	Input Power	Total Q	Input Power	Total Q	Input Power	Total Q	Input Power	Total Q	Input Power	Total Q	Input Power
1.6 + 1.6 + 2.5 + 5.0 + 6.0	22	14.11	1.79	11.97	1.91	11.26	1.94	9.83	2.02	11.28	2.05	12.24	2.07
	25	13.25	2.28	11.87	2.35	11.41	2.37	10.50	2.42	11.51	2.43	12.19	2.44
	29	12.57	2.79	11.85	2.81	11.61	2.82	11.13	2.84	11.71	2.84	12.09	2.85
	32	11.75	3.07	11.57	3.07	11.52	3.07	11.40	3.07	11.77	3.07	12.01	3.08
	35	11.33	3.26	11.41	3.25	11.44	3.24	11.50	3.23	11.75	3.23	11.91	3.23
	40	10.92	3.38	11.10	3.37	11.17	3.36	11.29	3.35	11.54	3.34	11.71	3.34
	43	10.82	3.36	10.88	3.34	10.90	3.34	10.94	3.32	11.32	3.32	11.57	3.32
	46	10.88	3.23	10.66	3.23	10.58	3.23	10.43	3.23	11.03	3.24	11.43	3.24
1.6 + 1.6 + 2.5 + 5.0 + 7.1	22	14.11	1.80	11.97	1.91	11.26	1.95	9.83	2.02	11.28	2.05	12.24	2.07
	25	13.25	2.29	11.87	2.36	11.41	2.38	10.50	2.43	11.51	2.44	12.19	2.45
	29	12.57	2.79	11.85	2.82	11.61	2.83	11.13	2.85	11.71	2.85	12.09	2.85
	32	11.75	3.08	11.57	3.08	11.52	3.08	11.40	3.08	11.77	3.08	12.01	3.09
	35	11.33	3.27	11.41	3.26	11.44	3.25	11.50	3.24	11.75	3.24	11.91	3.24
	40	10.92	3.39	11.10	3.38	11.17	3.37	11.29	3.36	11.54	3.35	11.71	3.35
	43	10.82	3.37	10.88	3.35	10.90	3.35	10.94	3.33	11.32	3.33	11.57	3.33
	46	10.88	3.24	10.66	3.24	10.58	3.24	10.43	3.24	11.03	3.25	11.43	3.25
1.6 + 1.6 + 2.5 + 6.0 + 6.0	22	14.11	1.79	11.97	1.91	11.26	1.94	9.83	2.02	11.28	2.05	12.24	2.07
	25	13.25	2.28	11.87	2.35	11.41	2.37	10.50	2.42	11.51	2.43	12.19	2.44
	29	12.57	2.79	11.85	2.81	11.61	2.82	11.13	2.84	11.71	2.84	12.09	2.85
	32	11.75	3.07	11.57	3.07	11.52	3.07	11.40	3.07	11.77	3.07	12.01	3.08
	35	11.33	3.26	11.41	3.25	11.44	3.24	11.50	3.23	11.75	3.23	11.91	3.23
	40	10.92	3.38	11.10	3.37	11.17	3.36	11.29	3.35	11.54	3.34	11.71	3.34
	43	10.82	3.36	10.88	3.34	10.90	3.34	10.94	3.32	11.32	3.32	11.57	3.32
	46	10.88	3.23	10.66	3.23	10.58	3.23	10.43	3.23	11.03	3.24	11.43	3.24
1.6 + 1.6 + 3.5 + 3.5 + 3.5	22	14.11	1.90	11.97	2.02	11.26	2.06	9.83	2.14	11.28	2.17	12.24	2.19
	25	13.25	2.42	11.87	2.49	11.41	2.51	10.50	2.56	11.51	2.58	12.19	2.59
	29	12.57	2.95	11.85	2.98	11.61	2.99	11.13	3.00	11.71	3.01	12.09	3.01
	32	11.75	3.25	11.57	3.25	11.52	3.25	11.40	3.25	11.77	3.25	12.01	3.26
	35	11.33	3.46	11.41	3.44	11.44	3.43	11.50	3.42	11.75	3.42	11.91	3.42
	40	10.92	3.58	11.10	3.56	11.17	3.56	11.29	3.55	11.54	3.54	11.71	3.54
	43	10.82	3.56	10.88	3.54	10.90	3.53	10.94	3.52	11.32	3.52	11.57	3.52
	46	10.88	3.42	10.66	3.42	10.58	3.42	10.43	3.42	11.03	3.43	11.43	3.43
1.6 + 1.6 + 3.5 + 3.5 + 4.2	22	14.11	1.90	11.97	2.02	11.26	2.06	9.83	2.14	11.28	2.17	12.24	2.19
	25	13.25	2.42	11.87	2.49	11.41	2.51	10.50	2.56	11.51	2.58	12.19	2.59
	29	12.57	2.95	11.85	2.98	11.61	2.99	11.13	3.00	11.71	3.01	12.09	3.01
	32	11.75	3.25	11.57	3.25	11.52	3.25	11.40	3.25	11.77	3.25	12.01	3.26
	35	11.33	3.46	11.41	3.44	11.44	3.43	11.50	3.42	11.75	3.42	11.91	3.42
	40	10.92	3.58	11.10	3.56	11.17	3.56	11.29	3.55	11.54	3.54	11.71	3.54
	43	10.82	3.56	10.88	3.54	10.90	3.53	10.94	3.52	11.32	3.52	11.57	3.52
	46	10.88	3.42	10.66	3.42	10.58	3.42	10.43	3.42	11.03	3.43	11.43	3.43



Combination (Capacity)	Outdoor Air Temp. °C DB	Indoor Air Temp. °C											
		27/16		27/17.5		27/18		27/19		27/22		27/24	
		Total Q	Input Power	Total Q	Input Power	Total Q	Input Power	Total Q	Input Power	Total Q	Input Power	Total Q	Input Power
1.6 + 1.6 + 3.5 + 3.5 + 5.0	22	14.11	1.82	11.97	1.94	11.26	1.97	9.83	2.05	11.28	2.08	12.24	2.10
	25	13.25	2.32	11.87	2.39	11.41	2.41	10.50	2.46	11.51	2.47	12.19	2.48
	29	12.57	2.83	11.85	2.85	11.61	2.86	11.13	2.88	11.71	2.89	12.09	2.89
	32	11.75	3.12	11.57	3.12	11.52	3.12	11.40	3.12	11.77	3.12	12.01	3.12
	35	11.33	3.31	11.41	3.30	11.44	3.29	11.50	3.28	11.75	3.28	11.91	3.28
	40	10.92	3.44	11.10	3.42	11.17	3.41	11.29	3.40	11.54	3.40	11.71	3.39
	43	10.82	3.41	10.88	3.39	10.90	3.39	10.94	3.38	11.32	3.38	11.57	3.38
	46	10.88	3.28	10.66	3.28	10.58	3.28	10.43	3.28	11.03	3.29	11.43	3.29
1.6 + 1.6 + 3.5 + 3.5 + 6.0	22	14.11	1.82	11.97	1.94	11.26	1.97	9.83	2.05	11.28	2.08	12.24	2.10
	25	13.25	2.32	11.87	2.39	11.41	2.41	10.50	2.46	11.51	2.47	12.19	2.48
	29	12.57	2.83	11.85	2.85	11.61	2.86	11.13	2.88	11.71	2.89	12.09	2.89
	32	11.75	3.12	11.57	3.12	11.52	3.12	11.40	3.12	11.77	3.12	12.01	3.12
	35	11.33	3.31	11.41	3.30	11.44	3.29	11.50	3.28	11.75	3.28	11.91	3.28
	40	10.92	3.44	11.10	3.42	11.17	3.41	11.29	3.40	11.54	3.40	11.71	3.39
	43	10.82	3.41	10.88	3.39	10.90	3.39	10.94	3.38	11.32	3.38	11.57	3.38
	46	10.88	3.28	10.66	3.28	10.58	3.28	10.43	3.28	11.03	3.29	11.43	3.29
1.6 + 1.6 + 3.5 + 3.5 + 7.1	22	14.11	1.83	11.97	1.94	11.26	1.98	9.83	2.05	11.28	2.09	12.24	2.11
	25	13.25	2.32	11.87	2.39	11.41	2.42	10.50	2.46	11.51	2.48	12.19	2.49
	29	12.57	2.84	11.85	2.86	11.61	2.87	11.13	2.89	11.71	2.89	12.09	2.90
	32	11.75	3.12	11.57	3.12	11.52	3.12	11.40	3.12	11.77	3.13	12.01	3.13
	35	11.33	3.32	11.41	3.31	11.44	3.30	11.50	3.29	11.75	3.29	11.91	3.29
	40	10.92	3.45	11.10	3.43	11.17	3.42	11.29	3.41	11.54	3.41	11.71	3.40
	43	10.82	3.42	10.88	3.40	10.90	3.40	10.94	3.39	11.32	3.39	11.57	3.39
	46	10.88	3.29	10.66	3.29	10.58	3.29	10.43	3.29	11.03	3.30	11.43	3.30
1.6 + 1.6 + 3.5 + 4.2 + 4.2	22	14.11	1.86	11.97	1.97	11.26	2.01	9.83	2.09	11.28	2.12	12.24	2.14
	25	13.25	2.36	11.87	2.43	11.41	2.45	10.50	2.50	11.51	2.52	12.19	2.53
	29	12.57	2.88	11.85	2.91	11.61	2.92	11.13	2.93	11.71	2.94	12.09	2.94
	32	11.75	3.17	11.57	3.17	11.52	3.17	11.40	3.17	11.77	3.18	12.01	3.18
	35	11.33	3.38	11.41	3.36	11.44	3.35	11.50	3.34	11.75	3.34	11.91	3.34
	40	10.92	3.50	11.10	3.48	11.17	3.48	11.29	3.46	11.54	3.46	11.71	3.45
	43	10.82	3.47	10.88	3.45	10.90	3.45	10.94	3.44	11.32	3.44	11.57	3.44
	46	10.88	3.34	10.66	3.34	10.58	3.34	10.43	3.34	11.03	3.35	11.43	3.35
1.6 + 1.6 + 3.5 + 4.2 + 5.0	22	14.11	1.83	11.97	1.94	11.26	1.98	9.83	2.05	11.28	2.09	12.24	2.11
	25	13.25	2.32	11.87	2.39	11.41	2.42	10.50	2.46	11.51	2.48	12.19	2.49
	29	12.57	2.84	11.85	2.86	11.61	2.87	11.13	2.89	11.71	2.89	12.09	2.90
	32	11.75	3.12	11.57	3.12	11.52	3.12	11.40	3.12	11.77	3.13	12.01	3.13
	35	11.33	3.32	11.41	3.31	11.44	3.30	11.50	3.29	11.75	3.29	11.91	3.29
	40	10.92	3.45	11.10	3.43	11.17	3.42	11.29	3.41	11.54	3.41	11.71	3.40
	43	10.82	3.42	10.88	3.40	10.90	3.40	10.94	3.39	11.32	3.39	11.57	3.39
	46	10.88	3.29	10.66	3.29	10.58	3.29	10.43	3.29	11.03	3.30	11.43	3.30

Combination (Capacity)	Outdoor Air Temp. °C DB	Indoor Air Temp. °C											
		27/16		27/17.5		27/18		27/19		27/22		27/24	
		Total Q	Input Power	Total Q	Input Power	Total Q	Input Power	Total Q	Input Power	Total Q	Input Power	Total Q	Input Power
1.6 + 1.6 + 3.5 + 4.2 + 6.0	22	14.11	1.83	11.97	1.94	11.26	1.98	9.83	2.05	11.28	2.09	12.24	2.11
	25	13.25	2.32	11.87	2.39	11.41	2.42	10.50	2.46	11.51	2.48	12.19	2.49
	29	12.57	2.84	11.85	2.86	11.61	2.87	11.13	2.89	11.71	2.89	12.09	2.90
	32	11.75	3.12	11.57	3.12	11.52	3.12	11.40	3.12	11.77	3.13	12.01	3.13
	35	11.33	3.32	11.41	3.31	11.44	3.30	11.50	3.29	11.75	3.29	11.91	3.29
	40	10.92	3.45	11.10	3.43	11.17	3.42	11.29	3.41	11.54	3.41	11.71	3.40
	43	10.82	3.42	10.88	3.40	10.90	3.40	10.94	3.39	11.32	3.39	11.57	3.39
	46	10.88	3.29	10.66	3.29	10.58	3.29	10.43	3.29	11.03	3.30	11.43	3.30
1.6 + 1.6 + 3.5 + 4.2 + 7.1	22	14.11	1.83	11.97	1.94	11.26	1.98	9.83	2.05	11.28	2.09	12.24	2.11
	25	13.25	2.32	11.87	2.39	11.41	2.42	10.50	2.46	11.51	2.48	12.19	2.49
	29	12.57	2.84	11.85	2.86	11.61	2.87	11.13	2.89	11.71	2.89	12.09	2.90
	32	11.75	3.12	11.57	3.12	11.52	3.12	11.40	3.12	11.77	3.13	12.01	3.13
	35	11.33	3.32	11.41	3.31	11.44	3.30	11.50	3.29	11.75	3.29	11.91	3.29
	40	10.92	3.45	11.10	3.43	11.17	3.42	11.29	3.41	11.54	3.41	11.71	3.40
	43	10.82	3.42	10.88	3.40	10.90	3.40	10.94	3.39	11.32	3.39	11.57	3.39
	46	10.88	3.29	10.66	3.29	10.58	3.29	10.43	3.29	11.03	3.30	11.43	3.30
1.6 + 1.6 + 3.5 + 5.0 + 5.0	22	14.11	1.80	11.97	1.91	11.26	1.95	9.83	2.02	11.28	2.05	12.24	2.07
	25	13.25	2.29	11.87	2.36	11.41	2.38	10.50	2.43	11.51	2.44	12.19	2.45
	29	12.57	2.79	11.85	2.82	11.61	2.83	11.13	2.85	11.71	2.85	12.09	2.85
	32	11.75	3.08	11.57	3.08	11.52	3.08	11.40	3.08	11.77	3.08	12.01	3.09
	35	11.33	3.27	11.41	3.26	11.44	3.25	11.50	3.24	11.75	3.24	11.91	3.24
	40	10.92	3.39	11.10	3.38	11.17	3.37	11.29	3.36	11.54	3.35	11.71	3.35
	43	10.82	3.37	10.88	3.35	10.90	3.35	10.94	3.33	11.32	3.33	11.57	3.33
	46	10.88	3.24	10.66	3.24	10.58	3.24	10.43	3.24	11.03	3.25	11.43	3.25
1.6 + 1.6 + 3.5 + 5.0 + 6.0	22	14.11	1.80	11.97	1.91	11.26	1.95	9.83	2.02	11.28	2.05	12.24	2.07
	25	13.25	2.29	11.87	2.36	11.41	2.38	10.50	2.43	11.51	2.44	12.19	2.45
	29	12.57	2.79	11.85	2.82	11.61	2.83	11.13	2.85	11.71	2.85	12.09	2.85
	32	11.75	3.08	11.57	3.08	11.52	3.08	11.40	3.08	11.77	3.08	12.01	3.09
	35	11.33	3.27	11.41	3.26	11.44	3.25	11.50	3.24	11.75	3.24	11.91	3.24
	40	10.92	3.39	11.10	3.38	11.17	3.37	11.29	3.36	11.54	3.35	11.71	3.35
	43	10.82	3.37	10.88	3.35	10.90	3.35	10.94	3.33	11.32	3.33	11.57	3.33
	46	10.88	3.24	10.66	3.24	10.58	3.24	10.43	3.24	11.03	3.25	11.43	3.25
1.6 + 1.6 + 4.2 + 4.2 + 4.2	22	14.11	1.86	11.97	1.97	11.26	2.01	9.83	2.09	11.28	2.12	12.24	2.14
	25	13.25	2.36	11.87	2.43	11.41	2.45	10.50	2.50	11.51	2.52	12.19	2.53
	29	12.57	2.88	11.85	2.91	11.61	2.92	11.13	2.93	11.71	2.94	12.09	2.94
	32	11.75	3.17	11.57	3.17	11.52	3.17	11.40	3.17	11.77	3.18	12.01	3.18
	35	11.33	3.38	11.41	3.36	11.44	3.35	11.50	3.34	11.75	3.34	11.91	3.34
	40	10.92	3.50	11.10	3.48	11.17	3.48	11.29	3.46	11.54	3.46	11.71	3.45
	43	10.82	3.47	10.88	3.45	10.90	3.45	10.94	3.44	11.32	3.44	11.57	3.44
	46	10.88	3.34	10.66	3.34	10.58	3.34	10.43	3.34	11.03	3.35	11.43	3.35

Combination (Capacity)	Outdoor Air Temp. °C DB	Indoor Air Temp. °C											
		27/16		27/17.5		27/18		27/19		27/22		27/24	
		Total Q	Input Power	Total Q	Input Power	Total Q	Input Power	Total Q	Input Power	Total Q	Input Power	Total Q	Input Power
1.6 + 1.6 + 4.2 + 4.2 + 5.0	22	14.11	1.83	11.97	1.94	11.26	1.98	9.83	2.05	11.28	2.09	12.24	2.11
	25	13.25	2.32	11.87	2.39	11.41	2.42	10.50	2.46	11.51	2.48	12.19	2.49
	29	12.57	2.84	11.85	2.86	11.61	2.87	11.13	2.89	11.71	2.89	12.09	2.90
	32	11.75	3.12	11.57	3.12	11.52	3.12	11.40	3.12	11.77	3.13	12.01	3.13
	35	11.33	3.32	11.41	3.31	11.44	3.30	11.50	3.29	11.75	3.29	11.91	3.29
	40	10.92	3.45	11.10	3.43	11.17	3.42	11.29	3.41	11.54	3.41	11.71	3.40
	43	10.82	3.42	10.88	3.40	10.90	3.40	10.94	3.39	11.32	3.39	11.57	3.39
	46	10.88	3.29	10.66	3.29	10.58	3.29	10.43	3.29	11.03	3.30	11.43	3.30
1.6 + 1.6 + 4.2 + 4.2 + 6.0	22	14.11	1.83	11.97	1.94	11.26	1.98	9.83	2.05	11.28	2.09	12.24	2.11
	25	13.25	2.32	11.87	2.39	11.41	2.42	10.50	2.46	11.51	2.48	12.19	2.49
	29	12.57	2.84	11.85	2.86	11.61	2.87	11.13	2.89	11.71	2.89	12.09	2.90
	32	11.75	3.12	11.57	3.12	11.52	3.12	11.40	3.12	11.77	3.13	12.01	3.13
	35	11.33	3.32	11.41	3.31	11.44	3.30	11.50	3.29	11.75	3.29	11.91	3.29
	40	10.92	3.45	11.10	3.43	11.17	3.42	11.29	3.41	11.54	3.41	11.71	3.40
	43	10.82	3.42	10.88	3.40	10.90	3.40	10.94	3.39	11.32	3.39	11.57	3.39
	46	10.88	3.29	10.66	3.29	10.58	3.29	10.43	3.29	11.03	3.30	11.43	3.30
1.6 + 1.6 + 4.2 + 5.0 + 5.0	22	14.11	1.80	11.97	1.91	11.26	1.95	9.83	2.02	11.28	2.05	12.24	2.07
	25	13.25	2.29	11.87	2.36	11.41	2.38	10.50	2.43	11.51	2.44	12.19	2.45
	29	12.57	2.79	11.85	2.82	11.61	2.83	11.13	2.85	11.71	2.85	12.09	2.85
	32	11.75	3.08	11.57	3.08	11.52	3.08	11.40	3.08	11.77	3.08	12.01	3.09
	35	11.33	3.27	11.41	3.26	11.44	3.25	11.50	3.24	11.75	3.24	11.91	3.24
	40	10.92	3.39	11.10	3.38	11.17	3.37	11.29	3.36	11.54	3.35	11.71	3.35
	43	10.82	3.37	10.88	3.35	10.90	3.35	10.94	3.33	11.32	3.33	11.57	3.33
	46	10.88	3.24	10.66	3.24	10.58	3.24	10.43	3.24	11.03	3.25	11.43	3.25
1.6 + 1.6 + 5.0 + 5.0 + 5.0	22	14.11	1.82	11.97	1.93	11.26	1.97	9.83	2.04	11.28	2.07	12.24	2.09
	25	13.25	2.31	11.87	2.38	11.41	2.40	10.50	2.45	11.51	2.46	12.19	2.47
	29	12.57	2.82	11.85	2.85	11.61	2.85	11.13	2.87	11.71	2.88	12.09	2.88
	32	11.75	3.11	11.57	3.11	11.52	3.11	11.40	3.11	11.77	3.11	12.01	3.11
	35	11.33	3.30	11.41	3.29	11.44	3.28	11.50	3.27	11.75	3.27	11.91	3.27
	40	10.92	3.43	11.10	3.41	11.17	3.40	11.29	3.39	11.54	3.39	11.71	3.38
	43	10.82	3.40	10.88	3.38	10.90	3.38	10.94	3.37	11.32	3.37	11.57	3.37
	46	10.88	3.27	10.66	3.27	10.58	3.27	10.43	3.27	11.03	3.28	11.43	3.28
1.6 + 2.0 + 2.0 + 2.0 + 2.0	22	14.11	1.94	11.97	2.06	11.26	2.10	9.83	2.18	11.28	2.21	12.24	2.23
	25	13.25	2.47	11.87	2.54	11.41	2.56	10.50	2.61	11.51	2.63	12.19	2.64
	29	12.57	3.01	11.85	3.04	11.61	3.05	11.13	3.07	11.71	3.07	12.09	3.07
	32	11.75	3.31	11.57	3.31	11.52	3.31	11.40	3.31	11.77	3.32	12.01	3.32
	35	11.33	3.53	11.41	3.51	11.44	3.50	11.50	3.49	11.75	3.49	11.91	3.49
	40	10.92	3.66	11.10	3.64	11.17	3.63	11.29	3.62	11.54	3.61	11.71	3.61
	43	10.82	3.63	10.88	3.61	10.90	3.60	10.94	3.59	11.32	3.59	11.57	3.59
	46	10.88	3.49	10.66	3.49	10.58	3.49	10.43	3.49	11.03	3.50	11.43	3.50

Combination (Capacity)	Outdoor Air Temp. °C DB	Indoor Air Temp. °C											
		27/16		27/17.5		27/18		27/19		27/22		27/24	
		Total Q	Input Power	Total Q	Input Power	Total Q	Input Power	Total Q	Input Power	Total Q	Input Power	Total Q	Input Power
1.6 + 2.0 + 2.0 + 2.0 + 2.5	22	14.11	1.94	11.97	2.06	11.26	2.10	9.83	2.18	11.28	2.21	12.24	2.23
	25	13.25	2.47	11.87	2.54	11.41	2.56	10.50	2.61	11.51	2.63	12.19	2.64
	29	12.57	3.01	11.85	3.04	11.61	3.05	11.13	3.07	11.71	3.07	12.09	3.07
	32	11.75	3.31	11.57	3.31	11.52	3.31	11.40	3.31	11.77	3.32	12.01	3.32
	35	11.33	3.53	11.41	3.51	11.44	3.50	11.50	3.49	11.75	3.49	11.91	3.49
	40	10.92	3.66	11.10	3.64	11.17	3.63	11.29	3.62	11.54	3.61	11.71	3.61
	43	10.82	3.63	10.88	3.61	10.90	3.60	10.94	3.59	11.32	3.59	11.57	3.59
	46	10.88	3.49	10.66	3.49	10.58	3.49	10.43	3.49	11.03	3.50	11.43	3.50
1.6 + 2.0 + 2.0 + 2.0 + 3.5	22	14.11	1.89	11.97	2.01	11.26	2.05	9.83	2.13	11.28	2.16	12.24	2.18
	25	13.25	2.41	11.87	2.48	11.41	2.50	10.50	2.55	11.51	2.57	12.19	2.58
	29	12.57	2.94	11.85	2.97	11.61	2.98	11.13	3.00	11.71	3.00	12.09	3.00
	32	11.75	3.24	11.57	3.24	11.52	3.24	11.40	3.24	11.77	3.24	12.01	3.25
	35	11.33	3.45	11.41	3.43	11.44	3.42	11.50	3.41	11.75	3.41	11.91	3.41
	40	10.92	3.57	11.10	3.55	11.17	3.55	11.29	3.54	11.54	3.53	11.71	3.53
	43	10.82	3.55	10.88	3.53	10.90	3.52	10.94	3.51	11.32	3.51	11.57	3.51
	46	10.88	3.41	10.66	3.41	10.58	3.41	10.43	3.41	11.03	3.42	11.43	3.42
1.6 + 2.0 + 2.0 + 2.0 + 4.2	22	14.11	1.89	11.97	2.01	11.26	2.05	9.83	2.13	11.28	2.16	12.24	2.18
	25	13.25	2.41	11.87	2.48	11.41	2.50	10.50	2.55	11.51	2.57	12.19	2.58
	29	12.57	2.94	11.85	2.97	11.61	2.98	11.13	3.00	11.71	3.00	12.09	3.00
	32	11.75	3.24	11.57	3.24	11.52	3.24	11.40	3.24	11.77	3.24	12.01	3.25
	35	11.33	3.45	11.41	3.43	11.44	3.42	11.50	3.41	11.75	3.41	11.91	3.41
	40	10.92	3.57	11.10	3.55	11.17	3.55	11.29	3.54	11.54	3.53	11.71	3.53
	43	10.82	3.55	10.88	3.53	10.90	3.52	10.94	3.51	11.32	3.51	11.57	3.51
	46	10.88	3.41	10.66	3.41	10.58	3.41	10.43	3.41	11.03	3.42	11.43	3.42
1.6 + 2.0 + 2.0 + 2.0 + 5.0	22	14.11	1.82	11.97	1.94	11.26	1.97	9.83	2.05	11.28	2.08	12.24	2.10
	25	13.25	2.32	11.87	2.39	11.41	2.41	10.50	2.46	11.51	2.47	12.19	2.48
	29	12.57	2.83	11.85	2.85	11.61	2.86	11.13	2.88	11.71	2.89	12.09	2.89
	32	11.75	3.12	11.57	3.12	11.52	3.12	11.40	3.12	11.77	3.12	12.01	3.12
	35	11.33	3.31	11.41	3.30	11.44	3.29	11.50	3.28	11.75	3.28	11.91	3.28
	40	10.92	3.44	11.10	3.42	11.17	3.41	11.29	3.40	11.54	3.40	11.71	3.39
	43	10.82	3.41	10.88	3.39	10.90	3.39	10.94	3.38	11.32	3.38	11.57	3.38
	46	10.88	3.28	10.66	3.28	10.58	3.28	10.43	3.28	11.03	3.29	11.43	3.29
1.6 + 2.0 + 2.0 + 2.0 + 6.0	22	14.11	1.82	11.97	1.94	11.26	1.97	9.83	2.05	11.28	2.08	12.24	2.10
	25	13.25	2.32	11.87	2.39	11.41	2.41	10.50	2.46	11.51	2.47	12.19	2.48
	29	12.57	2.83	11.85	2.85	11.61	2.86	11.13	2.88	11.71	2.89	12.09	2.89
	32	11.75	3.12	11.57	3.12	11.52	3.12	11.40	3.12	11.77	3.12	12.01	3.12
	35	11.33	3.31	11.41	3.30	11.44	3.29	11.50	3.28	11.75	3.28	11.91	3.28
	40	10.92	3.44	11.10	3.42	11.17	3.41	11.29	3.40	11.54	3.40	11.71	3.39
	43	10.82	3.41	10.88	3.39	10.90	3.39	10.94	3.38	11.32	3.38	11.57	3.38
	46	10.88	3.28	10.66	3.28	10.58	3.28	10.43	3.28	11.03	3.29	11.43	3.29

Combination (Capacity)	Outdoor Air Temp. °C DB	Indoor Air Temp. °C											
		27/16		27/17.5		27/18		27/19		27/22		27/24	
		Total Q	Input Power	Total Q	Input Power	Total Q	Input Power	Total Q	Input Power	Total Q	Input Power	Total Q	Input Power
1.6 + 2.0 + 2.0 + 2.0 + 7.1	22	14.11	1.82	11.97	1.94	11.26	1.97	9.83	2.05	11.28	2.08	12.24	2.10
	25	13.25	2.32	11.87	2.39	11.41	2.41	10.50	2.46	11.51	2.47	12.19	2.48
	29	12.57	2.83	11.85	2.85	11.61	2.86	11.13	2.88	11.71	2.89	12.09	2.89
	32	11.75	3.12	11.57	3.12	11.52	3.12	11.40	3.12	11.77	3.12	12.01	3.12
	35	11.33	3.31	11.41	3.30	11.44	3.29	11.50	3.28	11.75	3.28	11.91	3.28
	40	10.92	3.44	11.10	3.42	11.17	3.41	11.29	3.40	11.54	3.40	11.71	3.39
	43	10.82	3.41	10.88	3.39	10.90	3.39	10.94	3.38	11.32	3.38	11.57	3.38
	46	10.88	3.28	10.66	3.28	10.58	3.28	10.43	3.28	11.03	3.29	11.43	3.29
1.6 + 2.0 + 2.0 + 2.5 + 2.5	22	14.11	1.94	11.97	2.06	11.26	2.10	9.83	2.18	11.28	2.21	12.24	2.23
	25	13.25	2.47	11.87	2.54	11.41	2.56	10.50	2.61	11.51	2.63	12.19	2.64
	29	12.57	3.01	11.85	3.04	11.61	3.05	11.13	3.07	11.71	3.07	12.09	3.07
	32	11.75	3.31	11.57	3.31	11.52	3.31	11.40	3.31	11.77	3.32	12.01	3.32
	35	11.33	3.53	11.41	3.51	11.44	3.50	11.50	3.49	11.75	3.49	11.91	3.49
	40	10.92	3.66	11.10	3.64	11.17	3.63	11.29	3.62	11.54	3.61	11.71	3.61
	43	10.82	3.63	10.88	3.61	10.90	3.60	10.94	3.59	11.32	3.59	11.57	3.59
	46	10.88	3.49	10.66	3.49	10.58	3.49	10.43	3.49	11.03	3.50	11.43	3.50
1.6 + 2.0 + 2.0 + 2.5 + 3.5	22	14.11	1.89	11.97	2.01	11.26	2.05	9.83	2.13	11.28	2.16	12.24	2.18
	25	13.25	2.41	11.87	2.48	11.41	2.50	10.50	2.55	11.51	2.57	12.19	2.58
	29	12.57	2.94	11.85	2.97	11.61	2.98	11.13	3.00	11.71	3.00	12.09	3.00
	32	11.75	3.24	11.57	3.24	11.52	3.24	11.40	3.24	11.77	3.24	12.01	3.25
	35	11.33	3.45	11.41	3.43	11.44	3.42	11.50	3.41	11.75	3.41	11.91	3.41
	40	10.92	3.57	11.10	3.55	11.17	3.55	11.29	3.54	11.54	3.53	11.71	3.53
	43	10.82	3.55	10.88	3.53	10.90	3.52	10.94	3.51	11.32	3.51	11.57	3.51
	46	10.88	3.41	10.66	3.41	10.58	3.41	10.43	3.41	11.03	3.42	11.43	3.42
1.6 + 2.0 + 2.0 + 2.5 + 4.2	22	14.11	1.89	11.97	2.01	11.26	2.05	9.83	2.13	11.28	2.16	12.24	2.18
	25	13.25	2.41	11.87	2.48	11.41	2.50	10.50	2.55	11.51	2.57	12.19	2.58
	29	12.57	2.94	11.85	2.97	11.61	2.98	11.13	3.00	11.71	3.00	12.09	3.00
	32	11.75	3.24	11.57	3.24	11.52	3.24	11.40	3.24	11.77	3.24	12.01	3.25
	35	11.33	3.45	11.41	3.43	11.44	3.42	11.50	3.41	11.75	3.41	11.91	3.41
	40	10.92	3.57	11.10	3.55	11.17	3.55	11.29	3.54	11.54	3.53	11.71	3.53
	43	10.82	3.55	10.88	3.53	10.90	3.52	10.94	3.51	11.32	3.51	11.57	3.51
	46	10.88	3.41	10.66	3.41	10.58	3.41	10.43	3.41	11.03	3.42	11.43	3.42
1.6 + 2.0 + 2.0 + 2.5 + 5.0	22	14.11	1.82	11.97	1.94	11.26	1.97	9.83	2.05	11.28	2.08	12.24	2.10
	25	13.25	2.32	11.87	2.39	11.41	2.41	10.50	2.46	11.51	2.47	12.19	2.48
	29	12.57	2.83	11.85	2.85	11.61	2.86	11.13	2.88	11.71	2.89	12.09	2.89
	32	11.75	3.12	11.57	3.12	11.52	3.12	11.40	3.12	11.77	3.12	12.01	3.12
	35	11.33	3.31	11.41	3.30	11.44	3.29	11.50	3.28	11.75	3.28	11.91	3.28
	40	10.92	3.44	11.10	3.42	11.17	3.41	11.29	3.40	11.54	3.40	11.71	3.39
	43	10.82	3.41	10.88	3.39	10.90	3.39	10.94	3.38	11.32	3.38	11.57	3.38
	46	10.88	3.28	10.66	3.28	10.58	3.28	10.43	3.28	11.03	3.29	11.43	3.29

Combination (Capacity)	Outdoor Air Temp. °C DB	Indoor Air Temp. °C											
		27/16		27/17.5		27/18		27/19		27/22		27/24	
		Total Q	Input Power	Total Q	Input Power	Total Q	Input Power	Total Q	Input Power	Total Q	Input Power	Total Q	Input Power
1.6 + 2.0 + 2.0 + 2.5 + 6.0	22	14.11	1.82	11.97	1.94	11.26	1.97	9.83	2.05	11.28	2.08	12.24	2.10
	25	13.25	2.32	11.87	2.39	11.41	2.41	10.50	2.46	11.51	2.47	12.19	2.48
	29	12.57	2.83	11.85	2.85	11.61	2.86	11.13	2.88	11.71	2.89	12.09	2.89
	32	11.75	3.12	11.57	3.12	11.52	3.12	11.40	3.12	11.77	3.12	12.01	3.12
	35	11.33	3.31	11.41	3.30	11.44	3.29	11.50	3.28	11.75	3.28	11.91	3.28
	40	10.92	3.44	11.10	3.42	11.17	3.41	11.29	3.40	11.54	3.40	11.71	3.39
	43	10.82	3.41	10.88	3.39	10.90	3.39	10.94	3.38	11.32	3.38	11.57	3.38
	46	10.88	3.28	10.66	3.28	10.58	3.28	10.43	3.28	11.03	3.29	11.43	3.29
1.6 + 2.0 + 2.0 + 2.5 + 7.1	22	14.11	1.82	11.97	1.94	11.26	1.97	9.83	2.05	11.28	2.08	12.24	2.10
	25	13.25	2.32	11.87	2.39	11.41	2.41	10.50	2.46	11.51	2.47	12.19	2.48
	29	12.57	2.83	11.85	2.85	11.61	2.86	11.13	2.88	11.71	2.89	12.09	2.89
	32	11.75	3.12	11.57	3.12	11.52	3.12	11.40	3.12	11.77	3.12	12.01	3.12
	35	11.33	3.31	11.41	3.30	11.44	3.29	11.50	3.28	11.75	3.28	11.91	3.28
	40	10.92	3.44	11.10	3.42	11.17	3.41	11.29	3.40	11.54	3.40	11.71	3.39
	43	10.82	3.41	10.88	3.39	10.90	3.39	10.94	3.38	11.32	3.38	11.57	3.38
	46	10.88	3.28	10.66	3.28	10.58	3.28	10.43	3.28	11.03	3.29	11.43	3.29
1.6 + 2.0 + 2.0 + 3.5 + 3.5	22	14.11	1.89	11.97	2.01	11.26	2.05	9.83	2.13	11.28	2.16	12.24	2.18
	25	13.25	2.41	11.87	2.48	11.41	2.50	10.50	2.55	11.51	2.57	12.19	2.58
	29	12.57	2.94	11.85	2.97	11.61	2.98	11.13	3.00	11.71	3.00	12.09	3.00
	32	11.75	3.24	11.57	3.24	11.52	3.24	11.40	3.24	11.77	3.24	12.01	3.25
	35	11.33	3.45	11.41	3.43	11.44	3.42	11.50	3.41	11.75	3.41	11.91	3.41
	40	10.92	3.57	11.10	3.55	11.17	3.55	11.29	3.54	11.54	3.53	11.71	3.53
	43	10.82	3.55	10.88	3.53	10.90	3.52	10.94	3.51	11.32	3.51	11.57	3.51
	46	10.88	3.41	10.66	3.41	10.58	3.41	10.43	3.41	11.03	3.42	11.43	3.42
1.6 + 2.0 + 2.0 + 3.5 + 4.2	22	14.11	1.90	11.97	2.02	11.26	2.06	9.83	2.14	11.28	2.17	12.24	2.19
	25	13.25	2.42	11.87	2.49	11.41	2.51	10.50	2.56	11.51	2.58	12.19	2.59
	29	12.57	2.95	11.85	2.98	11.61	2.99	11.13	3.00	11.71	3.01	12.09	3.01
	32	11.75	3.25	11.57	3.25	11.52	3.25	11.40	3.25	11.77	3.25	12.01	3.26
	35	11.33	3.46	11.41	3.44	11.44	3.43	11.50	3.42	11.75	3.42	11.91	3.42
	40	10.92	3.58	11.10	3.56	11.17	3.56	11.29	3.55	11.54	3.54	11.71	3.54
	43	10.82	3.56	10.88	3.54	10.90	3.53	10.94	3.52	11.32	3.52	11.57	3.52
	46	10.88	3.42	10.66	3.42	10.58	3.42	10.43	3.42	11.03	3.43	11.43	3.43
1.6 + 2.0 + 2.0 + 3.5 + 5.0	22	14.11	1.82	11.97	1.94	11.26	1.97	9.83	2.05	11.28	2.08	12.24	2.10
	25	13.25	2.32	11.87	2.39	11.41	2.41	10.50	2.46	11.51	2.47	12.19	2.48
	29	12.57	2.83	11.85	2.85	11.61	2.86	11.13	2.88	11.71	2.89	12.09	2.89
	32	11.75	3.12	11.57	3.12	11.52	3.12	11.40	3.12	11.77	3.12	12.01	3.12
	35	11.33	3.31	11.41	3.30	11.44	3.29	11.50	3.28	11.75	3.28	11.91	3.28
	40	10.92	3.44	11.10	3.42	11.17	3.41	11.29	3.40	11.54	3.40	11.71	3.39
	43	10.82	3.41	10.88	3.39	10.90	3.39	10.94	3.38	11.32	3.38	11.57	3.38
	46	10.88	3.28	10.66	3.28	10.58	3.28	10.43	3.28	11.03	3.29	11.43	3.29

Combination (Capacity)	Outdoor Air Temp. °C DB	Indoor Air Temp. °C											
		27/16		27/17.5		27/18		27/19		27/22		27/24	
		Total Q	Input Power	Total Q	Input Power	Total Q	Input Power	Total Q	Input Power	Total Q	Input Power	Total Q	Input Power
1.6 + 2.0 + 2.0 + 3.5 + 6.0	22	14.11	1.82	11.97	1.94	11.26	1.97	9.83	2.05	11.28	2.08	12.24	2.10
	25	13.25	2.32	11.87	2.39	11.41	2.41	10.50	2.46	11.51	2.47	12.19	2.48
	29	12.57	2.83	11.85	2.85	11.61	2.86	11.13	2.88	11.71	2.89	12.09	2.89
	32	11.75	3.12	11.57	3.12	11.52	3.12	11.40	3.12	11.77	3.12	12.01	3.12
	35	11.33	3.31	11.41	3.30	11.44	3.29	11.50	3.28	11.75	3.28	11.91	3.28
	40	10.92	3.44	11.10	3.42	11.17	3.41	11.29	3.40	11.54	3.40	11.71	3.39
	43	10.82	3.41	10.88	3.39	10.90	3.39	10.94	3.38	11.32	3.38	11.57	3.38
	46	10.88	3.28	10.66	3.28	10.58	3.28	10.43	3.28	11.03	3.29	11.43	3.29
1.6 + 2.0 + 2.0 + 3.5 + 7.1	22	14.11	1.83	11.97	1.94	11.26	1.98	9.83	2.05	11.28	2.09	12.24	2.11
	25	13.25	2.32	11.87	2.39	11.41	2.42	10.50	2.46	11.51	2.48	12.19	2.49
	29	12.57	2.84	11.85	2.86	11.61	2.87	11.13	2.89	11.71	2.89	12.09	2.90
	32	11.75	3.12	11.57	3.12	11.52	3.12	11.40	3.12	11.77	3.13	12.01	3.13
	35	11.33	3.32	11.41	3.31	11.44	3.30	11.50	3.29	11.75	3.29	11.91	3.29
	40	10.92	3.45	11.10	3.43	11.17	3.42	11.29	3.41	11.54	3.41	11.71	3.40
	43	10.82	3.42	10.88	3.40	10.90	3.40	10.94	3.39	11.32	3.39	11.57	3.39
	46	10.88	3.29	10.66	3.29	10.58	3.29	10.43	3.29	11.03	3.30	11.43	3.30
1.6 + 2.0 + 2.0 + 4.2 + 4.2	22	14.11	1.90	11.97	2.02	11.26	2.06	9.83	2.14	11.28	2.17	12.24	2.19
	25	13.25	2.42	11.87	2.49	11.41	2.51	10.50	2.56	11.51	2.58	12.19	2.59
	29	12.57	2.95	11.85	2.98	11.61	2.99	11.13	3.00	11.71	3.01	12.09	3.01
	32	11.75	3.25	11.57	3.25	11.52	3.25	11.40	3.25	11.77	3.25	12.01	3.26
	35	11.33	3.46	11.41	3.44	11.44	3.43	11.50	3.42	11.75	3.42	11.91	3.42
	40	10.92	3.58	11.10	3.56	11.17	3.56	11.29	3.55	11.54	3.54	11.71	3.54
	43	10.82	3.56	10.88	3.54	10.90	3.53	10.94	3.52	11.32	3.52	11.57	3.52
	46	10.88	3.42	10.66	3.42	10.58	3.42	10.43	3.42	11.03	3.43	11.43	3.43
1.6 + 2.0 + 2.0 + 4.2 + 5.0	22	14.11	1.82	11.97	1.94	11.26	1.97	9.83	2.05	11.28	2.08	12.24	2.10
	25	13.25	2.32	11.87	2.39	11.41	2.41	10.50	2.46	11.51	2.47	12.19	2.48
	29	12.57	2.83	11.85	2.85	11.61	2.86	11.13	2.88	11.71	2.89	12.09	2.89
	32	11.75	3.12	11.57	3.12	11.52	3.12	11.40	3.12	11.77	3.12	12.01	3.12
	35	11.33	3.31	11.41	3.30	11.44	3.29	11.50	3.28	11.75	3.28	11.91	3.28
	40	10.92	3.44	11.10	3.42	11.17	3.41	11.29	3.40	11.54	3.40	11.71	3.39
	43	10.82	3.41	10.88	3.39	10.90	3.39	10.94	3.38	11.32	3.38	11.57	3.38
	46	10.88	3.28	10.66	3.28	10.58	3.28	10.43	3.28	11.03	3.29	11.43	3.29
1.6 + 2.0 + 2.0 + 4.2 + 6.0	22	14.11	1.82	11.97	1.94	11.26	1.97	9.83	2.05	11.28	2.08	12.24	2.10
	25	13.25	2.32	11.87	2.39	11.41	2.41	10.50	2.46	11.51	2.47	12.19	2.48
	29	12.57	2.83	11.85	2.85	11.61	2.86	11.13	2.88	11.71	2.89	12.09	2.89
	32	11.75	3.12	11.57	3.12	11.52	3.12	11.40	3.12	11.77	3.12	12.01	3.12
	35	11.33	3.31	11.41	3.30	11.44	3.29	11.50	3.28	11.75	3.28	11.91	3.28
	40	10.92	3.44	11.10	3.42	11.17	3.41	11.29	3.40	11.54	3.40	11.71	3.39
	43	10.82	3.41	10.88	3.39	10.90	3.39	10.94	3.38	11.32	3.38	11.57	3.38
	46	10.88	3.28	10.66	3.28	10.58	3.28	10.43	3.28	11.03	3.29	11.43	3.29

Combination (Capacity)	Outdoor Air Temp. °C DB	Indoor Air Temp. °C											
		27/16		27/17.5		27/18		27/19		27/22		27/24	
		Total Q	Input Power	Total Q	Input Power	Total Q	Input Power	Total Q	Input Power	Total Q	Input Power	Total Q	Input Power
1.6 + 2.0 + 2.0 + 4.2 + 7.1	22	14.11	1.83	11.97	1.94	11.26	1.98	9.83	2.05	11.28	2.09	12.24	2.11
	25	13.25	2.32	11.87	2.39	11.41	2.42	10.50	2.46	11.51	2.48	12.19	2.49
	29	12.57	2.84	11.85	2.86	11.61	2.87	11.13	2.89	11.71	2.89	12.09	2.90
	32	11.75	3.12	11.57	3.12	11.52	3.12	11.40	3.12	11.77	3.13	12.01	3.13
	35	11.33	3.32	11.41	3.31	11.44	3.30	11.50	3.29	11.75	3.29	11.91	3.29
	40	10.92	3.45	11.10	3.43	11.17	3.42	11.29	3.41	11.54	3.41	11.71	3.40
	43	10.82	3.42	10.88	3.40	10.90	3.40	10.94	3.39	11.32	3.39	11.57	3.39
	46	10.88	3.29	10.66	3.29	10.58	3.29	10.43	3.29	11.03	3.30	11.43	3.30
1.6 + 2.0 + 2.0 + 5.0 + 5.0	22	14.11	1.79	11.97	1.91	11.26	1.94	9.83	2.02	11.28	2.05	12.24	2.07
	25	13.25	2.28	11.87	2.35	11.41	2.37	10.50	2.42	11.51	2.43	12.19	2.44
	29	12.57	2.79	11.85	2.81	11.61	2.82	11.13	2.84	11.71	2.84	12.09	2.85
	32	11.75	3.07	11.57	3.07	11.52	3.07	11.40	3.07	11.77	3.07	12.01	3.08
	35	11.33	3.26	11.41	3.25	11.44	3.24	11.50	3.23	11.75	3.23	11.91	3.23
	40	10.92	3.38	11.10	3.37	11.17	3.36	11.29	3.35	11.54	3.34	11.71	3.34
	43	10.82	3.36	10.88	3.34	10.90	3.34	10.94	3.32	11.32	3.32	11.57	3.32
	46	10.88	3.23	10.66	3.23	10.58	3.23	10.43	3.23	11.03	3.24	11.43	3.24
1.6 + 2.0 + 2.0 + 5.0 + 6.0	22	14.11	1.79	11.97	1.91	11.26	1.94	9.83	2.02	11.28	2.05	12.24	2.07
	25	13.25	2.28	11.87	2.35	11.41	2.37	10.50	2.42	11.51	2.43	12.19	2.44
	29	12.57	2.79	11.85	2.81	11.61	2.82	11.13	2.84	11.71	2.84	12.09	2.85
	32	11.75	3.07	11.57	3.07	11.52	3.07	11.40	3.07	11.77	3.07	12.01	3.08
	35	11.33	3.26	11.41	3.25	11.44	3.24	11.50	3.23	11.75	3.23	11.91	3.23
	40	10.92	3.38	11.10	3.37	11.17	3.36	11.29	3.35	11.54	3.34	11.71	3.34
	43	10.82	3.36	10.88	3.34	10.90	3.34	10.94	3.32	11.32	3.32	11.57	3.32
	46	10.88	3.23	10.66	3.23	10.58	3.23	10.43	3.23	11.03	3.24	11.43	3.24
1.6 + 2.0 + 2.0 + 5.0 + 7.1	22	14.11	1.80	11.97	1.91	11.26	1.95	9.83	2.02	11.28	2.05	12.24	2.07
	25	13.25	2.29	11.87	2.36	11.41	2.38	10.50	2.43	11.51	2.44	12.19	2.45
	29	12.57	2.79	11.85	2.82	11.61	2.83	11.13	2.85	11.71	2.85	12.09	2.85
	32	11.75	3.08	11.57	3.08	11.52	3.08	11.40	3.08	11.77	3.08	12.01	3.09
	35	11.33	3.27	11.41	3.26	11.44	3.25	11.50	3.24	11.75	3.24	11.91	3.24
	40	10.92	3.39	11.10	3.38	11.17	3.37	11.29	3.36	11.54	3.35	11.71	3.35
	43	10.82	3.37	10.88	3.35	10.90	3.35	10.94	3.33	11.32	3.33	11.57	3.33
	46	10.88	3.24	10.66	3.24	10.58	3.24	10.43	3.24	11.03	3.25	11.43	3.25
1.6 + 2.0 + 2.0 + 6.0 + 6.0	22	14.11	1.79	11.97	1.91	11.26	1.94	9.83	2.02	11.28	2.05	12.24	2.07
	25	13.25	2.28	11.87	2.35	11.41	2.37	10.50	2.42	11.51	2.43	12.19	2.44
	29	12.57	2.79	11.85	2.81	11.61	2.82	11.13	2.84	11.71	2.84	12.09	2.85
	32	11.75	3.07	11.57	3.07	11.52	3.07	11.40	3.07	11.77	3.07	12.01	3.08
	35	11.33	3.26	11.41	3.25	11.44	3.24	11.50	3.23	11.75	3.23	11.91	3.23
	40	10.92	3.38	11.10	3.37	11.17	3.36	11.29	3.35	11.54	3.34	11.71	3.34
	43	10.82	3.36	10.88	3.34	10.90	3.34	10.94	3.32	11.32	3.32	11.57	3.32
	46	10.88	3.23	10.66	3.23	10.58	3.23	10.43	3.23	11.03	3.24	11.43	3.24



Combination (Capacity)	Outdoor Air Temp. °C DB	Indoor Air Temp. °C											
		27/16		27/17.5		27/18		27/19		27/22		27/24	
		Total Q	Input Power	Total Q	Input Power	Total Q	Input Power	Total Q	Input Power	Total Q	Input Power	Total Q	Input Power
1.6 + 2.0 + 2.5 + 2.5 + 2.5	22	14.11	1.94	11.97	2.06	11.26	2.10	9.83	2.18	11.28	2.21	12.24	2.23
	25	13.25	2.47	11.87	2.54	11.41	2.56	10.50	2.61	11.51	2.63	12.19	2.64
	29	12.57	3.01	11.85	3.04	11.61	3.05	11.13	3.07	11.71	3.07	12.09	3.07
	32	11.75	3.31	11.57	3.31	11.52	3.31	11.40	3.31	11.77	3.32	12.01	3.32
	35	11.33	3.53	11.41	3.51	11.44	3.50	11.50	3.49	11.75	3.49	11.91	3.49
	40	10.92	3.66	11.10	3.64	11.17	3.63	11.29	3.62	11.54	3.61	11.71	3.61
	43	10.82	3.63	10.88	3.61	10.90	3.60	10.94	3.59	11.32	3.59	11.57	3.59
	46	10.88	3.49	10.66	3.49	10.58	3.49	10.43	3.49	11.03	3.50	11.43	3.50
1.6 + 2.0 + 2.5 + 2.5 + 3.5	22	14.11	1.89	11.97	2.01	11.26	2.05	9.83	2.13	11.28	2.16	12.24	2.18
	25	13.25	2.41	11.87	2.48	11.41	2.50	10.50	2.55	11.51	2.57	12.19	2.58
	29	12.57	2.94	11.85	2.97	11.61	2.98	11.13	3.00	11.71	3.00	12.09	3.00
	32	11.75	3.24	11.57	3.24	11.52	3.24	11.40	3.24	11.77	3.24	12.01	3.25
	35	11.33	3.45	11.41	3.43	11.44	3.42	11.50	3.41	11.75	3.41	11.91	3.41
	40	10.92	3.57	11.10	3.55	11.17	3.55	11.29	3.54	11.54	3.53	11.71	3.53
	43	10.82	3.55	10.88	3.53	10.90	3.52	10.94	3.51	11.32	3.51	11.57	3.51
	46	10.88	3.41	10.66	3.41	10.58	3.41	10.43	3.41	11.03	3.42	11.43	3.42
1.6 + 2.0 + 2.5 + 2.5 + 4.2	22	14.11	1.89	11.97	2.01	11.26	2.05	9.83	2.13	11.28	2.16	12.24	2.18
	25	13.25	2.41	11.87	2.48	11.41	2.50	10.50	2.55	11.51	2.57	12.19	2.58
	29	12.57	2.94	11.85	2.97	11.61	2.98	11.13	3.00	11.71	3.00	12.09	3.00
	32	11.75	3.24	11.57	3.24	11.52	3.24	11.40	3.24	11.77	3.24	12.01	3.25
	35	11.33	3.45	11.41	3.43	11.44	3.42	11.50	3.41	11.75	3.41	11.91	3.41
	40	10.92	3.57	11.10	3.55	11.17	3.55	11.29	3.54	11.54	3.53	11.71	3.53
	43	10.82	3.55	10.88	3.53	10.90	3.52	10.94	3.51	11.32	3.51	11.57	3.51
	46	10.88	3.41	10.66	3.41	10.58	3.41	10.43	3.41	11.03	3.42	11.43	3.42
1.6 + 2.0 + 2.5 + 2.5 + 5.0	22	14.11	1.82	11.97	1.94	11.26	1.97	9.83	2.05	11.28	2.08	12.24	2.10
	25	13.25	2.32	11.87	2.39	11.41	2.41	10.50	2.46	11.51	2.47	12.19	2.48
	29	12.57	2.83	11.85	2.85	11.61	2.86	11.13	2.88	11.71	2.89	12.09	2.89
	32	11.75	3.12	11.57	3.12	11.52	3.12	11.40	3.12	11.77	3.12	12.01	3.12
	35	11.33	3.31	11.41	3.30	11.44	3.29	11.50	3.28	11.75	3.28	11.91	3.28
	40	10.92	3.44	11.10	3.42	11.17	3.41	11.29	3.40	11.54	3.40	11.71	3.39
	43	10.82	3.41	10.88	3.39	10.90	3.39	10.94	3.38	11.32	3.38	11.57	3.38
	46	10.88	3.28	10.66	3.28	10.58	3.28	10.43	3.28	11.03	3.29	11.43	3.29
1.6 + 2.0 + 2.5 + 2.5 + 6.0	22	14.11	1.82	11.97	1.94	11.26	1.97	9.83	2.05	11.28	2.08	12.24	2.10
	25	13.25	2.32	11.87	2.39	11.41	2.41	10.50	2.46	11.51	2.47	12.19	2.48
	29	12.57	2.83	11.85	2.85	11.61	2.86	11.13	2.88	11.71	2.89	12.09	2.89
	32	11.75	3.12	11.57	3.12	11.52	3.12	11.40	3.12	11.77	3.12	12.01	3.12
	35	11.33	3.31	11.41	3.30	11.44	3.29	11.50	3.28	11.75	3.28	11.91	3.28
	40	10.92	3.44	11.10	3.42	11.17	3.41	11.29	3.40	11.54	3.40	11.71	3.39
	43	10.82	3.41	10.88	3.39	10.90	3.39	10.94	3.38	11.32	3.38	11.57	3.38
	46	10.88	3.28	10.66	3.28	10.58	3.28	10.43	3.28	11.03	3.29	11.43	3.29

Combination (Capacity)	Outdoor Air Temp. °C DB	Indoor Air Temp. °C											
		27/16		27/17.5		27/18		27/19		27/22		27/24	
		Total Q	Input Power	Total Q	Input Power	Total Q	Input Power	Total Q	Input Power	Total Q	Input Power	Total Q	Input Power
1.6 + 2.0 + 2.5 + 2.5 + 7.1	22	14.11	1.82	11.97	1.94	11.26	1.97	9.83	2.05	11.28	2.08	12.24	2.10
	25	13.25	2.32	11.87	2.39	11.41	2.41	10.50	2.46	11.51	2.47	12.19	2.48
	29	12.57	2.83	11.85	2.85	11.61	2.86	11.13	2.88	11.71	2.89	12.09	2.89
	32	11.75	3.12	11.57	3.12	11.52	3.12	11.40	3.12	11.77	3.12	12.01	3.12
	35	11.33	3.31	11.41	3.30	11.44	3.29	11.50	3.28	11.75	3.28	11.91	3.28
	40	10.92	3.44	11.10	3.42	11.17	3.41	11.29	3.40	11.54	3.40	11.71	3.39
	43	10.82	3.41	10.88	3.39	10.90	3.39	10.94	3.38	11.32	3.38	11.57	3.38
	46	10.88	3.28	10.66	3.28	10.58	3.28	10.43	3.28	11.03	3.29	11.43	3.29
1.6 + 2.0 + 2.5 + 3.5 + 3.5	22	14.11	1.89	11.97	2.01	11.26	2.05	9.83	2.13	11.28	2.16	12.24	2.18
	25	13.25	2.41	11.87	2.48	11.41	2.50	10.50	2.55	11.51	2.57	12.19	2.58
	29	12.57	2.94	11.85	2.97	11.61	2.98	11.13	3.00	11.71	3.00	12.09	3.00
	32	11.75	3.24	11.57	3.24	11.52	3.24	11.40	3.24	11.77	3.24	12.01	3.25
	35	11.33	3.45	11.41	3.43	11.44	3.42	11.50	3.41	11.75	3.41	11.91	3.41
	40	10.92	3.57	11.10	3.55	11.17	3.55	11.29	3.54	11.54	3.53	11.71	3.53
	43	10.82	3.55	10.88	3.53	10.90	3.52	10.94	3.51	11.32	3.51	11.57	3.51
	46	10.88	3.41	10.66	3.41	10.58	3.41	10.43	3.41	11.03	3.42	11.43	3.42
1.6 + 2.0 + 2.5 + 3.5 + 4.2	22	14.11	1.90	11.97	2.02	11.26	2.06	9.83	2.14	11.28	2.17	12.24	2.19
	25	13.25	2.42	11.87	2.49	11.41	2.51	10.50	2.56	11.51	2.58	12.19	2.59
	29	12.57	2.95	11.85	2.98	11.61	2.99	11.13	3.00	11.71	3.01	12.09	3.01
	32	11.75	3.25	11.57	3.25	11.52	3.25	11.40	3.25	11.77	3.25	12.01	3.26
	35	11.33	3.46	11.41	3.44	11.44	3.43	11.50	3.42	11.75	3.42	11.91	3.42
	40	10.92	3.58	11.10	3.56	11.17	3.56	11.29	3.55	11.54	3.54	11.71	3.54
	43	10.82	3.56	10.88	3.54	10.90	3.53	10.94	3.52	11.32	3.52	11.57	3.52
	46	10.88	3.42	10.66	3.42	10.58	3.42	10.43	3.42	11.03	3.43	11.43	3.43
1.6 + 2.0 + 2.5 + 3.5 + 5.0	22	14.11	1.82	11.97	1.94	11.26	1.97	9.83	2.05	11.28	2.08	12.24	2.10
	25	13.25	2.32	11.87	2.39	11.41	2.41	10.50	2.46	11.51	2.47	12.19	2.48
	29	12.57	2.83	11.85	2.85	11.61	2.86	11.13	2.88	11.71	2.89	12.09	2.89
	32	11.75	3.12	11.57	3.12	11.52	3.12	11.40	3.12	11.77	3.12	12.01	3.12
	35	11.33	3.31	11.41	3.30	11.44	3.29	11.50	3.28	11.75	3.28	11.91	3.28
	40	10.92	3.44	11.10	3.42	11.17	3.41	11.29	3.40	11.54	3.40	11.71	3.39
	43	10.82	3.41	10.88	3.39	10.90	3.39	10.94	3.38	11.32	3.38	11.57	3.38
	46	10.88	3.28	10.66	3.28	10.58	3.28	10.43	3.28	11.03	3.29	11.43	3.29
1.6 + 2.0 + 2.5 + 3.5 + 6.0	22	14.11	1.82	11.97	1.94	11.26	1.97	9.83	2.05	11.28	2.08	12.24	2.10
	25	13.25	2.32	11.87	2.39	11.41	2.41	10.50	2.46	11.51	2.47	12.19	2.48
	29	12.57	2.83	11.85	2.85	11.61	2.86	11.13	2.88	11.71	2.89	12.09	2.89
	32	11.75	3.12	11.57	3.12	11.52	3.12	11.40	3.12	11.77	3.12	12.01	3.12
	35	11.33	3.31	11.41	3.30	11.44	3.29	11.50	3.28	11.75	3.28	11.91	3.28
	40	10.92	3.44	11.10	3.42	11.17	3.41	11.29	3.40	11.54	3.40	11.71	3.39
	43	10.82	3.41	10.88	3.39	10.90	3.39	10.94	3.38	11.32	3.38	11.57	3.38
	46	10.88	3.28	10.66	3.28	10.58	3.28	10.43	3.28	11.03	3.29	11.43	3.29

Combination (Capacity)	Outdoor Air Temp. °C DB	Indoor Air Temp. °C											
		27/16		27/17.5		27/18		27/19		27/22		27/24	
		Total Q	Input Power	Total Q	Input Power	Total Q	Input Power	Total Q	Input Power	Total Q	Input Power	Total Q	Input Power
1.6 + 2.0 + 2.5 + 3.5 + 7.1	22	14.11	1.83	11.97	1.94	11.26	1.98	9.83	2.05	11.28	2.09	12.24	2.11
	25	13.25	2.32	11.87	2.39	11.41	2.42	10.50	2.46	11.51	2.48	12.19	2.49
	29	12.57	2.84	11.85	2.86	11.61	2.87	11.13	2.89	11.71	2.89	12.09	2.90
	32	11.75	3.12	11.57	3.12	11.52	3.12	11.40	3.12	11.77	3.13	12.01	3.13
	35	11.33	3.32	11.41	3.31	11.44	3.30	11.50	3.29	11.75	3.29	11.91	3.29
	40	10.92	3.45	11.10	3.43	11.17	3.42	11.29	3.41	11.54	3.41	11.71	3.40
	43	10.82	3.42	10.88	3.40	10.90	3.40	10.94	3.39	11.32	3.39	11.57	3.39
	46	10.88	3.29	10.66	3.29	10.58	3.29	10.43	3.29	11.03	3.30	11.43	3.30
1.6 + 2.0 + 2.5 + 4.2 + 4.2	22	14.11	1.90	11.97	2.02	11.26	2.06	9.83	2.14	11.28	2.17	12.24	2.19
	25	13.25	2.42	11.87	2.49	11.41	2.51	10.50	2.56	11.51	2.58	12.19	2.59
	29	12.57	2.95	11.85	2.98	11.61	2.99	11.13	3.00	11.71	3.01	12.09	3.01
	32	11.75	3.25	11.57	3.25	11.52	3.25	11.40	3.25	11.77	3.25	12.01	3.26
	35	11.33	3.46	11.41	3.44	11.44	3.43	11.50	3.42	11.75	3.42	11.91	3.42
	40	10.92	3.58	11.10	3.56	11.17	3.56	11.29	3.55	11.54	3.54	11.71	3.54
	43	10.82	3.56	10.88	3.54	10.90	3.53	10.94	3.52	11.32	3.52	11.57	3.52
	46	10.88	3.42	10.66	3.42	10.58	3.42	10.43	3.42	11.03	3.43	11.43	3.43
1.6 + 2.0 + 2.5 + 4.2 + 5.0	22	14.11	1.82	11.97	1.94	11.26	1.97	9.83	2.05	11.28	2.08	12.24	2.10
	25	13.25	2.32	11.87	2.39	11.41	2.41	10.50	2.46	11.51	2.47	12.19	2.48
	29	12.57	2.83	11.85	2.85	11.61	2.86	11.13	2.88	11.71	2.89	12.09	2.89
	32	11.75	3.12	11.57	3.12	11.52	3.12	11.40	3.12	11.77	3.12	12.01	3.12
	35	11.33	3.31	11.41	3.30	11.44	3.29	11.50	3.28	11.75	3.28	11.91	3.28
	40	10.92	3.44	11.10	3.42	11.17	3.41	11.29	3.40	11.54	3.40	11.71	3.39
	43	10.82	3.41	10.88	3.39	10.90	3.39	10.94	3.38	11.32	3.38	11.57	3.38
	46	10.88	3.28	10.66	3.28	10.58	3.28	10.43	3.28	11.03	3.29	11.43	3.29
1.6 + 2.0 + 2.5 + 4.2 + 6.0	22	14.11	1.82	11.97	1.94	11.26	1.97	9.83	2.05	11.28	2.08	12.24	2.10
	25	13.25	2.32	11.87	2.39	11.41	2.41	10.50	2.46	11.51	2.47	12.19	2.48
	29	12.57	2.83	11.85	2.85	11.61	2.86	11.13	2.88	11.71	2.89	12.09	2.89
	32	11.75	3.12	11.57	3.12	11.52	3.12	11.40	3.12	11.77	3.12	12.01	3.12
	35	11.33	3.31	11.41	3.30	11.44	3.29	11.50	3.28	11.75	3.28	11.91	3.28
	40	10.92	3.44	11.10	3.42	11.17	3.41	11.29	3.40	11.54	3.40	11.71	3.39
	43	10.82	3.41	10.88	3.39	10.90	3.39	10.94	3.38	11.32	3.38	11.57	3.38
	46	10.88	3.28	10.66	3.28	10.58	3.28	10.43	3.28	11.03	3.29	11.43	3.29
1.6 + 2.0 + 2.5 + 4.2 + 7.1	22	14.11	1.83	11.97	1.94	11.26	1.98	9.83	2.05	11.28	2.09	12.24	2.11
	25	13.25	2.32	11.87	2.39	11.41	2.42	10.50	2.46	11.51	2.48	12.19	2.49
	29	12.57	2.84	11.85	2.86	11.61	2.87	11.13	2.89	11.71	2.89	12.09	2.90
	32	11.75	3.12	11.57	3.12	11.52	3.12	11.40	3.12	11.77	3.13	12.01	3.13
	35	11.33	3.32	11.41	3.31	11.44	3.30	11.50	3.29	11.75	3.29	11.91	3.29
	40	10.92	3.45	11.10	3.43	11.17	3.42	11.29	3.41	11.54	3.41	11.71	3.40
	43	10.82	3.42	10.88	3.40	10.90	3.40	10.94	3.39	11.32	3.39	11.57	3.39
	46	10.88	3.29	10.66	3.29	10.58	3.29	10.43	3.29	11.03	3.30	11.43	3.30

Combination (Capacity)	Outdoor Air Temp. °C DB	Indoor Air Temp. °C											
		27/16		27/17.5		27/18		27/19		27/22		27/24	
		Total Q	Input Power	Total Q	Input Power	Total Q	Input Power	Total Q	Input Power	Total Q	Input Power	Total Q	Input Power
1.6 + 2.0 + 2.5 + 5.0 + 5.0	22	14.11	1.79	11.97	1.91	11.26	1.94	9.83	2.02	11.28	2.05	12.24	2.07
	25	13.25	2.28	11.87	2.35	11.41	2.37	10.50	2.42	11.51	2.43	12.19	2.44
	29	12.57	2.79	11.85	2.81	11.61	2.82	11.13	2.84	11.71	2.84	12.09	2.85
	32	11.75	3.07	11.57	3.07	11.52	3.07	11.40	3.07	11.77	3.07	12.01	3.08
	35	11.33	3.26	11.41	3.25	11.44	3.24	11.50	3.23	11.75	3.23	11.91	3.23
	40	10.92	3.38	11.10	3.37	11.17	3.36	11.29	3.35	11.54	3.34	11.71	3.34
	43	10.82	3.36	10.88	3.34	10.90	3.34	10.94	3.32	11.32	3.32	11.57	3.32
	46	10.88	3.23	10.66	3.23	10.58	3.23	10.43	3.23	11.03	3.24	11.43	3.24
1.6 + 2.0 + 2.5 + 5.0 + 6.0	22	14.11	1.79	11.97	1.91	11.26	1.94	9.83	2.02	11.28	2.05	12.24	2.07
	25	13.25	2.28	11.87	2.35	11.41	2.37	10.50	2.42	11.51	2.43	12.19	2.44
	29	12.57	2.79	11.85	2.81	11.61	2.82	11.13	2.84	11.71	2.84	12.09	2.85
	32	11.75	3.07	11.57	3.07	11.52	3.07	11.40	3.07	11.77	3.07	12.01	3.08
	35	11.33	3.26	11.41	3.25	11.44	3.24	11.50	3.23	11.75	3.23	11.91	3.23
	40	10.92	3.38	11.10	3.37	11.17	3.36	11.29	3.35	11.54	3.34	11.71	3.34
	43	10.82	3.36	10.88	3.34	10.90	3.34	10.94	3.32	11.32	3.32	11.57	3.32
	46	10.88	3.23	10.66	3.23	10.58	3.23	10.43	3.23	11.03	3.24	11.43	3.24
1.6 + 2.0 + 2.5 + 5.0 + 7.1	22	14.11	1.80	11.97	1.91	11.26	1.95	9.83	2.02	11.28	2.05	12.24	2.07
	25	13.25	2.29	11.87	2.36	11.41	2.38	10.50	2.43	11.51	2.44	12.19	2.45
	29	12.57	2.79	11.85	2.82	11.61	2.83	11.13	2.85	11.71	2.85	12.09	2.85
	32	11.75	3.08	11.57	3.08	11.52	3.08	11.40	3.08	11.77	3.08	12.01	3.09
	35	11.33	3.27	11.41	3.26	11.44	3.25	11.50	3.24	11.75	3.24	11.91	3.24
	40	10.92	3.39	11.10	3.38	11.17	3.37	11.29	3.36	11.54	3.35	11.71	3.35
	43	10.82	3.37	10.88	3.35	10.90	3.35	10.94	3.33	11.32	3.33	11.57	3.33
	46	10.88	3.24	10.66	3.24	10.58	3.24	10.43	3.24	11.03	3.25	11.43	3.25
1.6 + 2.0 + 2.5 + 6.0 + 6.0	22	14.11	1.79	11.97	1.91	11.26	1.94	9.83	2.02	11.28	2.05	12.24	2.07
	25	13.25	2.28	11.87	2.35	11.41	2.37	10.50	2.42	11.51	2.43	12.19	2.44
	29	12.57	2.79	11.85	2.81	11.61	2.82	11.13	2.84	11.71	2.84	12.09	2.85
	32	11.75	3.07	11.57	3.07	11.52	3.07	11.40	3.07	11.77	3.07	12.01	3.08
	35	11.33	3.26	11.41	3.25	11.44	3.24	11.50	3.23	11.75	3.23	11.91	3.23
	40	10.92	3.38	11.10	3.37	11.17	3.36	11.29	3.35	11.54	3.34	11.71	3.34
	43	10.82	3.36	10.88	3.34	10.90	3.34	10.94	3.32	11.32	3.32	11.57	3.32
	46	10.88	3.23	10.66	3.23	10.58	3.23	10.43	3.23	11.03	3.24	11.43	3.24
1.6 + 2.0 + 3.5 + 3.5 + 3.5	22	14.11	1.86	11.97	1.97	11.26	2.01	9.83	2.09	11.28	2.12	12.24	2.14
	25	13.25	2.36	11.87	2.43	11.41	2.45	10.50	2.50	11.51	2.52	12.19	2.53
	29	12.57	2.88	11.85	2.91	11.61	2.92	11.13	2.93	11.71	2.94	12.09	2.94
	32	11.75	3.17	11.57	3.17	11.52	3.17	11.40	3.17	11.77	3.18	12.01	3.18
	35	11.33	3.38	11.41	3.36	11.44	3.35	11.50	3.34	11.75	3.34	11.91	3.34
	40	10.92	3.50	11.10	3.48	11.17	3.48	11.29	3.46	11.54	3.46	11.71	3.45
	43	10.82	3.47	10.88	3.45	10.90	3.45	10.94	3.44	11.32	3.44	11.57	3.44
	46	10.88	3.34	10.66	3.34	10.58	3.34	10.43	3.34	11.03	3.35	11.43	3.35

Combination (Capacity)	Outdoor Air Temp. °C DB	Indoor Air Temp. °C											
		27/16		27/17.5		27/18		27/19		27/22		27/24	
		Total Q	Input Power	Total Q	Input Power	Total Q	Input Power	Total Q	Input Power	Total Q	Input Power	Total Q	Input Power
1.6 + 2.0 + 3.5 + 3.5 + 4.2	22	14.11	1.86	11.97	1.97	11.26	2.01	9.83	2.09	11.28	2.12	12.24	2.14
	25	13.25	2.36	11.87	2.43	11.41	2.45	10.50	2.50	11.51	2.52	12.19	2.53
	29	12.57	2.88	11.85	2.91	11.61	2.92	11.13	2.93	11.71	2.94	12.09	2.94
	32	11.75	3.17	11.57	3.17	11.52	3.17	11.40	3.17	11.77	3.18	12.01	3.18
	35	11.33	3.38	11.41	3.36	11.44	3.35	11.50	3.34	11.75	3.34	11.91	3.34
	40	10.92	3.50	11.10	3.48	11.17	3.48	11.29	3.46	11.54	3.46	11.71	3.45
	43	10.82	3.47	10.88	3.45	10.90	3.45	10.94	3.44	11.32	3.44	11.57	3.44
	46	10.88	3.34	10.66	3.34	10.58	3.34	10.43	3.34	11.03	3.35	11.43	3.35
1.6 + 2.0 + 3.5 + 3.5 + 5.0	22	14.11	1.83	11.97	1.94	11.26	1.98	9.83	2.05	11.28	2.09	12.24	2.11
	25	13.25	2.32	11.87	2.39	11.41	2.42	10.50	2.46	11.51	2.48	12.19	2.49
	29	12.57	2.84	11.85	2.86	11.61	2.87	11.13	2.89	11.71	2.89	12.09	2.90
	32	11.75	3.12	11.57	3.12	11.52	3.12	11.40	3.12	11.77	3.13	12.01	3.13
	35	11.33	3.32	11.41	3.31	11.44	3.30	11.50	3.29	11.75	3.29	11.91	3.29
	40	10.92	3.45	11.10	3.43	11.17	3.42	11.29	3.41	11.54	3.41	11.71	3.40
	43	10.82	3.42	10.88	3.40	10.90	3.40	10.94	3.39	11.32	3.39	11.57	3.39
	46	10.88	3.29	10.66	3.29	10.58	3.29	10.43	3.29	11.03	3.30	11.43	3.30
1.6 + 2.0 + 3.5 + 3.5 + 6.0	22	14.11	1.83	11.97	1.94	11.26	1.98	9.83	2.05	11.28	2.09	12.24	2.11
	25	13.25	2.32	11.87	2.39	11.41	2.42	10.50	2.46	11.51	2.48	12.19	2.49
	29	12.57	2.84	11.85	2.86	11.61	2.87	11.13	2.89	11.71	2.89	12.09	2.90
	32	11.75	3.12	11.57	3.12	11.52	3.12	11.40	3.12	11.77	3.13	12.01	3.13
	35	11.33	3.32	11.41	3.31	11.44	3.30	11.50	3.29	11.75	3.29	11.91	3.29
	40	10.92	3.45	11.10	3.43	11.17	3.42	11.29	3.41	11.54	3.41	11.71	3.40
	43	10.82	3.42	10.88	3.40	10.90	3.40	10.94	3.39	11.32	3.39	11.57	3.39
	46	10.88	3.29	10.66	3.29	10.58	3.29	10.43	3.29	11.03	3.30	11.43	3.30
1.6 + 2.0 + 3.5 + 3.5 + 7.1	22	14.11	1.83	11.97	1.94	11.26	1.98	9.83	2.05	11.28	2.09	12.24	2.11
	25	13.25	2.32	11.87	2.39	11.41	2.42	10.50	2.46	11.51	2.48	12.19	2.49
	29	12.57	2.84	11.85	2.86	11.61	2.87	11.13	2.89	11.71	2.89	12.09	2.90
	32	11.75	3.12	11.57	3.12	11.52	3.12	11.40	3.12	11.77	3.13	12.01	3.13
	35	11.33	3.32	11.41	3.31	11.44	3.30	11.50	3.29	11.75	3.29	11.91	3.29
	40	10.92	3.45	11.10	3.43	11.17	3.42	11.29	3.41	11.54	3.41	11.71	3.40
	43	10.82	3.42	10.88	3.40	10.90	3.40	10.94	3.39	11.32	3.39	11.57	3.39
	46	10.88	3.29	10.66	3.29	10.58	3.29	10.43	3.29	11.03	3.30	11.43	3.30
1.6 + 2.0 + 3.5 + 4.2 + 4.2	22	14.11	1.86	11.97	1.97	11.26	2.01	9.83	2.09	11.28	2.12	12.24	2.14
	25	13.25	2.36	11.87	2.43	11.41	2.45	10.50	2.50	11.51	2.52	12.19	2.53
	29	12.57	2.88	11.85	2.91	11.61	2.92	11.13	2.93	11.71	2.94	12.09	2.94
	32	11.75	3.17	11.57	3.17	11.52	3.17	11.40	3.17	11.77	3.18	12.01	3.18
	35	11.33	3.38	11.41	3.36	11.44	3.35	11.50	3.34	11.75	3.34	11.91	3.34
	40	10.92	3.50	11.10	3.48	11.17	3.48	11.29	3.46	11.54	3.46	11.71	3.45
	43	10.82	3.47	10.88	3.45	10.90	3.45	10.94	3.44	11.32	3.44	11.57	3.44
	46	10.88	3.34	10.66	3.34	10.58	3.34	10.43	3.34	11.03	3.35	11.43	3.35

Combination (Capacity)	Outdoor Air Temp. °C DB	Indoor Air Temp. °C											
		27/16		27/17.5		27/18		27/19		27/22		27/24	
		Total Q	Input Power	Total Q	Input Power	Total Q	Input Power	Total Q	Input Power	Total Q	Input Power	Total Q	Input Power
1.6 + 2.0 + 3.5 + 4.2 + 5.0	22	14.11	1.83	11.97	1.94	11.26	1.98	9.83	2.05	11.28	2.09	12.24	2.11
	25	13.25	2.32	11.87	2.39	11.41	2.42	10.50	2.46	11.51	2.48	12.19	2.49
	29	12.57	2.84	11.85	2.86	11.61	2.87	11.13	2.89	11.71	2.89	12.09	2.90
	32	11.75	3.12	11.57	3.12	11.52	3.12	11.40	3.12	11.77	3.13	12.01	3.13
	35	11.33	3.32	11.41	3.31	11.44	3.30	11.50	3.29	11.75	3.29	11.91	3.29
	40	10.92	3.45	11.10	3.43	11.17	3.42	11.29	3.41	11.54	3.41	11.71	3.40
	43	10.82	3.42	10.88	3.40	10.90	3.40	10.94	3.39	11.32	3.39	11.57	3.39
	46	10.88	3.29	10.66	3.29	10.58	3.29	10.43	3.29	11.03	3.30	11.43	3.30
1.6 + 2.0 + 3.5 + 4.2 + 6.0	22	14.11	1.83	11.97	1.94	11.26	1.98	9.83	2.05	11.28	2.09	12.24	2.11
	25	13.25	2.32	11.87	2.39	11.41	2.42	10.50	2.46	11.51	2.48	12.19	2.49
	29	12.57	2.84	11.85	2.86	11.61	2.87	11.13	2.89	11.71	2.89	12.09	2.90
	32	11.75	3.12	11.57	3.12	11.52	3.12	11.40	3.12	11.77	3.13	12.01	3.13
	35	11.33	3.32	11.41	3.31	11.44	3.30	11.50	3.29	11.75	3.29	11.91	3.29
	40	10.92	3.45	11.10	3.43	11.17	3.42	11.29	3.41	11.54	3.41	11.71	3.40
	43	10.82	3.42	10.88	3.40	10.90	3.40	10.94	3.39	11.32	3.39	11.57	3.39
	46	10.88	3.29	10.66	3.29	10.58	3.29	10.43	3.29	11.03	3.30	11.43	3.30
1.6 + 2.0 + 3.5 + 5.0 + 5.0	22	14.11	1.80	11.97	1.91	11.26	1.95	9.83	2.02	11.28	2.05	12.24	2.07
	25	13.25	2.29	11.87	2.36	11.41	2.38	10.50	2.43	11.51	2.44	12.19	2.45
	29	12.57	2.79	11.85	2.82	11.61	2.83	11.13	2.85	11.71	2.85	12.09	2.85
	32	11.75	3.08	11.57	3.08	11.52	3.08	11.40	3.08	11.77	3.08	12.01	3.09
	35	11.33	3.27	11.41	3.26	11.44	3.25	11.50	3.24	11.75	3.24	11.91	3.24
	40	10.92	3.39	11.10	3.38	11.17	3.37	11.29	3.36	11.54	3.35	11.71	3.35
	43	10.82	3.37	10.88	3.35	10.90	3.35	10.94	3.33	11.32	3.33	11.57	3.33
	46	10.88	3.24	10.66	3.24	10.58	3.24	10.43	3.24	11.03	3.25	11.43	3.25
1.6 + 2.0 + 3.5 + 5.0 + 6.0	22	14.11	1.80	11.97	1.91	11.26	1.95	9.83	2.02	11.28	2.05	12.24	2.07
	25	13.25	2.29	11.87	2.36	11.41	2.38	10.50	2.43	11.51	2.44	12.19	2.45
	29	12.57	2.79	11.85	2.82	11.61	2.83	11.13	2.85	11.71	2.85	12.09	2.85
	32	11.75	3.08	11.57	3.08	11.52	3.08	11.40	3.08	11.77	3.08	12.01	3.09
	35	11.33	3.27	11.41	3.26	11.44	3.25	11.50	3.24	11.75	3.24	11.91	3.24
	40	10.92	3.39	11.10	3.38	11.17	3.37	11.29	3.36	11.54	3.35	11.71	3.35
	43	10.82	3.37	10.88	3.35	10.90	3.35	10.94	3.33	11.32	3.33	11.57	3.33
	46	10.88	3.24	10.66	3.24	10.58	3.24	10.43	3.24	11.03	3.25	11.43	3.25
1.6 + 2.0 + 4.2 + 4.2 + 4.2	22	14.11	1.86	11.97	1.97	11.26	2.01	9.83	2.09	11.28	2.12	12.24	2.14
	25	13.25	2.36	11.87	2.43	11.41	2.45	10.50	2.50	11.51	2.52	12.19	2.53
	29	12.57	2.88	11.85	2.91	11.61	2.92	11.13	2.93	11.71	2.94	12.09	2.94
	32	11.75	3.17	11.57	3.17	11.52	3.17	11.40	3.17	11.77	3.18	12.01	3.18
	35	11.33	3.38	11.41	3.36	11.44	3.35	11.50	3.34	11.75	3.34	11.91	3.34
	40	10.92	3.50	11.10	3.48	11.17	3.48	11.29	3.46	11.54	3.46	11.71	3.45
	43	10.82	3.47	10.88	3.45	10.90	3.45	10.94	3.44	11.32	3.44	11.57	3.44
	46	10.88	3.34	10.66	3.34	10.58	3.34	10.43	3.34	11.03	3.35	11.43	3.35

Combination (Capacity)	Outdoor Air Temp. °C DB	Indoor Air Temp. °C											
		27/16		27/17.5		27/18		27/19		27/22		27/24	
		Total Q	Input Power	Total Q	Input Power	Total Q	Input Power	Total Q	Input Power	Total Q	Input Power	Total Q	Input Power
1.6 + 2.0 + 4.2 + 4.2 + 5.0	22	14.11	1.83	11.97	1.94	11.26	1.98	9.83	2.05	11.28	2.09	12.24	2.11
	25	13.25	2.32	11.87	2.39	11.41	2.42	10.50	2.46	11.51	2.48	12.19	2.49
	29	12.57	2.84	11.85	2.86	11.61	2.87	11.13	2.89	11.71	2.89	12.09	2.90
	32	11.75	3.12	11.57	3.12	11.52	3.12	11.40	3.12	11.77	3.13	12.01	3.13
	35	11.33	3.32	11.41	3.31	11.44	3.30	11.50	3.29	11.75	3.29	11.91	3.29
	40	10.92	3.45	11.10	3.43	11.17	3.42	11.29	3.41	11.54	3.41	11.71	3.40
	43	10.82	3.42	10.88	3.40	10.90	3.40	10.94	3.39	11.32	3.39	11.57	3.39
	46	10.88	3.29	10.66	3.29	10.58	3.29	10.43	3.29	11.03	3.30	11.43	3.30
1.6 + 2.0 + 4.2 + 4.2 + 6.0	22	14.11	1.83	11.97	1.94	11.26	1.98	9.83	2.05	11.28	2.09	12.24	2.11
	25	13.25	2.32	11.87	2.39	11.41	2.42	10.50	2.46	11.51	2.48	12.19	2.49
	29	12.57	2.84	11.85	2.86	11.61	2.87	11.13	2.89	11.71	2.89	12.09	2.90
	32	11.75	3.12	11.57	3.12	11.52	3.12	11.40	3.12	11.77	3.13	12.01	3.13
	35	11.33	3.32	11.41	3.31	11.44	3.30	11.50	3.29	11.75	3.29	11.91	3.29
	40	10.92	3.45	11.10	3.43	11.17	3.42	11.29	3.41	11.54	3.41	11.71	3.40
	43	10.82	3.42	10.88	3.40	10.90	3.40	10.94	3.39	11.32	3.39	11.57	3.39
	46	10.88	3.29	10.66	3.29	10.58	3.29	10.43	3.29	11.03	3.30	11.43	3.30
1.6 + 2.0 + 4.2 + 5.0 + 5.0	22	14.11	1.80	11.97	1.91	11.26	1.95	9.83	2.02	11.28	2.05	12.24	2.07
	25	13.25	2.29	11.87	2.36	11.41	2.38	10.50	2.43	11.51	2.44	12.19	2.45
	29	12.57	2.79	11.85	2.82	11.61	2.83	11.13	2.85	11.71	2.85	12.09	2.85
	32	11.75	3.08	11.57	3.08	11.52	3.08	11.40	3.08	11.77	3.08	12.01	3.09
	35	11.33	3.27	11.41	3.26	11.44	3.25	11.50	3.24	11.75	3.24	11.91	3.24
	40	10.92	3.39	11.10	3.38	11.17	3.37	11.29	3.36	11.54	3.35	11.71	3.35
	43	10.82	3.37	10.88	3.35	10.90	3.35	10.94	3.33	11.32	3.33	11.57	3.33
	46	10.88	3.24	10.66	3.24	10.58	3.24	10.43	3.24	11.03	3.25	11.43	3.25
1.6 + 2.5 + 2.5 + 2.5 + 2.5	22	14.11	1.94	11.97	2.06	11.26	2.10	9.83	2.18	11.28	2.21	12.24	2.23
	25	13.25	2.47	11.87	2.54	11.41	2.56	10.50	2.61	11.51	2.63	12.19	2.64
	29	12.57	3.01	11.85	3.04	11.61	3.05	11.13	3.07	11.71	3.07	12.09	3.07
	32	11.75	3.31	11.57	3.31	11.52	3.31	11.40	3.31	11.77	3.32	12.01	3.32
	35	11.33	3.53	11.41	3.51	11.44	3.50	11.50	3.49	11.75	3.49	11.91	3.49
	40	10.92	3.66	11.10	3.64	11.17	3.63	11.29	3.62	11.54	3.61	11.71	3.61
	43	10.82	3.63	10.88	3.61	10.90	3.60	10.94	3.59	11.32	3.59	11.57	3.59
	46	10.88	3.49	10.66	3.49	10.58	3.49	10.43	3.49	11.03	3.50	11.43	3.50
1.6 + 2.5 + 2.5 + 2.5 + 3.5	22	14.11	1.89	11.97	2.01	11.26	2.05	9.83	2.13	11.28	2.16	12.24	2.18
	25	13.25	2.41	11.87	2.48	11.41	2.50	10.50	2.55	11.51	2.57	12.19	2.58
	29	12.57	2.94	11.85	2.97	11.61	2.98	11.13	3.00	11.71	3.00	12.09	3.00
	32	11.75	3.24	11.57	3.24	11.52	3.24	11.40	3.24	11.77	3.24	12.01	3.25
	35	11.33	3.45	11.41	3.43	11.44	3.42	11.50	3.41	11.75	3.41	11.91	3.41
	40	10.92	3.57	11.10	3.55	11.17	3.55	11.29	3.54	11.54	3.53	11.71	3.53
	43	10.82	3.55	10.88	3.53	10.90	3.52	10.94	3.51	11.32	3.51	11.57	3.51
	46	10.88	3.41	10.66	3.41	10.58	3.41	10.43	3.41	11.03	3.42	11.43	3.42

Combination (Capacity)	Outdoor Air Temp. °C DB	Indoor Air Temp. °C											
		27/16		27/17.5		27/18		27/19		27/22		27/24	
		Total Q	Input Power	Total Q	Input Power	Total Q	Input Power	Total Q	Input Power	Total Q	Input Power	Total Q	Input Power
1.6 + 2.5 + 2.5 + 2.5 + 4.2	22	14.11	1.89	11.97	2.01	11.26	2.05	9.83	2.13	11.28	2.16	12.24	2.18
	25	13.25	2.41	11.87	2.48	11.41	2.50	10.50	2.55	11.51	2.57	12.19	2.58
	29	12.57	2.94	11.85	2.97	11.61	2.98	11.13	3.00	11.71	3.00	12.09	3.00
	32	11.75	3.24	11.57	3.24	11.52	3.24	11.40	3.24	11.77	3.24	12.01	3.25
	35	11.33	3.45	11.41	3.43	11.44	3.42	11.50	3.41	11.75	3.41	11.91	3.41
	40	10.92	3.57	11.10	3.55	11.17	3.55	11.29	3.54	11.54	3.53	11.71	3.53
	43	10.82	3.55	10.88	3.53	10.90	3.52	10.94	3.51	11.32	3.51	11.57	3.51
	46	10.88	3.41	10.66	3.41	10.58	3.41	10.43	3.41	11.03	3.42	11.43	3.42
1.6 + 2.5 + 2.5 + 2.5 + 5.0	22	14.11	1.82	11.97	1.94	11.26	1.97	9.83	2.05	11.28	2.08	12.24	2.10
	25	13.25	2.32	11.87	2.39	11.41	2.41	10.50	2.46	11.51	2.47	12.19	2.48
	29	12.57	2.83	11.85	2.85	11.61	2.86	11.13	2.88	11.71	2.89	12.09	2.89
	32	11.75	3.12	11.57	3.12	11.52	3.12	11.40	3.12	11.77	3.12	12.01	3.12
	35	11.33	3.31	11.41	3.30	11.44	3.29	11.50	3.28	11.75	3.28	11.91	3.28
	40	10.92	3.44	11.10	3.42	11.17	3.41	11.29	3.40	11.54	3.40	11.71	3.39
	43	10.82	3.41	10.88	3.39	10.90	3.39	10.94	3.38	11.32	3.38	11.57	3.38
	46	10.88	3.28	10.66	3.28	10.58	3.28	10.43	3.28	11.03	3.29	11.43	3.29
1.6 + 2.5 + 2.5 + 2.5 + 6.0	22	14.11	1.82	11.97	1.94	11.26	1.97	9.83	2.05	11.28	2.08	12.24	2.10
	25	13.25	2.32	11.87	2.39	11.41	2.41	10.50	2.46	11.51	2.47	12.19	2.48
	29	12.57	2.83	11.85	2.85	11.61	2.86	11.13	2.88	11.71	2.89	12.09	2.89
	32	11.75	3.12	11.57	3.12	11.52	3.12	11.40	3.12	11.77	3.12	12.01	3.12
	35	11.33	3.31	11.41	3.30	11.44	3.29	11.50	3.28	11.75	3.28	11.91	3.28
	40	10.92	3.44	11.10	3.42	11.17	3.41	11.29	3.40	11.54	3.40	11.71	3.39
	43	10.82	3.41	10.88	3.39	10.90	3.39	10.94	3.38	11.32	3.38	11.57	3.38
	46	10.88	3.28	10.66	3.28	10.58	3.28	10.43	3.28	11.03	3.29	11.43	3.29
1.6 + 2.5 + 2.5 + 2.5 + 7.1	22	14.11	1.82	11.97	1.94	11.26	1.97	9.83	2.05	11.28	2.08	12.24	2.10
	25	13.25	2.32	11.87	2.39	11.41	2.41	10.50	2.46	11.51	2.47	12.19	2.48
	29	12.57	2.83	11.85	2.85	11.61	2.86	11.13	2.88	11.71	2.89	12.09	2.89
	32	11.75	3.12	11.57	3.12	11.52	3.12	11.40	3.12	11.77	3.12	12.01	3.12
	35	11.33	3.31	11.41	3.30	11.44	3.29	11.50	3.28	11.75	3.28	11.91	3.28
	40	10.92	3.44	11.10	3.42	11.17	3.41	11.29	3.40	11.54	3.40	11.71	3.39
	43	10.82	3.41	10.88	3.39	10.90	3.39	10.94	3.38	11.32	3.38	11.57	3.38
	46	10.88	3.28	10.66	3.28	10.58	3.28	10.43	3.28	11.03	3.29	11.43	3.29
1.6 + 2.5 + 2.5 + 3.5 + 3.5	22	14.11	1.89	11.97	2.01	11.26	2.05	9.83	2.13	11.28	2.16	12.24	2.18
	25	13.25	2.41	11.87	2.48	11.41	2.50	10.50	2.55	11.51	2.57	12.19	2.58
	29	12.57	2.94	11.85	2.97	11.61	2.98	11.13	3.00	11.71	3.00	12.09	3.00
	32	11.75	3.24	11.57	3.24	11.52	3.24	11.40	3.24	11.77	3.24	12.01	3.25
	35	11.33	3.45	11.41	3.43	11.44	3.42	11.50	3.41	11.75	3.41	11.91	3.41
	40	10.92	3.57	11.10	3.55	11.17	3.55	11.29	3.54	11.54	3.53	11.71	3.53
	43	10.82	3.55	10.88	3.53	10.90	3.52	10.94	3.51	11.32	3.51	11.57	3.51
	46	10.88	3.41	10.66	3.41	10.58	3.41	10.43	3.41	11.03	3.42	11.43	3.42



Combination (Capacity)	Outdoor Air Temp. °C DB	Indoor Air Temp. °C											
		27/16		27/17.5		27/18		27/19		27/22		27/24	
		Total Q	Input Power	Total Q	Input Power	Total Q	Input Power	Total Q	Input Power	Total Q	Input Power	Total Q	Input Power
1.6 + 2.5 + 2.5 + 3.5 + 4.2	22	14.11	1.90	11.97	2.02	11.26	2.06	9.83	2.14	11.28	2.17	12.24	2.19
	25	13.25	2.42	11.87	2.49	11.41	2.51	10.50	2.56	11.51	2.58	12.19	2.59
	29	12.57	2.95	11.85	2.98	11.61	2.99	11.13	3.00	11.71	3.01	12.09	3.01
	32	11.75	3.25	11.57	3.25	11.52	3.25	11.40	3.25	11.77	3.25	12.01	3.26
	35	11.33	3.46	11.41	3.44	11.44	3.43	11.50	3.42	11.75	3.42	11.91	3.42
	40	10.92	3.58	11.10	3.56	11.17	3.56	11.29	3.55	11.54	3.54	11.71	3.54
	43	10.82	3.56	10.88	3.54	10.90	3.53	10.94	3.52	11.32	3.52	11.57	3.52
	46	10.88	3.42	10.66	3.42	10.58	3.42	10.43	3.42	11.03	3.43	11.43	3.43
1.6 + 2.5 + 2.5 + 3.5 + 5.0	22	14.11	1.82	11.97	1.94	11.26	1.97	9.83	2.05	11.28	2.08	12.24	2.10
	25	13.25	2.32	11.87	2.39	11.41	2.41	10.50	2.46	11.51	2.47	12.19	2.48
	29	12.57	2.83	11.85	2.85	11.61	2.86	11.13	2.88	11.71	2.89	12.09	2.89
	32	11.75	3.12	11.57	3.12	11.52	3.12	11.40	3.12	11.77	3.12	12.01	3.12
	35	11.33	3.31	11.41	3.30	11.44	3.29	11.50	3.28	11.75	3.28	11.91	3.28
	40	10.92	3.44	11.10	3.42	11.17	3.41	11.29	3.40	11.54	3.40	11.71	3.39
	43	10.82	3.41	10.88	3.39	10.90	3.39	10.94	3.38	11.32	3.38	11.57	3.38
	46	10.88	3.28	10.66	3.28	10.58	3.28	10.43	3.28	11.03	3.29	11.43	3.29
1.6 + 2.5 + 2.5 + 3.5 + 6.0	22	14.11	1.82	11.97	1.94	11.26	1.97	9.83	2.05	11.28	2.08	12.24	2.10
	25	13.25	2.32	11.87	2.39	11.41	2.41	10.50	2.46	11.51	2.47	12.19	2.48
	29	12.57	2.83	11.85	2.85	11.61	2.86	11.13	2.88	11.71	2.89	12.09	2.89
	32	11.75	3.12	11.57	3.12	11.52	3.12	11.40	3.12	11.77	3.12	12.01	3.12
	35	11.33	3.31	11.41	3.30	11.44	3.29	11.50	3.28	11.75	3.28	11.91	3.28
	40	10.92	3.44	11.10	3.42	11.17	3.41	11.29	3.40	11.54	3.40	11.71	3.39
	43	10.82	3.41	10.88	3.39	10.90	3.39	10.94	3.38	11.32	3.38	11.57	3.38
	46	10.88	3.28	10.66	3.28	10.58	3.28	10.43	3.28	11.03	3.29	11.43	3.29
1.6 + 2.5 + 2.5 + 3.5 + 7.1	22	14.11	1.83	11.97	1.94	11.26	1.98	9.83	2.05	11.28	2.09	12.24	2.11
	25	13.25	2.32	11.87	2.39	11.41	2.42	10.50	2.46	11.51	2.48	12.19	2.49
	29	12.57	2.84	11.85	2.86	11.61	2.87	11.13	2.89	11.71	2.89	12.09	2.90
	32	11.75	3.12	11.57	3.12	11.52	3.12	11.40	3.12	11.77	3.13	12.01	3.13
	35	11.33	3.32	11.41	3.31	11.44	3.30	11.50	3.29	11.75	3.29	11.91	3.29
	40	10.92	3.45	11.10	3.43	11.17	3.42	11.29	3.41	11.54	3.41	11.71	3.40
	43	10.82	3.42	10.88	3.40	10.90	3.40	10.94	3.39	11.32	3.39	11.57	3.39
	46	10.88	3.29	10.66	3.29	10.58	3.29	10.43	3.29	11.03	3.30	11.43	3.30
1.6 + 2.5 + 2.5 + 4.2 + 4.2	22	14.11	1.90	11.97	2.02	11.26	2.06	9.83	2.14	11.28	2.17	12.24	2.19
	25	13.25	2.42	11.87	2.49	11.41	2.51	10.50	2.56	11.51	2.58	12.19	2.59
	29	12.57	2.95	11.85	2.98	11.61	2.99	11.13	3.00	11.71	3.01	12.09	3.01
	32	11.75	3.25	11.57	3.25	11.52	3.25	11.40	3.25	11.77	3.25	12.01	3.26
	35	11.33	3.46	11.41	3.44	11.44	3.43	11.50	3.42	11.75	3.42	11.91	3.42
	40	10.92	3.58	11.10	3.56	11.17	3.56	11.29	3.55	11.54	3.54	11.71	3.54
	43	10.82	3.56	10.88	3.54	10.90	3.53	10.94	3.52	11.32	3.52	11.57	3.52
	46	10.88	3.42	10.66	3.42	10.58	3.42	10.43	3.42	11.03	3.43	11.43	3.43

Combination (Capacity)	Outdoor Air Temp. °C DB	Indoor Air Temp. °C											
		27/16		27/17.5		27/18		27/19		27/22		27/24	
		Total Q	Input Power	Total Q	Input Power	Total Q	Input Power	Total Q	Input Power	Total Q	Input Power	Total Q	Input Power
1.6 + 2.5 + 2.5 + 4.2 + 5.0	22	14.11	1.82	11.97	1.94	11.26	1.97	9.83	2.05	11.28	2.08	12.24	2.10
	25	13.25	2.32	11.87	2.39	11.41	2.41	10.50	2.46	11.51	2.47	12.19	2.48
	29	12.57	2.83	11.85	2.85	11.61	2.86	11.13	2.88	11.71	2.89	12.09	2.89
	32	11.75	3.12	11.57	3.12	11.52	3.12	11.40	3.12	11.77	3.12	12.01	3.12
	35	11.33	3.31	11.41	3.30	11.44	3.29	11.50	3.28	11.75	3.28	11.91	3.28
	40	10.92	3.44	11.10	3.42	11.17	3.41	11.29	3.40	11.54	3.40	11.71	3.39
	43	10.82	3.41	10.88	3.39	10.90	3.39	10.94	3.38	11.32	3.38	11.57	3.38
	46	10.88	3.28	10.66	3.28	10.58	3.28	10.43	3.28	11.03	3.29	11.43	3.29
1.6 + 2.5 + 2.5 + 4.2 + 6.0	22	14.11	1.82	11.97	1.94	11.26	1.97	9.83	2.05	11.28	2.08	12.24	2.10
	25	13.25	2.32	11.87	2.39	11.41	2.41	10.50	2.46	11.51	2.47	12.19	2.48
	29	12.57	2.83	11.85	2.85	11.61	2.86	11.13	2.88	11.71	2.89	12.09	2.89
	32	11.75	3.12	11.57	3.12	11.52	3.12	11.40	3.12	11.77	3.12	12.01	3.12
	35	11.33	3.31	11.41	3.30	11.44	3.29	11.50	3.28	11.75	3.28	11.91	3.28
	40	10.92	3.44	11.10	3.42	11.17	3.41	11.29	3.40	11.54	3.40	11.71	3.39
	43	10.82	3.41	10.88	3.39	10.90	3.39	10.94	3.38	11.32	3.38	11.57	3.38
	46	10.88	3.28	10.66	3.28	10.58	3.28	10.43	3.28	11.03	3.29	11.43	3.29
1.6 + 2.5 + 2.5 + 4.2 + 7.1	22	14.11	1.83	11.97	1.94	11.26	1.98	9.83	2.05	11.28	2.09	12.24	2.11
	25	13.25	2.32	11.87	2.39	11.41	2.42	10.50	2.46	11.51	2.48	12.19	2.49
	29	12.57	2.84	11.85	2.86	11.61	2.87	11.13	2.89	11.71	2.89	12.09	2.90
	32	11.75	3.12	11.57	3.12	11.52	3.12	11.40	3.12	11.77	3.13	12.01	3.13
	35	11.33	3.32	11.41	3.31	11.44	3.30	11.50	3.29	11.75	3.29	11.91	3.29
	40	10.92	3.45	11.10	3.43	11.17	3.42	11.29	3.41	11.54	3.41	11.71	3.40
	43	10.82	3.42	10.88	3.40	10.90	3.40	10.94	3.39	11.32	3.39	11.57	3.39
	46	10.88	3.29	10.66	3.29	10.58	3.29	10.43	3.29	11.03	3.30	11.43	3.30
1.6 + 2.5 + 2.5 + 5.0 + 5.0	22	14.11	1.79	11.97	1.91	11.26	1.94	9.83	2.02	11.28	2.05	12.24	2.07
	25	13.25	2.28	11.87	2.35	11.41	2.37	10.50	2.42	11.51	2.43	12.19	2.44
	29	12.57	2.79	11.85	2.81	11.61	2.82	11.13	2.84	11.71	2.84	12.09	2.85
	32	11.75	3.07	11.57	3.07	11.52	3.07	11.40	3.07	11.77	3.07	12.01	3.08
	35	11.33	3.26	11.41	3.25	11.44	3.24	11.50	3.23	11.75	3.23	11.91	3.23
	40	10.92	3.38	11.10	3.37	11.17	3.36	11.29	3.35	11.54	3.34	11.71	3.34
	43	10.82	3.36	10.88	3.34	10.90	3.34	10.94	3.32	11.32	3.32	11.57	3.32
	46	10.88	3.23	10.66	3.23	10.58	3.23	10.43	3.23	11.03	3.24	11.43	3.24
1.6 + 2.5 + 2.5 + 5.0 + 6.0	22	14.11	1.79	11.97	1.91	11.26	1.94	9.83	2.02	11.28	2.05	12.24	2.07
	25	13.25	2.28	11.87	2.35	11.41	2.37	10.50	2.42	11.51	2.43	12.19	2.44
	29	12.57	2.79	11.85	2.81	11.61	2.82	11.13	2.84	11.71	2.84	12.09	2.85
	32	11.75	3.07	11.57	3.07	11.52	3.07	11.40	3.07	11.77	3.07	12.01	3.08
	35	11.33	3.26	11.41	3.25	11.44	3.24	11.50	3.23	11.75	3.23	11.91	3.23
	40	10.92	3.38	11.10	3.37	11.17	3.36	11.29	3.35	11.54	3.34	11.71	3.34
	43	10.82	3.36	10.88	3.34	10.90	3.34	10.94	3.32	11.32	3.32	11.57	3.32
	46	10.88	3.23	10.66	3.23	10.58	3.23	10.43	3.23	11.03	3.24	11.43	3.24

Combination (Capacity)	Outdoor Air Temp. °C DB	Indoor Air Temp. °C											
		27/16		27/17.5		27/18		27/19		27/22		27/24	
		Total Q	Input Power	Total Q	Input Power	Total Q	Input Power	Total Q	Input Power	Total Q	Input Power	Total Q	Input Power
1.6 + 2.5 + 3.5 + 3.5 + 3.5	22	14.11	1.86	11.97	1.97	11.26	2.01	9.83	2.09	11.28	2.12	12.24	2.14
	25	13.25	2.36	11.87	2.43	11.41	2.45	10.50	2.50	11.51	2.52	12.19	2.53
	29	12.57	2.88	11.85	2.91	11.61	2.92	11.13	2.93	11.71	2.94	12.09	2.94
	32	11.75	3.17	11.57	3.17	11.52	3.17	11.40	3.17	11.77	3.18	12.01	3.18
	35	11.33	3.38	11.41	3.36	11.44	3.35	11.50	3.34	11.75	3.34	11.91	3.34
	40	10.92	3.50	11.10	3.48	11.17	3.48	11.29	3.46	11.54	3.46	11.71	3.45
	43	10.82	3.47	10.88	3.45	10.90	3.45	10.94	3.44	11.32	3.44	11.57	3.44
	46	10.88	3.34	10.66	3.34	10.58	3.34	10.43	3.34	11.03	3.35	11.43	3.35
1.6 + 2.5 + 3.5 + 3.5 + 4.2	22	14.11	1.86	11.97	1.97	11.26	2.01	9.83	2.09	11.28	2.12	12.24	2.14
	25	13.25	2.36	11.87	2.43	11.41	2.45	10.50	2.50	11.51	2.52	12.19	2.53
	29	12.57	2.88	11.85	2.91	11.61	2.92	11.13	2.93	11.71	2.94	12.09	2.94
	32	11.75	3.17	11.57	3.17	11.52	3.17	11.40	3.17	11.77	3.18	12.01	3.18
	35	11.33	3.38	11.41	3.36	11.44	3.35	11.50	3.34	11.75	3.34	11.91	3.34
	40	10.92	3.50	11.10	3.48	11.17	3.48	11.29	3.46	11.54	3.46	11.71	3.45
	43	10.82	3.47	10.88	3.45	10.90	3.45	10.94	3.44	11.32	3.44	11.57	3.44
	46	10.88	3.34	10.66	3.34	10.58	3.34	10.43	3.34	11.03	3.35	11.43	3.35
1.6 + 2.5 + 3.5 + 3.5 + 5.0	22	14.11	1.83	11.97	1.94	11.26	1.98	9.83	2.05	11.28	2.09	12.24	2.11
	25	13.25	2.32	11.87	2.39	11.41	2.42	10.50	2.46	11.51	2.48	12.19	2.49
	29	12.57	2.84	11.85	2.86	11.61	2.87	11.13	2.89	11.71	2.89	12.09	2.90
	32	11.75	3.12	11.57	3.12	11.52	3.12	11.40	3.12	11.77	3.13	12.01	3.13
	35	11.33	3.32	11.41	3.31	11.44	3.30	11.50	3.29	11.75	3.29	11.91	3.29
	40	10.92	3.45	11.10	3.43	11.17	3.42	11.29	3.41	11.54	3.41	11.71	3.40
	43	10.82	3.42	10.88	3.40	10.90	3.40	10.94	3.39	11.32	3.39	11.57	3.39
	46	10.88	3.29	10.66	3.29	10.58	3.29	10.43	3.29	11.03	3.30	11.43	3.30
1.6 + 2.5 + 3.5 + 3.5 + 6.0	22	14.11	1.83	11.97	1.94	11.26	1.98	9.83	2.05	11.28	2.09	12.24	2.11
	25	13.25	2.32	11.87	2.39	11.41	2.42	10.50	2.46	11.51	2.48	12.19	2.49
	29	12.57	2.84	11.85	2.86	11.61	2.87	11.13	2.89	11.71	2.89	12.09	2.90
	32	11.75	3.12	11.57	3.12	11.52	3.12	11.40	3.12	11.77	3.13	12.01	3.13
	35	11.33	3.32	11.41	3.31	11.44	3.30	11.50	3.29	11.75	3.29	11.91	3.29
	40	10.92	3.45	11.10	3.43	11.17	3.42	11.29	3.41	11.54	3.41	11.71	3.40
	43	10.82	3.42	10.88	3.40	10.90	3.40	10.94	3.39	11.32	3.39	11.57	3.39
	46	10.88	3.29	10.66	3.29	10.58	3.29	10.43	3.29	11.03	3.30	11.43	3.30
1.6 + 2.5 + 3.5 + 3.5 + 7.1	22	14.11	1.83	11.97	1.94	11.26	1.98	9.83	2.05	11.28	2.09	12.24	2.11
	25	13.25	2.32	11.87	2.39	11.41	2.42	10.50	2.46	11.51	2.48	12.19	2.49
	29	12.57	2.84	11.85	2.86	11.61	2.87	11.13	2.89	11.71	2.89	12.09	2.90
	32	11.75	3.12	11.57	3.12	11.52	3.12	11.40	3.12	11.77	3.13	12.01	3.13
	35	11.33	3.32	11.41	3.31	11.44	3.30	11.50	3.29	11.75	3.29	11.91	3.29
	40	10.92	3.45	11.10	3.43	11.17	3.42	11.29	3.41	11.54	3.41	11.71	3.40
	43	10.82	3.42	10.88	3.40	10.90	3.40	10.94	3.39	11.32	3.39	11.57	3.39
	46	10.88	3.29	10.66	3.29	10.58	3.29	10.43	3.29	11.03	3.30	11.43	3.30

Combination (Capacity)	Outdoor Air Temp. °C DB	Indoor Air Temp. °C											
		27/16		27/17.5		27/18		27/19		27/22		27/24	
		Total Q	Input Power	Total Q	Input Power	Total Q	Input Power	Total Q	Input Power	Total Q	Input Power	Total Q	Input Power
1.6 + 2.5 + 3.5 + 4.2 + 4.2	22	14.11	1.86	11.97	1.97	11.26	2.01	9.83	2.09	11.28	2.12	12.24	2.14
	25	13.25	2.36	11.87	2.43	11.41	2.45	10.50	2.50	11.51	2.52	12.19	2.53
	29	12.57	2.88	11.85	2.91	11.61	2.92	11.13	2.93	11.71	2.94	12.09	2.94
	32	11.75	3.17	11.57	3.17	11.52	3.17	11.40	3.17	11.77	3.18	12.01	3.18
	35	11.33	3.38	11.41	3.36	11.44	3.35	11.50	3.34	11.75	3.34	11.91	3.34
	40	10.92	3.50	11.10	3.48	11.17	3.48	11.29	3.46	11.54	3.46	11.71	3.45
	43	10.82	3.47	10.88	3.45	10.90	3.45	10.94	3.44	11.32	3.44	11.57	3.44
	46	10.88	3.34	10.66	3.34	10.58	3.34	10.43	3.34	11.03	3.35	11.43	3.35
1.6 + 2.5 + 3.5 + 4.2 + 5.0	22	14.11	1.83	11.97	1.94	11.26	1.98	9.83	2.05	11.28	2.09	12.24	2.11
	25	13.25	2.32	11.87	2.39	11.41	2.42	10.50	2.46	11.51	2.48	12.19	2.49
	29	12.57	2.84	11.85	2.86	11.61	2.87	11.13	2.89	11.71	2.89	12.09	2.90
	32	11.75	3.12	11.57	3.12	11.52	3.12	11.40	3.12	11.77	3.13	12.01	3.13
	35	11.33	3.32	11.41	3.31	11.44	3.30	11.50	3.29	11.75	3.29	11.91	3.29
	40	10.92	3.45	11.10	3.43	11.17	3.42	11.29	3.41	11.54	3.41	11.71	3.40
	43	10.82	3.42	10.88	3.40	10.90	3.40	10.94	3.39	11.32	3.39	11.57	3.39
	46	10.88	3.29	10.66	3.29	10.58	3.29	10.43	3.29	11.03	3.30	11.43	3.30
1.6 + 2.5 + 3.5 + 4.2 + 6.0	22	14.11	1.83	11.97	1.94	11.26	1.98	9.83	2.05	11.28	2.09	12.24	2.11
	25	13.25	2.32	11.87	2.39	11.41	2.42	10.50	2.46	11.51	2.48	12.19	2.49
	29	12.57	2.84	11.85	2.86	11.61	2.87	11.13	2.89	11.71	2.89	12.09	2.90
	32	11.75	3.12	11.57	3.12	11.52	3.12	11.40	3.12	11.77	3.13	12.01	3.13
	35	11.33	3.32	11.41	3.31	11.44	3.30	11.50	3.29	11.75	3.29	11.91	3.29
	40	10.92	3.45	11.10	3.43	11.17	3.42	11.29	3.41	11.54	3.41	11.71	3.40
	43	10.82	3.42	10.88	3.40	10.90	3.40	10.94	3.39	11.32	3.39	11.57	3.39
	46	10.88	3.29	10.66	3.29	10.58	3.29	10.43	3.29	11.03	3.30	11.43	3.30
1.6 + 2.5 + 3.5 + 5.0 + 5.0	22	14.11	1.80	11.97	1.91	11.26	1.95	9.83	2.02	11.28	2.05	12.24	2.07
	25	13.25	2.29	11.87	2.36	11.41	2.38	10.50	2.43	11.51	2.44	12.19	2.45
	29	12.57	2.79	11.85	2.82	11.61	2.83	11.13	2.85	11.71	2.85	12.09	2.85
	32	11.75	3.08	11.57	3.08	11.52	3.08	11.40	3.08	11.77	3.08	12.01	3.09
	35	11.33	3.27	11.41	3.26	11.44	3.25	11.50	3.24	11.75	3.24	11.91	3.24
	40	10.92	3.39	11.10	3.38	11.17	3.37	11.29	3.36	11.54	3.35	11.71	3.35
	43	10.82	3.37	10.88	3.35	10.90	3.35	10.94	3.33	11.32	3.33	11.57	3.33
	46	10.88	3.24	10.66	3.24	10.58	3.24	10.43	3.24	11.03	3.25	11.43	3.25
1.6 + 2.5 + 4.2 + 4.2 + 4.2	22	14.11	1.86	11.97	1.97	11.26	2.01	9.83	2.09	11.28	2.12	12.24	2.14
	25	13.25	2.36	11.87	2.43	11.41	2.45	10.50	2.50	11.51	2.52	12.19	2.53
	29	12.57	2.88	11.85	2.91	11.61	2.92	11.13	2.93	11.71	2.94	12.09	2.94
	32	11.75	3.17	11.57	3.17	11.52	3.17	11.40	3.17	11.77	3.18	12.01	3.18
	35	11.33	3.38	11.41	3.36	11.44	3.35	11.50	3.34	11.75	3.34	11.91	3.34
	40	10.92	3.50	11.10	3.48	11.17	3.48	11.29	3.46	11.54	3.46	11.71	3.45
	43	10.82	3.47	10.88	3.45	10.90	3.45	10.94	3.44	11.32	3.44	11.57	3.44
	46	10.88	3.34	10.66	3.34	10.58	3.34	10.43	3.34	11.03	3.35	11.43	3.35

Combination (Capacity)	Outdoor Air Temp. °C DB	Indoor Air Temp. °C											
		27/16		27/17.5		27/18		27/19		27/22		27/24	
		Total Q	Input Power	Total Q	Input Power	Total Q	Input Power	Total Q	Input Power	Total Q	Input Power	Total Q	Input Power
1.6 + 2.5 + 4.2 + 4.2 + 5.0	22	14.11	1.83	11.97	1.94	11.26	1.98	9.83	2.05	11.28	2.09	12.24	2.11
	25	13.25	2.32	11.87	2.39	11.41	2.42	10.50	2.46	11.51	2.48	12.19	2.49
	29	12.57	2.84	11.85	2.86	11.61	2.87	11.13	2.89	11.71	2.89	12.09	2.90
	32	11.75	3.12	11.57	3.12	11.52	3.12	11.40	3.12	11.77	3.13	12.01	3.13
	35	11.33	3.32	11.41	3.31	11.44	3.30	11.50	3.29	11.75	3.29	11.91	3.29
	40	10.92	3.45	11.10	3.43	11.17	3.42	11.29	3.41	11.54	3.41	11.71	3.40
	43	10.82	3.42	10.88	3.40	10.90	3.40	10.94	3.39	11.32	3.39	11.57	3.39
	46	10.88	3.29	10.66	3.29	10.58	3.29	10.43	3.29	11.03	3.30	11.43	3.30
1.6 + 2.5 + 4.2 + 5.0 + 5.0	22	14.11	1.80	11.97	1.91	11.26	1.95	9.83	2.02	11.28	2.05	12.24	2.07
	25	13.25	2.29	11.87	2.36	11.41	2.38	10.50	2.43	11.51	2.44	12.19	2.45
	29	12.57	2.79	11.85	2.82	11.61	2.83	11.13	2.85	11.71	2.85	12.09	2.85
	32	11.75	3.08	11.57	3.08	11.52	3.08	11.40	3.08	11.77	3.08	12.01	3.09
	35	11.33	3.27	11.41	3.26	11.44	3.25	11.50	3.24	11.75	3.24	11.91	3.24
	40	10.92	3.39	11.10	3.38	11.17	3.37	11.29	3.36	11.54	3.35	11.71	3.35
	43	10.82	3.37	10.88	3.35	10.90	3.35	10.94	3.33	11.32	3.33	11.57	3.33
	46	10.88	3.24	10.66	3.24	10.58	3.24	10.43	3.24	11.03	3.25	11.43	3.25
1.6 + 3.5 + 3.5 + 3.5 + 3.5	22	14.11	1.86	11.97	1.98	11.26	2.01	9.83	2.09	11.28	2.12	12.24	2.14
	25	13.25	2.37	11.87	2.44	11.41	2.46	10.50	2.51	11.51	2.52	12.19	2.53
	29	12.57	2.89	11.85	2.92	11.61	2.92	11.13	2.94	11.71	2.95	12.09	2.95
	32	11.75	3.18	11.57	3.18	11.52	3.18	11.40	3.18	11.77	3.19	12.01	3.19
	35	11.33	3.39	11.41	3.37	11.44	3.36	11.50	3.35	11.75	3.35	11.91	3.35
	40	10.92	3.51	11.10	3.49	11.17	3.49	11.29	3.47	11.54	3.47	11.71	3.47
	43	10.82	3.48	10.88	3.47	10.90	3.46	10.94	3.45	11.32	3.45	11.57	3.45
	46	10.88	3.35	10.66	3.35	10.58	3.35	10.43	3.35	11.03	3.36	11.43	3.36
1.6 + 3.5 + 3.5 + 3.5 + 4.2	22	14.11	1.86	11.97	1.98	11.26	2.01	9.83	2.09	11.28	2.12	12.24	2.14
	25	13.25	2.37	11.87	2.44	11.41	2.46	10.50	2.51	11.51	2.52	12.19	2.53
	29	12.57	2.89	11.85	2.92	11.61	2.92	11.13	2.94	11.71	2.95	12.09	2.95
	32	11.75	3.18	11.57	3.18	11.52	3.18	11.40	3.18	11.77	3.19	12.01	3.19
	35	11.33	3.39	11.41	3.37	11.44	3.36	11.50	3.35	11.75	3.35	11.91	3.35
	40	10.92	3.51	11.10	3.49	11.17	3.49	11.29	3.47	11.54	3.47	11.71	3.47
	43	10.82	3.48	10.88	3.47	10.90	3.46	10.94	3.45	11.32	3.45	11.57	3.45
	46	10.88	3.35	10.66	3.35	10.58	3.35	10.43	3.35	11.03	3.36	11.43	3.36
1.6 + 3.5 + 3.5 + 3.5 + 5.0	22	14.11	1.83	11.97	1.94	11.26	1.98	9.83	2.05	11.28	2.09	12.24	2.11
	25	13.25	2.32	11.87	2.39	11.41	2.42	10.50	2.46	11.51	2.48	12.19	2.49
	29	12.57	2.84	11.85	2.86	11.61	2.87	11.13	2.89	11.71	2.89	12.09	2.90
	32	11.75	3.12	11.57	3.12	11.52	3.12	11.40	3.12	11.77	3.13	12.01	3.13
	35	11.33	3.32	11.41	3.31	11.44	3.30	11.50	3.29	11.75	3.29	11.91	3.29
	40	10.92	3.45	11.10	3.43	11.17	3.42	11.29	3.41	11.54	3.41	11.71	3.40
	43	10.82	3.42	10.88	3.40	10.90	3.40	10.94	3.39	11.32	3.39	11.57	3.39
	46	10.88	3.29	10.66	3.29	10.58	3.29	10.43	3.29	11.03	3.30	11.43	3.30

Combination (Capacity)	Outdoor Air Temp. °C DB	Indoor Air Temp. °C											
		27/16		27/17.5		27/18		27/19		27/22		27/24	
		Total Q	Input Power	Total Q	Input Power	Total Q	Input Power	Total Q	Input Power	Total Q	Input Power	Total Q	Input Power
1.6 + 3.5 + 3.5 + 3.5 + 6.0	22	14.11	1.83	11.97	1.94	11.26	1.98	9.83	2.05	11.28	2.09	12.24	2.11
	25	13.25	2.32	11.87	2.39	11.41	2.42	10.50	2.46	11.51	2.48	12.19	2.49
	29	12.57	2.84	11.85	2.86	11.61	2.87	11.13	2.89	11.71	2.89	12.09	2.90
	32	11.75	3.12	11.57	3.12	11.52	3.12	11.40	3.12	11.77	3.13	12.01	3.13
	35	11.33	3.32	11.41	3.31	11.44	3.30	11.50	3.29	11.75	3.29	11.91	3.29
	40	10.92	3.45	11.10	3.43	11.17	3.42	11.29	3.41	11.54	3.41	11.71	3.40
	43	10.82	3.42	10.88	3.40	10.90	3.40	10.94	3.39	11.32	3.39	11.57	3.39
	46	10.88	3.29	10.66	3.29	10.58	3.29	10.43	3.29	11.03	3.30	11.43	3.30
1.6 + 3.5 + 3.5 + 4.2 + 4.2	22	14.11	1.86	11.97	1.98	11.26	2.01	9.83	2.09	11.28	2.12	12.24	2.14
	25	13.25	2.37	11.87	2.44	11.41	2.46	10.50	2.51	11.51	2.52	12.19	2.53
	29	12.57	2.89	11.85	2.92	11.61	2.92	11.13	2.94	11.71	2.95	12.09	2.95
	32	11.75	3.18	11.57	3.18	11.52	3.18	11.40	3.18	11.77	3.19	12.01	3.19
	35	11.33	3.39	11.41	3.37	11.44	3.36	11.50	3.35	11.75	3.35	11.91	3.35
	40	10.92	3.51	11.10	3.49	11.17	3.49	11.29	3.47	11.54	3.47	11.71	3.47
	43	10.82	3.48	10.88	3.47	10.90	3.46	10.94	3.45	11.32	3.45	11.57	3.45
	46	10.88	3.35	10.66	3.35	10.58	3.35	10.43	3.35	11.03	3.36	11.43	3.36
1.6 + 3.5 + 3.5 + 4.2 + 5.0	22	14.11	1.83	11.97	1.94	11.26	1.98	9.83	2.05	11.28	2.09	12.24	2.11
	25	13.25	2.32	11.87	2.39	11.41	2.42	10.50	2.46	11.51	2.48	12.19	2.49
	29	12.57	2.84	11.85	2.86	11.61	2.87	11.13	2.89	11.71	2.89	12.09	2.90
	32	11.75	3.12	11.57	3.12	11.52	3.12	11.40	3.12	11.77	3.13	12.01	3.13
	35	11.33	3.32	11.41	3.31	11.44	3.30	11.50	3.29	11.75	3.29	11.91	3.29
	40	10.92	3.45	11.10	3.43	11.17	3.42	11.29	3.41	11.54	3.41	11.71	3.40
	43	10.82	3.42	10.88	3.40	10.90	3.40	10.94	3.39	11.32	3.39	11.57	3.39
	46	10.88	3.29	10.66	3.29	10.58	3.29	10.43	3.29	11.03	3.30	11.43	3.30
1.6 + 3.5 + 4.2 + 4.2 + 4.2	22	14.11	1.86	11.97	1.98	11.26	2.01	9.83	2.09	11.28	2.12	12.24	2.14
	25	13.25	2.37	11.87	2.44	11.41	2.46	10.50	2.51	11.51	2.52	12.19	2.53
	29	12.57	2.89	11.85	2.92	11.61	2.92	11.13	2.94	11.71	2.95	12.09	2.95
	32	11.75	3.18	11.57	3.18	11.52	3.18	11.40	3.18	11.77	3.19	12.01	3.19
	35	11.33	3.39	11.41	3.37	11.44	3.36	11.50	3.35	11.75	3.35	11.91	3.35
	40	10.92	3.51	11.10	3.49	11.17	3.49	11.29	3.47	11.54	3.47	11.71	3.47
	43	10.82	3.48	10.88	3.47	10.90	3.46	10.94	3.45	11.32	3.45	11.57	3.45
	46	10.88	3.35	10.66	3.35	10.58	3.35	10.43	3.35	11.03	3.36	11.43	3.36
2.0 + 2.0 + 2.0 + 2.0 + 2.0	22	14.11	1.94	11.97	2.06	11.26	2.10	9.83	2.18	11.28	2.21	12.24	2.23
	25	13.25	2.47	11.87	2.54	11.41	2.56	10.50	2.61	11.51	2.63	12.19	2.64
	29	12.57	3.01	11.85	3.04	11.61	3.05	11.13	3.07	11.71	3.07	12.09	3.07
	32	11.75	3.31	11.57	3.31	11.52	3.31	11.40	3.31	11.77	3.32	12.01	3.32
	35	11.33	3.53	11.41	3.51	11.44	3.50	11.50	3.49	11.75	3.49	11.91	3.49
	40	10.92	3.66	11.10	3.64	11.17	3.63	11.29	3.62	11.54	3.61	11.71	3.61
	43	10.82	3.63	10.88	3.61	10.90	3.60	10.94	3.59	11.32	3.59	11.57	3.59
	46	10.88	3.49	10.66	3.49	10.58	3.49	10.43	3.49	11.03	3.50	11.43	3.50

Combination (Capacity)	Outdoor Air Temp. °C DB	Indoor Air Temp. °C											
		27/16		27/17.5		27/18		27/19		27/22		27/24	
		Total Q	Input Power	Total Q	Input Power	Total Q	Input Power	Total Q	Input Power	Total Q	Input Power	Total Q	Input Power
2.0 + 2.0 + 2.0 + 2.0 + 2.5	22	14.11	1.94	11.97	2.06	11.26	2.10	9.83	2.18	11.28	2.21	12.24	2.23
	25	13.25	2.47	11.87	2.54	11.41	2.56	10.50	2.61	11.51	2.63	12.19	2.64
	29	12.57	3.01	11.85	3.04	11.61	3.05	11.13	3.07	11.71	3.07	12.09	3.07
	32	11.75	3.31	11.57	3.31	11.52	3.31	11.40	3.31	11.77	3.32	12.01	3.32
	35	11.33	3.53	11.41	3.51	11.44	3.50	11.50	3.49	11.75	3.49	11.91	3.49
	40	10.92	3.66	11.10	3.64	11.17	3.63	11.29	3.62	11.54	3.61	11.71	3.61
	43	10.82	3.63	10.88	3.61	10.90	3.60	10.94	3.59	11.32	3.59	11.57	3.59
	46	10.88	3.49	10.66	3.49	10.58	3.49	10.43	3.49	11.03	3.50	11.43	3.50
2.0 + 2.0 + 2.0 + 2.0 + 3.5	22	14.11	1.89	11.97	2.01	11.26	2.05	9.83	2.13	11.28	2.16	12.24	2.18
	25	13.25	2.41	11.87	2.48	11.41	2.50	10.50	2.55	11.51	2.57	12.19	2.58
	29	12.57	2.94	11.85	2.97	11.61	2.98	11.13	3.00	11.71	3.00	12.09	3.00
	32	11.75	3.24	11.57	3.24	11.52	3.24	11.40	3.24	11.77	3.24	12.01	3.25
	35	11.33	3.45	11.41	3.43	11.44	3.42	11.50	3.41	11.75	3.41	11.91	3.41
	40	10.92	3.57	11.10	3.55	11.17	3.55	11.29	3.54	11.54	3.53	11.71	3.53
	43	10.82	3.55	10.88	3.53	10.90	3.52	10.94	3.51	11.32	3.51	11.57	3.51
	46	10.88	3.41	10.66	3.41	10.58	3.41	10.43	3.41	11.03	3.42	11.43	3.42
2.0 + 2.0 + 2.0 + 2.0 + 4.2	22	14.11	1.89	11.97	2.01	11.26	2.05	9.83	2.13	11.28	2.16	12.24	2.18
	25	13.25	2.41	11.87	2.48	11.41	2.50	10.50	2.55	11.51	2.57	12.19	2.58
	29	12.57	2.94	11.85	2.97	11.61	2.98	11.13	3.00	11.71	3.00	12.09	3.00
	32	11.75	3.24	11.57	3.24	11.52	3.24	11.40	3.24	11.77	3.24	12.01	3.25
	35	11.33	3.45	11.41	3.43	11.44	3.42	11.50	3.41	11.75	3.41	11.91	3.41
	40	10.92	3.57	11.10	3.55	11.17	3.55	11.29	3.54	11.54	3.53	11.71	3.53
	43	10.82	3.55	10.88	3.53	10.90	3.52	10.94	3.51	11.32	3.51	11.57	3.51
	46	10.88	3.41	10.66	3.41	10.58	3.41	10.43	3.41	11.03	3.42	11.43	3.42
2.0 + 2.0 + 2.0 + 2.0 + 5.0	22	14.11	1.82	11.97	1.94	11.26	1.97	9.83	2.05	11.28	2.08	12.24	2.10
	25	13.25	2.32	11.87	2.39	11.41	2.41	10.50	2.46	11.51	2.47	12.19	2.48
	29	12.57	2.83	11.85	2.85	11.61	2.86	11.13	2.88	11.71	2.89	12.09	2.89
	32	11.75	3.12	11.57	3.12	11.52	3.12	11.40	3.12	11.77	3.12	12.01	3.12
	35	11.33	3.31	11.41	3.30	11.44	3.29	11.50	3.28	11.75	3.28	11.91	3.28
	40	10.92	3.44	11.10	3.42	11.17	3.41	11.29	3.40	11.54	3.40	11.71	3.39
	43	10.82	3.41	10.88	3.39	10.90	3.39	10.94	3.38	11.32	3.38	11.57	3.38
	46	10.88	3.28	10.66	3.28	10.58	3.28	10.43	3.28	11.03	3.29	11.43	3.29
2.0 + 2.0 + 2.0 + 2.0 + 6.0	22	14.11	1.82	11.97	1.94	11.26	1.97	9.83	2.05	11.28	2.08	12.24	2.10
	25	13.25	2.32	11.87	2.39	11.41	2.41	10.50	2.46	11.51	2.47	12.19	2.48
	29	12.57	2.83	11.85	2.85	11.61	2.86	11.13	2.88	11.71	2.89	12.09	2.89
	32	11.75	3.12	11.57	3.12	11.52	3.12	11.40	3.12	11.77	3.12	12.01	3.12
	35	11.33	3.31	11.41	3.30	11.44	3.29	11.50	3.28	11.75	3.28	11.91	3.28
	40	10.92	3.44	11.10	3.42	11.17	3.41	11.29	3.40	11.54	3.40	11.71	3.39
	43	10.82	3.41	10.88	3.39	10.90	3.39	10.94	3.38	11.32	3.38	11.57	3.38
	46	10.88	3.28	10.66	3.28	10.58	3.28	10.43	3.28	11.03	3.29	11.43	3.29

Combination (Capacity)	Outdoor Air Temp. °C DB	Indoor Air Temp. °C											
		27/16		27/17.5		27/18		27/19		27/22		27/24	
		Total Q	Input Power	Total Q	Input Power	Total Q	Input Power	Total Q	Input Power	Total Q	Input Power	Total Q	Input Power
2.0 + 2.0 + 2.0 + 2.0 + 7.1	22	14.11	1.82	11.97	1.94	11.26	1.97	9.83	2.05	11.28	2.08	12.24	2.10
	25	13.25	2.32	11.87	2.39	11.41	2.41	10.50	2.46	11.51	2.47	12.19	2.48
	29	12.57	2.83	11.85	2.85	11.61	2.86	11.13	2.88	11.71	2.89	12.09	2.89
	32	11.75	3.12	11.57	3.12	11.52	3.12	11.40	3.12	11.77	3.12	12.01	3.12
	35	11.33	3.31	11.41	3.30	11.44	3.29	11.50	3.28	11.75	3.28	11.91	3.28
	40	10.92	3.44	11.10	3.42	11.17	3.41	11.29	3.40	11.54	3.40	11.71	3.39
	43	10.82	3.41	10.88	3.39	10.90	3.39	10.94	3.38	11.32	3.38	11.57	3.38
	46	10.88	3.28	10.66	3.28	10.58	3.28	10.43	3.28	11.03	3.29	11.43	3.29
2.0 + 2.0 + 2.0 + 2.5 + 2.5	22	14.11	1.94	11.97	2.06	11.26	2.10	9.83	2.18	11.28	2.21	12.24	2.23
	25	13.25	2.47	11.87	2.54	11.41	2.56	10.50	2.61	11.51	2.63	12.19	2.64
	29	12.57	3.01	11.85	3.04	11.61	3.05	11.13	3.07	11.71	3.07	12.09	3.07
	32	11.75	3.31	11.57	3.31	11.52	3.31	11.40	3.31	11.77	3.32	12.01	3.32
	35	11.33	3.53	11.41	3.51	11.44	3.50	11.50	3.49	11.75	3.49	11.91	3.49
	40	10.92	3.66	11.10	3.64	11.17	3.63	11.29	3.62	11.54	3.61	11.71	3.61
	43	10.82	3.63	10.88	3.61	10.90	3.60	10.94	3.59	11.32	3.59	11.57	3.59
	46	10.88	3.49	10.66	3.49	10.58	3.49	10.43	3.49	11.03	3.50	11.43	3.50
2.0 + 2.0 + 2.0 + 2.5 + 3.5	22	14.11	1.89	11.97	2.01	11.26	2.05	9.83	2.13	11.28	2.16	12.24	2.18
	25	13.25	2.41	11.87	2.48	11.41	2.50	10.50	2.55	11.51	2.57	12.19	2.58
	29	12.57	2.94	11.85	2.97	11.61	2.98	11.13	3.00	11.71	3.00	12.09	3.00
	32	11.75	3.24	11.57	3.24	11.52	3.24	11.40	3.24	11.77	3.24	12.01	3.25
	35	11.33	3.45	11.41	3.43	11.44	3.42	11.50	3.41	11.75	3.41	11.91	3.41
	40	10.92	3.57	11.10	3.55	11.17	3.55	11.29	3.54	11.54	3.53	11.71	3.53
	43	10.82	3.55	10.88	3.53	10.90	3.52	10.94	3.51	11.32	3.51	11.57	3.51
	46	10.88	3.41	10.66	3.41	10.58	3.41	10.43	3.41	11.03	3.42	11.43	3.42
2.0 + 2.0 + 2.0 + 2.5 + 4.2	22	14.11	1.89	11.97	2.01	11.26	2.05	9.83	2.13	11.28	2.16	12.24	2.18
	25	13.25	2.41	11.87	2.48	11.41	2.50	10.50	2.55	11.51	2.57	12.19	2.58
	29	12.57	2.94	11.85	2.97	11.61	2.98	11.13	3.00	11.71	3.00	12.09	3.00
	32	11.75	3.24	11.57	3.24	11.52	3.24	11.40	3.24	11.77	3.24	12.01	3.25
	35	11.33	3.45	11.41	3.43	11.44	3.42	11.50	3.41	11.75	3.41	11.91	3.41
	40	10.92	3.57	11.10	3.55	11.17	3.55	11.29	3.54	11.54	3.53	11.71	3.53
	43	10.82	3.55	10.88	3.53	10.90	3.52	10.94	3.51	11.32	3.51	11.57	3.51
	46	10.88	3.41	10.66	3.41	10.58	3.41	10.43	3.41	11.03	3.42	11.43	3.42
2.0 + 2.0 + 2.0 + 2.5 + 5.0	22	14.11	1.82	11.97	1.94	11.26	1.97	9.83	2.05	11.28	2.08	12.24	2.10
	25	13.25	2.32	11.87	2.39	11.41	2.41	10.50	2.46	11.51	2.47	12.19	2.48
	29	12.57	2.83	11.85	2.85	11.61	2.86	11.13	2.88	11.71	2.89	12.09	2.89
	32	11.75	3.12	11.57	3.12	11.52	3.12	11.40	3.12	11.77	3.12	12.01	3.12
	35	11.33	3.31	11.41	3.30	11.44	3.29	11.50	3.28	11.75	3.28	11.91	3.28
	40	10.92	3.44	11.10	3.42	11.17	3.41	11.29	3.40	11.54	3.40	11.71	3.39
	43	10.82	3.41	10.88	3.39	10.90	3.39	10.94	3.38	11.32	3.38	11.57	3.38
	46	10.88	3.28	10.66	3.28	10.58	3.28	10.43	3.28	11.03	3.29	11.43	3.29



Combination (Capacity)	Outdoor Air Temp. °C DB	Indoor Air Temp. °C											
		27/16		27/17.5		27/18		27/19		27/22		27/24	
		Total Q	Input Power	Total Q	Input Power	Total Q	Input Power	Total Q	Input Power	Total Q	Input Power	Total Q	Input Power
2.0 + 2.0 + 2.0 + 2.5 + 6.0	22	14.11	1.82	11.97	1.94	11.26	1.97	9.83	2.05	11.28	2.08	12.24	2.10
	25	13.25	2.32	11.87	2.39	11.41	2.41	10.50	2.46	11.51	2.47	12.19	2.48
	29	12.57	2.83	11.85	2.85	11.61	2.86	11.13	2.88	11.71	2.89	12.09	2.89
	32	11.75	3.12	11.57	3.12	11.52	3.12	11.40	3.12	11.77	3.12	12.01	3.12
	35	11.33	3.31	11.41	3.30	11.44	3.29	11.50	3.28	11.75	3.28	11.91	3.28
	40	10.92	3.44	11.10	3.42	11.17	3.41	11.29	3.40	11.54	3.40	11.71	3.39
	43	10.82	3.41	10.88	3.39	10.90	3.39	10.94	3.38	11.32	3.38	11.57	3.38
	46	10.88	3.28	10.66	3.28	10.58	3.28	10.43	3.28	11.03	3.29	11.43	3.29
2.0 + 2.0 + 2.0 + 2.5 + 7.1	22	14.11	1.82	11.97	1.94	11.26	1.97	9.83	2.05	11.28	2.08	12.24	2.10
	25	13.25	2.32	11.87	2.39	11.41	2.41	10.50	2.46	11.51	2.47	12.19	2.48
	29	12.57	2.83	11.85	2.85	11.61	2.86	11.13	2.88	11.71	2.89	12.09	2.89
	32	11.75	3.12	11.57	3.12	11.52	3.12	11.40	3.12	11.77	3.12	12.01	3.12
	35	11.33	3.31	11.41	3.30	11.44	3.29	11.50	3.28	11.75	3.28	11.91	3.28
	40	10.92	3.44	11.10	3.42	11.17	3.41	11.29	3.40	11.54	3.40	11.71	3.39
	43	10.82	3.41	10.88	3.39	10.90	3.39	10.94	3.38	11.32	3.38	11.57	3.38
	46	10.88	3.28	10.66	3.28	10.58	3.28	10.43	3.28	11.03	3.29	11.43	3.29
2.0 + 2.0 + 2.0 + 3.5 + 3.5	22	14.11	1.90	11.97	2.02	11.26	2.06	9.83	2.14	11.28	2.17	12.24	2.19
	25	13.25	2.42	11.87	2.49	11.41	2.51	10.50	2.56	11.51	2.58	12.19	2.59
	29	12.57	2.95	11.85	2.98	11.61	2.99	11.13	3.00	11.71	3.01	12.09	3.01
	32	11.75	3.25	11.57	3.25	11.52	3.25	11.40	3.25	11.77	3.25	12.01	3.26
	35	11.33	3.46	11.41	3.44	11.44	3.43	11.50	3.42	11.75	3.42	11.91	3.42
	40	10.92	3.58	11.10	3.56	11.17	3.56	11.29	3.55	11.54	3.54	11.71	3.54
	43	10.82	3.56	10.88	3.54	10.90	3.53	10.94	3.52	11.32	3.52	11.57	3.52
	46	10.88	3.42	10.66	3.42	10.58	3.42	10.43	3.42	11.03	3.43	11.43	3.43
2.0 + 2.0 + 2.0 + 3.5 + 4.2	22	14.11	1.90	11.97	2.02	11.26	2.06	9.83	2.14	11.28	2.17	12.24	2.19
	25	13.25	2.42	11.87	2.49	11.41	2.51	10.50	2.56	11.51	2.58	12.19	2.59
	29	12.57	2.95	11.85	2.98	11.61	2.99	11.13	3.00	11.71	3.01	12.09	3.01
	32	11.75	3.25	11.57	3.25	11.52	3.25	11.40	3.25	11.77	3.25	12.01	3.26
	35	11.33	3.46	11.41	3.44	11.44	3.43	11.50	3.42	11.75	3.42	11.91	3.42
	40	10.92	3.58	11.10	3.56	11.17	3.56	11.29	3.55	11.54	3.54	11.71	3.54
	43	10.82	3.56	10.88	3.54	10.90	3.53	10.94	3.52	11.32	3.52	11.57	3.52
	46	10.88	3.42	10.66	3.42	10.58	3.42	10.43	3.42	11.03	3.43	11.43	3.43
2.0 + 2.0 + 2.0 + 3.5 + 5.0	22	14.11	1.82	11.97	1.94	11.26	1.97	9.83	2.05	11.28	2.08	12.24	2.10
	25	13.25	2.32	11.87	2.39	11.41	2.41	10.50	2.46	11.51	2.47	12.19	2.48
	29	12.57	2.83	11.85	2.85	11.61	2.86	11.13	2.88	11.71	2.89	12.09	2.89
	32	11.75	3.12	11.57	3.12	11.52	3.12	11.40	3.12	11.77	3.12	12.01	3.12
	35	11.33	3.31	11.41	3.30	11.44	3.29	11.50	3.28	11.75	3.28	11.91	3.28
	40	10.92	3.44	11.10	3.42	11.17	3.41	11.29	3.40	11.54	3.40	11.71	3.39
	43	10.82	3.41	10.88	3.39	10.90	3.39	10.94	3.38	11.32	3.38	11.57	3.38
	46	10.88	3.28	10.66	3.28	10.58	3.28	10.43	3.28	11.03	3.29	11.43	3.29

Combination (Capacity)	Outdoor Air Temp. °C DB	Indoor Air Temp. °C											
		27/16		27/17.5		27/18		27/19		27/22		27/24	
		Total Q	Input Power	Total Q	Input Power	Total Q	Input Power	Total Q	Input Power	Total Q	Input Power	Total Q	Input Power
2.0 + 2.0 + 2.0 + 3.5 + 6.0	22	14.11	1.82	11.97	1.94	11.26	1.97	9.83	2.05	11.28	2.08	12.24	2.10
	25	13.25	2.32	11.87	2.39	11.41	2.41	10.50	2.46	11.51	2.47	12.19	2.48
	29	12.57	2.83	11.85	2.85	11.61	2.86	11.13	2.88	11.71	2.89	12.09	2.89
	32	11.75	3.12	11.57	3.12	11.52	3.12	11.40	3.12	11.77	3.12	12.01	3.12
	35	11.33	3.31	11.41	3.30	11.44	3.29	11.50	3.28	11.75	3.28	11.91	3.28
	40	10.92	3.44	11.10	3.42	11.17	3.41	11.29	3.40	11.54	3.40	11.71	3.39
	43	10.82	3.41	10.88	3.39	10.90	3.39	10.94	3.38	11.32	3.38	11.57	3.38
	46	10.88	3.28	10.66	3.28	10.58	3.28	10.43	3.28	11.03	3.29	11.43	3.29
2.0 + 2.0 + 2.0 + 3.5 + 7.1	22	14.11	1.83	11.97	1.94	11.26	1.98	9.83	2.05	11.28	2.09	12.24	2.11
	25	13.25	2.32	11.87	2.39	11.41	2.42	10.50	2.46	11.51	2.48	12.19	2.49
	29	12.57	2.84	11.85	2.86	11.61	2.87	11.13	2.89	11.71	2.89	12.09	2.90
	32	11.75	3.12	11.57	3.12	11.52	3.12	11.40	3.12	11.77	3.13	12.01	3.13
	35	11.33	3.32	11.41	3.31	11.44	3.30	11.50	3.29	11.75	3.29	11.91	3.29
	40	10.92	3.45	11.10	3.43	11.17	3.42	11.29	3.41	11.54	3.41	11.71	3.40
	43	10.82	3.42	10.88	3.40	10.90	3.40	10.94	3.39	11.32	3.39	11.57	3.39
	46	10.88	3.29	10.66	3.29	10.58	3.29	10.43	3.29	11.03	3.30	11.43	3.30
2.0 + 2.0 + 2.0 + 4.2 + 4.2	22	14.11	1.90	11.97	2.02	11.26	2.06	9.83	2.14	11.28	2.17	12.24	2.19
	25	13.25	2.42	11.87	2.49	11.41	2.51	10.50	2.56	11.51	2.58	12.19	2.59
	29	12.57	2.95	11.85	2.98	11.61	2.99	11.13	3.00	11.71	3.01	12.09	3.01
	32	11.75	3.25	11.57	3.25	11.52	3.25	11.40	3.25	11.77	3.25	12.01	3.26
	35	11.33	3.46	11.41	3.44	11.44	3.43	11.50	3.42	11.75	3.42	11.91	3.42
	40	10.92	3.58	11.10	3.56	11.17	3.56	11.29	3.55	11.54	3.54	11.71	3.54
	43	10.82	3.56	10.88	3.54	10.90	3.53	10.94	3.52	11.32	3.52	11.57	3.52
	46	10.88	3.42	10.66	3.42	10.58	3.42	10.43	3.42	11.03	3.43	11.43	3.43
2.0 + 2.0 + 2.0 + 4.2 + 5.0	22	14.11	1.82	11.97	1.94	11.26	1.97	9.83	2.05	11.28	2.08	12.24	2.10
	25	13.25	2.32	11.87	2.39	11.41	2.41	10.50	2.46	11.51	2.47	12.19	2.48
	29	12.57	2.83	11.85	2.85	11.61	2.86	11.13	2.88	11.71	2.89	12.09	2.89
	32	11.75	3.12	11.57	3.12	11.52	3.12	11.40	3.12	11.77	3.12	12.01	3.12
	35	11.33	3.31	11.41	3.30	11.44	3.29	11.50	3.28	11.75	3.28	11.91	3.28
	40	10.92	3.44	11.10	3.42	11.17	3.41	11.29	3.40	11.54	3.40	11.71	3.39
	43	10.82	3.41	10.88	3.39	10.90	3.39	10.94	3.38	11.32	3.38	11.57	3.38
	46	10.88	3.28	10.66	3.28	10.58	3.28	10.43	3.28	11.03	3.29	11.43	3.29
2.0 + 2.0 + 2.0 + 4.2 + 6.0	22	14.11	1.82	11.97	1.94	11.26	1.97	9.83	2.05	11.28	2.08	12.24	2.10
	25	13.25	2.32	11.87	2.39	11.41	2.41	10.50	2.46	11.51	2.47	12.19	2.48
	29	12.57	2.83	11.85	2.85	11.61	2.86	11.13	2.88	11.71	2.89	12.09	2.89
	32	11.75	3.12	11.57	3.12	11.52	3.12	11.40	3.12	11.77	3.12	12.01	3.12
	35	11.33	3.31	11.41	3.30	11.44	3.29	11.50	3.28	11.75	3.28	11.91	3.28
	40	10.92	3.44	11.10	3.42	11.17	3.41	11.29	3.40	11.54	3.40	11.71	3.39
	43	10.82	3.41	10.88	3.39	10.90	3.39	10.94	3.38	11.32	3.38	11.57	3.38
	46	10.88	3.28	10.66	3.28	10.58	3.28	10.43	3.28	11.03	3.29	11.43	3.29

Combination (Capacity)	Outdoor Air Temp. °C DB	Indoor Air Temp. °C											
		27/16		27/17.5		27/18		27/19		27/22		27/24	
		Total Q	Input Power	Total Q	Input Power	Total Q	Input Power	Total Q	Input Power	Total Q	Input Power	Total Q	Input Power
2.0 + 2.0 + 2.0 + 4.2 + 7.1	22	14.11	1.83	11.97	1.94	11.26	1.98	9.83	2.05	11.28	2.09	12.24	2.11
	25	13.25	2.32	11.87	2.39	11.41	2.42	10.50	2.46	11.51	2.48	12.19	2.49
	29	12.57	2.84	11.85	2.86	11.61	2.87	11.13	2.89	11.71	2.89	12.09	2.90
	32	11.75	3.12	11.57	3.12	11.52	3.12	11.40	3.12	11.77	3.13	12.01	3.13
	35	11.33	3.32	11.41	3.31	11.44	3.30	11.50	3.29	11.75	3.29	11.91	3.29
	40	10.92	3.45	11.10	3.43	11.17	3.42	11.29	3.41	11.54	3.41	11.71	3.40
	43	10.82	3.42	10.88	3.40	10.90	3.40	10.94	3.39	11.32	3.39	11.57	3.39
	46	10.88	3.29	10.66	3.29	10.58	3.29	10.43	3.29	11.03	3.30	11.43	3.30
2.0 + 2.0 + 2.0 + 5.0 + 5.0	22	14.11	1.79	11.97	1.91	11.26	1.94	9.83	2.02	11.28	2.05	12.24	2.07
	25	13.25	2.28	11.87	2.35	11.41	2.37	10.50	2.42	11.51	2.43	12.19	2.44
	29	12.57	2.79	11.85	2.81	11.61	2.82	11.13	2.84	11.71	2.84	12.09	2.85
	32	11.75	3.07	11.57	3.07	11.52	3.07	11.40	3.07	11.77	3.07	12.01	3.08
	35	11.33	3.26	11.41	3.25	11.44	3.24	11.50	3.23	11.75	3.23	11.91	3.23
	40	10.92	3.38	11.10	3.37	11.17	3.36	11.29	3.35	11.54	3.34	11.71	3.34
	43	10.82	3.36	10.88	3.34	10.90	3.34	10.94	3.32	11.32	3.32	11.57	3.32
	46	10.88	3.23	10.66	3.23	10.58	3.23	10.43	3.23	11.03	3.24	11.43	3.24
2.0 + 2.0 + 2.0 + 5.0 + 6.0	22	14.11	1.79	11.97	1.91	11.26	1.94	9.83	2.02	11.28	2.05	12.24	2.07
	25	13.25	2.28	11.87	2.35	11.41	2.37	10.50	2.42	11.51	2.43	12.19	2.44
	29	12.57	2.79	11.85	2.81	11.61	2.82	11.13	2.84	11.71	2.84	12.09	2.85
	32	11.75	3.07	11.57	3.07	11.52	3.07	11.40	3.07	11.77	3.07	12.01	3.08
	35	11.33	3.26	11.41	3.25	11.44	3.24	11.50	3.23	11.75	3.23	11.91	3.23
	40	10.92	3.38	11.10	3.37	11.17	3.36	11.29	3.35	11.54	3.34	11.71	3.34
	43	10.82	3.36	10.88	3.34	10.90	3.34	10.94	3.32	11.32	3.32	11.57	3.32
	46	10.88	3.23	10.66	3.23	10.58	3.23	10.43	3.23	11.03	3.24	11.43	3.24
2.0 + 2.0 + 2.0 + 5.0 + 7.1	22	14.11	1.80	11.97	1.91	11.26	1.95	9.83	2.02	11.28	2.05	12.24	2.07
	25	13.25	2.29	11.87	2.36	11.41	2.38	10.50	2.43	11.51	2.44	12.19	2.45
	29	12.57	2.79	11.85	2.82	11.61	2.83	11.13	2.85	11.71	2.85	12.09	2.85
	32	11.75	3.08	11.57	3.08	11.52	3.08	11.40	3.08	11.77	3.08	12.01	3.09
	35	11.33	3.27	11.41	3.26	11.44	3.25	11.50	3.24	11.75	3.24	11.91	3.24
	40	10.92	3.39	11.10	3.38	11.17	3.37	11.29	3.36	11.54	3.35	11.71	3.35
	43	10.82	3.37	10.88	3.35	10.90	3.35	10.94	3.33	11.32	3.33	11.57	3.33
	46	10.88	3.24	10.66	3.24	10.58	3.24	10.43	3.24	11.03	3.25	11.43	3.25
2.0 + 2.0 + 2.0 + 6.0 + 6.0	22	14.11	1.79	11.97	1.91	11.26	1.94	9.83	2.02	11.28	2.05	12.24	2.07
	25	13.25	2.28	11.87	2.35	11.41	2.37	10.50	2.42	11.51	2.43	12.19	2.44
	29	12.57	2.79	11.85	2.81	11.61	2.82	11.13	2.84	11.71	2.84	12.09	2.85
	32	11.75	3.07	11.57	3.07	11.52	3.07	11.40	3.07	11.77	3.07	12.01	3.08
	35	11.33	3.26	11.41	3.25	11.44	3.24	11.50	3.23	11.75	3.23	11.91	3.23
	40	10.92	3.38	11.10	3.37	11.17	3.36	11.29	3.35	11.54	3.34	11.71	3.34
	43	10.82	3.36	10.88	3.34	10.90	3.34	10.94	3.32	11.32	3.32	11.57	3.32
	46	10.88	3.23	10.66	3.23	10.58	3.23	10.43	3.23	11.03	3.24	11.43	3.24

Combination (Capacity)	Outdoor Air Temp. °C DB	Indoor Air Temp. °C											
		27/16		27/17.5		27/18		27/19		27/22		27/24	
		Total Q	Input Power	Total Q	Input Power	Total Q	Input Power	Total Q	Input Power	Total Q	Input Power	Total Q	Input Power
2.0 + 2.0 + 2.5 + 2.5 + 2.5	22	14.11	1.94	11.97	2.06	11.26	2.10	9.83	2.18	11.28	2.21	12.24	2.23
	25	13.25	2.47	11.87	2.54	11.41	2.56	10.50	2.61	11.51	2.63	12.19	2.64
	29	12.57	3.01	11.85	3.04	11.61	3.05	11.13	3.07	11.71	3.07	12.09	3.07
	32	11.75	3.31	11.57	3.31	11.52	3.31	11.40	3.31	11.77	3.32	12.01	3.32
	35	11.33	3.53	11.41	3.51	11.44	3.50	11.50	3.49	11.75	3.49	11.91	3.49
	40	10.92	3.66	11.10	3.64	11.17	3.63	11.29	3.62	11.54	3.61	11.71	3.61
	43	10.82	3.63	10.88	3.61	10.90	3.60	10.94	3.59	11.32	3.59	11.57	3.59
	46	10.88	3.49	10.66	3.49	10.58	3.49	10.43	3.49	11.03	3.50	11.43	3.50
2.0 + 2.0 + 2.5 + 2.5 + 3.5	22	14.11	1.89	11.97	2.01	11.26	2.05	9.83	2.13	11.28	2.16	12.24	2.18
	25	13.25	2.41	11.87	2.48	11.41	2.50	10.50	2.55	11.51	2.57	12.19	2.58
	29	12.57	2.94	11.85	2.97	11.61	2.98	11.13	3.00	11.71	3.00	12.09	3.00
	32	11.75	3.24	11.57	3.24	11.52	3.24	11.40	3.24	11.77	3.24	12.01	3.25
	35	11.33	3.45	11.41	3.43	11.44	3.42	11.50	3.41	11.75	3.41	11.91	3.41
	40	10.92	3.57	11.10	3.55	11.17	3.55	11.29	3.54	11.54	3.53	11.71	3.53
	43	10.82	3.55	10.88	3.53	10.90	3.52	10.94	3.51	11.32	3.51	11.57	3.51
	46	10.88	3.41	10.66	3.41	10.58	3.41	10.43	3.41	11.03	3.42	11.43	3.42
2.0 + 2.0 + 2.5 + 2.5 + 4.2	22	14.11	1.89	11.97	2.01	11.26	2.05	9.83	2.13	11.28	2.16	12.24	2.18
	25	13.25	2.41	11.87	2.48	11.41	2.50	10.50	2.55	11.51	2.57	12.19	2.58
	29	12.57	2.94	11.85	2.97	11.61	2.98	11.13	3.00	11.71	3.00	12.09	3.00
	32	11.75	3.24	11.57	3.24	11.52	3.24	11.40	3.24	11.77	3.24	12.01	3.25
	35	11.33	3.45	11.41	3.43	11.44	3.42	11.50	3.41	11.75	3.41	11.91	3.41
	40	10.92	3.57	11.10	3.55	11.17	3.55	11.29	3.54	11.54	3.53	11.71	3.53
	43	10.82	3.55	10.88	3.53	10.90	3.52	10.94	3.51	11.32	3.51	11.57	3.51
	46	10.88	3.41	10.66	3.41	10.58	3.41	10.43	3.41	11.03	3.42	11.43	3.42
2.0 + 2.0 + 2.5 + 2.5 + 5.0	22	14.11	1.82	11.97	1.94	11.26	1.97	9.83	2.05	11.28	2.08	12.24	2.10
	25	13.25	2.32	11.87	2.39	11.41	2.41	10.50	2.46	11.51	2.47	12.19	2.48
	29	12.57	2.83	11.85	2.85	11.61	2.86	11.13	2.88	11.71	2.89	12.09	2.89
	32	11.75	3.12	11.57	3.12	11.52	3.12	11.40	3.12	11.77	3.12	12.01	3.12
	35	11.33	3.31	11.41	3.30	11.44	3.29	11.50	3.28	11.75	3.28	11.91	3.28
	40	10.92	3.44	11.10	3.42	11.17	3.41	11.29	3.40	11.54	3.40	11.71	3.39
	43	10.82	3.41	10.88	3.39	10.90	3.39	10.94	3.38	11.32	3.38	11.57	3.38
	46	10.88	3.28	10.66	3.28	10.58	3.28	10.43	3.28	11.03	3.29	11.43	3.29
2.0 + 2.0 + 2.5 + 2.5 + 6.0	22	14.11	1.82	11.97	1.94	11.26	1.97	9.83	2.05	11.28	2.08	12.24	2.10
	25	13.25	2.32	11.87	2.39	11.41	2.41	10.50	2.46	11.51	2.47	12.19	2.48
	29	12.57	2.83	11.85	2.85	11.61	2.86	11.13	2.88	11.71	2.89	12.09	2.89
	32	11.75	3.12	11.57	3.12	11.52	3.12	11.40	3.12	11.77	3.12	12.01	3.12
	35	11.33	3.31	11.41	3.30	11.44	3.29	11.50	3.28	11.75	3.28	11.91	3.28
	40	10.92	3.44	11.10	3.42	11.17	3.41	11.29	3.40	11.54	3.40	11.71	3.39
	43	10.82	3.41	10.88	3.39	10.90	3.39	10.94	3.38	11.32	3.38	11.57	3.38
	46	10.88	3.28	10.66	3.28	10.58	3.28	10.43	3.28	11.03	3.29	11.43	3.29

Combination (Capacity)	Outdoor Air Temp. °C DB	Indoor Air Temp. °C											
		27/16		27/17.5		27/18		27/19		27/22		27/24	
		Total Q	Input Power	Total Q	Input Power	Total Q	Input Power	Total Q	Input Power	Total Q	Input Power	Total Q	Input Power
2.0 + 2.0 + 2.5 + 2.5 + 7.1	22	14.11	1.82	11.97	1.94	11.26	1.97	9.83	2.05	11.28	2.08	12.24	2.10
	25	13.25	2.32	11.87	2.39	11.41	2.41	10.50	2.46	11.51	2.47	12.19	2.48
	29	12.57	2.83	11.85	2.85	11.61	2.86	11.13	2.88	11.71	2.89	12.09	2.89
	32	11.75	3.12	11.57	3.12	11.52	3.12	11.40	3.12	11.77	3.12	12.01	3.12
	35	11.33	3.31	11.41	3.30	11.44	3.29	11.50	3.28	11.75	3.28	11.91	3.28
	40	10.92	3.44	11.10	3.42	11.17	3.41	11.29	3.40	11.54	3.40	11.71	3.39
	43	10.82	3.41	10.88	3.39	10.90	3.39	10.94	3.38	11.32	3.38	11.57	3.38
	46	10.88	3.28	10.66	3.28	10.58	3.28	10.43	3.28	11.03	3.29	11.43	3.29
2.0 + 2.0 + 2.5 + 3.5 + 3.5	22	14.11	1.90	11.97	2.02	11.26	2.06	9.83	2.14	11.28	2.17	12.24	2.19
	25	13.25	2.42	11.87	2.49	11.41	2.51	10.50	2.56	11.51	2.58	12.19	2.59
	29	12.57	2.95	11.85	2.98	11.61	2.99	11.13	3.00	11.71	3.01	12.09	3.01
	32	11.75	3.25	11.57	3.25	11.52	3.25	11.40	3.25	11.77	3.25	12.01	3.26
	35	11.33	3.46	11.41	3.44	11.44	3.43	11.50	3.42	11.75	3.42	11.91	3.42
	40	10.92	3.58	11.10	3.56	11.17	3.56	11.29	3.55	11.54	3.54	11.71	3.54
	43	10.82	3.56	10.88	3.54	10.90	3.53	10.94	3.52	11.32	3.52	11.57	3.52
	46	10.88	3.42	10.66	3.42	10.58	3.42	10.43	3.42	11.03	3.43	11.43	3.43
2.0 + 2.0 + 2.5 + 3.5 + 4.2	22	14.11	1.90	11.97	2.02	11.26	2.06	9.83	2.14	11.28	2.17	12.24	2.19
	25	13.25	2.42	11.87	2.49	11.41	2.51	10.50	2.56	11.51	2.58	12.19	2.59
	29	12.57	2.95	11.85	2.98	11.61	2.99	11.13	3.00	11.71	3.01	12.09	3.01
	32	11.75	3.25	11.57	3.25	11.52	3.25	11.40	3.25	11.77	3.25	12.01	3.26
	35	11.33	3.46	11.41	3.44	11.44	3.43	11.50	3.42	11.75	3.42	11.91	3.42
	40	10.92	3.58	11.10	3.56	11.17	3.56	11.29	3.55	11.54	3.54	11.71	3.54
	43	10.82	3.56	10.88	3.54	10.90	3.53	10.94	3.52	11.32	3.52	11.57	3.52
	46	10.88	3.42	10.66	3.42	10.58	3.42	10.43	3.42	11.03	3.43	11.43	3.43
2.0 + 2.0 + 2.5 + 3.5 + 5.0	22	14.11	1.82	11.97	1.94	11.26	1.97	9.83	2.05	11.28	2.08	12.24	2.10
	25	13.25	2.32	11.87	2.39	11.41	2.41	10.50	2.46	11.51	2.47	12.19	2.48
	29	12.57	2.83	11.85	2.85	11.61	2.86	11.13	2.88	11.71	2.89	12.09	2.89
	32	11.75	3.12	11.57	3.12	11.52	3.12	11.40	3.12	11.77	3.12	12.01	3.12
	35	11.33	3.31	11.41	3.30	11.44	3.29	11.50	3.28	11.75	3.28	11.91	3.28
	40	10.92	3.44	11.10	3.42	11.17	3.41	11.29	3.40	11.54	3.40	11.71	3.39
	43	10.82	3.41	10.88	3.39	10.90	3.39	10.94	3.38	11.32	3.38	11.57	3.38
	46	10.88	3.28	10.66	3.28	10.58	3.28	10.43	3.28	11.03	3.29	11.43	3.29
2.0 + 2.0 + 2.5 + 3.5 + 6.0	22	14.11	1.82	11.97	1.94	11.26	1.97	9.83	2.05	11.28	2.08	12.24	2.10
	25	13.25	2.32	11.87	2.39	11.41	2.41	10.50	2.46	11.51	2.47	12.19	2.48
	29	12.57	2.83	11.85	2.85	11.61	2.86	11.13	2.88	11.71	2.89	12.09	2.89
	32	11.75	3.12	11.57	3.12	11.52	3.12	11.40	3.12	11.77	3.12	12.01	3.12
	35	11.33	3.31	11.41	3.30	11.44	3.29	11.50	3.28	11.75	3.28	11.91	3.28
	40	10.92	3.44	11.10	3.42	11.17	3.41	11.29	3.40	11.54	3.40	11.71	3.39
	43	10.82	3.41	10.88	3.39	10.90	3.39	10.94	3.38	11.32	3.38	11.57	3.38
	46	10.88	3.28	10.66	3.28	10.58	3.28	10.43	3.28	11.03	3.29	11.43	3.29

Combination (Capacity)	Outdoor Air Temp. °C DB	Indoor Air Temp. °C											
		27/16		27/17.5		27/18		27/19		27/22		27/24	
		Total Q	Input Power	Total Q	Input Power	Total Q	Input Power	Total Q	Input Power	Total Q	Input Power	Total Q	Input Power
2.0 + 2.0 + 2.5 + 3.5 + 7.1	22	14.11	1.83	11.97	1.94	11.26	1.98	9.83	2.05	11.28	2.09	12.24	2.11
	25	13.25	2.32	11.87	2.39	11.41	2.42	10.50	2.46	11.51	2.48	12.19	2.49
	29	12.57	2.84	11.85	2.86	11.61	2.87	11.13	2.89	11.71	2.89	12.09	2.90
	32	11.75	3.12	11.57	3.12	11.52	3.12	11.40	3.12	11.77	3.13	12.01	3.13
	35	11.33	3.32	11.41	3.31	11.44	3.30	11.50	3.29	11.75	3.29	11.91	3.29
	40	10.92	3.45	11.10	3.43	11.17	3.42	11.29	3.41	11.54	3.41	11.71	3.40
	43	10.82	3.42	10.88	3.40	10.90	3.40	10.94	3.39	11.32	3.39	11.57	3.39
	46	10.88	3.29	10.66	3.29	10.58	3.29	10.43	3.29	11.03	3.30	11.43	3.30
2.0 + 2.0 + 2.5 + 4.2 + 4.2	22	14.11	1.90	11.97	2.02	11.26	2.06	9.83	2.14	11.28	2.17	12.24	2.19
	25	13.25	2.42	11.87	2.49	11.41	2.51	10.50	2.56	11.51	2.58	12.19	2.59
	29	12.57	2.95	11.85	2.98	11.61	2.99	11.13	3.00	11.71	3.01	12.09	3.01
	32	11.75	3.25	11.57	3.25	11.52	3.25	11.40	3.25	11.77	3.25	12.01	3.26
	35	11.33	3.46	11.41	3.44	11.44	3.43	11.50	3.42	11.75	3.42	11.91	3.42
	40	10.92	3.58	11.10	3.56	11.17	3.56	11.29	3.55	11.54	3.54	11.71	3.54
	43	10.82	3.56	10.88	3.54	10.90	3.53	10.94	3.52	11.32	3.52	11.57	3.52
	46	10.88	3.42	10.66	3.42	10.58	3.42	10.43	3.42	11.03	3.43	11.43	3.43
2.0 + 2.0 + 2.5 + 4.2 + 5.0	22	14.11	1.82	11.97	1.94	11.26	1.97	9.83	2.05	11.28	2.08	12.24	2.10
	25	13.25	2.32	11.87	2.39	11.41	2.41	10.50	2.46	11.51	2.47	12.19	2.48
	29	12.57	2.83	11.85	2.85	11.61	2.86	11.13	2.88	11.71	2.89	12.09	2.89
	32	11.75	3.12	11.57	3.12	11.52	3.12	11.40	3.12	11.77	3.12	12.01	3.12
	35	11.33	3.31	11.41	3.30	11.44	3.29	11.50	3.28	11.75	3.28	11.91	3.28
	40	10.92	3.44	11.10	3.42	11.17	3.41	11.29	3.40	11.54	3.40	11.71	3.39
	43	10.82	3.41	10.88	3.39	10.90	3.39	10.94	3.38	11.32	3.38	11.57	3.38
	46	10.88	3.28	10.66	3.28	10.58	3.28	10.43	3.28	11.03	3.29	11.43	3.29
2.0 + 2.0 + 2.5 + 4.2 + 6.0	22	14.11	1.82	11.97	1.94	11.26	1.97	9.83	2.05	11.28	2.08	12.24	2.10
	25	13.25	2.32	11.87	2.39	11.41	2.41	10.50	2.46	11.51	2.47	12.19	2.48
	29	12.57	2.83	11.85	2.85	11.61	2.86	11.13	2.88	11.71	2.89	12.09	2.89
	32	11.75	3.12	11.57	3.12	11.52	3.12	11.40	3.12	11.77	3.12	12.01	3.12
	35	11.33	3.31	11.41	3.30	11.44	3.29	11.50	3.28	11.75	3.28	11.91	3.28
	40	10.92	3.44	11.10	3.42	11.17	3.41	11.29	3.40	11.54	3.40	11.71	3.39
	43	10.82	3.41	10.88	3.39	10.90	3.39	10.94	3.38	11.32	3.38	11.57	3.38
	46	10.88	3.28	10.66	3.28	10.58	3.28	10.43	3.28	11.03	3.29	11.43	3.29
2.0 + 2.0 + 2.5 + 4.2 + 7.1	22	14.11	1.83	11.97	1.94	11.26	1.98	9.83	2.05	11.28	2.09	12.24	2.11
	25	13.25	2.32	11.87	2.39	11.41	2.42	10.50	2.46	11.51	2.48	12.19	2.49
	29	12.57	2.84	11.85	2.86	11.61	2.87	11.13	2.89	11.71	2.89	12.09	2.90
	32	11.75	3.12	11.57	3.12	11.52	3.12	11.40	3.12	11.77	3.13	12.01	3.13
	35	11.33	3.32	11.41	3.31	11.44	3.30	11.50	3.29	11.75	3.29	11.91	3.29
	40	10.92	3.45	11.10	3.43	11.17	3.42	11.29	3.41	11.54	3.41	11.71	3.40
	43	10.82	3.42	10.88	3.40	10.90	3.40	10.94	3.39	11.32	3.39	11.57	3.39
	46	10.88	3.29	10.66	3.29	10.58	3.29	10.43	3.29	11.03	3.30	11.43	3.30

Combination (Capacity)	Outdoor Air Temp. °C DB	Indoor Air Temp. °C											
		27/16		27/17.5		27/18		27/19		27/22		27/24	
		Total Q	Input Power	Total Q	Input Power	Total Q	Input Power	Total Q	Input Power	Total Q	Input Power	Total Q	Input Power
2.0 + 2.0 + 2.5 + 5.0 + 5.0	22	14.11	1.79	11.97	1.91	11.26	1.94	9.83	2.02	11.28	2.05	12.24	2.07
	25	13.25	2.28	11.87	2.35	11.41	2.37	10.50	2.42	11.51	2.43	12.19	2.44
	29	12.57	2.79	11.85	2.81	11.61	2.82	11.13	2.84	11.71	2.84	12.09	2.85
	32	11.75	3.07	11.57	3.07	11.52	3.07	11.40	3.07	11.77	3.07	12.01	3.08
	35	11.33	3.26	11.41	3.25	11.44	3.24	11.50	3.23	11.75	3.23	11.91	3.23
	40	10.92	3.38	11.10	3.37	11.17	3.36	11.29	3.35	11.54	3.34	11.71	3.34
	43	10.82	3.36	10.88	3.34	10.90	3.34	10.94	3.32	11.32	3.32	11.57	3.32
	46	10.88	3.23	10.66	3.23	10.58	3.23	10.43	3.23	11.03	3.24	11.43	3.24
2.0 + 2.0 + 2.5 + 5.0 + 6.0	22	14.11	1.79	11.97	1.91	11.26	1.94	9.83	2.02	11.28	2.05	12.24	2.07
	25	13.25	2.28	11.87	2.35	11.41	2.37	10.50	2.42	11.51	2.43	12.19	2.44
	29	12.57	2.79	11.85	2.81	11.61	2.82	11.13	2.84	11.71	2.84	12.09	2.85
	32	11.75	3.07	11.57	3.07	11.52	3.07	11.40	3.07	11.77	3.07	12.01	3.08
	35	11.33	3.26	11.41	3.25	11.44	3.24	11.50	3.23	11.75	3.23	11.91	3.23
	40	10.92	3.38	11.10	3.37	11.17	3.36	11.29	3.35	11.54	3.34	11.71	3.34
	43	10.82	3.36	10.88	3.34	10.90	3.34	10.94	3.32	11.32	3.32	11.57	3.32
	46	10.88	3.23	10.66	3.23	10.58	3.23	10.43	3.23	11.03	3.24	11.43	3.24
2.0 + 2.0 + 3.5 + 3.5 + 3.5	22	14.11	1.86	11.97	1.97	11.26	2.01	9.83	2.09	11.28	2.12	12.24	2.14
	25	13.25	2.36	11.87	2.43	11.41	2.45	10.50	2.50	11.51	2.52	12.19	2.53
	29	12.57	2.88	11.85	2.91	11.61	2.92	11.13	2.93	11.71	2.94	12.09	2.94
	32	11.75	3.17	11.57	3.17	11.52	3.17	11.40	3.17	11.77	3.18	12.01	3.18
	35	11.33	3.38	11.41	3.36	11.44	3.35	11.50	3.34	11.75	3.34	11.91	3.34
	40	10.92	3.50	11.10	3.48	11.17	3.48	11.29	3.46	11.54	3.46	11.71	3.45
	43	10.82	3.47	10.88	3.45	10.90	3.45	10.94	3.44	11.32	3.44	11.57	3.44
	46	10.88	3.34	10.66	3.34	10.58	3.34	10.43	3.34	11.03	3.35	11.43	3.35
2.0 + 2.0 + 3.5 + 3.5 + 4.2	22	14.11	1.86	11.97	1.97	11.26	2.01	9.83	2.09	11.28	2.12	12.24	2.14
	25	13.25	2.36	11.87	2.43	11.41	2.45	10.50	2.50	11.51	2.52	12.19	2.53
	29	12.57	2.88	11.85	2.91	11.61	2.92	11.13	2.93	11.71	2.94	12.09	2.94
	32	11.75	3.17	11.57	3.17	11.52	3.17	11.40	3.17	11.77	3.18	12.01	3.18
	35	11.33	3.38	11.41	3.36	11.44	3.35	11.50	3.34	11.75	3.34	11.91	3.34
	40	10.92	3.50	11.10	3.48	11.17	3.48	11.29	3.46	11.54	3.46	11.71	3.45
	43	10.82	3.47	10.88	3.45	10.90	3.45	10.94	3.44	11.32	3.44	11.57	3.44
	46	10.88	3.34	10.66	3.34	10.58	3.34	10.43	3.34	11.03	3.35	11.43	3.35
2.0 + 2.0 + 3.5 + 3.5 + 5.0	22	14.11	1.83	11.97	1.94	11.26	1.98	9.83	2.05	11.28	2.09	12.24	2.11
	25	13.25	2.32	11.87	2.39	11.41	2.42	10.50	2.46	11.51	2.48	12.19	2.49
	29	12.57	2.84	11.85	2.86	11.61	2.87	11.13	2.89	11.71	2.89	12.09	2.90
	32	11.75	3.12	11.57	3.12	11.52	3.12	11.40	3.12	11.77	3.13	12.01	3.13
	35	11.33	3.32	11.41	3.31	11.44	3.30	11.50	3.29	11.75	3.29	11.91	3.29
	40	10.92	3.45	11.10	3.43	11.17	3.42	11.29	3.41	11.54	3.41	11.71	3.40
	43	10.82	3.42	10.88	3.40	10.90	3.40	10.94	3.39	11.32	3.39	11.57	3.39
	46	10.88	3.29	10.66	3.29	10.58	3.29	10.43	3.29	11.03	3.30	11.43	3.30

Combination (Capacity)	Outdoor Air Temp. °C DB	Indoor Air Temp. °C											
		27/16		27/17.5		27/18		27/19		27/22		27/24	
		Total Q	Input Power	Total Q	Input Power	Total Q	Input Power	Total Q	Input Power	Total Q	Input Power	Total Q	Input Power
2.0 + 2.0 + 3.5 + 3.5 + 6.0	22	14.11	1.83	11.97	1.94	11.26	1.98	9.83	2.05	11.28	2.09	12.24	2.11
	25	13.25	2.32	11.87	2.39	11.41	2.42	10.50	2.46	11.51	2.48	12.19	2.49
	29	12.57	2.84	11.85	2.86	11.61	2.87	11.13	2.89	11.71	2.89	12.09	2.90
	32	11.75	3.12	11.57	3.12	11.52	3.12	11.40	3.12	11.77	3.13	12.01	3.13
	35	11.33	3.32	11.41	3.31	11.44	3.30	11.50	3.29	11.75	3.29	11.91	3.29
	40	10.92	3.45	11.10	3.43	11.17	3.42	11.29	3.41	11.54	3.41	11.71	3.40
	43	10.82	3.42	10.88	3.40	10.90	3.40	10.94	3.39	11.32	3.39	11.57	3.39
	46	10.88	3.29	10.66	3.29	10.58	3.29	10.43	3.29	11.03	3.30	11.43	3.30
2.0 + 2.0 + 3.5 + 3.5 + 7.1	22	14.11	1.83	11.97	1.94	11.26	1.98	9.83	2.05	11.28	2.09	12.24	2.11
	25	13.25	2.32	11.87	2.39	11.41	2.42	10.50	2.46	11.51	2.48	12.19	2.49
	29	12.57	2.84	11.85	2.86	11.61	2.87	11.13	2.89	11.71	2.89	12.09	2.90
	32	11.75	3.12	11.57	3.12	11.52	3.12	11.40	3.12	11.77	3.13	12.01	3.13
	35	11.33	3.32	11.41	3.31	11.44	3.30	11.50	3.29	11.75	3.29	11.91	3.29
	40	10.92	3.45	11.10	3.43	11.17	3.42	11.29	3.41	11.54	3.41	11.71	3.40
	43	10.82	3.42	10.88	3.40	10.90	3.40	10.94	3.39	11.32	3.39	11.57	3.39
	46	10.88	3.29	10.66	3.29	10.58	3.29	10.43	3.29	11.03	3.30	11.43	3.30
2.0 + 2.0 + 3.5 + 4.2 + 4.2	22	14.11	1.86	11.97	1.98	11.26	2.01	9.83	2.09	11.28	2.12	12.24	2.14
	25	13.25	2.37	11.87	2.44	11.41	2.46	10.50	2.51	11.51	2.52	12.19	2.53
	29	12.57	2.89	11.85	2.92	11.61	2.92	11.13	2.94	11.71	2.95	12.09	2.95
	32	11.75	3.18	11.57	3.18	11.52	3.18	11.40	3.18	11.77	3.19	12.01	3.19
	35	11.33	3.39	11.41	3.37	11.44	3.36	11.50	3.35	11.75	3.35	11.91	3.35
	40	10.92	3.51	11.10	3.49	11.17	3.49	11.29	3.47	11.54	3.47	11.71	3.47
	43	10.82	3.48	10.88	3.47	10.90	3.46	10.94	3.45	11.32	3.45	11.57	3.45
	46	10.88	3.35	10.66	3.35	10.58	3.35	10.43	3.35	11.03	3.36	11.43	3.36
2.0 + 2.0 + 3.5 + 4.2 + 5.0	22	14.11	1.83	11.97	1.94	11.26	1.98	9.83	2.05	11.28	2.09	12.24	2.11
	25	13.25	2.32	11.87	2.39	11.41	2.42	10.50	2.46	11.51	2.48	12.19	2.49
	29	12.57	2.84	11.85	2.86	11.61	2.87	11.13	2.89	11.71	2.89	12.09	2.90
	32	11.75	3.12	11.57	3.12	11.52	3.12	11.40	3.12	11.77	3.13	12.01	3.13
	35	11.33	3.32	11.41	3.31	11.44	3.30	11.50	3.29	11.75	3.29	11.91	3.29
	40	10.92	3.45	11.10	3.43	11.17	3.42	11.29	3.41	11.54	3.41	11.71	3.40
	43	10.82	3.42	10.88	3.40	10.90	3.40	10.94	3.39	11.32	3.39	11.57	3.39
	46	10.88	3.29	10.66	3.29	10.58	3.29	10.43	3.29	11.03	3.30	11.43	3.30
2.0 + 2.0 + 3.5 + 4.2 + 6.0	22	14.11	1.83	11.97	1.94	11.26	1.98	9.83	2.05	11.28	2.09	12.24	2.11
	25	13.25	2.32	11.87	2.39	11.41	2.42	10.50	2.46	11.51	2.48	12.19	2.49
	29	12.57	2.84	11.85	2.86	11.61	2.87	11.13	2.89	11.71	2.89	12.09	2.90
	32	11.75	3.12	11.57	3.12	11.52	3.12	11.40	3.12	11.77	3.13	12.01	3.13
	35	11.33	3.32	11.41	3.31	11.44	3.30	11.50	3.29	11.75	3.29	11.91	3.29
	40	10.92	3.45	11.10	3.43	11.17	3.42	11.29	3.41	11.54	3.41	11.71	3.40
	43	10.82	3.42	10.88	3.40	10.90	3.40	10.94	3.39	11.32	3.39	11.57	3.39
	46	10.88	3.29	10.66	3.29	10.58	3.29	10.43	3.29	11.03	3.30	11.43	3.30



Combination (Capacity)	Outdoor Air Temp. °C DB	Indoor Air Temp. °C											
		27/16		27/17.5		27/18		27/19		27/22		27/24	
		Total Q	Input Power	Total Q	Input Power	Total Q	Input Power	Total Q	Input Power	Total Q	Input Power	Total Q	Input Power
2.0 + 2.0 + 3.5 + 5.0 + 5.0	22	14.11	1.80	11.97	1.91	11.26	1.95	9.83	2.02	11.28	2.05	12.24	2.07
	25	13.25	2.29	11.87	2.36	11.41	2.38	10.50	2.43	11.51	2.44	12.19	2.45
	29	12.57	2.79	11.85	2.82	11.61	2.83	11.13	2.85	11.71	2.85	12.09	2.85
	32	11.75	3.08	11.57	3.08	11.52	3.08	11.40	3.08	11.77	3.08	12.01	3.09
	35	11.33	3.27	11.41	3.26	11.44	3.25	11.50	3.24	11.75	3.24	11.91	3.24
	40	10.92	3.39	11.10	3.38	11.17	3.37	11.29	3.36	11.54	3.35	11.71	3.35
	43	10.82	3.37	10.88	3.35	10.90	3.35	10.94	3.33	11.32	3.33	11.57	3.33
	46	10.88	3.24	10.66	3.24	10.58	3.24	10.43	3.24	11.03	3.25	11.43	3.25
2.0 + 2.0 + 4.2 + 4.2 + 4.2	22	14.11	1.86	11.97	1.98	11.26	2.01	9.83	2.09	11.28	2.12	12.24	2.14
	25	13.25	2.37	11.87	2.44	11.41	2.46	10.50	2.51	11.51	2.52	12.19	2.53
	29	12.57	2.89	11.85	2.92	11.61	2.92	11.13	2.94	11.71	2.95	12.09	2.95
	32	11.75	3.18	11.57	3.18	11.52	3.18	11.40	3.18	11.77	3.19	12.01	3.19
	35	11.33	3.39	11.41	3.37	11.44	3.36	11.50	3.35	11.75	3.35	11.91	3.35
	40	10.92	3.51	11.10	3.49	11.17	3.49	11.29	3.47	11.54	3.47	11.71	3.47
	43	10.82	3.48	10.88	3.47	10.90	3.46	10.94	3.45	11.32	3.45	11.57	3.45
	46	10.88	3.35	10.66	3.35	10.58	3.35	10.43	3.35	11.03	3.36	11.43	3.36
2.0 + 2.0 + 4.2 + 4.2 + 5.0	22	14.11	1.83	11.97	1.94	11.26	1.98	9.83	2.05	11.28	2.09	12.24	2.11
	25	13.25	2.32	11.87	2.39	11.41	2.42	10.50	2.46	11.51	2.48	12.19	2.49
	29	12.57	2.84	11.85	2.86	11.61	2.87	11.13	2.89	11.71	2.89	12.09	2.90
	32	11.75	3.12	11.57	3.12	11.52	3.12	11.40	3.12	11.77	3.13	12.01	3.13
	35	11.33	3.32	11.41	3.31	11.44	3.30	11.50	3.29	11.75	3.29	11.91	3.29
	40	10.92	3.45	11.10	3.43	11.17	3.42	11.29	3.41	11.54	3.41	11.71	3.40
	43	10.82	3.42	10.88	3.40	10.90	3.40	10.94	3.39	11.32	3.39	11.57	3.39
	46	10.88	3.29	10.66	3.29	10.58	3.29	10.43	3.29	11.03	3.30	11.43	3.30
2.0 + 2.0 + 4.2 + 5.0 + 5.0	22	14.11	1.80	11.97	1.91	11.26	1.95	9.83	2.02	11.28	2.05	12.24	2.07
	25	13.25	2.29	11.87	2.36	11.41	2.38	10.50	2.43	11.51	2.44	12.19	2.45
	29	12.57	2.79	11.85	2.82	11.61	2.83	11.13	2.85	11.71	2.85	12.09	2.85
	32	11.75	3.08	11.57	3.08	11.52	3.08	11.40	3.08	11.77	3.08	12.01	3.09
	35	11.33	3.27	11.41	3.26	11.44	3.25	11.50	3.24	11.75	3.24	11.91	3.24
	40	10.92	3.39	11.10	3.38	11.17	3.37	11.29	3.36	11.54	3.35	11.71	3.35
	43	10.82	3.37	10.88	3.35	10.90	3.35	10.94	3.33	11.32	3.33	11.57	3.33
	46	10.88	3.24	10.66	3.24	10.58	3.24	10.43	3.24	11.03	3.25	11.43	3.25
2.0 + 2.5 + 2.5 + 2.5 + 2.5	22	14.11	1.94	11.97	2.06	11.26	2.10	9.83	2.18	11.28	2.21	12.24	2.23
	25	13.25	2.47	11.87	2.54	11.41	2.56	10.50	2.61	11.51	2.63	12.19	2.64
	29	12.57	3.01	11.85	3.04	11.61	3.05	11.13	3.07	11.71	3.07	12.09	3.07
	32	11.75	3.31	11.57	3.31	11.52	3.31	11.40	3.31	11.77	3.32	12.01	3.32
	35	11.33	3.53	11.41	3.51	11.44	3.50	11.50	3.49	11.75	3.49	11.91	3.49
	40	10.92	3.66	11.10	3.64	11.17	3.63	11.29	3.62	11.54	3.61	11.71	3.61
	43	10.82	3.63	10.88	3.61	10.90	3.60	10.94	3.59	11.32	3.59	11.57	3.59
	46	10.88	3.49	10.66	3.49	10.58	3.49	10.43	3.49	11.03	3.50	11.43	3.50

Combination (Capacity)	Outdoor Air Temp. °C DB	Indoor Air Temp. °C											
		27/16		27/17.5		27/18		27/19		27/22		27/24	
		Total Q	Input Power	Total Q	Input Power	Total Q	Input Power	Total Q	Input Power	Total Q	Input Power	Total Q	Input Power
2.0 + 2.5 + 2.5 + 2.5 + 3.5	22	14.11	1.89	11.97	2.01	11.26	2.05	9.83	2.13	11.28	2.16	12.24	2.18
	25	13.25	2.41	11.87	2.48	11.41	2.50	10.50	2.55	11.51	2.57	12.19	2.58
	29	12.57	2.94	11.85	2.97	11.61	2.98	11.13	3.00	11.71	3.00	12.09	3.00
	32	11.75	3.24	11.57	3.24	11.52	3.24	11.40	3.24	11.77	3.24	12.01	3.25
	35	11.33	3.45	11.41	3.43	11.44	3.42	11.50	3.41	11.75	3.41	11.91	3.41
	40	10.92	3.57	11.10	3.55	11.17	3.55	11.29	3.54	11.54	3.53	11.71	3.53
	43	10.82	3.55	10.88	3.53	10.90	3.52	10.94	3.51	11.32	3.51	11.57	3.51
	46	10.88	3.41	10.66	3.41	10.58	3.41	10.43	3.41	11.03	3.42	11.43	3.42
2.0 + 2.5 + 2.5 + 2.5 + 4.2	22	14.11	1.89	11.97	2.01	11.26	2.05	9.83	2.13	11.28	2.16	12.24	2.18
	25	13.25	2.41	11.87	2.48	11.41	2.50	10.50	2.55	11.51	2.57	12.19	2.58
	29	12.57	2.94	11.85	2.97	11.61	2.98	11.13	3.00	11.71	3.00	12.09	3.00
	32	11.75	3.24	11.57	3.24	11.52	3.24	11.40	3.24	11.77	3.24	12.01	3.25
	35	11.33	3.45	11.41	3.43	11.44	3.42	11.50	3.41	11.75	3.41	11.91	3.41
	40	10.92	3.57	11.10	3.55	11.17	3.55	11.29	3.54	11.54	3.53	11.71	3.53
	43	10.82	3.55	10.88	3.53	10.90	3.52	10.94	3.51	11.32	3.51	11.57	3.51
	46	10.88	3.41	10.66	3.41	10.58	3.41	10.43	3.41	11.03	3.42	11.43	3.42
2.0 + 2.5 + 2.5 + 2.5 + 5.0	22	14.11	1.82	11.97	1.94	11.26	1.97	9.83	2.05	11.28	2.08	12.24	2.10
	25	13.25	2.32	11.87	2.39	11.41	2.41	10.50	2.46	11.51	2.47	12.19	2.48
	29	12.57	2.83	11.85	2.85	11.61	2.86	11.13	2.88	11.71	2.89	12.09	2.89
	32	11.75	3.12	11.57	3.12	11.52	3.12	11.40	3.12	11.77	3.12	12.01	3.12
	35	11.33	3.31	11.41	3.30	11.44	3.29	11.50	3.28	11.75	3.28	11.91	3.28
	40	10.92	3.44	11.10	3.42	11.17	3.41	11.29	3.40	11.54	3.40	11.71	3.39
	43	10.82	3.41	10.88	3.39	10.90	3.39	10.94	3.38	11.32	3.38	11.57	3.38
	46	10.88	3.28	10.66	3.28	10.58	3.28	10.43	3.28	11.03	3.29	11.43	3.29
2.0 + 2.5 + 2.5 + 2.5 + 6.0	22	14.11	1.82	11.97	1.94	11.26	1.97	9.83	2.05	11.28	2.08	12.24	2.10
	25	13.25	2.32	11.87	2.39	11.41	2.41	10.50	2.46	11.51	2.47	12.19	2.48
	29	12.57	2.83	11.85	2.85	11.61	2.86	11.13	2.88	11.71	2.89	12.09	2.89
	32	11.75	3.12	11.57	3.12	11.52	3.12	11.40	3.12	11.77	3.12	12.01	3.12
	35	11.33	3.31	11.41	3.30	11.44	3.29	11.50	3.28	11.75	3.28	11.91	3.28
	40	10.92	3.44	11.10	3.42	11.17	3.41	11.29	3.40	11.54	3.40	11.71	3.39
	43	10.82	3.41	10.88	3.39	10.90	3.39	10.94	3.38	11.32	3.38	11.57	3.38
	46	10.88	3.28	10.66	3.28	10.58	3.28	10.43	3.28	11.03	3.29	11.43	3.29
2.0 + 2.5 + 2.5 + 2.5 + 7.1	22	14.11	1.82	11.97	1.94	11.26	1.97	9.83	2.05	11.28	2.08	12.24	2.10
	25	13.25	2.32	11.87	2.39	11.41	2.41	10.50	2.46	11.51	2.47	12.19	2.48
	29	12.57	2.83	11.85	2.85	11.61	2.86	11.13	2.88	11.71	2.89	12.09	2.89
	32	11.75	3.12	11.57	3.12	11.52	3.12	11.40	3.12	11.77	3.12	12.01	3.12
	35	11.33	3.31	11.41	3.30	11.44	3.29	11.50	3.28	11.75	3.28	11.91	3.28
	40	10.92	3.44	11.10	3.42	11.17	3.41	11.29	3.40	11.54	3.40	11.71	3.39
	43	10.82	3.41	10.88	3.39	10.90	3.39	10.94	3.38	11.32	3.38	11.57	3.38
	46	10.88	3.28	10.66	3.28	10.58	3.28	10.43	3.28	11.03	3.29	11.43	3.29

Combination (Capacity)	Outdoor Air Temp. °C DB	Indoor Air Temp. °C											
		27/16		27/17.5		27/18		27/19		27/22		27/24	
		Total Q	Input Power	Total Q	Input Power	Total Q	Input Power	Total Q	Input Power	Total Q	Input Power	Total Q	Input Power
2.0 + 2.5 + 2.5 + 3.5 + 3.5	22	14.11	1.90	11.97	2.02	11.26	2.06	9.83	2.14	11.28	2.17	12.24	2.19
	25	13.25	2.42	11.87	2.49	11.41	2.51	10.50	2.56	11.51	2.58	12.19	2.59
	29	12.57	2.95	11.85	2.98	11.61	2.99	11.13	3.00	11.71	3.01	12.09	3.01
	32	11.75	3.25	11.57	3.25	11.52	3.25	11.40	3.25	11.77	3.25	12.01	3.26
	35	11.33	3.46	11.41	3.44	11.44	3.43	11.50	3.42	11.75	3.42	11.91	3.42
	40	10.92	3.58	11.10	3.56	11.17	3.56	11.29	3.55	11.54	3.54	11.71	3.54
	43	10.82	3.56	10.88	3.54	10.90	3.53	10.94	3.52	11.32	3.52	11.57	3.52
	46	10.88	3.42	10.66	3.42	10.58	3.42	10.43	3.42	11.03	3.43	11.43	3.43
2.0 + 2.5 + 2.5 + 3.5 + 4.2	22	14.11	1.90	11.97	2.02	11.26	2.06	9.83	2.14	11.28	2.17	12.24	2.19
	25	13.25	2.42	11.87	2.49	11.41	2.51	10.50	2.56	11.51	2.58	12.19	2.59
	29	12.57	2.95	11.85	2.98	11.61	2.99	11.13	3.00	11.71	3.01	12.09	3.01
	32	11.75	3.25	11.57	3.25	11.52	3.25	11.40	3.25	11.77	3.25	12.01	3.26
	35	11.33	3.46	11.41	3.44	11.44	3.43	11.50	3.42	11.75	3.42	11.91	3.42
	40	10.92	3.58	11.10	3.56	11.17	3.56	11.29	3.55	11.54	3.54	11.71	3.54
	43	10.82	3.56	10.88	3.54	10.90	3.53	10.94	3.52	11.32	3.52	11.57	3.52
	46	10.88	3.42	10.66	3.42	10.58	3.42	10.43	3.42	11.03	3.43	11.43	3.43
2.0 + 2.5 + 2.5 + 3.5 + 5.0	22	14.11	1.82	11.97	1.94	11.26	1.97	9.83	2.05	11.28	2.08	12.24	2.10
	25	13.25	2.32	11.87	2.39	11.41	2.41	10.50	2.46	11.51	2.47	12.19	2.48
	29	12.57	2.83	11.85	2.85	11.61	2.86	11.13	2.88	11.71	2.89	12.09	2.89
	32	11.75	3.12	11.57	3.12	11.52	3.12	11.40	3.12	11.77	3.12	12.01	3.12
	35	11.33	3.31	11.41	3.30	11.44	3.29	11.50	3.28	11.75	3.28	11.91	3.28
	40	10.92	3.44	11.10	3.42	11.17	3.41	11.29	3.40	11.54	3.40	11.71	3.39
	43	10.82	3.41	10.88	3.39	10.90	3.39	10.94	3.38	11.32	3.38	11.57	3.38
	46	10.88	3.28	10.66	3.28	10.58	3.28	10.43	3.28	11.03	3.29	11.43	3.29
2.0 + 2.5 + 2.5 + 3.5 + 6.0	22	14.11	1.82	11.97	1.94	11.26	1.97	9.83	2.05	11.28	2.08	12.24	2.10
	25	13.25	2.32	11.87	2.39	11.41	2.41	10.50	2.46	11.51	2.47	12.19	2.48
	29	12.57	2.83	11.85	2.85	11.61	2.86	11.13	2.88	11.71	2.89	12.09	2.89
	32	11.75	3.12	11.57	3.12	11.52	3.12	11.40	3.12	11.77	3.12	12.01	3.12
	35	11.33	3.31	11.41	3.30	11.44	3.29	11.50	3.28	11.75	3.28	11.91	3.28
	40	10.92	3.44	11.10	3.42	11.17	3.41	11.29	3.40	11.54	3.40	11.71	3.39
	43	10.82	3.41	10.88	3.39	10.90	3.39	10.94	3.38	11.32	3.38	11.57	3.38
	46	10.88	3.28	10.66	3.28	10.58	3.28	10.43	3.28	11.03	3.29	11.43	3.29
2.0 + 2.5 + 2.5 + 3.5 + 7.1	22	14.11	1.83	11.97	1.94	11.26	1.98	9.83	2.05	11.28	2.09	12.24	2.11
	25	13.25	2.32	11.87	2.39	11.41	2.42	10.50	2.46	11.51	2.48	12.19	2.49
	29	12.57	2.84	11.85	2.86	11.61	2.87	11.13	2.89	11.71	2.89	12.09	2.90
	32	11.75	3.12	11.57	3.12	11.52	3.12	11.40	3.12	11.77	3.13	12.01	3.13
	35	11.33	3.32	11.41	3.31	11.44	3.30	11.50	3.29	11.75	3.29	11.91	3.29
	40	10.92	3.45	11.10	3.43	11.17	3.42	11.29	3.41	11.54	3.41	11.71	3.40
	43	10.82	3.42	10.88	3.40	10.90	3.40	10.94	3.39	11.32	3.39	11.57	3.39
	46	10.88	3.29	10.66	3.29	10.58	3.29	10.43	3.29	11.03	3.30	11.43	3.30

Combination (Capacity)	Outdoor Air Temp. °C DB	Indoor Air Temp. °C											
		27/16		27/17.5		27/18		27/19		27/22		27/24	
		Total Q	Input Power	Total Q	Input Power	Total Q	Input Power	Total Q	Input Power	Total Q	Input Power	Total Q	Input Power
2.0 + 2.5 + 2.5 + 4.2 + 4.2	22	14.11	1.90	11.97	2.02	11.26	2.06	9.83	2.14	11.28	2.17	12.24	2.19
	25	13.25	2.42	11.87	2.49	11.41	2.51	10.50	2.56	11.51	2.58	12.19	2.59
	29	12.57	2.95	11.85	2.98	11.61	2.99	11.13	3.00	11.71	3.01	12.09	3.01
	32	11.75	3.25	11.57	3.25	11.52	3.25	11.40	3.25	11.77	3.25	12.01	3.26
	35	11.33	3.46	11.41	3.44	11.44	3.43	11.50	3.42	11.75	3.42	11.91	3.42
	40	10.92	3.58	11.10	3.56	11.17	3.56	11.29	3.55	11.54	3.54	11.71	3.54
	43	10.82	3.56	10.88	3.54	10.90	3.53	10.94	3.52	11.32	3.52	11.57	3.52
	46	10.88	3.42	10.66	3.42	10.58	3.42	10.43	3.42	11.03	3.43	11.43	3.43
2.0 + 2.5 + 2.5 + 4.2 + 5.0	22	14.11	1.82	11.97	1.94	11.26	1.97	9.83	2.05	11.28	2.08	12.24	2.10
	25	13.25	2.32	11.87	2.39	11.41	2.41	10.50	2.46	11.51	2.47	12.19	2.48
	29	12.57	2.83	11.85	2.85	11.61	2.86	11.13	2.88	11.71	2.89	12.09	2.89
	32	11.75	3.12	11.57	3.12	11.52	3.12	11.40	3.12	11.77	3.12	12.01	3.12
	35	11.33	3.31	11.41	3.30	11.44	3.29	11.50	3.28	11.75	3.28	11.91	3.28
	40	10.92	3.44	11.10	3.42	11.17	3.41	11.29	3.40	11.54	3.40	11.71	3.39
	43	10.82	3.41	10.88	3.39	10.90	3.39	10.94	3.38	11.32	3.38	11.57	3.38
	46	10.88	3.28	10.66	3.28	10.58	3.28	10.43	3.28	11.03	3.29	11.43	3.29
2.0 + 2.5 + 2.5 + 4.2 + 6.0	22	14.11	1.82	11.97	1.94	11.26	1.97	9.83	2.05	11.28	2.08	12.24	2.10
	25	13.25	2.32	11.87	2.39	11.41	2.41	10.50	2.46	11.51	2.47	12.19	2.48
	29	12.57	2.83	11.85	2.85	11.61	2.86	11.13	2.88	11.71	2.89	12.09	2.89
	32	11.75	3.12	11.57	3.12	11.52	3.12	11.40	3.12	11.77	3.12	12.01	3.12
	35	11.33	3.31	11.41	3.30	11.44	3.29	11.50	3.28	11.75	3.28	11.91	3.28
	40	10.92	3.44	11.10	3.42	11.17	3.41	11.29	3.40	11.54	3.40	11.71	3.39
	43	10.82	3.41	10.88	3.39	10.90	3.39	10.94	3.38	11.32	3.38	11.57	3.38
	46	10.88	3.28	10.66	3.28	10.58	3.28	10.43	3.28	11.03	3.29	11.43	3.29
2.0 + 2.5 + 2.5 + 4.2 + 7.1	22	14.11	1.83	11.97	1.94	11.26	1.98	9.83	2.05	11.28	2.09	12.24	2.11
	25	13.25	2.32	11.87	2.39	11.41	2.42	10.50	2.46	11.51	2.48	12.19	2.49
	29	12.57	2.84	11.85	2.86	11.61	2.87	11.13	2.89	11.71	2.89	12.09	2.90
	32	11.75	3.12	11.57	3.12	11.52	3.12	11.40	3.12	11.77	3.13	12.01	3.13
	35	11.33	3.32	11.41	3.31	11.44	3.30	11.50	3.29	11.75	3.29	11.91	3.29
	40	10.92	3.45	11.10	3.43	11.17	3.42	11.29	3.41	11.54	3.41	11.71	3.40
	43	10.82	3.42	10.88	3.40	10.90	3.40	10.94	3.39	11.32	3.39	11.57	3.39
	46	10.88	3.29	10.66	3.29	10.58	3.29	10.43	3.29	11.03	3.30	11.43	3.30
2.0 + 2.5 + 2.5 + 5.0 + 5.0	22	14.11	1.79	11.97	1.91	11.26	1.94	9.83	2.02	11.28	2.05	12.24	2.07
	25	13.25	2.28	11.87	2.35	11.41	2.37	10.50	2.42	11.51	2.43	12.19	2.44
	29	12.57	2.79	11.85	2.81	11.61	2.82	11.13	2.84	11.71	2.84	12.09	2.85
	32	11.75	3.07	11.57	3.07	11.52	3.07	11.40	3.07	11.77	3.07	12.01	3.08
	35	11.33	3.26	11.41	3.25	11.44	3.24	11.50	3.23	11.75	3.23	11.91	3.23
	40	10.92	3.38	11.10	3.37	11.17	3.36	11.29	3.35	11.54	3.34	11.71	3.34
	43	10.82	3.36	10.88	3.34	10.90	3.34	10.94	3.32	11.32	3.32	11.57	3.32
	46	10.88	3.23	10.66	3.23	10.58	3.23	10.43	3.23	11.03	3.24	11.43	3.24

Combination (Capacity)	Outdoor Air Temp. °C DB	Indoor Air Temp. °C											
		27/16		27/17.5		27/18		27/19		27/22		27/24	
		Total Q	Input Power	Total Q	Input Power	Total Q	Input Power	Total Q	Input Power	Total Q	Input Power	Total Q	Input Power
2.0 + 2.5 + 2.5 + 5.0 + 6.0	22	14.11	1.79	11.97	1.91	11.26	1.94	9.83	2.02	11.28	2.05	12.24	2.07
	25	13.25	2.28	11.87	2.35	11.41	2.37	10.50	2.42	11.51	2.43	12.19	2.44
	29	12.57	2.79	11.85	2.81	11.61	2.82	11.13	2.84	11.71	2.84	12.09	2.85
	32	11.75	3.07	11.57	3.07	11.52	3.07	11.40	3.07	11.77	3.07	12.01	3.08
	35	11.33	3.26	11.41	3.25	11.44	3.24	11.50	3.23	11.75	3.23	11.91	3.23
	40	10.92	3.38	11.10	3.37	11.17	3.36	11.29	3.35	11.54	3.34	11.71	3.34
	43	10.82	3.36	10.88	3.34	10.90	3.34	10.94	3.32	11.32	3.32	11.57	3.32
	46	10.88	3.23	10.66	3.23	10.58	3.23	10.43	3.23	11.03	3.24	11.43	3.24
2.0 + 2.5 + 3.5 + 3.5 + 3.5	22	14.11	1.86	11.97	1.97	11.26	2.01	9.83	2.09	11.28	2.12	12.24	2.14
	25	13.25	2.36	11.87	2.43	11.41	2.45	10.50	2.50	11.51	2.52	12.19	2.53
	29	12.57	2.88	11.85	2.91	11.61	2.92	11.13	2.93	11.71	2.94	12.09	2.94
	32	11.75	3.17	11.57	3.17	11.52	3.17	11.40	3.17	11.77	3.18	12.01	3.18
	35	11.33	3.38	11.41	3.36	11.44	3.35	11.50	3.34	11.75	3.34	11.91	3.34
	40	10.92	3.50	11.10	3.48	11.17	3.48	11.29	3.46	11.54	3.46	11.71	3.45
	43	10.82	3.47	10.88	3.45	10.90	3.45	10.94	3.44	11.32	3.44	11.57	3.44
	46	10.88	3.34	10.66	3.34	10.58	3.34	10.43	3.34	11.03	3.35	11.43	3.35
2.0 + 2.5 + 3.5 + 3.5 + 4.2	22	14.11	1.86	11.97	1.97	11.26	2.01	9.83	2.09	11.28	2.12	12.24	2.14
	25	13.25	2.36	11.87	2.43	11.41	2.45	10.50	2.50	11.51	2.52	12.19	2.53
	29	12.57	2.88	11.85	2.91	11.61	2.92	11.13	2.93	11.71	2.94	12.09	2.94
	32	11.75	3.17	11.57	3.17	11.52	3.17	11.40	3.17	11.77	3.18	12.01	3.18
	35	11.33	3.38	11.41	3.36	11.44	3.35	11.50	3.34	11.75	3.34	11.91	3.34
	40	10.92	3.50	11.10	3.48	11.17	3.48	11.29	3.46	11.54	3.46	11.71	3.45
	43	10.82	3.47	10.88	3.45	10.90	3.45	10.94	3.44	11.32	3.44	11.57	3.44
	46	10.88	3.34	10.66	3.34	10.58	3.34	10.43	3.34	11.03	3.35	11.43	3.35
2.0 + 2.5 + 3.5 + 3.5 + 5.0	22	14.11	1.83	11.97	1.94	11.26	1.98	9.83	2.05	11.28	2.09	12.24	2.11
	25	13.25	2.32	11.87	2.39	11.41	2.42	10.50	2.46	11.51	2.48	12.19	2.49
	29	12.57	2.84	11.85	2.86	11.61	2.87	11.13	2.89	11.71	2.89	12.09	2.90
	32	11.75	3.12	11.57	3.12	11.52	3.12	11.40	3.12	11.77	3.13	12.01	3.13
	35	11.33	3.32	11.41	3.31	11.44	3.30	11.50	3.29	11.75	3.29	11.91	3.29
	40	10.92	3.45	11.10	3.43	11.17	3.42	11.29	3.41	11.54	3.41	11.71	3.40
	43	10.82	3.42	10.88	3.40	10.90	3.40	10.94	3.39	11.32	3.39	11.57	3.39
	46	10.88	3.29	10.66	3.29	10.58	3.29	10.43	3.29	11.03	3.30	11.43	3.30
2.0 + 2.5 + 3.5 + 3.5 + 6.0	22	14.11	1.83	11.97	1.94	11.26	1.98	9.83	2.05	11.28	2.09	12.24	2.11
	25	13.25	2.32	11.87	2.39	11.41	2.42	10.50	2.46	11.51	2.48	12.19	2.49
	29	12.57	2.84	11.85	2.86	11.61	2.87	11.13	2.89	11.71	2.89	12.09	2.90
	32	11.75	3.12	11.57	3.12	11.52	3.12	11.40	3.12	11.77	3.13	12.01	3.13
	35	11.33	3.32	11.41	3.31	11.44	3.30	11.50	3.29	11.75	3.29	11.91	3.29
	40	10.92	3.45	11.10	3.43	11.17	3.42	11.29	3.41	11.54	3.41	11.71	3.40
	43	10.82	3.42	10.88	3.40	10.90	3.40	10.94	3.39	11.32	3.39	11.57	3.39
	46	10.88	3.29	10.66	3.29	10.58	3.29	10.43	3.29	11.03	3.30	11.43	3.30

Combination (Capacity)	Outdoor Air Temp. °C DB	Indoor Air Temp. °C											
		27/16		27/17.5		27/18		27/19		27/22		27/24	
		Total Q	Input Power	Total Q	Input Power	Total Q	Input Power	Total Q	Input Power	Total Q	Input Power	Total Q	Input Power
2.0 + 2.5 + 3.5 + 4.2 + 4.2	22	14.11	1.86	11.97	1.98	11.26	2.01	9.83	2.09	11.28	2.12	12.24	2.14
	25	13.25	2.37	11.87	2.44	11.41	2.46	10.50	2.51	11.51	2.52	12.19	2.53
	29	12.57	2.89	11.85	2.92	11.61	2.92	11.13	2.94	11.71	2.95	12.09	2.95
	32	11.75	3.18	11.57	3.18	11.52	3.18	11.40	3.18	11.77	3.19	12.01	3.19
	35	11.33	3.39	11.41	3.37	11.44	3.36	11.50	3.35	11.75	3.35	11.91	3.35
	40	10.92	3.51	11.10	3.49	11.17	3.49	11.29	3.47	11.54	3.47	11.71	3.47
	43	10.82	3.48	10.88	3.47	10.90	3.46	10.94	3.45	11.32	3.45	11.57	3.45
	46	10.88	3.35	10.66	3.35	10.58	3.35	10.43	3.35	11.03	3.36	11.43	3.36
2.0 + 2.5 + 3.5 + 4.2 + 5.0	22	14.11	1.83	11.97	1.94	11.26	1.98	9.83	2.05	11.28	2.09	12.24	2.11
	25	13.25	2.32	11.87	2.39	11.41	2.42	10.50	2.46	11.51	2.48	12.19	2.49
	29	12.57	2.84	11.85	2.86	11.61	2.87	11.13	2.89	11.71	2.89	12.09	2.90
	32	11.75	3.12	11.57	3.12	11.52	3.12	11.40	3.12	11.77	3.13	12.01	3.13
	35	11.33	3.32	11.41	3.31	11.44	3.30	11.50	3.29	11.75	3.29	11.91	3.29
	40	10.92	3.45	11.10	3.43	11.17	3.42	11.29	3.41	11.54	3.41	11.71	3.40
	43	10.82	3.42	10.88	3.40	10.90	3.40	10.94	3.39	11.32	3.39	11.57	3.39
	46	10.88	3.29	10.66	3.29	10.58	3.29	10.43	3.29	11.03	3.30	11.43	3.30
2.0 + 2.5 + 3.5 + 4.2 + 6.0	22	14.11	1.83	11.97	1.94	11.26	1.98	9.83	2.05	11.28	2.09	12.24	2.11
	25	13.25	2.32	11.87	2.39	11.41	2.42	10.50	2.46	11.51	2.48	12.19	2.49
	29	12.57	2.84	11.85	2.86	11.61	2.87	11.13	2.89	11.71	2.89	12.09	2.90
	32	11.75	3.12	11.57	3.12	11.52	3.12	11.40	3.12	11.77	3.13	12.01	3.13
	35	11.33	3.32	11.41	3.31	11.44	3.30	11.50	3.29	11.75	3.29	11.91	3.29
	40	10.92	3.45	11.10	3.43	11.17	3.42	11.29	3.41	11.54	3.41	11.71	3.40
	43	10.82	3.42	10.88	3.40	10.90	3.40	10.94	3.39	11.32	3.39	11.57	3.39
	46	10.88	3.29	10.66	3.29	10.58	3.29	10.43	3.29	11.03	3.30	11.43	3.30
2.0 + 2.5 + 3.5 + 5.0 + 5.0	22	14.11	1.80	11.97	1.91	11.26	1.95	9.83	2.02	11.28	2.05	12.24	2.07
	25	13.25	2.29	11.87	2.36	11.41	2.38	10.50	2.43	11.51	2.44	12.19	2.45
	29	12.57	2.79	11.85	2.82	11.61	2.83	11.13	2.85	11.71	2.85	12.09	2.85
	32	11.75	3.08	11.57	3.08	11.52	3.08	11.40	3.08	11.77	3.08	12.01	3.09
	35	11.33	3.27	11.41	3.26	11.44	3.25	11.50	3.24	11.75	3.24	11.91	3.24
	40	10.92	3.39	11.10	3.38	11.17	3.37	11.29	3.36	11.54	3.35	11.71	3.35
	43	10.82	3.37	10.88	3.35	10.90	3.35	10.94	3.33	11.32	3.33	11.57	3.33
	46	10.88	3.24	10.66	3.24	10.58	3.24	10.43	3.24	11.03	3.25	11.43	3.25
2.0 + 2.5 + 4.2 + 4.2 + 4.2	22	14.11	1.86	11.97	1.98	11.26	2.01	9.83	2.09	11.28	2.12	12.24	2.14
	25	13.25	2.37	11.87	2.44	11.41	2.46	10.50	2.51	11.51	2.52	12.19	2.53
	29	12.57	2.89	11.85	2.92	11.61	2.92	11.13	2.94	11.71	2.95	12.09	2.95
	32	11.75	3.18	11.57	3.18	11.52	3.18	11.40	3.18	11.77	3.19	12.01	3.19
	35	11.33	3.39	11.41	3.37	11.44	3.36	11.50	3.35	11.75	3.35	11.91	3.35
	40	10.92	3.51	11.10	3.49	11.17	3.49	11.29	3.47	11.54	3.47	11.71	3.47
	43	10.82	3.48	10.88	3.47	10.90	3.46	10.94	3.45	11.32	3.45	11.57	3.45
	46	10.88	3.35	10.66	3.35	10.58	3.35	10.43	3.35	11.03	3.36	11.43	3.36

Combination (Capacity)	Outdoor Air Temp. °C DB	Indoor Air Temp. °C											
		27/16		27/17.5		27/18		27/19		27/22		27/24	
		Total Q	Input Power	Total Q	Input Power	Total Q	Input Power	Total Q	Input Power	Total Q	Input Power	Total Q	Input Power
2.0 + 2.5 + 4.2 + 4.2 + 5.0	22	14.11	1.83	11.97	1.94	11.26	1.98	9.83	2.05	11.28	2.09	12.24	2.11
	25	13.25	2.32	11.87	2.39	11.41	2.42	10.50	2.46	11.51	2.48	12.19	2.49
	29	12.57	2.84	11.85	2.86	11.61	2.87	11.13	2.89	11.71	2.89	12.09	2.90
	32	11.75	3.12	11.57	3.12	11.52	3.12	11.40	3.12	11.77	3.13	12.01	3.13
	35	11.33	3.32	11.41	3.31	11.44	3.30	11.50	3.29	11.75	3.29	11.91	3.29
	40	10.92	3.45	11.10	3.43	11.17	3.42	11.29	3.41	11.54	3.41	11.71	3.40
	43	10.82	3.42	10.88	3.40	10.90	3.40	10.94	3.39	11.32	3.39	11.57	3.39
	46	10.88	3.29	10.66	3.29	10.58	3.29	10.43	3.29	11.03	3.30	11.43	3.30
2.0 + 3.5 + 3.5 + 3.5 + 3.5	22	14.11	1.86	11.97	1.98	11.26	2.01	9.83	2.09	11.28	2.12	12.24	2.14
	25	13.25	2.37	11.87	2.44	11.41	2.46	10.50	2.51	11.51	2.52	12.19	2.53
	29	12.57	2.89	11.85	2.92	11.61	2.92	11.13	2.94	11.71	2.95	12.09	2.95
	32	11.75	3.18	11.57	3.18	11.52	3.18	11.40	3.18	11.77	3.19	12.01	3.19
	35	11.33	3.39	11.41	3.37	11.44	3.36	11.50	3.35	11.75	3.35	11.91	3.35
	40	10.92	3.51	11.10	3.49	11.17	3.49	11.29	3.47	11.54	3.47	11.71	3.47
	43	10.82	3.48	10.88	3.47	10.90	3.46	10.94	3.45	11.32	3.45	11.57	3.45
	46	10.88	3.35	10.66	3.35	10.58	3.35	10.43	3.35	11.03	3.36	11.43	3.36
2.0 + 3.5 + 3.5 + 3.5 + 4.2	22	14.11	1.86	11.97	1.98	11.26	2.01	9.83	2.09	11.28	2.12	12.24	2.14
	25	13.25	2.37	11.87	2.44	11.41	2.46	10.50	2.51	11.51	2.52	12.19	2.53
	29	12.57	2.89	11.85	2.92	11.61	2.92	11.13	2.94	11.71	2.95	12.09	2.95
	32	11.75	3.18	11.57	3.18	11.52	3.18	11.40	3.18	11.77	3.19	12.01	3.19
	35	11.33	3.39	11.41	3.37	11.44	3.36	11.50	3.35	11.75	3.35	11.91	3.35
	40	10.92	3.51	11.10	3.49	11.17	3.49	11.29	3.47	11.54	3.47	11.71	3.47
	43	10.82	3.48	10.88	3.47	10.90	3.46	10.94	3.45	11.32	3.45	11.57	3.45
	46	10.88	3.35	10.66	3.35	10.58	3.35	10.43	3.35	11.03	3.36	11.43	3.36
2.0 + 3.5 + 3.5 + 3.5 + 5.0	22	14.11	1.83	11.97	1.94	11.26	1.98	9.83	2.05	11.28	2.09	12.24	2.11
	25	13.25	2.32	11.87	2.39	11.41	2.42	10.50	2.46	11.51	2.48	12.19	2.49
	29	12.57	2.84	11.85	2.86	11.61	2.87	11.13	2.89	11.71	2.89	12.09	2.90
	32	11.75	3.12	11.57	3.12	11.52	3.12	11.40	3.12	11.77	3.13	12.01	3.13
	35	11.33	3.32	11.41	3.31	11.44	3.30	11.50	3.29	11.75	3.29	11.91	3.29
	40	10.92	3.45	11.10	3.43	11.17	3.42	11.29	3.41	11.54	3.41	11.71	3.40
	43	10.82	3.42	10.88	3.40	10.90	3.40	10.94	3.39	11.32	3.39	11.57	3.39
	46	10.88	3.29	10.66	3.29	10.58	3.29	10.43	3.29	11.03	3.30	11.43	3.30
2.0 + 3.5 + 3.5 + 4.2 + 4.2	22	14.11	1.86	11.97	1.98	11.26	2.01	9.83	2.09	11.28	2.12	12.24	2.14
	25	13.25	2.37	11.87	2.44	11.41	2.46	10.50	2.51	11.51	2.52	12.19	2.53
	29	12.57	2.89	11.85	2.92	11.61	2.92	11.13	2.94	11.71	2.95	12.09	2.95
	32	11.75	3.18	11.57	3.18	11.52	3.18	11.40	3.18	11.77	3.19	12.01	3.19
	35	11.33	3.39	11.41	3.37	11.44	3.36	11.50	3.35	11.75	3.35	11.91	3.35
	40	10.92	3.51	11.10	3.49	11.17	3.49	11.29	3.47	11.54	3.47	11.71	3.47
	43	10.82	3.48	10.88	3.47	10.90	3.46	10.94	3.45	11.32	3.45	11.57	3.45
	46	10.88	3.35	10.66	3.35	10.58	3.35	10.43	3.35	11.03	3.36	11.43	3.36

Combination (Capacity)	Outdoor Air Temp. °C DB	Indoor Air Temp. °C											
		27/16		27/17.5		27/18		27/19		27/22		27/24	
		Total Q	Input Power	Total Q	Input Power	Total Q	Input Power	Total Q	Input Power	Total Q	Input Power	Total Q	Input Power
2.0 + 3.5 + 3.5 + 4.2 + 5.0	22	14.11	1.83	11.97	1.94	11.26	1.98	9.83	2.05	11.28	2.09	12.24	2.11
	25	13.25	2.32	11.87	2.39	11.41	2.42	10.50	2.46	11.51	2.48	12.19	2.49
	29	12.57	2.84	11.85	2.86	11.61	2.87	11.13	2.89	11.71	2.89	12.09	2.90
	32	11.75	3.12	11.57	3.12	11.52	3.12	11.40	3.12	11.77	3.13	12.01	3.13
	35	11.33	3.32	11.41	3.31	11.44	3.30	11.50	3.29	11.75	3.29	11.91	3.29
	40	10.92	3.45	11.10	3.43	11.17	3.42	11.29	3.41	11.54	3.41	11.71	3.40
	43	10.82	3.42	10.88	3.40	10.90	3.40	10.94	3.39	11.32	3.39	11.57	3.39
	46	10.88	3.29	10.66	3.29	10.58	3.29	10.43	3.29	11.03	3.30	11.43	3.30
2.0 + 3.5 + 4.2 + 4.2 + 4.2	22	14.11	1.86	11.97	1.98	11.26	2.01	9.83	2.09	11.28	2.12	12.24	2.14
	25	13.25	2.37	11.87	2.44	11.41	2.46	10.50	2.51	11.51	2.52	12.19	2.53
	29	12.57	2.89	11.85	2.92	11.61	2.92	11.13	2.94	11.71	2.95	12.09	2.95
	32	11.75	3.18	11.57	3.18	11.52	3.18	11.40	3.18	11.77	3.19	12.01	3.19
	35	11.33	3.39	11.41	3.37	11.44	3.36	11.50	3.35	11.75	3.35	11.91	3.35
	40	10.92	3.51	11.10	3.49	11.17	3.49	11.29	3.47	11.54	3.47	11.71	3.47
	43	10.82	3.48	10.88	3.47	10.90	3.46	10.94	3.45	11.32	3.45	11.57	3.45
	46	10.88	3.35	10.66	3.35	10.58	3.35	10.43	3.35	11.03	3.36	11.43	3.36
2.5 + 2.5 + 2.5 + 2.5 + 2.5	22	14.11	1.94	11.97	2.06	11.26	2.10	9.83	2.18	11.28	2.21	12.24	2.23
	25	13.25	2.47	11.87	2.54	11.41	2.56	10.50	2.61	11.51	2.63	12.19	2.64
	29	12.57	3.01	11.85	3.04	11.61	3.05	11.13	3.07	11.71	3.07	12.09	3.07
	32	11.75	3.31	11.57	3.31	11.52	3.31	11.40	3.31	11.77	3.32	12.01	3.32
	35	11.33	3.53	11.41	3.51	11.44	3.50	11.50	3.49	11.75	3.49	11.91	3.49
	40	10.92	3.66	11.10	3.64	11.17	3.63	11.29	3.62	11.54	3.61	11.71	3.61
	43	10.82	3.63	10.88	3.61	10.90	3.60	10.94	3.59	11.32	3.59	11.57	3.59
	46	10.88	3.49	10.66	3.49	10.58	3.49	10.43	3.49	11.03	3.50	11.43	3.50
2.5 + 2.5 + 2.5 + 2.5 + 3.5	22	14.11	1.89	11.97	2.01	11.26	2.05	9.83	2.13	11.28	2.16	12.24	2.18
	25	13.25	2.41	11.87	2.48	11.41	2.50	10.50	2.55	11.51	2.57	12.19	2.58
	29	12.57	2.94	11.85	2.97	11.61	2.98	11.13	3.00	11.71	3.00	12.09	3.00
	32	11.75	3.24	11.57	3.24	11.52	3.24	11.40	3.24	11.77	3.24	12.01	3.25
	35	11.33	3.45	11.41	3.43	11.44	3.42	11.50	3.41	11.75	3.41	11.91	3.41
	40	10.92	3.57	11.10	3.55	11.17	3.55	11.29	3.54	11.54	3.53	11.71	3.53
	43	10.82	3.55	10.88	3.53	10.90	3.52	10.94	3.51	11.32	3.51	11.57	3.51
	46	10.88	3.41	10.66	3.41	10.58	3.41	10.43	3.41	11.03	3.42	11.43	3.42
2.5 + 2.5 + 2.5 + 2.5 + 4.2	22	14.11	1.89	11.97	2.01	11.26	2.05	9.83	2.13	11.28	2.16	12.24	2.18
	25	13.25	2.41	11.87	2.48	11.41	2.50	10.50	2.55	11.51	2.57	12.19	2.58
	29	12.57	2.94	11.85	2.97	11.61	2.98	11.13	3.00	11.71	3.00	12.09	3.00
	32	11.75	3.24	11.57	3.24	11.52	3.24	11.40	3.24	11.77	3.24	12.01	3.25
	35	11.33	3.45	11.41	3.43	11.44	3.42	11.50	3.41	11.75	3.41	11.91	3.41
	40	10.92	3.57	11.10	3.55	11.17	3.55	11.29	3.54	11.54	3.53	11.71	3.53
	43	10.82	3.55	10.88	3.53	10.90	3.52	10.94	3.51	11.32	3.51	11.57	3.51
	46	10.88	3.41	10.66	3.41	10.58	3.41	10.43	3.41	11.03	3.42	11.43	3.42



Combination (Capacity)	Outdoor Air Temp. °C DB	Indoor Air Temp. °C											
		27/16		27/17.5		27/18		27/19		27/22		27/24	
		Total Q	Input Power	Total Q	Input Power	Total Q	Input Power	Total Q	Input Power	Total Q	Input Power	Total Q	Input Power
2.5 + 2.5 + 2.5 + 2.5 + 5.0	22	14.11	1.82	11.97	1.94	11.26	1.97	9.83	2.05	11.28	2.08	12.24	2.10
	25	13.25	2.32	11.87	2.39	11.41	2.41	10.50	2.46	11.51	2.47	12.19	2.48
	29	12.57	2.83	11.85	2.85	11.61	2.86	11.13	2.88	11.71	2.89	12.09	2.89
	32	11.75	3.12	11.57	3.12	11.52	3.12	11.40	3.12	11.77	3.12	12.01	3.12
	35	11.33	3.31	11.41	3.30	11.44	3.29	11.50	3.28	11.75	3.28	11.91	3.28
	40	10.92	3.44	11.10	3.42	11.17	3.41	11.29	3.40	11.54	3.40	11.71	3.39
	43	10.82	3.41	10.88	3.39	10.90	3.39	10.94	3.38	11.32	3.38	11.57	3.38
	46	10.88	3.28	10.66	3.28	10.58	3.28	10.43	3.28	11.03	3.29	11.43	3.29
2.5 + 2.5 + 2.5 + 2.5 + 6.0	22	14.11	1.82	11.97	1.94	11.26	1.97	9.83	2.05	11.28	2.08	12.24	2.10
	25	13.25	2.32	11.87	2.39	11.41	2.41	10.50	2.46	11.51	2.47	12.19	2.48
	29	12.57	2.83	11.85	2.85	11.61	2.86	11.13	2.88	11.71	2.89	12.09	2.89
	32	11.75	3.12	11.57	3.12	11.52	3.12	11.40	3.12	11.77	3.12	12.01	3.12
	35	11.33	3.31	11.41	3.30	11.44	3.29	11.50	3.28	11.75	3.28	11.91	3.28
	40	10.92	3.44	11.10	3.42	11.17	3.41	11.29	3.40	11.54	3.40	11.71	3.39
	43	10.82	3.41	10.88	3.39	10.90	3.39	10.94	3.38	11.32	3.38	11.57	3.38
	46	10.88	3.28	10.66	3.28	10.58	3.28	10.43	3.28	11.03	3.29	11.43	3.29
2.5 + 2.5 + 2.5 + 2.5 + 7.1	22	14.11	1.82	11.97	1.94	11.26	1.97	9.83	2.05	11.28	2.08	12.24	2.10
	25	13.25	2.32	11.87	2.39	11.41	2.41	10.50	2.46	11.51	2.47	12.19	2.48
	29	12.57	2.83	11.85	2.85	11.61	2.86	11.13	2.88	11.71	2.89	12.09	2.89
	32	11.75	3.12	11.57	3.12	11.52	3.12	11.40	3.12	11.77	3.12	12.01	3.12
	35	11.33	3.31	11.41	3.30	11.44	3.29	11.50	3.28	11.75	3.28	11.91	3.28
	40	10.92	3.44	11.10	3.42	11.17	3.41	11.29	3.40	11.54	3.40	11.71	3.39
	43	10.82	3.41	10.88	3.39	10.90	3.39	10.94	3.38	11.32	3.38	11.57	3.38
	46	10.88	3.28	10.66	3.28	10.58	3.28	10.43	3.28	11.03	3.29	11.43	3.29
2.5 + 2.5 + 2.5 + 3.5 + 3.5	22	14.11	1.90	11.97	2.02	11.26	2.06	9.83	2.14	11.28	2.17	12.24	2.19
	25	13.25	2.42	11.87	2.49	11.41	2.51	10.50	2.56	11.51	2.58	12.19	2.59
	29	12.57	2.95	11.85	2.98	11.61	2.99	11.13	3.00	11.71	3.01	12.09	3.01
	32	11.75	3.25	11.57	3.25	11.52	3.25	11.40	3.25	11.77	3.25	12.01	3.26
	35	11.33	3.46	11.41	3.44	11.44	3.43	11.50	3.42	11.75	3.42	11.91	3.42
	40	10.92	3.58	11.10	3.56	11.17	3.56	11.29	3.55	11.54	3.54	11.71	3.54
	43	10.82	3.56	10.88	3.54	10.90	3.53	10.94	3.52	11.32	3.52	11.57	3.52
	46	10.88	3.42	10.66	3.42	10.58	3.42	10.43	3.42	11.03	3.43	11.43	3.43
2.5 + 2.5 + 2.5 + 3.5 + 4.2	22	14.11	1.90	11.97	2.02	11.26	2.06	9.83	2.14	11.28	2.17	12.24	2.19
	25	13.25	2.42	11.87	2.49	11.41	2.51	10.50	2.56	11.51	2.58	12.19	2.59
	29	12.57	2.95	11.85	2.98	11.61	2.99	11.13	3.00	11.71	3.01	12.09	3.01
	32	11.75	3.25	11.57	3.25	11.52	3.25	11.40	3.25	11.77	3.25	12.01	3.26
	35	11.33	3.46	11.41	3.44	11.44	3.43	11.50	3.42	11.75	3.42	11.91	3.42
	40	10.92	3.58	11.10	3.56	11.17	3.56	11.29	3.55	11.54	3.54	11.71	3.54
	43	10.82	3.56	10.88	3.54	10.90	3.53	10.94	3.52	11.32	3.52	11.57	3.52
	46	10.88	3.42	10.66	3.42	10.58	3.42	10.43	3.42	11.03	3.43	11.43	3.43

Combination (Capacity)	Outdoor Air Temp. °C DB	Indoor Air Temp. °C											
		27/16		27/17.5		27/18		27/19		27/22		27/24	
		Total Q	Input Power	Total Q	Input Power	Total Q	Input Power	Total Q	Input Power	Total Q	Input Power	Total Q	Input Power
2.5 + 2.5 + 2.5 + 3.5 + 5.0	22	14.11	1.82	11.97	1.94	11.26	1.97	9.83	2.05	11.28	2.08	12.24	2.10
	25	13.25	2.32	11.87	2.39	11.41	2.41	10.50	2.46	11.51	2.47	12.19	2.48
	29	12.57	2.83	11.85	2.85	11.61	2.86	11.13	2.88	11.71	2.89	12.09	2.89
	32	11.75	3.12	11.57	3.12	11.52	3.12	11.40	3.12	11.77	3.12	12.01	3.12
	35	11.33	3.31	11.41	3.30	11.44	3.29	11.50	3.28	11.75	3.28	11.91	3.28
	40	10.92	3.44	11.10	3.42	11.17	3.41	11.29	3.40	11.54	3.40	11.71	3.39
	43	10.82	3.41	10.88	3.39	10.90	3.39	10.94	3.38	11.32	3.38	11.57	3.38
	46	10.88	3.28	10.66	3.28	10.58	3.28	10.43	3.28	11.03	3.29	11.43	3.29
2.5 + 2.5 + 2.5 + 3.5 + 6.0	22	14.11	1.82	11.97	1.94	11.26	1.97	9.83	2.05	11.28	2.08	12.24	2.10
	25	13.25	2.32	11.87	2.39	11.41	2.41	10.50	2.46	11.51	2.47	12.19	2.48
	29	12.57	2.83	11.85	2.85	11.61	2.86	11.13	2.88	11.71	2.89	12.09	2.89
	32	11.75	3.12	11.57	3.12	11.52	3.12	11.40	3.12	11.77	3.12	12.01	3.12
	35	11.33	3.31	11.41	3.30	11.44	3.29	11.50	3.28	11.75	3.28	11.91	3.28
	40	10.92	3.44	11.10	3.42	11.17	3.41	11.29	3.40	11.54	3.40	11.71	3.39
	43	10.82	3.41	10.88	3.39	10.90	3.39	10.94	3.38	11.32	3.38	11.57	3.38
	46	10.88	3.28	10.66	3.28	10.58	3.28	10.43	3.28	11.03	3.29	11.43	3.29
2.5 + 2.5 + 2.5 + 3.5 + 7.1	22	14.11	1.83	11.97	1.94	11.26	1.98	9.83	2.05	11.28	2.09	12.24	2.11
	25	13.25	2.32	11.87	2.39	11.41	2.42	10.50	2.46	11.51	2.48	12.19	2.49
	29	12.57	2.84	11.85	2.86	11.61	2.87	11.13	2.89	11.71	2.89	12.09	2.90
	32	11.75	3.12	11.57	3.12	11.52	3.12	11.40	3.12	11.77	3.13	12.01	3.13
	35	11.33	3.32	11.41	3.31	11.44	3.30	11.50	3.29	11.75	3.29	11.91	3.29
	40	10.92	3.45	11.10	3.43	11.17	3.42	11.29	3.41	11.54	3.41	11.71	3.40
	43	10.82	3.42	10.88	3.40	10.90	3.40	10.94	3.39	11.32	3.39	11.57	3.39
	46	10.88	3.29	10.66	3.29	10.58	3.29	10.43	3.29	11.03	3.30	11.43	3.30
2.5 + 2.5 + 2.5 + 4.2 + 4.2	22	14.11	1.90	11.97	2.02	11.26	2.06	9.83	2.14	11.28	2.17	12.24	2.19
	25	13.25	2.42	11.87	2.49	11.41	2.51	10.50	2.56	11.51	2.58	12.19	2.59
	29	12.57	2.95	11.85	2.98	11.61	2.99	11.13	3.00	11.71	3.01	12.09	3.01
	32	11.75	3.25	11.57	3.25	11.52	3.25	11.40	3.25	11.77	3.25	12.01	3.26
	35	11.33	3.46	11.41	3.44	11.44	3.43	11.50	3.42	11.75	3.42	11.91	3.42
	40	10.92	3.58	11.10	3.56	11.17	3.56	11.29	3.55	11.54	3.54	11.71	3.54
	43	10.82	3.56	10.88	3.54	10.90	3.53	10.94	3.52	11.32	3.52	11.57	3.52
	46	10.88	3.42	10.66	3.42	10.58	3.42	10.43	3.42	11.03	3.43	11.43	3.43
2.5 + 2.5 + 2.5 + 4.2 + 5.0	22	14.11	1.82	11.97	1.94	11.26	1.97	9.83	2.05	11.28	2.08	12.24	2.10
	25	13.25	2.32	11.87	2.39	11.41	2.41	10.50	2.46	11.51	2.47	12.19	2.48
	29	12.57	2.83	11.85	2.85	11.61	2.86	11.13	2.88	11.71	2.89	12.09	2.89
	32	11.75	3.12	11.57	3.12	11.52	3.12	11.40	3.12	11.77	3.12	12.01	3.12
	35	11.33	3.31	11.41	3.30	11.44	3.29	11.50	3.28	11.75	3.28	11.91	3.28
	40	10.92	3.44	11.10	3.42	11.17	3.41	11.29	3.40	11.54	3.40	11.71	3.39
	43	10.82	3.41	10.88	3.39	10.90	3.39	10.94	3.38	11.32	3.38	11.57	3.38
	46	10.88	3.28	10.66	3.28	10.58	3.28	10.43	3.28	11.03	3.29	11.43	3.29

Combination (Capacity)	Outdoor Air Temp. °C DB	Indoor Air Temp. °C											
		27/16		27/17.5		27/18		27/19		27/22		27/24	
		Total Q	Input Power	Total Q	Input Power	Total Q	Input Power	Total Q	Input Power	Total Q	Input Power	Total Q	Input Power
2.5 + 2.5 + 2.5 + 4.2 + 6.0	22	14.11	1.82	11.97	1.94	11.26	1.97	9.83	2.05	11.28	2.08	12.24	2.10
	25	13.25	2.32	11.87	2.39	11.41	2.41	10.50	2.46	11.51	2.47	12.19	2.48
	29	12.57	2.83	11.85	2.85	11.61	2.86	11.13	2.88	11.71	2.89	12.09	2.89
	32	11.75	3.12	11.57	3.12	11.52	3.12	11.40	3.12	11.77	3.12	12.01	3.12
	35	11.33	3.31	11.41	3.30	11.44	3.29	11.50	3.28	11.75	3.28	11.91	3.28
	40	10.92	3.44	11.10	3.42	11.17	3.41	11.29	3.40	11.54	3.40	11.71	3.39
	43	10.82	3.41	10.88	3.39	10.90	3.39	10.94	3.38	11.32	3.38	11.57	3.38
	46	10.88	3.28	10.66	3.28	10.58	3.28	10.43	3.28	11.03	3.29	11.43	3.29
2.5 + 2.5 + 2.5 + 5.0 + 5.0	22	14.11	1.79	11.97	1.91	11.26	1.94	9.83	2.02	11.28	2.05	12.24	2.07
	25	13.25	2.28	11.87	2.35	11.41	2.37	10.50	2.42	11.51	2.43	12.19	2.44
	29	12.57	2.79	11.85	2.81	11.61	2.82	11.13	2.84	11.71	2.84	12.09	2.85
	32	11.75	3.07	11.57	3.07	11.52	3.07	11.40	3.07	11.77	3.07	12.01	3.08
	35	11.33	3.26	11.41	3.25	11.44	3.24	11.50	3.23	11.75	3.23	11.91	3.23
	40	10.92	3.38	11.10	3.37	11.17	3.36	11.29	3.35	11.54	3.34	11.71	3.34
	43	10.82	3.36	10.88	3.34	10.90	3.34	10.94	3.32	11.32	3.32	11.57	3.32
	46	10.88	3.23	10.66	3.23	10.58	3.23	10.43	3.23	11.03	3.24	11.43	3.24
2.5 + 2.5 + 3.5 + 3.5 + 3.5	22	14.11	1.86	11.97	1.97	11.26	2.01	9.83	2.09	11.28	2.12	12.24	2.14
	25	13.25	2.36	11.87	2.43	11.41	2.45	10.50	2.50	11.51	2.52	12.19	2.53
	29	12.57	2.88	11.85	2.91	11.61	2.92	11.13	2.93	11.71	2.94	12.09	2.94
	32	11.75	3.17	11.57	3.17	11.52	3.17	11.40	3.17	11.77	3.18	12.01	3.18
	35	11.33	3.38	11.41	3.36	11.44	3.35	11.50	3.34	11.75	3.34	11.91	3.34
	40	10.92	3.50	11.10	3.48	11.17	3.48	11.29	3.46	11.54	3.46	11.71	3.45
	43	10.82	3.47	10.88	3.45	10.90	3.45	10.94	3.44	11.32	3.44	11.57	3.44
	46	10.88	3.34	10.66	3.34	10.58	3.34	10.43	3.34	11.03	3.35	11.43	3.35
2.5 + 2.5 + 3.5 + 3.5 + 4.2	22	14.11	1.86	11.97	1.97	11.26	2.01	9.83	2.09	11.28	2.12	12.24	2.14
	25	13.25	2.36	11.87	2.43	11.41	2.45	10.50	2.50	11.51	2.52	12.19	2.53
	29	12.57	2.88	11.85	2.91	11.61	2.92	11.13	2.93	11.71	2.94	12.09	2.94
	32	11.75	3.17	11.57	3.17	11.52	3.17	11.40	3.17	11.77	3.18	12.01	3.18
	35	11.33	3.38	11.41	3.36	11.44	3.35	11.50	3.34	11.75	3.34	11.91	3.34
	40	10.92	3.50	11.10	3.48	11.17	3.48	11.29	3.46	11.54	3.46	11.71	3.45
	43	10.82	3.47	10.88	3.45	10.90	3.45	10.94	3.44	11.32	3.44	11.57	3.44
	46	10.88	3.34	10.66	3.34	10.58	3.34	10.43	3.34	11.03	3.35	11.43	3.35
2.5 + 2.5 + 3.5 + 3.5 + 5.0	22	14.11	1.83	11.97	1.94	11.26	1.98	9.83	2.05	11.28	2.09	12.24	2.11
	25	13.25	2.32	11.87	2.39	11.41	2.42	10.50	2.46	11.51	2.48	12.19	2.49
	29	12.57	2.84	11.85	2.86	11.61	2.87	11.13	2.89	11.71	2.89	12.09	2.90
	32	11.75	3.12	11.57	3.12	11.52	3.12	11.40	3.12	11.77	3.13	12.01	3.13
	35	11.33	3.32	11.41	3.31	11.44	3.30	11.50	3.29	11.75	3.29	11.91	3.29
	40	10.92	3.45	11.10	3.43	11.17	3.42	11.29	3.41	11.54	3.41	11.71	3.40
	43	10.82	3.42	10.88	3.40	10.90	3.40	10.94	3.39	11.32	3.39	11.57	3.39
	46	10.88	3.29	10.66	3.29	10.58	3.29	10.43	3.29	11.03	3.30	11.43	3.30

Combination (Capacity)	Outdoor Air Temp. °C DB	Indoor Air Temp. °C											
		27/16		27/17.5		27/18		27/19		27/22		27/24	
		Total Q	Input Power	Total Q	Input Power	Total Q	Input Power	Total Q	Input Power	Total Q	Input Power	Total Q	Input Power
2.5 + 2.5 + 3.5 + 3.5 + 6.0	22	14.11	1.83	11.97	1.94	11.26	1.98	9.83	2.05	11.28	2.09	12.24	2.11
	25	13.25	2.32	11.87	2.39	11.41	2.42	10.50	2.46	11.51	2.48	12.19	2.49
	29	12.57	2.84	11.85	2.86	11.61	2.87	11.13	2.89	11.71	2.89	12.09	2.90
	32	11.75	3.12	11.57	3.12	11.52	3.12	11.40	3.12	11.77	3.13	12.01	3.13
	35	11.33	3.32	11.41	3.31	11.44	3.30	11.50	3.29	11.75	3.29	11.91	3.29
	40	10.92	3.45	11.10	3.43	11.17	3.42	11.29	3.41	11.54	3.41	11.71	3.40
	43	10.82	3.42	10.88	3.40	10.90	3.40	10.94	3.39	11.32	3.39	11.57	3.39
	46	10.88	3.29	10.66	3.29	10.58	3.29	10.43	3.29	11.03	3.30	11.43	3.30
2.5 + 2.5 + 3.5 + 4.2 + 4.2	22	14.11	1.86	11.97	1.98	11.26	2.01	9.83	2.09	11.28	2.12	12.24	2.14
	25	13.25	2.37	11.87	2.44	11.41	2.46	10.50	2.51	11.51	2.52	12.19	2.53
	29	12.57	2.89	11.85	2.92	11.61	2.92	11.13	2.94	11.71	2.95	12.09	2.95
	32	11.75	3.18	11.57	3.18	11.52	3.18	11.40	3.18	11.77	3.19	12.01	3.19
	35	11.33	3.39	11.41	3.37	11.44	3.36	11.50	3.35	11.75	3.35	11.91	3.35
	40	10.92	3.51	11.10	3.49	11.17	3.49	11.29	3.47	11.54	3.47	11.71	3.47
	43	10.82	3.48	10.88	3.47	10.90	3.46	10.94	3.45	11.32	3.45	11.57	3.45
	46	10.88	3.35	10.66	3.35	10.58	3.35	10.43	3.35	11.03	3.36	11.43	3.36
2.5 + 2.5 + 3.5 + 4.2 + 5.0	22	14.11	1.83	11.97	1.94	11.26	1.98	9.83	2.05	11.28	2.09	12.24	2.11
	25	13.25	2.32	11.87	2.39	11.41	2.42	10.50	2.46	11.51	2.48	12.19	2.49
	29	12.57	2.84	11.85	2.86	11.61	2.87	11.13	2.89	11.71	2.89	12.09	2.90
	32	11.75	3.12	11.57	3.12	11.52	3.12	11.40	3.12	11.77	3.13	12.01	3.13
	35	11.33	3.32	11.41	3.31	11.44	3.30	11.50	3.29	11.75	3.29	11.91	3.29
	40	10.92	3.45	11.10	3.43	11.17	3.42	11.29	3.41	11.54	3.41	11.71	3.40
	43	10.82	3.42	10.88	3.40	10.90	3.40	10.94	3.39	11.32	3.39	11.57	3.39
	46	10.88	3.29	10.66	3.29	10.58	3.29	10.43	3.29	11.03	3.30	11.43	3.30
2.5 + 2.5 + 4.2 + 4.2 + 4.2	22	14.11	1.86	11.97	1.98	11.26	2.01	9.83	2.09	11.28	2.12	12.24	2.14
	25	13.25	2.37	11.87	2.44	11.41	2.46	10.50	2.51	11.51	2.52	12.19	2.53
	29	12.57	2.89	11.85	2.92	11.61	2.92	11.13	2.94	11.71	2.95	12.09	2.95
	32	11.75	3.18	11.57	3.18	11.52	3.18	11.40	3.18	11.77	3.19	12.01	3.19
	35	11.33	3.39	11.41	3.37	11.44	3.36	11.50	3.35	11.75	3.35	11.91	3.35
	40	10.92	3.51	11.10	3.49	11.17	3.49	11.29	3.47	11.54	3.47	11.71	3.47
	43	10.82	3.48	10.88	3.47	10.90	3.46	10.94	3.45	11.32	3.45	11.57	3.45
	46	10.88	3.35	10.66	3.35	10.58	3.35	10.43	3.35	11.03	3.36	11.43	3.36
2.5 + 3.5 + 3.5 + 3.5 + 3.5	22	14.11	1.86	11.97	1.98	11.26	2.01	9.83	2.09	11.28	2.12	12.24	2.14
	25	13.25	2.37	11.87	2.44	11.41	2.46	10.50	2.51	11.51	2.52	12.19	2.53
	29	12.57	2.89	11.85	2.92	11.61	2.92	11.13	2.94	11.71	2.95	12.09	2.95
	32	11.75	3.18	11.57	3.18	11.52	3.18	11.40	3.18	11.77	3.19	12.01	3.19
	35	11.33	3.39	11.41	3.37	11.44	3.36	11.50	3.35	11.75	3.35	11.91	3.35
	40	10.92	3.51	11.10	3.49	11.17	3.49	11.29	3.47	11.54	3.47	11.71	3.47
	43	10.82	3.48	10.88	3.47	10.90	3.46	10.94	3.45	11.32	3.45	11.57	3.45
	46	10.88	3.35	10.66	3.35	10.58	3.35	10.43	3.35	11.03	3.36	11.43	3.36

Combination (Capacity)	Outdoor Air Temp. °C DB	Indoor Air Temp. °C											
		27/16		27/17.5		27/18		27/19		27/22		27/24	
		Total Q	Input Power	Total Q	Input Power	Total Q	Input Power	Total Q	Input Power	Total Q	Input Power	Total Q	Input Power
2.5 + 3.5 + 3.5 + 3.5 + 4.2	22	14.11	1.86	11.97	1.98	11.26	2.01	9.83	2.09	11.28	2.12	12.24	2.14
	25	13.25	2.37	11.87	2.44	11.41	2.46	10.50	2.51	11.51	2.52	12.19	2.53
	29	12.57	2.89	11.85	2.92	11.61	2.92	11.13	2.94	11.71	2.95	12.09	2.95
	32	11.75	3.18	11.57	3.18	11.52	3.18	11.40	3.18	11.77	3.19	12.01	3.19
	35	11.33	3.39	11.41	3.37	11.44	3.36	11.50	3.35	11.75	3.35	11.91	3.35
	40	10.92	3.51	11.10	3.49	11.17	3.49	11.29	3.47	11.54	3.47	11.71	3.47
	43	10.82	3.48	10.88	3.47	10.90	3.46	10.94	3.45	11.32	3.45	11.57	3.45
	46	10.88	3.35	10.66	3.35	10.58	3.35	10.43	3.35	11.03	3.36	11.43	3.36
2.5 + 3.5 + 3.5 + 3.5 + 5.0	22	14.11	1.83	11.97	1.94	11.26	1.98	9.83	2.05	11.28	2.09	12.24	2.11
	25	13.25	2.32	11.87	2.39	11.41	2.42	10.50	2.46	11.51	2.48	12.19	2.49
	29	12.57	2.84	11.85	2.86	11.61	2.87	11.13	2.89	11.71	2.89	12.09	2.90
	32	11.75	3.12	11.57	3.12	11.52	3.12	11.40	3.12	11.77	3.13	12.01	3.13
	35	11.33	3.32	11.41	3.31	11.44	3.30	11.50	3.29	11.75	3.29	11.91	3.29
	40	10.92	3.45	11.10	3.43	11.17	3.42	11.29	3.41	11.54	3.41	11.71	3.40
	43	10.82	3.42	10.88	3.40	10.90	3.40	10.94	3.39	11.32	3.39	11.57	3.39
	46	10.88	3.29	10.66	3.29	10.58	3.29	10.43	3.29	11.03	3.30	11.43	3.30
2.5 + 3.5 + 3.5 + 4.2 + 4.2	22	14.11	1.86	11.97	1.98	11.26	2.01	9.83	2.09	11.28	2.12	12.24	2.14
	25	13.25	2.37	11.87	2.44	11.41	2.46	10.50	2.51	11.51	2.52	12.19	2.53
	29	12.57	2.89	11.85	2.92	11.61	2.92	11.13	2.94	11.71	2.95	12.09	2.95
	32	11.75	3.18	11.57	3.18	11.52	3.18	11.40	3.18	11.77	3.19	12.01	3.19
	35	11.33	3.39	11.41	3.37	11.44	3.36	11.50	3.35	11.75	3.35	11.91	3.35
	40	10.92	3.51	11.10	3.49	11.17	3.49	11.29	3.47	11.54	3.47	11.71	3.47
	43	10.82	3.48	10.88	3.47	10.90	3.46	10.94	3.45	11.32	3.45	11.57	3.45
	46	10.88	3.35	10.66	3.35	10.58	3.35	10.43	3.35	11.03	3.36	11.43	3.36
3.5 + 3.5 + 3.5 + 3.5 + 3.5	22	14.11	1.86	11.97	1.98	11.26	2.01	9.83	2.09	11.28	2.12	12.24	2.14
	25	13.25	2.37	11.87	2.44	11.41	2.46	10.50	2.51	11.51	2.52	12.19	2.53
	29	12.57	2.89	11.85	2.92	11.61	2.92	11.13	2.94	11.71	2.95	12.09	2.95
	32	11.75	3.18	11.57	3.18	11.52	3.18	11.40	3.18	11.77	3.19	12.01	3.19
	35	11.33	3.39	11.41	3.37	11.44	3.36	11.50	3.35	11.75	3.35	11.91	3.35
	40	10.92	3.51	11.10	3.49	11.17	3.49	11.29	3.47	11.54	3.47	11.71	3.47
	43	10.82	3.48	10.88	3.47	10.90	3.46	10.94	3.45	11.32	3.45	11.57	3.45
	46	10.88	3.35	10.66	3.35	10.58	3.35	10.43	3.35	11.03	3.36	11.43	3.36
3.5 + 3.5 + 3.5 + 3.5 + 4.2	22	14.11	1.86	11.97	1.98	11.26	2.01	9.83	2.09	11.28	2.12	12.24	2.14
	25	13.25	2.37	11.87	2.44	11.41	2.46	10.50	2.51	11.51	2.52	12.19	2.53
	29	12.57	2.89	11.85	2.92	11.61	2.92	11.13	2.94	11.71	2.95	12.09	2.95
	32	11.75	3.18	11.57	3.18	11.52	3.18	11.40	3.18	11.77	3.19	12.01	3.19
	35	11.33	3.39	11.41	3.37	11.44	3.36	11.50	3.35	11.75	3.35	11.91	3.35
	40	10.92	3.51	11.10	3.49	11.17	3.49	11.29	3.47	11.54	3.47	11.71	3.47
	43	10.82	3.48	10.88	3.47	10.90	3.46	10.94	3.45	11.32	3.45	11.57	3.45
	46	10.88	3.35	10.66	3.35	10.58	3.35	10.43	3.35	11.03	3.36	11.43	3.36

Total Q: Total Cooling Capacity (kW)  
Input Power (kW)

## 18.2 Heat Mode Performance Data

Unit setting: Standard piping length, Hi Fan, Heat mode at 30°C

Voltage: 230V, 50Hz

### 18.2.1 CU-4Z80TBE

Combination (Capacity)	Indoor Air Temp. °C DB	Outdoor Air Temp. °C											
		16/15		15/14		10/9		7/6		6/5		2/1	
		Total Q	Input Power	Total Q	Input Power	Total Q	Input Power	Total Q	Input Power	Total Q	Input Power	Total Q	Input Power
1.6	16	3.95	0.79	3.89	0.81	3.59	0.89	3.41	0.94	3.42	0.98	3.39	1.16
	18	3.84	0.81	3.78	0.82	3.49	0.90	3.31	0.95	3.35	0.99	3.42	1.14
	20	3.73	0.82	3.68	0.84	3.38	0.91	3.20	0.96	3.25	1.00	3.39	1.14
	21	3.68	0.84	3.62	0.85	3.31	0.92	3.13	0.97	3.19	1.00	3.36	1.15
	22	3.62	0.85	3.56	0.86	3.24	0.93	3.05	0.97	3.12	1.01	3.33	1.17
	24	3.51	0.87	3.44	0.88	3.08	0.93	2.87	0.97	2.96	1.02	3.23	1.21
2.0	16	5.06	1.01	4.98	1.03	4.60	1.14	4.36	1.20	4.38	1.26	4.35	1.49
	18	4.92	1.03	4.85	1.05	4.47	1.15	4.25	1.21	4.29	1.26	4.39	1.46
	20	4.78	1.06	4.71	1.08	4.33	1.17	4.10	1.23	4.16	1.28	4.35	1.46
	21	4.72	1.07	4.64	1.09	4.25	1.18	4.01	1.24	4.09	1.28	4.31	1.47
	22	4.64	1.09	4.56	1.10	4.16	1.19	3.91	1.24	4.00	1.29	4.26	1.49
	24	4.49	1.12	4.40	1.13	3.95	1.20	3.68	1.24	3.79	1.30	4.14	1.55
2.5	16	5.31	1.01	5.22	1.03	4.82	1.14	4.58	1.20	4.59	1.26	4.56	1.49
	18	5.16	1.03	5.08	1.05	4.69	1.15	4.45	1.21	4.50	1.26	4.60	1.46
	20	5.02	1.06	4.94	1.08	4.54	1.17	4.30	1.23	4.37	1.28	4.56	1.46
	21	4.95	1.07	4.86	1.09	4.45	1.18	4.21	1.24	4.29	1.28	4.52	1.47
	22	4.86	1.09	4.78	1.10	4.36	1.19	4.11	1.24	4.20	1.29	4.47	1.49
	24	4.71	1.12	4.62	1.13	4.14	1.20	3.86	1.24	3.97	1.30	4.34	1.55
3.5	16	7.16	1.73	7.05	1.76	6.50	1.94	6.17	2.05	6.20	2.15	6.15	2.54
	18	6.96	1.77	6.86	1.80	6.33	1.97	6.01	2.07	6.07	2.16	6.21	2.49
	20	6.77	1.80	6.66	1.84	6.12	2.00	5.80	2.10	5.89	2.18	6.15	2.49
	21	6.67	1.83	6.56	1.86	6.01	2.02	5.68	2.11	5.78	2.19	6.09	2.51
	22	6.56	1.86	6.45	1.88	5.88	2.03	5.54	2.11	5.66	2.20	6.03	2.55
	24	6.35	1.91	6.23	1.93	5.59	2.04	5.20	2.11	5.36	2.22	5.86	2.65
4.2	16	8.39	2.41	8.26	2.46	7.62	2.71	7.24	2.86	7.26	2.99	7.21	3.54
	18	8.16	2.46	8.04	2.51	7.42	2.75	7.04	2.89	7.11	3.01	7.28	3.47
	20	7.94	2.52	7.81	2.56	7.18	2.79	6.80	2.93	6.91	3.04	7.21	3.47
	21	7.82	2.55	7.69	2.60	7.04	2.82	6.65	2.95	6.78	3.06	7.14	3.51
	22	7.69	2.59	7.56	2.63	6.89	2.83	6.49	2.95	6.63	3.07	7.07	3.56
	24	7.45	2.66	7.30	2.69	6.55	2.85	6.10	2.95	6.28	3.10	6.87	3.70
5.0	16	8.51	2.07	8.38	2.11	7.73	2.33	7.34	2.46	7.37	2.58	7.31	3.05
	18	8.28	2.12	8.16	2.16	7.53	2.37	7.15	2.49	7.22	2.59	7.38	2.98
	20	8.05	2.16	7.92	2.20	7.28	2.40	6.90	2.52	7.01	2.61	7.31	2.98
	21	7.94	2.20	7.81	2.23	7.15	2.42	6.75	2.54	6.88	2.63	7.25	3.01
	22	7.81	2.23	7.67	2.26	6.99	2.43	6.59	2.54	6.73	2.64	7.18	3.06
	24	7.56	2.29	7.41	2.32	6.65	2.45	6.19	2.54	6.38	2.67	6.97	3.18

Combination (Capacity)	Indoor Air Temp. °C DB	Outdoor Air Temp. °C									
		0/-1		-5/-6		-7/-8		-10/-11		-15/-	
		Total Q	Input Power	Total Q	Input Power	Total Q	Input Power	Total Q	Input Power	Total Q	Input Power
1.6	16	3.28	1.12	2.80	1.03	2.60	1.00	2.24	0.99	1.63	0.98
	18	3.25	1.11	2.70	1.04	2.42	1.01	2.17	0.99	1.67	0.97
	20	3.21	1.11	2.60	1.05	2.35	1.02	2.10	1.00	1.68	0.97
	21	3.18	1.12	2.55	1.06	2.30	1.03	2.06	1.01	1.67	0.97
	22	3.14	1.14	2.50	1.07	2.25	1.04	2.02	1.01	1.65	0.97
	24	3.04	1.18	2.41	1.10	2.15	1.07	1.94	1.04	1.59	0.98
2.0	16	4.20	1.44	3.58	1.32	3.34	1.28	2.87	1.27	2.08	1.26
	18	4.17	1.42	3.46	1.33	3.10	1.29	2.79	1.27	2.14	1.25
	20	4.11	1.42	3.33	1.34	3.01	1.31	2.69	1.28	2.15	1.24
	21	4.07	1.44	3.27	1.35	2.95	1.32	2.64	1.29	2.14	1.24
	22	4.02	1.46	3.20	1.36	2.88	1.33	2.59	1.30	2.11	1.25
	24	3.90	1.51	3.09	1.41	2.76	1.37	2.49	1.33	2.04	1.26
2.5	16	4.40	1.44	3.76	1.32	3.50	1.28	3.01	1.27	2.19	1.26
	18	4.37	1.42	3.62	1.33	3.25	1.29	2.92	1.27	2.25	1.25
	20	4.31	1.42	3.49	1.34	3.16	1.31	2.82	1.28	2.26	1.24
	21	4.27	1.44	3.43	1.35	3.09	1.32	2.77	1.29	2.25	1.24
	22	4.21	1.46	3.36	1.36	3.02	1.33	2.72	1.30	2.22	1.25
	24	4.09	1.51	3.24	1.41	2.89	1.37	2.61	1.33	2.13	1.26
3.5	16	5.94	2.46	5.07	2.26	4.72	2.18	4.06	2.17	2.95	2.15
	18	5.90	2.42	4.89	2.27	4.39	2.20	3.94	2.17	3.03	2.13
	20	5.81	2.43	4.71	2.29	4.26	2.23	3.81	2.19	3.05	2.11
	21	5.76	2.46	4.62	2.31	4.17	2.25	3.74	2.20	3.03	2.11
	22	5.68	2.49	4.53	2.33	4.07	2.27	3.66	2.21	2.99	2.13
	24	5.52	2.58	4.36	2.40	3.90	2.33	3.52	2.26	2.88	2.15
4.2	16	6.96	3.43	5.94	3.15	5.53	3.04	4.76	3.02	3.46	3.00
	18	6.91	3.38	5.73	3.16	5.15	3.07	4.62	3.03	3.55	2.97
	20	6.82	3.39	5.52	3.19	5.00	3.11	4.46	3.05	3.57	2.95
	21	6.75	3.43	5.42	3.23	4.88	3.15	4.39	3.07	3.55	2.95
	22	6.66	3.47	5.31	3.25	4.77	3.16	4.30	3.09	3.51	2.97
	24	6.47	3.60	5.12	3.35	4.58	3.25	4.13	3.16	3.38	3.00
5.0	16	7.06	2.95	6.03	2.71	5.62	2.61	4.83	2.60	3.51	2.58
	18	7.01	2.91	5.81	2.72	5.22	2.64	4.69	2.61	3.61	2.55
	20	6.92	2.92	5.60	2.74	5.07	2.67	4.53	2.62	3.62	2.54
	21	6.85	2.95	5.50	2.77	4.96	2.71	4.45	2.64	3.61	2.54
	22	6.76	2.99	5.39	2.80	4.84	2.72	4.36	2.66	3.56	2.55
	24	6.57	3.10	5.19	2.88	4.64	2.80	4.19	2.72	3.43	2.58

Combination (Capacity)	Indoor Air Temp. °C DB	Outdoor Air Temp. °C											
		16/15		15/14		10/9		7/6		6/5		2/1	
		Total Q	Input Power	Total Q	Input Power	Total Q	Input Power	Total Q	Input Power	Total Q	Input Power	Total Q	Input Power
6.0	16	11.11	2.10	10.94	2.14	10.09	2.36	9.58	2.49	9.61	2.61	9.54	3.08
	18	10.80	2.14	10.64	2.18	9.82	2.39	9.32	2.52	9.41	2.62	9.63	3.02
	20	10.50	2.19	10.34	2.23	9.50	2.43	9.00	2.55	9.14	2.64	9.54	3.02
	21	10.35	2.22	10.18	2.26	9.32	2.45	8.81	2.57	8.97	2.66	9.45	3.05
	22	10.18	2.25	10.00	2.29	9.12	2.46	8.59	2.57	8.78	2.67	9.36	3.10
	24	9.86	2.32	9.66	2.34	8.67	2.48	8.08	2.57	8.32	2.70	9.09	3.22
7.1	16	11.35	2.24	11.18	2.28	10.31	2.51	9.79	2.65	9.83	2.78	9.75	3.29
	18	11.04	2.29	10.88	2.33	10.03	2.55	9.53	2.69	9.62	2.79	9.84	3.22
	20	10.74	2.34	10.57	2.38	9.71	2.59	9.20	2.72	9.34	2.82	9.75	3.22
	21	10.58	2.37	10.41	2.41	9.53	2.61	9.00	2.74	9.17	2.84	9.66	3.25
	22	10.41	2.40	10.23	2.44	9.32	2.63	8.78	2.74	8.98	2.85	9.57	3.30
	24	10.08	2.47	9.88	2.50	8.86	2.65	8.26	2.74	8.50	2.88	9.29	3.44
1.6 + 1.6	16	11.81	2.30	11.59	2.35	10.47	2.60	9.80	2.76	9.17	2.88	7.26	3.16
	18	11.25	2.38	10.99	2.43	9.71	2.66	8.94	2.80	8.38	2.93	6.87	3.25
	20	10.89	2.46	10.59	2.50	9.10	2.71	8.20	2.84	7.68	2.96	6.44	3.25
	21	10.75	2.51	10.43	2.54	8.83	2.70	7.86	2.79	7.36	2.93	6.22	3.27
	22	10.66	2.56	10.44	2.59	9.34	2.76	8.68	2.86	7.97	2.99	5.97	3.28
	24	10.60	2.65	10.20	2.68	8.23	2.81	7.04	2.89	6.56	3.01	5.46	3.29
1.6 + 2.0	16	11.81	2.29	11.59	2.34	10.47	2.60	9.80	2.75	9.17	2.87	7.26	3.15
	18	11.25	2.37	10.99	2.42	9.71	2.65	8.94	2.79	8.38	2.92	6.87	3.24
	20	10.89	2.45	10.59	2.50	9.10	2.70	8.20	2.83	7.68	2.95	6.44	3.24
	21	10.75	2.50	10.43	2.53	8.83	2.69	7.86	2.78	7.36	2.92	6.22	3.25
	22	10.66	2.55	10.44	2.58	9.34	2.75	8.68	2.85	7.97	2.98	5.97	3.27
	24	10.60	2.64	10.20	2.67	8.23	2.80	7.04	2.88	6.56	3.00	5.46	3.28
1.6 + 2.5	16	11.81	2.29	11.59	2.34	10.47	2.60	9.80	2.75	9.17	2.87	7.26	3.15
	18	11.25	2.37	10.99	2.42	9.71	2.65	8.94	2.79	8.38	2.92	6.87	3.24
	20	10.89	2.45	10.59	2.50	9.10	2.70	8.20	2.83	7.68	2.95	6.44	3.24
	21	10.75	2.50	10.43	2.53	8.83	2.69	7.86	2.78	7.36	2.92	6.22	3.25
	22	10.66	2.55	10.44	2.58	9.34	2.75	8.68	2.85	7.97	2.98	5.97	3.27
	24	10.60	2.64	10.20	2.67	8.23	2.80	7.04	2.88	6.56	3.00	5.46	3.28
1.6 + 3.5	16	12.39	2.35	12.15	2.41	10.98	2.67	10.28	2.83	9.62	2.95	7.61	3.24
	18	11.80	2.44	11.53	2.49	10.18	2.73	9.38	2.87	8.78	3.01	7.20	3.33
	20	11.42	2.52	11.11	2.57	9.54	2.78	8.60	2.91	8.05	3.04	6.76	3.33
	21	11.28	2.57	10.94	2.60	9.26	2.77	8.25	2.86	7.72	3.00	6.52	3.35
	22	11.18	2.62	10.95	2.66	9.80	2.83	9.11	2.93	8.36	3.06	6.27	3.36
	24	11.11	2.72	10.70	2.74	8.63	2.88	7.38	2.96	6.88	3.09	5.72	3.38



Combination (Capacity)	Indoor Air Temp. °C DB	Outdoor Air Temp. °C									
		0/-1		-5/-6		-7/-8		-10/-11		-15/-	
		Total Q	Input Power	Total Q	Input Power	Total Q	Input Power	Total Q	Input Power	Total Q	Input Power
6.0	16	9.21	2.98	7.86	2.74	7.32	2.64	6.29	2.63	4.58	2.61
	18	9.15	2.94	7.58	2.75	6.81	2.68	6.11	2.64	4.70	2.58
	20	9.02	2.95	7.30	2.78	6.62	2.71	5.91	2.65	4.73	2.57
	21	8.94	2.98	7.17	2.81	6.47	2.74	5.80	2.67	4.70	2.57
	22	8.82	3.02	7.03	2.83	6.32	2.75	5.69	2.69	4.64	2.58
	24	8.56	3.14	6.77	2.92	6.06	2.83	5.46	2.75	4.47	2.61
7.1	16	9.42	3.18	8.04	2.92	7.49	2.82	6.43	2.81	4.68	2.79
	18	9.35	3.14	7.75	2.94	6.96	2.85	6.25	2.82	4.81	2.75
	20	9.22	3.15	7.47	2.96	6.76	2.89	6.04	2.83	4.83	2.74
	21	9.14	3.18	7.33	2.99	6.61	2.92	5.93	2.85	4.81	2.74
	22	9.02	3.22	7.19	3.02	6.46	2.94	5.81	2.87	4.74	2.75
	24	8.75	3.34	6.92	3.11	6.19	3.02	5.58	2.93	4.57	2.79
1.6 + 1.6	16	7.05	3.18	6.54	3.21	6.33	3.23	6.10	3.08	5.59	3.02
	18	6.69	3.24	6.25	3.21	5.82	3.20	5.98	3.06	5.64	3.01
	20	6.32	3.24	6.02	3.19	5.90	3.17	5.88	3.07	5.56	3.01
	21	6.07	3.24	5.72	3.19	5.57	3.17	5.66	3.08	5.47	3.04
	22	5.94	3.25	5.86	3.20	5.82	3.17	5.79	3.10	5.33	3.04
	24	5.54	3.30	5.75	3.22	5.83	3.20	5.71	3.15	4.98	3.10
1.6 + 2.0	16	7.05	3.16	6.54	3.20	6.33	3.22	6.10	3.06	5.59	3.01
	18	6.69	3.23	6.25	3.20	6.07	3.18	5.98	3.05	5.64	3.00
	20	6.32	3.22	6.02	3.18	5.90	3.16	5.88	3.06	5.56	3.00
	21	6.07	3.23	5.72	3.18	5.57	3.16	5.66	3.07	5.47	3.03
	22	5.94	3.24	5.86	3.18	5.82	3.16	5.79	3.09	5.33	3.03
	24	5.54	3.28	5.75	3.21	5.83	3.18	5.71	3.14	4.98	3.08
1.6 + 2.5	16	7.05	3.16	6.54	3.20	6.33	3.22	6.10	3.06	5.59	3.01
	18	6.69	3.23	6.25	3.20	6.07	3.18	5.98	3.05	5.64	3.00
	20	6.32	3.22	6.02	3.18	5.90	3.16	5.88	3.06	5.56	3.00
	21	6.07	3.23	5.72	3.18	5.57	3.16	5.66	3.07	5.47	3.03
	22	5.94	3.24	5.86	3.18	5.82	3.16	5.79	3.09	5.33	3.03
	24	5.54	3.28	5.75	3.21	5.83	3.18	5.71	3.14	4.98	3.08
1.6 + 3.5	16	7.40	3.25	6.86	3.29	6.64	3.31	6.39	3.15	5.86	3.09
	18	7.02	3.32	6.55	3.29	6.37	3.27	6.27	3.13	5.91	3.08
	20	6.63	3.32	6.31	3.27	6.19	3.25	6.17	3.15	5.83	3.08
	21	6.37	3.32	6.00	3.27	5.85	3.25	5.94	3.16	5.73	3.11
	22	6.23	3.33	6.14	3.27	6.11	3.25	6.07	3.18	5.59	3.11
	24	5.81	3.38	6.03	3.30	6.12	3.27	5.99	3.23	5.23	3.17

Combination (Capacity)	Indoor Air Temp. °C DB	Outdoor Air Temp. °C											
		16/15		15/14		10/9		7/6		6/5		2/1	
		Total Q	Input Power	Total Q	Input Power	Total Q	Input Power	Total Q	Input Power	Total Q	Input Power	Total Q	Input Power
1.6 + 4.2	16	14.12	2.78	13.85	2.85	12.51	3.15	11.71	3.34	10.96	3.49	8.67	3.83
	18	13.44	2.88	13.14	2.94	11.61	3.23	10.69	3.40	10.01	3.55	8.21	3.94
	20	13.01	2.98	12.66	3.03	10.87	3.29	9.80	3.44	9.18	3.59	7.70	3.94
	21	12.85	3.04	12.47	3.08	10.55	3.27	9.40	3.38	8.80	3.55	7.43	3.96
	22	12.74	3.10	12.48	3.14	11.17	3.34	10.38	3.47	9.53	3.62	7.14	3.97
	24	12.66	3.21	12.19	3.24	9.83	3.40	8.42	3.50	7.85	3.65	6.52	3.99
1.6 + 5.0	16	14.40	2.63	14.13	2.69	12.77	2.98	11.95	3.16	11.18	3.29	8.85	3.62
	18	13.72	2.72	13.40	2.78	11.84	3.05	10.91	3.21	10.21	3.36	8.38	3.72
	20	13.28	2.82	12.91	2.87	11.09	3.11	10.00	3.25	9.37	3.39	7.86	3.72
	21	13.11	2.87	12.72	2.91	10.76	3.09	9.59	3.20	8.98	3.35	7.58	3.74
	22	13.00	2.93	12.74	2.97	11.39	3.16	10.59	3.28	9.72	3.42	7.29	3.75
	24	12.92	3.03	12.44	3.06	10.03	3.21	8.59	3.30	8.01	3.45	6.66	3.77
1.6 + 6.0	16	14.40	2.63	14.13	2.69	12.77	2.98	11.95	3.16	11.18	3.29	8.85	3.62
	18	13.72	2.72	13.40	2.78	11.84	3.05	10.91	3.21	10.21	3.36	8.38	3.72
	20	13.28	2.82	12.91	2.87	11.09	3.11	10.00	3.25	9.37	3.39	7.86	3.72
	21	13.11	2.87	12.72	2.91	10.76	3.09	9.59	3.20	8.98	3.35	7.58	3.74
	22	13.00	2.93	12.74	2.97	11.39	3.16	10.59	3.28	9.72	3.42	7.29	3.75
	24	12.92	3.03	12.44	3.06	10.03	3.21	8.59	3.30	8.01	3.45	6.66	3.77
1.6 + 7.1	16	14.84	2.77	14.55	2.83	13.15	3.14	12.31	3.32	11.52	3.47	9.12	3.80
	18	14.13	2.87	13.81	2.92	12.20	3.21	11.23	3.38	10.52	3.53	8.63	3.92
	20	13.68	2.97	13.30	3.02	11.43	3.27	10.30	3.42	9.65	3.57	8.09	3.92
	21	13.51	3.02	13.10	3.06	11.09	3.25	9.88	3.36	9.25	3.53	7.81	3.93
	22	13.39	3.08	13.12	3.12	11.74	3.33	10.91	3.45	10.01	3.60	7.50	3.95
	24	13.31	3.19	12.81	3.22	10.33	3.38	8.84	3.48	8.25	3.63	6.86	3.97
2.0 + 2.0	16	11.81	2.28	11.59	2.33	10.47	2.59	9.80	2.74	9.17	2.86	7.26	3.14
	18	11.25	2.36	10.99	2.41	9.71	2.64	8.94	2.78	8.38	2.91	6.87	3.23
	20	10.89	2.45	10.59	2.49	9.10	2.70	8.20	2.82	7.68	2.94	6.44	3.23
	21	10.75	2.49	10.43	2.52	8.83	2.68	7.86	2.77	7.36	2.91	6.22	3.24
	22	10.66	2.54	10.44	2.57	9.34	2.74	8.68	2.84	7.97	2.97	5.97	3.25
	24	10.60	2.63	10.20	2.66	8.23	2.79	7.04	2.87	6.56	2.99	5.46	3.27
2.0 + 2.5	16	11.81	2.28	11.59	2.33	10.47	2.59	9.80	2.74	9.17	2.86	7.26	3.14
	18	11.25	2.36	10.99	2.41	9.71	2.64	8.94	2.78	8.38	2.91	6.87	3.23
	20	10.89	2.45	10.59	2.49	9.10	2.70	8.20	2.82	7.68	2.94	6.44	3.23
	21	10.75	2.49	10.43	2.52	8.83	2.68	7.86	2.77	7.36	2.91	6.22	3.24
	22	10.66	2.54	10.44	2.57	9.34	2.74	8.68	2.84	7.97	2.97	5.97	3.25
	24	10.60	2.63	10.20	2.66	8.23	2.79	7.04	2.87	6.56	2.99	5.46	3.27

Combination (Capacity)	Indoor Air Temp. °C DB	Outdoor Air Temp. °C									
		0/-1		-5/-6		-7/-8		-10/-11		-15/-	
		Total Q	Input Power	Total Q	Input Power	Total Q	Input Power	Total Q	Input Power	Total Q	Input Power
1.6 + 4.2	16	8.43	3.85	7.81	3.89	7.57	3.91	7.29	3.73	6.68	3.65
	18	8.00	3.93	7.47	3.89	7.25	3.87	7.15	3.70	6.73	3.65
	20	7.56	3.92	7.19	3.86	7.05	3.84	7.03	3.72	6.64	3.65
	21	7.26	3.93	6.83	3.87	6.66	3.84	6.77	3.73	6.53	3.68
	22	7.10	3.94	7.00	3.87	6.96	3.84	6.92	3.76	6.37	3.68
	24	6.62	3.99	6.87	3.90	6.97	3.87	6.83	3.82	5.96	3.75
1.6 + 5.0	16	8.60	3.63	7.97	3.68	7.72	3.70	7.43	3.52	6.82	3.45
	18	8.16	3.71	7.62	3.67	7.40	3.66	7.29	3.50	6.87	3.45
	20	7.71	3.70	7.34	3.65	7.19	3.63	7.17	3.52	6.78	3.45
	21	7.41	3.71	6.97	3.65	6.80	3.63	6.90	3.53	6.67	3.48
	22	7.24	3.72	7.14	3.66	7.10	3.63	7.06	3.55	6.50	3.48
	24	6.76	3.77	7.01	3.69	7.11	3.66	6.97	3.61	6.08	3.54
1.6 + 6.0	16	8.60	3.63	7.97	3.68	7.72	3.70	7.43	3.52	6.82	3.45
	18	8.16	3.71	7.62	3.67	7.40	3.66	7.29	3.50	6.87	3.45
	20	7.71	3.70	7.34	3.65	7.19	3.63	7.17	3.52	6.78	3.45
	21	7.41	3.71	6.97	3.65	6.80	3.63	6.90	3.53	6.67	3.48
	22	7.24	3.72	7.14	3.66	7.10	3.63	7.06	3.55	6.50	3.48
	24	6.76	3.77	7.01	3.69	7.11	3.66	6.97	3.61	6.08	3.54
1.6 + 7.1	16	8.86	3.82	8.21	3.87	7.95	3.89	7.66	3.70	7.02	3.63
	18	8.40	3.90	7.85	3.86	7.62	3.85	7.51	3.68	7.08	3.63
	20	7.94	3.90	7.56	3.84	7.41	3.82	7.38	3.70	6.98	3.63
	21	7.63	3.91	7.18	3.84	7.00	3.82	7.11	3.71	6.87	3.66
	22	7.46	3.92	7.36	3.85	7.31	3.82	7.27	3.73	6.70	3.66
	24	6.96	3.97	7.22	3.88	7.33	3.85	7.18	3.79	6.26	3.73
2.0 + 2.0	16	7.05	3.15	6.54	3.19	6.33	3.21	6.10	3.05	5.59	3.00
	18	6.69	3.22	6.25	3.19	6.07	3.17	5.98	3.04	5.64	2.99
	20	6.32	3.21	6.02	3.17	5.90	3.15	5.88	3.05	5.56	2.99
	21	6.07	3.22	5.72	3.17	5.57	3.15	5.66	3.06	5.47	3.02
	22	5.94	3.23	5.86	3.17	5.82	3.15	5.79	3.08	5.33	3.02
	24	5.54	3.27	5.75	3.20	5.83	3.17	5.71	3.13	4.98	3.07
2.0 + 2.5	16	7.05	3.15	6.54	3.19	6.33	3.21	6.10	3.05	5.59	3.00
	18	6.69	3.22	6.25	3.19	6.07	3.17	5.98	3.04	5.64	2.99
	20	6.32	3.21	6.02	3.17	5.90	3.15	5.88	3.05	5.56	2.99
	21	6.07	3.22	5.72	3.17	5.57	3.15	5.66	3.06	5.47	3.02
	22	5.94	3.23	5.86	3.17	5.82	3.15	5.79	3.08	5.33	3.02
	24	5.54	3.27	5.75	3.20	5.83	3.17	5.71	3.13	4.98	3.07

Combination (Capacity)	Indoor Air Temp. °C DB	Outdoor Air Temp. °C											
		16/15		15/14		10/9		7/6		6/5		2/1	
		Total Q	Input Power	Total Q	Input Power	Total Q	Input Power	Total Q	Input Power	Total Q	Input Power	Total Q	Input Power
2.0 + 3.5	16	12.39	2.31	12.15	2.36	10.98	2.61	10.28	2.77	9.62	2.89	7.61	3.17
	18	11.80	2.39	11.53	2.44	10.18	2.67	9.38	2.81	8.78	2.94	7.20	3.27
	20	11.42	2.47	11.11	2.51	9.54	2.72	8.60	2.85	8.05	2.97	6.76	3.27
	21	11.28	2.52	10.94	2.55	9.26	2.71	8.25	2.80	7.72	2.94	6.52	3.28
	22	11.18	2.57	10.95	2.60	9.80	2.77	9.11	2.87	8.36	3.00	6.27	3.29
	24	11.11	2.66	10.70	2.69	8.63	2.82	7.38	2.90	6.88	3.03	5.72	3.31
2.0 + 4.2	16	14.40	2.87	14.13	2.94	12.77	3.26	11.95	3.45	11.18	3.60	8.85	3.95
	18	13.72	2.98	13.40	3.03	11.84	3.33	10.91	3.51	10.21	3.67	8.38	4.07
	20	13.28	3.08	12.91	3.13	11.09	3.39	10.00	3.55	9.37	3.70	7.86	4.07
	21	13.11	3.14	12.72	3.18	10.76	3.37	9.59	3.49	8.98	3.66	7.58	4.08
	22	13.00	3.20	12.74	3.24	11.39	3.45	10.59	3.58	9.72	3.73	7.29	4.10
	24	12.92	3.31	12.44	3.35	10.03	3.51	8.59	3.61	8.01	3.77	6.66	4.12
2.0 + 5.0	16	14.40	2.61	14.13	2.67	12.77	2.96	11.95	3.14	11.18	3.27	8.85	3.59
	18	13.72	2.71	13.40	2.76	11.84	3.03	10.91	3.19	10.21	3.34	8.38	3.70
	20	13.28	2.80	12.91	2.85	11.09	3.09	10.00	3.23	9.37	3.37	7.86	3.70
	21	13.11	2.85	12.72	2.89	10.76	3.07	9.59	3.18	8.98	3.33	7.58	3.71
	22	13.00	2.91	12.74	2.95	11.39	3.14	10.59	3.26	9.72	3.40	7.29	3.73
	24	12.92	3.02	12.44	3.05	10.03	3.19	8.59	3.28	8.01	3.43	6.66	3.75
2.0 + 6.0	16	14.40	2.61	14.13	2.67	12.77	2.96	11.95	3.14	11.18	3.27	8.85	3.59
	18	13.72	2.71	13.40	2.76	11.84	3.03	10.91	3.19	10.21	3.34	8.38	3.70
	20	13.28	2.80	12.91	2.85	11.09	3.09	10.00	3.23	9.37	3.37	7.86	3.70
	21	13.11	2.85	12.72	2.89	10.76	3.07	9.59	3.18	8.98	3.33	7.58	3.71
	22	13.00	2.91	12.74	2.95	11.39	3.14	10.59	3.26	9.72	3.40	7.29	3.73
	24	12.92	3.02	12.44	3.05	10.03	3.19	8.59	3.28	8.01	3.43	6.66	3.75
2.0 + 7.1	16	14.84	2.75	14.55	2.81	13.15	3.12	12.31	3.30	11.52	3.45	9.12	3.78
	18	14.13	2.85	13.81	2.91	12.20	3.19	11.23	3.36	10.52	3.51	8.63	3.90
	20	13.68	2.95	13.30	3.00	11.43	3.25	10.30	3.40	9.65	3.55	8.09	3.90
	21	13.51	3.00	13.10	3.04	11.09	3.23	9.88	3.34	9.25	3.51	7.81	3.91
	22	13.39	3.06	13.12	3.10	11.74	3.31	10.91	3.43	10.01	3.57	7.50	3.92
	24	13.31	3.17	12.81	3.21	10.33	3.36	8.84	3.46	8.25	3.61	6.86	3.94
2.5 + 2.5	16	12.39	2.37	12.15	2.42	10.98	2.69	10.28	2.84	9.62	2.97	7.61	3.26
	18	11.80	2.46	11.53	2.50	10.18	2.75	9.38	2.89	8.78	3.03	7.20	3.36
	20	11.42	2.54	11.11	2.58	9.54	2.80	8.60	2.93	8.05	3.06	6.76	3.36
	21	11.28	2.59	10.94	2.62	9.26	2.78	8.25	2.88	7.72	3.02	6.52	3.37
	22	11.18	2.64	10.95	2.67	9.80	2.85	9.11	2.95	8.36	3.08	6.27	3.38
	24	11.11	2.74	10.70	2.76	8.63	2.90	7.38	2.98	6.88	3.11	5.72	3.40

Combination (Capacity)	Indoor Air Temp. °C DB	Outdoor Air Temp. °C									
		0/-1		-5/-6		-7/-8		-10/-11		-15/-	
		Total Q	Input Power	Total Q	Input Power	Total Q	Input Power	Total Q	Input Power	Total Q	Input Power
2.0 + 3.5	16	7.40	3.19	6.86	3.23	6.64	3.24	6.39	3.09	5.86	3.03
	18	7.02	3.25	6.55	3.22	6.37	3.21	6.27	3.07	5.91	3.02
	20	6.63	3.25	6.31	3.20	6.19	3.18	6.17	3.09	5.83	3.02
	21	6.37	3.26	6.00	3.20	5.85	3.18	5.94	3.09	5.73	3.05
	22	6.23	3.27	6.14	3.21	6.11	3.18	6.07	3.11	5.59	3.05
	24	5.81	3.31	6.03	3.24	6.12	3.21	5.99	3.16	5.23	3.11
2.0 + 4.2	16	8.60	3.97	7.97	4.02	7.72	4.04	7.43	3.84	6.82	3.77
	18	8.16	4.05	7.62	4.01	7.40	3.99	7.29	3.82	6.87	3.76
	20	7.71	4.04	7.34	3.99	7.19	3.96	7.17	3.84	6.78	3.76
	21	7.41	4.06	6.97	3.99	6.80	3.96	6.90	3.85	6.67	3.80
	22	7.24	4.07	7.14	3.99	7.10	3.96	7.06	3.88	6.50	3.80
	24	6.76	4.12	7.01	4.03	7.11	3.99	6.97	3.94	6.08	3.87
2.0 + 5.0	16	8.60	3.61	7.97	3.66	7.72	3.67	7.43	3.50	6.82	3.43
	18	8.16	3.69	7.62	3.65	7.40	3.63	7.29	3.48	6.87	3.42
	20	7.71	3.68	7.34	3.63	7.19	3.61	7.17	3.50	6.78	3.42
	21	7.41	3.69	6.97	3.63	6.80	3.61	6.90	3.51	6.67	3.46
	22	7.24	3.70	7.14	3.63	7.10	3.61	7.06	3.53	6.50	3.46
	24	6.76	3.75	7.01	3.67	7.11	3.63	6.97	3.58	6.08	3.52
2.0 + 6.0	16	8.60	3.61	7.97	3.66	7.72	3.67	7.43	3.50	6.82	3.43
	18	8.16	3.69	7.62	3.65	7.40	3.63	7.29	3.48	6.87	3.42
	20	7.71	3.68	7.34	3.63	7.19	3.61	7.17	3.50	6.78	3.42
	21	7.41	3.69	6.97	3.63	6.80	3.61	6.90	3.51	6.67	3.46
	22	7.24	3.70	7.14	3.63	7.10	3.61	7.06	3.53	6.50	3.46
	24	6.76	3.75	7.01	3.67	7.11	3.63	6.97	3.58	6.08	3.52
2.0 + 7.1	16	8.86	3.80	8.21	3.85	7.95	3.87	7.66	3.68	7.02	3.61
	18	8.40	3.88	7.85	3.84	7.62	3.83	7.51	3.66	7.08	3.60
	20	7.94	3.87	7.56	3.82	7.41	3.80	7.38	3.68	6.98	3.60
	21	7.63	3.88	7.18	3.82	7.00	3.80	7.11	3.69	6.87	3.64
	22	7.46	3.90	7.36	3.83	7.31	3.80	7.27	3.71	6.70	3.64
	24	6.96	3.95	7.22	3.86	7.33	3.83	7.18	3.77	6.26	3.71
2.5 + 2.5	16	7.40	3.28	6.86	3.32	6.64	3.33	6.39	3.17	5.86	3.11
	18	7.02	3.34	6.55	3.31	6.37	3.30	6.27	3.15	5.91	3.11
	20	6.63	3.34	6.31	3.29	6.19	3.27	6.17	3.17	5.83	3.11
	21	6.37	3.35	6.00	3.29	5.85	3.27	5.94	3.18	5.73	3.14
	22	6.23	3.36	6.14	3.30	6.11	3.27	6.07	3.20	5.59	3.14
	24	5.81	3.40	6.03	3.33	6.12	3.30	5.99	3.25	5.23	3.19

Combination (Capacity)	Indoor Air Temp. °C DB	Outdoor Air Temp. °C											
		16/15		15/14		10/9		7/6		6/5		2/1	
		Total Q	Input Power	Total Q	Input Power	Total Q	Input Power	Total Q	Input Power	Total Q	Input Power	Total Q	Input Power
2.5 + 3.5	16	14.12	2.78	13.85	2.85	12.51	3.15	11.71	3.34	10.96	3.49	8.67	3.83
	18	13.44	2.88	13.14	2.94	11.61	3.23	10.69	3.40	10.01	3.55	8.21	3.94
	20	13.01	2.98	12.66	3.03	10.87	3.29	9.80	3.44	9.18	3.59	7.70	3.94
	21	12.85	3.04	12.47	3.08	10.55	3.27	9.40	3.38	8.80	3.55	7.43	3.96
	22	12.74	3.10	12.48	3.14	11.17	3.34	10.38	3.47	9.53	3.62	7.14	3.97
	24	12.66	3.21	12.19	3.24	9.83	3.40	8.42	3.50	7.85	3.65	6.52	3.99
2.5 + 4.2	16	14.40	2.87	14.13	2.94	12.77	3.26	11.95	3.45	11.18	3.60	8.85	3.95
	18	13.72	2.98	13.40	3.03	11.84	3.33	10.91	3.51	10.21	3.67	8.38	4.07
	20	13.28	3.08	12.91	3.13	11.09	3.39	10.00	3.55	9.37	3.70	7.86	4.07
	21	13.11	3.14	12.72	3.18	10.76	3.37	9.59	3.49	8.98	3.66	7.58	4.08
	22	13.00	3.20	12.74	3.24	11.39	3.45	10.59	3.58	9.72	3.73	7.29	4.10
	24	12.92	3.31	12.44	3.35	10.03	3.51	8.59	3.61	8.01	3.77	6.66	4.12
2.5 + 5.0	16	14.40	2.61	14.13	2.67	12.77	2.96	11.95	3.14	11.18	3.27	8.85	3.59
	18	13.72	2.71	13.40	2.76	11.84	3.03	10.91	3.19	10.21	3.34	8.38	3.70
	20	13.28	2.80	12.91	2.85	11.09	3.09	10.00	3.23	9.37	3.37	7.86	3.70
	21	13.11	2.85	12.72	2.89	10.76	3.07	9.59	3.18	8.98	3.33	7.58	3.71
	22	13.00	2.91	12.74	2.95	11.39	3.14	10.59	3.26	9.72	3.40	7.29	3.73
	24	12.92	3.02	12.44	3.05	10.03	3.19	8.59	3.28	8.01	3.43	6.66	3.75
2.5 + 6.0	16	14.40	2.61	14.13	2.67	12.77	2.96	11.95	3.14	11.18	3.27	8.85	3.59
	18	13.72	2.71	13.40	2.76	11.84	3.03	10.91	3.19	10.21	3.34	8.38	3.70
	20	13.28	2.80	12.91	2.85	11.09	3.09	10.00	3.23	9.37	3.37	7.86	3.70
	21	13.11	2.85	12.72	2.89	10.76	3.07	9.59	3.18	8.98	3.33	7.58	3.71
	22	13.00	2.91	12.74	2.95	11.39	3.14	10.59	3.26	9.72	3.40	7.29	3.73
	24	12.92	3.02	12.44	3.05	10.03	3.19	8.59	3.28	8.01	3.43	6.66	3.75
2.5 + 7.1	16	14.84	2.75	14.55	2.81	13.15	3.12	12.31	3.30	11.52	3.45	9.12	3.78
	18	14.13	2.85	13.81	2.91	12.20	3.19	11.23	3.36	10.52	3.51	8.63	3.90
	20	13.68	2.95	13.30	3.00	11.43	3.25	10.30	3.40	9.65	3.55	8.09	3.90
	21	13.51	3.00	13.10	3.04	11.09	3.23	9.88	3.34	9.25	3.51	7.81	3.91
	22	13.39	3.06	13.12	3.10	11.74	3.31	10.91	3.43	10.01	3.57	7.50	3.92
	24	13.31	3.17	12.81	3.21	10.33	3.36	8.84	3.46	8.25	3.61	6.86	3.94
3.5 + 3.5	16	14.40	2.81	14.13	2.87	12.77	3.18	11.95	3.37	11.18	3.52	8.85	3.86
	18	13.72	2.91	13.40	2.97	11.84	3.25	10.91	3.43	10.21	3.59	8.38	3.98
	20	13.28	3.01	12.91	3.06	11.09	3.32	10.00	3.47	9.37	3.62	7.86	3.98
	21	13.11	3.07	12.72	3.11	10.76	3.30	9.59	3.41	8.98	3.58	7.58	3.99
	22	13.00	3.12	12.74	3.17	11.39	3.37	10.59	3.50	9.72	3.65	7.29	4.00
	24	12.92	3.24	12.44	3.27	10.03	3.43	8.59	3.53	8.01	3.68	6.66	4.03

Combination (Capacity)	Indoor Air Temp. °C DB	Outdoor Air Temp. °C									
		0/-1		-5/-6		-7/-8		-10/-11		-15/-	
		Total Q	Input Power	Total Q	Input Power	Total Q	Input Power	Total Q	Input Power	Total Q	Input Power
2.5 + 3.5	16	8.43	3.85	7.81	3.89	7.57	3.91	7.29	3.73	6.68	3.65
	18	8.00	3.93	7.47	3.89	7.25	3.87	7.15	3.70	6.73	3.65
	20	7.56	3.92	7.19	3.86	7.05	3.84	7.03	3.72	6.64	3.65
	21	7.26	3.93	6.83	3.87	6.66	3.84	6.77	3.73	6.53	3.68
	22	7.10	3.94	7.00	3.87	6.96	3.84	6.92	3.76	6.37	3.68
	24	6.62	3.99	6.87	3.90	6.97	3.87	6.83	3.82	5.96	3.75
2.5 + 4.2	16	8.60	3.97	7.97	4.02	7.72	4.04	7.43	3.84	6.82	3.77
	18	8.16	4.05	7.62	4.01	7.40	3.99	7.29	3.82	6.87	3.76
	20	7.71	4.04	7.34	3.99	7.19	3.96	7.17	3.84	6.78	3.76
	21	7.41	4.06	6.97	3.99	6.80	3.96	6.90	3.85	6.67	3.80
	22	7.24	4.07	7.14	3.99	7.10	3.96	7.06	3.88	6.50	3.80
	24	6.76	4.12	7.01	4.03	7.11	3.99	6.97	3.94	6.08	3.87
2.5 + 5.0	16	8.60	3.61	7.97	3.66	7.72	3.67	7.43	3.50	6.82	3.43
	18	8.16	3.69	7.62	3.65	7.40	3.63	7.29	3.48	6.87	3.42
	20	7.71	3.68	7.34	3.63	7.19	3.61	7.17	3.50	6.78	3.42
	21	7.41	3.69	6.97	3.63	6.80	3.61	6.90	3.51	6.67	3.46
	22	7.24	3.70	7.14	3.63	7.10	3.61	7.06	3.53	6.50	3.46
	24	6.76	3.75	7.01	3.67	7.11	3.63	6.97	3.58	6.08	3.52
2.5 + 6.0	16	8.60	3.61	7.97	3.66	7.72	3.67	7.43	3.50	6.82	3.43
	18	8.16	3.69	7.62	3.65	7.40	3.63	7.29	3.48	6.87	3.42
	20	7.71	3.68	7.34	3.63	7.19	3.61	7.17	3.50	6.78	3.42
	21	7.41	3.69	6.97	3.63	6.80	3.61	6.90	3.51	6.67	3.46
	22	7.24	3.70	7.14	3.63	7.10	3.61	7.06	3.53	6.50	3.46
	24	6.76	3.75	7.01	3.67	7.11	3.63	6.97	3.58	6.08	3.52
2.5 + 7.1	16	8.86	3.80	8.21	3.85	7.95	3.87	7.66	3.68	7.02	3.61
	18	8.40	3.88	7.85	3.84	7.62	3.83	7.51	3.66	7.08	3.60
	20	7.94	3.87	7.56	3.82	7.41	3.80	7.38	3.68	6.98	3.60
	21	7.63	3.88	7.18	3.82	7.00	3.80	7.11	3.69	6.87	3.64
	22	7.46	3.90	7.36	3.83	7.31	3.80	7.27	3.71	6.70	3.64
	24	6.96	3.95	7.22	3.86	7.33	3.83	7.18	3.77	6.26	3.71
3.5 + 3.5	16	8.60	3.88	7.97	3.93	7.72	3.95	7.43	3.76	6.82	3.69
	18	8.16	3.96	7.62	3.92	7.40	3.90	7.29	3.74	6.87	3.68
	20	7.71	3.95	7.34	3.90	7.19	3.88	7.17	3.76	6.78	3.68
	21	7.41	3.96	6.97	3.90	6.80	3.88	6.90	3.77	6.67	3.71
	22	7.24	3.98	7.14	3.90	7.10	3.88	7.06	3.79	6.50	3.71
	24	6.76	4.03	7.01	3.94	7.11	3.90	6.97	3.85	6.08	3.78

Combination (Capacity)	Indoor Air Temp. °C DB	Outdoor Air Temp. °C											
		16/15		15/14		10/9		7/6		6/5		2/1	
		Total Q	Input Power	Total Q	Input Power	Total Q	Input Power	Total Q	Input Power	Total Q	Input Power	Total Q	Input Power
3.5 + 4.2	16	14.40	2.80	14.13	2.86	12.77	3.17	11.95	3.36	11.18	3.51	8.85	3.85
	18	13.72	2.90	13.40	2.96	11.84	3.24	10.91	3.42	10.21	3.57	8.38	3.96
	20	13.28	3.00	12.91	3.05	11.09	3.31	10.00	3.46	9.37	3.61	7.86	3.96
	21	13.11	3.06	12.72	3.10	10.76	3.29	9.59	3.40	8.98	3.57	7.58	3.98
	22	13.00	3.12	12.74	3.16	11.39	3.36	10.59	3.49	9.72	3.64	7.29	3.99
	24	12.92	3.23	12.44	3.26	10.03	3.42	8.59	3.52	8.01	3.67	6.66	4.01
3.5 + 5.0	16	14.40	2.59	14.13	2.65	12.77	2.93	11.95	3.11	11.18	3.24	8.85	3.56
	18	13.72	2.68	13.40	2.74	11.84	3.00	10.91	3.16	10.21	3.31	8.38	3.67
	20	13.28	2.78	12.91	2.82	11.09	3.06	10.00	3.20	9.37	3.34	7.86	3.67
	21	13.11	2.83	12.72	2.86	10.76	3.04	9.59	3.15	8.98	3.30	7.58	3.68
	22	13.00	2.88	12.74	2.92	11.39	3.11	10.59	3.23	9.72	3.36	7.29	3.69
	24	12.92	2.99	12.44	3.02	10.03	3.16	8.59	3.25	8.01	3.40	6.66	3.71
3.5 + 6.0	16	14.84	2.69	14.55	2.75	13.15	3.04	12.31	3.22	11.52	3.36	9.12	3.69
	18	14.13	2.78	13.81	2.84	12.20	3.11	11.23	3.28	10.52	3.43	8.63	3.80
	20	13.68	2.88	13.30	2.93	11.43	3.17	10.30	3.32	9.65	3.46	8.09	3.80
	21	13.51	2.93	13.10	2.97	11.09	3.16	9.88	3.27	9.25	3.42	7.81	3.82
	22	13.39	2.99	13.12	3.03	11.74	3.23	10.91	3.35	10.01	3.49	7.50	3.83
	24	13.31	3.10	12.81	3.13	10.33	3.28	8.84	3.38	8.25	3.52	6.86	3.85
3.5 + 7.1	16	15.12	2.78	14.84	2.84	13.40	3.15	12.55	3.33	11.74	3.48	9.29	3.82
	18	14.40	2.87	14.08	2.93	12.43	3.22	11.45	3.39	10.72	3.54	8.80	3.93
	20	13.94	2.97	13.56	3.03	11.65	3.28	10.50	3.43	9.83	3.58	8.25	3.93
	21	13.77	3.03	13.36	3.07	11.30	3.26	10.07	3.37	9.43	3.54	7.96	3.94
	22	13.65	3.09	13.37	3.13	11.96	3.34	11.12	3.46	10.21	3.61	7.65	3.96
	24	13.57	3.20	13.06	3.23	10.53	3.39	9.02	3.49	8.41	3.64	6.99	3.98
4.2 + 4.2	16	14.40	2.79	14.13	2.85	12.77	3.16	11.95	3.35	11.18	3.50	8.85	3.84
	18	13.72	2.89	13.40	2.95	11.84	3.24	10.91	3.41	10.21	3.56	8.38	3.95
	20	13.28	2.99	12.91	3.04	11.09	3.30	10.00	3.45	9.37	3.60	7.86	3.95
	21	13.11	3.05	12.72	3.09	10.76	3.28	9.59	3.39	8.98	3.56	7.58	3.97
	22	13.00	3.11	12.74	3.15	11.39	3.35	10.59	3.48	9.72	3.63	7.29	3.98
	24	12.92	3.22	12.44	3.25	10.03	3.41	8.59	3.51	8.01	3.66	6.66	4.00
4.2 + 5.0	16	14.84	2.68	14.55	2.74	13.15	3.04	12.31	3.21	11.52	3.35	9.12	3.68
	18	14.13	2.77	13.81	2.83	12.20	3.10	11.23	3.27	10.52	3.42	8.63	3.79
	20	13.68	2.87	13.30	2.92	11.43	3.16	10.30	3.31	9.65	3.45	8.09	3.79
	21	13.51	2.93	13.10	2.96	11.09	3.15	9.88	3.26	9.25	3.41	7.81	3.81
	22	13.39	2.98	13.12	3.02	11.74	3.22	10.91	3.34	10.01	3.48	7.50	3.82
	24	13.31	3.09	12.81	3.12	10.33	3.27	8.84	3.36	8.25	3.51	6.86	3.84



Combination (Capacity)	Indoor Air Temp. °C DB	Outdoor Air Temp. °C									
		0/-1		-5/-6		-7/-8		-10/-11		-15/-	
		Total Q	Input Power	Total Q	Input Power	Total Q	Input Power	Total Q	Input Power	Total Q	Input Power
3.5 + 4.2	16	8.60	3.87	7.97	3.92	7.72	3.94	7.43	3.75	6.82	3.68
	18	8.16	3.95	7.62	3.91	7.40	3.89	7.29	3.73	6.87	3.67
	20	7.71	3.94	7.34	3.89	7.19	3.86	7.17	3.75	6.78	3.67
	21	7.41	3.95	6.97	3.89	6.80	3.86	6.90	3.76	6.67	3.70
	22	7.24	3.96	7.14	3.89	7.10	3.86	7.06	3.78	6.50	3.70
	24	6.76	4.02	7.01	3.93	7.11	3.89	6.97	3.84	6.08	3.77
3.5 + 5.0	16	8.60	3.58	7.97	3.62	7.72	3.64	7.43	3.47	6.82	3.40
	18	8.16	3.65	7.62	3.61	7.40	3.60	7.29	3.45	6.87	3.39
	20	7.71	3.65	7.34	3.59	7.19	3.57	7.17	3.46	6.78	3.39
	21	7.41	3.66	6.97	3.60	6.80	3.57	6.90	3.47	6.67	3.42
	22	7.24	3.67	7.14	3.60	7.10	3.57	7.06	3.49	6.50	3.42
	24	6.76	3.71	7.01	3.63	7.11	3.60	6.97	3.55	6.08	3.49
3.5 + 6.0	16	8.86	3.71	8.21	3.76	7.95	3.78	7.66	3.60	7.02	3.53
	18	8.40	3.79	7.85	3.75	7.62	3.74	7.51	3.57	7.08	3.52
	20	7.94	3.78	7.56	3.73	7.41	3.71	7.38	3.59	6.98	3.52
	21	7.63	3.79	7.18	3.73	7.00	3.71	7.11	3.60	6.87	3.55
	22	7.46	3.80	7.36	3.74	7.31	3.71	7.27	3.62	6.70	3.55
	24	6.96	3.85	7.22	3.77	7.33	3.74	7.18	3.68	6.26	3.62
3.5 + 7.1	16	9.03	3.84	8.37	3.88	8.11	3.90	7.81	3.71	7.16	3.64
	18	8.57	3.91	8.00	3.87	7.77	3.86	7.66	3.69	7.22	3.64
	20	8.10	3.91	7.71	3.85	7.55	3.83	7.53	3.71	7.12	3.64
	21	7.78	3.92	7.32	3.86	7.14	3.83	7.25	3.72	7.00	3.67
	22	7.61	3.93	7.50	3.86	7.46	3.83	7.41	3.74	6.83	3.67
	24	7.10	3.98	7.36	3.89	7.47	3.86	7.32	3.81	6.38	3.74
4.2 + 4.2	16	8.60	3.86	7.97	3.91	7.72	3.92	7.43	3.74	6.82	3.66
	18	8.16	3.94	7.62	3.90	7.40	3.88	7.29	3.71	6.87	3.66
	20	7.71	3.93	7.34	3.87	7.19	3.85	7.17	3.73	6.78	3.66
	21	7.41	3.94	6.97	3.88	6.80	3.85	6.90	3.75	6.67	3.69
	22	7.24	3.95	7.14	3.88	7.10	3.85	7.06	3.77	6.50	3.69
	24	6.76	4.00	7.01	3.92	7.11	3.88	6.97	3.83	6.08	3.76
4.2 + 5.0	16	8.86	3.70	8.21	3.75	7.95	3.77	7.66	3.58	7.02	3.52
	18	8.40	3.78	7.85	3.74	7.62	3.72	7.51	3.56	7.08	3.51
	20	7.94	3.77	7.56	3.72	7.41	3.70	7.38	3.58	6.98	3.51
	21	7.63	3.78	7.18	3.72	7.00	3.70	7.11	3.59	6.87	3.54
	22	7.46	3.79	7.36	3.72	7.31	3.70	7.27	3.61	6.70	3.54
	24	6.96	3.84	7.22	3.76	7.33	3.72	7.18	3.67	6.26	3.61

Combination (Capacity)	Indoor Air Temp. °C DB	Outdoor Air Temp. °C											
		16/15		15/14		10/9		7/6		6/5		2/1	
		Total Q	Input Power	Total Q	Input Power	Total Q	Input Power	Total Q	Input Power	Total Q	Input Power	Total Q	Input Power
4.2 + 6.0	16	14.84	2.68	14.55	2.74	13.15	3.04	12.31	3.21	11.52	3.35	9.12	3.68
	18	14.13	2.77	13.81	2.83	12.20	3.10	11.23	3.27	10.52	3.42	8.63	3.79
	20	13.68	2.87	13.30	2.92	11.43	3.16	10.30	3.31	9.65	3.45	8.09	3.79
	21	13.51	2.93	13.10	2.96	11.09	3.15	9.88	3.26	9.25	3.41	7.81	3.81
	22	13.39	2.98	13.12	3.02	11.74	3.22	10.91	3.34	10.01	3.48	7.50	3.82
	24	13.31	3.09	12.81	3.12	10.33	3.27	8.84	3.36	8.25	3.51	6.86	3.84
4.2 + 7.1	16	15.12	2.77	14.84	2.83	13.40	3.14	12.55	3.32	11.74	3.47	9.29	3.80
	18	14.40	2.87	14.08	2.92	12.43	3.21	11.45	3.38	10.72	3.53	8.80	3.92
	20	13.94	2.97	13.56	3.02	11.65	3.27	10.50	3.42	9.83	3.57	8.25	3.92
	21	13.77	3.02	13.36	3.06	11.30	3.25	10.07	3.36	9.43	3.53	7.96	3.93
	22	13.65	3.08	13.37	3.12	11.96	3.33	11.12	3.45	10.21	3.60	7.65	3.95
	24	13.57	3.19	13.06	3.22	10.53	3.38	9.02	3.48	8.41	3.63	6.99	3.97
5.0 + 5.0	16	14.84	2.50	14.55	2.56	13.15	2.83	12.31	3.00	11.52	3.13	9.12	3.44
	18	14.13	2.59	13.81	2.64	12.20	2.90	11.23	3.05	10.52	3.19	8.63	3.54
	20	13.68	2.68	13.30	2.73	11.43	2.95	10.30	3.09	9.65	3.22	8.09	3.54
	21	13.51	2.73	13.10	2.77	11.09	2.94	9.88	3.04	9.25	3.19	7.81	3.55
	22	13.39	2.78	13.12	2.82	11.74	3.00	10.91	3.12	10.01	3.25	7.50	3.57
	24	13.31	2.88	12.81	2.91	10.33	3.06	8.84	3.14	8.25	3.28	6.86	3.58
5.0 + 6.0	16	15.12	2.55	14.84	2.61	13.40	2.89	12.55	3.06	11.74	3.19	9.29	3.50
	18	14.40	2.64	14.08	2.69	12.43	2.95	11.45	3.11	10.72	3.25	8.80	3.61
	20	13.94	2.73	13.56	2.78	11.65	3.01	10.50	3.15	9.83	3.29	8.25	3.61
	21	13.77	2.78	13.36	2.82	11.30	2.99	10.07	3.10	9.43	3.25	7.96	3.62
	22	13.65	2.84	13.37	2.87	11.96	3.06	11.12	3.18	10.21	3.31	7.65	3.64
	24	13.57	2.94	13.06	2.97	10.53	3.12	9.02	3.20	8.41	3.34	6.99	3.65
5.0 + 7.1	16	15.12	2.53	14.84	2.59	13.40	2.87	12.55	3.04	11.74	3.17	9.29	3.48
	18	14.40	2.62	14.08	2.68	12.43	2.94	11.45	3.09	10.72	3.23	8.80	3.59
	20	13.94	2.71	13.56	2.76	11.65	2.99	10.50	3.13	9.83	3.27	8.25	3.59
	21	13.77	2.77	13.36	2.80	11.30	2.97	10.07	3.08	9.43	3.23	7.96	3.60
	22	13.65	2.82	13.37	2.86	11.96	3.04	11.12	3.16	10.21	3.29	7.65	3.61
	24	13.57	2.92	13.06	2.95	10.53	3.10	9.02	3.18	8.41	3.32	6.99	3.63
6.0 + 6.0	16	15.12	2.55	14.84	2.61	13.40	2.89	12.55	3.06	11.74	3.19	9.29	3.50
	18	14.40	2.64	14.08	2.69	12.43	2.95	11.45	3.11	10.72	3.25	8.80	3.61
	20	13.94	2.73	13.56	2.78	11.65	3.01	10.50	3.15	9.83	3.29	8.25	3.61
	21	13.77	2.78	13.36	2.82	11.30	2.99	10.07	3.10	9.43	3.25	7.96	3.62
	22	13.65	2.84	13.37	2.87	11.96	3.06	11.12	3.18	10.21	3.31	7.65	3.64
	24	13.57	2.94	13.06	2.97	10.53	3.12	9.02	3.20	8.41	3.34	6.99	3.65

Combination (Capacity)	Indoor Air Temp. °C DB	Outdoor Air Temp. °C									
		0/-1		-5/-6		-7/-8		-10/-11		-15/-	
		Total Q	Input Power	Total Q	Input Power	Total Q	Input Power	Total Q	Input Power	Total Q	Input Power
4.2 + 6.0	16	8.86	3.70	8.21	3.75	7.95	3.77	7.66	3.58	7.02	3.52
	18	8.40	3.78	7.85	3.74	7.62	3.72	7.51	3.56	7.08	3.51
	20	7.94	3.77	7.56	3.72	7.41	3.70	7.38	3.58	6.98	3.51
	21	7.63	3.78	7.18	3.72	7.00	3.70	7.11	3.59	6.87	3.54
	22	7.46	3.79	7.36	3.72	7.31	3.70	7.27	3.61	6.70	3.54
	24	6.96	3.84	7.22	3.76	7.33	3.72	7.18	3.67	6.26	3.61
4.2 + 7.1	16	9.03	3.82	8.37	3.87	8.11	3.89	7.81	3.70	7.16	3.63
	18	8.57	3.90	8.00	3.86	7.77	3.85	7.66	3.68	7.22	3.63
	20	8.10	3.90	7.71	3.84	7.55	3.82	7.53	3.70	7.12	3.63
	21	7.78	3.91	7.32	3.84	7.14	3.82	7.25	3.71	7.00	3.66
	22	7.61	3.92	7.50	3.85	7.46	3.82	7.41	3.73	6.83	3.66
	24	7.10	3.97	7.36	3.88	7.47	3.85	7.32	3.79	6.38	3.73
5.0 + 5.0	16	8.86	3.45	8.21	3.50	7.95	3.51	7.66	3.35	7.02	3.28
	18	8.40	3.53	7.85	3.49	7.62	3.48	7.51	3.33	7.08	3.28
	20	7.94	3.52	7.56	3.47	7.41	3.45	7.38	3.34	6.98	3.28
	21	7.63	3.53	7.18	3.47	7.00	3.45	7.11	3.35	6.87	3.31
	22	7.46	3.54	7.36	3.48	7.31	3.45	7.27	3.37	6.70	3.31
	24	6.96	3.59	7.22	3.51	7.33	3.48	7.18	3.43	6.26	3.37
5.0 + 6.0	16	9.03	3.52	8.37	3.57	8.11	3.58	7.81	3.41	7.16	3.35
	18	8.57	3.59	8.00	3.56	7.77	3.54	7.66	3.39	7.22	3.34
	20	8.10	3.59	7.71	3.54	7.55	3.52	7.53	3.41	7.12	3.34
	21	7.78	3.60	7.32	3.54	7.14	3.52	7.25	3.42	7.00	3.37
	22	7.61	3.61	7.50	3.54	7.46	3.52	7.41	3.44	6.83	3.37
	24	7.10	3.66	7.36	3.58	7.47	3.54	7.32	3.49	6.38	3.43
5.0 + 7.1	16	9.03	3.50	8.37	3.54	8.11	3.56	7.81	3.39	7.16	3.32
	18	8.57	3.57	8.00	3.54	7.77	3.52	7.66	3.37	7.22	3.32
	20	8.10	3.57	7.71	3.52	7.55	3.50	7.53	3.39	7.12	3.32
	21	7.78	3.58	7.32	3.52	7.14	3.50	7.25	3.40	7.00	3.35
	22	7.61	3.59	7.50	3.52	7.46	3.50	7.41	3.42	6.83	3.35
	24	7.10	3.63	7.36	3.55	7.47	3.52	7.32	3.47	6.38	3.41
6.0 + 6.0	16	9.03	3.52	8.37	3.57	8.11	3.58	7.81	3.41	7.16	3.35
	18	8.57	3.59	8.00	3.56	7.77	3.54	7.66	3.39	7.22	3.34
	20	8.10	3.59	7.71	3.54	7.55	3.52	7.53	3.41	7.12	3.34
	21	7.78	3.60	7.32	3.54	7.14	3.52	7.25	3.42	7.00	3.37
	22	7.61	3.61	7.50	3.54	7.46	3.52	7.41	3.44	6.83	3.37
	24	7.10	3.66	7.36	3.58	7.47	3.54	7.32	3.49	6.38	3.43

Combination (Capacity)	Indoor Air Temp. °C DB	Outdoor Air Temp. °C											
		16/15		15/14		10/9		7/6		6/5		2/1	
		Total Q	Input Power	Total Q	Input Power	Total Q	Input Power	Total Q	Input Power	Total Q	Input Power	Total Q	Input Power
6.0 + 7.1	16	15.12	2.53	14.84	2.59	13.40	2.87	12.55	3.04	11.74	3.17	9.29	3.48
	18	14.40	2.62	14.08	2.68	12.43	2.94	11.45	3.09	10.72	3.23	8.80	3.59
	20	13.94	2.71	13.56	2.76	11.65	2.99	10.50	3.13	9.83	3.27	8.25	3.59
	21	13.77	2.77	13.36	2.80	11.30	2.97	10.07	3.08	9.43	3.23	7.96	3.60
	22	13.65	2.82	13.37	2.86	11.96	3.04	11.12	3.16	10.21	3.29	7.65	3.61
	24	13.57	2.92	13.06	2.95	10.53	3.10	9.02	3.18	8.41	3.32	6.99	3.63
7.1 + 7.1	16	15.12	2.52	14.84	2.58	13.40	2.86	12.55	3.03	11.74	3.16	9.29	3.47
	18	14.40	2.62	14.08	2.67	12.43	2.93	11.45	3.08	10.72	3.22	8.80	3.57
	20	13.94	2.71	13.56	2.75	11.65	2.98	10.50	3.12	9.83	3.25	8.25	3.57
	21	13.77	2.76	13.36	2.79	11.30	2.97	10.07	3.07	9.43	3.22	7.96	3.59
	22	13.65	2.81	13.37	2.85	11.96	3.03	11.12	3.15	10.21	3.28	7.65	3.60
	24	13.57	2.91	13.06	2.94	10.53	3.09	9.02	3.17	8.41	3.31	6.99	3.62
1.6 + 1.6 + 1.6	16	14.98	2.70	14.70	2.76	13.28	3.06	12.43	3.24	11.63	3.38	9.21	3.72
	18	14.27	2.80	13.94	2.85	12.32	3.13	11.34	3.30	10.62	3.45	8.71	3.83
	20	13.81	2.90	13.43	2.95	11.54	3.19	10.40	3.34	9.74	3.48	8.17	3.83
	21	13.64	2.95	13.23	2.99	11.19	3.17	9.97	3.29	9.34	3.44	7.88	3.84
	22	13.52	3.01	13.25	3.05	11.85	3.25	11.01	3.37	10.11	3.51	7.58	3.85
	24	13.44	3.12	12.94	3.15	10.43	3.30	8.93	3.40	8.33	3.55	6.92	3.87
1.6 + 1.6 + 2.0	16	14.98	2.64	14.70	2.70	13.28	2.99	12.43	3.17	11.63	3.30	9.21	3.63
	18	14.27	2.73	13.94	2.79	12.32	3.06	11.34	3.22	10.62	3.37	8.71	3.74
	20	13.81	2.83	13.43	2.88	11.54	3.12	10.40	3.26	9.74	3.40	8.17	3.74
	21	13.64	2.88	13.23	2.92	11.19	3.10	9.97	3.21	9.34	3.36	7.88	3.75
	22	13.52	2.94	13.25	2.97	11.85	3.17	11.01	3.29	10.11	3.43	7.58	3.76
	24	13.44	3.04	12.94	3.07	10.43	3.22	8.93	3.31	8.33	3.46	6.92	3.78
1.6 + 1.6 + 2.5	16	14.98	2.64	14.70	2.70	13.28	2.99	12.43	3.17	11.63	3.30	9.21	3.63
	18	14.27	2.73	13.94	2.79	12.32	3.06	11.34	3.22	10.62	3.37	8.71	3.74
	20	13.81	2.83	13.43	2.88	11.54	3.12	10.40	3.26	9.74	3.40	8.17	3.74
	21	13.64	2.88	13.23	2.92	11.19	3.10	9.97	3.21	9.34	3.36	7.88	3.75
	22	13.52	2.94	13.25	2.97	11.85	3.17	11.01	3.29	10.11	3.43	7.58	3.76
	24	13.44	3.04	12.94	3.07	10.43	3.22	8.93	3.31	8.33	3.46	6.92	3.78
1.6 + 1.6 + 3.5	16	14.98	2.61	14.70	2.67	13.28	2.96	12.43	3.14	11.63	3.27	9.21	3.59
	18	14.27	2.71	13.94	2.76	12.32	3.03	11.34	3.19	10.62	3.34	8.71	3.70
	20	13.81	2.80	13.43	2.85	11.54	3.09	10.40	3.23	9.74	3.37	8.17	3.70
	21	13.64	2.85	13.23	2.89	11.19	3.07	9.97	3.18	9.34	3.33	7.88	3.71
	22	13.52	2.91	13.25	2.95	11.85	3.14	11.01	3.26	10.11	3.40	7.58	3.73
	24	13.44	3.02	12.94	3.05	10.43	3.19	8.93	3.28	8.33	3.43	6.92	3.75

Combination (Capacity)	Indoor Air Temp. °C DB	Outdoor Air Temp. °C									
		0/-1		-5/-6		-7/-8		-10/-11		-15/-	
		Total Q	Input Power	Total Q	Input Power	Total Q	Input Power	Total Q	Input Power	Total Q	Input Power
6.0 + 7.1	16	9.03	3.50	8.37	3.54	8.11	3.56	7.81	3.39	7.16	3.32
	18	8.57	3.57	8.00	3.54	7.77	3.52	7.66	3.37	7.22	3.32
	20	8.10	3.57	7.71	3.52	7.55	3.50	7.53	3.39	7.12	3.32
	21	7.78	3.58	7.32	3.52	7.14	3.50	7.25	3.40	7.00	3.35
	22	7.61	3.59	7.50	3.52	7.46	3.50	7.41	3.42	6.83	3.35
	24	7.10	3.63	7.36	3.55	7.47	3.52	7.32	3.47	6.38	3.41
7.1 + 7.1	16	9.03	3.49	8.37	3.53	8.11	3.55	7.81	3.38	7.16	3.31
	18	8.57	3.56	8.00	3.52	7.77	3.51	7.66	3.36	7.22	3.31
	20	8.10	3.55	7.71	3.50	7.55	3.48	7.53	3.38	7.12	3.31
	21	7.78	3.56	7.32	3.51	7.14	3.48	7.25	3.39	7.00	3.34
	22	7.61	3.57	7.50	3.51	7.46	3.48	7.41	3.41	6.83	3.34
	24	7.10	3.62	7.36	3.54	7.47	3.51	7.32	3.46	6.38	3.40
1.6 + 1.6 + 1.6	16	8.94	3.73	8.29	3.78	8.03	3.80	7.73	3.62	7.09	3.55
	18	8.49	3.81	7.92	3.77	7.70	3.76	7.59	3.60	7.15	3.54
	20	8.02	3.81	7.63	3.75	7.48	3.73	7.46	3.62	7.05	3.54
	21	7.70	3.82	7.25	3.75	7.07	3.73	7.18	3.63	6.93	3.57
	22	7.53	3.83	7.43	3.76	7.38	3.73	7.34	3.65	6.76	3.57
	24	7.03	3.88	7.29	3.79	7.40	3.76	7.25	3.71	6.32	3.64
1.6 + 1.6 + 2.0	16	8.94	3.65	8.29	3.69	8.03	3.71	7.73	3.53	7.09	3.46
	18	8.49	3.72	7.92	3.68	7.70	3.67	7.59	3.51	7.15	3.46
	20	8.02	3.71	7.63	3.66	7.48	3.64	7.46	3.53	7.05	3.46
	21	7.70	3.72	7.25	3.66	7.07	3.64	7.18	3.54	6.93	3.49
	22	7.53	3.74	7.43	3.67	7.38	3.64	7.34	3.56	6.76	3.49
	24	7.03	3.78	7.29	3.70	7.40	3.67	7.25	3.62	6.32	3.55
1.6 + 1.6 + 2.5	16	8.94	3.65	8.29	3.69	8.03	3.71	7.73	3.53	7.09	3.46
	18	8.49	3.72	7.92	3.68	7.70	3.67	7.59	3.51	7.15	3.46
	20	8.02	3.71	7.63	3.66	7.48	3.64	7.46	3.53	7.05	3.46
	21	7.70	3.72	7.25	3.66	7.07	3.64	7.18	3.54	6.93	3.49
	22	7.53	3.74	7.43	3.67	7.38	3.64	7.34	3.56	6.76	3.49
	24	7.03	3.78	7.29	3.70	7.40	3.67	7.25	3.62	6.32	3.55
1.6 + 1.6 + 3.5	16	8.94	3.61	8.29	3.66	8.03	3.67	7.73	3.50	7.09	3.43
	18	8.49	3.69	7.92	3.65	7.70	3.63	7.59	3.48	7.15	3.42
	20	8.02	3.68	7.63	3.63	7.48	3.61	7.46	3.50	7.05	3.42
	21	7.70	3.69	7.25	3.63	7.07	3.61	7.18	3.51	6.93	3.46
	22	7.53	3.70	7.43	3.63	7.38	3.61	7.34	3.53	6.76	3.46
	24	7.03	3.75	7.29	3.67	7.40	3.63	7.25	3.58	6.32	3.52

Combination (Capacity)	Indoor Air Temp. °C DB	Outdoor Air Temp. °C											
		16/15		15/14		10/9		7/6		6/5		2/1	
		Total Q	Input Power	Total Q	Input Power	Total Q	Input Power	Total Q	Input Power	Total Q	Input Power	Total Q	Input Power
1.6 + 1.6 + 4.2	16	14.98	2.60	14.70	2.66	13.28	2.94	12.43	3.12	11.63	3.25	9.21	3.57
	18	14.27	2.69	13.94	2.74	12.32	3.01	11.34	3.17	10.62	3.32	8.71	3.68
	20	13.81	2.78	13.43	2.83	11.54	3.07	10.40	3.21	9.74	3.35	8.17	3.68
	21	13.64	2.84	13.23	2.87	11.19	3.05	9.97	3.16	9.34	3.31	7.88	3.69
	22	13.52	2.89	13.25	2.93	11.85	3.12	11.01	3.24	10.11	3.38	7.58	3.70
	24	13.44	3.00	12.94	3.03	10.43	3.17	8.93	3.26	8.33	3.41	6.92	3.72
1.6 + 1.6 + 5.0	16	14.98	2.43	14.70	2.48	13.28	2.75	12.43	2.91	11.63	3.04	9.21	3.34
	18	14.27	2.51	13.94	2.56	12.32	2.81	11.34	2.96	10.62	3.10	8.71	3.44
	20	13.81	2.60	13.43	2.65	11.54	2.87	10.40	3.00	9.74	3.13	8.17	3.44
	21	13.64	2.65	13.23	2.68	11.19	2.85	9.97	2.95	9.34	3.09	7.88	3.45
	22	13.52	2.70	13.25	2.74	11.85	2.92	11.01	3.02	10.11	3.15	7.58	3.46
	24	13.44	2.80	12.94	2.83	10.43	2.97	8.93	3.05	8.33	3.18	6.92	3.48
1.6 + 1.6 + 6.0	16	15.12	2.48	14.84	2.53	13.40	2.81	12.55	2.97	11.74	3.10	9.29	3.40
	18	14.40	2.56	14.08	2.62	12.43	2.87	11.45	3.02	10.72	3.16	8.80	3.51
	20	13.94	2.65	13.56	2.70	11.65	2.92	10.50	3.06	9.83	3.19	8.25	3.51
	21	13.77	2.70	13.36	2.74	11.30	2.91	10.07	3.01	9.43	3.15	7.96	3.52
	22	13.65	2.76	13.37	2.79	11.96	2.98	11.12	3.09	10.21	3.22	7.65	3.53
	24	13.57	2.86	13.06	2.89	10.53	3.03	9.02	3.11	8.41	3.25	6.99	3.55
1.6 + 1.6 + 7.1	16	15.12	2.46	14.84	2.51	13.40	2.79	12.55	2.95	11.74	3.08	9.29	3.38
	18	14.40	2.55	14.08	2.60	12.43	2.85	11.45	3.00	10.72	3.14	8.80	3.48
	20	13.94	2.64	13.56	2.68	11.65	2.91	10.50	3.04	9.83	3.17	8.25	3.48
	21	13.77	2.69	13.36	2.72	11.30	2.89	10.07	2.99	9.43	3.13	7.96	3.50
	22	13.65	2.74	13.37	2.77	11.96	2.96	11.12	3.07	10.21	3.20	7.65	3.51
	24	13.57	2.84	13.06	2.87	10.53	3.01	9.02	3.09	8.41	3.23	6.99	3.53
1.6 + 2.0 + 2.0	16	14.98	2.63	14.70	2.69	13.28	2.98	12.43	3.16	11.63	3.29	9.21	3.62
	18	14.27	2.72	13.94	2.78	12.32	3.05	11.34	3.21	10.62	3.36	8.71	3.72
	20	13.81	2.82	13.43	2.87	11.54	3.11	10.40	3.25	9.74	3.39	8.17	3.72
	21	13.64	2.87	13.23	2.91	11.19	3.09	9.97	3.20	9.34	3.35	7.88	3.74
	22	13.52	2.93	13.25	2.97	11.85	3.16	11.01	3.28	10.11	3.42	7.58	3.75
	24	13.44	3.03	12.94	3.06	10.43	3.21	8.93	3.30	8.33	3.45	6.92	3.77
1.6 + 2.0 + 2.5	16	14.98	2.63	14.70	2.69	13.28	2.98	12.43	3.16	11.63	3.29	9.21	3.62
	18	14.27	2.72	13.94	2.78	12.32	3.05	11.34	3.21	10.62	3.36	8.71	3.72
	20	13.81	2.82	13.43	2.87	11.54	3.11	10.40	3.25	9.74	3.39	8.17	3.72
	21	13.64	2.87	13.23	2.91	11.19	3.09	9.97	3.20	9.34	3.35	7.88	3.74
	22	13.52	2.93	13.25	2.97	11.85	3.16	11.01	3.28	10.11	3.42	7.58	3.75
	24	13.44	3.03	12.94	3.06	10.43	3.21	8.93	3.30	8.33	3.45	6.92	3.77

Combination (Capacity)	Indoor Air Temp. °C DB	Outdoor Air Temp. °C									
		0/-1		-5/-6		-7/-8		-10/-11		-15/-	
		Total Q	Input Power	Total Q	Input Power	Total Q	Input Power	Total Q	Input Power	Total Q	Input Power
1.6 + 1.6 + 4.2	16	8.94	3.59	8.29	3.63	8.03	3.65	7.73	3.48	7.09	3.41
	18	8.49	3.66	7.92	3.63	7.70	3.61	7.59	3.46	7.15	3.40
	20	8.02	3.66	7.63	3.61	7.48	3.58	7.46	3.47	7.05	3.40
	21	7.70	3.67	7.25	3.61	7.07	3.58	7.18	3.48	6.93	3.43
	22	7.53	3.68	7.43	3.61	7.38	3.58	7.34	3.50	6.76	3.43
	24	7.03	3.73	7.29	3.64	7.40	3.61	7.25	3.56	6.32	3.50
1.6 + 1.6 + 5.0	16	8.94	3.35	8.29	3.40	8.03	3.41	7.73	3.25	7.09	3.19
	18	8.49	3.42	7.92	3.39	7.70	3.38	7.59	3.23	7.15	3.18
	20	8.02	3.42	7.63	3.37	7.48	3.35	7.46	3.25	7.05	3.18
	21	7.70	3.43	7.25	3.37	7.07	3.35	7.18	3.26	6.93	3.21
	22	7.53	3.44	7.43	3.38	7.38	3.35	7.34	3.28	6.76	3.21
	24	7.03	3.48	7.29	3.41	7.40	3.38	7.25	3.33	6.32	3.27
1.6 + 1.6 + 6.0	16	9.03	3.42	8.37	3.46	8.11	3.48	7.81	3.31	7.16	3.25
	18	8.57	3.49	8.00	3.46	7.77	3.44	7.66	3.29	7.22	3.24
	20	8.10	3.49	7.71	3.44	7.55	3.42	7.53	3.31	7.12	3.24
	21	7.78	3.50	7.32	3.44	7.14	3.42	7.25	3.32	7.00	3.27
	22	7.61	3.51	7.50	3.44	7.46	3.42	7.41	3.34	6.83	3.27
	24	7.10	3.55	7.36	3.47	7.47	3.44	7.32	3.39	6.38	3.34
1.6 + 1.6 + 7.1	16	9.03	3.40	8.37	3.44	8.11	3.46	7.81	3.29	7.16	3.23
	18	8.57	3.47	8.00	3.43	7.77	3.42	7.66	3.27	7.22	3.22
	20	8.10	3.46	7.71	3.41	7.55	3.39	7.53	3.29	7.12	3.22
	21	7.78	3.47	7.32	3.42	7.14	3.39	7.25	3.30	7.00	3.25
	22	7.61	3.48	7.50	3.42	7.46	3.39	7.41	3.32	6.83	3.25
	24	7.10	3.53	7.36	3.45	7.47	3.42	7.32	3.37	6.38	3.31
1.6 + 2.0 + 2.0	16	8.94	3.63	8.29	3.68	8.03	3.70	7.73	3.52	7.09	3.45
	18	8.49	3.71	7.92	3.67	7.70	3.66	7.59	3.50	7.15	3.45
	20	8.02	3.70	7.63	3.65	7.48	3.63	7.46	3.52	7.05	3.45
	21	7.70	3.71	7.25	3.65	7.07	3.63	7.18	3.53	6.93	3.48
	22	7.53	3.72	7.43	3.66	7.38	3.63	7.34	3.55	6.76	3.48
	24	7.03	3.77	7.29	3.69	7.40	3.66	7.25	3.61	6.32	3.54
1.6 + 2.0 + 2.5	16	8.94	3.63	8.29	3.68	8.03	3.70	7.73	3.52	7.09	3.45
	18	8.49	3.71	7.92	3.67	7.70	3.66	7.59	3.50	7.15	3.45
	20	8.02	3.70	7.63	3.65	7.48	3.63	7.46	3.52	7.05	3.45
	21	7.70	3.71	7.25	3.65	7.07	3.63	7.18	3.53	6.93	3.48
	22	7.53	3.72	7.43	3.66	7.38	3.63	7.34	3.55	6.76	3.48
	24	7.03	3.77	7.29	3.69	7.40	3.66	7.25	3.61	6.32	3.54

Combination (Capacity)	Indoor Air Temp. °C DB	Outdoor Air Temp. °C											
		16/15		15/14		10/9		7/6		6/5		2/1	
		Total Q	Input Power	Total Q	Input Power	Total Q	Input Power	Total Q	Input Power	Total Q	Input Power	Total Q	Input Power
1.6 + 2.0 + 3.5	16	14.98	2.60	14.70	2.66	13.28	2.94	12.43	3.12	11.63	3.25	9.21	3.57
	18	14.27	2.69	13.94	2.74	12.32	3.01	11.34	3.17	10.62	3.32	8.71	3.68
	20	13.81	2.78	13.43	2.83	11.54	3.07	10.40	3.21	9.74	3.35	8.17	3.68
	21	13.64	2.84	13.23	2.87	11.19	3.05	9.97	3.16	9.34	3.31	7.88	3.69
	22	13.52	2.89	13.25	2.93	11.85	3.12	11.01	3.24	10.11	3.38	7.58	3.70
	24	13.44	3.00	12.94	3.03	10.43	3.17	8.93	3.26	8.33	3.41	6.92	3.72
1.6 + 2.0 + 4.2	16	14.98	2.59	14.70	2.65	13.28	2.93	12.43	3.11	11.63	3.24	9.21	3.56
	18	14.27	2.68	13.94	2.74	12.32	3.00	11.34	3.16	10.62	3.31	8.71	3.67
	20	13.81	2.78	13.43	2.82	11.54	3.06	10.40	3.20	9.74	3.34	8.17	3.67
	21	13.64	2.83	13.23	2.86	11.19	3.04	9.97	3.15	9.34	3.30	7.88	3.68
	22	13.52	2.88	13.25	2.92	11.85	3.11	11.01	3.23	10.11	3.36	7.58	3.69
	24	13.44	2.99	12.94	3.02	10.43	3.16	8.93	3.25	8.33	3.40	6.92	3.71
1.6 + 2.0 + 5.0	16	15.12	2.47	14.84	2.52	13.40	2.80	12.55	2.96	11.74	3.09	9.29	3.39
	18	14.40	2.56	14.08	2.61	12.43	2.86	11.45	3.01	10.72	3.15	8.80	3.49
	20	13.94	2.65	13.56	2.69	11.65	2.92	10.50	3.05	9.83	3.18	8.25	3.49
	21	13.77	2.70	13.36	2.73	11.30	2.90	10.07	3.00	9.43	3.14	7.96	3.51
	22	13.65	2.75	13.37	2.78	11.96	2.97	11.12	3.08	10.21	3.21	7.65	3.52
	24	13.57	2.85	13.06	2.88	10.53	3.02	9.02	3.10	8.41	3.24	6.99	3.54
1.6 + 2.0 + 6.0	16	15.12	2.47	14.84	2.52	13.40	2.80	12.55	2.96	11.74	3.09	9.29	3.39
	18	14.40	2.56	14.08	2.61	12.43	2.86	11.45	3.01	10.72	3.15	8.80	3.49
	20	13.94	2.65	13.56	2.69	11.65	2.92	10.50	3.05	9.83	3.18	8.25	3.49
	21	13.77	2.70	13.36	2.73	11.30	2.90	10.07	3.00	9.43	3.14	7.96	3.51
	22	13.65	2.75	13.37	2.78	11.96	2.97	11.12	3.08	10.21	3.21	7.65	3.52
	24	13.57	2.85	13.06	2.88	10.53	3.02	9.02	3.10	8.41	3.24	6.99	3.54
1.6 + 2.0 + 7.1	16	15.12	2.45	14.84	2.51	13.40	2.78	12.55	2.94	11.74	3.07	9.29	3.37
	18	14.40	2.54	14.08	2.59	12.43	2.84	11.45	2.99	10.72	3.13	8.80	3.47
	20	13.94	2.63	13.56	2.67	11.65	2.90	10.50	3.03	9.83	3.16	8.25	3.47
	21	13.77	2.68	13.36	2.71	11.30	2.88	10.07	2.98	9.43	3.12	7.96	3.48
	22	13.65	2.73	13.37	2.76	11.96	2.95	11.12	3.06	10.21	3.19	7.65	3.50
	24	13.57	2.83	13.06	2.86	10.53	3.00	9.02	3.08	8.41	3.22	6.99	3.51
1.6 + 2.5 + 2.5	16	14.98	2.63	14.70	2.69	13.28	2.98	12.43	3.16	11.63	3.29	9.21	3.62
	18	14.27	2.72	13.94	2.78	12.32	3.05	11.34	3.21	10.62	3.36	8.71	3.72
	20	13.81	2.82	13.43	2.87	11.54	3.11	10.40	3.25	9.74	3.39	8.17	3.72
	21	13.64	2.87	13.23	2.91	11.19	3.09	9.97	3.20	9.34	3.35	7.88	3.74
	22	13.52	2.93	13.25	2.97	11.85	3.16	11.01	3.28	10.11	3.42	7.58	3.75
	24	13.44	3.03	12.94	3.06	10.43	3.21	8.93	3.30	8.33	3.45	6.92	3.77



Combination (Capacity)	Indoor Air Temp. °C DB	Outdoor Air Temp. °C									
		0/-1		-5/-6		-7/-8		-10/-11		-15/-	
		Total Q	Input Power	Total Q	Input Power	Total Q	Input Power	Total Q	Input Power	Total Q	Input Power
1.6 + 2.0 + 3.5	16	8.94	3.59	8.29	3.63	8.03	3.65	7.73	3.48	7.09	3.41
	18	8.49	3.66	7.92	3.63	7.70	3.61	7.59	3.46	7.15	3.40
	20	8.02	3.66	7.63	3.61	7.48	3.58	7.46	3.47	7.05	3.40
	21	7.70	3.67	7.25	3.61	7.07	3.58	7.18	3.48	6.93	3.43
	22	7.53	3.68	7.43	3.61	7.38	3.58	7.34	3.50	6.76	3.43
	24	7.03	3.73	7.29	3.64	7.40	3.61	7.25	3.56	6.32	3.50
1.6 + 2.0 + 4.2	16	8.94	3.58	8.29	3.62	8.03	3.64	7.73	3.47	7.09	3.40
	18	8.49	3.65	7.92	3.61	7.70	3.60	7.59	3.45	7.15	3.39
	20	8.02	3.65	7.63	3.59	7.48	3.57	7.46	3.46	7.05	3.39
	21	7.70	3.66	7.25	3.60	7.07	3.57	7.18	3.47	6.93	3.42
	22	7.53	3.67	7.43	3.60	7.38	3.57	7.34	3.49	6.76	3.42
	24	7.03	3.71	7.29	3.63	7.40	3.60	7.25	3.55	6.32	3.49
1.6 + 2.0 + 5.0	16	9.03	3.41	8.37	3.45	8.11	3.47	7.81	3.30	7.16	3.24
	18	8.57	3.48	8.00	3.45	7.77	3.43	7.66	3.28	7.22	3.23
	20	8.10	3.47	7.71	3.43	7.55	3.41	7.53	3.30	7.12	3.23
	21	7.78	3.48	7.32	3.43	7.14	3.41	7.25	3.31	7.00	3.26
	22	7.61	3.49	7.50	3.43	7.46	3.41	7.41	3.33	6.83	3.26
	24	7.10	3.54	7.36	3.46	7.47	3.43	7.32	3.38	6.38	3.32
1.6 + 2.0 + 6.0	16	9.03	3.41	8.37	3.45	8.11	3.47	7.81	3.30	7.16	3.24
	18	8.57	3.48	8.00	3.45	7.77	3.43	7.66	3.28	7.22	3.23
	20	8.10	3.47	7.71	3.43	7.55	3.41	7.53	3.30	7.12	3.23
	21	7.78	3.48	7.32	3.43	7.14	3.41	7.25	3.31	7.00	3.26
	22	7.61	3.49	7.50	3.43	7.46	3.41	7.41	3.33	6.83	3.26
	24	7.10	3.54	7.36	3.46	7.47	3.43	7.32	3.38	6.38	3.32
1.6 + 2.0 + 7.1	16	9.03	3.39	8.37	3.43	8.11	3.45	7.81	3.28	7.16	3.22
	18	8.57	3.46	8.00	3.42	7.77	3.41	7.66	3.26	7.22	3.21
	20	8.10	3.45	7.71	3.40	7.55	3.38	7.53	3.28	7.12	3.21
	21	7.78	3.46	7.32	3.41	7.14	3.38	7.25	3.29	7.00	3.24
	22	7.61	3.47	7.50	3.41	7.46	3.38	7.41	3.31	6.83	3.24
	24	7.10	3.52	7.36	3.44	7.47	3.41	7.32	3.36	6.38	3.30
1.6 + 2.5 + 2.5	16	8.94	3.63	8.29	3.68	8.03	3.70	7.73	3.52	7.09	3.45
	18	8.49	3.71	7.92	3.67	7.70	3.66	7.59	3.50	7.15	3.45
	20	8.02	3.70	7.63	3.65	7.48	3.63	7.46	3.52	7.05	3.45
	21	7.70	3.71	7.25	3.65	7.07	3.63	7.18	3.53	6.93	3.48
	22	7.53	3.72	7.43	3.66	7.38	3.63	7.34	3.55	6.76	3.48
	24	7.03	3.77	7.29	3.69	7.40	3.66	7.25	3.61	6.32	3.54

Combination (Capacity)	Indoor Air Temp. °C DB	Outdoor Air Temp. °C											
		16/15		15/14		10/9		7/6		6/5		2/1	
		Total Q	Input Power	Total Q	Input Power	Total Q	Input Power	Total Q	Input Power	Total Q	Input Power	Total Q	Input Power
1.6 + 2.5 + 3.5	16	14.98	2.60	14.70	2.66	13.28	2.94	12.43	3.12	11.63	3.25	9.21	3.57
	18	14.27	2.69	13.94	2.74	12.32	3.01	11.34	3.17	10.62	3.32	8.71	3.68
	20	13.81	2.78	13.43	2.83	11.54	3.07	10.40	3.21	9.74	3.35	8.17	3.68
	21	13.64	2.84	13.23	2.87	11.19	3.05	9.97	3.16	9.34	3.31	7.88	3.69
	22	13.52	2.89	13.25	2.93	11.85	3.12	11.01	3.24	10.11	3.38	7.58	3.70
	24	13.44	3.00	12.94	3.03	10.43	3.17	8.93	3.26	8.33	3.41	6.92	3.72
1.6 + 2.5 + 4.2	16	14.98	2.59	14.70	2.65	13.28	2.93	12.43	3.11	11.63	3.24	9.21	3.56
	18	14.27	2.68	13.94	2.74	12.32	3.00	11.34	3.16	10.62	3.31	8.71	3.67
	20	13.81	2.78	13.43	2.82	11.54	3.06	10.40	3.20	9.74	3.34	8.17	3.67
	21	13.64	2.83	13.23	2.86	11.19	3.04	9.97	3.15	9.34	3.30	7.88	3.68
	22	13.52	2.88	13.25	2.92	11.85	3.11	11.01	3.23	10.11	3.36	7.58	3.69
	24	13.44	2.99	12.94	3.02	10.43	3.16	8.93	3.25	8.33	3.40	6.92	3.71
1.6 + 2.5 + 5.0	16	15.12	2.47	14.84	2.52	13.40	2.80	12.55	2.96	11.74	3.09	9.29	3.39
	18	14.40	2.56	14.08	2.61	12.43	2.86	11.45	3.01	10.72	3.15	8.80	3.49
	20	13.94	2.65	13.56	2.69	11.65	2.92	10.50	3.05	9.83	3.18	8.25	3.49
	21	13.77	2.70	13.36	2.73	11.30	2.90	10.07	3.00	9.43	3.14	7.96	3.51
	22	13.65	2.75	13.37	2.78	11.96	2.97	11.12	3.08	10.21	3.21	7.65	3.52
	24	13.57	2.85	13.06	2.88	10.53	3.02	9.02	3.10	8.41	3.24	6.99	3.54
1.6 + 2.5 + 6.0	16	15.12	2.47	14.84	2.52	13.40	2.80	12.55	2.96	11.74	3.09	9.29	3.39
	18	14.40	2.56	14.08	2.61	12.43	2.86	11.45	3.01	10.72	3.15	8.80	3.49
	20	13.94	2.65	13.56	2.69	11.65	2.92	10.50	3.05	9.83	3.18	8.25	3.49
	21	13.77	2.70	13.36	2.73	11.30	2.90	10.07	3.00	9.43	3.14	7.96	3.51
	22	13.65	2.75	13.37	2.78	11.96	2.97	11.12	3.08	10.21	3.21	7.65	3.52
	24	13.57	2.85	13.06	2.88	10.53	3.02	9.02	3.10	8.41	3.24	6.99	3.54
1.6 + 2.5 + 7.1	16	15.27	2.50	14.98	2.56	13.53	2.83	12.66	3.00	11.85	3.13	9.38	3.44
	18	14.54	2.59	14.21	2.64	12.55	2.90	11.56	3.05	10.83	3.19	8.88	3.54
	20	14.08	2.68	13.69	2.73	11.76	2.95	10.60	3.09	9.93	3.22	8.33	3.54
	21	13.90	2.73	13.49	2.77	11.41	2.94	10.16	3.04	9.52	3.19	8.04	3.55
	22	13.78	2.78	13.50	2.82	12.08	3.00	11.23	3.12	10.30	3.25	7.72	3.57
	24	13.70	2.88	13.19	2.91	10.63	3.06	9.10	3.14	8.49	3.28	7.06	3.58
1.6 + 3.5 + 3.5	16	15.12	2.62	14.84	2.68	13.40	2.97	12.55	3.15	11.74	3.28	9.29	3.60
	18	14.40	2.72	14.08	2.77	12.43	3.04	11.45	3.20	10.72	3.35	8.80	3.71
	20	13.94	2.81	13.56	2.86	11.65	3.10	10.50	3.24	9.83	3.38	8.25	3.71
	21	13.77	2.86	13.36	2.90	11.30	3.08	10.07	3.19	9.43	3.34	7.96	3.73
	22	13.65	2.92	13.37	2.96	11.96	3.15	11.12	3.27	10.21	3.41	7.65	3.74
	24	13.57	3.02	13.06	3.05	10.53	3.20	9.02	3.29	8.41	3.44	6.99	3.76

Combination (Capacity)	Indoor Air Temp. °C DB	Outdoor Air Temp. °C									
		0/-1		-5/-6		-7/-8		-10/-11		-15/-	
		Total Q	Input Power	Total Q	Input Power	Total Q	Input Power	Total Q	Input Power	Total Q	Input Power
1.6 + 2.5 + 3.5	16	8.94	3.59	8.29	3.63	8.03	3.65	7.73	3.48	7.09	3.41
	18	8.49	3.66	7.92	3.63	7.70	3.61	7.59	3.46	7.15	3.40
	20	8.02	3.66	7.63	3.61	7.48	3.58	7.46	3.47	7.05	3.40
	21	7.70	3.67	7.25	3.61	7.07	3.58	7.18	3.48	6.93	3.43
	22	7.53	3.68	7.43	3.61	7.38	3.58	7.34	3.50	6.76	3.43
	24	7.03	3.73	7.29	3.64	7.40	3.61	7.25	3.56	6.32	3.50
1.6 + 2.5 + 4.2	16	8.94	3.58	8.29	3.62	8.03	3.64	7.73	3.47	7.09	3.40
	18	8.49	3.65	7.92	3.61	7.70	3.60	7.59	3.45	7.15	3.39
	20	8.02	3.65	7.63	3.59	7.48	3.57	7.46	3.46	7.05	3.39
	21	7.70	3.66	7.25	3.60	7.07	3.57	7.18	3.47	6.93	3.42
	22	7.53	3.67	7.43	3.60	7.38	3.57	7.34	3.49	6.76	3.42
	24	7.03	3.71	7.29	3.63	7.40	3.60	7.25	3.55	6.32	3.49
1.6 + 2.5 + 5.0	16	9.03	3.41	8.37	3.45	8.11	3.47	7.81	3.30	7.16	3.24
	18	8.57	3.48	8.00	3.45	7.77	3.43	7.66	3.28	7.22	3.23
	20	8.10	3.47	7.71	3.43	7.55	3.41	7.53	3.30	7.12	3.23
	21	7.78	3.48	7.32	3.43	7.14	3.41	7.25	3.31	7.00	3.26
	22	7.61	3.49	7.50	3.43	7.46	3.41	7.41	3.33	6.83	3.26
	24	7.10	3.54	7.36	3.46	7.47	3.43	7.32	3.38	6.38	3.32
1.6 + 2.5 + 6.0	16	9.03	3.41	8.37	3.45	8.11	3.47	7.81	3.30	7.16	3.24
	18	8.57	3.48	8.00	3.45	7.77	3.43	7.66	3.28	7.22	3.23
	20	8.10	3.47	7.71	3.43	7.55	3.41	7.53	3.30	7.12	3.23
	21	7.78	3.48	7.32	3.43	7.14	3.41	7.25	3.31	7.00	3.26
	22	7.61	3.49	7.50	3.43	7.46	3.41	7.41	3.33	6.83	3.26
	24	7.10	3.54	7.36	3.46	7.47	3.43	7.32	3.38	6.38	3.32
1.6 + 2.5 + 7.1	16	9.12	3.45	8.45	3.50	8.19	3.51	7.88	3.35	7.23	3.28
	18	8.65	3.53	8.08	3.49	7.85	3.48	7.73	3.33	7.28	3.28
	20	8.17	3.52	7.78	3.47	7.62	3.45	7.60	3.34	7.18	3.28
	21	7.85	3.53	7.39	3.47	7.21	3.45	7.32	3.35	7.07	3.31
	22	7.68	3.54	7.57	3.48	7.53	3.45	7.48	3.37	6.89	3.31
	24	7.16	3.59	7.43	3.51	7.54	3.48	7.39	3.43	6.44	3.37
1.6 + 3.5 + 3.5	16	9.03	3.62	8.37	3.67	8.11	3.69	7.81	3.51	7.16	3.44
	18	8.57	3.70	8.00	3.66	7.77	3.65	7.66	3.49	7.22	3.43
	20	8.10	3.69	7.71	3.64	7.55	3.62	7.53	3.51	7.12	3.43
	21	7.78	3.70	7.32	3.64	7.14	3.62	7.25	3.52	7.00	3.47
	22	7.61	3.71	7.50	3.65	7.46	3.62	7.41	3.54	6.83	3.47
	24	7.10	3.76	7.36	3.68	7.47	3.65	7.32	3.59	6.38	3.53

Combination (Capacity)	Indoor Air Temp. °C DB	Outdoor Air Temp. °C											
		16/15		15/14		10/9		7/6		6/5		2/1	
		Total Q	Input Power	Total Q	Input Power	Total Q	Input Power	Total Q	Input Power	Total Q	Input Power	Total Q	Input Power
1.6 + 3.5 + 4.2	16	15.12	2.56	14.84	2.61	13.40	2.90	12.55	3.07	11.74	3.20	9.29	3.52
	18	14.40	2.65	14.08	2.70	12.43	2.96	11.45	3.12	10.72	3.26	8.80	3.62
	20	13.94	2.74	13.56	2.79	11.65	3.02	10.50	3.16	9.83	3.30	8.25	3.62
	21	13.77	2.79	13.36	2.83	11.30	3.00	10.07	3.11	9.43	3.26	7.96	3.63
	22	13.65	2.85	13.37	2.88	11.96	3.07	11.12	3.19	10.21	3.32	7.65	3.65
	24	13.57	2.95	13.06	2.98	10.53	3.13	9.02	3.21	8.41	3.35	6.99	3.67
1.6 + 3.5 + 5.0	16	15.12	2.44	14.84	2.49	13.40	2.76	12.55	2.92	11.74	3.05	9.29	3.35
	18	14.40	2.52	14.08	2.57	12.43	2.82	11.45	2.97	10.72	3.11	8.80	3.45
	20	13.94	2.61	13.56	2.65	11.65	2.88	10.50	3.01	9.83	3.14	8.25	3.45
	21	13.77	2.66	13.36	2.69	11.30	2.86	10.07	2.96	9.43	3.10	7.96	3.46
	22	13.65	2.71	13.37	2.75	11.96	2.93	11.12	3.03	10.21	3.16	7.65	3.47
	24	13.57	2.81	13.06	2.84	10.53	2.98	9.02	3.06	8.41	3.19	6.99	3.49
1.6 + 3.5 + 6.0	16	15.27	2.48	14.98	2.54	13.53	2.82	12.66	2.98	11.85	3.11	9.38	3.42
	18	14.54	2.57	14.21	2.62	12.55	2.88	11.56	3.03	10.83	3.17	8.88	3.52
	20	14.08	2.66	13.69	2.71	11.76	2.93	10.60	3.07	9.93	3.20	8.33	3.52
	21	13.90	2.71	13.49	2.75	11.41	2.92	10.16	3.02	9.52	3.16	8.04	3.53
	22	13.78	2.76	13.50	2.80	12.08	2.99	11.23	3.10	10.30	3.23	7.72	3.54
	24	13.70	2.87	13.19	2.89	10.63	3.04	9.10	3.12	8.49	3.26	7.06	3.56
1.6 + 3.5 + 7.1	16	15.27	2.48	14.98	2.53	13.53	2.81	12.66	2.97	11.85	3.10	9.38	3.40
	18	14.54	2.56	14.21	2.62	12.55	2.87	11.56	3.02	10.83	3.16	8.88	3.51
	20	14.08	2.65	13.69	2.70	11.76	2.92	10.60	3.06	9.93	3.19	8.33	3.51
	21	13.90	2.70	13.49	2.74	11.41	2.91	10.16	3.01	9.52	3.15	8.04	3.52
	22	13.78	2.76	13.50	2.79	12.08	2.98	11.23	3.09	10.30	3.22	7.72	3.53
	24	13.70	2.86	13.19	2.89	10.63	3.03	9.10	3.11	8.49	3.25	7.06	3.55
1.6 + 4.2 + 4.2	16	15.12	2.55	14.84	2.61	13.40	2.89	12.55	3.06	11.74	3.19	9.29	3.50
	18	14.40	2.64	14.08	2.69	12.43	2.95	11.45	3.11	10.72	3.25	8.80	3.61
	20	13.94	2.73	13.56	2.78	11.65	3.01	10.50	3.15	9.83	3.29	8.25	3.61
	21	13.77	2.78	13.36	2.82	11.30	2.99	10.07	3.10	9.43	3.25	7.96	3.62
	22	13.65	2.84	13.37	2.87	11.96	3.06	11.12	3.18	10.21	3.31	7.65	3.64
	24	13.57	2.94	13.06	2.97	10.53	3.12	9.02	3.20	8.41	3.34	6.99	3.65
1.6 + 4.2 + 5.0	16	15.12	2.43	14.84	2.48	13.40	2.75	12.55	2.91	11.74	3.04	9.29	3.34
	18	14.40	2.51	14.08	2.56	12.43	2.81	11.45	2.96	10.72	3.10	8.80	3.44
	20	13.94	2.60	13.56	2.65	11.65	2.87	10.50	3.00	9.83	3.13	8.25	3.44
	21	13.77	2.65	13.36	2.68	11.30	2.85	10.07	2.95	9.43	3.09	7.96	3.45
	22	13.65	2.70	13.37	2.74	11.96	2.92	11.12	3.02	10.21	3.15	7.65	3.46
	24	13.57	2.80	13.06	2.83	10.53	2.97	9.02	3.05	8.41	3.18	6.99	3.48

Combination (Capacity)	Indoor Air Temp. °C DB	Outdoor Air Temp. °C									
		0/-1		-5/-6		-7/-8		-10/-11		-15/-	
		Total Q	Input Power	Total Q	Input Power	Total Q	Input Power	Total Q	Input Power	Total Q	Input Power
1.6 + 3.5 + 4.2	16	9.03	3.53	8.37	3.58	8.11	3.59	7.81	3.42	7.16	3.36
	18	8.57	3.61	8.00	3.57	7.77	3.56	7.66	3.40	7.22	3.35
	20	8.10	3.60	7.71	3.55	7.55	3.53	7.53	3.42	7.12	3.35
	21	7.78	3.61	7.32	3.55	7.14	3.53	7.25	3.43	7.00	3.38
	22	7.61	3.62	7.50	3.56	7.46	3.53	7.41	3.45	6.83	3.38
	24	7.10	3.67	7.36	3.59	7.47	3.56	7.32	3.51	6.38	3.44
1.6 + 3.5 + 5.0	16	9.03	3.37	8.37	3.41	8.11	3.42	7.81	3.26	7.16	3.20
	18	8.57	3.43	8.00	3.40	7.77	3.39	7.66	3.24	7.22	3.19
	20	8.10	3.43	7.71	3.38	7.55	3.36	7.53	3.26	7.12	3.19
	21	7.78	3.44	7.32	3.38	7.14	3.36	7.25	3.27	7.00	3.22
	22	7.61	3.45	7.50	3.39	7.46	3.36	7.41	3.29	6.83	3.22
	24	7.10	3.49	7.36	3.42	7.47	3.39	7.32	3.34	6.38	3.28
1.6 + 3.5 + 6.0	16	9.12	3.43	8.45	3.48	8.19	3.49	7.88	3.32	7.23	3.26
	18	8.65	3.50	8.08	3.47	7.85	3.45	7.73	3.31	7.28	3.25
	20	8.17	3.50	7.78	3.45	7.62	3.43	7.60	3.32	7.18	3.25
	21	7.85	3.51	7.39	3.45	7.21	3.43	7.32	3.33	7.07	3.28
	22	7.68	3.52	7.57	3.45	7.53	3.43	7.48	3.35	6.89	3.28
	24	7.16	3.56	7.43	3.48	7.54	3.45	7.39	3.41	6.44	3.35
1.6 + 3.5 + 7.1	16	9.12	3.42	8.45	3.46	8.19	3.48	7.88	3.31	7.23	3.25
	18	8.65	3.49	8.08	3.46	7.85	3.44	7.73	3.29	7.28	3.24
	20	8.17	3.49	7.78	3.44	7.62	3.42	7.60	3.31	7.18	3.24
	21	7.85	3.50	7.39	3.44	7.21	3.42	7.32	3.32	7.07	3.27
	22	7.68	3.51	7.57	3.44	7.53	3.42	7.48	3.34	6.89	3.27
	24	7.16	3.55	7.43	3.47	7.54	3.44	7.39	3.39	6.44	3.34
1.6 + 4.2 + 4.2	16	9.03	3.52	8.37	3.57	8.11	3.58	7.81	3.41	7.16	3.35
	18	8.57	3.59	8.00	3.56	7.77	3.54	7.66	3.39	7.22	3.34
	20	8.10	3.59	7.71	3.54	7.55	3.52	7.53	3.41	7.12	3.34
	21	7.78	3.60	7.32	3.54	7.14	3.52	7.25	3.42	7.00	3.37
	22	7.61	3.61	7.50	3.54	7.46	3.52	7.41	3.44	6.83	3.37
	24	7.10	3.66	7.36	3.58	7.47	3.54	7.32	3.49	6.38	3.43
1.6 + 4.2 + 5.0	16	9.03	3.35	8.37	3.40	8.11	3.41	7.81	3.25	7.16	3.19
	18	8.57	3.42	8.00	3.39	7.77	3.38	7.66	3.23	7.22	3.18
	20	8.10	3.42	7.71	3.37	7.55	3.35	7.53	3.25	7.12	3.18
	21	7.78	3.43	7.32	3.37	7.14	3.35	7.25	3.26	7.00	3.21
	22	7.61	3.44	7.50	3.38	7.46	3.35	7.41	3.28	6.83	3.21
	24	7.10	3.48	7.36	3.41	7.47	3.38	7.32	3.33	6.38	3.27

Combination (Capacity)	Indoor Air Temp. °C DB	Outdoor Air Temp. °C											
		16/15		15/14		10/9		7/6		6/5		2/1	
		Total Q	Input Power	Total Q	Input Power	Total Q	Input Power	Total Q	Input Power	Total Q	Input Power	Total Q	Input Power
1.6 + 4.2 + 6.0	16	15.27	2.48	14.98	2.53	13.53	2.81	12.66	2.97	11.85	3.10	9.38	3.40
	18	14.54	2.56	14.21	2.62	12.55	2.87	11.56	3.02	10.83	3.16	8.88	3.51
	20	14.08	2.65	13.69	2.70	11.76	2.92	10.60	3.06	9.93	3.19	8.33	3.51
	21	13.90	2.70	13.49	2.74	11.41	2.91	10.16	3.01	9.52	3.15	8.04	3.52
	22	13.78	2.76	13.50	2.79	12.08	2.98	11.23	3.09	10.30	3.22	7.72	3.53
	24	13.70	2.86	13.19	2.89	10.63	3.03	9.10	3.11	8.49	3.25	7.06	3.55
1.6 + 4.2 + 7.1	16	15.27	2.46	14.98	2.51	13.53	2.79	12.66	2.95	11.85	3.08	9.38	3.38
	18	14.54	2.55	14.21	2.60	12.55	2.85	11.56	3.00	10.83	3.14	8.88	3.48
	20	14.08	2.64	13.69	2.68	11.76	2.91	10.60	3.04	9.93	3.17	8.33	3.48
	21	13.90	2.69	13.49	2.72	11.41	2.89	10.16	2.99	9.52	3.13	8.04	3.50
	22	13.78	2.74	13.50	2.77	12.08	2.96	11.23	3.07	10.30	3.20	7.72	3.51
	24	13.70	2.84	13.19	2.87	10.63	3.01	9.10	3.09	8.49	3.23	7.06	3.53
1.6 + 5.0 + 5.0	16	15.27	2.37	14.98	2.42	13.53	2.69	12.66	2.84	11.85	2.97	9.38	3.26
	18	14.54	2.46	14.21	2.50	12.55	2.75	11.56	2.89	10.83	3.03	8.88	3.36
	20	14.08	2.54	13.69	2.58	11.76	2.80	10.60	2.93	9.93	3.06	8.33	3.36
	21	13.90	2.59	13.49	2.62	11.41	2.78	10.16	2.88	9.52	3.02	8.04	3.37
	22	13.78	2.64	13.50	2.67	12.08	2.85	11.23	2.95	10.30	3.08	7.72	3.38
	24	13.70	2.74	13.19	2.76	10.63	2.90	9.10	2.98	8.49	3.11	7.06	3.40
1.6 + 5.0 + 6.0	16	15.27	2.37	14.98	2.42	13.53	2.69	12.66	2.84	11.85	2.97	9.38	3.26
	18	14.54	2.46	14.21	2.50	12.55	2.75	11.56	2.89	10.83	3.03	8.88	3.36
	20	14.08	2.54	13.69	2.58	11.76	2.80	10.60	2.93	9.93	3.06	8.33	3.36
	21	13.90	2.59	13.49	2.62	11.41	2.78	10.16	2.88	9.52	3.02	8.04	3.37
	22	13.78	2.64	13.50	2.67	12.08	2.85	11.23	2.95	10.30	3.08	7.72	3.38
	24	13.70	2.74	13.19	2.76	10.63	2.90	9.10	2.98	8.49	3.11	7.06	3.40
1.6 + 5.0 + 7.1	16	15.27	2.36	14.98	2.42	13.53	2.68	12.66	2.84	11.85	2.96	9.38	3.25
	18	14.54	2.45	14.21	2.50	12.55	2.74	11.56	2.88	10.83	3.02	8.88	3.35
	20	14.08	2.53	13.69	2.58	11.76	2.79	10.60	2.92	9.93	3.05	8.33	3.35
	21	13.90	2.58	13.49	2.61	11.41	2.78	10.16	2.87	9.52	3.01	8.04	3.36
	22	13.78	2.63	13.50	2.66	12.08	2.84	11.23	2.94	10.30	3.07	7.72	3.37
	24	13.70	2.73	13.19	2.75	10.63	2.89	9.10	2.97	8.49	3.10	7.06	3.39
1.6 + 6.0 + 6.0	16	15.27	2.37	14.98	2.42	13.53	2.69	12.66	2.84	11.85	2.97	9.38	3.26
	18	14.54	2.46	14.21	2.50	12.55	2.75	11.56	2.89	10.83	3.03	8.88	3.36
	20	14.08	2.54	13.69	2.58	11.76	2.80	10.60	2.93	9.93	3.06	8.33	3.36
	21	13.90	2.59	13.49	2.62	11.41	2.78	10.16	2.88	9.52	3.02	8.04	3.37
	22	13.78	2.64	13.50	2.67	12.08	2.85	11.23	2.95	10.30	3.08	7.72	3.38
	24	13.70	2.74	13.19	2.76	10.63	2.90	9.10	2.98	8.49	3.11	7.06	3.40

Combination (Capacity)	Indoor Air Temp. °C DB	Outdoor Air Temp. °C									
		0/-1		-5/-6		-7/-8		-10/-11		-15/-	
		Total Q	Input Power	Total Q	Input Power	Total Q	Input Power	Total Q	Input Power	Total Q	Input Power
1.6 + 4.2 + 6.0	16	9.12	3.42	8.45	3.46	8.19	3.48	7.88	3.31	7.23	3.25
	18	8.65	3.49	8.08	3.46	7.85	3.44	7.73	3.29	7.28	3.24
	20	8.17	3.49	7.78	3.44	7.62	3.42	7.60	3.31	7.18	3.24
	21	7.85	3.50	7.39	3.44	7.21	3.42	7.32	3.32	7.07	3.27
	22	7.68	3.51	7.57	3.44	7.53	3.42	7.48	3.34	6.89	3.27
	24	7.16	3.55	7.43	3.47	7.54	3.44	7.39	3.39	6.44	3.34
1.6 + 4.2 + 7.1	16	9.12	3.40	8.45	3.44	8.19	3.46	7.88	3.29	7.23	3.23
	18	8.65	3.47	8.08	3.43	7.85	3.42	7.73	3.27	7.28	3.22
	20	8.17	3.46	7.78	3.41	7.62	3.39	7.60	3.29	7.18	3.22
	21	7.85	3.47	7.39	3.42	7.21	3.39	7.32	3.30	7.07	3.25
	22	7.68	3.48	7.57	3.42	7.53	3.39	7.48	3.32	6.89	3.25
	24	7.16	3.53	7.43	3.45	7.54	3.42	7.39	3.37	6.44	3.31
1.6 + 5.0 + 5.0	16	9.12	3.28	8.45	3.32	8.19	3.33	7.88	3.17	7.23	3.11
	18	8.65	3.34	8.08	3.31	7.85	3.30	7.73	3.15	7.28	3.11
	20	8.17	3.34	7.78	3.29	7.62	3.27	7.60	3.17	7.18	3.11
	21	7.85	3.35	7.39	3.29	7.21	3.27	7.32	3.18	7.07	3.14
	22	7.68	3.36	7.57	3.30	7.53	3.27	7.48	3.20	6.89	3.14
	24	7.16	3.40	7.43	3.33	7.54	3.30	7.39	3.25	6.44	3.19
1.6 + 5.0 + 6.0	16	9.12	3.28	8.45	3.32	8.19	3.33	7.88	3.17	7.23	3.11
	18	8.65	3.34	8.08	3.31	7.85	3.30	7.73	3.15	7.28	3.11
	20	8.17	3.34	7.78	3.29	7.62	3.27	7.60	3.17	7.18	3.11
	21	7.85	3.35	7.39	3.29	7.21	3.27	7.32	3.18	7.07	3.14
	22	7.68	3.36	7.57	3.30	7.53	3.27	7.48	3.20	6.89	3.14
	24	7.16	3.40	7.43	3.33	7.54	3.30	7.39	3.25	6.44	3.19
1.6 + 5.0 + 7.1	16	9.12	3.26	8.45	3.31	8.19	3.32	7.88	3.16	7.23	3.10
	18	8.65	3.33	8.08	3.30	7.85	3.29	7.73	3.14	7.28	3.10
	20	8.17	3.33	7.78	3.28	7.62	3.26	7.60	3.16	7.18	3.10
	21	7.85	3.34	7.39	3.28	7.21	3.26	7.32	3.17	7.07	3.12
	22	7.68	3.35	7.57	3.29	7.53	3.26	7.48	3.19	6.89	3.12
	24	7.16	3.39	7.43	3.31	7.54	3.29	7.39	3.24	6.44	3.18
1.6 + 6.0 + 6.0	16	9.12	3.28	8.45	3.32	8.19	3.33	7.88	3.17	7.23	3.11
	18	8.65	3.34	8.08	3.31	7.85	3.30	7.73	3.15	7.28	3.11
	20	8.17	3.34	7.78	3.29	7.62	3.27	7.60	3.17	7.18	3.11
	21	7.85	3.35	7.39	3.29	7.21	3.27	7.32	3.18	7.07	3.14
	22	7.68	3.36	7.57	3.30	7.53	3.27	7.48	3.20	6.89	3.14
	24	7.16	3.40	7.43	3.33	7.54	3.30	7.39	3.25	6.44	3.19

Combination (Capacity)	Indoor Air Temp. °C DB	Outdoor Air Temp. °C											
		16/15		15/14		10/9		7/6		6/5		2/1	
		Total Q	Input Power	Total Q	Input Power	Total Q	Input Power	Total Q	Input Power	Total Q	Input Power	Total Q	Input Power
1.6 + 6.0 + 7.1	16	15.27	2.36	14.98	2.42	13.53	2.68	12.66	2.84	11.85	2.96	9.38	3.25
	18	14.54	2.45	14.21	2.50	12.55	2.74	11.56	2.88	10.83	3.02	8.88	3.35
	20	14.08	2.53	13.69	2.58	11.76	2.79	10.60	2.92	9.93	3.05	8.33	3.35
	21	13.90	2.58	13.49	2.61	11.41	2.78	10.16	2.87	9.52	3.01	8.04	3.36
	22	13.78	2.63	13.50	2.66	12.08	2.84	11.23	2.94	10.30	3.07	7.72	3.37
	24	13.70	2.73	13.19	2.75	10.63	2.89	9.10	2.97	8.49	3.10	7.06	3.39
2.0 + 2.0 + 2.0	16	14.98	2.62	14.70	2.68	13.28	2.97	12.43	3.15	11.63	3.28	9.21	3.60
	18	14.27	2.72	13.94	2.77	12.32	3.04	11.34	3.20	10.62	3.35	8.71	3.71
	20	13.81	2.81	13.43	2.86	11.54	3.10	10.40	3.24	9.74	3.38	8.17	3.71
	21	13.64	2.86	13.23	2.90	11.19	3.08	9.97	3.19	9.34	3.34	7.88	3.73
	22	13.52	2.92	13.25	2.96	11.85	3.15	11.01	3.27	10.11	3.41	7.58	3.74
	24	13.44	3.02	12.94	3.05	10.43	3.20	8.93	3.29	8.33	3.44	6.92	3.76
2.0 + 2.0 + 2.5	16	14.98	2.62	14.70	2.68	13.28	2.97	12.43	3.15	11.63	3.28	9.21	3.60
	18	14.27	2.72	13.94	2.77	12.32	3.04	11.34	3.20	10.62	3.35	8.71	3.71
	20	13.81	2.81	13.43	2.86	11.54	3.10	10.40	3.24	9.74	3.38	8.17	3.71
	21	13.64	2.86	13.23	2.90	11.19	3.08	9.97	3.19	9.34	3.34	7.88	3.73
	22	13.52	2.92	13.25	2.96	11.85	3.15	11.01	3.27	10.11	3.41	7.58	3.74
	24	13.44	3.02	12.94	3.05	10.43	3.20	8.93	3.29	8.33	3.44	6.92	3.76
2.0 + 2.0 + 3.5	16	14.98	2.59	14.70	2.65	13.28	2.93	12.43	3.11	11.63	3.24	9.21	3.56
	18	14.27	2.68	13.94	2.74	12.32	3.00	11.34	3.16	10.62	3.31	8.71	3.67
	20	13.81	2.78	13.43	2.82	11.54	3.06	10.40	3.20	9.74	3.34	8.17	3.67
	21	13.64	2.83	13.23	2.86	11.19	3.04	9.97	3.15	9.34	3.30	7.88	3.68
	22	13.52	2.88	13.25	2.92	11.85	3.11	11.01	3.23	10.11	3.36	7.58	3.69
	24	13.44	2.99	12.94	3.02	10.43	3.16	8.93	3.25	8.33	3.40	6.92	3.71
2.0 + 2.0 + 4.2	16	14.98	2.58	14.70	2.64	13.28	2.93	12.43	3.10	11.63	3.23	9.21	3.55
	18	14.27	2.67	13.94	2.73	12.32	2.99	11.34	3.15	10.62	3.30	8.71	3.65
	20	13.81	2.77	13.43	2.81	11.54	3.05	10.40	3.19	9.74	3.33	8.17	3.65
	21	13.64	2.82	13.23	2.85	11.19	3.03	9.97	3.14	9.34	3.29	7.88	3.67
	22	13.52	2.87	13.25	2.91	11.85	3.10	11.01	3.22	10.11	3.35	7.58	3.68
	24	13.44	2.98	12.94	3.01	10.43	3.15	8.93	3.24	8.33	3.39	6.92	3.70
2.0 + 2.0 + 5.0	16	15.12	2.45	14.84	2.51	13.40	2.78	12.55	2.94	11.74	3.07	9.29	3.37
	18	14.40	2.54	14.08	2.59	12.43	2.84	11.45	2.99	10.72	3.13	8.80	3.47
	20	13.94	2.63	13.56	2.67	11.65	2.90	10.50	3.03	9.83	3.16	8.25	3.47
	21	13.77	2.68	13.36	2.71	11.30	2.88	10.07	2.98	9.43	3.12	7.96	3.48
	22	13.65	2.73	13.37	2.76	11.96	2.95	11.12	3.06	10.21	3.19	7.65	3.50
	24	13.57	2.83	13.06	2.86	10.53	3.00	9.02	3.08	8.41	3.22	6.99	3.51



Combination (Capacity)	Indoor Air Temp. °C DB	Outdoor Air Temp. °C									
		0/-1		-5/-6		-7/-8		-10/-11		-15/-	
		Total Q	Input Power	Total Q	Input Power	Total Q	Input Power	Total Q	Input Power	Total Q	Input Power
1.6 + 6.0 + 7.1	16	9.12	3.26	8.45	3.31	8.19	3.32	7.88	3.16	7.23	3.10
	18	8.65	3.33	8.08	3.30	7.85	3.29	7.73	3.14	7.28	3.10
	20	8.17	3.33	7.78	3.28	7.62	3.26	7.60	3.16	7.18	3.10
	21	7.85	3.34	7.39	3.28	7.21	3.26	7.32	3.17	7.07	3.12
	22	7.68	3.35	7.57	3.29	7.53	3.26	7.48	3.19	6.89	3.12
	24	7.16	3.39	7.43	3.31	7.54	3.29	7.39	3.24	6.44	3.18
2.0 + 2.0 + 2.0	16	8.94	3.62	8.29	3.67	8.03	3.69	7.73	3.51	7.09	3.44
	18	8.49	3.70	7.92	3.66	7.70	3.65	7.59	3.49	7.15	3.43
	20	8.02	3.69	7.63	3.64	7.48	3.62	7.46	3.51	7.05	3.43
	21	7.70	3.70	7.25	3.64	7.07	3.62	7.18	3.52	6.93	3.47
	22	7.53	3.71	7.43	3.65	7.38	3.62	7.34	3.54	6.76	3.47
	24	7.03	3.76	7.29	3.68	7.40	3.65	7.25	3.59	6.32	3.53
2.0 + 2.0 + 2.5	16	8.94	3.62	8.29	3.67	8.03	3.69	7.73	3.51	7.09	3.44
	18	8.49	3.70	7.92	3.66	7.70	3.65	7.59	3.49	7.15	3.43
	20	8.02	3.69	7.63	3.64	7.48	3.62	7.46	3.51	7.05	3.43
	21	7.70	3.70	7.25	3.64	7.07	3.62	7.18	3.52	6.93	3.47
	22	7.53	3.71	7.43	3.65	7.38	3.62	7.34	3.54	6.76	3.47
	24	7.03	3.76	7.29	3.68	7.40	3.65	7.25	3.59	6.32	3.53
2.0 + 2.0 + 3.5	16	8.94	3.58	8.29	3.62	8.03	3.64	7.73	3.47	7.09	3.40
	18	8.49	3.65	7.92	3.61	7.70	3.60	7.59	3.45	7.15	3.39
	20	8.02	3.65	7.63	3.59	7.48	3.57	7.46	3.46	7.05	3.39
	21	7.70	3.66	7.25	3.60	7.07	3.57	7.18	3.47	6.93	3.42
	22	7.53	3.67	7.43	3.60	7.38	3.57	7.34	3.49	6.76	3.42
	24	7.03	3.71	7.29	3.63	7.40	3.60	7.25	3.55	6.32	3.49
2.0 + 2.0 + 4.2	16	8.94	3.57	8.29	3.61	8.03	3.63	7.73	3.45	7.09	3.39
	18	8.49	3.64	7.92	3.60	7.70	3.59	7.59	3.43	7.15	3.38
	20	8.02	3.63	7.63	3.58	7.48	3.56	7.46	3.45	7.05	3.38
	21	7.70	3.64	7.25	3.59	7.07	3.56	7.18	3.46	6.93	3.41
	22	7.53	3.65	7.43	3.59	7.38	3.56	7.34	3.48	6.76	3.41
	24	7.03	3.70	7.29	3.62	7.40	3.59	7.25	3.54	6.32	3.48
2.0 + 2.0 + 5.0	16	9.03	3.39	8.37	3.43	8.11	3.45	7.81	3.28	7.16	3.22
	18	8.57	3.46	8.00	3.42	7.77	3.41	7.66	3.26	7.22	3.21
	20	8.10	3.45	7.71	3.40	7.55	3.38	7.53	3.28	7.12	3.21
	21	7.78	3.46	7.32	3.41	7.14	3.38	7.25	3.29	7.00	3.24
	22	7.61	3.47	7.50	3.41	7.46	3.38	7.41	3.31	6.83	3.24
	24	7.10	3.52	7.36	3.44	7.47	3.41	7.32	3.36	6.38	3.30

Combination (Capacity)	Indoor Air Temp. °C DB	Outdoor Air Temp. °C											
		16/15		15/14		10/9		7/6		6/5		2/1	
		Total Q	Input Power	Total Q	Input Power	Total Q	Input Power	Total Q	Input Power	Total Q	Input Power	Total Q	Input Power
2.0 + 2.0 + 6.0	16	15.12	2.45	14.84	2.51	13.40	2.78	12.55	2.94	11.74	3.07	9.29	3.37
	18	14.40	2.54	14.08	2.59	12.43	2.84	11.45	2.99	10.72	3.13	8.80	3.47
	20	13.94	2.63	13.56	2.67	11.65	2.90	10.50	3.03	9.83	3.16	8.25	3.47
	21	13.77	2.68	13.36	2.71	11.30	2.88	10.07	2.98	9.43	3.12	7.96	3.48
	22	13.65	2.73	13.37	2.76	11.96	2.95	11.12	3.06	10.21	3.19	7.65	3.50
	24	13.57	2.83	13.06	2.86	10.53	3.00	9.02	3.08	8.41	3.22	6.99	3.51
2.0 + 2.0 + 7.1	16	15.27	2.49	14.98	2.55	13.53	2.82	12.66	2.99	11.85	3.12	9.38	3.43
	18	14.54	2.58	14.21	2.63	12.55	2.89	11.56	3.04	10.83	3.18	8.88	3.53
	20	14.08	2.67	13.69	2.72	11.76	2.94	10.60	3.08	9.93	3.21	8.33	3.53
	21	13.90	2.72	13.49	2.76	11.41	2.93	10.16	3.03	9.52	3.18	8.04	3.54
	22	13.78	2.77	13.50	2.81	12.08	2.99	11.23	3.11	10.30	3.24	7.72	3.55
	24	13.70	2.88	13.19	2.90	10.63	3.05	9.10	3.13	8.49	3.27	7.06	3.57
2.0 + 2.5 + 2.5	16	14.98	2.62	14.70	2.68	13.28	2.97	12.43	3.15	11.63	3.28	9.21	3.60
	18	14.27	2.72	13.94	2.77	12.32	3.04	11.34	3.20	10.62	3.35	8.71	3.71
	20	13.81	2.81	13.43	2.86	11.54	3.10	10.40	3.24	9.74	3.38	8.17	3.71
	21	13.64	2.86	13.23	2.90	11.19	3.08	9.97	3.19	9.34	3.34	7.88	3.73
	22	13.52	2.92	13.25	2.96	11.85	3.15	11.01	3.27	10.11	3.41	7.58	3.74
	24	13.44	3.02	12.94	3.05	10.43	3.20	8.93	3.29	8.33	3.44	6.92	3.76
2.0 + 2.5 + 3.5	16	14.98	2.59	14.70	2.65	13.28	2.93	12.43	3.11	11.63	3.24	9.21	3.56
	18	14.27	2.68	13.94	2.74	12.32	3.00	11.34	3.16	10.62	3.31	8.71	3.67
	20	13.81	2.78	13.43	2.82	11.54	3.06	10.40	3.20	9.74	3.34	8.17	3.67
	21	13.64	2.83	13.23	2.86	11.19	3.04	9.97	3.15	9.34	3.30	7.88	3.68
	22	13.52	2.88	13.25	2.92	11.85	3.11	11.01	3.23	10.11	3.36	7.58	3.69
	24	13.44	2.99	12.94	3.02	10.43	3.16	8.93	3.25	8.33	3.40	6.92	3.71
2.0 + 2.5 + 4.2	16	15.12	2.63	14.84	2.69	13.40	2.98	12.55	3.16	11.74	3.29	9.29	3.62
	18	14.40	2.72	14.08	2.78	12.43	3.05	11.45	3.21	10.72	3.36	8.80	3.72
	20	13.94	2.82	13.56	2.87	11.65	3.11	10.50	3.25	9.83	3.39	8.25	3.72
	21	13.77	2.87	13.36	2.91	11.30	3.09	10.07	3.20	9.43	3.35	7.96	3.74
	22	13.65	2.93	13.37	2.97	11.96	3.16	11.12	3.28	10.21	3.42	7.65	3.75
	24	13.57	3.03	13.06	3.06	10.53	3.21	9.02	3.30	8.41	3.45	6.99	3.77
2.0 + 2.5 + 5.0	16	15.12	2.45	14.84	2.51	13.40	2.78	12.55	2.94	11.74	3.07	9.29	3.37
	18	14.40	2.54	14.08	2.59	12.43	2.84	11.45	2.99	10.72	3.13	8.80	3.47
	20	13.94	2.63	13.56	2.67	11.65	2.90	10.50	3.03	9.83	3.16	8.25	3.47
	21	13.77	2.68	13.36	2.71	11.30	2.88	10.07	2.98	9.43	3.12	7.96	3.48
	22	13.65	2.73	13.37	2.76	11.96	2.95	11.12	3.06	10.21	3.19	7.65	3.50
	24	13.57	2.83	13.06	2.86	10.53	3.00	9.02	3.08	8.41	3.22	6.99	3.51

Combination (Capacity)	Indoor Air Temp. °C DB	Outdoor Air Temp. °C									
		0/-1		-5/-6		-7/-8		-10/-11		-15/-	
		Total Q	Input Power	Total Q	Input Power	Total Q	Input Power	Total Q	Input Power	Total Q	Input Power
2.0 + 2.0 + 6.0	16	9.03	3.39	8.37	3.43	8.11	3.45	7.81	3.28	7.16	3.22
	18	8.57	3.46	8.00	3.42	7.77	3.41	7.66	3.26	7.22	3.21
	20	8.10	3.45	7.71	3.40	7.55	3.38	7.53	3.28	7.12	3.21
	21	7.78	3.46	7.32	3.41	7.14	3.38	7.25	3.29	7.00	3.24
	22	7.61	3.47	7.50	3.41	7.46	3.38	7.41	3.31	6.83	3.24
	24	7.10	3.52	7.36	3.44	7.47	3.41	7.32	3.36	6.38	3.30
2.0 + 2.0 + 7.1	16	9.12	3.44	8.45	3.49	8.19	3.50	7.88	3.34	7.23	3.27
	18	8.65	3.51	8.08	3.48	7.85	3.47	7.73	3.32	7.28	3.26
	20	8.17	3.51	7.78	3.46	7.62	3.44	7.60	3.33	7.18	3.26
	21	7.85	3.52	7.39	3.46	7.21	3.44	7.32	3.34	7.07	3.30
	22	7.68	3.53	7.57	3.47	7.53	3.44	7.48	3.36	6.89	3.30
	24	7.16	3.57	7.43	3.50	7.54	3.47	7.39	3.42	6.44	3.36
2.0 + 2.5 + 2.5	16	8.94	3.62	8.29	3.67	8.03	3.69	7.73	3.51	7.09	3.44
	18	8.49	3.70	7.92	3.66	7.70	3.65	7.59	3.49	7.15	3.43
	20	8.02	3.69	7.63	3.64	7.48	3.62	7.46	3.51	7.05	3.43
	21	7.70	3.70	7.25	3.64	7.07	3.62	7.18	3.52	6.93	3.47
	22	7.53	3.71	7.43	3.65	7.38	3.62	7.34	3.54	6.76	3.47
	24	7.03	3.76	7.29	3.68	7.40	3.65	7.25	3.59	6.32	3.53
2.0 + 2.5 + 3.5	16	8.94	3.58	8.29	3.62	8.03	3.64	7.73	3.47	7.09	3.40
	18	8.49	3.65	7.92	3.61	7.70	3.60	7.59	3.45	7.15	3.39
	20	8.02	3.65	7.63	3.59	7.48	3.57	7.46	3.46	7.05	3.39
	21	7.70	3.66	7.25	3.60	7.07	3.57	7.18	3.47	6.93	3.42
	22	7.53	3.67	7.43	3.60	7.38	3.57	7.34	3.49	6.76	3.42
	24	7.03	3.71	7.29	3.63	7.40	3.60	7.25	3.55	6.32	3.49
2.0 + 2.5 + 4.2	16	9.03	3.63	8.37	3.68	8.11	3.70	7.81	3.52	7.16	3.45
	18	8.57	3.71	8.00	3.67	7.77	3.66	7.66	3.50	7.22	3.45
	20	8.10	3.70	7.71	3.65	7.55	3.63	7.53	3.52	7.12	3.45
	21	7.78	3.71	7.32	3.65	7.14	3.63	7.25	3.53	7.00	3.48
	22	7.61	3.72	7.50	3.66	7.46	3.63	7.41	3.55	6.83	3.48
	24	7.10	3.77	7.36	3.69	7.47	3.66	7.32	3.61	6.38	3.54
2.0 + 2.5 + 5.0	16	9.03	3.39	8.37	3.43	8.11	3.45	7.81	3.28	7.16	3.22
	18	8.57	3.46	8.00	3.42	7.77	3.41	7.66	3.26	7.22	3.21
	20	8.10	3.45	7.71	3.40	7.55	3.38	7.53	3.28	7.12	3.21
	21	7.78	3.46	7.32	3.41	7.14	3.38	7.25	3.29	7.00	3.24
	22	7.61	3.47	7.50	3.41	7.46	3.38	7.41	3.31	6.83	3.24
	24	7.10	3.52	7.36	3.44	7.47	3.41	7.32	3.36	6.38	3.30

Combination (Capacity)	Indoor Air Temp. °C DB	Outdoor Air Temp. °C											
		16/15		15/14		10/9		7/6		6/5		2/1	
		Total Q	Input Power	Total Q	Input Power	Total Q	Input Power	Total Q	Input Power	Total Q	Input Power	Total Q	Input Power
2.0 + 2.5 + 6.0	16	15.12	2.45	14.84	2.51	13.40	2.78	12.55	2.94	11.74	3.07	9.29	3.37
	18	14.40	2.54	14.08	2.59	12.43	2.84	11.45	2.99	10.72	3.13	8.80	3.47
	20	13.94	2.63	13.56	2.67	11.65	2.90	10.50	3.03	9.83	3.16	8.25	3.47
	21	13.77	2.68	13.36	2.71	11.30	2.88	10.07	2.98	9.43	3.12	7.96	3.48
	22	13.65	2.73	13.37	2.76	11.96	2.95	11.12	3.06	10.21	3.19	7.65	3.50
	24	13.57	2.83	13.06	2.86	10.53	3.00	9.02	3.08	8.41	3.22	6.99	3.51
2.0 + 2.5 + 7.1	16	15.27	2.49	14.98	2.55	13.53	2.82	12.66	2.99	11.85	3.12	9.38	3.43
	18	14.54	2.58	14.21	2.63	12.55	2.89	11.56	3.04	10.83	3.18	8.88	3.53
	20	14.08	2.67	13.69	2.72	11.76	2.94	10.60	3.08	9.93	3.21	8.33	3.53
	21	13.90	2.72	13.49	2.76	11.41	2.93	10.16	3.03	9.52	3.18	8.04	3.54
	22	13.78	2.77	13.50	2.81	12.08	2.99	11.23	3.11	10.30	3.24	7.72	3.55
	24	13.70	2.88	13.19	2.90	10.63	3.05	9.10	3.13	8.49	3.27	7.06	3.57
2.0 + 3.5 + 3.5	16	15.12	2.56	14.84	2.61	13.40	2.90	12.55	3.07	11.74	3.20	9.29	3.52
	18	14.40	2.65	14.08	2.70	12.43	2.96	11.45	3.12	10.72	3.26	8.80	3.62
	20	13.94	2.74	13.56	2.79	11.65	3.02	10.50	3.16	9.83	3.30	8.25	3.62
	21	13.77	2.79	13.36	2.83	11.30	3.00	10.07	3.11	9.43	3.26	7.96	3.63
	22	13.65	2.85	13.37	2.88	11.96	3.07	11.12	3.19	10.21	3.32	7.65	3.65
	24	13.57	2.95	13.06	2.98	10.53	3.13	9.02	3.21	8.41	3.35	6.99	3.67
2.0 + 3.5 + 4.2	16	15.12	2.55	14.84	2.61	13.40	2.89	12.55	3.06	11.74	3.19	9.29	3.50
	18	14.40	2.64	14.08	2.69	12.43	2.95	11.45	3.11	10.72	3.25	8.80	3.61
	20	13.94	2.73	13.56	2.78	11.65	3.01	10.50	3.15	9.83	3.29	8.25	3.61
	21	13.77	2.78	13.36	2.82	11.30	2.99	10.07	3.10	9.43	3.25	7.96	3.62
	22	13.65	2.84	13.37	2.87	11.96	3.06	11.12	3.18	10.21	3.31	7.65	3.64
	24	13.57	2.94	13.06	2.97	10.53	3.12	9.02	3.20	8.41	3.34	6.99	3.65
2.0 + 3.5 + 5.0	16	15.12	2.43	14.84	2.48	13.40	2.75	12.55	2.91	11.74	3.04	9.29	3.34
	18	14.40	2.51	14.08	2.56	12.43	2.81	11.45	2.96	10.72	3.10	8.80	3.44
	20	13.94	2.60	13.56	2.65	11.65	2.87	10.50	3.00	9.83	3.13	8.25	3.44
	21	13.77	2.65	13.36	2.68	11.30	2.85	10.07	2.95	9.43	3.09	7.96	3.45
	22	13.65	2.70	13.37	2.74	11.96	2.92	11.12	3.02	10.21	3.15	7.65	3.46
	24	13.57	2.80	13.06	2.83	10.53	2.97	9.02	3.05	8.41	3.18	6.99	3.48
2.0 + 3.5 + 6.0	16	15.27	2.48	14.98	2.53	13.53	2.81	12.66	2.97	11.85	3.10	9.38	3.40
	18	14.54	2.56	14.21	2.62	12.55	2.87	11.56	3.02	10.83	3.16	8.88	3.51
	20	14.08	2.65	13.69	2.70	11.76	2.92	10.60	3.06	9.93	3.19	8.33	3.51
	21	13.90	2.70	13.49	2.74	11.41	2.91	10.16	3.01	9.52	3.15	8.04	3.52
	22	13.78	2.76	13.50	2.79	12.08	2.98	11.23	3.09	10.30	3.22	7.72	3.53
	24	13.70	2.86	13.19	2.89	10.63	3.03	9.10	3.11	8.49	3.25	7.06	3.55

Combination (Capacity)	Indoor Air Temp. °C DB	Outdoor Air Temp. °C									
		0/-1		-5/-6		-7/-8		-10/-11		-15/-	
		Total Q	Input Power	Total Q	Input Power	Total Q	Input Power	Total Q	Input Power	Total Q	Input Power
2.0 + 2.5 + 6.0	16	9.03	3.39	8.37	3.43	8.11	3.45	7.81	3.28	7.16	3.22
	18	8.57	3.46	8.00	3.42	7.77	3.41	7.66	3.26	7.22	3.21
	20	8.10	3.45	7.71	3.40	7.55	3.38	7.53	3.28	7.12	3.21
	21	7.78	3.46	7.32	3.41	7.14	3.38	7.25	3.29	7.00	3.24
	22	7.61	3.47	7.50	3.41	7.46	3.38	7.41	3.31	6.83	3.24
	24	7.10	3.52	7.36	3.44	7.47	3.41	7.32	3.36	6.38	3.30
2.0 + 2.5 + 7.1	16	9.12	3.44	8.45	3.49	8.19	3.50	7.88	3.34	7.23	3.27
	18	8.65	3.51	8.08	3.48	7.85	3.47	7.73	3.32	7.28	3.26
	20	8.17	3.51	7.78	3.46	7.62	3.44	7.60	3.33	7.18	3.26
	21	7.85	3.52	7.39	3.46	7.21	3.44	7.32	3.34	7.07	3.30
	22	7.68	3.53	7.57	3.47	7.53	3.44	7.48	3.36	6.89	3.30
	24	7.16	3.57	7.43	3.50	7.54	3.47	7.39	3.42	6.44	3.36
2.0 + 3.5 + 3.5	16	9.03	3.53	8.37	3.58	8.11	3.59	7.81	3.42	7.16	3.36
	18	8.57	3.61	8.00	3.57	7.77	3.56	7.66	3.40	7.22	3.35
	20	8.10	3.60	7.71	3.55	7.55	3.53	7.53	3.42	7.12	3.35
	21	7.78	3.61	7.32	3.55	7.14	3.53	7.25	3.43	7.00	3.38
	22	7.61	3.62	7.50	3.56	7.46	3.53	7.41	3.45	6.83	3.38
	24	7.10	3.67	7.36	3.59	7.47	3.56	7.32	3.51	6.38	3.44
2.0 + 3.5 + 4.2	16	9.03	3.52	8.37	3.57	8.11	3.58	7.81	3.41	7.16	3.35
	18	8.57	3.59	8.00	3.56	7.77	3.54	7.66	3.39	7.22	3.34
	20	8.10	3.59	7.71	3.54	7.55	3.52	7.53	3.41	7.12	3.34
	21	7.78	3.60	7.32	3.54	7.14	3.52	7.25	3.42	7.00	3.37
	22	7.61	3.61	7.50	3.54	7.46	3.52	7.41	3.44	6.83	3.37
	24	7.10	3.66	7.36	3.58	7.47	3.54	7.32	3.49	6.38	3.43
2.0 + 3.5 + 5.0	16	9.03	3.35	8.37	3.40	8.11	3.41	7.81	3.25	7.16	3.19
	18	8.57	3.42	8.00	3.39	7.77	3.38	7.66	3.23	7.22	3.18
	20	8.10	3.42	7.71	3.37	7.55	3.35	7.53	3.25	7.12	3.18
	21	7.78	3.43	7.32	3.37	7.14	3.35	7.25	3.26	7.00	3.21
	22	7.61	3.44	7.50	3.38	7.46	3.35	7.41	3.28	6.83	3.21
	24	7.10	3.48	7.36	3.41	7.47	3.38	7.32	3.33	6.38	3.27
2.0 + 3.5 + 6.0	16	9.12	3.42	8.45	3.46	8.19	3.48	7.88	3.31	7.23	3.25
	18	8.65	3.49	8.08	3.46	7.85	3.44	7.73	3.29	7.28	3.24
	20	8.17	3.49	7.78	3.44	7.62	3.42	7.60	3.31	7.18	3.24
	21	7.85	3.50	7.39	3.44	7.21	3.42	7.32	3.32	7.07	3.27
	22	7.68	3.51	7.57	3.44	7.53	3.42	7.48	3.34	6.89	3.27
	24	7.16	3.55	7.43	3.47	7.54	3.44	7.39	3.39	6.44	3.34

Combination (Capacity)	Indoor Air Temp. °C DB	Outdoor Air Temp. °C											
		16/15		15/14		10/9		7/6		6/5		2/1	
		Total Q	Input Power	Total Q	Input Power	Total Q	Input Power	Total Q	Input Power	Total Q	Input Power	Total Q	Input Power
2.0 + 3.5 + 7.1	16	15.27	2.46	14.98	2.51	13.53	2.79	12.66	2.95	11.85	3.08	9.38	3.38
	18	14.54	2.55	14.21	2.60	12.55	2.85	11.56	3.00	10.83	3.14	8.88	3.48
	20	14.08	2.64	13.69	2.68	11.76	2.91	10.60	3.04	9.93	3.17	8.33	3.48
	21	13.90	2.69	13.49	2.72	11.41	2.89	10.16	2.99	9.52	3.13	8.04	3.50
	22	13.78	2.74	13.50	2.77	12.08	2.96	11.23	3.07	10.30	3.20	7.72	3.51
	24	13.70	2.84	13.19	2.87	10.63	3.01	9.10	3.09	8.49	3.23	7.06	3.53
2.0 + 4.2 + 4.2	16	15.12	2.54	14.84	2.60	13.40	2.88	12.55	3.05	11.74	3.18	9.29	3.49
	18	14.40	2.63	14.08	2.68	12.43	2.94	11.45	3.10	10.72	3.24	8.80	3.60
	20	13.94	2.72	13.56	2.77	11.65	3.00	10.50	3.14	9.83	3.28	8.25	3.60
	21	13.77	2.78	13.36	2.81	11.30	2.98	10.07	3.09	9.43	3.24	7.96	3.61
	22	13.65	2.83	13.37	2.86	11.96	3.05	11.12	3.17	10.21	3.30	7.65	3.62
	24	13.57	2.93	13.06	2.96	10.53	3.11	9.02	3.19	8.41	3.33	6.99	3.64
2.0 + 4.2 + 5.0	16	15.27	2.47	14.98	2.52	13.53	2.80	12.66	2.96	11.85	3.09	9.38	3.39
	18	14.54	2.56	14.21	2.61	12.55	2.86	11.56	3.01	10.83	3.15	8.88	3.49
	20	14.08	2.65	13.69	2.69	11.76	2.92	10.60	3.05	9.93	3.18	8.33	3.49
	21	13.90	2.70	13.49	2.73	11.41	2.90	10.16	3.00	9.52	3.14	8.04	3.51
	22	13.78	2.75	13.50	2.78	12.08	2.97	11.23	3.08	10.30	3.21	7.72	3.52
	24	13.70	2.85	13.19	2.88	10.63	3.02	9.10	3.10	8.49	3.24	7.06	3.54
2.0 + 4.2 + 6.0	16	15.27	2.47	14.98	2.52	13.53	2.80	12.66	2.96	11.85	3.09	9.38	3.39
	18	14.54	2.56	14.21	2.61	12.55	2.86	11.56	3.01	10.83	3.15	8.88	3.49
	20	14.08	2.65	13.69	2.69	11.76	2.92	10.60	3.05	9.93	3.18	8.33	3.49
	21	13.90	2.70	13.49	2.73	11.41	2.90	10.16	3.00	9.52	3.14	8.04	3.51
	22	13.78	2.75	13.50	2.78	12.08	2.97	11.23	3.08	10.30	3.21	7.72	3.52
	24	13.70	2.85	13.19	2.88	10.63	3.02	9.10	3.10	8.49	3.24	7.06	3.54
2.0 + 4.2 + 7.1	16	15.27	2.45	14.98	2.51	13.53	2.78	12.66	2.94	11.85	3.07	9.38	3.37
	18	14.54	2.54	14.21	2.59	12.55	2.84	11.56	2.99	10.83	3.13	8.88	3.47
	20	14.08	2.63	13.69	2.67	11.76	2.90	10.60	3.03	9.93	3.16	8.33	3.47
	21	13.90	2.68	13.49	2.71	11.41	2.88	10.16	2.98	9.52	3.12	8.04	3.48
	22	13.78	2.73	13.50	2.76	12.08	2.95	11.23	3.06	10.30	3.19	7.72	3.50
	24	13.70	2.83	13.19	2.86	10.63	3.00	9.10	3.08	8.49	3.22	7.06	3.51
2.0 + 5.0 + 5.0	16	15.27	2.36	14.98	2.42	13.53	2.68	12.66	2.84	11.85	2.96	9.38	3.25
	18	14.54	2.45	14.21	2.50	12.55	2.74	11.56	2.88	10.83	3.02	8.88	3.35
	20	14.08	2.53	13.69	2.58	11.76	2.79	10.60	2.92	9.93	3.05	8.33	3.35
	21	13.90	2.58	13.49	2.61	11.41	2.78	10.16	2.87	9.52	3.01	8.04	3.36
	22	13.78	2.63	13.50	2.66	12.08	2.84	11.23	2.94	10.30	3.07	7.72	3.37
	24	13.70	2.73	13.19	2.75	10.63	2.89	9.10	2.97	8.49	3.10	7.06	3.39

Combination (Capacity)	Indoor Air Temp. °C DB	Outdoor Air Temp. °C									
		0/-1		-5/-6		-7/-8		-10/-11		-15/-	
		Total Q	Input Power	Total Q	Input Power	Total Q	Input Power	Total Q	Input Power	Total Q	Input Power
2.0 + 3.5 + 7.1	16	9.12	3.40	8.45	3.44	8.19	3.46	7.88	3.29	7.23	3.23
	18	8.65	3.47	8.08	3.43	7.85	3.42	7.73	3.27	7.28	3.22
	20	8.17	3.46	7.78	3.41	7.62	3.39	7.60	3.29	7.18	3.22
	21	7.85	3.47	7.39	3.42	7.21	3.39	7.32	3.30	7.07	3.25
	22	7.68	3.48	7.57	3.42	7.53	3.39	7.48	3.32	6.89	3.25
	24	7.16	3.53	7.43	3.45	7.54	3.42	7.39	3.37	6.44	3.31
2.0 + 4.2 + 4.2	16	9.03	3.51	8.37	3.55	8.11	3.57	7.81	3.40	7.16	3.34
	18	8.57	3.58	8.00	3.55	7.77	3.53	7.66	3.38	7.22	3.33
	20	8.10	3.58	7.71	3.53	7.55	3.51	7.53	3.40	7.12	3.33
	21	7.78	3.59	7.32	3.53	7.14	3.51	7.25	3.41	7.00	3.36
	22	7.61	3.60	7.50	3.53	7.46	3.51	7.41	3.43	6.83	3.36
	24	7.10	3.64	7.36	3.56	7.47	3.53	7.32	3.48	6.38	3.42
2.0 + 4.2 + 5.0	16	9.12	3.41	8.45	3.45	8.19	3.47	7.88	3.30	7.23	3.24
	18	8.65	3.48	8.08	3.45	7.85	3.43	7.73	3.28	7.28	3.23
	20	8.17	3.47	7.78	3.43	7.62	3.41	7.60	3.30	7.18	3.23
	21	7.85	3.48	7.39	3.43	7.21	3.41	7.32	3.31	7.07	3.26
	22	7.68	3.49	7.57	3.43	7.53	3.41	7.48	3.33	6.89	3.26
	24	7.16	3.54	7.43	3.46	7.54	3.43	7.39	3.38	6.44	3.32
2.0 + 4.2 + 6.0	16	9.12	3.41	8.45	3.45	8.19	3.47	7.88	3.30	7.23	3.24
	18	8.65	3.48	8.08	3.45	7.85	3.43	7.73	3.28	7.28	3.23
	20	8.17	3.47	7.78	3.43	7.62	3.41	7.60	3.30	7.18	3.23
	21	7.85	3.48	7.39	3.43	7.21	3.41	7.32	3.31	7.07	3.26
	22	7.68	3.49	7.57	3.43	7.53	3.41	7.48	3.33	6.89	3.26
	24	7.16	3.54	7.43	3.46	7.54	3.43	7.39	3.38	6.44	3.32
2.0 + 4.2 + 7.1	16	9.12	3.39	8.45	3.43	8.19	3.45	7.88	3.28	7.23	3.22
	18	8.65	3.46	8.08	3.42	7.85	3.41	7.73	3.26	7.28	3.21
	20	8.17	3.45	7.78	3.40	7.62	3.38	7.60	3.28	7.18	3.21
	21	7.85	3.46	7.39	3.41	7.21	3.38	7.32	3.29	7.07	3.24
	22	7.68	3.47	7.57	3.41	7.53	3.38	7.48	3.31	6.89	3.24
	24	7.16	3.52	7.43	3.44	7.54	3.41	7.39	3.36	6.44	3.30
2.0 + 5.0 + 5.0	16	9.12	3.26	8.45	3.31	8.19	3.32	7.88	3.16	7.23	3.10
	18	8.65	3.33	8.08	3.30	7.85	3.29	7.73	3.14	7.28	3.10
	20	8.17	3.33	7.78	3.28	7.62	3.26	7.60	3.16	7.18	3.10
	21	7.85	3.34	7.39	3.28	7.21	3.26	7.32	3.17	7.07	3.12
	22	7.68	3.35	7.57	3.29	7.53	3.26	7.48	3.19	6.89	3.12
	24	7.16	3.39	7.43	3.31	7.54	3.29	7.39	3.24	6.44	3.18

Combination (Capacity)	Indoor Air Temp. °C DB	Outdoor Air Temp. °C											
		16/15		15/14		10/9		7/6		6/5		2/1	
		Total Q	Input Power	Total Q	Input Power	Total Q	Input Power	Total Q	Input Power	Total Q	Input Power	Total Q	Input Power
2.0 + 5.0 + 6.0	16	15.27	2.36	14.98	2.42	13.53	2.68	12.66	2.84	11.85	2.96	9.38	3.25
	18	14.54	2.45	14.21	2.50	12.55	2.74	11.56	2.88	10.83	3.02	8.88	3.35
	20	14.08	2.53	13.69	2.58	11.76	2.79	10.60	2.92	9.93	3.05	8.33	3.35
	21	13.90	2.58	13.49	2.61	11.41	2.78	10.16	2.87	9.52	3.01	8.04	3.36
	22	13.78	2.63	13.50	2.66	12.08	2.84	11.23	2.94	10.30	3.07	7.72	3.37
	24	13.70	2.73	13.19	2.75	10.63	2.89	9.10	2.97	8.49	3.10	7.06	3.39
2.0 + 5.0 + 7.1	16	15.27	2.35	14.98	2.41	13.53	2.67	12.66	2.83	11.85	2.95	9.38	3.24
	18	14.54	2.44	14.21	2.49	12.55	2.73	11.56	2.87	10.83	3.01	8.88	3.33
	20	14.08	2.52	13.69	2.57	11.76	2.78	10.60	2.91	9.93	3.04	8.33	3.33
	21	13.90	2.57	13.49	2.60	11.41	2.77	10.16	2.86	9.52	3.00	8.04	3.35
	22	13.78	2.62	13.50	2.66	12.08	2.83	11.23	2.93	10.30	3.06	7.72	3.36
	24	13.70	2.72	13.19	2.74	10.63	2.88	9.10	2.96	8.49	3.09	7.06	3.38
2.0 + 6.0 + 6.0	16	15.27	2.36	14.98	2.42	13.53	2.68	12.66	2.84	11.85	2.96	9.38	3.25
	18	14.54	2.45	14.21	2.50	12.55	2.74	11.56	2.88	10.83	3.02	8.88	3.35
	20	14.08	2.53	13.69	2.58	11.76	2.79	10.60	2.92	9.93	3.05	8.33	3.35
	21	13.90	2.58	13.49	2.61	11.41	2.78	10.16	2.87	9.52	3.01	8.04	3.36
	22	13.78	2.63	13.50	2.66	12.08	2.84	11.23	2.94	10.30	3.07	7.72	3.37
	24	13.70	2.73	13.19	2.75	10.63	2.89	9.10	2.97	8.49	3.10	7.06	3.39
2.5 + 2.5 + 2.5	16	14.98	2.62	14.70	2.68	13.28	2.97	12.43	3.15	11.63	3.28	9.21	3.60
	18	14.27	2.72	13.94	2.77	12.32	3.04	11.34	3.20	10.62	3.35	8.71	3.71
	20	13.81	2.81	13.43	2.86	11.54	3.10	10.40	3.24	9.74	3.38	8.17	3.71
	21	13.64	2.86	13.23	2.90	11.19	3.08	9.97	3.19	9.34	3.34	7.88	3.73
	22	13.52	2.92	13.25	2.96	11.85	3.15	11.01	3.27	10.11	3.41	7.58	3.74
	24	13.44	3.02	12.94	3.05	10.43	3.20	8.93	3.29	8.33	3.44	6.92	3.76
2.5 + 2.5 + 3.5	16	14.98	2.59	14.70	2.65	13.28	2.93	12.43	3.11	11.63	3.24	9.21	3.56
	18	14.27	2.68	13.94	2.74	12.32	3.00	11.34	3.16	10.62	3.31	8.71	3.67
	20	13.81	2.78	13.43	2.82	11.54	3.06	10.40	3.20	9.74	3.34	8.17	3.67
	21	13.64	2.83	13.23	2.86	11.19	3.04	9.97	3.15	9.34	3.30	7.88	3.68
	22	13.52	2.88	13.25	2.92	11.85	3.11	11.01	3.23	10.11	3.36	7.58	3.69
	24	13.44	2.99	12.94	3.02	10.43	3.16	8.93	3.25	8.33	3.40	6.92	3.71
2.5 + 2.5 + 4.2	16	15.12	2.63	14.84	2.69	13.40	2.98	12.55	3.16	11.74	3.29	9.29	3.62
	18	14.40	2.72	14.08	2.78	12.43	3.05	11.45	3.21	10.72	3.36	8.80	3.72
	20	13.94	2.82	13.56	2.87	11.65	3.11	10.50	3.25	9.83	3.39	8.25	3.72
	21	13.77	2.87	13.36	2.91	11.30	3.09	10.07	3.20	9.43	3.35	7.96	3.74
	22	13.65	2.93	13.37	2.97	11.96	3.16	11.12	3.28	10.21	3.42	7.65	3.75
	24	13.57	3.03	13.06	3.06	10.53	3.21	9.02	3.30	8.41	3.45	6.99	3.77



Combination (Capacity)	Indoor Air Temp. °C DB	Outdoor Air Temp. °C									
		0/-1		-5/-6		-7/-8		-10/-11		-15/-	
		Total Q	Input Power	Total Q	Input Power	Total Q	Input Power	Total Q	Input Power	Total Q	Input Power
2.0 + 5.0 + 6.0	16	9.12	3.26	8.45	3.31	8.19	3.32	7.88	3.16	7.23	3.10
	18	8.65	3.33	8.08	3.30	7.85	3.29	7.73	3.14	7.28	3.10
	20	8.17	3.33	7.78	3.28	7.62	3.26	7.60	3.16	7.18	3.10
	21	7.85	3.34	7.39	3.28	7.21	3.26	7.32	3.17	7.07	3.12
	22	7.68	3.35	7.57	3.29	7.53	3.26	7.48	3.19	6.89	3.12
	24	7.16	3.39	7.43	3.31	7.54	3.29	7.39	3.24	6.44	3.18
2.0 + 5.0 + 7.1	16	9.12	3.25	8.45	3.29	8.19	3.31	7.88	3.15	7.23	3.09
	18	8.65	3.32	8.08	3.29	7.85	3.27	7.73	3.13	7.28	3.08
	20	8.17	3.32	7.78	3.27	7.62	3.25	7.60	3.15	7.18	3.08
	21	7.85	3.32	7.39	3.27	7.21	3.25	7.32	3.16	7.07	3.11
	22	7.68	3.33	7.57	3.27	7.53	3.25	7.48	3.18	6.89	3.11
	24	7.16	3.38	7.43	3.30	7.54	3.27	7.39	3.23	6.44	3.17
2.0 + 6.0 + 6.0	16	9.12	3.26	8.45	3.31	8.19	3.32	7.88	3.16	7.23	3.10
	18	8.65	3.33	8.08	3.30	7.85	3.29	7.73	3.14	7.28	3.10
	20	8.17	3.33	7.78	3.28	7.62	3.26	7.60	3.16	7.18	3.10
	21	7.85	3.34	7.39	3.28	7.21	3.26	7.32	3.17	7.07	3.12
	22	7.68	3.35	7.57	3.29	7.53	3.26	7.48	3.19	6.89	3.12
	24	7.16	3.39	7.43	3.31	7.54	3.29	7.39	3.24	6.44	3.18
2.5 + 2.5 + 2.5	16	8.94	3.62	8.29	3.67	8.03	3.69	7.73	3.51	7.09	3.44
	18	8.49	3.70	7.92	3.66	7.70	3.65	7.59	3.49	7.15	3.43
	20	8.02	3.69	7.63	3.64	7.48	3.62	7.46	3.51	7.05	3.43
	21	7.70	3.70	7.25	3.64	7.07	3.62	7.18	3.52	6.93	3.47
	22	7.53	3.71	7.43	3.65	7.38	3.62	7.34	3.54	6.76	3.47
	24	7.03	3.76	7.29	3.68	7.40	3.65	7.25	3.59	6.32	3.53
2.5 + 2.5 + 3.5	16	8.94	3.58	8.29	3.62	8.03	3.64	7.73	3.47	7.09	3.40
	18	8.49	3.65	7.92	3.61	7.70	3.60	7.59	3.45	7.15	3.39
	20	8.02	3.65	7.63	3.59	7.48	3.57	7.46	3.46	7.05	3.39
	21	7.70	3.66	7.25	3.60	7.07	3.57	7.18	3.47	6.93	3.42
	22	7.53	3.67	7.43	3.60	7.38	3.57	7.34	3.49	6.76	3.42
	24	7.03	3.71	7.29	3.63	7.40	3.60	7.25	3.55	6.32	3.49
2.5 + 2.5 + 4.2	16	9.03	3.63	8.37	3.68	8.11	3.70	7.81	3.52	7.16	3.45
	18	8.57	3.71	8.00	3.67	7.77	3.66	7.66	3.50	7.22	3.45
	20	8.10	3.70	7.71	3.65	7.55	3.63	7.53	3.52	7.12	3.45
	21	7.78	3.71	7.32	3.65	7.14	3.63	7.25	3.53	7.00	3.48
	22	7.61	3.72	7.50	3.66	7.46	3.63	7.41	3.55	6.83	3.48
	24	7.10	3.77	7.36	3.69	7.47	3.66	7.32	3.61	6.38	3.54

Combination (Capacity)	Indoor Air Temp. °C DB	Outdoor Air Temp. °C											
		16/15		15/14		10/9		7/6		6/5		2/1	
		Total Q	Input Power	Total Q	Input Power	Total Q	Input Power	Total Q	Input Power	Total Q	Input Power	Total Q	Input Power
2.5 + 2.5 + 5.0	16	15.12	2.45	14.84	2.51	13.40	2.78	12.55	2.94	11.74	3.07	9.29	3.37
	18	14.40	2.54	14.08	2.59	12.43	2.84	11.45	2.99	10.72	3.13	8.80	3.47
	20	13.94	2.63	13.56	2.67	11.65	2.90	10.50	3.03	9.83	3.16	8.25	3.47
	21	13.77	2.68	13.36	2.71	11.30	2.88	10.07	2.98	9.43	3.12	7.96	3.48
	22	13.65	2.73	13.37	2.76	11.96	2.95	11.12	3.06	10.21	3.19	7.65	3.50
	24	13.57	2.83	13.06	2.86	10.53	3.00	9.02	3.08	8.41	3.22	6.99	3.51
2.5 + 2.5 + 6.0	16	15.12	2.45	14.84	2.51	13.40	2.78	12.55	2.94	11.74	3.07	9.29	3.37
	18	14.40	2.54	14.08	2.59	12.43	2.84	11.45	2.99	10.72	3.13	8.80	3.47
	20	13.94	2.63	13.56	2.67	11.65	2.90	10.50	3.03	9.83	3.16	8.25	3.47
	21	13.77	2.68	13.36	2.71	11.30	2.88	10.07	2.98	9.43	3.12	7.96	3.48
	22	13.65	2.73	13.37	2.76	11.96	2.95	11.12	3.06	10.21	3.19	7.65	3.50
	24	13.57	2.83	13.06	2.86	10.53	3.00	9.02	3.08	8.41	3.22	6.99	3.51
2.5 + 2.5 + 7.1	16	15.27	2.49	14.98	2.55	13.53	2.82	12.66	2.99	11.85	3.12	9.38	3.43
	18	14.54	2.58	14.21	2.63	12.55	2.89	11.56	3.04	10.83	3.18	8.88	3.53
	20	14.08	2.67	13.69	2.72	11.76	2.94	10.60	3.08	9.93	3.21	8.33	3.53
	21	13.90	2.72	13.49	2.76	11.41	2.93	10.16	3.03	9.52	3.18	8.04	3.54
	22	13.78	2.77	13.50	2.81	12.08	2.99	11.23	3.11	10.30	3.24	7.72	3.55
	24	13.70	2.88	13.19	2.90	10.63	3.05	9.10	3.13	8.49	3.27	7.06	3.57
2.5 + 3.5 + 3.5	16	15.12	2.56	14.84	2.61	13.40	2.90	12.55	3.07	11.74	3.20	9.29	3.52
	18	14.40	2.65	14.08	2.70	12.43	2.96	11.45	3.12	10.72	3.26	8.80	3.62
	20	13.94	2.74	13.56	2.79	11.65	3.02	10.50	3.16	9.83	3.30	8.25	3.62
	21	13.77	2.79	13.36	2.83	11.30	3.00	10.07	3.11	9.43	3.26	7.96	3.63
	22	13.65	2.85	13.37	2.88	11.96	3.07	11.12	3.19	10.21	3.32	7.65	3.65
	24	13.57	2.95	13.06	2.98	10.53	3.13	9.02	3.21	8.41	3.35	6.99	3.67
2.5 + 3.5 + 4.2	16	15.12	2.55	14.84	2.61	13.40	2.89	12.55	3.06	11.74	3.19	9.29	3.50
	18	14.40	2.64	14.08	2.69	12.43	2.95	11.45	3.11	10.72	3.25	8.80	3.61
	20	13.94	2.73	13.56	2.78	11.65	3.01	10.50	3.15	9.83	3.29	8.25	3.61
	21	13.77	2.78	13.36	2.82	11.30	2.99	10.07	3.10	9.43	3.25	7.96	3.62
	22	13.65	2.84	13.37	2.87	11.96	3.06	11.12	3.18	10.21	3.31	7.65	3.64
	24	13.57	2.94	13.06	2.97	10.53	3.12	9.02	3.20	8.41	3.34	6.99	3.65
2.5 + 3.5 + 5.0	16	15.12	2.43	14.84	2.48	13.40	2.75	12.55	2.91	11.74	3.04	9.29	3.34
	18	14.40	2.51	14.08	2.56	12.43	2.81	11.45	2.96	10.72	3.10	8.80	3.44
	20	13.94	2.60	13.56	2.65	11.65	2.87	10.50	3.00	9.83	3.13	8.25	3.44
	21	13.77	2.65	13.36	2.68	11.30	2.85	10.07	2.95	9.43	3.09	7.96	3.45
	22	13.65	2.70	13.37	2.74	11.96	2.92	11.12	3.02	10.21	3.15	7.65	3.46
	24	13.57	2.80	13.06	2.83	10.53	2.97	9.02	3.05	8.41	3.18	6.99	3.48

Combination (Capacity)	Indoor Air Temp. °C DB	Outdoor Air Temp. °C									
		0/-1		-5/-6		-7/-8		-10/-11		-15/-	
		Total Q	Input Power	Total Q	Input Power	Total Q	Input Power	Total Q	Input Power	Total Q	Input Power
2.5 + 2.5 + 5.0	16	9.03	3.39	8.37	3.43	8.11	3.45	7.81	3.28	7.16	3.22
	18	8.57	3.46	8.00	3.42	7.77	3.41	7.66	3.26	7.22	3.21
	20	8.10	3.45	7.71	3.40	7.55	3.38	7.53	3.28	7.12	3.21
	21	7.78	3.46	7.32	3.41	7.14	3.38	7.25	3.29	7.00	3.24
	22	7.61	3.47	7.50	3.41	7.46	3.38	7.41	3.31	6.83	3.24
	24	7.10	3.52	7.36	3.44	7.47	3.41	7.32	3.36	6.38	3.30
2.5 + 2.5 + 6.0	16	9.03	3.39	8.37	3.43	8.11	3.45	7.81	3.28	7.16	3.22
	18	8.57	3.46	8.00	3.42	7.77	3.41	7.66	3.26	7.22	3.21
	20	8.10	3.45	7.71	3.40	7.55	3.38	7.53	3.28	7.12	3.21
	21	7.78	3.46	7.32	3.41	7.14	3.38	7.25	3.29	7.00	3.24
	22	7.61	3.47	7.50	3.41	7.46	3.38	7.41	3.31	6.83	3.24
	24	7.10	3.52	7.36	3.44	7.47	3.41	7.32	3.36	6.38	3.30
2.5 + 2.5 + 7.1	16	9.12	3.44	8.45	3.49	8.19	3.50	7.88	3.34	7.23	3.27
	18	8.65	3.51	8.08	3.48	7.85	3.47	7.73	3.32	7.28	3.26
	20	8.17	3.51	7.78	3.46	7.62	3.44	7.60	3.33	7.18	3.26
	21	7.85	3.52	7.39	3.46	7.21	3.44	7.32	3.34	7.07	3.30
	22	7.68	3.53	7.57	3.47	7.53	3.44	7.48	3.36	6.89	3.30
	24	7.16	3.57	7.43	3.50	7.54	3.47	7.39	3.42	6.44	3.36
2.5 + 3.5 + 3.5	16	9.03	3.53	8.37	3.58	8.11	3.59	7.81	3.42	7.16	3.36
	18	8.57	3.61	8.00	3.57	7.77	3.56	7.66	3.40	7.22	3.35
	20	8.10	3.60	7.71	3.55	7.55	3.53	7.53	3.42	7.12	3.35
	21	7.78	3.61	7.32	3.55	7.14	3.53	7.25	3.43	7.00	3.38
	22	7.61	3.62	7.50	3.56	7.46	3.53	7.41	3.45	6.83	3.38
	24	7.10	3.67	7.36	3.59	7.47	3.56	7.32	3.51	6.38	3.44
2.5 + 3.5 + 4.2	16	9.03	3.52	8.37	3.57	8.11	3.58	7.81	3.41	7.16	3.35
	18	8.57	3.59	8.00	3.56	7.77	3.54	7.66	3.39	7.22	3.34
	20	8.10	3.59	7.71	3.54	7.55	3.52	7.53	3.41	7.12	3.34
	21	7.78	3.60	7.32	3.54	7.14	3.52	7.25	3.42	7.00	3.37
	22	7.61	3.61	7.50	3.54	7.46	3.52	7.41	3.44	6.83	3.37
	24	7.10	3.66	7.36	3.58	7.47	3.54	7.32	3.49	6.38	3.43
2.5 + 3.5 + 5.0	16	9.03	3.35	8.37	3.40	8.11	3.41	7.81	3.25	7.16	3.19
	18	8.57	3.42	8.00	3.39	7.77	3.38	7.66	3.23	7.22	3.18
	20	8.10	3.42	7.71	3.37	7.55	3.35	7.53	3.25	7.12	3.18
	21	7.78	3.43	7.32	3.37	7.14	3.35	7.25	3.26	7.00	3.21
	22	7.61	3.44	7.50	3.38	7.46	3.35	7.41	3.28	6.83	3.21
	24	7.10	3.48	7.36	3.41	7.47	3.38	7.32	3.33	6.38	3.27

Combination (Capacity)	Indoor Air Temp. °C DB	Outdoor Air Temp. °C											
		16/15		15/14		10/9		7/6		6/5		2/1	
		Total Q	Input Power	Total Q	Input Power	Total Q	Input Power	Total Q	Input Power	Total Q	Input Power	Total Q	Input Power
2.5 + 3.5 + 6.0	16	15.27	2.48	14.98	2.53	13.53	2.81	12.66	2.97	11.85	3.10	9.38	3.40
	18	14.54	2.56	14.21	2.62	12.55	2.87	11.56	3.02	10.83	3.16	8.88	3.51
	20	14.08	2.65	13.69	2.70	11.76	2.92	10.60	3.06	9.93	3.19	8.33	3.51
	21	13.90	2.70	13.49	2.74	11.41	2.91	10.16	3.01	9.52	3.15	8.04	3.52
	22	13.78	2.76	13.50	2.79	12.08	2.98	11.23	3.09	10.30	3.22	7.72	3.53
	24	13.70	2.86	13.19	2.89	10.63	3.03	9.10	3.11	8.49	3.25	7.06	3.55
2.5 + 3.5 + 7.1	16	15.27	2.46	14.98	2.51	13.53	2.79	12.66	2.95	11.85	3.08	9.38	3.38
	18	14.54	2.55	14.21	2.60	12.55	2.85	11.56	3.00	10.83	3.14	8.88	3.48
	20	14.08	2.64	13.69	2.68	11.76	2.91	10.60	3.04	9.93	3.17	8.33	3.48
	21	13.90	2.69	13.49	2.72	11.41	2.89	10.16	2.99	9.52	3.13	8.04	3.50
	22	13.78	2.74	13.50	2.77	12.08	2.96	11.23	3.07	10.30	3.20	7.72	3.51
	24	13.70	2.84	13.19	2.87	10.63	3.01	9.10	3.09	8.49	3.23	7.06	3.53
2.5 + 4.2 + 4.2	16	15.12	2.54	14.84	2.60	13.40	2.88	12.55	3.05	11.74	3.18	9.29	3.49
	18	14.40	2.63	14.08	2.68	12.43	2.94	11.45	3.10	10.72	3.24	8.80	3.60
	20	13.94	2.72	13.56	2.77	11.65	3.00	10.50	3.14	9.83	3.28	8.25	3.60
	21	13.77	2.78	13.36	2.81	11.30	2.98	10.07	3.09	9.43	3.24	7.96	3.61
	22	13.65	2.83	13.37	2.86	11.96	3.05	11.12	3.17	10.21	3.30	7.65	3.62
	24	13.57	2.93	13.06	2.96	10.53	3.11	9.02	3.19	8.41	3.33	6.99	3.64
2.5 + 4.2 + 5.0	16	15.27	2.47	14.98	2.52	13.53	2.80	12.66	2.96	11.85	3.09	9.38	3.39
	18	14.54	2.56	14.21	2.61	12.55	2.86	11.56	3.01	10.83	3.15	8.88	3.49
	20	14.08	2.65	13.69	2.69	11.76	2.92	10.60	3.05	9.93	3.18	8.33	3.49
	21	13.90	2.70	13.49	2.73	11.41	2.90	10.16	3.00	9.52	3.14	8.04	3.51
	22	13.78	2.75	13.50	2.78	12.08	2.97	11.23	3.08	10.30	3.21	7.72	3.52
	24	13.70	2.85	13.19	2.88	10.63	3.02	9.10	3.10	8.49	3.24	7.06	3.54
2.5 + 4.2 + 6.0	16	15.27	2.47	14.98	2.52	13.53	2.80	12.66	2.96	11.85	3.09	9.38	3.39
	18	14.54	2.56	14.21	2.61	12.55	2.86	11.56	3.01	10.83	3.15	8.88	3.49
	20	14.08	2.65	13.69	2.69	11.76	2.92	10.60	3.05	9.93	3.18	8.33	3.49
	21	13.90	2.70	13.49	2.73	11.41	2.90	10.16	3.00	9.52	3.14	8.04	3.51
	22	13.78	2.75	13.50	2.78	12.08	2.97	11.23	3.08	10.30	3.21	7.72	3.52
	24	13.70	2.85	13.19	2.88	10.63	3.02	9.10	3.10	8.49	3.24	7.06	3.54
2.5 + 4.2 + 7.1	16	15.27	2.45	14.98	2.51	13.53	2.78	12.66	2.94	11.85	3.07	9.38	3.37
	18	14.54	2.54	14.21	2.59	12.55	2.84	11.56	2.99	10.83	3.13	8.88	3.47
	20	14.08	2.63	13.69	2.67	11.76	2.90	10.60	3.03	9.93	3.16	8.33	3.47
	21	13.90	2.68	13.49	2.71	11.41	2.88	10.16	2.98	9.52	3.12	8.04	3.48
	22	13.78	2.73	13.50	2.76	12.08	2.95	11.23	3.06	10.30	3.19	7.72	3.50
	24	13.70	2.83	13.19	2.86	10.63	3.00	9.10	3.08	8.49	3.22	7.06	3.51

Combination (Capacity)	Indoor Air Temp. °C DB	Outdoor Air Temp. °C									
		0/-1		-5/-6		-7/-8		-10/-11		-15/-	
		Total Q	Input Power	Total Q	Input Power	Total Q	Input Power	Total Q	Input Power	Total Q	Input Power
2.5 + 3.5 + 6.0	16	9.12	3.42	8.45	3.46	8.19	3.48	7.88	3.31	7.23	3.25
	18	8.65	3.49	8.08	3.46	7.85	3.44	7.73	3.29	7.28	3.24
	20	8.17	3.49	7.78	3.44	7.62	3.42	7.60	3.31	7.18	3.24
	21	7.85	3.50	7.39	3.44	7.21	3.42	7.32	3.32	7.07	3.27
	22	7.68	3.51	7.57	3.44	7.53	3.42	7.48	3.34	6.89	3.27
	24	7.16	3.55	7.43	3.47	7.54	3.44	7.39	3.39	6.44	3.34
2.5 + 3.5 + 7.1	16	9.12	3.40	8.45	3.44	8.19	3.46	7.88	3.29	7.23	3.23
	18	8.65	3.47	8.08	3.43	7.85	3.42	7.73	3.27	7.28	3.22
	20	8.17	3.46	7.78	3.41	7.62	3.39	7.60	3.29	7.18	3.22
	21	7.85	3.47	7.39	3.42	7.21	3.39	7.32	3.30	7.07	3.25
	22	7.68	3.48	7.57	3.42	7.53	3.39	7.48	3.32	6.89	3.25
	24	7.16	3.53	7.43	3.45	7.54	3.42	7.39	3.37	6.44	3.31
2.5 + 4.2 + 4.2	16	9.03	3.51	8.37	3.55	8.11	3.57	7.81	3.40	7.16	3.34
	18	8.57	3.58	8.00	3.55	7.77	3.53	7.66	3.38	7.22	3.33
	20	8.10	3.58	7.71	3.53	7.55	3.51	7.53	3.40	7.12	3.33
	21	7.78	3.59	7.32	3.53	7.14	3.51	7.25	3.41	7.00	3.36
	22	7.61	3.60	7.50	3.53	7.46	3.51	7.41	3.43	6.83	3.36
	24	7.10	3.64	7.36	3.56	7.47	3.53	7.32	3.48	6.38	3.42
2.5 + 4.2 + 5.0	16	9.12	3.41	8.45	3.45	8.19	3.47	7.88	3.30	7.23	3.24
	18	8.65	3.48	8.08	3.45	7.85	3.43	7.73	3.28	7.28	3.23
	20	8.17	3.47	7.78	3.43	7.62	3.41	7.60	3.30	7.18	3.23
	21	7.85	3.48	7.39	3.43	7.21	3.41	7.32	3.31	7.07	3.26
	22	7.68	3.49	7.57	3.43	7.53	3.41	7.48	3.33	6.89	3.26
	24	7.16	3.54	7.43	3.46	7.54	3.43	7.39	3.38	6.44	3.32
2.5 + 4.2 + 6.0	16	9.12	3.41	8.45	3.45	8.19	3.47	7.88	3.30	7.23	3.24
	18	8.65	3.48	8.08	3.45	7.85	3.43	7.73	3.28	7.28	3.23
	20	8.17	3.47	7.78	3.43	7.62	3.41	7.60	3.30	7.18	3.23
	21	7.85	3.48	7.39	3.43	7.21	3.41	7.32	3.31	7.07	3.26
	22	7.68	3.49	7.57	3.43	7.53	3.41	7.48	3.33	6.89	3.26
	24	7.16	3.54	7.43	3.46	7.54	3.43	7.39	3.38	6.44	3.32
2.5 + 4.2 + 7.1	16	9.12	3.39	8.45	3.43	8.19	3.45	7.88	3.28	7.23	3.22
	18	8.65	3.46	8.08	3.42	7.85	3.41	7.73	3.26	7.28	3.21
	20	8.17	3.45	7.78	3.40	7.62	3.38	7.60	3.28	7.18	3.21
	21	7.85	3.46	7.39	3.41	7.21	3.38	7.32	3.29	7.07	3.24
	22	7.68	3.47	7.57	3.41	7.53	3.38	7.48	3.31	6.89	3.24
	24	7.16	3.52	7.43	3.44	7.54	3.41	7.39	3.36	6.44	3.30

Combination (Capacity)	Indoor Air Temp. °C DB	Outdoor Air Temp. °C											
		16/15		15/14		10/9		7/6		6/5		2/1	
		Total Q	Input Power	Total Q	Input Power	Total Q	Input Power	Total Q	Input Power	Total Q	Input Power	Total Q	Input Power
2.5 + 5.0 + 5.0	16	15.27	2.36	14.98	2.42	13.53	2.68	12.66	2.84	11.85	2.96	9.38	3.25
	18	14.54	2.45	14.21	2.50	12.55	2.74	11.56	2.88	10.83	3.02	8.88	3.35
	20	14.08	2.53	13.69	2.58	11.76	2.79	10.60	2.92	9.93	3.05	8.33	3.35
	21	13.90	2.58	13.49	2.61	11.41	2.78	10.16	2.87	9.52	3.01	8.04	3.36
	22	13.78	2.63	13.50	2.66	12.08	2.84	11.23	2.94	10.30	3.07	7.72	3.37
	24	13.70	2.73	13.19	2.75	10.63	2.89	9.10	2.97	8.49	3.10	7.06	3.39
2.5 + 5.0 + 6.0	16	15.27	2.36	14.98	2.42	13.53	2.68	12.66	2.84	11.85	2.96	9.38	3.25
	18	14.54	2.45	14.21	2.50	12.55	2.74	11.56	2.88	10.83	3.02	8.88	3.35
	20	14.08	2.53	13.69	2.58	11.76	2.79	10.60	2.92	9.93	3.05	8.33	3.35
	21	13.90	2.58	13.49	2.61	11.41	2.78	10.16	2.87	9.52	3.01	8.04	3.36
	22	13.78	2.63	13.50	2.66	12.08	2.84	11.23	2.94	10.30	3.07	7.72	3.37
	24	13.70	2.73	13.19	2.75	10.63	2.89	9.10	2.97	8.49	3.10	7.06	3.39
2.5 + 5.0 + 7.1	16	15.27	2.35	14.98	2.41	13.53	2.67	12.66	2.83	11.85	2.95	9.38	3.24
	18	14.54	2.44	14.21	2.49	12.55	2.73	11.56	2.87	10.83	3.01	8.88	3.33
	20	14.08	2.52	13.69	2.57	11.76	2.78	10.60	2.91	9.93	3.04	8.33	3.33
	21	13.90	2.57	13.49	2.60	11.41	2.77	10.16	2.86	9.52	3.00	8.04	3.35
	22	13.78	2.62	13.50	2.66	12.08	2.83	11.23	2.93	10.30	3.06	7.72	3.36
	24	13.70	2.72	13.19	2.74	10.63	2.88	9.10	2.96	8.49	3.09	7.06	3.38
2.5 + 6.0 + 6.0	16	15.27	2.36	14.98	2.42	13.53	2.68	12.66	2.84	11.85	2.96	9.38	3.25
	18	14.54	2.45	14.21	2.50	12.55	2.74	11.56	2.88	10.83	3.02	8.88	3.35
	20	14.08	2.53	13.69	2.58	11.76	2.79	10.60	2.92	9.93	3.05	8.33	3.35
	21	13.90	2.58	13.49	2.61	11.41	2.78	10.16	2.87	9.52	3.01	8.04	3.36
	22	13.78	2.63	13.50	2.66	12.08	2.84	11.23	2.94	10.30	3.07	7.72	3.37
	24	13.70	2.73	13.19	2.75	10.63	2.89	9.10	2.97	8.49	3.10	7.06	3.39
3.5 + 3.5 + 3.5	16	15.12	2.53	14.84	2.59	13.40	2.87	12.55	3.04	11.74	3.17	9.29	3.48
	18	14.40	2.62	14.08	2.68	12.43	2.94	11.45	3.09	10.72	3.23	8.80	3.59
	20	13.94	2.71	13.56	2.76	11.65	2.99	10.50	3.13	9.83	3.27	8.25	3.59
	21	13.77	2.77	13.36	2.80	11.30	2.97	10.07	3.08	9.43	3.23	7.96	3.60
	22	13.65	2.82	13.37	2.86	11.96	3.04	11.12	3.16	10.21	3.29	7.65	3.61
	24	13.57	2.92	13.06	2.95	10.53	3.10	9.02	3.18	8.41	3.32	6.99	3.63
3.5 + 3.5 + 4.2	16	15.27	2.56	14.98	2.62	13.53	2.91	12.66	3.08	11.85	3.21	9.38	3.53
	18	14.54	2.66	14.21	2.71	12.55	2.97	11.56	3.13	10.83	3.28	8.88	3.63
	20	14.08	2.75	13.69	2.80	11.76	3.03	10.60	3.17	9.93	3.31	8.33	3.63
	21	13.90	2.80	13.49	2.84	11.41	3.01	10.16	3.12	9.52	3.27	8.04	3.65
	22	13.78	2.85	13.50	2.89	12.08	3.08	11.23	3.20	10.30	3.33	7.72	3.66
	24	13.70	2.96	13.19	2.99	10.63	3.13	9.10	3.22	8.49	3.36	7.06	3.68

Combination (Capacity)	Indoor Air Temp. °C DB	Outdoor Air Temp. °C									
		0/-1		-5/-6		-7/-8		-10/-11		-15/-	
		Total Q	Input Power	Total Q	Input Power	Total Q	Input Power	Total Q	Input Power	Total Q	Input Power
2.5 + 5.0 + 5.0	16	9.12	3.26	8.45	3.31	8.19	3.32	7.88	3.16	7.23	3.10
	18	8.65	3.33	8.08	3.30	7.85	3.29	7.73	3.14	7.28	3.10
	20	8.17	3.33	7.78	3.28	7.62	3.26	7.60	3.16	7.18	3.10
	21	7.85	3.34	7.39	3.28	7.21	3.26	7.32	3.17	7.07	3.12
	22	7.68	3.35	7.57	3.29	7.53	3.26	7.48	3.19	6.89	3.12
	24	7.16	3.39	7.43	3.31	7.54	3.29	7.39	3.24	6.44	3.18
2.5 + 5.0 + 6.0	16	9.12	3.26	8.45	3.31	8.19	3.32	7.88	3.16	7.23	3.10
	18	8.65	3.33	8.08	3.30	7.85	3.29	7.73	3.14	7.28	3.10
	20	8.17	3.33	7.78	3.28	7.62	3.26	7.60	3.16	7.18	3.10
	21	7.85	3.34	7.39	3.28	7.21	3.26	7.32	3.17	7.07	3.12
	22	7.68	3.35	7.57	3.29	7.53	3.26	7.48	3.19	6.89	3.12
	24	7.16	3.39	7.43	3.31	7.54	3.29	7.39	3.24	6.44	3.18
2.5 + 5.0 + 7.1	16	9.12	3.25	8.45	3.29	8.19	3.31	7.88	3.15	7.23	3.09
	18	8.65	3.32	8.08	3.29	7.85	3.27	7.73	3.13	7.28	3.08
	20	8.17	3.32	7.78	3.27	7.62	3.25	7.60	3.15	7.18	3.08
	21	7.85	3.32	7.39	3.27	7.21	3.25	7.32	3.16	7.07	3.11
	22	7.68	3.33	7.57	3.27	7.53	3.25	7.48	3.18	6.89	3.11
	24	7.16	3.38	7.43	3.30	7.54	3.27	7.39	3.23	6.44	3.17
2.5 + 6.0 + 6.0	16	9.12	3.26	8.45	3.31	8.19	3.32	7.88	3.16	7.23	3.10
	18	8.65	3.33	8.08	3.30	7.85	3.29	7.73	3.14	7.28	3.10
	20	8.17	3.33	7.78	3.28	7.62	3.26	7.60	3.16	7.18	3.10
	21	7.85	3.34	7.39	3.28	7.21	3.26	7.32	3.17	7.07	3.12
	22	7.68	3.35	7.57	3.29	7.53	3.26	7.48	3.19	6.89	3.12
	24	7.16	3.39	7.43	3.31	7.54	3.29	7.39	3.24	6.44	3.18
3.5 + 3.5 + 3.5	16	9.03	3.50	8.37	3.54	8.11	3.56	7.81	3.39	7.16	3.32
	18	8.57	3.57	8.00	3.54	7.77	3.52	7.66	3.37	7.22	3.32
	20	8.10	3.57	7.71	3.52	7.55	3.50	7.53	3.39	7.12	3.32
	21	7.78	3.58	7.32	3.52	7.14	3.50	7.25	3.40	7.00	3.35
	22	7.61	3.59	7.50	3.52	7.46	3.50	7.41	3.42	6.83	3.35
	24	7.10	3.63	7.36	3.55	7.47	3.52	7.32	3.47	6.38	3.41
3.5 + 3.5 + 4.2	16	9.12	3.54	8.45	3.59	8.19	3.61	7.88	3.43	7.23	3.37
	18	8.65	3.62	8.08	3.58	7.85	3.57	7.73	3.41	7.28	3.36
	20	8.17	3.61	7.78	3.56	7.62	3.54	7.60	3.43	7.18	3.36
	21	7.85	3.62	7.39	3.56	7.21	3.54	7.32	3.44	7.07	3.39
	22	7.68	3.63	7.57	3.57	7.53	3.54	7.48	3.46	6.89	3.39
	24	7.16	3.68	7.43	3.60	7.54	3.57	7.39	3.52	6.44	3.46

Combination (Capacity)	Indoor Air Temp. °C DB	Outdoor Air Temp. °C											
		16/15		15/14		10/9		7/6		6/5		2/1	
		Total Q	Input Power	Total Q	Input Power	Total Q	Input Power	Total Q	Input Power	Total Q	Input Power	Total Q	Input Power
3.5 + 3.5 + 5.0	16	15.27	2.45	14.98	2.51	13.53	2.78	12.66	2.94	11.85	3.07	9.38	3.37
	18	14.54	2.54	14.21	2.59	12.55	2.84	11.56	2.99	10.83	3.13	8.88	3.47
	20	14.08	2.63	13.69	2.67	11.76	2.90	10.60	3.03	9.93	3.16	8.33	3.47
	21	13.90	2.68	13.49	2.71	11.41	2.88	10.16	2.98	9.52	3.12	8.04	3.48
	22	13.78	2.73	13.50	2.76	12.08	2.95	11.23	3.06	10.30	3.19	7.72	3.50
	24	13.70	2.83	13.19	2.86	10.63	3.00	9.10	3.08	8.49	3.22	7.06	3.51
3.5 + 3.5 + 6.0	16	15.27	2.45	14.98	2.51	13.53	2.78	12.66	2.94	11.85	3.07	9.38	3.37
	18	14.54	2.54	14.21	2.59	12.55	2.84	11.56	2.99	10.83	3.13	8.88	3.47
	20	14.08	2.63	13.69	2.67	11.76	2.90	10.60	3.03	9.93	3.16	8.33	3.47
	21	13.90	2.68	13.49	2.71	11.41	2.88	10.16	2.98	9.52	3.12	8.04	3.48
	22	13.78	2.73	13.50	2.76	12.08	2.95	11.23	3.06	10.30	3.19	7.72	3.50
	24	13.70	2.83	13.19	2.86	10.63	3.00	9.10	3.08	8.49	3.22	7.06	3.51
3.5 + 3.5 + 7.1	16	15.27	2.44	14.98	2.49	13.53	2.76	12.66	2.92	11.85	3.05	9.38	3.35
	18	14.54	2.52	14.21	2.57	12.55	2.82	11.56	2.97	10.83	3.11	8.88	3.45
	20	14.08	2.61	13.69	2.65	11.76	2.88	10.60	3.01	9.93	3.14	8.33	3.45
	21	13.90	2.66	13.49	2.69	11.41	2.86	10.16	2.96	9.52	3.10	8.04	3.46
	22	13.78	2.71	13.50	2.75	12.08	2.93	11.23	3.03	10.30	3.16	7.72	3.47
	24	13.70	2.81	13.19	2.84	10.63	2.98	9.10	3.06	8.49	3.19	7.06	3.49
3.5 + 4.2 + 4.2	16	15.27	2.56	14.98	2.61	13.53	2.90	12.66	3.07	11.85	3.20	9.38	3.52
	18	14.54	2.65	14.21	2.70	12.55	2.96	11.56	3.12	10.83	3.26	8.88	3.62
	20	14.08	2.74	13.69	2.79	11.76	3.02	10.60	3.16	9.93	3.30	8.33	3.62
	21	13.90	2.79	13.49	2.83	11.41	3.00	10.16	3.11	9.52	3.26	8.04	3.63
	22	13.78	2.85	13.50	2.88	12.08	3.07	11.23	3.19	10.30	3.32	7.72	3.65
	24	13.70	2.95	13.19	2.98	10.63	3.13	9.10	3.21	8.49	3.35	7.06	3.67
3.5 + 4.2 + 5.0	16	15.27	2.44	14.98	2.50	13.53	2.77	12.66	2.93	11.85	3.06	9.38	3.36
	18	14.54	2.53	14.21	2.58	12.55	2.83	11.56	2.98	10.83	3.12	8.88	3.46
	20	14.08	2.62	13.69	2.66	11.76	2.89	10.60	3.02	9.93	3.15	8.33	3.46
	21	13.90	2.67	13.49	2.70	11.41	2.87	10.16	2.97	9.52	3.11	8.04	3.47
	22	13.78	2.72	13.50	2.76	12.08	2.94	11.23	3.05	10.30	3.18	7.72	3.49
	24	13.70	2.82	13.19	2.85	10.63	2.99	9.10	3.07	8.49	3.21	7.06	3.50
3.5 + 4.2 + 6.0	16	15.27	2.44	14.98	2.50	13.53	2.77	12.66	2.93	11.85	3.06	9.38	3.36
	18	14.54	2.53	14.21	2.58	12.55	2.83	11.56	2.98	10.83	3.12	8.88	3.46
	20	14.08	2.62	13.69	2.66	11.76	2.89	10.60	3.02	9.93	3.15	8.33	3.46
	21	13.90	2.67	13.49	2.70	11.41	2.87	10.16	2.97	9.52	3.11	8.04	3.47
	22	13.78	2.72	13.50	2.76	12.08	2.94	11.23	3.05	10.30	3.18	7.72	3.49
	24	13.70	2.82	13.19	2.85	10.63	2.99	9.10	3.07	8.49	3.21	7.06	3.50



Combination (Capacity)	Indoor Air Temp. °C DB	Outdoor Air Temp. °C									
		0/-1		-5/-6		-7/-8		-10/-11		-15/-	
		Total Q	Input Power	Total Q	Input Power	Total Q	Input Power	Total Q	Input Power	Total Q	Input Power
3.5 + 3.5 + 5.0	16	9.12	3.39	8.45	3.43	8.19	3.45	7.88	3.28	7.23	3.22
	18	8.65	3.46	8.08	3.42	7.85	3.41	7.73	3.26	7.28	3.21
	20	8.17	3.45	7.78	3.40	7.62	3.38	7.60	3.28	7.18	3.21
	21	7.85	3.46	7.39	3.41	7.21	3.38	7.32	3.29	7.07	3.24
	22	7.68	3.47	7.57	3.41	7.53	3.38	7.48	3.31	6.89	3.24
	24	7.16	3.52	7.43	3.44	7.54	3.41	7.39	3.36	6.44	3.30
3.5 + 3.5 + 6.0	16	9.12	3.39	8.45	3.43	8.19	3.45	7.88	3.28	7.23	3.22
	18	8.65	3.46	8.08	3.42	7.85	3.41	7.73	3.26	7.28	3.21
	20	8.17	3.45	7.78	3.40	7.62	3.38	7.60	3.28	7.18	3.21
	21	7.85	3.46	7.39	3.41	7.21	3.38	7.32	3.29	7.07	3.24
	22	7.68	3.47	7.57	3.41	7.53	3.38	7.48	3.31	6.89	3.24
	24	7.16	3.52	7.43	3.44	7.54	3.41	7.39	3.36	6.44	3.30
3.5 + 3.5 + 7.1	16	9.12	3.37	8.45	3.41	8.19	3.42	7.88	3.26	7.23	3.20
	18	8.65	3.43	8.08	3.40	7.85	3.39	7.73	3.24	7.28	3.19
	20	8.17	3.43	7.78	3.38	7.62	3.36	7.60	3.26	7.18	3.19
	21	7.85	3.44	7.39	3.38	7.21	3.36	7.32	3.27	7.07	3.22
	22	7.68	3.45	7.57	3.39	7.53	3.36	7.48	3.29	6.89	3.22
	24	7.16	3.49	7.43	3.42	7.54	3.39	7.39	3.34	6.44	3.28
3.5 + 4.2 + 4.2	16	9.12	3.53	8.45	3.58	8.19	3.59	7.88	3.42	7.23	3.36
	18	8.65	3.61	8.08	3.57	7.85	3.56	7.73	3.40	7.28	3.35
	20	8.17	3.60	7.78	3.55	7.62	3.53	7.60	3.42	7.18	3.35
	21	7.85	3.61	7.39	3.55	7.21	3.53	7.32	3.43	7.07	3.38
	22	7.68	3.62	7.57	3.56	7.53	3.53	7.48	3.45	6.89	3.38
	24	7.16	3.67	7.43	3.59	7.54	3.56	7.39	3.51	6.44	3.44
3.5 + 4.2 + 5.0	16	9.12	3.38	8.45	3.42	8.19	3.44	7.88	3.27	7.23	3.21
	18	8.65	3.45	8.08	3.41	7.85	3.40	7.73	3.25	7.28	3.20
	20	8.17	3.44	7.78	3.39	7.62	3.37	7.60	3.27	7.18	3.20
	21	7.85	3.45	7.39	3.39	7.21	3.37	7.32	3.28	7.07	3.23
	22	7.68	3.46	7.57	3.40	7.53	3.37	7.48	3.30	6.89	3.23
	24	7.16	3.50	7.43	3.43	7.54	3.40	7.39	3.35	6.44	3.29
3.5 + 4.2 + 6.0	16	9.12	3.38	8.45	3.42	8.19	3.44	7.88	3.27	7.23	3.21
	18	8.65	3.45	8.08	3.41	7.85	3.40	7.73	3.25	7.28	3.20
	20	8.17	3.44	7.78	3.39	7.62	3.37	7.60	3.27	7.18	3.20
	21	7.85	3.45	7.39	3.39	7.21	3.37	7.32	3.28	7.07	3.23
	22	7.68	3.46	7.57	3.40	7.53	3.37	7.48	3.30	6.89	3.23
	24	7.16	3.50	7.43	3.43	7.54	3.40	7.39	3.35	6.44	3.29

Combination (Capacity)	Indoor Air Temp. °C DB	Outdoor Air Temp. °C											
		16/15		15/14		10/9		7/6		6/5		2/1	
		Total Q	Input Power	Total Q	Input Power	Total Q	Input Power	Total Q	Input Power	Total Q	Input Power	Total Q	Input Power
3.5 + 5.0 + 5.0	16	15.27	2.34	14.98	2.39	13.53	2.65	12.66	2.81	11.85	2.93	9.38	3.22
	18	14.54	2.42	14.21	2.47	12.55	2.71	11.56	2.85	10.83	2.99	8.88	3.31
	20	14.08	2.51	13.69	2.55	11.76	2.76	10.60	2.89	9.93	3.01	8.33	3.31
	21	13.90	2.55	13.49	2.59	11.41	2.75	10.16	2.84	9.52	2.98	8.04	3.32
	22	13.78	2.60	13.50	2.64	12.08	2.81	11.23	2.91	10.30	3.04	7.72	3.34
	24	13.70	2.70	13.19	2.72	10.63	2.86	9.10	2.94	8.49	3.07	7.06	3.35
3.5 + 5.0 + 6.0	16	15.27	2.34	14.98	2.39	13.53	2.65	12.66	2.81	11.85	2.93	9.38	3.22
	18	14.54	2.42	14.21	2.47	12.55	2.71	11.56	2.85	10.83	2.99	8.88	3.31
	20	14.08	2.51	13.69	2.55	11.76	2.76	10.60	2.89	9.93	3.01	8.33	3.31
	21	13.90	2.55	13.49	2.59	11.41	2.75	10.16	2.84	9.52	2.98	8.04	3.32
	22	13.78	2.60	13.50	2.64	12.08	2.81	11.23	2.91	10.30	3.04	7.72	3.34
	24	13.70	2.70	13.19	2.72	10.63	2.86	9.10	2.94	8.49	3.07	7.06	3.35
4.2 + 4.2 + 4.2	16	15.27	2.55	14.98	2.61	13.53	2.89	12.66	3.06	11.85	3.19	9.38	3.50
	18	14.54	2.64	14.21	2.69	12.55	2.95	11.56	3.11	10.83	3.25	8.88	3.61
	20	14.08	2.73	13.69	2.78	11.76	3.01	10.60	3.15	9.93	3.29	8.33	3.61
	21	13.90	2.78	13.49	2.82	11.41	2.99	10.16	3.10	9.52	3.25	8.04	3.62
	22	13.78	2.84	13.50	2.87	12.08	3.06	11.23	3.18	10.30	3.31	7.72	3.64
	24	13.70	2.94	13.19	2.97	10.63	3.12	9.10	3.20	8.49	3.34	7.06	3.65
4.2 + 4.2 + 5.0	16	15.27	2.43	14.98	2.48	13.53	2.75	12.66	2.91	11.85	3.04	9.38	3.34
	18	14.54	2.51	14.21	2.56	12.55	2.81	11.56	2.96	10.83	3.10	8.88	3.44
	20	14.08	2.60	13.69	2.65	11.76	2.87	10.60	3.00	9.93	3.13	8.33	3.44
	21	13.90	2.65	13.49	2.68	11.41	2.85	10.16	2.95	9.52	3.09	8.04	3.45
	22	13.78	2.70	13.50	2.74	12.08	2.92	11.23	3.02	10.30	3.15	7.72	3.46
	24	13.70	2.80	13.19	2.83	10.63	2.97	9.10	3.05	8.49	3.18	7.06	3.48
4.2 + 4.2 + 6.0	16	15.27	2.43	14.98	2.48	13.53	2.75	12.66	2.91	11.85	3.04	9.38	3.34
	18	14.54	2.51	14.21	2.56	12.55	2.81	11.56	2.96	10.83	3.10	8.88	3.44
	20	14.08	2.60	13.69	2.65	11.76	2.87	10.60	3.00	9.93	3.13	8.33	3.44
	21	13.90	2.65	13.49	2.68	11.41	2.85	10.16	2.95	9.52	3.09	8.04	3.45
	22	13.78	2.70	13.50	2.74	12.08	2.92	11.23	3.02	10.30	3.15	7.72	3.46
	24	13.70	2.80	13.19	2.83	10.63	2.97	9.10	3.05	8.49	3.18	7.06	3.48
4.2 + 5.0 + 5.0	16	15.27	2.33	14.98	2.38	13.53	2.64	12.66	2.80	11.85	2.92	9.38	3.20
	18	14.54	2.41	14.21	2.46	12.55	2.70	11.56	2.84	10.83	2.98	8.88	3.30
	20	14.08	2.50	13.69	2.54	11.76	2.75	10.60	2.88	9.93	3.00	8.33	3.30
	21	13.90	2.55	13.49	2.58	11.41	2.74	10.16	2.83	9.52	2.97	8.04	3.31
	22	13.78	2.59	13.50	2.63	12.08	2.80	11.23	2.90	10.30	3.03	7.72	3.32
	24	13.70	2.69	13.19	2.72	10.63	2.85	9.10	2.93	8.49	3.06	7.06	3.34

Combination (Capacity)	Indoor Air Temp. °C DB	Outdoor Air Temp. °C									
		0/-1		-5/-6		-7/-8		-10/-11		-15/-	
		Total Q	Input Power	Total Q	Input Power	Total Q	Input Power	Total Q	Input Power	Total Q	Input Power
3.5 + 5.0 + 5.0	16	9.12	3.23	8.45	3.27	8.19	3.29	7.88	3.13	7.23	3.07
	18	8.65	3.30	8.08	3.26	7.85	3.25	7.73	3.11	7.28	3.06
	20	8.17	3.29	7.78	3.25	7.62	3.23	7.60	3.13	7.18	3.06
	21	7.85	3.30	7.39	3.25	7.21	3.23	7.32	3.14	7.07	3.09
	22	7.68	3.31	7.57	3.25	7.53	3.23	7.48	3.16	6.89	3.09
	24	7.16	3.35	7.43	3.28	7.54	3.25	7.39	3.21	6.44	3.15
3.5 + 5.0 + 6.0	16	9.12	3.23	8.45	3.27	8.19	3.29	7.88	3.13	7.23	3.07
	18	8.65	3.30	8.08	3.26	7.85	3.25	7.73	3.11	7.28	3.06
	20	8.17	3.29	7.78	3.25	7.62	3.23	7.60	3.13	7.18	3.06
	21	7.85	3.30	7.39	3.25	7.21	3.23	7.32	3.14	7.07	3.09
	22	7.68	3.31	7.57	3.25	7.53	3.23	7.48	3.16	6.89	3.09
	24	7.16	3.35	7.43	3.28	7.54	3.25	7.39	3.21	6.44	3.15
4.2 + 4.2 + 4.2	16	9.12	3.52	8.45	3.57	8.19	3.58	7.88	3.41	7.23	3.35
	18	8.65	3.59	8.08	3.56	7.85	3.54	7.73	3.39	7.28	3.34
	20	8.17	3.59	7.78	3.54	7.62	3.52	7.60	3.41	7.18	3.34
	21	7.85	3.60	7.39	3.54	7.21	3.52	7.32	3.42	7.07	3.37
	22	7.68	3.61	7.57	3.54	7.53	3.52	7.48	3.44	6.89	3.37
	24	7.16	3.66	7.43	3.58	7.54	3.54	7.39	3.49	6.44	3.43
4.2 + 4.2 + 5.0	16	9.12	3.35	8.45	3.40	8.19	3.41	7.88	3.25	7.23	3.19
	18	8.65	3.42	8.08	3.39	7.85	3.38	7.73	3.23	7.28	3.18
	20	8.17	3.42	7.78	3.37	7.62	3.35	7.60	3.25	7.18	3.18
	21	7.85	3.43	7.39	3.37	7.21	3.35	7.32	3.26	7.07	3.21
	22	7.68	3.44	7.57	3.38	7.53	3.35	7.48	3.28	6.89	3.21
	24	7.16	3.48	7.43	3.41	7.54	3.38	7.39	3.33	6.44	3.27
4.2 + 4.2 + 6.0	16	9.12	3.35	8.45	3.40	8.19	3.41	7.88	3.25	7.23	3.19
	18	8.65	3.42	8.08	3.39	7.85	3.38	7.73	3.23	7.28	3.18
	20	8.17	3.42	7.78	3.37	7.62	3.35	7.60	3.25	7.18	3.18
	21	7.85	3.43	7.39	3.37	7.21	3.35	7.32	3.26	7.07	3.21
	22	7.68	3.44	7.57	3.38	7.53	3.35	7.48	3.28	6.89	3.21
	24	7.16	3.48	7.43	3.41	7.54	3.38	7.39	3.33	6.44	3.27
4.2 + 5.0 + 5.0	16	9.12	3.22	8.45	3.26	8.19	3.28	7.88	3.12	7.23	3.06
	18	8.65	3.29	8.08	3.25	7.85	3.24	7.73	3.10	7.28	3.05
	20	8.17	3.28	7.78	3.23	7.62	3.22	7.60	3.12	7.18	3.05
	21	7.85	3.29	7.39	3.24	7.21	3.22	7.32	3.13	7.07	3.08
	22	7.68	3.30	7.57	3.24	7.53	3.22	7.48	3.14	6.89	3.08
	24	7.16	3.34	7.43	3.27	7.54	3.24	7.39	3.20	6.44	3.14

Combination (Capacity)	Indoor Air Temp. °C DB	Outdoor Air Temp. °C											
		16/15		15/14		10/9		7/6		6/5		2/1	
		Total Q	Input Power	Total Q	Input Power	Total Q	Input Power	Total Q	Input Power	Total Q	Input Power	Total Q	Input Power
1.6 + 1.6 + 1.6 + 1.6	16	14.72	2.36	14.42	2.42	12.91	2.72	12.00	2.89	11.41	2.94	9.06	3.11
	18	14.11	2.46	13.80	2.51	12.23	2.80	11.29	2.97	10.75	3.01	8.56	3.17
	20	13.90	2.52	13.53	2.58	11.70	2.86	10.60	3.03	10.08	3.06	8.01	3.18
	21	13.92	2.55	13.51	2.59	11.45	2.80	10.21	2.93	9.71	2.98	7.72	3.20
	22	14.04	2.57	13.65	2.63	11.72	2.91	10.56	3.09	9.93	3.11	7.40	3.21
	24	14.55	2.59	13.96	2.65	11.01	2.95	9.24	3.13	8.74	3.16	6.74	3.24
1.6 + 1.6 + 1.6 + 2.0	16	14.72	2.35	14.42	2.41	12.91	2.71	12.00	2.89	11.41	2.93	9.06	3.10
	18	14.11	2.45	13.80	2.50	12.23	2.79	11.29	2.96	10.75	3.00	8.56	3.16
	20	13.90	2.51	13.53	2.57	11.70	2.85	10.60	3.02	10.08	3.05	8.01	3.17
	21	13.92	2.54	13.51	2.58	11.45	2.79	10.21	2.92	9.71	2.97	7.72	3.19
	22	14.04	2.56	13.65	2.62	11.72	2.90	10.56	3.08	9.93	3.10	7.40	3.20
	24	14.55	2.58	13.96	2.64	11.01	2.94	9.24	3.12	8.74	3.14	6.74	3.23
1.6 + 1.6 + 1.6 + 2.5	16	14.72	2.35	14.42	2.41	12.91	2.71	12.00	2.89	11.41	2.93	9.06	3.10
	18	14.11	2.45	13.80	2.50	12.23	2.79	11.29	2.96	10.75	3.00	8.56	3.16
	20	13.90	2.51	13.53	2.57	11.70	2.85	10.60	3.02	10.08	3.05	8.01	3.17
	21	13.92	2.54	13.51	2.58	11.45	2.79	10.21	2.92	9.71	2.97	7.72	3.19
	22	14.04	2.56	13.65	2.62	11.72	2.90	10.56	3.08	9.93	3.10	7.40	3.20
	24	14.55	2.58	13.96	2.64	11.01	2.94	9.24	3.12	8.74	3.14	6.74	3.23
1.6 + 1.6 + 1.6 + 3.5	16	14.72	2.33	14.42	2.39	12.91	2.68	12.00	2.86	11.41	2.90	9.06	3.07
	18	14.11	2.42	13.80	2.48	12.23	2.76	11.29	2.93	10.75	2.97	8.56	3.13
	20	13.90	2.49	13.53	2.54	11.70	2.82	10.60	2.99	10.08	3.02	8.01	3.14
	21	13.92	2.52	13.51	2.56	11.45	2.77	10.21	2.89	9.71	2.94	7.72	3.16
	22	14.04	2.53	13.65	2.59	11.72	2.87	10.56	3.05	9.93	3.07	7.40	3.17
	24	14.55	2.56	13.96	2.62	11.01	2.91	9.24	3.09	8.74	3.11	6.74	3.20
1.6 + 1.6 + 1.6 + 4.2	16	14.72	2.32	14.42	2.38	12.91	2.67	12.00	2.85	11.41	2.89	9.06	3.06
	18	14.11	2.42	13.80	2.47	12.23	2.75	11.29	2.92	10.75	2.96	8.56	3.12
	20	13.90	2.48	13.53	2.54	11.70	2.81	10.60	2.98	10.08	3.01	8.01	3.13
	21	13.92	2.51	13.51	2.55	11.45	2.76	10.21	2.88	9.71	2.93	7.72	3.15
	22	14.04	2.53	13.65	2.58	11.72	2.87	10.56	3.04	9.93	3.06	7.40	3.16
	24	14.55	2.55	13.96	2.61	11.01	2.90	9.24	3.08	8.74	3.10	6.74	3.19
1.6 + 1.6 + 1.6 + 5.0	16	14.72	2.23	14.42	2.28	12.91	2.56	12.00	2.73	11.41	2.77	9.06	2.93
	18	14.11	2.32	13.80	2.37	12.23	2.64	11.29	2.80	10.75	2.84	8.56	2.99
	20	13.90	2.38	13.53	2.43	11.70	2.70	10.60	2.86	10.08	2.89	8.01	3.01
	21	13.92	2.41	13.51	2.45	11.45	2.65	10.21	2.77	9.71	2.82	7.72	3.02
	22	14.04	2.42	13.65	2.48	11.72	2.75	10.56	2.91	9.93	2.94	7.40	3.03
	24	14.55	2.45	13.96	2.50	11.01	2.79	9.24	2.96	8.74	2.98	6.74	3.06

Combination (Capacity)	Indoor Air Temp. °C DB	Outdoor Air Temp. °C									
		0/-1		-5/-6		-7/-8		-10/-11		-15/-	
		Total Q	Input Power	Total Q	Input Power	Total Q	Input Power	Total Q	Input Power	Total Q	Input Power
1.6 + 1.6 + 1.6 + 1.6	16	8.80	3.07	8.13	2.97	7.87	2.93	7.56	2.83	7.05	2.66
	18	8.33	3.12	7.76	3.00	7.53	2.95	7.41	2.86	7.22	2.71
	20	7.86	3.14	7.46	3.01	7.31	2.96	7.28	2.90	7.24	2.79
	21	7.53	3.15	7.07	3.03	6.89	2.98	7.00	2.92	7.19	2.82
	22	7.36	3.16	7.25	3.04	7.21	2.99	7.17	2.94	7.10	2.85
	24	6.85	3.20	7.11	3.08	7.22	3.03	7.07	2.99	6.82	2.92
1.6 + 1.6 + 1.6 + 2.0	16	8.80	3.06	8.13	2.96	7.87	2.92	7.56	2.82	7.05	2.65
	18	8.33	3.11	7.76	2.99	7.53	2.94	7.41	2.85	7.22	2.70
	20	7.86	3.12	7.46	3.00	7.31	2.95	7.28	2.89	7.24	2.78
	21	7.53	3.14	7.07	3.02	6.89	2.97	7.00	2.91	7.19	2.81
	22	7.36	3.15	7.25	3.03	7.21	2.98	7.17	2.93	7.10	2.84
	24	6.85	3.19	7.11	3.07	7.22	3.02	7.07	2.98	6.82	2.91
1.6 + 1.6 + 1.6 + 2.5	16	8.80	3.06	8.13	2.96	7.87	2.92	7.56	2.82	7.05	2.65
	18	8.33	3.11	7.76	2.99	7.53	2.94	7.41	2.85	7.22	2.70
	20	7.86	3.12	7.46	3.00	7.31	2.95	7.28	2.89	7.24	2.78
	21	7.53	3.14	7.07	3.02	6.89	2.97	7.00	2.91	7.19	2.81
	22	7.36	3.15	7.25	3.03	7.21	2.98	7.17	2.93	7.10	2.84
	24	6.85	3.19	7.11	3.07	7.22	3.02	7.07	2.98	6.82	2.91
1.6 + 1.6 + 1.6 + 3.5	16	8.80	3.03	8.13	2.93	7.87	2.89	7.56	2.79	7.05	2.63
	18	8.33	3.08	7.76	2.96	7.53	2.91	7.41	2.82	7.22	2.68
	20	7.86	3.09	7.46	2.97	7.31	2.93	7.28	2.86	7.24	2.75
	21	7.53	3.11	7.07	2.99	6.89	2.94	7.00	2.88	7.19	2.78
	22	7.36	3.12	7.25	3.00	7.21	2.95	7.17	2.90	7.10	2.81
	24	6.85	3.15	7.11	3.04	7.22	2.99	7.07	2.95	6.82	2.88
1.6 + 1.6 + 1.6 + 4.2	16	8.80	3.02	8.13	2.92	7.87	2.88	7.56	2.78	7.05	2.62
	18	8.33	3.07	7.76	2.95	7.53	2.90	7.41	2.81	7.22	2.67
	20	7.86	3.08	7.46	2.96	7.31	2.92	7.28	2.85	7.24	2.74
	21	7.53	3.10	7.07	2.98	6.89	2.93	7.00	2.87	7.19	2.77
	22	7.36	3.11	7.25	2.99	7.21	2.94	7.17	2.89	7.10	2.81
	24	6.85	3.14	7.11	3.03	7.22	2.98	7.07	2.94	6.82	2.87
1.6 + 1.6 + 1.6 + 5.0	16	8.80	2.90	8.13	2.80	7.87	2.77	7.56	2.67	7.05	2.51
	18	8.33	2.95	7.76	2.83	7.53	2.78	7.41	2.70	7.22	2.56
	20	7.86	2.96	7.46	2.84	7.31	2.80	7.28	2.74	7.24	2.63
	21	7.53	2.97	7.07	2.86	6.89	2.81	7.00	2.76	7.19	2.66
	22	7.36	2.99	7.25	2.87	7.21	2.82	7.17	2.78	7.10	2.69
	24	6.85	3.02	7.11	2.91	7.22	2.86	7.07	2.82	6.82	2.76

Combination (Capacity)	Indoor Air Temp. °C DB	Outdoor Air Temp. °C											
		16/15		15/14		10/9		7/6		6/5		2/1	
		Total Q	Input Power	Total Q	Input Power	Total Q	Input Power	Total Q	Input Power	Total Q	Input Power	Total Q	Input Power
1.6 + 1.6 + 1.6 + 6.0	16	14.72	2.23	14.42	2.28	12.91	2.56	12.00	2.73	11.41	2.77	9.06	2.93
	18	14.11	2.32	13.80	2.37	12.23	2.64	11.29	2.80	10.75	2.84	8.56	2.99
	20	13.90	2.38	13.53	2.43	11.70	2.70	10.60	2.86	10.08	2.89	8.01	3.01
	21	13.92	2.41	13.51	2.45	11.45	2.65	10.21	2.77	9.71	2.82	7.72	3.02
	22	14.04	2.42	13.65	2.48	11.72	2.75	10.56	2.91	9.93	2.94	7.40	3.03
	24	14.55	2.45	13.96	2.50	11.01	2.79	9.24	2.96	8.74	2.98	6.74	3.06
1.6 + 1.6 + 1.6 + 7.1	16	14.72	2.22	14.42	2.27	12.91	2.55	12.00	2.72	11.41	2.76	9.06	2.92
	18	14.11	2.31	13.80	2.36	12.23	2.63	11.29	2.79	10.75	2.83	8.56	2.98
	20	13.90	2.37	13.53	2.42	11.70	2.69	10.60	2.85	10.08	2.88	8.01	2.99
	21	13.92	2.40	13.51	2.44	11.45	2.64	10.21	2.76	9.71	2.81	7.72	3.01
	22	14.04	2.42	13.65	2.47	11.72	2.74	10.56	2.90	9.93	2.93	7.40	3.02
	24	14.55	2.44	13.96	2.49	11.01	2.78	9.24	2.95	8.74	2.97	6.74	3.05
1.6 + 1.6 + 2.0 + 2.0	16	14.72	2.34	14.42	2.40	12.91	2.70	12.00	2.88	11.41	2.92	9.06	3.09
	18	14.11	2.44	13.80	2.50	12.23	2.78	11.29	2.95	10.75	2.99	8.56	3.15
	20	13.90	2.50	13.53	2.56	11.70	2.84	10.60	3.01	10.08	3.04	8.01	3.16
	21	13.92	2.53	13.51	2.57	11.45	2.78	10.21	2.91	9.71	2.96	7.72	3.18
	22	14.04	2.55	13.65	2.61	11.72	2.89	10.56	3.07	9.93	3.09	7.40	3.19
	24	14.55	2.57	13.96	2.63	11.01	2.93	9.24	3.11	8.74	3.13	6.74	3.22
1.6 + 1.6 + 2.0 + 2.5	16	14.72	2.34	14.42	2.40	12.91	2.70	12.00	2.88	11.41	2.92	9.06	3.09
	18	14.11	2.44	13.80	2.50	12.23	2.78	11.29	2.95	10.75	2.99	8.56	3.15
	20	13.90	2.50	13.53	2.56	11.70	2.84	10.60	3.01	10.08	3.04	8.01	3.16
	21	13.92	2.53	13.51	2.57	11.45	2.78	10.21	2.91	9.71	2.96	7.72	3.18
	22	14.04	2.55	13.65	2.61	11.72	2.89	10.56	3.07	9.93	3.09	7.40	3.19
	24	14.55	2.57	13.96	2.63	11.01	2.93	9.24	3.11	8.74	3.13	6.74	3.22
1.6 + 1.6 + 2.0 + 3.5	16	14.72	2.32	14.42	2.38	12.91	2.67	12.00	2.85	11.41	2.89	9.06	3.06
	18	14.11	2.42	13.80	2.47	12.23	2.75	11.29	2.92	10.75	2.96	8.56	3.12
	20	13.90	2.48	13.53	2.54	11.70	2.81	10.60	2.98	10.08	3.01	8.01	3.13
	21	13.92	2.51	13.51	2.55	11.45	2.76	10.21	2.88	9.71	2.93	7.72	3.15
	22	14.04	2.53	13.65	2.58	11.72	2.87	10.56	3.04	9.93	3.06	7.40	3.16
	24	14.55	2.55	13.96	2.61	11.01	2.90	9.24	3.08	8.74	3.10	6.74	3.19
1.6 + 1.6 + 2.0 + 4.2	16	14.72	2.31	14.42	2.37	12.91	2.66	12.00	2.84	11.41	2.88	9.06	3.05
	18	14.11	2.41	13.80	2.46	12.23	2.74	11.29	2.91	10.75	2.95	8.56	3.11
	20	13.90	2.47	13.53	2.53	11.70	2.80	10.60	2.97	10.08	3.00	8.01	3.12
	21	13.92	2.50	13.51	2.54	11.45	2.75	10.21	2.87	9.71	2.93	7.72	3.13
	22	14.04	2.52	13.65	2.57	11.72	2.86	10.56	3.02	9.93	3.05	7.40	3.15
	24	14.55	2.54	13.96	2.60	11.01	2.89	9.24	3.07	8.74	3.09	6.74	3.18

Combination (Capacity)	Indoor Air Temp. °C DB	Outdoor Air Temp. °C									
		0/-1		-5/-6		-7/-8		-10/-11		-15/-	
		Total Q	Input Power	Total Q	Input Power	Total Q	Input Power	Total Q	Input Power	Total Q	Input Power
1.6 + 1.6 + 1.6 + 6.0	16	8.80	2.90	8.13	2.80	7.87	2.77	7.56	2.67	7.05	2.51
	18	8.33	2.95	7.76	2.83	7.53	2.78	7.41	2.70	7.22	2.56
	20	7.86	2.96	7.46	2.84	7.31	2.80	7.28	2.74	7.24	2.63
	21	7.53	2.97	7.07	2.86	6.89	2.81	7.00	2.76	7.19	2.66
	22	7.36	2.99	7.25	2.87	7.21	2.82	7.17	2.78	7.10	2.69
	24	6.85	3.02	7.11	2.91	7.22	2.86	7.07	2.82	6.82	2.76
1.6 + 1.6 + 1.6 + 7.1	16	8.80	2.89	8.13	2.79	7.87	2.76	7.56	2.66	7.05	2.50
	18	8.33	2.93	7.76	2.82	7.53	2.77	7.41	2.69	7.22	2.55
	20	7.86	2.95	7.46	2.83	7.31	2.79	7.28	2.73	7.24	2.62
	21	7.53	2.96	7.07	2.85	6.89	2.80	7.00	2.75	7.19	2.65
	22	7.36	2.98	7.25	2.86	7.21	2.81	7.17	2.77	7.10	2.68
	24	6.85	3.01	7.11	2.89	7.22	2.85	7.07	2.81	6.82	2.75
1.6 + 1.6 + 2.0 + 2.0	16	8.80	3.05	8.13	2.95	7.87	2.91	7.56	2.81	7.05	2.64
	18	8.33	3.10	7.76	2.98	7.53	2.93	7.41	2.84	7.22	2.69
	20	7.86	3.11	7.46	2.99	7.31	2.95	7.28	2.88	7.24	2.77
	21	7.53	3.13	7.07	3.01	6.89	2.96	7.00	2.90	7.19	2.80
	22	7.36	3.14	7.25	3.02	7.21	2.97	7.17	2.92	7.10	2.83
	24	6.85	3.18	7.11	3.06	7.22	3.01	7.07	2.97	6.82	2.90
1.6 + 1.6 + 2.0 + 2.5	16	8.80	3.05	8.13	2.95	7.87	2.91	7.56	2.81	7.05	2.64
	18	8.33	3.10	7.76	2.98	7.53	2.93	7.41	2.84	7.22	2.69
	20	7.86	3.11	7.46	2.99	7.31	2.95	7.28	2.88	7.24	2.77
	21	7.53	3.13	7.07	3.01	6.89	2.96	7.00	2.90	7.19	2.80
	22	7.36	3.14	7.25	3.02	7.21	2.97	7.17	2.92	7.10	2.83
	24	6.85	3.18	7.11	3.06	7.22	3.01	7.07	2.97	6.82	2.90
1.6 + 1.6 + 2.0 + 3.5	16	8.80	3.02	8.13	2.92	7.87	2.88	7.56	2.78	7.05	2.62
	18	8.33	3.07	7.76	2.95	7.53	2.90	7.41	2.81	7.22	2.67
	20	7.86	3.08	7.46	2.96	7.31	2.92	7.28	2.85	7.24	2.74
	21	7.53	3.10	7.07	2.98	6.89	2.93	7.00	2.87	7.19	2.77
	22	7.36	3.11	7.25	2.99	7.21	2.94	7.17	2.89	7.10	2.81
	24	6.85	3.14	7.11	3.03	7.22	2.98	7.07	2.94	6.82	2.87
1.6 + 1.6 + 2.0 + 4.2	16	8.80	3.01	8.13	2.91	7.87	2.87	7.56	2.77	7.05	2.61
	18	8.33	3.06	7.76	2.94	7.53	2.89	7.41	2.80	7.22	2.66
	20	7.86	3.07	7.46	2.95	7.31	2.91	7.28	2.84	7.24	2.73
	21	7.53	3.09	7.07	2.97	6.89	2.92	7.00	2.86	7.19	2.76
	22	7.36	3.10	7.25	2.98	7.21	2.93	7.17	2.88	7.10	2.80
	24	6.85	3.13	7.11	3.02	7.22	2.97	7.07	2.93	6.82	2.86

Combination (Capacity)	Indoor Air Temp. °C DB	Outdoor Air Temp. °C											
		16/15		15/14		10/9		7/6		6/5		2/1	
		Total Q	Input Power	Total Q	Input Power	Total Q	Input Power	Total Q	Input Power	Total Q	Input Power	Total Q	Input Power
1.6 + 1.6 + 2.0 + 5.0	16	14.72	2.22	14.42	2.27	12.91	2.55	12.00	2.72	11.41	2.76	9.06	2.92
	18	14.11	2.31	13.80	2.36	12.23	2.63	11.29	2.79	10.75	2.83	8.56	2.98
	20	13.90	2.37	13.53	2.42	11.70	2.69	10.60	2.85	10.08	2.88	8.01	2.99
	21	13.92	2.40	13.51	2.44	11.45	2.64	10.21	2.76	9.71	2.81	7.72	3.01
	22	14.04	2.42	13.65	2.47	11.72	2.74	10.56	2.90	9.93	2.93	7.40	3.02
	24	14.55	2.44	13.96	2.49	11.01	2.78	9.24	2.95	8.74	2.97	6.74	3.05
1.6 + 1.6 + 2.0 + 6.0	16	14.72	2.22	14.42	2.27	12.91	2.55	12.00	2.72	11.41	2.76	9.06	2.92
	18	14.11	2.31	13.80	2.36	12.23	2.63	11.29	2.79	10.75	2.83	8.56	2.98
	20	13.90	2.37	13.53	2.42	11.70	2.69	10.60	2.85	10.08	2.88	8.01	2.99
	21	13.92	2.40	13.51	2.44	11.45	2.64	10.21	2.76	9.71	2.81	7.72	3.01
	22	14.04	2.42	13.65	2.47	11.72	2.74	10.56	2.90	9.93	2.93	7.40	3.02
	24	14.55	2.44	13.96	2.49	11.01	2.78	9.24	2.95	8.74	2.97	6.74	3.05
1.6 + 1.6 + 2.0 + 7.1	16	14.72	2.26	14.42	2.31	12.91	2.60	12.00	2.77	11.41	2.81	9.06	2.98
	18	14.11	2.35	13.80	2.40	12.23	2.68	11.29	2.84	10.75	2.88	8.56	3.03
	20	13.90	2.41	13.53	2.47	11.70	2.74	10.60	2.90	10.08	2.93	8.01	3.05
	21	13.92	2.44	13.51	2.48	11.45	2.68	10.21	2.80	9.71	2.86	7.72	3.06
	22	14.04	2.46	13.65	2.51	11.72	2.79	10.56	2.95	9.93	2.98	7.40	3.07
	24	14.55	2.48	13.96	2.54	11.01	2.83	9.24	3.00	8.74	3.02	6.74	3.11
1.6 + 1.6 + 2.5 + 2.5	16	14.72	2.34	14.42	2.40	12.91	2.70	12.00	2.88	11.41	2.92	9.06	3.09
	18	14.11	2.44	13.80	2.50	12.23	2.78	11.29	2.95	10.75	2.99	8.56	3.15
	20	13.90	2.50	13.53	2.56	11.70	2.84	10.60	3.01	10.08	3.04	8.01	3.16
	21	13.92	2.53	13.51	2.57	11.45	2.78	10.21	2.91	9.71	2.96	7.72	3.18
	22	14.04	2.55	13.65	2.61	11.72	2.89	10.56	3.07	9.93	3.09	7.40	3.19
	24	14.55	2.57	13.96	2.63	11.01	2.93	9.24	3.11	8.74	3.13	6.74	3.22
1.6 + 1.6 + 2.5 + 3.5	16	14.72	2.32	14.42	2.38	12.91	2.67	12.00	2.85	11.41	2.89	9.06	3.06
	18	14.11	2.42	13.80	2.47	12.23	2.75	11.29	2.92	10.75	2.96	8.56	3.12
	20	13.90	2.48	13.53	2.54	11.70	2.81	10.60	2.98	10.08	3.01	8.01	3.13
	21	13.92	2.51	13.51	2.55	11.45	2.76	10.21	2.88	9.71	2.93	7.72	3.15
	22	14.04	2.53	13.65	2.58	11.72	2.87	10.56	3.04	9.93	3.06	7.40	3.16
	24	14.55	2.55	13.96	2.61	11.01	2.90	9.24	3.08	8.74	3.10	6.74	3.19
1.6 + 1.6 + 2.5 + 4.2	16	14.72	2.31	14.42	2.37	12.91	2.66	12.00	2.84	11.41	2.88	9.06	3.05
	18	14.11	2.41	13.80	2.46	12.23	2.74	11.29	2.91	10.75	2.95	8.56	3.11
	20	13.90	2.47	13.53	2.53	11.70	2.80	10.60	2.97	10.08	3.00	8.01	3.12
	21	13.92	2.50	13.51	2.54	11.45	2.75	10.21	2.87	9.71	2.93	7.72	3.13
	22	14.04	2.52	13.65	2.57	11.72	2.86	10.56	3.02	9.93	3.05	7.40	3.15
	24	14.55	2.54	13.96	2.60	11.01	2.89	9.24	3.07	8.74	3.09	6.74	3.18



Combination (Capacity)	Indoor Air Temp. °C DB	Outdoor Air Temp. °C									
		0/-1		-5/-6		-7/-8		-10/-11		-15/-	
		Total Q	Input Power	Total Q	Input Power	Total Q	Input Power	Total Q	Input Power	Total Q	Input Power
1.6 + 1.6 + 2.0 + 5.0	16	8.80	2.89	8.13	2.79	7.87	2.76	7.56	2.66	7.05	2.50
	18	8.33	2.93	7.76	2.82	7.53	2.77	7.41	2.69	7.22	2.55
	20	7.86	2.95	7.46	2.83	7.31	2.79	7.28	2.73	7.24	2.62
	21	7.53	2.96	7.07	2.85	6.89	2.80	7.00	2.75	7.19	2.65
	22	7.36	2.98	7.25	2.86	7.21	2.81	7.17	2.77	7.10	2.68
	24	6.85	3.01	7.11	2.89	7.22	2.85	7.07	2.81	6.82	2.75
1.6 + 1.6 + 2.0 + 6.0	16	8.80	2.89	8.13	2.79	7.87	2.76	7.56	2.66	7.05	2.50
	18	8.33	2.93	7.76	2.82	7.53	2.77	7.41	2.69	7.22	2.55
	20	7.86	2.95	7.46	2.83	7.31	2.79	7.28	2.73	7.24	2.62
	21	7.53	2.96	7.07	2.85	6.89	2.80	7.00	2.75	7.19	2.65
	22	7.36	2.98	7.25	2.86	7.21	2.81	7.17	2.77	7.10	2.68
	24	6.85	3.01	7.11	2.89	7.22	2.85	7.07	2.81	6.82	2.75
1.6 + 1.6 + 2.0 + 7.1	16	8.80	2.94	8.13	2.84	7.87	2.81	7.56	2.71	7.05	2.55
	18	8.33	2.99	7.76	2.87	7.53	2.82	7.41	2.74	7.22	2.60
	20	7.86	3.00	7.46	2.88	7.31	2.84	7.28	2.77	7.24	2.67
	21	7.53	3.01	7.07	2.90	6.89	2.85	7.00	2.79	7.19	2.70
	22	7.36	3.03	7.25	2.91	7.21	2.86	7.17	2.81	7.10	2.73
	24	6.85	3.06	7.11	2.95	7.22	2.90	7.07	2.86	6.82	2.80
1.6 + 1.6 + 2.5 + 2.5	16	8.80	3.05	8.13	2.95	7.87	2.91	7.56	2.81	7.05	2.64
	18	8.33	3.10	7.76	2.98	7.53	2.93	7.41	2.84	7.22	2.69
	20	7.86	3.11	7.46	2.99	7.31	2.95	7.28	2.88	7.24	2.77
	21	7.53	3.13	7.07	3.01	6.89	2.96	7.00	2.90	7.19	2.80
	22	7.36	3.14	7.25	3.02	7.21	2.97	7.17	2.92	7.10	2.83
	24	6.85	3.18	7.11	3.06	7.22	3.01	7.07	2.97	6.82	2.90
1.6 + 1.6 + 2.5 + 3.5	16	8.80	3.02	8.13	2.92	7.87	2.88	7.56	2.78	7.05	2.62
	18	8.33	3.07	7.76	2.95	7.53	2.90	7.41	2.81	7.22	2.67
	20	7.86	3.08	7.46	2.96	7.31	2.92	7.28	2.85	7.24	2.74
	21	7.53	3.10	7.07	2.98	6.89	2.93	7.00	2.87	7.19	2.77
	22	7.36	3.11	7.25	2.99	7.21	2.94	7.17	2.89	7.10	2.81
	24	6.85	3.14	7.11	3.03	7.22	2.98	7.07	2.94	6.82	2.87
1.6 + 1.6 + 2.5 + 4.2	16	8.80	3.01	8.13	2.91	7.87	2.87	7.56	2.77	7.05	2.61
	18	8.33	3.06	7.76	2.94	7.53	2.89	7.41	2.80	7.22	2.66
	20	7.86	3.07	7.46	2.95	7.31	2.91	7.28	2.84	7.24	2.73
	21	7.53	3.09	7.07	2.97	6.89	2.92	7.00	2.86	7.19	2.76
	22	7.36	3.10	7.25	2.98	7.21	2.93	7.17	2.88	7.10	2.80
	24	6.85	3.13	7.11	3.02	7.22	2.97	7.07	2.93	6.82	2.86

Combination (Capacity)	Indoor Air Temp. °C DB	Outdoor Air Temp. °C											
		16/15		15/14		10/9		7/6		6/5		2/1	
		Total Q	Input Power	Total Q	Input Power	Total Q	Input Power	Total Q	Input Power	Total Q	Input Power	Total Q	Input Power
1.6 + 1.6 + 2.5 + 5.0	16	14.72	2.22	14.42	2.27	12.91	2.55	12.00	2.72	11.41	2.76	9.06	2.92
	18	14.11	2.31	13.80	2.36	12.23	2.63	11.29	2.79	10.75	2.83	8.56	2.98
	20	13.90	2.37	13.53	2.42	11.70	2.69	10.60	2.85	10.08	2.88	8.01	2.99
	21	13.92	2.40	13.51	2.44	11.45	2.64	10.21	2.76	9.71	2.81	7.72	3.01
	22	14.04	2.42	13.65	2.47	11.72	2.74	10.56	2.90	9.93	2.93	7.40	3.02
	24	14.55	2.44	13.96	2.49	11.01	2.78	9.24	2.95	8.74	2.97	6.74	3.05
1.6 + 1.6 + 2.5 + 6.0	16	14.72	2.22	14.42	2.27	12.91	2.55	12.00	2.72	11.41	2.76	9.06	2.92
	18	14.11	2.31	13.80	2.36	12.23	2.63	11.29	2.79	10.75	2.83	8.56	2.98
	20	13.90	2.37	13.53	2.42	11.70	2.69	10.60	2.85	10.08	2.88	8.01	2.99
	21	13.92	2.40	13.51	2.44	11.45	2.64	10.21	2.76	9.71	2.81	7.72	3.01
	22	14.04	2.42	13.65	2.47	11.72	2.74	10.56	2.90	9.93	2.93	7.40	3.02
	24	14.55	2.44	13.96	2.49	11.01	2.78	9.24	2.95	8.74	2.97	6.74	3.05
1.6 + 1.6 + 2.5 + 7.1	16	14.72	2.26	14.42	2.31	12.91	2.60	12.00	2.77	11.41	2.81	9.06	2.98
	18	14.11	2.35	13.80	2.40	12.23	2.68	11.29	2.84	10.75	2.88	8.56	3.03
	20	13.90	2.41	13.53	2.47	11.70	2.74	10.60	2.90	10.08	2.93	8.01	3.05
	21	13.92	2.44	13.51	2.48	11.45	2.68	10.21	2.80	9.71	2.86	7.72	3.06
	22	14.04	2.46	13.65	2.51	11.72	2.79	10.56	2.95	9.93	2.98	7.40	3.07
	24	14.55	2.48	13.96	2.54	11.01	2.83	9.24	3.00	8.74	3.02	6.74	3.11
1.6 + 1.6 + 3.5 + 3.5	16	14.72	2.30	14.42	2.35	12.91	2.64	12.00	2.82	11.41	2.86	9.06	3.03
	18	14.11	2.39	13.80	2.45	12.23	2.72	11.29	2.89	10.75	2.93	8.56	3.09
	20	13.90	2.45	13.53	2.51	11.70	2.78	10.60	2.95	10.08	2.98	8.01	3.10
	21	13.92	2.48	13.51	2.52	11.45	2.73	10.21	2.85	9.71	2.91	7.72	3.11
	22	14.04	2.50	13.65	2.56	11.72	2.84	10.56	3.00	9.93	3.03	7.40	3.13
	24	14.55	2.52	13.96	2.58	11.01	2.87	9.24	3.05	8.74	3.07	6.74	3.16
1.6 + 1.6 + 3.5 + 4.2	16	14.72	2.29	14.42	2.35	12.91	2.63	12.00	2.81	11.41	2.85	9.06	3.02
	18	14.11	2.38	13.80	2.44	12.23	2.72	11.29	2.88	10.75	2.92	8.56	3.08
	20	13.90	2.45	13.53	2.50	11.70	2.78	10.60	2.94	10.08	2.97	8.01	3.09
	21	13.92	2.47	13.51	2.51	11.45	2.72	10.21	2.84	9.71	2.90	7.72	3.10
	22	14.04	2.49	13.65	2.55	11.72	2.83	10.56	2.99	9.93	3.02	7.40	3.12
	24	14.55	2.51	13.96	2.57	11.01	2.86	9.24	3.04	8.74	3.06	6.74	3.15
1.6 + 1.6 + 3.5 + 5.0	16	14.72	2.25	14.42	2.31	12.91	2.59	12.00	2.76	11.41	2.80	9.06	2.97
	18	14.11	2.34	13.80	2.40	12.23	2.67	11.29	2.83	10.75	2.87	8.56	3.02
	20	13.90	2.40	13.53	2.46	11.70	2.73	10.60	2.89	10.08	2.92	8.01	3.04
	21	13.92	2.43	13.51	2.47	11.45	2.67	10.21	2.80	9.71	2.85	7.72	3.05
	22	14.04	2.45	13.65	2.50	11.72	2.78	10.56	2.94	9.93	2.97	7.40	3.06
	24	14.55	2.47	13.96	2.53	11.01	2.82	9.24	2.99	8.74	3.01	6.74	3.09

Combination (Capacity)	Indoor Air Temp. °C DB	Outdoor Air Temp. °C									
		0/-1		-5/-6		-7/-8		-10/-11		-15/-	
		Total Q	Input Power	Total Q	Input Power	Total Q	Input Power	Total Q	Input Power	Total Q	Input Power
1.6 + 1.6 + 2.5 + 5.0	16	8.80	2.89	8.13	2.79	7.87	2.76	7.56	2.66	7.05	2.50
	18	8.33	2.93	7.76	2.82	7.53	2.77	7.41	2.69	7.22	2.55
	20	7.86	2.95	7.46	2.83	7.31	2.79	7.28	2.73	7.24	2.62
	21	7.53	2.96	7.07	2.85	6.89	2.80	7.00	2.75	7.19	2.65
	22	7.36	2.98	7.25	2.86	7.21	2.81	7.17	2.77	7.10	2.68
	24	6.85	3.01	7.11	2.89	7.22	2.85	7.07	2.81	6.82	2.75
1.6 + 1.6 + 2.5 + 6.0	16	8.80	2.89	8.13	2.79	7.87	2.76	7.56	2.66	7.05	2.50
	18	8.33	2.93	7.76	2.82	7.53	2.77	7.41	2.69	7.22	2.55
	20	7.86	2.95	7.46	2.83	7.31	2.79	7.28	2.73	7.24	2.62
	21	7.53	2.96	7.07	2.85	6.89	2.80	7.00	2.75	7.19	2.65
	22	7.36	2.98	7.25	2.86	7.21	2.81	7.17	2.77	7.10	2.68
	24	6.85	3.01	7.11	2.89	7.22	2.85	7.07	2.81	6.82	2.75
1.6 + 1.6 + 2.5 + 7.1	16	8.80	2.94	8.13	2.84	7.87	2.81	7.56	2.71	7.05	2.55
	18	8.33	2.99	7.76	2.87	7.53	2.82	7.41	2.74	7.22	2.60
	20	7.86	3.00	7.46	2.88	7.31	2.84	7.28	2.77	7.24	2.67
	21	7.53	3.01	7.07	2.90	6.89	2.85	7.00	2.79	7.19	2.70
	22	7.36	3.03	7.25	2.91	7.21	2.86	7.17	2.81	7.10	2.73
	24	6.85	3.06	7.11	2.95	7.22	2.90	7.07	2.86	6.82	2.80
1.6 + 1.6 + 3.5 + 3.5	16	8.80	2.99	8.13	2.89	7.87	2.85	7.56	2.76	7.05	2.59
	18	8.33	3.04	7.76	2.92	7.53	2.87	7.41	2.78	7.22	2.64
	20	7.86	3.05	7.46	2.93	7.31	2.89	7.28	2.82	7.24	2.71
	21	7.53	3.07	7.07	2.95	6.89	2.90	7.00	2.84	7.19	2.75
	22	7.36	3.08	7.25	2.96	7.21	2.91	7.17	2.86	7.10	2.78
	24	6.85	3.11	7.11	3.00	7.22	2.95	7.07	2.91	6.82	2.85
1.6 + 1.6 + 3.5 + 4.2	16	8.80	2.98	8.13	2.88	7.87	2.84	7.56	2.75	7.05	2.58
	18	8.33	3.03	7.76	2.91	7.53	2.86	7.41	2.77	7.22	2.63
	20	7.86	3.04	7.46	2.92	7.31	2.88	7.28	2.81	7.24	2.70
	21	7.53	3.06	7.07	2.94	6.89	2.89	7.00	2.83	7.19	2.74
	22	7.36	3.07	7.25	2.95	7.21	2.90	7.17	2.85	7.10	2.77
	24	6.85	3.10	7.11	2.99	7.22	2.94	7.07	2.90	6.82	2.84
1.6 + 1.6 + 3.5 + 5.0	16	8.80	2.93	8.13	2.83	7.87	2.80	7.56	2.70	7.05	2.54
	18	8.33	2.98	7.76	2.86	7.53	2.81	7.41	2.73	7.22	2.59
	20	7.86	2.99	7.46	2.87	7.31	2.83	7.28	2.76	7.24	2.66
	21	7.53	3.00	7.07	2.89	6.89	2.84	7.00	2.78	7.19	2.69
	22	7.36	3.02	7.25	2.90	7.21	2.85	7.17	2.80	7.10	2.72
	24	6.85	3.05	7.11	2.94	7.22	2.89	7.07	2.85	6.82	2.79

Combination (Capacity)	Indoor Air Temp. °C DB	Outdoor Air Temp. °C											
		16/15		15/14		10/9		7/6		6/5		2/1	
		Total Q	Input Power	Total Q	Input Power	Total Q	Input Power	Total Q	Input Power	Total Q	Input Power	Total Q	Input Power
1.6 + 1.6 + 3.5 + 6.0	16	14.72	2.25	14.42	2.31	12.91	2.59	12.00	2.76	11.41	2.80	9.06	2.97
	18	14.11	2.34	13.80	2.40	12.23	2.67	11.29	2.83	10.75	2.87	8.56	3.02
	20	13.90	2.40	13.53	2.46	11.70	2.73	10.60	2.89	10.08	2.92	8.01	3.04
	21	13.92	2.43	13.51	2.47	11.45	2.67	10.21	2.80	9.71	2.85	7.72	3.05
	22	14.04	2.45	13.65	2.50	11.72	2.78	10.56	2.94	9.93	2.97	7.40	3.06
	24	14.55	2.47	13.96	2.53	11.01	2.82	9.24	2.99	8.74	3.01	6.74	3.09
1.6 + 1.6 + 3.5 + 7.1	16	14.72	2.23	14.42	2.29	12.91	2.57	12.00	2.74	11.41	2.78	9.06	2.95
	18	14.11	2.33	13.80	2.38	12.23	2.65	11.29	2.81	10.75	2.85	8.56	3.00
	20	13.90	2.39	13.53	2.44	11.70	2.71	10.60	2.87	10.08	2.90	8.01	3.02
	21	13.92	2.41	13.51	2.45	11.45	2.66	10.21	2.78	9.71	2.83	7.72	3.03
	22	14.04	2.43	13.65	2.49	11.72	2.76	10.56	2.92	9.93	2.95	7.40	3.04
	24	14.55	2.45	13.96	2.51	11.01	2.80	9.24	2.97	8.74	2.99	6.74	3.07
1.6 + 1.6 + 4.2 + 4.2	16	14.72	2.28	14.42	2.34	12.91	2.63	12.00	2.80	11.41	2.84	9.06	3.01
	18	14.11	2.37	13.80	2.43	12.23	2.71	11.29	2.87	10.75	2.91	8.56	3.07
	20	13.90	2.44	13.53	2.49	11.70	2.77	10.60	2.93	10.08	2.96	8.01	3.08
	21	13.92	2.46	13.51	2.51	11.45	2.71	10.21	2.83	9.71	2.89	7.72	3.09
	22	14.04	2.48	13.65	2.54	11.72	2.82	10.56	2.98	9.93	3.01	7.40	3.11
	24	14.55	2.51	13.96	2.56	11.01	2.85	9.24	3.03	8.74	3.05	6.74	3.14
1.6 + 1.6 + 4.2 + 5.0	16	14.72	2.24	14.42	2.30	12.91	2.58	12.00	2.75	11.41	2.79	9.06	2.96
	18	14.11	2.33	13.80	2.39	12.23	2.66	11.29	2.82	10.75	2.86	8.56	3.01
	20	13.90	2.40	13.53	2.45	11.70	2.72	10.60	2.88	10.08	2.91	8.01	3.03
	21	13.92	2.42	13.51	2.46	11.45	2.66	10.21	2.79	9.71	2.84	7.72	3.04
	22	14.04	2.44	13.65	2.50	11.72	2.77	10.56	2.93	9.93	2.96	7.40	3.05
	24	14.55	2.46	13.96	2.52	11.01	2.81	9.24	2.98	8.74	3.00	6.74	3.08
1.6 + 1.6 + 4.2 + 6.0	16	14.72	2.24	14.42	2.30	12.91	2.58	12.00	2.75	11.41	2.79	9.06	2.96
	18	14.11	2.33	13.80	2.39	12.23	2.66	11.29	2.82	10.75	2.86	8.56	3.01
	20	13.90	2.40	13.53	2.45	11.70	2.72	10.60	2.88	10.08	2.91	8.01	3.03
	21	13.92	2.42	13.51	2.46	11.45	2.66	10.21	2.79	9.71	2.84	7.72	3.04
	22	14.04	2.44	13.65	2.50	11.72	2.77	10.56	2.93	9.93	2.96	7.40	3.05
	24	14.55	2.46	13.96	2.52	11.01	2.81	9.24	2.98	8.74	3.00	6.74	3.08
1.6 + 1.6 + 4.2 + 7.1	16	14.72	2.23	14.42	2.29	12.91	2.57	12.00	2.74	11.41	2.78	9.06	2.95
	18	14.11	2.33	13.80	2.38	12.23	2.65	11.29	2.81	10.75	2.85	8.56	3.00
	20	13.90	2.39	13.53	2.44	11.70	2.71	10.60	2.87	10.08	2.90	8.01	3.02
	21	13.92	2.41	13.51	2.45	11.45	2.66	10.21	2.78	9.71	2.83	7.72	3.03
	22	14.04	2.43	13.65	2.49	11.72	2.76	10.56	2.92	9.93	2.95	7.40	3.04
	24	14.55	2.45	13.96	2.51	11.01	2.80	9.24	2.97	8.74	2.99	6.74	3.07

Combination (Capacity)	Indoor Air Temp. °C DB	Outdoor Air Temp. °C									
		0/-1		-5/-6		-7/-8		-10/-11		-15/-	
		Total Q	Input Power	Total Q	Input Power	Total Q	Input Power	Total Q	Input Power	Total Q	Input Power
1.6 + 1.6 + 3.5 + 6.0	16	8.80	2.93	8.13	2.83	7.87	2.80	7.56	2.70	7.05	2.54
	18	8.33	2.98	7.76	2.86	7.53	2.81	7.41	2.73	7.22	2.59
	20	7.86	2.99	7.46	2.87	7.31	2.83	7.28	2.76	7.24	2.66
	21	7.53	3.00	7.07	2.89	6.89	2.84	7.00	2.78	7.19	2.69
	22	7.36	3.02	7.25	2.90	7.21	2.85	7.17	2.80	7.10	2.72
	24	6.85	3.05	7.11	2.94	7.22	2.89	7.07	2.85	6.82	2.79
1.6 + 1.6 + 3.5 + 7.1	16	8.80	2.91	8.13	2.81	7.87	2.78	7.56	2.68	7.05	2.52
	18	8.33	2.96	7.76	2.84	7.53	2.79	7.41	2.71	7.22	2.57
	20	7.86	2.97	7.46	2.85	7.31	2.81	7.28	2.75	7.24	2.64
	21	7.53	2.98	7.07	2.87	6.89	2.82	7.00	2.76	7.19	2.67
	22	7.36	3.00	7.25	2.88	7.21	2.83	7.17	2.78	7.10	2.70
	24	6.85	3.03	7.11	2.92	7.22	2.87	7.07	2.83	6.82	2.77
1.6 + 1.6 + 4.2 + 4.2	16	8.80	2.97	8.13	2.87	7.87	2.84	7.56	2.74	7.05	2.57
	18	8.33	3.02	7.76	2.90	7.53	2.85	7.41	2.76	7.22	2.62
	20	7.86	3.03	7.46	2.91	7.31	2.87	7.28	2.80	7.24	2.70
	21	7.53	3.05	7.07	2.93	6.89	2.88	7.00	2.82	7.19	2.73
	22	7.36	3.06	7.25	2.94	7.21	2.89	7.17	2.84	7.10	2.76
	24	6.85	3.09	7.11	2.98	7.22	2.93	7.07	2.89	6.82	2.83
1.6 + 1.6 + 4.2 + 5.0	16	8.80	2.92	8.13	2.82	7.87	2.79	7.56	2.69	7.05	2.53
	18	8.33	2.97	7.76	2.85	7.53	2.80	7.41	2.72	7.22	2.58
	20	7.86	2.98	7.46	2.86	7.31	2.82	7.28	2.75	7.24	2.65
	21	7.53	2.99	7.07	2.88	6.89	2.83	7.00	2.77	7.19	2.68
	22	7.36	3.01	7.25	2.89	7.21	2.84	7.17	2.79	7.10	2.71
	24	6.85	3.04	7.11	2.93	7.22	2.88	7.07	2.84	6.82	2.78
1.6 + 1.6 + 4.2 + 6.0	16	8.80	2.92	8.13	2.82	7.87	2.79	7.56	2.69	7.05	2.53
	18	8.33	2.97	7.76	2.85	7.53	2.80	7.41	2.72	7.22	2.58
	20	7.86	2.98	7.46	2.86	7.31	2.82	7.28	2.75	7.24	2.65
	21	7.53	2.99	7.07	2.88	6.89	2.83	7.00	2.77	7.19	2.68
	22	7.36	3.01	7.25	2.89	7.21	2.84	7.17	2.79	7.10	2.71
	24	6.85	3.04	7.11	2.93	7.22	2.88	7.07	2.84	6.82	2.78
1.6 + 1.6 + 4.2 + 7.1	16	8.80	2.91	8.13	2.81	7.87	2.78	7.56	2.68	7.05	2.52
	18	8.33	2.96	7.76	2.84	7.53	2.79	7.41	2.71	7.22	2.57
	20	7.86	2.97	7.46	2.85	7.31	2.81	7.28	2.75	7.24	2.64
	21	7.53	2.98	7.07	2.87	6.89	2.82	7.00	2.76	7.19	2.67
	22	7.36	3.00	7.25	2.88	7.21	2.83	7.17	2.78	7.10	2.70
	24	6.85	3.03	7.11	2.92	7.22	2.87	7.07	2.83	6.82	2.77

Combination (Capacity)	Indoor Air Temp. °C DB	Outdoor Air Temp. °C											
		16/15		15/14		10/9		7/6		6/5		2/1	
		Total Q	Input Power	Total Q	Input Power	Total Q	Input Power	Total Q	Input Power	Total Q	Input Power	Total Q	Input Power
1.6 + 1.6 + 5.0 + 5.0	16	14.72	2.22	14.42	2.27	12.91	2.55	12.00	2.72	11.41	2.76	9.06	2.92
	18	14.11	2.31	13.80	2.36	12.23	2.63	11.29	2.79	10.75	2.83	8.56	2.98
	20	13.90	2.37	13.53	2.42	11.70	2.69	10.60	2.85	10.08	2.88	8.01	2.99
	21	13.92	2.40	13.51	2.44	11.45	2.64	10.21	2.76	9.71	2.81	7.72	3.01
	22	14.04	2.42	13.65	2.47	11.72	2.74	10.56	2.90	9.93	2.93	7.40	3.02
	24	14.55	2.44	13.96	2.49	11.01	2.78	9.24	2.95	8.74	2.97	6.74	3.05
1.6 + 1.6 + 5.0 + 6.0	16	14.72	2.22	14.42	2.27	12.91	2.55	12.00	2.72	11.41	2.76	9.06	2.92
	18	14.11	2.31	13.80	2.36	12.23	2.63	11.29	2.79	10.75	2.83	8.56	2.98
	20	13.90	2.37	13.53	2.42	11.70	2.69	10.60	2.85	10.08	2.88	8.01	2.99
	21	13.92	2.40	13.51	2.44	11.45	2.64	10.21	2.76	9.71	2.81	7.72	3.01
	22	14.04	2.42	13.65	2.47	11.72	2.74	10.56	2.90	9.93	2.93	7.40	3.02
	24	14.55	2.44	13.96	2.49	11.01	2.78	9.24	2.95	8.74	2.97	6.74	3.05
1.6 + 2.0 + 2.0 + 2.0	16	14.72	2.33	14.42	2.39	12.91	2.69	12.00	2.87	11.41	2.91	9.06	3.08
	18	14.11	2.43	13.80	2.49	12.23	2.77	11.29	2.94	10.75	2.98	8.56	3.14
	20	13.90	2.50	13.53	2.55	11.70	2.83	10.60	3.00	10.08	3.03	8.01	3.15
	21	13.92	2.52	13.51	2.57	11.45	2.78	10.21	2.90	9.71	2.95	7.72	3.17
	22	14.04	2.54	13.65	2.60	11.72	2.88	10.56	3.06	9.93	3.08	7.40	3.18
	24	14.55	2.57	13.96	2.63	11.01	2.92	9.24	3.10	8.74	3.12	6.74	3.21
1.6 + 2.0 + 2.0 + 2.5	16	14.72	2.33	14.42	2.39	12.91	2.69	12.00	2.87	11.41	2.91	9.06	3.08
	18	14.11	2.43	13.80	2.49	12.23	2.77	11.29	2.94	10.75	2.98	8.56	3.14
	20	13.90	2.50	13.53	2.55	11.70	2.83	10.60	3.00	10.08	3.03	8.01	3.15
	21	13.92	2.52	13.51	2.57	11.45	2.78	10.21	2.90	9.71	2.95	7.72	3.17
	22	14.04	2.54	13.65	2.60	11.72	2.88	10.56	3.06	9.93	3.08	7.40	3.18
	24	14.55	2.57	13.96	2.63	11.01	2.92	9.24	3.10	8.74	3.12	6.74	3.21
1.6 + 2.0 + 2.0 + 3.5	16	14.72	2.31	14.42	2.37	12.91	2.66	12.00	2.84	11.41	2.88	9.06	3.05
	18	14.11	2.41	13.80	2.46	12.23	2.74	11.29	2.91	10.75	2.95	8.56	3.11
	20	13.90	2.47	13.53	2.53	11.70	2.80	10.60	2.97	10.08	3.00	8.01	3.12
	21	13.92	2.50	13.51	2.54	11.45	2.75	10.21	2.87	9.71	2.93	7.72	3.13
	22	14.04	2.52	13.65	2.57	11.72	2.86	10.56	3.02	9.93	3.05	7.40	3.15
	24	14.55	2.54	13.96	2.60	11.01	2.89	9.24	3.07	8.74	3.09	6.74	3.18
1.6 + 2.0 + 2.0 + 4.2	16	14.72	2.30	14.42	2.36	12.91	2.65	12.00	2.83	11.41	2.87	9.06	3.04
	18	14.11	2.40	13.80	2.45	12.23	2.73	11.29	2.90	10.75	2.94	8.56	3.10
	20	13.90	2.46	13.53	2.52	11.70	2.79	10.60	2.96	10.08	2.99	8.01	3.11
	21	13.92	2.49	13.51	2.53	11.45	2.74	10.21	2.86	9.71	2.92	7.72	3.12
	22	14.04	2.51	13.65	2.56	11.72	2.85	10.56	3.01	9.93	3.04	7.40	3.14
	24	14.55	2.53	13.96	2.59	11.01	2.88	9.24	3.06	8.74	3.08	6.74	3.17

Combination (Capacity)	Indoor Air Temp. °C DB	Outdoor Air Temp. °C									
		0/-1		-5/-6		-7/-8		-10/-11		-15/-	
		Total Q	Input Power	Total Q	Input Power	Total Q	Input Power	Total Q	Input Power	Total Q	Input Power
1.6 + 1.6 + 5.0 + 5.0	16	8.80	2.89	8.13	2.79	7.87	2.76	7.56	2.66	7.05	2.50
	18	8.33	2.93	7.76	2.82	7.53	2.77	7.41	2.69	7.22	2.55
	20	7.86	2.95	7.46	2.83	7.31	2.79	7.28	2.73	7.24	2.62
	21	7.53	2.96	7.07	2.85	6.89	2.80	7.00	2.75	7.19	2.65
	22	7.36	2.98	7.25	2.86	7.21	2.81	7.17	2.77	7.10	2.68
	24	6.85	3.01	7.11	2.89	7.22	2.85	7.07	2.81	6.82	2.75
1.6 + 1.6 + 5.0 + 6.0	16	8.80	2.89	8.13	2.79	7.87	2.76	7.56	2.66	7.05	2.50
	18	8.33	2.93	7.76	2.82	7.53	2.77	7.41	2.69	7.22	2.55
	20	7.86	2.95	7.46	2.83	7.31	2.79	7.28	2.73	7.24	2.62
	21	7.53	2.96	7.07	2.85	6.89	2.80	7.00	2.75	7.19	2.65
	22	7.36	2.98	7.25	2.86	7.21	2.81	7.17	2.77	7.10	2.68
	24	6.85	3.01	7.11	2.89	7.22	2.85	7.07	2.81	6.82	2.75
1.6 + 2.0 + 2.0 + 2.0	16	8.80	3.04	8.13	2.94	7.87	2.90	7.56	2.80	7.05	2.63
	18	8.33	3.09	7.76	2.97	7.53	2.92	7.41	2.83	7.22	2.69
	20	7.86	3.10	7.46	2.98	7.31	2.94	7.28	2.87	7.24	2.76
	21	7.53	3.12	7.07	3.00	6.89	2.95	7.00	2.89	7.19	2.79
	22	7.36	3.13	7.25	3.01	7.21	2.96	7.17	2.91	7.10	2.82
	24	6.85	3.17	7.11	3.05	7.22	3.00	7.07	2.96	6.82	2.89
1.6 + 2.0 + 2.0 + 2.5	16	8.80	3.04	8.13	2.94	7.87	2.90	7.56	2.80	7.05	2.63
	18	8.33	3.09	7.76	2.97	7.53	2.92	7.41	2.83	7.22	2.69
	20	7.86	3.10	7.46	2.98	7.31	2.94	7.28	2.87	7.24	2.76
	21	7.53	3.12	7.07	3.00	6.89	2.95	7.00	2.89	7.19	2.79
	22	7.36	3.13	7.25	3.01	7.21	2.96	7.17	2.91	7.10	2.82
	24	6.85	3.17	7.11	3.05	7.22	3.00	7.07	2.96	6.82	2.89
1.6 + 2.0 + 2.0 + 3.5	16	8.80	3.01	8.13	2.91	7.87	2.87	7.56	2.77	7.05	2.61
	18	8.33	3.06	7.76	2.94	7.53	2.89	7.41	2.80	7.22	2.66
	20	7.86	3.07	7.46	2.95	7.31	2.91	7.28	2.84	7.24	2.73
	21	7.53	3.09	7.07	2.97	6.89	2.92	7.00	2.86	7.19	2.76
	22	7.36	3.10	7.25	2.98	7.21	2.93	7.17	2.88	7.10	2.80
	24	6.85	3.13	7.11	3.02	7.22	2.97	7.07	2.93	6.82	2.86
1.6 + 2.0 + 2.0 + 4.2	16	8.80	3.00	8.13	2.90	7.87	2.86	7.56	2.77	7.05	2.60
	18	8.33	3.05	7.76	2.93	7.53	2.88	7.41	2.79	7.22	2.65
	20	7.86	3.06	7.46	2.94	7.31	2.90	7.28	2.83	7.24	2.72
	21	7.53	3.08	7.07	2.96	6.89	2.91	7.00	2.85	7.19	2.75
	22	7.36	3.09	7.25	2.97	7.21	2.92	7.17	2.87	7.10	2.79
	24	6.85	3.12	7.11	3.01	7.22	2.96	7.07	2.92	6.82	2.86

Combination (Capacity)	Indoor Air Temp. °C DB	Outdoor Air Temp. °C											
		16/15		15/14		10/9		7/6		6/5		2/1	
		Total Q	Input Power	Total Q	Input Power	Total Q	Input Power	Total Q	Input Power	Total Q	Input Power	Total Q	Input Power
1.6 + 2.0 + 2.0 + 5.0	16	14.72	2.26	14.42	2.31	12.91	2.60	12.00	2.77	11.41	2.81	9.06	2.98
	18	14.11	2.35	13.80	2.40	12.23	2.68	11.29	2.84	10.75	2.88	8.56	3.03
	20	13.90	2.41	13.53	2.47	11.70	2.74	10.60	2.90	10.08	2.93	8.01	3.05
	21	13.92	2.44	13.51	2.48	11.45	2.68	10.21	2.80	9.71	2.86	7.72	3.06
	22	14.04	2.46	13.65	2.51	11.72	2.79	10.56	2.95	9.93	2.98	7.40	3.07
	24	14.55	2.48	13.96	2.54	11.01	2.83	9.24	3.00	8.74	3.02	6.74	3.11
1.6 + 2.0 + 2.0 + 6.0	16	14.72	2.26	14.42	2.31	12.91	2.60	12.00	2.77	11.41	2.81	9.06	2.98
	18	14.11	2.35	13.80	2.40	12.23	2.68	11.29	2.84	10.75	2.88	8.56	3.03
	20	13.90	2.41	13.53	2.47	11.70	2.74	10.60	2.90	10.08	2.93	8.01	3.05
	21	13.92	2.44	13.51	2.48	11.45	2.68	10.21	2.80	9.71	2.86	7.72	3.06
	22	14.04	2.46	13.65	2.51	11.72	2.79	10.56	2.95	9.93	2.98	7.40	3.07
	24	14.55	2.48	13.96	2.54	11.01	2.83	9.24	3.00	8.74	3.02	6.74	3.11
1.6 + 2.0 + 2.0 + 7.1	16	14.72	2.25	14.42	2.31	12.91	2.59	12.00	2.76	11.41	2.80	9.06	2.97
	18	14.11	2.34	13.80	2.40	12.23	2.67	11.29	2.83	10.75	2.87	8.56	3.02
	20	13.90	2.40	13.53	2.46	11.70	2.73	10.60	2.89	10.08	2.92	8.01	3.04
	21	13.92	2.43	13.51	2.47	11.45	2.67	10.21	2.80	9.71	2.85	7.72	3.05
	22	14.04	2.45	13.65	2.50	11.72	2.78	10.56	2.94	9.93	2.97	7.40	3.06
	24	14.55	2.47	13.96	2.53	11.01	2.82	9.24	2.99	8.74	3.01	6.74	3.09
1.6 + 2.0 + 2.5 + 2.5	16	14.72	2.33	14.42	2.39	12.91	2.69	12.00	2.87	11.41	2.91	9.06	3.08
	18	14.11	2.43	13.80	2.49	12.23	2.77	11.29	2.94	10.75	2.98	8.56	3.14
	20	13.90	2.50	13.53	2.55	11.70	2.83	10.60	3.00	10.08	3.03	8.01	3.15
	21	13.92	2.52	13.51	2.57	11.45	2.78	10.21	2.90	9.71	2.95	7.72	3.17
	22	14.04	2.54	13.65	2.60	11.72	2.88	10.56	3.06	9.93	3.08	7.40	3.18
	24	14.55	2.57	13.96	2.63	11.01	2.92	9.24	3.10	8.74	3.12	6.74	3.21
1.6 + 2.0 + 2.5 + 3.5	16	14.72	2.31	14.42	2.37	12.91	2.66	12.00	2.84	11.41	2.88	9.06	3.05
	18	14.11	2.41	13.80	2.46	12.23	2.74	11.29	2.91	10.75	2.95	8.56	3.11
	20	13.90	2.47	13.53	2.53	11.70	2.80	10.60	2.97	10.08	3.00	8.01	3.12
	21	13.92	2.50	13.51	2.54	11.45	2.75	10.21	2.87	9.71	2.93	7.72	3.13
	22	14.04	2.52	13.65	2.57	11.72	2.86	10.56	3.02	9.93	3.05	7.40	3.15
	24	14.55	2.54	13.96	2.60	11.01	2.89	9.24	3.07	8.74	3.09	6.74	3.18
1.6 + 2.0 + 2.5 + 4.2	16	14.72	2.30	14.42	2.36	12.91	2.65	12.00	2.83	11.41	2.87	9.06	3.04
	18	14.11	2.40	13.80	2.45	12.23	2.73	11.29	2.90	10.75	2.94	8.56	3.10
	20	13.90	2.46	13.53	2.52	11.70	2.79	10.60	2.96	10.08	2.99	8.01	3.11
	21	13.92	2.49	13.51	2.53	11.45	2.74	10.21	2.86	9.71	2.92	7.72	3.12
	22	14.04	2.51	13.65	2.56	11.72	2.85	10.56	3.01	9.93	3.04	7.40	3.14
	24	14.55	2.53	13.96	2.59	11.01	2.88	9.24	3.06	8.74	3.08	6.74	3.17



Combination (Capacity)	Indoor Air Temp. °C DB	Outdoor Air Temp. °C									
		0/-1		-5/-6		-7/-8		-10/-11		-15/-	
		Total Q	Input Power	Total Q	Input Power	Total Q	Input Power	Total Q	Input Power	Total Q	Input Power
1.6 + 2.0 + 2.0 + 5.0	16	8.80	2.94	8.13	2.84	7.87	2.81	7.56	2.71	7.05	2.55
	18	8.33	2.99	7.76	2.87	7.53	2.82	7.41	2.74	7.22	2.60
	20	7.86	3.00	7.46	2.88	7.31	2.84	7.28	2.77	7.24	2.67
	21	7.53	3.01	7.07	2.90	6.89	2.85	7.00	2.79	7.19	2.70
	22	7.36	3.03	7.25	2.91	7.21	2.86	7.17	2.81	7.10	2.73
	24	6.85	3.06	7.11	2.95	7.22	2.90	7.07	2.86	6.82	2.80
1.6 + 2.0 + 2.0 + 6.0	16	8.80	2.94	8.13	2.84	7.87	2.81	7.56	2.71	7.05	2.55
	18	8.33	2.99	7.76	2.87	7.53	2.82	7.41	2.74	7.22	2.60
	20	7.86	3.00	7.46	2.88	7.31	2.84	7.28	2.77	7.24	2.67
	21	7.53	3.01	7.07	2.90	6.89	2.85	7.00	2.79	7.19	2.70
	22	7.36	3.03	7.25	2.91	7.21	2.86	7.17	2.81	7.10	2.73
	24	6.85	3.06	7.11	2.95	7.22	2.90	7.07	2.86	6.82	2.80
1.6 + 2.0 + 2.0 + 7.1	16	8.80	2.93	8.13	2.83	7.87	2.80	7.56	2.70	7.05	2.54
	18	8.33	2.98	7.76	2.86	7.53	2.81	7.41	2.73	7.22	2.59
	20	7.86	2.99	7.46	2.87	7.31	2.83	7.28	2.76	7.24	2.66
	21	7.53	3.00	7.07	2.89	6.89	2.84	7.00	2.78	7.19	2.69
	22	7.36	3.02	7.25	2.90	7.21	2.85	7.17	2.80	7.10	2.72
	24	6.85	3.05	7.11	2.94	7.22	2.89	7.07	2.85	6.82	2.79
1.6 + 2.0 + 2.5 + 2.5	16	8.80	3.04	8.13	2.94	7.87	2.90	7.56	2.80	7.05	2.63
	18	8.33	3.09	7.76	2.97	7.53	2.92	7.41	2.83	7.22	2.69
	20	7.86	3.10	7.46	2.98	7.31	2.94	7.28	2.87	7.24	2.76
	21	7.53	3.12	7.07	3.00	6.89	2.95	7.00	2.89	7.19	2.79
	22	7.36	3.13	7.25	3.01	7.21	2.96	7.17	2.91	7.10	2.82
	24	6.85	3.17	7.11	3.05	7.22	3.00	7.07	2.96	6.82	2.89
1.6 + 2.0 + 2.5 + 3.5	16	8.80	3.01	8.13	2.91	7.87	2.87	7.56	2.77	7.05	2.61
	18	8.33	3.06	7.76	2.94	7.53	2.89	7.41	2.80	7.22	2.66
	20	7.86	3.07	7.46	2.95	7.31	2.91	7.28	2.84	7.24	2.73
	21	7.53	3.09	7.07	2.97	6.89	2.92	7.00	2.86	7.19	2.76
	22	7.36	3.10	7.25	2.98	7.21	2.93	7.17	2.88	7.10	2.80
	24	6.85	3.13	7.11	3.02	7.22	2.97	7.07	2.93	6.82	2.86
1.6 + 2.0 + 2.5 + 4.2	16	8.80	3.00	8.13	2.90	7.87	2.86	7.56	2.77	7.05	2.60
	18	8.33	3.05	7.76	2.93	7.53	2.88	7.41	2.79	7.22	2.65
	20	7.86	3.06	7.46	2.94	7.31	2.90	7.28	2.83	7.24	2.72
	21	7.53	3.08	7.07	2.96	6.89	2.91	7.00	2.85	7.19	2.75
	22	7.36	3.09	7.25	2.97	7.21	2.92	7.17	2.87	7.10	2.79
	24	6.85	3.12	7.11	3.01	7.22	2.96	7.07	2.92	6.82	2.86

Combination (Capacity)	Indoor Air Temp. °C DB	Outdoor Air Temp. °C											
		16/15		15/14		10/9		7/6		6/5		2/1	
		Total Q	Input Power	Total Q	Input Power	Total Q	Input Power	Total Q	Input Power	Total Q	Input Power	Total Q	Input Power
1.6 + 2.0 + 2.5 + 5.0	16	14.72	2.26	14.42	2.31	12.91	2.60	12.00	2.77	11.41	2.81	9.06	2.98
	18	14.11	2.35	13.80	2.40	12.23	2.68	11.29	2.84	10.75	2.88	8.56	3.03
	20	13.90	2.41	13.53	2.47	11.70	2.74	10.60	2.90	10.08	2.93	8.01	3.05
	21	13.92	2.44	13.51	2.48	11.45	2.68	10.21	2.80	9.71	2.86	7.72	3.06
	22	14.04	2.46	13.65	2.51	11.72	2.79	10.56	2.95	9.93	2.98	7.40	3.07
	24	14.55	2.48	13.96	2.54	11.01	2.83	9.24	3.00	8.74	3.02	6.74	3.11
1.6 + 2.0 + 2.5 + 6.0	16	14.72	2.26	14.42	2.31	12.91	2.60	12.00	2.77	11.41	2.81	9.06	2.98
	18	14.11	2.35	13.80	2.40	12.23	2.68	11.29	2.84	10.75	2.88	8.56	3.03
	20	13.90	2.41	13.53	2.47	11.70	2.74	10.60	2.90	10.08	2.93	8.01	3.05
	21	13.92	2.44	13.51	2.48	11.45	2.68	10.21	2.80	9.71	2.86	7.72	3.06
	22	14.04	2.46	13.65	2.51	11.72	2.79	10.56	2.95	9.93	2.98	7.40	3.07
	24	14.55	2.48	13.96	2.54	11.01	2.83	9.24	3.00	8.74	3.02	6.74	3.11
1.6 + 2.0 + 2.5 + 7.1	16	14.72	2.25	14.42	2.31	12.91	2.59	12.00	2.76	11.41	2.80	9.06	2.97
	18	14.11	2.34	13.80	2.40	12.23	2.67	11.29	2.83	10.75	2.87	8.56	3.02
	20	13.90	2.40	13.53	2.46	11.70	2.73	10.60	2.89	10.08	2.92	8.01	3.04
	21	13.92	2.43	13.51	2.47	11.45	2.67	10.21	2.80	9.71	2.85	7.72	3.05
	22	14.04	2.45	13.65	2.50	11.72	2.78	10.56	2.94	9.93	2.97	7.40	3.06
	24	14.55	2.47	13.96	2.53	11.01	2.82	9.24	2.99	8.74	3.01	6.74	3.09
1.6 + 2.0 + 3.5 + 3.5	16	14.72	2.29	14.42	2.35	12.91	2.63	12.00	2.81	11.41	2.85	9.06	3.02
	18	14.11	2.38	13.80	2.44	12.23	2.72	11.29	2.88	10.75	2.92	8.56	3.08
	20	13.90	2.45	13.53	2.50	11.70	2.78	10.60	2.94	10.08	2.97	8.01	3.09
	21	13.92	2.47	13.51	2.51	11.45	2.72	10.21	2.84	9.71	2.90	7.72	3.10
	22	14.04	2.49	13.65	2.55	11.72	2.83	10.56	2.99	9.93	3.02	7.40	3.12
	24	14.55	2.51	13.96	2.57	11.01	2.86	9.24	3.04	8.74	3.06	6.74	3.15
1.6 + 2.0 + 3.5 + 4.2	16	14.72	2.28	14.42	2.34	12.91	2.63	12.00	2.80	11.41	2.84	9.06	3.01
	18	14.11	2.37	13.80	2.43	12.23	2.71	11.29	2.87	10.75	2.91	8.56	3.07
	20	13.90	2.44	13.53	2.49	11.70	2.77	10.60	2.93	10.08	2.96	8.01	3.08
	21	13.92	2.46	13.51	2.51	11.45	2.71	10.21	2.83	9.71	2.89	7.72	3.09
	22	14.04	2.48	13.65	2.54	11.72	2.82	10.56	2.98	9.93	3.01	7.40	3.11
	24	14.55	2.51	13.96	2.56	11.01	2.85	9.24	3.03	8.74	3.05	6.74	3.14
1.6 + 2.0 + 3.5 + 5.0	16	14.72	2.24	14.42	2.30	12.91	2.58	12.00	2.75	11.41	2.79	9.06	2.96
	18	14.11	2.33	13.80	2.39	12.23	2.66	11.29	2.82	10.75	2.86	8.56	3.01
	20	13.90	2.40	13.53	2.45	11.70	2.72	10.60	2.88	10.08	2.91	8.01	3.03
	21	13.92	2.42	13.51	2.46	11.45	2.66	10.21	2.79	9.71	2.84	7.72	3.04
	22	14.04	2.44	13.65	2.50	11.72	2.77	10.56	2.93	9.93	2.96	7.40	3.05
	24	14.55	2.46	13.96	2.52	11.01	2.81	9.24	2.98	8.74	3.00	6.74	3.08

Combination (Capacity)	Indoor Air Temp. °C DB	Outdoor Air Temp. °C									
		0/-1		-5/-6		-7/-8		-10/-11		-15/-	
		Total Q	Input Power	Total Q	Input Power	Total Q	Input Power	Total Q	Input Power	Total Q	Input Power
1.6 + 2.0 + 2.5 + 5.0	16	8.80	2.94	8.13	2.84	7.87	2.81	7.56	2.71	7.05	2.55
	18	8.33	2.99	7.76	2.87	7.53	2.82	7.41	2.74	7.22	2.60
	20	7.86	3.00	7.46	2.88	7.31	2.84	7.28	2.77	7.24	2.67
	21	7.53	3.01	7.07	2.90	6.89	2.85	7.00	2.79	7.19	2.70
	22	7.36	3.03	7.25	2.91	7.21	2.86	7.17	2.81	7.10	2.73
	24	6.85	3.06	7.11	2.95	7.22	2.90	7.07	2.86	6.82	2.80
1.6 + 2.0 + 2.5 + 6.0	16	8.80	2.94	8.13	2.84	7.87	2.81	7.56	2.71	7.05	2.55
	18	8.33	2.99	7.76	2.87	7.53	2.82	7.41	2.74	7.22	2.60
	20	7.86	3.00	7.46	2.88	7.31	2.84	7.28	2.77	7.24	2.67
	21	7.53	3.01	7.07	2.90	6.89	2.85	7.00	2.79	7.19	2.70
	22	7.36	3.03	7.25	2.91	7.21	2.86	7.17	2.81	7.10	2.73
	24	6.85	3.06	7.11	2.95	7.22	2.90	7.07	2.86	6.82	2.80
1.6 + 2.0 + 2.5 + 7.1	16	8.80	2.93	8.13	2.83	7.87	2.80	7.56	2.70	7.05	2.54
	18	8.33	2.98	7.76	2.86	7.53	2.81	7.41	2.73	7.22	2.59
	20	7.86	2.99	7.46	2.87	7.31	2.83	7.28	2.76	7.24	2.66
	21	7.53	3.00	7.07	2.89	6.89	2.84	7.00	2.78	7.19	2.69
	22	7.36	3.02	7.25	2.90	7.21	2.85	7.17	2.80	7.10	2.72
	24	6.85	3.05	7.11	2.94	7.22	2.89	7.07	2.85	6.82	2.79
1.6 + 2.0 + 3.5 + 3.5	16	8.80	2.98	8.13	2.88	7.87	2.84	7.56	2.75	7.05	2.58
	18	8.33	3.03	7.76	2.91	7.53	2.86	7.41	2.77	7.22	2.63
	20	7.86	3.04	7.46	2.92	7.31	2.88	7.28	2.81	7.24	2.70
	21	7.53	3.06	7.07	2.94	6.89	2.89	7.00	2.83	7.19	2.74
	22	7.36	3.07	7.25	2.95	7.21	2.90	7.17	2.85	7.10	2.77
	24	6.85	3.10	7.11	2.99	7.22	2.94	7.07	2.90	6.82	2.84
1.6 + 2.0 + 3.5 + 4.2	16	8.80	2.97	8.13	2.87	7.87	2.84	7.56	2.74	7.05	2.57
	18	8.33	3.02	7.76	2.90	7.53	2.85	7.41	2.76	7.22	2.62
	20	7.86	3.03	7.46	2.91	7.31	2.87	7.28	2.80	7.24	2.70
	21	7.53	3.05	7.07	2.93	6.89	2.88	7.00	2.82	7.19	2.73
	22	7.36	3.06	7.25	2.94	7.21	2.89	7.17	2.84	7.10	2.76
	24	6.85	3.09	7.11	2.98	7.22	2.93	7.07	2.89	6.82	2.83
1.6 + 2.0 + 3.5 + 5.0	16	8.80	2.92	8.13	2.82	7.87	2.79	7.56	2.69	7.05	2.53
	18	8.33	2.97	7.76	2.85	7.53	2.80	7.41	2.72	7.22	2.58
	20	7.86	2.98	7.46	2.86	7.31	2.82	7.28	2.75	7.24	2.65
	21	7.53	2.99	7.07	2.88	6.89	2.83	7.00	2.77	7.19	2.68
	22	7.36	3.01	7.25	2.89	7.21	2.84	7.17	2.79	7.10	2.71
	24	6.85	3.04	7.11	2.93	7.22	2.88	7.07	2.84	6.82	2.78

Combination (Capacity)	Indoor Air Temp. °C DB	Outdoor Air Temp. °C											
		16/15		15/14		10/9		7/6		6/5		2/1	
		Total Q	Input Power	Total Q	Input Power	Total Q	Input Power	Total Q	Input Power	Total Q	Input Power	Total Q	Input Power
1.6 + 2.0 + 3.5 + 6.0	16	14.72	2.24	14.42	2.30	12.91	2.58	12.00	2.75	11.41	2.79	9.06	2.96
	18	14.11	2.33	13.80	2.39	12.23	2.66	11.29	2.82	10.75	2.86	8.56	3.01
	20	13.90	2.40	13.53	2.45	11.70	2.72	10.60	2.88	10.08	2.91	8.01	3.03
	21	13.92	2.42	13.51	2.46	11.45	2.66	10.21	2.79	9.71	2.84	7.72	3.04
	22	14.04	2.44	13.65	2.50	11.72	2.77	10.56	2.93	9.93	2.96	7.40	3.05
	24	14.55	2.46	13.96	2.52	11.01	2.81	9.24	2.98	8.74	3.00	6.74	3.08
1.6 + 2.0 + 3.5 + 7.1	16	14.72	2.23	14.42	2.29	12.91	2.57	12.00	2.74	11.41	2.78	9.06	2.95
	18	14.11	2.33	13.80	2.38	12.23	2.65	11.29	2.81	10.75	2.85	8.56	3.00
	20	13.90	2.39	13.53	2.44	11.70	2.71	10.60	2.87	10.08	2.90	8.01	3.02
	21	13.92	2.41	13.51	2.45	11.45	2.66	10.21	2.78	9.71	2.83	7.72	3.03
	22	14.04	2.43	13.65	2.49	11.72	2.76	10.56	2.92	9.93	2.95	7.40	3.04
	24	14.55	2.45	13.96	2.51	11.01	2.80	9.24	2.97	8.74	2.99	6.74	3.07
1.6 + 2.0 + 4.2 + 4.2	16	14.72	2.27	14.42	2.33	12.91	2.62	12.00	2.79	11.41	2.83	9.06	3.00
	18	14.11	2.37	13.80	2.42	12.23	2.70	11.29	2.86	10.75	2.90	8.56	3.05
	20	13.90	2.43	13.53	2.48	11.70	2.76	10.60	2.92	10.08	2.95	8.01	3.07
	21	13.92	2.46	13.51	2.50	11.45	2.70	10.21	2.82	9.71	2.88	7.72	3.08
	22	14.04	2.47	13.65	2.53	11.72	2.81	10.56	2.97	9.93	3.00	7.40	3.10
	24	14.55	2.50	13.96	2.56	11.01	2.85	9.24	3.02	8.74	3.04	6.74	3.13
1.6 + 2.0 + 4.2 + 5.0	16	14.72	2.23	14.42	2.29	12.91	2.57	12.00	2.74	11.41	2.78	9.06	2.95
	18	14.11	2.33	13.80	2.38	12.23	2.65	11.29	2.81	10.75	2.85	8.56	3.00
	20	13.90	2.39	13.53	2.44	11.70	2.71	10.60	2.87	10.08	2.90	8.01	3.02
	21	13.92	2.41	13.51	2.45	11.45	2.66	10.21	2.78	9.71	2.83	7.72	3.03
	22	14.04	2.43	13.65	2.49	11.72	2.76	10.56	2.92	9.93	2.95	7.40	3.04
	24	14.55	2.45	13.96	2.51	11.01	2.80	9.24	2.97	8.74	2.99	6.74	3.07
1.6 + 2.0 + 4.2 + 6.0	16	14.72	2.23	14.42	2.29	12.91	2.57	12.00	2.74	11.41	2.78	9.06	2.95
	18	14.11	2.33	13.80	2.38	12.23	2.65	11.29	2.81	10.75	2.85	8.56	3.00
	20	13.90	2.39	13.53	2.44	11.70	2.71	10.60	2.87	10.08	2.90	8.01	3.02
	21	13.92	2.41	13.51	2.45	11.45	2.66	10.21	2.78	9.71	2.83	7.72	3.03
	22	14.04	2.43	13.65	2.49	11.72	2.76	10.56	2.92	9.93	2.95	7.40	3.04
	24	14.55	2.45	13.96	2.51	11.01	2.80	9.24	2.97	8.74	2.99	6.74	3.07
1.6 + 2.0 + 5.0 + 5.0	16	14.72	2.26	14.42	2.31	12.91	2.60	12.00	2.77	11.41	2.81	9.06	2.98
	18	14.11	2.35	13.80	2.40	12.23	2.68	11.29	2.84	10.75	2.88	8.56	3.03
	20	13.90	2.41	13.53	2.47	11.70	2.74	10.60	2.90	10.08	2.93	8.01	3.05
	21	13.92	2.44	13.51	2.48	11.45	2.68	10.21	2.80	9.71	2.86	7.72	3.06
	22	14.04	2.46	13.65	2.51	11.72	2.79	10.56	2.95	9.93	2.98	7.40	3.07
	24	14.55	2.48	13.96	2.54	11.01	2.83	9.24	3.00	8.74	3.02	6.74	3.11

Combination (Capacity)	Indoor Air Temp. °C DB	Outdoor Air Temp. °C									
		0/-1		-5/-6		-7/-8		-10/-11		-15/-	
		Total Q	Input Power	Total Q	Input Power	Total Q	Input Power	Total Q	Input Power	Total Q	Input Power
1.6 + 2.0 + 3.5 + 6.0	16	8.80	2.92	8.13	2.82	7.87	2.79	7.56	2.69	7.05	2.53
	18	8.33	2.97	7.76	2.85	7.53	2.80	7.41	2.72	7.22	2.58
	20	7.86	2.98	7.46	2.86	7.31	2.82	7.28	2.75	7.24	2.65
	21	7.53	2.99	7.07	2.88	6.89	2.83	7.00	2.77	7.19	2.68
	22	7.36	3.01	7.25	2.89	7.21	2.84	7.17	2.79	7.10	2.71
	24	6.85	3.04	7.11	2.93	7.22	2.88	7.07	2.84	6.82	2.78
1.6 + 2.0 + 3.5 + 7.1	16	8.80	2.91	8.13	2.81	7.87	2.78	7.56	2.68	7.05	2.52
	18	8.33	2.96	7.76	2.84	7.53	2.79	7.41	2.71	7.22	2.57
	20	7.86	2.97	7.46	2.85	7.31	2.81	7.28	2.75	7.24	2.64
	21	7.53	2.98	7.07	2.87	6.89	2.82	7.00	2.76	7.19	2.67
	22	7.36	3.00	7.25	2.88	7.21	2.83	7.17	2.78	7.10	2.70
	24	6.85	3.03	7.11	2.92	7.22	2.87	7.07	2.83	6.82	2.77
1.6 + 2.0 + 4.2 + 4.2	16	8.80	2.96	8.13	2.86	7.87	2.83	7.56	2.73	7.05	2.56
	18	8.33	3.01	7.76	2.89	7.53	2.84	7.41	2.75	7.22	2.61
	20	7.86	3.02	7.46	2.90	7.31	2.86	7.28	2.79	7.24	2.69
	21	7.53	3.03	7.07	2.92	6.89	2.87	7.00	2.81	7.19	2.72
	22	7.36	3.05	7.25	2.93	7.21	2.88	7.17	2.83	7.10	2.75
	24	6.85	3.08	7.11	2.97	7.22	2.92	7.07	2.88	6.82	2.82
1.6 + 2.0 + 4.2 + 5.0	16	8.80	2.91	8.13	2.81	7.87	2.78	7.56	2.68	7.05	2.52
	18	8.33	2.96	7.76	2.84	7.53	2.79	7.41	2.71	7.22	2.57
	20	7.86	2.97	7.46	2.85	7.31	2.81	7.28	2.75	7.24	2.64
	21	7.53	2.98	7.07	2.87	6.89	2.82	7.00	2.76	7.19	2.67
	22	7.36	3.00	7.25	2.88	7.21	2.83	7.17	2.78	7.10	2.70
	24	6.85	3.03	7.11	2.92	7.22	2.87	7.07	2.83	6.82	2.77
1.6 + 2.0 + 4.2 + 6.0	16	8.80	2.91	8.13	2.81	7.87	2.78	7.56	2.68	7.05	2.52
	18	8.33	2.96	7.76	2.84	7.53	2.79	7.41	2.71	7.22	2.57
	20	7.86	2.97	7.46	2.85	7.31	2.81	7.28	2.75	7.24	2.64
	21	7.53	2.98	7.07	2.87	6.89	2.82	7.00	2.76	7.19	2.67
	22	7.36	3.00	7.25	2.88	7.21	2.83	7.17	2.78	7.10	2.70
	24	6.85	3.03	7.11	2.92	7.22	2.87	7.07	2.83	6.82	2.77
1.6 + 2.0 + 5.0 + 5.0	16	8.80	2.94	8.13	2.84	7.87	2.81	7.56	2.71	7.05	2.55
	18	8.33	2.99	7.76	2.87	7.53	2.82	7.41	2.74	7.22	2.60
	20	7.86	3.00	7.46	2.88	7.31	2.84	7.28	2.77	7.24	2.67
	21	7.53	3.01	7.07	2.90	6.89	2.85	7.00	2.79	7.19	2.70
	22	7.36	3.03	7.25	2.91	7.21	2.86	7.17	2.81	7.10	2.73
	24	6.85	3.06	7.11	2.95	7.22	2.90	7.07	2.86	6.82	2.80

Combination (Capacity)	Indoor Air Temp. °C DB	Outdoor Air Temp. °C											
		16/15		15/14		10/9		7/6		6/5		2/1	
		Total Q	Input Power	Total Q	Input Power	Total Q	Input Power	Total Q	Input Power	Total Q	Input Power	Total Q	Input Power
1.6 + 2.0 + 5.0 + 6.0	16	14.72	2.26	14.42	2.31	12.91	2.60	12.00	2.77	11.41	2.81	9.06	2.98
	18	14.11	2.35	13.80	2.40	12.23	2.68	11.29	2.84	10.75	2.88	8.56	3.03
	20	13.90	2.41	13.53	2.47	11.70	2.74	10.60	2.90	10.08	2.93	8.01	3.05
	21	13.92	2.44	13.51	2.48	11.45	2.68	10.21	2.80	9.71	2.86	7.72	3.06
	22	14.04	2.46	13.65	2.51	11.72	2.79	10.56	2.95	9.93	2.98	7.40	3.07
	24	14.55	2.48	13.96	2.54	11.01	2.83	9.24	3.00	8.74	3.02	6.74	3.11
1.6 + 2.5 + 2.5 + 2.5	16	14.72	2.33	14.42	2.39	12.91	2.69	12.00	2.87	11.41	2.91	9.06	3.08
	18	14.11	2.43	13.80	2.49	12.23	2.77	11.29	2.94	10.75	2.98	8.56	3.14
	20	13.90	2.50	13.53	2.55	11.70	2.83	10.60	3.00	10.08	3.03	8.01	3.15
	21	13.92	2.52	13.51	2.57	11.45	2.78	10.21	2.90	9.71	2.95	7.72	3.17
	22	14.04	2.54	13.65	2.60	11.72	2.88	10.56	3.06	9.93	3.08	7.40	3.18
	24	14.55	2.57	13.96	2.63	11.01	2.92	9.24	3.10	8.74	3.12	6.74	3.21
1.6 + 2.5 + 2.5 + 3.5	16	14.72	2.31	14.42	2.37	12.91	2.66	12.00	2.84	11.41	2.88	9.06	3.05
	18	14.11	2.41	13.80	2.46	12.23	2.74	11.29	2.91	10.75	2.95	8.56	3.11
	20	13.90	2.47	13.53	2.53	11.70	2.80	10.60	2.97	10.08	3.00	8.01	3.12
	21	13.92	2.50	13.51	2.54	11.45	2.75	10.21	2.87	9.71	2.93	7.72	3.13
	22	14.04	2.52	13.65	2.57	11.72	2.86	10.56	3.02	9.93	3.05	7.40	3.15
	24	14.55	2.54	13.96	2.60	11.01	2.89	9.24	3.07	8.74	3.09	6.74	3.18
1.6 + 2.5 + 2.5 + 4.2	16	14.72	2.30	14.42	2.36	12.91	2.65	12.00	2.83	11.41	2.87	9.06	3.04
	18	14.11	2.40	13.80	2.45	12.23	2.73	11.29	2.90	10.75	2.94	8.56	3.10
	20	13.90	2.46	13.53	2.52	11.70	2.79	10.60	2.96	10.08	2.99	8.01	3.11
	21	13.92	2.49	13.51	2.53	11.45	2.74	10.21	2.86	9.71	2.92	7.72	3.12
	22	14.04	2.51	13.65	2.56	11.72	2.85	10.56	3.01	9.93	3.04	7.40	3.14
	24	14.55	2.53	13.96	2.59	11.01	2.88	9.24	3.06	8.74	3.08	6.74	3.17
1.6 + 2.5 + 2.5 + 5.0	16	14.72	2.26	14.42	2.31	12.91	2.60	12.00	2.77	11.41	2.81	9.06	2.98
	18	14.11	2.35	13.80	2.40	12.23	2.68	11.29	2.84	10.75	2.88	8.56	3.03
	20	13.90	2.41	13.53	2.47	11.70	2.74	10.60	2.90	10.08	2.93	8.01	3.05
	21	13.92	2.44	13.51	2.48	11.45	2.68	10.21	2.80	9.71	2.86	7.72	3.06
	22	14.04	2.46	13.65	2.51	11.72	2.79	10.56	2.95	9.93	2.98	7.40	3.07
	24	14.55	2.48	13.96	2.54	11.01	2.83	9.24	3.00	8.74	3.02	6.74	3.11
1.6 + 2.5 + 2.5 + 6.0	16	14.72	2.26	14.42	2.31	12.91	2.60	12.00	2.77	11.41	2.81	9.06	2.98
	18	14.11	2.35	13.80	2.40	12.23	2.68	11.29	2.84	10.75	2.88	8.56	3.03
	20	13.90	2.41	13.53	2.47	11.70	2.74	10.60	2.90	10.08	2.93	8.01	3.05
	21	13.92	2.44	13.51	2.48	11.45	2.68	10.21	2.80	9.71	2.86	7.72	3.06
	22	14.04	2.46	13.65	2.51	11.72	2.79	10.56	2.95	9.93	2.98	7.40	3.07
	24	14.55	2.48	13.96	2.54	11.01	2.83	9.24	3.00	8.74	3.02	6.74	3.11

Combination (Capacity)	Indoor Air Temp. °C DB	Outdoor Air Temp. °C									
		0/-1		-5/-6		-7/-8		-10/-11		-15/-	
		Total Q	Input Power	Total Q	Input Power	Total Q	Input Power	Total Q	Input Power	Total Q	Input Power
1.6 + 2.0 + 5.0 + 6.0	16	8.80	2.94	8.13	2.84	7.87	2.81	7.56	2.71	7.05	2.55
	18	8.33	2.99	7.76	2.87	7.53	2.82	7.41	2.74	7.22	2.60
	20	7.86	3.00	7.46	2.88	7.31	2.84	7.28	2.77	7.24	2.67
	21	7.53	3.01	7.07	2.90	6.89	2.85	7.00	2.79	7.19	2.70
	22	7.36	3.03	7.25	2.91	7.21	2.86	7.17	2.81	7.10	2.73
	24	6.85	3.06	7.11	2.95	7.22	2.90	7.07	2.86	6.82	2.80
1.6 + 2.5 + 2.5 + 2.5	16	8.80	3.04	8.13	2.94	7.87	2.90	7.56	2.80	7.05	2.63
	18	8.33	3.09	7.76	2.97	7.53	2.92	7.41	2.83	7.22	2.69
	20	7.86	3.10	7.46	2.98	7.31	2.94	7.28	2.87	7.24	2.76
	21	7.53	3.12	7.07	3.00	6.89	2.95	7.00	2.89	7.19	2.79
	22	7.36	3.13	7.25	3.01	7.21	2.96	7.17	2.91	7.10	2.82
	24	6.85	3.17	7.11	3.05	7.22	3.00	7.07	2.96	6.82	2.89
1.6 + 2.5 + 2.5 + 3.5	16	8.80	3.01	8.13	2.91	7.87	2.87	7.56	2.77	7.05	2.61
	18	8.33	3.06	7.76	2.94	7.53	2.89	7.41	2.80	7.22	2.66
	20	7.86	3.07	7.46	2.95	7.31	2.91	7.28	2.84	7.24	2.73
	21	7.53	3.09	7.07	2.97	6.89	2.92	7.00	2.86	7.19	2.76
	22	7.36	3.10	7.25	2.98	7.21	2.93	7.17	2.88	7.10	2.80
	24	6.85	3.13	7.11	3.02	7.22	2.97	7.07	2.93	6.82	2.86
1.6 + 2.5 + 2.5 + 4.2	16	8.80	3.00	8.13	2.90	7.87	2.86	7.56	2.77	7.05	2.60
	18	8.33	3.05	7.76	2.93	7.53	2.88	7.41	2.79	7.22	2.65
	20	7.86	3.06	7.46	2.94	7.31	2.90	7.28	2.83	7.24	2.72
	21	7.53	3.08	7.07	2.96	6.89	2.91	7.00	2.85	7.19	2.75
	22	7.36	3.09	7.25	2.97	7.21	2.92	7.17	2.87	7.10	2.79
	24	6.85	3.12	7.11	3.01	7.22	2.96	7.07	2.92	6.82	2.86
1.6 + 2.5 + 2.5 + 5.0	16	8.80	2.94	8.13	2.84	7.87	2.81	7.56	2.71	7.05	2.55
	18	8.33	2.99	7.76	2.87	7.53	2.82	7.41	2.74	7.22	2.60
	20	7.86	3.00	7.46	2.88	7.31	2.84	7.28	2.77	7.24	2.67
	21	7.53	3.01	7.07	2.90	6.89	2.85	7.00	2.79	7.19	2.70
	22	7.36	3.03	7.25	2.91	7.21	2.86	7.17	2.81	7.10	2.73
	24	6.85	3.06	7.11	2.95	7.22	2.90	7.07	2.86	6.82	2.80
1.6 + 2.5 + 2.5 + 6.0	16	8.80	2.94	8.13	2.84	7.87	2.81	7.56	2.71	7.05	2.55
	18	8.33	2.99	7.76	2.87	7.53	2.82	7.41	2.74	7.22	2.60
	20	7.86	3.00	7.46	2.88	7.31	2.84	7.28	2.77	7.24	2.67
	21	7.53	3.01	7.07	2.90	6.89	2.85	7.00	2.79	7.19	2.70
	22	7.36	3.03	7.25	2.91	7.21	2.86	7.17	2.81	7.10	2.73
	24	6.85	3.06	7.11	2.95	7.22	2.90	7.07	2.86	6.82	2.80

Combination (Capacity)	Indoor Air Temp. °C DB	Outdoor Air Temp. °C											
		16/15		15/14		10/9		7/6		6/5		2/1	
		Total Q	Input Power	Total Q	Input Power	Total Q	Input Power	Total Q	Input Power	Total Q	Input Power	Total Q	Input Power
1.6 + 2.5 + 2.5 + 7.1	16	14.72	2.25	14.42	2.31	12.91	2.59	12.00	2.76	11.41	2.80	9.06	2.97
	18	14.11	2.34	13.80	2.40	12.23	2.67	11.29	2.83	10.75	2.87	8.56	3.02
	20	13.90	2.40	13.53	2.46	11.70	2.73	10.60	2.89	10.08	2.92	8.01	3.04
	21	13.92	2.43	13.51	2.47	11.45	2.67	10.21	2.80	9.71	2.85	7.72	3.05
	22	14.04	2.45	13.65	2.50	11.72	2.78	10.56	2.94	9.93	2.97	7.40	3.06
	24	14.55	2.47	13.96	2.53	11.01	2.82	9.24	2.99	8.74	3.01	6.74	3.09
1.6 + 2.5 + 3.5 + 3.5	16	14.72	2.29	14.42	2.35	12.91	2.63	12.00	2.81	11.41	2.85	9.06	3.02
	18	14.11	2.38	13.80	2.44	12.23	2.72	11.29	2.88	10.75	2.92	8.56	3.08
	20	13.90	2.45	13.53	2.50	11.70	2.78	10.60	2.94	10.08	2.97	8.01	3.09
	21	13.92	2.47	13.51	2.51	11.45	2.72	10.21	2.84	9.71	2.90	7.72	3.10
	22	14.04	2.49	13.65	2.55	11.72	2.83	10.56	2.99	9.93	3.02	7.40	3.12
	24	14.55	2.51	13.96	2.57	11.01	2.86	9.24	3.04	8.74	3.06	6.74	3.15
1.6 + 2.5 + 3.5 + 4.2	16	14.72	2.28	14.42	2.34	12.91	2.63	12.00	2.80	11.41	2.84	9.06	3.01
	18	14.11	2.37	13.80	2.43	12.23	2.71	11.29	2.87	10.75	2.91	8.56	3.07
	20	13.90	2.44	13.53	2.49	11.70	2.77	10.60	2.93	10.08	2.96	8.01	3.08
	21	13.92	2.46	13.51	2.51	11.45	2.71	10.21	2.83	9.71	2.89	7.72	3.09
	22	14.04	2.48	13.65	2.54	11.72	2.82	10.56	2.98	9.93	3.01	7.40	3.11
	24	14.55	2.51	13.96	2.56	11.01	2.85	9.24	3.03	8.74	3.05	6.74	3.14
1.6 + 2.5 + 3.5 + 5.0	16	14.72	2.24	14.42	2.30	12.91	2.58	12.00	2.75	11.41	2.79	9.06	2.96
	18	14.11	2.33	13.80	2.39	12.23	2.66	11.29	2.82	10.75	2.86	8.56	3.01
	20	13.90	2.40	13.53	2.45	11.70	2.72	10.60	2.88	10.08	2.91	8.01	3.03
	21	13.92	2.42	13.51	2.46	11.45	2.66	10.21	2.79	9.71	2.84	7.72	3.04
	22	14.04	2.44	13.65	2.50	11.72	2.77	10.56	2.93	9.93	2.96	7.40	3.05
	24	14.55	2.46	13.96	2.52	11.01	2.81	9.24	2.98	8.74	3.00	6.74	3.08
1.6 + 2.5 + 3.5 + 6.0	16	14.72	2.24	14.42	2.30	12.91	2.58	12.00	2.75	11.41	2.79	9.06	2.96
	18	14.11	2.33	13.80	2.39	12.23	2.66	11.29	2.82	10.75	2.86	8.56	3.01
	20	13.90	2.40	13.53	2.45	11.70	2.72	10.60	2.88	10.08	2.91	8.01	3.03
	21	13.92	2.42	13.51	2.46	11.45	2.66	10.21	2.79	9.71	2.84	7.72	3.04
	22	14.04	2.44	13.65	2.50	11.72	2.77	10.56	2.93	9.93	2.96	7.40	3.05
	24	14.55	2.46	13.96	2.52	11.01	2.81	9.24	2.98	8.74	3.00	6.74	3.08
1.6 + 2.5 + 3.5 + 7.1	16	14.72	2.23	14.42	2.29	12.91	2.57	12.00	2.74	11.41	2.78	9.06	2.95
	18	14.11	2.33	13.80	2.38	12.23	2.65	11.29	2.81	10.75	2.85	8.56	3.00
	20	13.90	2.39	13.53	2.44	11.70	2.71	10.60	2.87	10.08	2.90	8.01	3.02
	21	13.92	2.41	13.51	2.45	11.45	2.66	10.21	2.78	9.71	2.83	7.72	3.03
	22	14.04	2.43	13.65	2.49	11.72	2.76	10.56	2.92	9.93	2.95	7.40	3.04
	24	14.55	2.45	13.96	2.51	11.01	2.80	9.24	2.97	8.74	2.99	6.74	3.07



Combination (Capacity)	Indoor Air Temp. °C DB	Outdoor Air Temp. °C									
		0/-1		-5/-6		-7/-8		-10/-11		-15/-	
		Total Q	Input Power	Total Q	Input Power	Total Q	Input Power	Total Q	Input Power	Total Q	Input Power
1.6 + 2.5 + 2.5 + 7.1	16	8.80	2.93	8.13	2.83	7.87	2.80	7.56	2.70	7.05	2.54
	18	8.33	2.98	7.76	2.86	7.53	2.81	7.41	2.73	7.22	2.59
	20	7.86	2.99	7.46	2.87	7.31	2.83	7.28	2.76	7.24	2.66
	21	7.53	3.00	7.07	2.89	6.89	2.84	7.00	2.78	7.19	2.69
	22	7.36	3.02	7.25	2.90	7.21	2.85	7.17	2.80	7.10	2.72
	24	6.85	3.05	7.11	2.94	7.22	2.89	7.07	2.85	6.82	2.79
1.6 + 2.5 + 3.5 + 3.5	16	8.80	2.98	8.13	2.88	7.87	2.84	7.56	2.75	7.05	2.58
	18	8.33	3.03	7.76	2.91	7.53	2.86	7.41	2.77	7.22	2.63
	20	7.86	3.04	7.46	2.92	7.31	2.88	7.28	2.81	7.24	2.70
	21	7.53	3.06	7.07	2.94	6.89	2.89	7.00	2.83	7.19	2.74
	22	7.36	3.07	7.25	2.95	7.21	2.90	7.17	2.85	7.10	2.77
	24	6.85	3.10	7.11	2.99	7.22	2.94	7.07	2.90	6.82	2.84
1.6 + 2.5 + 3.5 + 4.2	16	8.80	2.97	8.13	2.87	7.87	2.84	7.56	2.74	7.05	2.57
	18	8.33	3.02	7.76	2.90	7.53	2.85	7.41	2.76	7.22	2.62
	20	7.86	3.03	7.46	2.91	7.31	2.87	7.28	2.80	7.24	2.70
	21	7.53	3.05	7.07	2.93	6.89	2.88	7.00	2.82	7.19	2.73
	22	7.36	3.06	7.25	2.94	7.21	2.89	7.17	2.84	7.10	2.76
	24	6.85	3.09	7.11	2.98	7.22	2.93	7.07	2.89	6.82	2.83
1.6 + 2.5 + 3.5 + 5.0	16	8.80	2.92	8.13	2.82	7.87	2.79	7.56	2.69	7.05	2.53
	18	8.33	2.97	7.76	2.85	7.53	2.80	7.41	2.72	7.22	2.58
	20	7.86	2.98	7.46	2.86	7.31	2.82	7.28	2.75	7.24	2.65
	21	7.53	2.99	7.07	2.88	6.89	2.83	7.00	2.77	7.19	2.68
	22	7.36	3.01	7.25	2.89	7.21	2.84	7.17	2.79	7.10	2.71
	24	6.85	3.04	7.11	2.93	7.22	2.88	7.07	2.84	6.82	2.78
1.6 + 2.5 + 3.5 + 6.0	16	8.80	2.92	8.13	2.82	7.87	2.79	7.56	2.69	7.05	2.53
	18	8.33	2.97	7.76	2.85	7.53	2.80	7.41	2.72	7.22	2.58
	20	7.86	2.98	7.46	2.86	7.31	2.82	7.28	2.75	7.24	2.65
	21	7.53	2.99	7.07	2.88	6.89	2.83	7.00	2.77	7.19	2.68
	22	7.36	3.01	7.25	2.89	7.21	2.84	7.17	2.79	7.10	2.71
	24	6.85	3.04	7.11	2.93	7.22	2.88	7.07	2.84	6.82	2.78
1.6 + 2.5 + 3.5 + 7.1	16	8.80	2.91	8.13	2.81	7.87	2.78	7.56	2.68	7.05	2.52
	18	8.33	2.96	7.76	2.84	7.53	2.79	7.41	2.71	7.22	2.57
	20	7.86	2.97	7.46	2.85	7.31	2.81	7.28	2.75	7.24	2.64
	21	7.53	2.98	7.07	2.87	6.89	2.82	7.00	2.76	7.19	2.67
	22	7.36	3.00	7.25	2.88	7.21	2.83	7.17	2.78	7.10	2.70
	24	6.85	3.03	7.11	2.92	7.22	2.87	7.07	2.83	6.82	2.77

Combination (Capacity)	Indoor Air Temp. °C DB	Outdoor Air Temp. °C											
		16/15		15/14		10/9		7/6		6/5		2/1	
		Total Q	Input Power	Total Q	Input Power	Total Q	Input Power	Total Q	Input Power	Total Q	Input Power	Total Q	Input Power
1.6 + 2.5 + 4.2 + 4.2	16	14.72	2.27	14.42	2.33	12.91	2.62	12.00	2.79	11.41	2.83	9.06	3.00
	18	14.11	2.37	13.80	2.42	12.23	2.70	11.29	2.86	10.75	2.90	8.56	3.05
	20	13.90	2.43	13.53	2.48	11.70	2.76	10.60	2.92	10.08	2.95	8.01	3.07
	21	13.92	2.46	13.51	2.50	11.45	2.70	10.21	2.82	9.71	2.88	7.72	3.08
	22	14.04	2.47	13.65	2.53	11.72	2.81	10.56	2.97	9.93	3.00	7.40	3.10
	24	14.55	2.50	13.96	2.56	11.01	2.85	9.24	3.02	8.74	3.04	6.74	3.13
1.6 + 2.5 + 4.2 + 5.0	16	14.72	2.23	14.42	2.29	12.91	2.57	12.00	2.74	11.41	2.78	9.06	2.95
	18	14.11	2.33	13.80	2.38	12.23	2.65	11.29	2.81	10.75	2.85	8.56	3.00
	20	13.90	2.39	13.53	2.44	11.70	2.71	10.60	2.87	10.08	2.90	8.01	3.02
	21	13.92	2.41	13.51	2.45	11.45	2.66	10.21	2.78	9.71	2.83	7.72	3.03
	22	14.04	2.43	13.65	2.49	11.72	2.76	10.56	2.92	9.93	2.95	7.40	3.04
	24	14.55	2.45	13.96	2.51	11.01	2.80	9.24	2.97	8.74	2.99	6.74	3.07
1.6 + 2.5 + 4.2 + 6.0	16	14.72	2.23	14.42	2.29	12.91	2.57	12.00	2.74	11.41	2.78	9.06	2.95
	18	14.11	2.33	13.80	2.38	12.23	2.65	11.29	2.81	10.75	2.85	8.56	3.00
	20	13.90	2.39	13.53	2.44	11.70	2.71	10.60	2.87	10.08	2.90	8.01	3.02
	21	13.92	2.41	13.51	2.45	11.45	2.66	10.21	2.78	9.71	2.83	7.72	3.03
	22	14.04	2.43	13.65	2.49	11.72	2.76	10.56	2.92	9.93	2.95	7.40	3.04
	24	14.55	2.45	13.96	2.51	11.01	2.80	9.24	2.97	8.74	2.99	6.74	3.07
1.6 + 2.5 + 5.0 + 5.0	16	14.72	2.26	14.42	2.31	12.91	2.60	12.00	2.77	11.41	2.81	9.06	2.98
	18	14.11	2.35	13.80	2.40	12.23	2.68	11.29	2.84	10.75	2.88	8.56	3.03
	20	13.90	2.41	13.53	2.47	11.70	2.74	10.60	2.90	10.08	2.93	8.01	3.05
	21	13.92	2.44	13.51	2.48	11.45	2.68	10.21	2.80	9.71	2.86	7.72	3.06
	22	14.04	2.46	13.65	2.51	11.72	2.79	10.56	2.95	9.93	2.98	7.40	3.07
	24	14.55	2.48	13.96	2.54	11.01	2.83	9.24	3.00	8.74	3.02	6.74	3.11
1.6 + 3.5 + 3.5 + 3.5	16	14.72	2.26	14.42	2.32	12.91	2.61	12.00	2.78	11.41	2.82	9.06	2.99
	18	14.11	2.36	13.80	2.41	12.23	2.69	11.29	2.85	10.75	2.89	8.56	3.04
	20	13.90	2.42	13.53	2.48	11.70	2.75	10.60	2.91	10.08	2.94	8.01	3.06
	21	13.92	2.45	13.51	2.49	11.45	2.69	10.21	2.81	9.71	2.87	7.72	3.07
	22	14.04	2.47	13.65	2.52	11.72	2.80	10.56	2.96	9.93	2.99	7.40	3.08
	24	14.55	2.49	13.96	2.55	11.01	2.84	9.24	3.01	8.74	3.03	6.74	3.12
1.6 + 3.5 + 3.5 + 4.2	16	14.72	2.26	14.42	2.31	12.91	2.60	12.00	2.77	11.41	2.81	9.06	2.98
	18	14.11	2.35	13.80	2.40	12.23	2.68	11.29	2.84	10.75	2.88	8.56	3.03
	20	13.90	2.41	13.53	2.47	11.70	2.74	10.60	2.90	10.08	2.93	8.01	3.05
	21	13.92	2.44	13.51	2.48	11.45	2.68	10.21	2.80	9.71	2.86	7.72	3.06
	22	14.04	2.46	13.65	2.51	11.72	2.79	10.56	2.95	9.93	2.98	7.40	3.07
	24	14.55	2.48	13.96	2.54	11.01	2.83	9.24	3.00	8.74	3.02	6.74	3.11

Combination (Capacity)	Indoor Air Temp. °C DB	Outdoor Air Temp. °C									
		0/-1		-5/-6		-7/-8		-10/-11		-15/-	
		Total Q	Input Power	Total Q	Input Power	Total Q	Input Power	Total Q	Input Power	Total Q	Input Power
1.6 + 2.5 + 4.2 + 4.2	16	8.80	2.96	8.13	2.86	7.87	2.83	7.56	2.73	7.05	2.56
	18	8.33	3.01	7.76	2.89	7.53	2.84	7.41	2.75	7.22	2.61
	20	7.86	3.02	7.46	2.90	7.31	2.86	7.28	2.79	7.24	2.69
	21	7.53	3.03	7.07	2.92	6.89	2.87	7.00	2.81	7.19	2.72
	22	7.36	3.05	7.25	2.93	7.21	2.88	7.17	2.83	7.10	2.75
	24	6.85	3.08	7.11	2.97	7.22	2.92	7.07	2.88	6.82	2.82
1.6 + 2.5 + 4.2 + 5.0	16	8.80	2.91	8.13	2.81	7.87	2.78	7.56	2.68	7.05	2.52
	18	8.33	2.96	7.76	2.84	7.53	2.79	7.41	2.71	7.22	2.57
	20	7.86	2.97	7.46	2.85	7.31	2.81	7.28	2.75	7.24	2.64
	21	7.53	2.98	7.07	2.87	6.89	2.82	7.00	2.76	7.19	2.67
	22	7.36	3.00	7.25	2.88	7.21	2.83	7.17	2.78	7.10	2.70
	24	6.85	3.03	7.11	2.92	7.22	2.87	7.07	2.83	6.82	2.77
1.6 + 2.5 + 4.2 + 6.0	16	8.80	2.91	8.13	2.81	7.87	2.78	7.56	2.68	7.05	2.52
	18	8.33	2.96	7.76	2.84	7.53	2.79	7.41	2.71	7.22	2.57
	20	7.86	2.97	7.46	2.85	7.31	2.81	7.28	2.75	7.24	2.64
	21	7.53	2.98	7.07	2.87	6.89	2.82	7.00	2.76	7.19	2.67
	22	7.36	3.00	7.25	2.88	7.21	2.83	7.17	2.78	7.10	2.70
	24	6.85	3.03	7.11	2.92	7.22	2.87	7.07	2.83	6.82	2.77
1.6 + 2.5 + 5.0 + 5.0	16	8.80	2.94	8.13	2.84	7.87	2.81	7.56	2.71	7.05	2.55
	18	8.33	2.99	7.76	2.87	7.53	2.82	7.41	2.74	7.22	2.60
	20	7.86	3.00	7.46	2.88	7.31	2.84	7.28	2.77	7.24	2.67
	21	7.53	3.01	7.07	2.90	6.89	2.85	7.00	2.79	7.19	2.70
	22	7.36	3.03	7.25	2.91	7.21	2.86	7.17	2.81	7.10	2.73
	24	6.85	3.06	7.11	2.95	7.22	2.90	7.07	2.86	6.82	2.80
1.6 + 3.5 + 3.5 + 3.5	16	8.80	2.95	8.13	2.85	7.87	2.82	7.56	2.72	7.05	2.56
	18	8.33	3.00	7.76	2.88	7.53	2.83	7.41	2.75	7.22	2.61
	20	7.86	3.01	7.46	2.89	7.31	2.85	7.28	2.78	7.24	2.68
	21	7.53	3.02	7.07	2.91	6.89	2.86	7.00	2.80	7.19	2.71
	22	7.36	3.04	7.25	2.92	7.21	2.87	7.17	2.82	7.10	2.74
	24	6.85	3.07	7.11	2.96	7.22	2.91	7.07	2.87	6.82	2.81
1.6 + 3.5 + 3.5 + 4.2	16	8.80	2.94	8.13	2.84	7.87	2.81	7.56	2.71	7.05	2.55
	18	8.33	2.99	7.76	2.87	7.53	2.82	7.41	2.74	7.22	2.60
	20	7.86	3.00	7.46	2.88	7.31	2.84	7.28	2.77	7.24	2.67
	21	7.53	3.01	7.07	2.90	6.89	2.85	7.00	2.79	7.19	2.70
	22	7.36	3.03	7.25	2.91	7.21	2.86	7.17	2.81	7.10	2.73
	24	6.85	3.06	7.11	2.95	7.22	2.90	7.07	2.86	6.82	2.80

Combination (Capacity)	Indoor Air Temp. °C DB	Outdoor Air Temp. °C											
		16/15		15/14		10/9		7/6		6/5		2/1	
		Total Q	Input Power	Total Q	Input Power	Total Q	Input Power	Total Q	Input Power	Total Q	Input Power	Total Q	Input Power
1.6 + 3.5 + 3.5 + 5.0	16	14.72	2.23	14.42	2.28	12.91	2.56	12.00	2.73	11.41	2.77	9.06	2.93
	18	14.11	2.32	13.80	2.37	12.23	2.64	11.29	2.80	10.75	2.84	8.56	2.99
	20	13.90	2.38	13.53	2.43	11.70	2.70	10.60	2.86	10.08	2.89	8.01	3.01
	21	13.92	2.41	13.51	2.45	11.45	2.65	10.21	2.77	9.71	2.82	7.72	3.02
	22	14.04	2.42	13.65	2.48	11.72	2.75	10.56	2.91	9.93	2.94	7.40	3.03
	24	14.55	2.45	13.96	2.50	11.01	2.79	9.24	2.96	8.74	2.98	6.74	3.06
1.6 + 3.5 + 3.5 + 6.0	16	14.72	2.23	14.42	2.28	12.91	2.56	12.00	2.73	11.41	2.77	9.06	2.93
	18	14.11	2.32	13.80	2.37	12.23	2.64	11.29	2.80	10.75	2.84	8.56	2.99
	20	13.90	2.38	13.53	2.43	11.70	2.70	10.60	2.86	10.08	2.89	8.01	3.01
	21	13.92	2.41	13.51	2.45	11.45	2.65	10.21	2.77	9.71	2.82	7.72	3.02
	22	14.04	2.42	13.65	2.48	11.72	2.75	10.56	2.91	9.93	2.94	7.40	3.03
	24	14.55	2.45	13.96	2.50	11.01	2.79	9.24	2.96	8.74	2.98	6.74	3.06
1.6 + 3.5 + 4.2 + 4.2	16	14.72	2.25	14.42	2.31	12.91	2.59	12.00	2.76	11.41	2.80	9.06	2.97
	18	14.11	2.34	13.80	2.40	12.23	2.67	11.29	2.83	10.75	2.87	8.56	3.02
	20	13.90	2.40	13.53	2.46	11.70	2.73	10.60	2.89	10.08	2.92	8.01	3.04
	21	13.92	2.43	13.51	2.47	11.45	2.67	10.21	2.80	9.71	2.85	7.72	3.05
	22	14.04	2.45	13.65	2.50	11.72	2.78	10.56	2.94	9.93	2.97	7.40	3.06
	24	14.55	2.47	13.96	2.53	11.01	2.82	9.24	2.99	8.74	3.01	6.74	3.09
1.6 + 3.5 + 4.2 + 5.0	16	14.72	2.22	14.42	2.27	12.91	2.55	12.00	2.72	11.41	2.76	9.06	2.92
	18	14.11	2.31	13.80	2.36	12.23	2.63	11.29	2.79	10.75	2.83	8.56	2.98
	20	13.90	2.37	13.53	2.42	11.70	2.69	10.60	2.85	10.08	2.88	8.01	2.99
	21	13.92	2.40	13.51	2.44	11.45	2.64	10.21	2.76	9.71	2.81	7.72	3.01
	22	14.04	2.42	13.65	2.47	11.72	2.74	10.56	2.90	9.93	2.93	7.40	3.02
	24	14.55	2.44	13.96	2.49	11.01	2.78	9.24	2.95	8.74	2.97	6.74	3.05
1.6 + 4.2 + 4.2 + 4.2	16	14.72	2.24	14.42	2.30	12.91	2.58	12.00	2.75	11.41	2.79	9.06	2.96
	18	14.11	2.33	13.80	2.39	12.23	2.66	11.29	2.82	10.75	2.86	8.56	3.01
	20	13.90	2.40	13.53	2.45	11.70	2.72	10.60	2.88	10.08	2.91	8.01	3.03
	21	13.92	2.42	13.51	2.46	11.45	2.66	10.21	2.79	9.71	2.84	7.72	3.04
	22	14.04	2.44	13.65	2.50	11.72	2.77	10.56	2.93	9.93	2.96	7.40	3.05
	24	14.55	2.46	13.96	2.52	11.01	2.81	9.24	2.98	8.74	3.00	6.74	3.08
2.0 + 2.0 + 2.0 + 2.0	16	14.72	2.33	14.42	2.39	12.91	2.68	12.00	2.86	11.41	2.90	9.06	3.07
	18	14.11	2.42	13.80	2.48	12.23	2.76	11.29	2.93	10.75	2.97	8.56	3.13
	20	13.90	2.49	13.53	2.54	11.70	2.82	10.60	2.99	10.08	3.02	8.01	3.14
	21	13.92	2.52	13.51	2.56	11.45	2.77	10.21	2.89	9.71	2.94	7.72	3.16
	22	14.04	2.53	13.65	2.59	11.72	2.87	10.56	3.05	9.93	3.07	7.40	3.17
	24	14.55	2.56	13.96	2.62	11.01	2.91	9.24	3.09	8.74	3.11	6.74	3.20

Combination (Capacity)	Indoor Air Temp. °C DB	Outdoor Air Temp. °C									
		0/-1		-5/-6		-7/-8		-10/-11		-15/-	
		Total Q	Input Power	Total Q	Input Power	Total Q	Input Power	Total Q	Input Power	Total Q	Input Power
1.6 + 3.5 + 3.5 + 5.0	16	8.80	2.90	8.13	2.80	7.87	2.77	7.56	2.67	7.05	2.51
	18	8.33	2.95	7.76	2.83	7.53	2.78	7.41	2.70	7.22	2.56
	20	7.86	2.96	7.46	2.84	7.31	2.80	7.28	2.74	7.24	2.63
	21	7.53	2.97	7.07	2.86	6.89	2.81	7.00	2.76	7.19	2.66
	22	7.36	2.99	7.25	2.87	7.21	2.82	7.17	2.78	7.10	2.69
	24	6.85	3.02	7.11	2.91	7.22	2.86	7.07	2.82	6.82	2.76
1.6 + 3.5 + 3.5 + 6.0	16	8.80	2.90	8.13	2.80	7.87	2.77	7.56	2.67	7.05	2.51
	18	8.33	2.95	7.76	2.83	7.53	2.78	7.41	2.70	7.22	2.56
	20	7.86	2.96	7.46	2.84	7.31	2.80	7.28	2.74	7.24	2.63
	21	7.53	2.97	7.07	2.86	6.89	2.81	7.00	2.76	7.19	2.66
	22	7.36	2.99	7.25	2.87	7.21	2.82	7.17	2.78	7.10	2.69
	24	6.85	3.02	7.11	2.91	7.22	2.86	7.07	2.82	6.82	2.76
1.6 + 3.5 + 4.2 + 4.2	16	8.80	2.93	8.13	2.83	7.87	2.80	7.56	2.70	7.05	2.54
	18	8.33	2.98	7.76	2.86	7.53	2.81	7.41	2.73	7.22	2.59
	20	7.86	2.99	7.46	2.87	7.31	2.83	7.28	2.76	7.24	2.66
	21	7.53	3.00	7.07	2.89	6.89	2.84	7.00	2.78	7.19	2.69
	22	7.36	3.02	7.25	2.90	7.21	2.85	7.17	2.80	7.10	2.72
	24	6.85	3.05	7.11	2.94	7.22	2.89	7.07	2.85	6.82	2.79
1.6 + 3.5 + 4.2 + 5.0	16	8.80	2.89	8.13	2.79	7.87	2.76	7.56	2.66	7.05	2.50
	18	8.33	2.93	7.76	2.82	7.53	2.77	7.41	2.69	7.22	2.55
	20	7.86	2.95	7.46	2.83	7.31	2.79	7.28	2.73	7.24	2.62
	21	7.53	2.96	7.07	2.85	6.89	2.80	7.00	2.75	7.19	2.65
	22	7.36	2.98	7.25	2.86	7.21	2.81	7.17	2.77	7.10	2.68
	24	6.85	3.01	7.11	2.89	7.22	2.85	7.07	2.81	6.82	2.75
1.6 + 4.2 + 4.2 + 4.2	16	8.80	2.92	8.13	2.82	7.87	2.79	7.56	2.69	7.05	2.53
	18	8.33	2.97	7.76	2.85	7.53	2.80	7.41	2.72	7.22	2.58
	20	7.86	2.98	7.46	2.86	7.31	2.82	7.28	2.75	7.24	2.65
	21	7.53	2.99	7.07	2.88	6.89	2.83	7.00	2.77	7.19	2.68
	22	7.36	3.01	7.25	2.89	7.21	2.84	7.17	2.79	7.10	2.71
	24	6.85	3.04	7.11	2.93	7.22	2.88	7.07	2.84	6.82	2.78
2.0 + 2.0 + 2.0 + 2.0	16	8.80	3.03	8.13	2.93	7.87	2.89	7.56	2.79	7.05	2.63
	18	8.33	3.08	7.76	2.96	7.53	2.91	7.41	2.82	7.22	2.68
	20	7.86	3.09	7.46	2.97	7.31	2.93	7.28	2.86	7.24	2.75
	21	7.53	3.11	7.07	2.99	6.89	2.94	7.00	2.88	7.19	2.78
	22	7.36	3.12	7.25	3.00	7.21	2.95	7.17	2.90	7.10	2.81
	24	6.85	3.15	7.11	3.04	7.22	2.99	7.07	2.95	6.82	2.88

Combination (Capacity)	Indoor Air Temp. °C DB	Outdoor Air Temp. °C											
		16/15		15/14		10/9		7/6		6/5		2/1	
		Total Q	Input Power	Total Q	Input Power	Total Q	Input Power	Total Q	Input Power	Total Q	Input Power	Total Q	Input Power
2.0 + 2.0 + 2.0 + 2.5	16	14.72	2.33	14.42	2.39	12.91	2.68	12.00	2.86	11.41	2.90	9.06	3.07
	18	14.11	2.42	13.80	2.48	12.23	2.76	11.29	2.93	10.75	2.97	8.56	3.13
	20	13.90	2.49	13.53	2.54	11.70	2.82	10.60	2.99	10.08	3.02	8.01	3.14
	21	13.92	2.52	13.51	2.56	11.45	2.77	10.21	2.89	9.71	2.94	7.72	3.16
	22	14.04	2.53	13.65	2.59	11.72	2.87	10.56	3.05	9.93	3.07	7.40	3.17
	24	14.55	2.56	13.96	2.62	11.01	2.91	9.24	3.09	8.74	3.11	6.74	3.20
2.0 + 2.0 + 2.0 + 3.5	16	14.72	2.30	14.42	2.36	12.91	2.65	12.00	2.83	11.41	2.87	9.06	3.04
	18	14.11	2.40	13.80	2.45	12.23	2.73	11.29	2.90	10.75	2.94	8.56	3.10
	20	13.90	2.46	13.53	2.52	11.70	2.79	10.60	2.96	10.08	2.99	8.01	3.11
	21	13.92	2.49	13.51	2.53	11.45	2.74	10.21	2.86	9.71	2.92	7.72	3.12
	22	14.04	2.51	13.65	2.56	11.72	2.85	10.56	3.01	9.93	3.04	7.40	3.14
	24	14.55	2.53	13.96	2.59	11.01	2.88	9.24	3.06	8.74	3.08	6.74	3.17
2.0 + 2.0 + 2.0 + 4.2	16	14.72	2.30	14.42	2.35	12.91	2.64	12.00	2.82	11.41	2.86	9.06	3.03
	18	14.11	2.39	13.80	2.45	12.23	2.72	11.29	2.89	10.75	2.93	8.56	3.09
	20	13.90	2.45	13.53	2.51	11.70	2.78	10.60	2.95	10.08	2.98	8.01	3.10
	21	13.92	2.48	13.51	2.52	11.45	2.73	10.21	2.85	9.71	2.91	7.72	3.11
	22	14.04	2.50	13.65	2.56	11.72	2.84	10.56	3.00	9.93	3.03	7.40	3.13
	24	14.55	2.52	13.96	2.58	11.01	2.87	9.24	3.05	8.74	3.07	6.74	3.16
2.0 + 2.0 + 2.0 + 5.0	16	14.72	2.25	14.42	2.31	12.91	2.59	12.00	2.76	11.41	2.80	9.06	2.97
	18	14.11	2.34	13.80	2.40	12.23	2.67	11.29	2.83	10.75	2.87	8.56	3.02
	20	13.90	2.40	13.53	2.46	11.70	2.73	10.60	2.89	10.08	2.92	8.01	3.04
	21	13.92	2.43	13.51	2.47	11.45	2.67	10.21	2.80	9.71	2.85	7.72	3.05
	22	14.04	2.45	13.65	2.50	11.72	2.78	10.56	2.94	9.93	2.97	7.40	3.06
	24	14.55	2.47	13.96	2.53	11.01	2.82	9.24	2.99	8.74	3.01	6.74	3.09
2.0 + 2.0 + 2.0 + 6.0	16	14.72	2.25	14.42	2.31	12.91	2.59	12.00	2.76	11.41	2.80	9.06	2.97
	18	14.11	2.34	13.80	2.40	12.23	2.67	11.29	2.83	10.75	2.87	8.56	3.02
	20	13.90	2.40	13.53	2.46	11.70	2.73	10.60	2.89	10.08	2.92	8.01	3.04
	21	13.92	2.43	13.51	2.47	11.45	2.67	10.21	2.80	9.71	2.85	7.72	3.05
	22	14.04	2.45	13.65	2.50	11.72	2.78	10.56	2.94	9.93	2.97	7.40	3.06
	24	14.55	2.47	13.96	2.53	11.01	2.82	9.24	2.99	8.74	3.01	6.74	3.09
2.0 + 2.0 + 2.0 + 7.1	16	14.72	2.24	14.42	2.30	12.91	2.58	12.00	2.75	11.41	2.79	9.06	2.96
	18	14.11	2.33	13.80	2.39	12.23	2.66	11.29	2.82	10.75	2.86	8.56	3.01
	20	13.90	2.40	13.53	2.45	11.70	2.72	10.60	2.88	10.08	2.91	8.01	3.03
	21	13.92	2.42	13.51	2.46	11.45	2.66	10.21	2.79	9.71	2.84	7.72	3.04
	22	14.04	2.44	13.65	2.50	11.72	2.77	10.56	2.93	9.93	2.96	7.40	3.05
	24	14.55	2.46	13.96	2.52	11.01	2.81	9.24	2.98	8.74	3.00	6.74	3.08

Combination (Capacity)	Indoor Air Temp. °C DB	Outdoor Air Temp. °C									
		0/-1		-5/-6		-7/-8		-10/-11		-15/-	
		Total Q	Input Power	Total Q	Input Power	Total Q	Input Power	Total Q	Input Power	Total Q	Input Power
2.0 + 2.0 + 2.0 + 2.5	16	8.80	3.03	8.13	2.93	7.87	2.89	7.56	2.79	7.05	2.63
	18	8.33	3.08	7.76	2.96	7.53	2.91	7.41	2.82	7.22	2.68
	20	7.86	3.09	7.46	2.97	7.31	2.93	7.28	2.86	7.24	2.75
	21	7.53	3.11	7.07	2.99	6.89	2.94	7.00	2.88	7.19	2.78
	22	7.36	3.12	7.25	3.00	7.21	2.95	7.17	2.90	7.10	2.81
	24	6.85	3.15	7.11	3.04	7.22	2.99	7.07	2.95	6.82	2.88
2.0 + 2.0 + 2.0 + 3.5	16	8.80	3.00	8.13	2.90	7.87	2.86	7.56	2.77	7.05	2.60
	18	8.33	3.05	7.76	2.93	7.53	2.88	7.41	2.79	7.22	2.65
	20	7.86	3.06	7.46	2.94	7.31	2.90	7.28	2.83	7.24	2.72
	21	7.53	3.08	7.07	2.96	6.89	2.91	7.00	2.85	7.19	2.75
	22	7.36	3.09	7.25	2.97	7.21	2.92	7.17	2.87	7.10	2.79
	24	6.85	3.12	7.11	3.01	7.22	2.96	7.07	2.92	6.82	2.86
2.0 + 2.0 + 2.0 + 4.2	16	8.80	2.99	8.13	2.89	7.87	2.85	7.56	2.76	7.05	2.59
	18	8.33	3.04	7.76	2.92	7.53	2.87	7.41	2.78	7.22	2.64
	20	7.86	3.05	7.46	2.93	7.31	2.89	7.28	2.82	7.24	2.71
	21	7.53	3.07	7.07	2.95	6.89	2.90	7.00	2.84	7.19	2.75
	22	7.36	3.08	7.25	2.96	7.21	2.91	7.17	2.86	7.10	2.78
	24	6.85	3.11	7.11	3.00	7.22	2.95	7.07	2.91	6.82	2.85
2.0 + 2.0 + 2.0 + 5.0	16	8.80	2.93	8.13	2.83	7.87	2.80	7.56	2.70	7.05	2.54
	18	8.33	2.98	7.76	2.86	7.53	2.81	7.41	2.73	7.22	2.59
	20	7.86	2.99	7.46	2.87	7.31	2.83	7.28	2.76	7.24	2.66
	21	7.53	3.00	7.07	2.89	6.89	2.84	7.00	2.78	7.19	2.69
	22	7.36	3.02	7.25	2.90	7.21	2.85	7.17	2.80	7.10	2.72
	24	6.85	3.05	7.11	2.94	7.22	2.89	7.07	2.85	6.82	2.79
2.0 + 2.0 + 2.0 + 6.0	16	8.80	2.93	8.13	2.83	7.87	2.80	7.56	2.70	7.05	2.54
	18	8.33	2.98	7.76	2.86	7.53	2.81	7.41	2.73	7.22	2.59
	20	7.86	2.99	7.46	2.87	7.31	2.83	7.28	2.76	7.24	2.66
	21	7.53	3.00	7.07	2.89	6.89	2.84	7.00	2.78	7.19	2.69
	22	7.36	3.02	7.25	2.90	7.21	2.85	7.17	2.80	7.10	2.72
	24	6.85	3.05	7.11	2.94	7.22	2.89	7.07	2.85	6.82	2.79
2.0 + 2.0 + 2.0 + 7.1	16	8.80	2.92	8.13	2.82	7.87	2.79	7.56	2.69	7.05	2.53
	18	8.33	2.97	7.76	2.85	7.53	2.80	7.41	2.72	7.22	2.58
	20	7.86	2.98	7.46	2.86	7.31	2.82	7.28	2.75	7.24	2.65
	21	7.53	2.99	7.07	2.88	6.89	2.83	7.00	2.77	7.19	2.68
	22	7.36	3.01	7.25	2.89	7.21	2.84	7.17	2.79	7.10	2.71
	24	6.85	3.04	7.11	2.93	7.22	2.88	7.07	2.84	6.82	2.78

Combination (Capacity)	Indoor Air Temp. °C DB	Outdoor Air Temp. °C											
		16/15		15/14		10/9		7/6		6/5		2/1	
		Total Q	Input Power	Total Q	Input Power	Total Q	Input Power	Total Q	Input Power	Total Q	Input Power	Total Q	Input Power
2.0 + 2.0 + 2.5 + 2.5	16	14.72	2.33	14.42	2.39	12.91	2.68	12.00	2.86	11.41	2.90	9.06	3.07
	18	14.11	2.42	13.80	2.48	12.23	2.76	11.29	2.93	10.75	2.97	8.56	3.13
	20	13.90	2.49	13.53	2.54	11.70	2.82	10.60	2.99	10.08	3.02	8.01	3.14
	21	13.92	2.52	13.51	2.56	11.45	2.77	10.21	2.89	9.71	2.94	7.72	3.16
	22	14.04	2.53	13.65	2.59	11.72	2.87	10.56	3.05	9.93	3.07	7.40	3.17
	24	14.55	2.56	13.96	2.62	11.01	2.91	9.24	3.09	8.74	3.11	6.74	3.20
2.0 + 2.0 + 2.5 + 3.5	16	14.72	2.30	14.42	2.36	12.91	2.65	12.00	2.83	11.41	2.87	9.06	3.04
	18	14.11	2.40	13.80	2.45	12.23	2.73	11.29	2.90	10.75	2.94	8.56	3.10
	20	13.90	2.46	13.53	2.52	11.70	2.79	10.60	2.96	10.08	2.99	8.01	3.11
	21	13.92	2.49	13.51	2.53	11.45	2.74	10.21	2.86	9.71	2.92	7.72	3.12
	22	14.04	2.51	13.65	2.56	11.72	2.85	10.56	3.01	9.93	3.04	7.40	3.14
	24	14.55	2.53	13.96	2.59	11.01	2.88	9.24	3.06	8.74	3.08	6.74	3.17
2.0 + 2.0 + 2.5 + 4.2	16	14.72	2.30	14.42	2.35	12.91	2.64	12.00	2.82	11.41	2.86	9.06	3.03
	18	14.11	2.39	13.80	2.45	12.23	2.72	11.29	2.89	10.75	2.93	8.56	3.09
	20	13.90	2.45	13.53	2.51	11.70	2.78	10.60	2.95	10.08	2.98	8.01	3.10
	21	13.92	2.48	13.51	2.52	11.45	2.73	10.21	2.85	9.71	2.91	7.72	3.11
	22	14.04	2.50	13.65	2.56	11.72	2.84	10.56	3.00	9.93	3.03	7.40	3.13
	24	14.55	2.52	13.96	2.58	11.01	2.87	9.24	3.05	8.74	3.07	6.74	3.16
2.0 + 2.0 + 2.5 + 5.0	16	14.72	2.25	14.42	2.31	12.91	2.59	12.00	2.76	11.41	2.80	9.06	2.97
	18	14.11	2.34	13.80	2.40	12.23	2.67	11.29	2.83	10.75	2.87	8.56	3.02
	20	13.90	2.40	13.53	2.46	11.70	2.73	10.60	2.89	10.08	2.92	8.01	3.04
	21	13.92	2.43	13.51	2.47	11.45	2.67	10.21	2.80	9.71	2.85	7.72	3.05
	22	14.04	2.45	13.65	2.50	11.72	2.78	10.56	2.94	9.93	2.97	7.40	3.06
	24	14.55	2.47	13.96	2.53	11.01	2.82	9.24	2.99	8.74	3.01	6.74	3.09
2.0 + 2.0 + 2.5 + 6.0	16	14.72	2.25	14.42	2.31	12.91	2.59	12.00	2.76	11.41	2.80	9.06	2.97
	18	14.11	2.34	13.80	2.40	12.23	2.67	11.29	2.83	10.75	2.87	8.56	3.02
	20	13.90	2.40	13.53	2.46	11.70	2.73	10.60	2.89	10.08	2.92	8.01	3.04
	21	13.92	2.43	13.51	2.47	11.45	2.67	10.21	2.80	9.71	2.85	7.72	3.05
	22	14.04	2.45	13.65	2.50	11.72	2.78	10.56	2.94	9.93	2.97	7.40	3.06
	24	14.55	2.47	13.96	2.53	11.01	2.82	9.24	2.99	8.74	3.01	6.74	3.09
2.0 + 2.0 + 2.5 + 7.1	16	14.72	2.24	14.42	2.30	12.91	2.58	12.00	2.75	11.41	2.79	9.06	2.96
	18	14.11	2.33	13.80	2.39	12.23	2.66	11.29	2.82	10.75	2.86	8.56	3.01
	20	13.90	2.40	13.53	2.45	11.70	2.72	10.60	2.88	10.08	2.91	8.01	3.03
	21	13.92	2.42	13.51	2.46	11.45	2.66	10.21	2.79	9.71	2.84	7.72	3.04
	22	14.04	2.44	13.65	2.50	11.72	2.77	10.56	2.93	9.93	2.96	7.40	3.05
	24	14.55	2.46	13.96	2.52	11.01	2.81	9.24	2.98	8.74	3.00	6.74	3.08



Combination (Capacity)	Indoor Air Temp. °C DB	Outdoor Air Temp. °C									
		0/-1		-5/-6		-7/-8		-10/-11		-15/-	
		Total Q	Input Power	Total Q	Input Power	Total Q	Input Power	Total Q	Input Power	Total Q	Input Power
2.0 + 2.0 + 2.5 + 2.5	16	8.80	3.03	8.13	2.93	7.87	2.89	7.56	2.79	7.05	2.63
	18	8.33	3.08	7.76	2.96	7.53	2.91	7.41	2.82	7.22	2.68
	20	7.86	3.09	7.46	2.97	7.31	2.93	7.28	2.86	7.24	2.75
	21	7.53	3.11	7.07	2.99	6.89	2.94	7.00	2.88	7.19	2.78
	22	7.36	3.12	7.25	3.00	7.21	2.95	7.17	2.90	7.10	2.81
	24	6.85	3.15	7.11	3.04	7.22	2.99	7.07	2.95	6.82	2.88
2.0 + 2.0 + 2.5 + 3.5	16	8.80	3.00	8.13	2.90	7.87	2.86	7.56	2.77	7.05	2.60
	18	8.33	3.05	7.76	2.93	7.53	2.88	7.41	2.79	7.22	2.65
	20	7.86	3.06	7.46	2.94	7.31	2.90	7.28	2.83	7.24	2.72
	21	7.53	3.08	7.07	2.96	6.89	2.91	7.00	2.85	7.19	2.75
	22	7.36	3.09	7.25	2.97	7.21	2.92	7.17	2.87	7.10	2.79
	24	6.85	3.12	7.11	3.01	7.22	2.96	7.07	2.92	6.82	2.86
2.0 + 2.0 + 2.5 + 4.2	16	8.80	2.99	8.13	2.89	7.87	2.85	7.56	2.76	7.05	2.59
	18	8.33	3.04	7.76	2.92	7.53	2.87	7.41	2.78	7.22	2.64
	20	7.86	3.05	7.46	2.93	7.31	2.89	7.28	2.82	7.24	2.71
	21	7.53	3.07	7.07	2.95	6.89	2.90	7.00	2.84	7.19	2.75
	22	7.36	3.08	7.25	2.96	7.21	2.91	7.17	2.86	7.10	2.78
	24	6.85	3.11	7.11	3.00	7.22	2.95	7.07	2.91	6.82	2.85
2.0 + 2.0 + 2.5 + 5.0	16	8.80	2.93	8.13	2.83	7.87	2.80	7.56	2.70	7.05	2.54
	18	8.33	2.98	7.76	2.86	7.53	2.81	7.41	2.73	7.22	2.59
	20	7.86	2.99	7.46	2.87	7.31	2.83	7.28	2.76	7.24	2.66
	21	7.53	3.00	7.07	2.89	6.89	2.84	7.00	2.78	7.19	2.69
	22	7.36	3.02	7.25	2.90	7.21	2.85	7.17	2.80	7.10	2.72
	24	6.85	3.05	7.11	2.94	7.22	2.89	7.07	2.85	6.82	2.79
2.0 + 2.0 + 2.5 + 6.0	16	8.80	2.93	8.13	2.83	7.87	2.80	7.56	2.70	7.05	2.54
	18	8.33	2.98	7.76	2.86	7.53	2.81	7.41	2.73	7.22	2.59
	20	7.86	2.99	7.46	2.87	7.31	2.83	7.28	2.76	7.24	2.66
	21	7.53	3.00	7.07	2.89	6.89	2.84	7.00	2.78	7.19	2.69
	22	7.36	3.02	7.25	2.90	7.21	2.85	7.17	2.80	7.10	2.72
	24	6.85	3.05	7.11	2.94	7.22	2.89	7.07	2.85	6.82	2.79
2.0 + 2.0 + 2.5 + 7.1	16	8.80	2.92	8.13	2.82	7.87	2.79	7.56	2.69	7.05	2.53
	18	8.33	2.97	7.76	2.85	7.53	2.80	7.41	2.72	7.22	2.58
	20	7.86	2.98	7.46	2.86	7.31	2.82	7.28	2.75	7.24	2.65
	21	7.53	2.99	7.07	2.88	6.89	2.83	7.00	2.77	7.19	2.68
	22	7.36	3.01	7.25	2.89	7.21	2.84	7.17	2.79	7.10	2.71
	24	6.85	3.04	7.11	2.93	7.22	2.88	7.07	2.84	6.82	2.78

Combination (Capacity)	Indoor Air Temp. °C DB	Outdoor Air Temp. °C											
		16/15		15/14		10/9		7/6		6/5		2/1	
		Total Q	Input Power	Total Q	Input Power	Total Q	Input Power	Total Q	Input Power	Total Q	Input Power	Total Q	Input Power
2.0 + 2.0 + 3.5 + 3.5	16	14.72	2.28	14.42	2.34	12.91	2.63	12.00	2.80	11.41	2.84	9.06	3.01
	18	14.11	2.37	13.80	2.43	12.23	2.71	11.29	2.87	10.75	2.91	8.56	3.07
	20	13.90	2.44	13.53	2.49	11.70	2.77	10.60	2.93	10.08	2.96	8.01	3.08
	21	13.92	2.46	13.51	2.51	11.45	2.71	10.21	2.83	9.71	2.89	7.72	3.09
	22	14.04	2.48	13.65	2.54	11.72	2.82	10.56	2.98	9.93	3.01	7.40	3.11
	24	14.55	2.51	13.96	2.56	11.01	2.85	9.24	3.03	8.74	3.05	6.74	3.14
2.0 + 2.0 + 3.5 + 4.2	16	14.72	2.27	14.42	2.33	12.91	2.62	12.00	2.79	11.41	2.83	9.06	3.00
	18	14.11	2.37	13.80	2.42	12.23	2.70	11.29	2.86	10.75	2.90	8.56	3.05
	20	13.90	2.43	13.53	2.48	11.70	2.76	10.60	2.92	10.08	2.95	8.01	3.07
	21	13.92	2.46	13.51	2.50	11.45	2.70	10.21	2.82	9.71	2.88	7.72	3.08
	22	14.04	2.47	13.65	2.53	11.72	2.81	10.56	2.97	9.93	3.00	7.40	3.10
	24	14.55	2.50	13.96	2.56	11.01	2.85	9.24	3.02	8.74	3.04	6.74	3.13
2.0 + 2.0 + 3.5 + 5.0	16	14.72	2.23	14.42	2.29	12.91	2.57	12.00	2.74	11.41	2.78	9.06	2.95
	18	14.11	2.33	13.80	2.38	12.23	2.65	11.29	2.81	10.75	2.85	8.56	3.00
	20	13.90	2.39	13.53	2.44	11.70	2.71	10.60	2.87	10.08	2.90	8.01	3.02
	21	13.92	2.41	13.51	2.45	11.45	2.66	10.21	2.78	9.71	2.83	7.72	3.03
	22	14.04	2.43	13.65	2.49	11.72	2.76	10.56	2.92	9.93	2.95	7.40	3.04
	24	14.55	2.45	13.96	2.51	11.01	2.80	9.24	2.97	8.74	2.99	6.74	3.07
2.0 + 2.0 + 3.5 + 6.0	16	14.72	2.23	14.42	2.29	12.91	2.57	12.00	2.74	11.41	2.78	9.06	2.95
	18	14.11	2.33	13.80	2.38	12.23	2.65	11.29	2.81	10.75	2.85	8.56	3.00
	20	13.90	2.39	13.53	2.44	11.70	2.71	10.60	2.87	10.08	2.90	8.01	3.02
	21	13.92	2.41	13.51	2.45	11.45	2.66	10.21	2.78	9.71	2.83	7.72	3.03
	22	14.04	2.43	13.65	2.49	11.72	2.76	10.56	2.92	9.93	2.95	7.40	3.04
	24	14.55	2.45	13.96	2.51	11.01	2.80	9.24	2.97	8.74	2.99	6.74	3.07
2.0 + 2.0 + 3.5 + 7.1	16	14.72	2.23	14.42	2.28	12.91	2.56	12.00	2.73	11.41	2.77	9.06	2.93
	18	14.11	2.32	13.80	2.37	12.23	2.64	11.29	2.80	10.75	2.84	8.56	2.99
	20	13.90	2.38	13.53	2.43	11.70	2.70	10.60	2.86	10.08	2.89	8.01	3.01
	21	13.92	2.41	13.51	2.45	11.45	2.65	10.21	2.77	9.71	2.82	7.72	3.02
	22	14.04	2.42	13.65	2.48	11.72	2.75	10.56	2.91	9.93	2.94	7.40	3.03
	24	14.55	2.45	13.96	2.50	11.01	2.79	9.24	2.96	8.74	2.98	6.74	3.06
2.0 + 2.0 + 4.2 + 4.2	16	14.72	2.26	14.42	2.32	12.91	2.61	12.00	2.78	11.41	2.82	9.06	2.99
	18	14.11	2.36	13.80	2.41	12.23	2.69	11.29	2.85	10.75	2.89	8.56	3.04
	20	13.90	2.42	13.53	2.48	11.70	2.75	10.60	2.91	10.08	2.94	8.01	3.06
	21	13.92	2.45	13.51	2.49	11.45	2.69	10.21	2.81	9.71	2.87	7.72	3.07
	22	14.04	2.47	13.65	2.52	11.72	2.80	10.56	2.96	9.93	2.99	7.40	3.08
	24	14.55	2.49	13.96	2.55	11.01	2.84	9.24	3.01	8.74	3.03	6.74	3.12

Combination (Capacity)	Indoor Air Temp. °C DB	Outdoor Air Temp. °C									
		0/-1		-5/-6		-7/-8		-10/-11		-15/-	
		Total Q	Input Power	Total Q	Input Power	Total Q	Input Power	Total Q	Input Power	Total Q	Input Power
2.0 + 2.0 + 3.5 + 3.5	16	8.80	2.97	8.13	2.87	7.87	2.84	7.56	2.74	7.05	2.57
	18	8.33	3.02	7.76	2.90	7.53	2.85	7.41	2.76	7.22	2.62
	20	7.86	3.03	7.46	2.91	7.31	2.87	7.28	2.80	7.24	2.70
	21	7.53	3.05	7.07	2.93	6.89	2.88	7.00	2.82	7.19	2.73
	22	7.36	3.06	7.25	2.94	7.21	2.89	7.17	2.84	7.10	2.76
	24	6.85	3.09	7.11	2.98	7.22	2.93	7.07	2.89	6.82	2.83
2.0 + 2.0 + 3.5 + 4.2	16	8.80	2.96	8.13	2.86	7.87	2.83	7.56	2.73	7.05	2.56
	18	8.33	3.01	7.76	2.89	7.53	2.84	7.41	2.75	7.22	2.61
	20	7.86	3.02	7.46	2.90	7.31	2.86	7.28	2.79	7.24	2.69
	21	7.53	3.03	7.07	2.92	6.89	2.87	7.00	2.81	7.19	2.72
	22	7.36	3.05	7.25	2.93	7.21	2.88	7.17	2.83	7.10	2.75
	24	6.85	3.08	7.11	2.97	7.22	2.92	7.07	2.88	6.82	2.82
2.0 + 2.0 + 3.5 + 5.0	16	8.80	2.91	8.13	2.81	7.87	2.78	7.56	2.68	7.05	2.52
	18	8.33	2.96	7.76	2.84	7.53	2.79	7.41	2.71	7.22	2.57
	20	7.86	2.97	7.46	2.85	7.31	2.81	7.28	2.75	7.24	2.64
	21	7.53	2.98	7.07	2.87	6.89	2.82	7.00	2.76	7.19	2.67
	22	7.36	3.00	7.25	2.88	7.21	2.83	7.17	2.78	7.10	2.70
	24	6.85	3.03	7.11	2.92	7.22	2.87	7.07	2.83	6.82	2.77
2.0 + 2.0 + 3.5 + 6.0	16	8.80	2.91	8.13	2.81	7.87	2.78	7.56	2.68	7.05	2.52
	18	8.33	2.96	7.76	2.84	7.53	2.79	7.41	2.71	7.22	2.57
	20	7.86	2.97	7.46	2.85	7.31	2.81	7.28	2.75	7.24	2.64
	21	7.53	2.98	7.07	2.87	6.89	2.82	7.00	2.76	7.19	2.67
	22	7.36	3.00	7.25	2.88	7.21	2.83	7.17	2.78	7.10	2.70
	24	6.85	3.03	7.11	2.92	7.22	2.87	7.07	2.83	6.82	2.77
2.0 + 2.0 + 3.5 + 7.1	16	8.80	2.90	8.13	2.80	7.87	2.77	7.56	2.67	7.05	2.51
	18	8.33	2.95	7.76	2.83	7.53	2.78	7.41	2.70	7.22	2.56
	20	7.86	2.96	7.46	2.84	7.31	2.80	7.28	2.74	7.24	2.63
	21	7.53	2.97	7.07	2.86	6.89	2.81	7.00	2.76	7.19	2.66
	22	7.36	2.99	7.25	2.87	7.21	2.82	7.17	2.78	7.10	2.69
	24	6.85	3.02	7.11	2.91	7.22	2.86	7.07	2.82	6.82	2.76
2.0 + 2.0 + 4.2 + 4.2	16	8.80	2.95	8.13	2.85	7.87	2.82	7.56	2.72	7.05	2.56
	18	8.33	3.00	7.76	2.88	7.53	2.83	7.41	2.75	7.22	2.61
	20	7.86	3.01	7.46	2.89	7.31	2.85	7.28	2.78	7.24	2.68
	21	7.53	3.02	7.07	2.91	6.89	2.86	7.00	2.80	7.19	2.71
	22	7.36	3.04	7.25	2.92	7.21	2.87	7.17	2.82	7.10	2.74
	24	6.85	3.07	7.11	2.96	7.22	2.91	7.07	2.87	6.82	2.81

Combination (Capacity)	Indoor Air Temp. °C DB	Outdoor Air Temp. °C											
		16/15		15/14		10/9		7/6		6/5		2/1	
		Total Q	Input Power	Total Q	Input Power	Total Q	Input Power	Total Q	Input Power	Total Q	Input Power	Total Q	Input Power
2.0 + 2.0 + 4.2 + 5.0	16	14.72	2.23	14.42	2.28	12.91	2.56	12.00	2.73	11.41	2.77	9.06	2.93
	18	14.11	2.32	13.80	2.37	12.23	2.64	11.29	2.80	10.75	2.84	8.56	2.99
	20	13.90	2.38	13.53	2.43	11.70	2.70	10.60	2.86	10.08	2.89	8.01	3.01
	21	13.92	2.41	13.51	2.45	11.45	2.65	10.21	2.77	9.71	2.82	7.72	3.02
	22	14.04	2.42	13.65	2.48	11.72	2.75	10.56	2.91	9.93	2.94	7.40	3.03
	24	14.55	2.45	13.96	2.50	11.01	2.79	9.24	2.96	8.74	2.98	6.74	3.06
2.0 + 2.0 + 4.2 + 6.0	16	14.72	2.23	14.42	2.28	12.91	2.56	12.00	2.73	11.41	2.77	9.06	2.93
	18	14.11	2.32	13.80	2.37	12.23	2.64	11.29	2.80	10.75	2.84	8.56	2.99
	20	13.90	2.38	13.53	2.43	11.70	2.70	10.60	2.86	10.08	2.89	8.01	3.01
	21	13.92	2.41	13.51	2.45	11.45	2.65	10.21	2.77	9.71	2.82	7.72	3.02
	22	14.04	2.42	13.65	2.48	11.72	2.75	10.56	2.91	9.93	2.94	7.40	3.03
	24	14.55	2.45	13.96	2.50	11.01	2.79	9.24	2.96	8.74	2.98	6.74	3.06
2.0 + 2.0 + 5.0 + 5.0	16	14.72	2.25	14.42	2.31	12.91	2.59	12.00	2.76	11.41	2.80	9.06	2.97
	18	14.11	2.34	13.80	2.40	12.23	2.67	11.29	2.83	10.75	2.87	8.56	3.02
	20	13.90	2.40	13.53	2.46	11.70	2.73	10.60	2.89	10.08	2.92	8.01	3.04
	21	13.92	2.43	13.51	2.47	11.45	2.67	10.21	2.80	9.71	2.85	7.72	3.05
	22	14.04	2.45	13.65	2.50	11.72	2.78	10.56	2.94	9.93	2.97	7.40	3.06
	24	14.55	2.47	13.96	2.53	11.01	2.82	9.24	2.99	8.74	3.01	6.74	3.09
2.0 + 2.5 + 2.5 + 2.5	16	14.72	2.33	14.42	2.39	12.91	2.68	12.00	2.86	11.41	2.90	9.06	3.07
	18	14.11	2.42	13.80	2.48	12.23	2.76	11.29	2.93	10.75	2.97	8.56	3.13
	20	13.90	2.49	13.53	2.54	11.70	2.82	10.60	2.99	10.08	3.02	8.01	3.14
	21	13.92	2.52	13.51	2.56	11.45	2.77	10.21	2.89	9.71	2.94	7.72	3.16
	22	14.04	2.53	13.65	2.59	11.72	2.87	10.56	3.05	9.93	3.07	7.40	3.17
	24	14.55	2.56	13.96	2.62	11.01	2.91	9.24	3.09	8.74	3.11	6.74	3.20
2.0 + 2.5 + 2.5 + 3.5	16	14.72	2.30	14.42	2.36	12.91	2.65	12.00	2.83	11.41	2.87	9.06	3.04
	18	14.11	2.40	13.80	2.45	12.23	2.73	11.29	2.90	10.75	2.94	8.56	3.10
	20	13.90	2.46	13.53	2.52	11.70	2.79	10.60	2.96	10.08	2.99	8.01	3.11
	21	13.92	2.49	13.51	2.53	11.45	2.74	10.21	2.86	9.71	2.92	7.72	3.12
	22	14.04	2.51	13.65	2.56	11.72	2.85	10.56	3.01	9.93	3.04	7.40	3.14
	24	14.55	2.53	13.96	2.59	11.01	2.88	9.24	3.06	8.74	3.08	6.74	3.17
2.0 + 2.5 + 2.5 + 4.2	16	14.72	2.30	14.42	2.35	12.91	2.64	12.00	2.82	11.41	2.86	9.06	3.03
	18	14.11	2.39	13.80	2.45	12.23	2.72	11.29	2.89	10.75	2.93	8.56	3.09
	20	13.90	2.45	13.53	2.51	11.70	2.78	10.60	2.95	10.08	2.98	8.01	3.10
	21	13.92	2.48	13.51	2.52	11.45	2.73	10.21	2.85	9.71	2.91	7.72	3.11
	22	14.04	2.50	13.65	2.56	11.72	2.84	10.56	3.00	9.93	3.03	7.40	3.13
	24	14.55	2.52	13.96	2.58	11.01	2.87	9.24	3.05	8.74	3.07	6.74	3.16

Combination (Capacity)	Indoor Air Temp. °C DB	Outdoor Air Temp. °C									
		0/-1		-5/-6		-7/-8		-10/-11		-15/-	
		Total Q	Input Power	Total Q	Input Power	Total Q	Input Power	Total Q	Input Power	Total Q	Input Power
2.0 + 2.0 + 4.2 + 5.0	16	8.80	2.90	8.13	2.80	7.87	2.77	7.56	2.67	7.05	2.51
	18	8.33	2.95	7.76	2.83	7.53	2.78	7.41	2.70	7.22	2.56
	20	7.86	2.96	7.46	2.84	7.31	2.80	7.28	2.74	7.24	2.63
	21	7.53	2.97	7.07	2.86	6.89	2.81	7.00	2.76	7.19	2.66
	22	7.36	2.99	7.25	2.87	7.21	2.82	7.17	2.78	7.10	2.69
	24	6.85	3.02	7.11	2.91	7.22	2.86	7.07	2.82	6.82	2.76
2.0 + 2.0 + 4.2 + 6.0	16	8.80	2.90	8.13	2.80	7.87	2.77	7.56	2.67	7.05	2.51
	18	8.33	2.95	7.76	2.83	7.53	2.78	7.41	2.70	7.22	2.56
	20	7.86	2.96	7.46	2.84	7.31	2.80	7.28	2.74	7.24	2.63
	21	7.53	2.97	7.07	2.86	6.89	2.81	7.00	2.76	7.19	2.66
	22	7.36	2.99	7.25	2.87	7.21	2.82	7.17	2.78	7.10	2.69
	24	6.85	3.02	7.11	2.91	7.22	2.86	7.07	2.82	6.82	2.76
2.0 + 2.0 + 5.0 + 5.0	16	8.80	2.93	8.13	2.83	7.87	2.80	7.56	2.70	7.05	2.54
	18	8.33	2.98	7.76	2.86	7.53	2.81	7.41	2.73	7.22	2.59
	20	7.86	2.99	7.46	2.87	7.31	2.83	7.28	2.76	7.24	2.66
	21	7.53	3.00	7.07	2.89	6.89	2.84	7.00	2.78	7.19	2.69
	22	7.36	3.02	7.25	2.90	7.21	2.85	7.17	2.80	7.10	2.72
	24	6.85	3.05	7.11	2.94	7.22	2.89	7.07	2.85	6.82	2.79
2.0 + 2.5 + 2.5 + 2.5	16	8.80	3.03	8.13	2.93	7.87	2.89	7.56	2.79	7.05	2.63
	18	8.33	3.08	7.76	2.96	7.53	2.91	7.41	2.82	7.22	2.68
	20	7.86	3.09	7.46	2.97	7.31	2.93	7.28	2.86	7.24	2.75
	21	7.53	3.11	7.07	2.99	6.89	2.94	7.00	2.88	7.19	2.78
	22	7.36	3.12	7.25	3.00	7.21	2.95	7.17	2.90	7.10	2.81
	24	6.85	3.15	7.11	3.04	7.22	2.99	7.07	2.95	6.82	2.88
2.0 + 2.5 + 2.5 + 3.5	16	8.80	3.00	8.13	2.90	7.87	2.86	7.56	2.77	7.05	2.60
	18	8.33	3.05	7.76	2.93	7.53	2.88	7.41	2.79	7.22	2.65
	20	7.86	3.06	7.46	2.94	7.31	2.90	7.28	2.83	7.24	2.72
	21	7.53	3.08	7.07	2.96	6.89	2.91	7.00	2.85	7.19	2.75
	22	7.36	3.09	7.25	2.97	7.21	2.92	7.17	2.87	7.10	2.79
	24	6.85	3.12	7.11	3.01	7.22	2.96	7.07	2.92	6.82	2.86
2.0 + 2.5 + 2.5 + 4.2	16	8.80	2.99	8.13	2.89	7.87	2.85	7.56	2.76	7.05	2.59
	18	8.33	3.04	7.76	2.92	7.53	2.87	7.41	2.78	7.22	2.64
	20	7.86	3.05	7.46	2.93	7.31	2.89	7.28	2.82	7.24	2.71
	21	7.53	3.07	7.07	2.95	6.89	2.90	7.00	2.84	7.19	2.75
	22	7.36	3.08	7.25	2.96	7.21	2.91	7.17	2.86	7.10	2.78
	24	6.85	3.11	7.11	3.00	7.22	2.95	7.07	2.91	6.82	2.85

Combination (Capacity)	Indoor Air Temp. °C DB	Outdoor Air Temp. °C											
		16/15		15/14		10/9		7/6		6/5		2/1	
		Total Q	Input Power	Total Q	Input Power	Total Q	Input Power	Total Q	Input Power	Total Q	Input Power	Total Q	Input Power
2.0 + 2.5 + 2.5 + 5.0	16	14.72	2.25	14.42	2.31	12.91	2.59	12.00	2.76	11.41	2.80	9.06	2.97
	18	14.11	2.34	13.80	2.40	12.23	2.67	11.29	2.83	10.75	2.87	8.56	3.02
	20	13.90	2.40	13.53	2.46	11.70	2.73	10.60	2.89	10.08	2.92	8.01	3.04
	21	13.92	2.43	13.51	2.47	11.45	2.67	10.21	2.80	9.71	2.85	7.72	3.05
	22	14.04	2.45	13.65	2.50	11.72	2.78	10.56	2.94	9.93	2.97	7.40	3.06
	24	14.55	2.47	13.96	2.53	11.01	2.82	9.24	2.99	8.74	3.01	6.74	3.09
2.0 + 2.5 + 2.5 + 6.0	16	14.72	2.25	14.42	2.31	12.91	2.59	12.00	2.76	11.41	2.80	9.06	2.97
	18	14.11	2.34	13.80	2.40	12.23	2.67	11.29	2.83	10.75	2.87	8.56	3.02
	20	13.90	2.40	13.53	2.46	11.70	2.73	10.60	2.89	10.08	2.92	8.01	3.04
	21	13.92	2.43	13.51	2.47	11.45	2.67	10.21	2.80	9.71	2.85	7.72	3.05
	22	14.04	2.45	13.65	2.50	11.72	2.78	10.56	2.94	9.93	2.97	7.40	3.06
	24	14.55	2.47	13.96	2.53	11.01	2.82	9.24	2.99	8.74	3.01	6.74	3.09
2.0 + 2.5 + 2.5 + 7.1	16	14.72	2.24	14.42	2.30	12.91	2.58	12.00	2.75	11.41	2.79	9.06	2.96
	18	14.11	2.33	13.80	2.39	12.23	2.66	11.29	2.82	10.75	2.86	8.56	3.01
	20	13.90	2.40	13.53	2.45	11.70	2.72	10.60	2.88	10.08	2.91	8.01	3.03
	21	13.92	2.42	13.51	2.46	11.45	2.66	10.21	2.79	9.71	2.84	7.72	3.04
	22	14.04	2.44	13.65	2.50	11.72	2.77	10.56	2.93	9.93	2.96	7.40	3.05
	24	14.55	2.46	13.96	2.52	11.01	2.81	9.24	2.98	8.74	3.00	6.74	3.08
2.0 + 2.5 + 3.5 + 3.5	16	14.72	2.28	14.42	2.34	12.91	2.63	12.00	2.80	11.41	2.84	9.06	3.01
	18	14.11	2.37	13.80	2.43	12.23	2.71	11.29	2.87	10.75	2.91	8.56	3.07
	20	13.90	2.44	13.53	2.49	11.70	2.77	10.60	2.93	10.08	2.96	8.01	3.08
	21	13.92	2.46	13.51	2.51	11.45	2.71	10.21	2.83	9.71	2.89	7.72	3.09
	22	14.04	2.48	13.65	2.54	11.72	2.82	10.56	2.98	9.93	3.01	7.40	3.11
	24	14.55	2.51	13.96	2.56	11.01	2.85	9.24	3.03	8.74	3.05	6.74	3.14
2.0 + 2.5 + 3.5 + 4.2	16	14.72	2.27	14.42	2.33	12.91	2.62	12.00	2.79	11.41	2.83	9.06	3.00
	18	14.11	2.37	13.80	2.42	12.23	2.70	11.29	2.86	10.75	2.90	8.56	3.05
	20	13.90	2.43	13.53	2.48	11.70	2.76	10.60	2.92	10.08	2.95	8.01	3.07
	21	13.92	2.46	13.51	2.50	11.45	2.70	10.21	2.82	9.71	2.88	7.72	3.08
	22	14.04	2.47	13.65	2.53	11.72	2.81	10.56	2.97	9.93	3.00	7.40	3.10
	24	14.55	2.50	13.96	2.56	11.01	2.85	9.24	3.02	8.74	3.04	6.74	3.13
2.0 + 2.5 + 3.5 + 5.0	16	14.72	2.23	14.42	2.29	12.91	2.57	12.00	2.74	11.41	2.78	9.06	2.95
	18	14.11	2.33	13.80	2.38	12.23	2.65	11.29	2.81	10.75	2.85	8.56	3.00
	20	13.90	2.39	13.53	2.44	11.70	2.71	10.60	2.87	10.08	2.90	8.01	3.02
	21	13.92	2.41	13.51	2.45	11.45	2.66	10.21	2.78	9.71	2.83	7.72	3.03
	22	14.04	2.43	13.65	2.49	11.72	2.76	10.56	2.92	9.93	2.95	7.40	3.04
	24	14.55	2.45	13.96	2.51	11.01	2.80	9.24	2.97	8.74	2.99	6.74	3.07

Combination (Capacity)	Indoor Air Temp. °C DB	Outdoor Air Temp. °C									
		0/-1		-5/-6		-7/-8		-10/-11		-15/-	
		Total Q	Input Power	Total Q	Input Power	Total Q	Input Power	Total Q	Input Power	Total Q	Input Power
2.0 + 2.5 + 2.5 + 5.0	16	8.80	2.93	8.13	2.83	7.87	2.80	7.56	2.70	7.05	2.54
	18	8.33	2.98	7.76	2.86	7.53	2.81	7.41	2.73	7.22	2.59
	20	7.86	2.99	7.46	2.87	7.31	2.83	7.28	2.76	7.24	2.66
	21	7.53	3.00	7.07	2.89	6.89	2.84	7.00	2.78	7.19	2.69
	22	7.36	3.02	7.25	2.90	7.21	2.85	7.17	2.80	7.10	2.72
	24	6.85	3.05	7.11	2.94	7.22	2.89	7.07	2.85	6.82	2.79
2.0 + 2.5 + 2.5 + 6.0	16	8.80	2.93	8.13	2.83	7.87	2.80	7.56	2.70	7.05	2.54
	18	8.33	2.98	7.76	2.86	7.53	2.81	7.41	2.73	7.22	2.59
	20	7.86	2.99	7.46	2.87	7.31	2.83	7.28	2.76	7.24	2.66
	21	7.53	3.00	7.07	2.89	6.89	2.84	7.00	2.78	7.19	2.69
	22	7.36	3.02	7.25	2.90	7.21	2.85	7.17	2.80	7.10	2.72
	24	6.85	3.05	7.11	2.94	7.22	2.89	7.07	2.85	6.82	2.79
2.0 + 2.5 + 2.5 + 7.1	16	8.80	2.92	8.13	2.82	7.87	2.79	7.56	2.69	7.05	2.53
	18	8.33	2.97	7.76	2.85	7.53	2.80	7.41	2.72	7.22	2.58
	20	7.86	2.98	7.46	2.86	7.31	2.82	7.28	2.75	7.24	2.65
	21	7.53	2.99	7.07	2.88	6.89	2.83	7.00	2.77	7.19	2.68
	22	7.36	3.01	7.25	2.89	7.21	2.84	7.17	2.79	7.10	2.71
	24	6.85	3.04	7.11	2.93	7.22	2.88	7.07	2.84	6.82	2.78
2.0 + 2.5 + 3.5 + 3.5	16	8.80	2.97	8.13	2.87	7.87	2.84	7.56	2.74	7.05	2.57
	18	8.33	3.02	7.76	2.90	7.53	2.85	7.41	2.76	7.22	2.62
	20	7.86	3.03	7.46	2.91	7.31	2.87	7.28	2.80	7.24	2.70
	21	7.53	3.05	7.07	2.93	6.89	2.88	7.00	2.82	7.19	2.73
	22	7.36	3.06	7.25	2.94	7.21	2.89	7.17	2.84	7.10	2.76
	24	6.85	3.09	7.11	2.98	7.22	2.93	7.07	2.89	6.82	2.83
2.0 + 2.5 + 3.5 + 4.2	16	8.80	2.96	8.13	2.86	7.87	2.83	7.56	2.73	7.05	2.56
	18	8.33	3.01	7.76	2.89	7.53	2.84	7.41	2.75	7.22	2.61
	20	7.86	3.02	7.46	2.90	7.31	2.86	7.28	2.79	7.24	2.69
	21	7.53	3.03	7.07	2.92	6.89	2.87	7.00	2.81	7.19	2.72
	22	7.36	3.05	7.25	2.93	7.21	2.88	7.17	2.83	7.10	2.75
	24	6.85	3.08	7.11	2.97	7.22	2.92	7.07	2.88	6.82	2.82
2.0 + 2.5 + 3.5 + 5.0	16	8.80	2.91	8.13	2.81	7.87	2.78	7.56	2.68	7.05	2.52
	18	8.33	2.96	7.76	2.84	7.53	2.79	7.41	2.71	7.22	2.57
	20	7.86	2.97	7.46	2.85	7.31	2.81	7.28	2.75	7.24	2.64
	21	7.53	2.98	7.07	2.87	6.89	2.82	7.00	2.76	7.19	2.67
	22	7.36	3.00	7.25	2.88	7.21	2.83	7.17	2.78	7.10	2.70
	24	6.85	3.03	7.11	2.92	7.22	2.87	7.07	2.83	6.82	2.77

Combination (Capacity)	Indoor Air Temp. °C DB	Outdoor Air Temp. °C											
		16/15		15/14		10/9		7/6		6/5		2/1	
		Total Q	Input Power	Total Q	Input Power	Total Q	Input Power	Total Q	Input Power	Total Q	Input Power	Total Q	Input Power
2.0 + 2.5 + 3.5 + 6.0	16	14.72	2.23	14.42	2.29	12.91	2.57	12.00	2.74	11.41	2.78	9.06	2.95
	18	14.11	2.33	13.80	2.38	12.23	2.65	11.29	2.81	10.75	2.85	8.56	3.00
	20	13.90	2.39	13.53	2.44	11.70	2.71	10.60	2.87	10.08	2.90	8.01	3.02
	21	13.92	2.41	13.51	2.45	11.45	2.66	10.21	2.78	9.71	2.83	7.72	3.03
	22	14.04	2.43	13.65	2.49	11.72	2.76	10.56	2.92	9.93	2.95	7.40	3.04
	24	14.55	2.45	13.96	2.51	11.01	2.80	9.24	2.97	8.74	2.99	6.74	3.07
2.0 + 2.5 + 4.2 + 4.2	16	14.72	2.26	14.42	2.32	12.91	2.61	12.00	2.78	11.41	2.82	9.06	2.99
	18	14.11	2.36	13.80	2.41	12.23	2.69	11.29	2.85	10.75	2.89	8.56	3.04
	20	13.90	2.42	13.53	2.48	11.70	2.75	10.60	2.91	10.08	2.94	8.01	3.06
	21	13.92	2.45	13.51	2.49	11.45	2.69	10.21	2.81	9.71	2.87	7.72	3.07
	22	14.04	2.47	13.65	2.52	11.72	2.80	10.56	2.96	9.93	2.99	7.40	3.08
	24	14.55	2.49	13.96	2.55	11.01	2.84	9.24	3.01	8.74	3.03	6.74	3.12
2.0 + 2.5 + 4.2 + 5.0	16	14.72	2.23	14.42	2.28	12.91	2.56	12.00	2.73	11.41	2.77	9.06	2.93
	18	14.11	2.32	13.80	2.37	12.23	2.64	11.29	2.80	10.75	2.84	8.56	2.99
	20	13.90	2.38	13.53	2.43	11.70	2.70	10.60	2.86	10.08	2.89	8.01	3.01
	21	13.92	2.41	13.51	2.45	11.45	2.65	10.21	2.77	9.71	2.82	7.72	3.02
	22	14.04	2.42	13.65	2.48	11.72	2.75	10.56	2.91	9.93	2.94	7.40	3.03
	24	14.55	2.45	13.96	2.50	11.01	2.79	9.24	2.96	8.74	2.98	6.74	3.06
2.0 + 2.5 + 4.2 + 6.0	16	14.72	2.23	14.42	2.28	12.91	2.56	12.00	2.73	11.41	2.77	9.06	2.93
	18	14.11	2.32	13.80	2.37	12.23	2.64	11.29	2.80	10.75	2.84	8.56	2.99
	20	13.90	2.38	13.53	2.43	11.70	2.70	10.60	2.86	10.08	2.89	8.01	3.01
	21	13.92	2.41	13.51	2.45	11.45	2.65	10.21	2.77	9.71	2.82	7.72	3.02
	22	14.04	2.42	13.65	2.48	11.72	2.75	10.56	2.91	9.93	2.94	7.40	3.03
	24	14.55	2.45	13.96	2.50	11.01	2.79	9.24	2.96	8.74	2.98	6.74	3.06
2.0 + 2.5 + 5.0 + 5.0	16	14.72	2.25	14.42	2.31	12.91	2.59	12.00	2.76	11.41	2.80	9.06	2.97
	18	14.11	2.34	13.80	2.40	12.23	2.67	11.29	2.83	10.75	2.87	8.56	3.02
	20	13.90	2.40	13.53	2.46	11.70	2.73	10.60	2.89	10.08	2.92	8.01	3.04
	21	13.92	2.43	13.51	2.47	11.45	2.67	10.21	2.80	9.71	2.85	7.72	3.05
	22	14.04	2.45	13.65	2.50	11.72	2.78	10.56	2.94	9.93	2.97	7.40	3.06
	24	14.55	2.47	13.96	2.53	11.01	2.82	9.24	2.99	8.74	3.01	6.74	3.09
2.0 + 3.5 + 3.5 + 3.5	16	14.72	2.26	14.42	2.31	12.91	2.60	12.00	2.77	11.41	2.81	9.06	2.98
	18	14.11	2.35	13.80	2.40	12.23	2.68	11.29	2.84	10.75	2.88	8.56	3.03
	20	13.90	2.41	13.53	2.47	11.70	2.74	10.60	2.90	10.08	2.93	8.01	3.05
	21	13.92	2.44	13.51	2.48	11.45	2.68	10.21	2.80	9.71	2.86	7.72	3.06
	22	14.04	2.46	13.65	2.51	11.72	2.79	10.56	2.95	9.93	2.98	7.40	3.07
	24	14.55	2.48	13.96	2.54	11.01	2.83	9.24	3.00	8.74	3.02	6.74	3.11



Combination (Capacity)	Indoor Air Temp. °C DB	Outdoor Air Temp. °C									
		0/-1		-5/-6		-7/-8		-10/-11		-15/-	
		Total Q	Input Power	Total Q	Input Power	Total Q	Input Power	Total Q	Input Power	Total Q	Input Power
2.0 + 2.5 + 3.5 + 6.0	16	8.80	2.91	8.13	2.81	7.87	2.78	7.56	2.68	7.05	2.52
	18	8.33	2.96	7.76	2.84	7.53	2.79	7.41	2.71	7.22	2.57
	20	7.86	2.97	7.46	2.85	7.31	2.81	7.28	2.75	7.24	2.64
	21	7.53	2.98	7.07	2.87	6.89	2.82	7.00	2.76	7.19	2.67
	22	7.36	3.00	7.25	2.88	7.21	2.83	7.17	2.78	7.10	2.70
	24	6.85	3.03	7.11	2.92	7.22	2.87	7.07	2.83	6.82	2.77
2.0 + 2.5 + 4.2 + 4.2	16	8.80	2.95	8.13	2.85	7.87	2.82	7.56	2.72	7.05	2.56
	18	8.33	3.00	7.76	2.88	7.53	2.83	7.41	2.75	7.22	2.61
	20	7.86	3.01	7.46	2.89	7.31	2.85	7.28	2.78	7.24	2.68
	21	7.53	3.02	7.07	2.91	6.89	2.86	7.00	2.80	7.19	2.71
	22	7.36	3.04	7.25	2.92	7.21	2.87	7.17	2.82	7.10	2.74
	24	6.85	3.07	7.11	2.96	7.22	2.91	7.07	2.87	6.82	2.81
2.0 + 2.5 + 4.2 + 5.0	16	8.80	2.90	8.13	2.80	7.87	2.77	7.56	2.67	7.05	2.51
	18	8.33	2.95	7.76	2.83	7.53	2.78	7.41	2.70	7.22	2.56
	20	7.86	2.96	7.46	2.84	7.31	2.80	7.28	2.74	7.24	2.63
	21	7.53	2.97	7.07	2.86	6.89	2.81	7.00	2.76	7.19	2.66
	22	7.36	2.99	7.25	2.87	7.21	2.82	7.17	2.78	7.10	2.69
	24	6.85	3.02	7.11	2.91	7.22	2.86	7.07	2.82	6.82	2.76
2.0 + 2.5 + 4.2 + 6.0	16	8.80	2.90	8.13	2.80	7.87	2.77	7.56	2.67	7.05	2.51
	18	8.33	2.95	7.76	2.83	7.53	2.78	7.41	2.70	7.22	2.56
	20	7.86	2.96	7.46	2.84	7.31	2.80	7.28	2.74	7.24	2.63
	21	7.53	2.97	7.07	2.86	6.89	2.81	7.00	2.76	7.19	2.66
	22	7.36	2.99	7.25	2.87	7.21	2.82	7.17	2.78	7.10	2.69
	24	6.85	3.02	7.11	2.91	7.22	2.86	7.07	2.82	6.82	2.76
2.0 + 2.5 + 5.0 + 5.0	16	8.80	2.93	8.13	2.83	7.87	2.80	7.56	2.70	7.05	2.54
	18	8.33	2.98	7.76	2.86	7.53	2.81	7.41	2.73	7.22	2.59
	20	7.86	2.99	7.46	2.87	7.31	2.83	7.28	2.76	7.24	2.66
	21	7.53	3.00	7.07	2.89	6.89	2.84	7.00	2.78	7.19	2.69
	22	7.36	3.02	7.25	2.90	7.21	2.85	7.17	2.80	7.10	2.72
	24	6.85	3.05	7.11	2.94	7.22	2.89	7.07	2.85	6.82	2.79
2.0 + 3.5 + 3.5 + 3.5	16	8.80	2.94	8.13	2.84	7.87	2.81	7.56	2.71	7.05	2.55
	18	8.33	2.99	7.76	2.87	7.53	2.82	7.41	2.74	7.22	2.60
	20	7.86	3.00	7.46	2.88	7.31	2.84	7.28	2.77	7.24	2.67
	21	7.53	3.01	7.07	2.90	6.89	2.85	7.00	2.79	7.19	2.70
	22	7.36	3.03	7.25	2.91	7.21	2.86	7.17	2.81	7.10	2.73
	24	6.85	3.06	7.11	2.95	7.22	2.90	7.07	2.86	6.82	2.80

Combination (Capacity)	Indoor Air Temp. °C DB	Outdoor Air Temp. °C											
		16/15		15/14		10/9		7/6		6/5		2/1	
		Total Q	Input Power	Total Q	Input Power	Total Q	Input Power	Total Q	Input Power	Total Q	Input Power	Total Q	Input Power
2.0 + 3.5 + 3.5 + 4.2	16	14.72	2.25	14.42	2.31	12.91	2.59	12.00	2.76	11.41	2.80	9.06	2.97
	18	14.11	2.34	13.80	2.40	12.23	2.67	11.29	2.83	10.75	2.87	8.56	3.02
	20	13.90	2.40	13.53	2.46	11.70	2.73	10.60	2.89	10.08	2.92	8.01	3.04
	21	13.92	2.43	13.51	2.47	11.45	2.67	10.21	2.80	9.71	2.85	7.72	3.05
	22	14.04	2.45	13.65	2.50	11.72	2.78	10.56	2.94	9.93	2.97	7.40	3.06
	24	14.55	2.47	13.96	2.53	11.01	2.82	9.24	2.99	8.74	3.01	6.74	3.09
2.0 + 3.5 + 3.5 + 5.0	16	14.72	2.22	14.42	2.27	12.91	2.55	12.00	2.72	11.41	2.76	9.06	2.92
	18	14.11	2.31	13.80	2.36	12.23	2.63	11.29	2.79	10.75	2.83	8.56	2.98
	20	13.90	2.37	13.53	2.42	11.70	2.69	10.60	2.85	10.08	2.88	8.01	2.99
	21	13.92	2.40	13.51	2.44	11.45	2.64	10.21	2.76	9.71	2.81	7.72	3.01
	22	14.04	2.42	13.65	2.47	11.72	2.74	10.56	2.90	9.93	2.93	7.40	3.02
	24	14.55	2.44	13.96	2.49	11.01	2.78	9.24	2.95	8.74	2.97	6.74	3.05
2.0 + 3.5 + 4.2 + 4.2	16	14.72	2.24	14.42	2.30	12.91	2.58	12.00	2.75	11.41	2.79	9.06	2.96
	18	14.11	2.33	13.80	2.39	12.23	2.66	11.29	2.82	10.75	2.86	8.56	3.01
	20	13.90	2.40	13.53	2.45	11.70	2.72	10.60	2.88	10.08	2.91	8.01	3.03
	21	13.92	2.42	13.51	2.46	11.45	2.66	10.21	2.79	9.71	2.84	7.72	3.04
	22	14.04	2.44	13.65	2.50	11.72	2.77	10.56	2.93	9.93	2.96	7.40	3.05
	24	14.55	2.46	13.96	2.52	11.01	2.81	9.24	2.98	8.74	3.00	6.74	3.08
2.0 + 3.5 + 4.2 + 5.0	16	14.72	2.21	14.42	2.27	12.91	2.55	12.00	2.71	11.41	2.75	9.06	2.91
	18	14.11	2.30	13.80	2.36	12.23	2.62	11.29	2.78	10.75	2.82	8.56	2.97
	20	13.90	2.36	13.53	2.42	11.70	2.68	10.60	2.84	10.08	2.87	8.01	2.98
	21	13.92	2.39	13.51	2.43	11.45	2.63	10.21	2.75	9.71	2.80	7.72	3.00
	22	14.04	2.41	13.65	2.46	11.72	2.73	10.56	2.89	9.93	2.92	7.40	3.01
	24	14.55	2.43	13.96	2.49	11.01	2.77	9.24	2.94	8.74	2.96	6.74	3.04
2.0 + 4.2 + 4.2 + 4.2	16	14.72	2.23	14.42	2.29	12.91	2.57	12.00	2.74	11.41	2.78	9.06	2.95
	18	14.11	2.33	13.80	2.38	12.23	2.65	11.29	2.81	10.75	2.85	8.56	3.00
	20	13.90	2.39	13.53	2.44	11.70	2.71	10.60	2.87	10.08	2.90	8.01	3.02
	21	13.92	2.41	13.51	2.45	11.45	2.66	10.21	2.78	9.71	2.83	7.72	3.03
	22	14.04	2.43	13.65	2.49	11.72	2.76	10.56	2.92	9.93	2.95	7.40	3.04
	24	14.55	2.45	13.96	2.51	11.01	2.80	9.24	2.97	8.74	2.99	6.74	3.07
2.5 + 2.5 + 2.5 + 2.5	16	14.72	2.33	14.42	2.39	12.91	2.68	12.00	2.86	11.41	2.90	9.06	3.07
	18	14.11	2.42	13.80	2.48	12.23	2.76	11.29	2.93	10.75	2.97	8.56	3.13
	20	13.90	2.49	13.53	2.54	11.70	2.82	10.60	2.99	10.08	3.02	8.01	3.14
	21	13.92	2.52	13.51	2.56	11.45	2.77	10.21	2.89	9.71	2.94	7.72	3.16
	22	14.04	2.53	13.65	2.59	11.72	2.87	10.56	3.05	9.93	3.07	7.40	3.17
	24	14.55	2.56	13.96	2.62	11.01	2.91	9.24	3.09	8.74	3.11	6.74	3.20

Combination (Capacity)	Indoor Air Temp. °C DB	Outdoor Air Temp. °C									
		0/-1		-5/-6		-7/-8		-10/-11		-15/-	
		Total Q	Input Power	Total Q	Input Power	Total Q	Input Power	Total Q	Input Power	Total Q	Input Power
2.0 + 3.5 + 3.5 + 4.2	16	8.80	2.93	8.13	2.83	7.87	2.80	7.56	2.70	7.05	2.54
	18	8.33	2.98	7.76	2.86	7.53	2.81	7.41	2.73	7.22	2.59
	20	7.86	2.99	7.46	2.87	7.31	2.83	7.28	2.76	7.24	2.66
	21	7.53	3.00	7.07	2.89	6.89	2.84	7.00	2.78	7.19	2.69
	22	7.36	3.02	7.25	2.90	7.21	2.85	7.17	2.80	7.10	2.72
	24	6.85	3.05	7.11	2.94	7.22	2.89	7.07	2.85	6.82	2.79
2.0 + 3.5 + 3.5 + 5.0	16	8.80	2.89	8.13	2.79	7.87	2.76	7.56	2.66	7.05	2.50
	18	8.33	2.93	7.76	2.82	7.53	2.77	7.41	2.69	7.22	2.55
	20	7.86	2.95	7.46	2.83	7.31	2.79	7.28	2.73	7.24	2.62
	21	7.53	2.96	7.07	2.85	6.89	2.80	7.00	2.75	7.19	2.65
	22	7.36	2.98	7.25	2.86	7.21	2.81	7.17	2.77	7.10	2.68
	24	6.85	3.01	7.11	2.89	7.22	2.85	7.07	2.81	6.82	2.75
2.0 + 3.5 + 4.2 + 4.2	16	8.80	2.92	8.13	2.82	7.87	2.79	7.56	2.69	7.05	2.53
	18	8.33	2.97	7.76	2.85	7.53	2.80	7.41	2.72	7.22	2.58
	20	7.86	2.98	7.46	2.86	7.31	2.82	7.28	2.75	7.24	2.65
	21	7.53	2.99	7.07	2.88	6.89	2.83	7.00	2.77	7.19	2.68
	22	7.36	3.01	7.25	2.89	7.21	2.84	7.17	2.79	7.10	2.71
	24	6.85	3.04	7.11	2.93	7.22	2.88	7.07	2.84	6.82	2.78
2.0 + 3.5 + 4.2 + 5.0	16	8.80	2.88	8.13	2.79	7.87	2.75	7.56	2.65	7.05	2.49
	18	8.33	2.92	7.76	2.81	7.53	2.76	7.41	2.68	7.22	2.54
	20	7.86	2.94	7.46	2.82	7.31	2.78	7.28	2.72	7.24	2.61
	21	7.53	2.95	7.07	2.84	6.89	2.79	7.00	2.74	7.19	2.64
	22	7.36	2.96	7.25	2.85	7.21	2.80	7.17	2.76	7.10	2.67
	24	6.85	3.00	7.11	2.88	7.22	2.84	7.07	2.80	6.82	2.74
2.0 + 4.2 + 4.2 + 4.2	16	8.80	2.91	8.13	2.81	7.87	2.78	7.56	2.68	7.05	2.52
	18	8.33	2.96	7.76	2.84	7.53	2.79	7.41	2.71	7.22	2.57
	20	7.86	2.97	7.46	2.85	7.31	2.81	7.28	2.75	7.24	2.64
	21	7.53	2.98	7.07	2.87	6.89	2.82	7.00	2.76	7.19	2.67
	22	7.36	3.00	7.25	2.88	7.21	2.83	7.17	2.78	7.10	2.70
	24	6.85	3.03	7.11	2.92	7.22	2.87	7.07	2.83	6.82	2.77
2.5 + 2.5 + 2.5 + 2.5	16	8.80	3.03	8.13	2.93	7.87	2.89	7.56	2.79	7.05	2.63
	18	8.33	3.08	7.76	2.96	7.53	2.91	7.41	2.82	7.22	2.68
	20	7.86	3.09	7.46	2.97	7.31	2.93	7.28	2.86	7.24	2.75
	21	7.53	3.11	7.07	2.99	6.89	2.94	7.00	2.88	7.19	2.78
	22	7.36	3.12	7.25	3.00	7.21	2.95	7.17	2.90	7.10	2.81
	24	6.85	3.15	7.11	3.04	7.22	2.99	7.07	2.95	6.82	2.88

Combination (Capacity)	Indoor Air Temp. °C DB	Outdoor Air Temp. °C											
		16/15		15/14		10/9		7/6		6/5		2/1	
		Total Q	Input Power	Total Q	Input Power	Total Q	Input Power	Total Q	Input Power	Total Q	Input Power	Total Q	Input Power
2.5 + 2.5 + 2.5 + 3.5	16	14.72	2.30	14.42	2.36	12.91	2.65	12.00	2.83	11.41	2.87	9.06	3.04
	18	14.11	2.40	13.80	2.45	12.23	2.73	11.29	2.90	10.75	2.94	8.56	3.10
	20	13.90	2.46	13.53	2.52	11.70	2.79	10.60	2.96	10.08	2.99	8.01	3.11
	21	13.92	2.49	13.51	2.53	11.45	2.74	10.21	2.86	9.71	2.92	7.72	3.12
	22	14.04	2.51	13.65	2.56	11.72	2.85	10.56	3.01	9.93	3.04	7.40	3.14
	24	14.55	2.53	13.96	2.59	11.01	2.88	9.24	3.06	8.74	3.08	6.74	3.17
2.5 + 2.5 + 2.5 + 4.2	16	14.72	2.30	14.42	2.35	12.91	2.64	12.00	2.82	11.41	2.86	9.06	3.03
	18	14.11	2.39	13.80	2.45	12.23	2.72	11.29	2.89	10.75	2.93	8.56	3.09
	20	13.90	2.45	13.53	2.51	11.70	2.78	10.60	2.95	10.08	2.98	8.01	3.10
	21	13.92	2.48	13.51	2.52	11.45	2.73	10.21	2.85	9.71	2.91	7.72	3.11
	22	14.04	2.50	13.65	2.56	11.72	2.84	10.56	3.00	9.93	3.03	7.40	3.13
	24	14.55	2.52	13.96	2.58	11.01	2.87	9.24	3.05	8.74	3.07	6.74	3.16
2.5 + 2.5 + 2.5 + 5.0	16	14.72	2.25	14.42	2.31	12.91	2.59	12.00	2.76	11.41	2.80	9.06	2.97
	18	14.11	2.34	13.80	2.40	12.23	2.67	11.29	2.83	10.75	2.87	8.56	3.02
	20	13.90	2.40	13.53	2.46	11.70	2.73	10.60	2.89	10.08	2.92	8.01	3.04
	21	13.92	2.43	13.51	2.47	11.45	2.67	10.21	2.80	9.71	2.85	7.72	3.05
	22	14.04	2.45	13.65	2.50	11.72	2.78	10.56	2.94	9.93	2.97	7.40	3.06
	24	14.55	2.47	13.96	2.53	11.01	2.82	9.24	2.99	8.74	3.01	6.74	3.09
2.5 + 2.5 + 2.5 + 6.0	16	14.72	2.25	14.42	2.31	12.91	2.59	12.00	2.76	11.41	2.80	9.06	2.97
	18	14.11	2.34	13.80	2.40	12.23	2.67	11.29	2.83	10.75	2.87	8.56	3.02
	20	13.90	2.40	13.53	2.46	11.70	2.73	10.60	2.89	10.08	2.92	8.01	3.04
	21	13.92	2.43	13.51	2.47	11.45	2.67	10.21	2.80	9.71	2.85	7.72	3.05
	22	14.04	2.45	13.65	2.50	11.72	2.78	10.56	2.94	9.93	2.97	7.40	3.06
	24	14.55	2.47	13.96	2.53	11.01	2.82	9.24	2.99	8.74	3.01	6.74	3.09
2.5 + 2.5 + 2.5 + 7.1	16	14.72	2.24	14.42	2.30	12.91	2.58	12.00	2.75	11.41	2.79	9.06	2.96
	18	14.11	2.33	13.80	2.39	12.23	2.66	11.29	2.82	10.75	2.86	8.56	3.01
	20	13.90	2.40	13.53	2.45	11.70	2.72	10.60	2.88	10.08	2.91	8.01	3.03
	21	13.92	2.42	13.51	2.46	11.45	2.66	10.21	2.79	9.71	2.84	7.72	3.04
	22	14.04	2.44	13.65	2.50	11.72	2.77	10.56	2.93	9.93	2.96	7.40	3.05
	24	14.55	2.46	13.96	2.52	11.01	2.81	9.24	2.98	8.74	3.00	6.74	3.08
2.5 + 2.5 + 3.5 + 3.5	16	14.72	2.28	14.42	2.34	12.91	2.63	12.00	2.80	11.41	2.84	9.06	3.01
	18	14.11	2.37	13.80	2.43	12.23	2.71	11.29	2.87	10.75	2.91	8.56	3.07
	20	13.90	2.44	13.53	2.49	11.70	2.77	10.60	2.93	10.08	2.96	8.01	3.08
	21	13.92	2.46	13.51	2.51	11.45	2.71	10.21	2.83	9.71	2.89	7.72	3.09
	22	14.04	2.48	13.65	2.54	11.72	2.82	10.56	2.98	9.93	3.01	7.40	3.11
	24	14.55	2.51	13.96	2.56	11.01	2.85	9.24	3.03	8.74	3.05	6.74	3.14

Combination (Capacity)	Indoor Air Temp. °C DB	Outdoor Air Temp. °C									
		0/-1		-5/-6		-7/-8		-10/-11		-15/-	
		Total Q	Input Power	Total Q	Input Power	Total Q	Input Power	Total Q	Input Power	Total Q	Input Power
2.5 + 2.5 + 2.5 + 3.5	16	8.80	3.00	8.13	2.90	7.87	2.86	7.56	2.77	7.05	2.60
	18	8.33	3.05	7.76	2.93	7.53	2.88	7.41	2.79	7.22	2.65
	20	7.86	3.06	7.46	2.94	7.31	2.90	7.28	2.83	7.24	2.72
	21	7.53	3.08	7.07	2.96	6.89	2.91	7.00	2.85	7.19	2.75
	22	7.36	3.09	7.25	2.97	7.21	2.92	7.17	2.87	7.10	2.79
	24	6.85	3.12	7.11	3.01	7.22	2.96	7.07	2.92	6.82	2.86
2.5 + 2.5 + 2.5 + 4.2	16	8.80	2.99	8.13	2.89	7.87	2.85	7.56	2.76	7.05	2.59
	18	8.33	3.04	7.76	2.92	7.53	2.87	7.41	2.78	7.22	2.64
	20	7.86	3.05	7.46	2.93	7.31	2.89	7.28	2.82	7.24	2.71
	21	7.53	3.07	7.07	2.95	6.89	2.90	7.00	2.84	7.19	2.75
	22	7.36	3.08	7.25	2.96	7.21	2.91	7.17	2.86	7.10	2.78
	24	6.85	3.11	7.11	3.00	7.22	2.95	7.07	2.91	6.82	2.85
2.5 + 2.5 + 2.5 + 5.0	16	8.80	2.93	8.13	2.83	7.87	2.80	7.56	2.70	7.05	2.54
	18	8.33	2.98	7.76	2.86	7.53	2.81	7.41	2.73	7.22	2.59
	20	7.86	2.99	7.46	2.87	7.31	2.83	7.28	2.76	7.24	2.66
	21	7.53	3.00	7.07	2.89	6.89	2.84	7.00	2.78	7.19	2.69
	22	7.36	3.02	7.25	2.90	7.21	2.85	7.17	2.80	7.10	2.72
	24	6.85	3.05	7.11	2.94	7.22	2.89	7.07	2.85	6.82	2.79
2.5 + 2.5 + 2.5 + 6.0	16	8.80	2.93	8.13	2.83	7.87	2.80	7.56	2.70	7.05	2.54
	18	8.33	2.98	7.76	2.86	7.53	2.81	7.41	2.73	7.22	2.59
	20	7.86	2.99	7.46	2.87	7.31	2.83	7.28	2.76	7.24	2.66
	21	7.53	3.00	7.07	2.89	6.89	2.84	7.00	2.78	7.19	2.69
	22	7.36	3.02	7.25	2.90	7.21	2.85	7.17	2.80	7.10	2.72
	24	6.85	3.05	7.11	2.94	7.22	2.89	7.07	2.85	6.82	2.79
2.5 + 2.5 + 2.5 + 7.1	16	8.80	2.92	8.13	2.82	7.87	2.79	7.56	2.69	7.05	2.53
	18	8.33	2.97	7.76	2.85	7.53	2.80	7.41	2.72	7.22	2.58
	20	7.86	2.98	7.46	2.86	7.31	2.82	7.28	2.75	7.24	2.65
	21	7.53	2.99	7.07	2.88	6.89	2.83	7.00	2.77	7.19	2.68
	22	7.36	3.01	7.25	2.89	7.21	2.84	7.17	2.79	7.10	2.71
	24	6.85	3.04	7.11	2.93	7.22	2.88	7.07	2.84	6.82	2.78
2.5 + 2.5 + 3.5 + 3.5	16	8.80	2.97	8.13	2.87	7.87	2.84	7.56	2.74	7.05	2.57
	18	8.33	3.02	7.76	2.90	7.53	2.85	7.41	2.76	7.22	2.62
	20	7.86	3.03	7.46	2.91	7.31	2.87	7.28	2.80	7.24	2.70
	21	7.53	3.05	7.07	2.93	6.89	2.88	7.00	2.82	7.19	2.73
	22	7.36	3.06	7.25	2.94	7.21	2.89	7.17	2.84	7.10	2.76
	24	6.85	3.09	7.11	2.98	7.22	2.93	7.07	2.89	6.82	2.83

Combination (Capacity)	Indoor Air Temp. °C DB	Outdoor Air Temp. °C											
		16/15		15/14		10/9		7/6		6/5		2/1	
		Total Q	Input Power	Total Q	Input Power	Total Q	Input Power	Total Q	Input Power	Total Q	Input Power	Total Q	Input Power
2.5 + 2.5 + 3.5 + 4.2	16	14.72	2.27	14.42	2.33	12.91	2.62	12.00	2.79	11.41	2.83	9.06	3.00
	18	14.11	2.37	13.80	2.42	12.23	2.70	11.29	2.86	10.75	2.90	8.56	3.05
	20	13.90	2.43	13.53	2.48	11.70	2.76	10.60	2.92	10.08	2.95	8.01	3.07
	21	13.92	2.46	13.51	2.50	11.45	2.70	10.21	2.82	9.71	2.88	7.72	3.08
	22	14.04	2.47	13.65	2.53	11.72	2.81	10.56	2.97	9.93	3.00	7.40	3.10
	24	14.55	2.50	13.96	2.56	11.01	2.85	9.24	3.02	8.74	3.04	6.74	3.13
2.5 + 2.5 + 3.5 + 5.0	16	14.72	2.23	14.42	2.29	12.91	2.57	12.00	2.74	11.41	2.78	9.06	2.95
	18	14.11	2.33	13.80	2.38	12.23	2.65	11.29	2.81	10.75	2.85	8.56	3.00
	20	13.90	2.39	13.53	2.44	11.70	2.71	10.60	2.87	10.08	2.90	8.01	3.02
	21	13.92	2.41	13.51	2.45	11.45	2.66	10.21	2.78	9.71	2.83	7.72	3.03
	22	14.04	2.43	13.65	2.49	11.72	2.76	10.56	2.92	9.93	2.95	7.40	3.04
	24	14.55	2.45	13.96	2.51	11.01	2.80	9.24	2.97	8.74	2.99	6.74	3.07
2.5 + 2.5 + 3.5 + 6.0	16	14.72	2.23	14.42	2.29	12.91	2.57	12.00	2.74	11.41	2.78	9.06	2.95
	18	14.11	2.33	13.80	2.38	12.23	2.65	11.29	2.81	10.75	2.85	8.56	3.00
	20	13.90	2.39	13.53	2.44	11.70	2.71	10.60	2.87	10.08	2.90	8.01	3.02
	21	13.92	2.41	13.51	2.45	11.45	2.66	10.21	2.78	9.71	2.83	7.72	3.03
	22	14.04	2.43	13.65	2.49	11.72	2.76	10.56	2.92	9.93	2.95	7.40	3.04
	24	14.55	2.45	13.96	2.51	11.01	2.80	9.24	2.97	8.74	2.99	6.74	3.07
2.5 + 2.5 + 4.2 + 4.2	16	14.72	2.26	14.42	2.32	12.91	2.61	12.00	2.78	11.41	2.82	9.06	2.99
	18	14.11	2.36	13.80	2.41	12.23	2.69	11.29	2.85	10.75	2.89	8.56	3.04
	20	13.90	2.42	13.53	2.48	11.70	2.75	10.60	2.91	10.08	2.94	8.01	3.06
	21	13.92	2.45	13.51	2.49	11.45	2.69	10.21	2.81	9.71	2.87	7.72	3.07
	22	14.04	2.47	13.65	2.52	11.72	2.80	10.56	2.96	9.93	2.99	7.40	3.08
	24	14.55	2.49	13.96	2.55	11.01	2.84	9.24	3.01	8.74	3.03	6.74	3.12
2.5 + 2.5 + 4.2 + 5.0	16	14.72	2.23	14.42	2.28	12.91	2.56	12.00	2.73	11.41	2.77	9.06	2.93
	18	14.11	2.32	13.80	2.37	12.23	2.64	11.29	2.80	10.75	2.84	8.56	2.99
	20	13.90	2.38	13.53	2.43	11.70	2.70	10.60	2.86	10.08	2.89	8.01	3.01
	21	13.92	2.41	13.51	2.45	11.45	2.65	10.21	2.77	9.71	2.82	7.72	3.02
	22	14.04	2.42	13.65	2.48	11.72	2.75	10.56	2.91	9.93	2.94	7.40	3.03
	24	14.55	2.45	13.96	2.50	11.01	2.79	9.24	2.96	8.74	2.98	6.74	3.06
2.5 + 3.5 + 3.5 + 3.5	16	14.72	2.26	14.42	2.31	12.91	2.60	12.00	2.77	11.41	2.81	9.06	2.98
	18	14.11	2.35	13.80	2.40	12.23	2.68	11.29	2.84	10.75	2.88	8.56	3.03
	20	13.90	2.41	13.53	2.47	11.70	2.74	10.60	2.90	10.08	2.93	8.01	3.05
	21	13.92	2.44	13.51	2.48	11.45	2.68	10.21	2.80	9.71	2.86	7.72	3.06
	22	14.04	2.46	13.65	2.51	11.72	2.79	10.56	2.95	9.93	2.98	7.40	3.07
	24	14.55	2.48	13.96	2.54	11.01	2.83	9.24	3.00	8.74	3.02	6.74	3.11

Combination (Capacity)	Indoor Air Temp. °C DB	Outdoor Air Temp. °C									
		0/-1		-5/-6		-7/-8		-10/-11		-15/-	
		Total Q	Input Power	Total Q	Input Power	Total Q	Input Power	Total Q	Input Power	Total Q	Input Power
2.5 + 2.5 + 3.5 + 4.2	16	8.80	2.96	8.13	2.86	7.87	2.83	7.56	2.73	7.05	2.56
	18	8.33	3.01	7.76	2.89	7.53	2.84	7.41	2.75	7.22	2.61
	20	7.86	3.02	7.46	2.90	7.31	2.86	7.28	2.79	7.24	2.69
	21	7.53	3.03	7.07	2.92	6.89	2.87	7.00	2.81	7.19	2.72
	22	7.36	3.05	7.25	2.93	7.21	2.88	7.17	2.83	7.10	2.75
	24	6.85	3.08	7.11	2.97	7.22	2.92	7.07	2.88	6.82	2.82
2.5 + 2.5 + 3.5 + 5.0	16	8.80	2.91	8.13	2.81	7.87	2.78	7.56	2.68	7.05	2.52
	18	8.33	2.96	7.76	2.84	7.53	2.79	7.41	2.71	7.22	2.57
	20	7.86	2.97	7.46	2.85	7.31	2.81	7.28	2.75	7.24	2.64
	21	7.53	2.98	7.07	2.87	6.89	2.82	7.00	2.76	7.19	2.67
	22	7.36	3.00	7.25	2.88	7.21	2.83	7.17	2.78	7.10	2.70
	24	6.85	3.03	7.11	2.92	7.22	2.87	7.07	2.83	6.82	2.77
2.5 + 2.5 + 3.5 + 6.0	16	8.80	2.91	8.13	2.81	7.87	2.78	7.56	2.68	7.05	2.52
	18	8.33	2.96	7.76	2.84	7.53	2.79	7.41	2.71	7.22	2.57
	20	7.86	2.97	7.46	2.85	7.31	2.81	7.28	2.75	7.24	2.64
	21	7.53	2.98	7.07	2.87	6.89	2.82	7.00	2.76	7.19	2.67
	22	7.36	3.00	7.25	2.88	7.21	2.83	7.17	2.78	7.10	2.70
	24	6.85	3.03	7.11	2.92	7.22	2.87	7.07	2.83	6.82	2.77
2.5 + 2.5 + 4.2 + 4.2	16	8.80	2.95	8.13	2.85	7.87	2.82	7.56	2.72	7.05	2.56
	18	8.33	3.00	7.76	2.88	7.53	2.83	7.41	2.75	7.22	2.61
	20	7.86	3.01	7.46	2.89	7.31	2.85	7.28	2.78	7.24	2.68
	21	7.53	3.02	7.07	2.91	6.89	2.86	7.00	2.80	7.19	2.71
	22	7.36	3.04	7.25	2.92	7.21	2.87	7.17	2.82	7.10	2.74
	24	6.85	3.07	7.11	2.96	7.22	2.91	7.07	2.87	6.82	2.81
2.5 + 2.5 + 4.2 + 5.0	16	8.80	2.90	8.13	2.80	7.87	2.77	7.56	2.67	7.05	2.51
	18	8.33	2.95	7.76	2.83	7.53	2.78	7.41	2.70	7.22	2.56
	20	7.86	2.96	7.46	2.84	7.31	2.80	7.28	2.74	7.24	2.63
	21	7.53	2.97	7.07	2.86	6.89	2.81	7.00	2.76	7.19	2.66
	22	7.36	2.99	7.25	2.87	7.21	2.82	7.17	2.78	7.10	2.69
	24	6.85	3.02	7.11	2.91	7.22	2.86	7.07	2.82	6.82	2.76
2.5 + 3.5 + 3.5 + 3.5	16	8.80	2.94	8.13	2.84	7.87	2.81	7.56	2.71	7.05	2.55
	18	8.33	2.99	7.76	2.87	7.53	2.82	7.41	2.74	7.22	2.60
	20	7.86	3.00	7.46	2.88	7.31	2.84	7.28	2.77	7.24	2.67
	21	7.53	3.01	7.07	2.90	6.89	2.85	7.00	2.79	7.19	2.70
	22	7.36	3.03	7.25	2.91	7.21	2.86	7.17	2.81	7.10	2.73
	24	6.85	3.06	7.11	2.95	7.22	2.90	7.07	2.86	6.82	2.80

Combination (Capacity)	Indoor Air Temp. °C DB	Outdoor Air Temp. °C											
		16/15		15/14		10/9		7/6		6/5		2/1	
		Total Q	Input Power	Total Q	Input Power	Total Q	Input Power	Total Q	Input Power	Total Q	Input Power	Total Q	Input Power
2.5 + 3.5 + 3.5 + 4.2	16	14.72	2.25	14.42	2.31	12.91	2.59	12.00	2.76	11.41	2.80	9.06	2.97
	18	14.11	2.34	13.80	2.40	12.23	2.67	11.29	2.83	10.75	2.87	8.56	3.02
	20	13.90	2.40	13.53	2.46	11.70	2.73	10.60	2.89	10.08	2.92	8.01	3.04
	21	13.92	2.43	13.51	2.47	11.45	2.67	10.21	2.80	9.71	2.85	7.72	3.05
	22	14.04	2.45	13.65	2.50	11.72	2.78	10.56	2.94	9.93	2.97	7.40	3.06
	24	14.55	2.47	13.96	2.53	11.01	2.82	9.24	2.99	8.74	3.01	6.74	3.09
2.5 + 3.5 + 3.5 + 5.0	16	14.72	2.22	14.42	2.27	12.91	2.55	12.00	2.72	11.41	2.76	9.06	2.92
	18	14.11	2.31	13.80	2.36	12.23	2.63	11.29	2.79	10.75	2.83	8.56	2.98
	20	13.90	2.37	13.53	2.42	11.70	2.69	10.60	2.85	10.08	2.88	8.01	2.99
	21	13.92	2.40	13.51	2.44	11.45	2.64	10.21	2.76	9.71	2.81	7.72	3.01
	22	14.04	2.42	13.65	2.47	11.72	2.74	10.56	2.90	9.93	2.93	7.40	3.02
	24	14.55	2.44	13.96	2.49	11.01	2.78	9.24	2.95	8.74	2.97	6.74	3.05
2.5 + 3.5 + 4.2 + 4.2	16	14.72	2.24	14.42	2.30	12.91	2.58	12.00	2.75	11.41	2.79	9.06	2.96
	18	14.11	2.33	13.80	2.39	12.23	2.66	11.29	2.82	10.75	2.86	8.56	3.01
	20	13.90	2.40	13.53	2.45	11.70	2.72	10.60	2.88	10.08	2.91	8.01	3.03
	21	13.92	2.42	13.51	2.46	11.45	2.66	10.21	2.79	9.71	2.84	7.72	3.04
	22	14.04	2.44	13.65	2.50	11.72	2.77	10.56	2.93	9.93	2.96	7.40	3.05
	24	14.55	2.46	13.96	2.52	11.01	2.81	9.24	2.98	8.74	3.00	6.74	3.08
3.5 + 3.5 + 3.5 + 3.5	16	14.72	2.23	14.42	2.29	12.91	2.57	12.00	2.74	11.41	2.78	9.06	2.95
	18	14.11	2.33	13.80	2.38	12.23	2.65	11.29	2.81	10.75	2.85	8.56	3.00
	20	13.90	2.39	13.53	2.44	11.70	2.71	10.60	2.87	10.08	2.90	8.01	3.02
	21	13.92	2.41	13.51	2.45	11.45	2.66	10.21	2.78	9.71	2.83	7.72	3.03
	22	14.04	2.43	13.65	2.49	11.72	2.76	10.56	2.92	9.93	2.95	7.40	3.04
	24	14.55	2.45	13.96	2.51	11.01	2.80	9.24	2.97	8.74	2.99	6.74	3.07
3.5 + 3.5 + 3.5 + 4.2	16	14.72	2.23	14.42	2.28	12.91	2.56	12.00	2.73	11.41	2.77	9.06	2.93
	18	14.11	2.32	13.80	2.37	12.23	2.64	11.29	2.80	10.75	2.84	8.56	2.99
	20	13.90	2.38	13.53	2.43	11.70	2.70	10.60	2.86	10.08	2.89	8.01	3.01
	21	13.92	2.41	13.51	2.45	11.45	2.65	10.21	2.77	9.71	2.82	7.72	3.02
	22	14.04	2.42	13.65	2.48	11.72	2.75	10.56	2.91	9.93	2.94	7.40	3.03
	24	14.55	2.45	13.96	2.50	11.01	2.79	9.24	2.96	8.74	2.98	6.74	3.06



Combination (Capacity)	Indoor Air Temp. °C DB	Outdoor Air Temp. °C									
		0/-1		-5/-6		-7/-8		-10/-11		-15/-	
		Total Q	Input Power	Total Q	Input Power	Total Q	Input Power	Total Q	Input Power	Total Q	Input Power
2.5 + 3.5 + 3.5 + 4.2	16	8.80	2.93	8.13	2.83	7.87	2.80	7.56	2.70	7.05	2.54
	18	8.33	2.98	7.76	2.86	7.53	2.81	7.41	2.73	7.22	2.59
	20	7.86	2.99	7.46	2.87	7.31	2.83	7.28	2.76	7.24	2.66
	21	7.53	3.00	7.07	2.89	6.89	2.84	7.00	2.78	7.19	2.69
	22	7.36	3.02	7.25	2.90	7.21	2.85	7.17	2.80	7.10	2.72
	24	6.85	3.05	7.11	2.94	7.22	2.89	7.07	2.85	6.82	2.79
2.5 + 3.5 + 3.5 + 5.0	16	8.80	2.89	8.13	2.79	7.87	2.76	7.56	2.66	7.05	2.50
	18	8.33	2.93	7.76	2.82	7.53	2.77	7.41	2.69	7.22	2.55
	20	7.86	2.95	7.46	2.83	7.31	2.79	7.28	2.73	7.24	2.62
	21	7.53	2.96	7.07	2.85	6.89	2.80	7.00	2.75	7.19	2.65
	22	7.36	2.98	7.25	2.86	7.21	2.81	7.17	2.77	7.10	2.68
	24	6.85	3.01	7.11	2.89	7.22	2.85	7.07	2.81	6.82	2.75
2.5 + 3.5 + 4.2 + 4.2	16	8.80	2.92	8.13	2.82	7.87	2.79	7.56	2.69	7.05	2.53
	18	8.33	2.97	7.76	2.85	7.53	2.80	7.41	2.72	7.22	2.58
	20	7.86	2.98	7.46	2.86	7.31	2.82	7.28	2.75	7.24	2.65
	21	7.53	2.99	7.07	2.88	6.89	2.83	7.00	2.77	7.19	2.68
	22	7.36	3.01	7.25	2.89	7.21	2.84	7.17	2.79	7.10	2.71
	24	6.85	3.04	7.11	2.93	7.22	2.88	7.07	2.84	6.82	2.78
3.5 + 3.5 + 3.5 + 3.5	16	8.80	2.91	8.13	2.81	7.87	2.78	7.56	2.68	7.05	2.52
	18	8.33	2.96	7.76	2.84	7.53	2.79	7.41	2.71	7.22	2.57
	20	7.86	2.97	7.46	2.85	7.31	2.81	7.28	2.75	7.24	2.64
	21	7.53	2.98	7.07	2.87	6.89	2.82	7.00	2.76	7.19	2.67
	22	7.36	3.00	7.25	2.88	7.21	2.83	7.17	2.78	7.10	2.70
	24	6.85	3.03	7.11	2.92	7.22	2.87	7.07	2.83	6.82	2.77
3.5 + 3.5 + 3.5 + 4.2	16	8.80	2.90	8.13	2.80	7.87	2.77	7.56	2.67	7.05	2.51
	18	8.33	2.95	7.76	2.83	7.53	2.78	7.41	2.70	7.22	2.56
	20	7.86	2.96	7.46	2.84	7.31	2.80	7.28	2.74	7.24	2.63
	21	7.53	2.97	7.07	2.86	6.89	2.81	7.00	2.76	7.19	2.66
	22	7.36	2.99	7.25	2.87	7.21	2.82	7.17	2.78	7.10	2.69
	24	6.85	3.02	7.11	2.91	7.22	2.86	7.07	2.82	6.82	2.76

Total Q: Total Heating Capacity (kW)  
Input Power (kW)

## 18.2.2 CU-5Z90TBE

Combination (Capacity)	Indoor Air Temp. °C DB	Outdoor Air Temp. °C											
		16/15		15/14		10/9		7/6		6/5		2/1	
		Total Q	Input Power	Total Q	Input Power	Total Q	Input Power	Total Q	Input Power	Total Q	Input Power	Total Q	Input Power
1.6	16	3.95	0.79	3.89	0.81	3.59	0.89	3.41	0.94	3.42	0.98	3.39	1.16
	18	3.84	0.81	3.78	0.82	3.49	0.90	3.31	0.95	3.35	0.99	3.42	1.14
	20	3.73	0.82	3.68	0.84	3.38	0.91	3.20	0.96	3.25	1.00	3.39	1.14
	21	3.68	0.84	3.62	0.85	3.31	0.92	3.13	0.97	3.19	1.00	3.36	1.15
	22	3.62	0.85	3.56	0.86	3.24	0.93	3.05	0.97	3.12	1.01	3.33	1.17
	24	3.51	0.87	3.44	0.88	3.08	0.93	2.87	0.97	2.96	1.02	3.23	1.21
2.0	16	5.06	1.01	4.98	1.03	4.60	1.14	4.36	1.20	4.38	1.26	4.35	1.49
	18	4.92	1.03	4.85	1.05	4.47	1.15	4.25	1.21	4.29	1.26	4.39	1.46
	20	4.78	1.06	4.71	1.08	4.33	1.17	4.10	1.23	4.16	1.28	4.35	1.46
	21	4.72	1.07	4.64	1.09	4.25	1.18	4.01	1.24	4.09	1.28	4.31	1.47
	22	4.64	1.09	4.56	1.10	4.16	1.19	3.91	1.24	4.00	1.29	4.26	1.49
	24	4.49	1.12	4.40	1.13	3.95	1.20	3.68	1.24	3.79	1.30	4.14	1.55
2.5	16	5.31	1.01	5.22	1.03	4.82	1.14	4.58	1.20	4.59	1.26	4.56	1.49
	18	5.16	1.03	5.08	1.05	4.69	1.15	4.45	1.21	4.50	1.26	4.60	1.46
	20	5.02	1.06	4.94	1.08	4.54	1.17	4.30	1.23	4.37	1.28	4.56	1.46
	21	4.95	1.07	4.86	1.09	4.45	1.18	4.21	1.24	4.29	1.28	4.52	1.47
	22	4.86	1.09	4.78	1.10	4.36	1.19	4.11	1.24	4.20	1.29	4.47	1.49
	24	4.71	1.12	4.62	1.13	4.14	1.20	3.86	1.24	3.97	1.30	4.34	1.55
3.5	16	7.16	1.73	7.05	1.76	6.50	1.94	6.17	2.05	6.20	2.15	6.15	2.54
	18	6.96	1.77	6.86	1.80	6.33	1.97	6.01	2.07	6.07	2.16	6.21	2.49
	20	6.77	1.80	6.66	1.84	6.12	2.00	5.80	2.10	5.89	2.18	6.15	2.49
	21	6.67	1.83	6.56	1.86	6.01	2.02	5.68	2.11	5.78	2.19	6.09	2.51
	22	6.56	1.86	6.45	1.88	5.88	2.03	5.54	2.11	5.66	2.20	6.03	2.55
	24	6.35	1.91	6.23	1.93	5.59	2.04	5.20	2.11	5.36	2.22	5.86	2.65
4.2	16	8.39	2.41	8.26	2.46	7.62	2.71	7.24	2.86	7.26	2.99	7.21	3.54
	18	8.16	2.46	8.04	2.51	7.42	2.75	7.04	2.89	7.11	3.01	7.28	3.47
	20	7.94	2.52	7.81	2.56	7.18	2.79	6.80	2.93	6.91	3.04	7.21	3.47
	21	7.82	2.55	7.69	2.60	7.04	2.82	6.65	2.95	6.78	3.06	7.14	3.51
	22	7.69	2.59	7.56	2.63	6.89	2.83	6.49	2.95	6.63	3.07	7.07	3.56
	24	7.45	2.66	7.30	2.69	6.55	2.85	6.10	2.95	6.28	3.10	6.87	3.70
5.0	16	8.51	2.07	8.38	2.11	7.73	2.33	7.34	2.46	7.37	2.58	7.31	3.05
	18	8.28	2.12	8.16	2.16	7.53	2.37	7.15	2.49	7.22	2.59	7.38	2.98
	20	8.05	2.16	7.92	2.20	7.28	2.40	6.90	2.52	7.01	2.61	7.31	2.98
	21	7.94	2.20	7.81	2.23	7.15	2.42	6.75	2.54	6.88	2.63	7.25	3.01
	22	7.81	2.23	7.67	2.26	6.99	2.43	6.59	2.54	6.73	2.64	7.18	3.06
	24	7.56	2.29	7.41	2.32	6.65	2.45	6.19	2.54	6.38	2.67	6.97	3.18

Combination (Capacity)	Indoor Air Temp. °C DB	Outdoor Air Temp. °C									
		0/-1		-5/-6		-7/-8		-10/-11		-15/-	
		Total Q	Input Power	Total Q	Input Power	Total Q	Input Power	Total Q	Input Power	Total Q	Input Power
1.6	16	3.28	1.12	2.80	1.03	2.60	1.00	2.24	0.99	1.63	0.98
	18	3.25	1.11	2.70	1.04	2.42	1.01	2.17	0.99	1.67	0.97
	20	3.21	1.11	2.60	1.05	2.35	1.02	2.10	1.00	1.68	0.97
	21	3.18	1.12	2.55	1.06	2.30	1.03	2.06	1.01	1.67	0.97
	22	3.14	1.14	2.50	1.07	2.25	1.04	2.02	1.01	1.65	0.97
	24	3.04	1.18	2.41	1.10	2.15	1.07	1.94	1.04	1.59	0.98
2.0	16	4.20	1.44	3.58	1.32	3.34	1.28	2.87	1.27	2.08	1.26
	18	4.17	1.42	3.46	1.33	3.10	1.29	2.79	1.27	2.14	1.25
	20	4.11	1.42	3.33	1.34	3.01	1.31	2.69	1.28	2.15	1.24
	21	4.07	1.44	3.27	1.35	2.95	1.32	2.64	1.29	2.14	1.24
	22	4.02	1.46	3.20	1.36	2.88	1.33	2.59	1.30	2.11	1.25
	24	3.90	1.51	3.09	1.41	2.76	1.37	2.49	1.33	2.04	1.26
2.5	16	4.40	1.44	3.76	1.32	3.50	1.28	3.01	1.27	2.19	1.26
	18	4.37	1.42	3.62	1.33	3.25	1.29	2.92	1.27	2.25	1.25
	20	4.31	1.42	3.49	1.34	3.16	1.31	2.82	1.28	2.26	1.24
	21	4.27	1.44	3.43	1.35	3.09	1.32	2.77	1.29	2.25	1.24
	22	4.21	1.46	3.36	1.36	3.02	1.33	2.72	1.30	2.22	1.25
	24	4.09	1.51	3.24	1.41	2.89	1.37	2.61	1.33	2.13	1.26
3.5	16	5.94	2.46	5.07	2.26	4.72	2.18	4.06	2.17	2.95	2.15
	18	5.90	2.42	4.89	2.27	4.39	2.20	3.94	2.17	3.03	2.13
	20	5.81	2.43	4.71	2.29	4.26	2.23	3.81	2.19	3.05	2.11
	21	5.76	2.46	4.62	2.31	4.17	2.25	3.74	2.20	3.03	2.11
	22	5.68	2.49	4.53	2.33	4.07	2.27	3.66	2.21	2.99	2.13
	24	5.52	2.58	4.36	2.40	3.90	2.33	3.52	2.26	2.88	2.15
4.2	16	6.96	3.43	5.94	3.15	5.53	3.04	4.76	3.02	3.46	3.00
	18	6.91	3.38	5.73	3.16	5.15	3.07	4.62	3.03	3.55	2.97
	20	6.82	3.39	5.52	3.19	5.00	3.11	4.46	3.05	3.57	2.95
	21	6.75	3.43	5.42	3.23	4.88	3.15	4.39	3.07	3.55	2.95
	22	6.66	3.47	5.31	3.25	4.77	3.16	4.30	3.09	3.51	2.97
	24	6.47	3.60	5.12	3.35	4.58	3.25	4.13	3.16	3.38	3.00
5.0	16	7.06	2.95	6.03	2.71	5.62	2.61	4.83	2.60	3.51	2.58
	18	7.01	2.91	5.81	2.72	5.22	2.64	4.69	2.61	3.61	2.55
	20	6.92	2.92	5.60	2.74	5.07	2.67	4.53	2.62	3.62	2.54
	21	6.85	2.95	5.50	2.77	4.96	2.71	4.45	2.64	3.61	2.54
	22	6.76	2.99	5.39	2.80	4.84	2.72	4.36	2.66	3.56	2.55
	24	6.57	3.10	5.19	2.88	4.64	2.80	4.19	2.72	3.43	2.58

Combination (Capacity)	Indoor Air Temp. °C DB	Outdoor Air Temp. °C											
		16/15		15/14		10/9		7/6		6/5		2/1	
		Total Q	Input Power	Total Q	Input Power	Total Q	Input Power	Total Q	Input Power	Total Q	Input Power	Total Q	Input Power
6.0	16	11.11	2.10	10.94	2.14	10.09	2.36	9.58	2.49	9.61	2.61	9.54	3.08
	18	10.80	2.14	10.64	2.18	9.82	2.39	9.32	2.52	9.41	2.62	9.63	3.02
	20	10.50	2.19	10.34	2.23	9.50	2.43	9.00	2.55	9.14	2.64	9.54	3.02
	21	10.35	2.22	10.18	2.26	9.32	2.45	8.81	2.57	8.97	2.66	9.45	3.05
	22	10.18	2.25	10.00	2.29	9.12	2.46	8.59	2.57	8.78	2.67	9.36	3.10
	24	9.86	2.32	9.66	2.34	8.67	2.48	8.08	2.57	8.32	2.70	9.09	3.22
7.1	16	11.35	2.24	11.18	2.28	10.31	2.51	9.79	2.65	9.83	2.78	9.75	3.29
	18	11.04	2.29	10.88	2.33	10.03	2.55	9.53	2.69	9.62	2.79	9.84	3.22
	20	10.74	2.34	10.57	2.38	9.71	2.59	9.20	2.72	9.34	2.82	9.75	3.22
	21	10.58	2.37	10.41	2.41	9.53	2.61	9.00	2.74	9.17	2.84	9.66	3.25
	22	10.41	2.40	10.23	2.44	9.32	2.63	8.78	2.74	8.98	2.85	9.57	3.30
	24	10.08	2.47	9.88	2.50	8.86	2.65	8.26	2.74	8.50	2.88	9.29	3.44
1.6 + 1.6	16	11.81	1.95	11.59	1.99	10.47	2.21	9.80	2.34	9.17	2.44	7.26	2.68
	18	11.25	2.02	10.99	2.06	9.71	2.26	8.94	2.38	8.38	2.49	6.87	2.76
	20	10.89	2.09	10.59	2.13	9.10	2.30	8.20	2.41	7.68	2.51	6.44	2.76
	21	10.75	2.13	10.43	2.16	8.83	2.29	7.86	2.37	7.36	2.48	6.22	2.77
	22	10.66	2.17	10.44	2.20	9.34	2.34	8.68	2.43	7.97	2.53	5.97	2.78
	24	10.60	2.25	10.20	2.27	8.23	2.38	7.04	2.45	6.56	2.56	5.46	2.80
1.6 + 2.0	16	11.81	1.94	11.59	1.99	10.47	2.20	9.80	2.33	9.17	2.43	7.26	2.67
	18	11.25	2.01	10.99	2.05	9.71	2.25	8.94	2.37	8.38	2.48	6.87	2.75
	20	10.89	2.08	10.59	2.12	9.10	2.29	8.20	2.40	7.68	2.50	6.44	2.75
	21	10.75	2.12	10.43	2.15	8.83	2.28	7.86	2.36	7.36	2.47	6.22	2.76
	22	10.66	2.16	10.44	2.19	9.34	2.33	8.68	2.42	7.97	2.52	5.97	2.77
	24	10.60	2.24	10.20	2.26	8.23	2.37	7.04	2.44	6.56	2.55	5.46	2.78
1.6 + 2.5	16	11.81	1.94	11.59	1.99	10.47	2.20	9.80	2.33	9.17	2.43	7.26	2.67
	18	11.25	2.01	10.99	2.05	9.71	2.25	8.94	2.37	8.38	2.48	6.87	2.75
	20	10.89	2.08	10.59	2.12	9.10	2.29	8.20	2.40	7.68	2.50	6.44	2.75
	21	10.75	2.12	10.43	2.15	8.83	2.28	7.86	2.36	7.36	2.47	6.22	2.76
	22	10.66	2.16	10.44	2.19	9.34	2.33	8.68	2.42	7.97	2.52	5.97	2.77
	24	10.60	2.24	10.20	2.26	8.23	2.37	7.04	2.44	6.56	2.55	5.46	2.78
1.6 + 3.5	16	12.39	2.01	12.15	2.05	10.98	2.27	10.28	2.41	9.62	2.51	7.61	2.76
	18	11.80	2.08	11.53	2.12	10.18	2.33	9.38	2.45	8.78	2.56	7.20	2.84
	20	11.42	2.15	11.11	2.19	9.54	2.37	8.60	2.48	8.05	2.59	6.76	2.84
	21	11.28	2.19	10.94	2.22	9.26	2.36	8.25	2.44	7.72	2.56	6.52	2.85
	22	11.18	2.23	10.95	2.26	9.80	2.41	9.11	2.50	8.36	2.61	6.27	2.86
	24	11.11	2.32	10.70	2.34	8.63	2.45	7.38	2.52	6.88	2.63	5.72	2.88

Combination (Capacity)	Indoor Air Temp. °C DB	Outdoor Air Temp. °C									
		0/-1		-5/-6		-7/-8		-10/-11		-15/-	
		Total Q	Input Power	Total Q	Input Power	Total Q	Input Power	Total Q	Input Power	Total Q	Input Power
6.0	16	9.21	2.98	7.86	2.74	7.32	2.64	6.29	2.63	4.58	2.61
	18	9.15	2.94	7.58	2.75	6.81	2.68	6.11	2.64	4.70	2.58
	20	9.02	2.95	7.30	2.78	6.62	2.71	5.91	2.65	4.73	2.57
	21	8.94	2.98	7.17	2.81	6.47	2.74	5.80	2.67	4.70	2.57
	22	8.82	3.02	7.03	2.83	6.32	2.75	5.69	2.69	4.64	2.58
	24	8.56	3.14	6.77	2.92	6.06	2.83	5.46	2.75	4.47	2.61
7.1	16	9.42	3.18	8.04	2.92	7.49	2.82	6.43	2.81	4.68	2.79
	18	9.35	3.14	7.75	2.94	6.96	2.85	6.25	2.82	4.81	2.75
	20	9.22	3.15	7.47	2.96	6.76	2.89	6.04	2.83	4.83	2.74
	21	9.14	3.18	7.33	2.99	6.61	2.92	5.93	2.85	4.81	2.74
	22	9.02	3.22	7.19	3.02	6.46	2.94	5.81	2.87	4.74	2.75
	24	8.75	3.34	6.92	3.11	6.19	3.02	5.58	2.93	4.57	2.79
1.6 + 1.6	16	7.05	2.69	6.54	2.73	6.33	2.74	6.10	2.61	5.59	2.56
	18	6.69	2.75	6.25	2.72	5.82	2.71	5.98	2.60	5.64	2.55
	20	6.32	2.75	6.02	2.71	5.90	2.69	5.88	2.61	5.56	2.55
	21	6.07	2.75	5.72	2.71	5.57	2.69	5.66	2.62	5.47	2.58
	22	5.94	2.76	5.86	2.71	5.82	2.69	5.79	2.63	5.33	2.58
	24	5.54	2.80	5.75	2.74	5.83	2.71	5.71	2.67	4.98	2.63
1.6 + 2.0	16	7.05	2.68	6.54	2.72	6.33	2.73	6.10	2.60	5.59	2.55
	18	6.69	2.74	6.25	2.71	5.82	2.70	5.98	2.58	5.64	2.54
	20	6.32	2.73	6.02	2.70	5.90	2.68	5.88	2.60	5.56	2.54
	21	6.07	2.74	5.72	2.70	5.57	2.68	5.66	2.61	5.47	2.57
	22	5.94	2.75	5.86	2.70	5.82	2.68	5.79	2.62	5.33	2.57
	24	5.54	2.79	5.75	2.72	5.83	2.70	5.71	2.66	4.98	2.62
1.6 + 2.5	16	7.05	2.68	6.54	2.72	6.33	2.73	6.10	2.60	5.59	2.55
	18	6.69	2.74	6.25	2.71	5.82	2.70	5.98	2.58	5.64	2.54
	20	6.32	2.73	6.02	2.70	5.90	2.68	5.88	2.60	5.56	2.54
	21	6.07	2.74	5.72	2.70	5.57	2.68	5.66	2.61	5.47	2.57
	22	5.94	2.75	5.86	2.70	5.82	2.68	5.79	2.62	5.33	2.57
	24	5.54	2.79	5.75	2.72	5.83	2.70	5.71	2.66	4.98	2.62
1.6 + 3.5	16	7.40	2.77	6.86	2.81	6.64	2.82	6.39	2.69	5.86	2.63
	18	7.02	2.83	6.55	2.80	6.10	2.79	6.27	2.67	5.91	2.63
	20	6.63	2.83	6.31	2.79	6.19	2.77	6.17	2.68	5.83	2.63
	21	6.37	2.83	6.00	2.79	5.85	2.77	5.94	2.69	5.73	2.65
	22	6.23	2.84	6.14	2.79	6.11	2.77	6.07	2.71	5.59	2.65
	24	5.81	2.88	6.03	2.82	6.12	2.79	5.99	2.75	5.23	2.70

Combination (Capacity)	Indoor Air Temp. °C DB	Outdoor Air Temp. °C											
		16/15		15/14		10/9		7/6		6/5		2/1	
		Total Q	Input Power	Total Q	Input Power	Total Q	Input Power	Total Q	Input Power	Total Q	Input Power	Total Q	Input Power
1.6 + 4.2	16	14.55	2.45	14.27	2.51	12.89	2.78	12.07	2.94	11.29	3.07	8.94	3.37
	18	13.85	2.54	13.54	2.59	11.96	2.84	11.01	2.99	10.32	3.13	8.46	3.47
	20	13.41	2.63	13.04	2.67	11.20	2.90	10.10	3.03	9.46	3.16	7.94	3.47
	21	13.24	2.68	12.85	2.71	10.87	2.88	9.68	2.98	9.07	3.12	7.66	3.48
	22	13.13	2.73	12.86	2.76	11.51	2.95	10.70	3.06	9.82	3.19	7.36	3.50
	24	13.05	2.83	12.56	2.86	10.13	3.00	8.67	3.08	8.09	3.22	6.72	3.51
1.6 + 5.0	16	15.84	2.46	15.54	2.51	14.04	2.79	13.14	2.95	12.30	3.08	9.74	3.38
	18	15.09	2.55	14.75	2.60	13.03	2.85	12.00	3.00	11.24	3.14	9.21	3.48
	20	14.61	2.64	14.21	2.68	12.20	2.91	11.00	3.04	10.30	3.17	8.64	3.48
	21	14.43	2.69	13.99	2.72	11.84	2.89	10.55	2.99	9.87	3.13	8.34	3.50
	22	14.30	2.74	14.01	2.77	12.53	2.96	11.65	3.07	10.69	3.20	8.01	3.51
	24	14.21	2.84	13.68	2.87	11.04	3.01	9.45	3.09	8.81	3.23	7.32	3.53
1.6 + 6.0	16	15.84	2.46	15.54	2.51	14.04	2.79	13.14	2.95	12.30	3.08	9.74	3.38
	18	15.09	2.55	14.75	2.60	13.03	2.85	12.00	3.00	11.24	3.14	9.21	3.48
	20	14.61	2.64	14.21	2.68	12.20	2.91	11.00	3.04	10.30	3.17	8.64	3.48
	21	14.43	2.69	13.99	2.72	11.84	2.89	10.55	2.99	9.87	3.13	8.34	3.50
	22	14.30	2.74	14.01	2.77	12.53	2.96	11.65	3.07	10.69	3.20	8.01	3.51
	24	14.21	2.84	13.68	2.87	11.04	3.01	9.45	3.09	8.81	3.23	7.32	3.53
1.6 + 7.1	16	18.72	3.10	18.37	3.17	16.60	3.51	15.53	3.72	14.54	3.88	11.51	4.26
	18	17.83	3.21	17.43	3.27	15.40	3.59	14.18	3.78	13.28	3.96	10.89	4.39
	20	17.26	3.32	16.79	3.38	14.42	3.66	13.00	3.83	12.18	4.00	10.22	4.39
	21	17.05	3.39	16.54	3.43	13.99	3.64	12.47	3.77	11.67	3.95	9.86	4.40
	22	16.91	3.45	16.56	3.49	14.81	3.72	13.77	3.86	12.64	4.03	9.47	4.42
	24	16.80	3.58	16.17	3.61	13.04	3.79	11.16	3.89	10.41	4.07	8.65	4.44
2.0 + 2.0	16	11.81	1.93	11.59	1.98	10.47	2.19	9.80	2.32	9.17	2.42	7.26	2.66
	18	11.25	2.00	10.99	2.04	9.71	2.24	8.94	2.36	8.38	2.47	6.87	2.74
	20	10.89	2.07	10.59	2.11	9.10	2.28	8.20	2.39	7.68	2.49	6.44	2.74
	21	10.75	2.11	10.43	2.14	8.83	2.27	7.86	2.35	7.36	2.46	6.22	2.75
	22	10.66	2.15	10.44	2.18	9.34	2.32	8.68	2.41	7.97	2.51	5.97	2.76
	24	10.60	2.23	10.20	2.25	8.23	2.36	7.04	2.43	6.56	2.54	5.46	2.77
2.0 + 2.5	16	11.81	1.93	11.59	1.98	10.47	2.19	9.80	2.32	9.17	2.42	7.26	2.66
	18	11.25	2.00	10.99	2.04	9.71	2.24	8.94	2.36	8.38	2.47	6.87	2.74
	20	10.89	2.07	10.59	2.11	9.10	2.28	8.20	2.39	7.68	2.49	6.44	2.74
	21	10.75	2.11	10.43	2.14	8.83	2.27	7.86	2.35	7.36	2.46	6.22	2.75
	22	10.66	2.15	10.44	2.18	9.34	2.32	8.68	2.41	7.97	2.51	5.97	2.76
	24	10.60	2.23	10.20	2.25	8.23	2.36	7.04	2.43	6.56	2.54	5.46	2.77

Combination (Capacity)	Indoor Air Temp. °C DB	Outdoor Air Temp. °C									
		0/-1		-5/-6		-7/-8		-10/-11		-15/-	
		Total Q	Input Power	Total Q	Input Power	Total Q	Input Power	Total Q	Input Power	Total Q	Input Power
1.6 + 4.2	16	8.69	3.39	8.05	3.43	7.80	3.45	7.51	3.28	6.89	3.22
	18	8.24	3.46	7.69	3.42	7.17	3.41	7.37	3.26	6.94	3.21
	20	7.79	3.45	7.41	3.40	7.26	3.38	7.24	3.28	6.84	3.21
	21	7.48	3.46	7.04	3.41	6.87	3.38	6.97	3.29	6.73	3.24
	22	7.32	3.47	7.21	3.41	7.17	3.38	7.13	3.31	6.57	3.24
	24	6.83	3.52	7.08	3.44	7.18	3.41	7.04	3.36	6.14	3.30
1.6 + 5.0	16	9.46	3.40	8.77	3.44	8.50	3.46	8.18	3.29	7.50	3.23
	18	8.98	3.47	8.38	3.43	7.81	3.42	8.02	3.27	7.56	3.22
	20	8.48	3.46	8.07	3.41	7.91	3.39	7.89	3.29	7.45	3.22
	21	8.15	3.47	7.67	3.42	7.48	3.39	7.59	3.30	7.33	3.25
	22	7.97	3.48	7.86	3.42	7.81	3.39	7.77	3.32	7.15	3.25
	24	7.43	3.53	7.71	3.45	7.82	3.42	7.67	3.37	6.68	3.31
1.6 + 6.0	16	9.46	3.40	8.77	3.44	8.50	3.46	8.18	3.29	7.50	3.23
	18	8.98	3.47	8.38	3.43	7.81	3.42	8.02	3.27	7.56	3.22
	20	8.48	3.46	8.07	3.41	7.91	3.39	7.89	3.29	7.45	3.22
	21	8.15	3.47	7.67	3.42	7.48	3.39	7.59	3.30	7.33	3.25
	22	7.97	3.48	7.86	3.42	7.81	3.39	7.77	3.32	7.15	3.25
	24	7.43	3.53	7.71	3.45	7.82	3.42	7.67	3.37	6.68	3.31
1.6 + 7.1	16	11.18	4.28	10.37	4.34	10.04	4.36	9.66	4.15	8.86	4.07
	18	10.61	4.37	9.90	4.33	9.23	4.31	9.48	4.12	8.93	4.06
	20	10.02	4.36	9.54	4.30	9.35	4.28	9.32	4.15	8.81	4.06
	21	9.63	4.38	9.06	4.31	8.84	4.28	8.98	4.16	8.67	4.10
	22	9.42	4.39	9.28	4.31	9.23	4.28	9.18	4.18	8.45	4.10
	24	8.79	4.44	9.11	4.35	9.25	4.31	9.06	4.25	7.90	4.17
2.0 + 2.0	16	7.05	2.67	6.54	2.71	6.33	2.72	6.10	2.59	5.59	2.54
	18	6.69	2.73	6.25	2.70	5.82	2.69	5.98	2.57	5.64	2.53
	20	6.32	2.72	6.02	2.68	5.90	2.67	5.88	2.59	5.56	2.53
	21	6.07	2.73	5.72	2.69	5.57	2.67	5.66	2.59	5.47	2.56
	22	5.94	2.74	5.86	2.69	5.82	2.67	5.79	2.61	5.33	2.56
	24	5.54	2.77	5.75	2.71	5.83	2.69	5.71	2.65	4.98	2.61
2.0 + 2.5	16	7.05	2.67	6.54	2.71	6.33	2.72	6.10	2.59	5.59	2.54
	18	6.69	2.73	6.25	2.70	5.82	2.69	5.98	2.57	5.64	2.53
	20	6.32	2.72	6.02	2.68	5.90	2.67	5.88	2.59	5.56	2.53
	21	6.07	2.73	5.72	2.69	5.57	2.67	5.66	2.59	5.47	2.56
	22	5.94	2.74	5.86	2.69	5.82	2.67	5.79	2.61	5.33	2.56
	24	5.54	2.77	5.75	2.71	5.83	2.69	5.71	2.65	4.98	2.61

Combination (Capacity)	Indoor Air Temp. °C DB	Outdoor Air Temp. °C											
		16/15		15/14		10/9		7/6		6/5		2/1	
		Total Q	Input Power	Total Q	Input Power	Total Q	Input Power	Total Q	Input Power	Total Q	Input Power	Total Q	Input Power
2.0 + 3.5	16	12.39	1.96	12.15	2.00	10.98	2.22	10.28	2.35	9.62	2.45	7.61	2.69
	18	11.80	2.03	11.53	2.07	10.18	2.27	9.38	2.39	8.78	2.50	7.20	2.77
	20	11.42	2.10	11.11	2.13	9.54	2.31	8.60	2.42	8.05	2.52	6.76	2.77
	21	11.28	2.14	10.94	2.17	9.26	2.30	8.25	2.38	7.72	2.49	6.52	2.78
	22	11.18	2.18	10.95	2.21	9.80	2.35	9.11	2.44	8.36	2.54	6.27	2.79
	24	11.11	2.26	10.70	2.28	8.63	2.39	7.38	2.46	6.88	2.57	5.72	2.81
2.0 + 4.2	16	15.84	2.61	15.54	2.67	14.04	2.96	13.14	3.14	12.30	3.27	9.74	3.59
	18	15.09	2.71	14.75	2.76	13.03	3.03	12.00	3.19	11.24	3.34	9.21	3.70
	20	14.61	2.80	14.21	2.85	12.20	3.09	11.00	3.23	10.30	3.37	8.64	3.70
	21	14.43	2.85	13.99	2.89	11.84	3.07	10.55	3.18	9.87	3.33	8.34	3.71
	22	14.30	2.91	14.01	2.95	12.53	3.14	11.65	3.26	10.69	3.40	8.01	3.73
	24	14.21	3.02	13.68	3.05	11.04	3.19	9.45	3.28	8.81	3.43	7.32	3.75
2.0 + 5.0	16	15.84	2.41	15.54	2.46	14.04	2.73	13.14	2.89	12.30	3.02	9.74	3.32
	18	15.09	2.50	14.75	2.55	13.03	2.79	12.00	2.94	11.24	3.08	9.21	3.41
	20	14.61	2.58	14.21	2.63	12.20	2.85	11.00	2.98	10.30	3.11	8.64	3.41
	21	14.43	2.63	13.99	2.67	11.84	2.83	10.55	2.93	9.87	3.07	8.34	3.43
	22	14.30	2.68	14.01	2.72	12.53	2.90	11.65	3.00	10.69	3.13	8.01	3.44
	24	14.21	2.78	13.68	2.81	11.04	2.95	9.45	3.03	8.81	3.16	7.32	3.46
2.0 + 6.0	16	17.14	2.69	16.82	2.75	15.19	3.05	14.22	3.23	13.31	3.37	10.53	3.70
	18	16.32	2.79	15.95	2.85	14.09	3.12	12.98	3.29	12.15	3.44	9.97	3.82
	20	15.80	2.89	15.37	2.94	13.20	3.18	11.90	3.33	11.15	3.47	9.35	3.82
	21	15.61	2.94	15.14	2.98	12.81	3.16	11.41	3.28	10.68	3.43	9.02	3.83
	22	15.47	3.00	15.16	3.04	13.56	3.24	12.60	3.36	11.57	3.50	8.67	3.84
	24	15.38	3.11	14.80	3.14	11.94	3.29	10.22	3.39	9.53	3.53	7.92	3.86
2.0 + 7.1	16	18.72	3.09	18.37	3.16	16.60	3.50	15.53	3.71	14.54	3.87	11.51	4.25
	18	17.83	3.20	17.43	3.27	15.40	3.58	14.18	3.77	13.28	3.95	10.89	4.38
	20	17.26	3.31	16.79	3.37	14.42	3.65	13.00	3.82	12.18	3.98	10.22	4.38
	21	17.05	3.38	16.54	3.42	13.99	3.63	12.47	3.76	11.67	3.94	9.86	4.39
	22	16.91	3.44	16.56	3.49	14.81	3.71	13.77	3.85	12.64	4.02	9.47	4.41
	24	16.80	3.57	16.17	3.60	13.04	3.78	11.16	3.88	10.41	4.05	8.65	4.43
2.5 + 2.5	16	12.39	2.02	12.15	2.07	10.98	2.29	10.28	2.43	9.62	2.53	7.61	2.78
	18	11.80	2.10	11.53	2.14	10.18	2.34	9.38	2.47	8.78	2.58	7.20	2.86
	20	11.42	2.17	11.11	2.20	9.54	2.39	8.60	2.50	8.05	2.61	6.76	2.86
	21	11.28	2.21	10.94	2.24	9.26	2.38	8.25	2.46	7.72	2.58	6.52	2.87
	22	11.18	2.25	10.95	2.28	9.80	2.43	9.11	2.52	8.36	2.63	6.27	2.89
	24	11.11	2.33	10.70	2.36	8.63	2.47	7.38	2.54	6.88	2.65	5.72	2.90



Combination (Capacity)	Indoor Air Temp. °C DB	Outdoor Air Temp. °C									
		0/-1		-5/-6		-7/-8		-10/-11		-15/-	
		Total Q	Input Power	Total Q	Input Power	Total Q	Input Power	Total Q	Input Power	Total Q	Input Power
2.0 + 3.5	16	7.40	2.71	6.86	2.74	6.64	2.75	6.39	2.62	5.86	2.57
	18	7.02	2.76	6.55	2.73	6.10	2.72	6.27	2.61	5.91	2.57
	20	6.63	2.76	6.31	2.72	6.19	2.70	6.17	2.62	5.83	2.57
	21	6.37	2.76	6.00	2.72	5.85	2.70	5.94	2.63	5.73	2.59
	22	6.23	2.77	6.14	2.72	6.11	2.70	6.07	2.64	5.59	2.59
	24	5.81	2.81	6.03	2.75	6.12	2.72	5.99	2.68	5.23	2.64
2.0 + 4.2	16	9.46	3.61	8.77	3.66	8.50	3.67	8.18	3.50	7.50	3.43
	18	8.98	3.69	8.38	3.65	7.81	3.63	8.02	3.48	7.56	3.42
	20	8.48	3.68	8.07	3.63	7.91	3.61	7.89	3.50	7.45	3.42
	21	8.15	3.69	7.67	3.63	7.48	3.61	7.59	3.51	7.33	3.46
	22	7.97	3.70	7.86	3.63	7.81	3.61	7.77	3.53	7.15	3.46
	24	7.43	3.75	7.71	3.67	7.82	3.63	7.67	3.58	6.68	3.52
2.0 + 5.0	16	9.46	3.33	8.77	3.37	8.50	3.39	8.18	3.23	7.50	3.17
	18	8.98	3.40	8.38	3.37	7.81	3.35	8.02	3.21	7.56	3.16
	20	8.48	3.40	8.07	3.35	7.91	3.33	7.89	3.23	7.45	3.16
	21	8.15	3.40	7.67	3.35	7.48	3.33	7.59	3.24	7.33	3.19
	22	7.97	3.41	7.86	3.35	7.81	3.33	7.77	3.25	7.15	3.19
	24	7.43	3.46	7.71	3.38	7.82	3.35	7.67	3.31	6.68	3.25
2.0 + 6.0	16	10.23	3.72	9.49	3.77	9.19	3.79	8.85	3.61	8.11	3.54
	18	9.71	3.80	9.07	3.76	8.45	3.75	8.68	3.59	8.18	3.53
	20	9.18	3.79	8.74	3.74	8.56	3.72	8.53	3.60	8.06	3.53
	21	8.81	3.80	8.30	3.74	8.09	3.72	8.22	3.62	7.93	3.56
	22	8.62	3.82	8.50	3.75	8.45	3.72	8.40	3.64	7.74	3.56
	24	8.04	3.86	8.34	3.78	8.46	3.75	8.29	3.69	7.23	3.63
2.0 + 7.1	16	11.18	4.27	10.37	4.32	10.04	4.35	9.66	4.14	8.86	4.06
	18	10.61	4.36	9.90	4.32	9.23	4.30	9.48	4.11	8.93	4.05
	20	10.02	4.35	9.54	4.29	9.35	4.27	9.32	4.14	8.81	4.05
	21	9.63	4.36	9.06	4.29	8.84	4.27	8.98	4.15	8.67	4.09
	22	9.42	4.38	9.28	4.30	9.23	4.27	9.18	4.17	8.45	4.09
	24	8.79	4.43	9.11	4.34	9.25	4.30	9.06	4.24	7.90	4.16
2.5 + 2.5	16	7.40	2.80	6.86	2.83	6.64	2.84	6.39	2.71	5.86	2.66
	18	7.02	2.85	6.55	2.82	6.10	2.81	6.27	2.69	5.91	2.65
	20	6.63	2.85	6.31	2.81	6.19	2.79	6.17	2.71	5.83	2.65
	21	6.37	2.86	6.00	2.81	5.85	2.79	5.94	2.71	5.73	2.68
	22	6.23	2.86	6.14	2.81	6.11	2.79	6.07	2.73	5.59	2.68
	24	5.81	2.90	6.03	2.84	6.12	2.81	5.99	2.77	5.23	2.73

Combination (Capacity)	Indoor Air Temp. °C DB	Outdoor Air Temp. °C											
		16/15		15/14		10/9		7/6		6/5		2/1	
		Total Q	Input Power	Total Q	Input Power	Total Q	Input Power	Total Q	Input Power	Total Q	Input Power	Total Q	Input Power
2.5 + 3.5	16	14.55	2.45	14.27	2.51	12.89	2.78	12.07	2.94	11.29	3.07	8.94	3.37
	18	13.85	2.54	13.54	2.59	11.96	2.84	11.01	2.99	10.32	3.13	8.46	3.47
	20	13.41	2.63	13.04	2.67	11.20	2.90	10.10	3.03	9.46	3.16	7.94	3.47
	21	13.24	2.68	12.85	2.71	10.87	2.88	9.68	2.98	9.07	3.12	7.66	3.48
	22	13.13	2.73	12.86	2.76	11.51	2.95	10.70	3.06	9.82	3.19	7.36	3.50
	24	13.05	2.83	12.56	2.86	10.13	3.00	8.67	3.08	8.09	3.22	6.72	3.51
2.5 + 4.2	16	15.84	2.61	15.54	2.67	14.04	2.96	13.14	3.14	12.30	3.27	9.74	3.59
	18	15.09	2.71	14.75	2.76	13.03	3.03	12.00	3.19	11.24	3.34	9.21	3.70
	20	14.61	2.80	14.21	2.85	12.20	3.09	11.00	3.23	10.30	3.37	8.64	3.70
	21	14.43	2.85	13.99	2.89	11.84	3.07	10.55	3.18	9.87	3.33	8.34	3.71
	22	14.30	2.91	14.01	2.95	12.53	3.14	11.65	3.26	10.69	3.40	8.01	3.73
	24	14.21	3.02	13.68	3.05	11.04	3.19	9.45	3.28	8.81	3.43	7.32	3.75
2.5 + 5.0	16	15.84	2.41	15.54	2.46	14.04	2.73	13.14	2.89	12.30	3.02	9.74	3.32
	18	15.09	2.50	14.75	2.55	13.03	2.79	12.00	2.94	11.24	3.08	9.21	3.41
	20	14.61	2.58	14.21	2.63	12.20	2.85	11.00	2.98	10.30	3.11	8.64	3.41
	21	14.43	2.63	13.99	2.67	11.84	2.83	10.55	2.93	9.87	3.07	8.34	3.43
	22	14.30	2.68	14.01	2.72	12.53	2.90	11.65	3.00	10.69	3.13	8.01	3.44
	24	14.21	2.78	13.68	2.81	11.04	2.95	9.45	3.03	8.81	3.16	7.32	3.46
2.5 + 6.0	16	18.72	3.10	18.37	3.17	16.60	3.51	15.53	3.72	14.54	3.88	11.51	4.26
	18	17.83	3.21	17.43	3.27	15.40	3.59	14.18	3.78	13.28	3.96	10.89	4.39
	20	17.26	3.32	16.79	3.38	14.42	3.66	13.00	3.83	12.18	4.00	10.22	4.39
	21	17.05	3.39	16.54	3.43	13.99	3.64	12.47	3.77	11.67	3.95	9.86	4.40
	22	16.91	3.45	16.56	3.49	14.81	3.72	13.77	3.86	12.64	4.03	9.47	4.42
	24	16.80	3.58	16.17	3.61	13.04	3.79	11.16	3.89	10.41	4.07	8.65	4.44
2.5 + 7.1	16	18.72	3.09	18.37	3.16	16.60	3.50	15.53	3.71	14.54	3.87	11.51	4.25
	18	17.83	3.20	17.43	3.27	15.40	3.58	14.18	3.77	13.28	3.95	10.89	4.38
	20	17.26	3.31	16.79	3.37	14.42	3.65	13.00	3.82	12.18	3.98	10.22	4.38
	21	17.05	3.38	16.54	3.42	13.99	3.63	12.47	3.76	11.67	3.94	9.86	4.39
	22	16.91	3.44	16.56	3.49	14.81	3.71	13.77	3.85	12.64	4.02	9.47	4.41
	24	16.80	3.57	16.17	3.60	13.04	3.78	11.16	3.88	10.41	4.05	8.65	4.43
3.5 + 3.5	16	15.84	2.61	15.54	2.66	14.04	2.95	13.14	3.13	12.30	3.26	9.74	3.58
	18	15.09	2.70	14.75	2.75	13.03	3.02	12.00	3.18	11.24	3.33	9.21	3.69
	20	14.61	2.79	14.21	2.84	12.20	3.08	11.00	3.22	10.30	3.36	8.64	3.69
	21	14.43	2.85	13.99	2.88	11.84	3.06	10.55	3.17	9.87	3.32	8.34	3.70
	22	14.30	2.90	14.01	2.94	12.53	3.13	11.65	3.25	10.69	3.39	8.01	3.72
	24	14.21	3.01	13.68	3.04	11.04	3.18	9.45	3.27	8.81	3.42	7.32	3.74

Combination (Capacity)	Indoor Air Temp. °C DB	Outdoor Air Temp. °C									
		0/-1		-5/-6		-7/-8		-10/-11		-15/-	
		Total Q	Input Power	Total Q	Input Power	Total Q	Input Power	Total Q	Input Power	Total Q	Input Power
2.5 + 3.5	16	8.69	3.39	8.05	3.43	7.80	3.45	7.51	3.28	6.89	3.22
	18	8.24	3.46	7.69	3.42	7.17	3.41	7.37	3.26	6.94	3.21
	20	7.79	3.45	7.41	3.40	7.26	3.38	7.24	3.28	6.84	3.21
	21	7.48	3.46	7.04	3.41	6.87	3.38	6.97	3.29	6.73	3.24
	22	7.32	3.47	7.21	3.41	7.17	3.38	7.13	3.31	6.57	3.24
	24	6.83	3.52	7.08	3.44	7.18	3.41	7.04	3.36	6.14	3.30
2.5 + 4.2	16	9.46	3.61	8.77	3.66	8.50	3.67	8.18	3.50	7.50	3.43
	18	8.98	3.69	8.38	3.65	7.81	3.63	8.02	3.48	7.56	3.42
	20	8.48	3.68	8.07	3.63	7.91	3.61	7.89	3.50	7.45	3.42
	21	8.15	3.69	7.67	3.63	7.48	3.61	7.59	3.51	7.33	3.46
	22	7.97	3.70	7.86	3.63	7.81	3.61	7.77	3.53	7.15	3.46
	24	7.43	3.75	7.71	3.67	7.82	3.63	7.67	3.58	6.68	3.52
2.5 + 5.0	16	9.46	3.33	8.77	3.37	8.50	3.39	8.18	3.23	7.50	3.17
	18	8.98	3.40	8.38	3.37	7.81	3.35	8.02	3.21	7.56	3.16
	20	8.48	3.40	8.07	3.35	7.91	3.33	7.89	3.23	7.45	3.16
	21	8.15	3.40	7.67	3.35	7.48	3.33	7.59	3.24	7.33	3.19
	22	7.97	3.41	7.86	3.35	7.81	3.33	7.77	3.25	7.15	3.19
	24	7.43	3.46	7.71	3.38	7.82	3.35	7.67	3.31	6.68	3.25
2.5 + 6.0	16	11.18	4.28	10.37	4.34	10.04	4.36	9.66	4.15	8.86	4.07
	18	10.61	4.37	9.90	4.33	9.23	4.31	9.48	4.12	8.93	4.06
	20	10.02	4.36	9.54	4.30	9.35	4.28	9.32	4.15	8.81	4.06
	21	9.63	4.38	9.06	4.31	8.84	4.28	8.98	4.16	8.67	4.10
	22	9.42	4.39	9.28	4.31	9.23	4.28	9.18	4.18	8.45	4.10
	24	8.79	4.44	9.11	4.35	9.25	4.31	9.06	4.25	7.90	4.17
2.5 + 7.1	16	11.18	4.27	10.37	4.32	10.04	4.35	9.66	4.14	8.86	4.06
	18	10.61	4.36	9.90	4.32	9.23	4.30	9.48	4.11	8.93	4.05
	20	10.02	4.35	9.54	4.29	9.35	4.27	9.32	4.14	8.81	4.05
	21	9.63	4.36	9.06	4.29	8.84	4.27	8.98	4.15	8.67	4.09
	22	9.42	4.38	9.28	4.30	9.23	4.27	9.18	4.17	8.45	4.09
	24	8.79	4.43	9.11	4.34	9.25	4.30	9.06	4.24	7.90	4.16
3.5 + 3.5	16	9.46	3.60	8.77	3.64	8.50	3.66	8.18	3.49	7.50	3.42
	18	8.98	3.67	8.38	3.64	7.81	3.62	8.02	3.47	7.56	3.41
	20	8.48	3.67	8.07	3.62	7.91	3.60	7.89	3.49	7.45	3.41
	21	8.15	3.68	7.67	3.62	7.48	3.60	7.59	3.50	7.33	3.45
	22	7.97	3.69	7.86	3.62	7.81	3.60	7.77	3.52	7.15	3.45
	24	7.43	3.74	7.71	3.66	7.82	3.62	7.67	3.57	6.68	3.51

Combination (Capacity)	Indoor Air Temp. °C DB	Outdoor Air Temp. °C											
		16/15		15/14		10/9		7/6		6/5		2/1	
		Total Q	Input Power	Total Q	Input Power	Total Q	Input Power	Total Q	Input Power	Total Q	Input Power	Total Q	Input Power
3.5 + 4.2	16	15.84	2.56	15.54	2.61	14.04	2.90	13.14	3.07	12.30	3.20	9.74	3.52
	18	15.09	2.65	14.75	2.70	13.03	2.96	12.00	3.12	11.24	3.26	9.21	3.62
	20	14.61	2.74	14.21	2.79	12.20	3.02	11.00	3.16	10.30	3.30	8.64	3.62
	21	14.43	2.79	13.99	2.83	11.84	3.00	10.55	3.11	9.87	3.26	8.34	3.63
	22	14.30	2.85	14.01	2.88	12.53	3.07	11.65	3.19	10.69	3.32	8.01	3.65
	24	14.21	2.95	13.68	2.98	11.04	3.13	9.45	3.21	8.81	3.35	7.32	3.67
3.5 + 5.0	16	18.72	3.08	18.37	3.15	16.60	3.49	15.53	3.70	14.54	3.86	11.51	4.24
	18	17.83	3.19	17.43	3.26	15.40	3.57	14.18	3.76	13.28	3.94	10.89	4.37
	20	17.26	3.30	16.79	3.36	14.42	3.64	13.00	3.81	12.18	3.97	10.22	4.37
	21	17.05	3.37	16.54	3.41	13.99	3.62	12.47	3.75	11.67	3.93	9.86	4.38
	22	16.91	3.43	16.56	3.48	14.81	3.70	13.77	3.84	12.64	4.01	9.47	4.40
	24	16.80	3.56	16.17	3.59	13.04	3.77	11.16	3.87	10.41	4.04	8.65	4.42
3.5 + 6.0	16	18.72	3.08	18.37	3.15	16.60	3.49	15.53	3.70	14.54	3.86	11.51	4.24
	18	17.83	3.19	17.43	3.26	15.40	3.57	14.18	3.76	13.28	3.94	10.89	4.37
	20	17.26	3.30	16.79	3.36	14.42	3.64	13.00	3.81	12.18	3.97	10.22	4.37
	21	17.05	3.37	16.54	3.41	13.99	3.62	12.47	3.75	11.67	3.93	9.86	4.38
	22	16.91	3.43	16.56	3.48	14.81	3.70	13.77	3.84	12.64	4.01	9.47	4.40
	24	16.80	3.56	16.17	3.59	13.04	3.77	11.16	3.87	10.41	4.04	8.65	4.42
3.5 + 7.1	16	19.88	3.35	19.50	3.42	17.62	3.80	16.49	4.02	15.43	4.19	12.21	4.61
	18	18.93	3.47	18.50	3.54	16.34	3.88	15.05	4.09	14.10	4.28	11.56	4.74
	20	18.32	3.59	17.82	3.65	15.31	3.96	13.80	4.14	12.93	4.32	10.84	4.74
	21	18.10	3.66	17.56	3.70	14.85	3.93	13.23	4.07	12.39	4.27	10.46	4.76
	22	17.95	3.73	17.58	3.78	15.72	4.03	14.61	4.17	13.41	4.35	10.05	4.78
	24	17.83	3.87	17.17	3.90	13.84	4.09	11.85	4.21	11.05	4.39	9.19	4.80
4.2 + 4.2	16	18.72	3.23	18.37	3.30	16.60	3.66	15.53	3.87	14.54	4.04	11.51	4.44
	18	17.83	3.34	17.43	3.41	15.40	3.74	14.18	3.94	13.28	4.12	10.89	4.57
	20	17.26	3.46	16.79	3.52	14.42	3.81	13.00	3.99	12.18	4.16	10.22	4.57
	21	17.05	3.53	16.54	3.57	13.99	3.79	12.47	3.92	11.67	4.11	9.86	4.59
	22	16.91	3.59	16.56	3.64	14.81	3.88	13.77	4.02	12.64	4.20	9.47	4.60
	24	16.80	3.73	16.17	3.76	13.04	3.95	11.16	4.06	10.41	4.24	8.65	4.63
4.2 + 5.0	16	18.72	3.03	18.37	3.09	16.60	3.43	15.53	3.63	14.54	3.79	11.51	4.16
	18	17.83	3.13	17.43	3.20	15.40	3.51	14.18	3.69	13.28	3.86	10.89	4.29
	20	17.26	3.24	16.79	3.30	14.42	3.57	13.00	3.74	12.18	3.90	10.22	4.29
	21	17.05	3.31	16.54	3.35	13.99	3.55	12.47	3.68	11.67	3.86	9.86	4.30
	22	16.91	3.37	16.56	3.41	14.81	3.64	13.77	3.77	12.64	3.93	9.47	4.32
	24	16.80	3.49	16.17	3.53	13.04	3.70	11.16	3.80	10.41	3.97	8.65	4.34

Combination (Capacity)	Indoor Air Temp. °C DB	Outdoor Air Temp. °C									
		0/-1		-5/-6		-7/-8		-10/-11		-15/-	
		Total Q	Input Power	Total Q	Input Power	Total Q	Input Power	Total Q	Input Power	Total Q	Input Power
3.5 + 4.2	16	9.46	3.53	8.77	3.58	8.50	3.59	8.18	3.42	7.50	3.36
	18	8.98	3.61	8.38	3.57	7.81	3.56	8.02	3.40	7.56	3.35
	20	8.48	3.60	8.07	3.55	7.91	3.53	7.89	3.42	7.45	3.35
	21	8.15	3.61	7.67	3.55	7.48	3.53	7.59	3.43	7.33	3.38
	22	7.97	3.62	7.86	3.56	7.81	3.53	7.77	3.45	7.15	3.38
	24	7.43	3.67	7.71	3.59	7.82	3.56	7.67	3.51	6.68	3.44
3.5 + 5.0	16	11.18	4.26	10.37	4.31	10.04	4.33	9.66	4.13	8.86	4.05
	18	10.61	4.35	9.90	4.30	9.23	4.29	9.48	4.10	8.93	4.04
	20	10.02	4.34	9.54	4.28	9.35	4.25	9.32	4.12	8.81	4.04
	21	9.63	4.35	9.06	4.28	8.84	4.25	8.98	4.14	8.67	4.08
	22	9.42	4.37	9.28	4.29	9.23	4.25	9.18	4.16	8.45	4.08
	24	8.79	4.42	9.11	4.32	9.25	4.29	9.06	4.23	7.90	4.15
3.5 + 6.0	16	11.18	4.26	10.37	4.31	10.04	4.33	9.66	4.13	8.86	4.05
	18	10.61	4.35	9.90	4.30	9.23	4.29	9.48	4.10	8.93	4.04
	20	10.02	4.34	9.54	4.28	9.35	4.25	9.32	4.12	8.81	4.04
	21	9.63	4.35	9.06	4.28	8.84	4.25	8.98	4.14	8.67	4.08
	22	9.42	4.37	9.28	4.29	9.23	4.25	9.18	4.16	8.45	4.08
	24	8.79	4.42	9.11	4.32	9.25	4.29	9.06	4.23	7.90	4.15
3.5 + 7.1	16	11.87	4.63	11.00	4.69	10.66	4.71	10.26	4.48	9.41	4.40
	18	11.26	4.72	10.51	4.68	9.79	4.66	10.07	4.46	9.48	4.39
	20	10.64	4.72	10.13	4.65	9.93	4.62	9.89	4.48	9.35	4.39
	21	10.22	4.73	9.62	4.65	9.38	4.62	9.53	4.49	9.20	4.43
	22	10.00	4.74	9.86	4.66	9.80	4.62	9.74	4.52	8.97	4.43
	24	9.33	4.80	9.68	4.70	9.82	4.66	9.62	4.59	8.39	4.51
4.2 + 4.2	16	11.18	4.46	10.37	4.52	10.04	4.54	9.66	4.32	8.86	4.24
	18	10.61	4.55	9.90	4.51	9.23	4.49	9.48	4.30	8.93	4.23
	20	10.02	4.55	9.54	4.48	9.35	4.46	9.32	4.32	8.81	4.23
	21	9.63	4.56	9.06	4.49	8.84	4.46	8.98	4.33	8.67	4.27
	22	9.42	4.57	9.28	4.49	9.23	4.46	9.18	4.36	8.45	4.27
	24	8.79	4.63	9.11	4.53	9.25	4.49	9.06	4.43	7.90	4.35
4.2 + 5.0	16	11.18	4.18	10.37	4.23	10.04	4.25	9.66	4.05	8.86	3.97
	18	10.61	4.27	9.90	4.22	9.23	4.21	9.48	4.03	8.93	3.96
	20	10.02	4.26	9.54	4.20	9.35	4.18	9.32	4.05	8.81	3.96
	21	9.63	4.27	9.06	4.20	8.84	4.18	8.98	4.06	8.67	4.00
	22	9.42	4.29	9.28	4.21	9.23	4.18	9.18	4.08	8.45	4.00
	24	8.79	4.34	9.11	4.25	9.25	4.21	9.06	4.15	7.90	4.08

Combination (Capacity)	Indoor Air Temp. °C DB	Outdoor Air Temp. °C											
		16/15		15/14		10/9		7/6		6/5		2/1	
		Total Q	Input Power	Total Q	Input Power	Total Q	Input Power	Total Q	Input Power	Total Q	Input Power	Total Q	Input Power
4.2 + 6.0	16	19.88	3.36	19.50	3.43	17.62	3.81	16.49	4.03	15.43	4.21	12.21	4.62
	18	18.93	3.48	18.50	3.55	16.34	3.89	15.05	4.10	14.10	4.29	11.56	4.75
	20	18.32	3.60	17.82	3.66	15.31	3.97	13.80	4.15	12.93	4.33	10.84	4.75
	21	18.10	3.67	17.56	3.71	14.85	3.94	13.23	4.08	12.39	4.28	10.46	4.77
	22	17.95	3.74	17.58	3.79	15.72	4.04	14.61	4.18	13.41	4.36	10.05	4.79
	24	17.83	3.87	17.17	3.91	13.84	4.10	11.85	4.22	11.05	4.40	9.19	4.81
4.2 + 7.1	16	19.88	3.34	19.50	3.42	17.62	3.79	16.49	4.01	15.43	4.18	12.21	4.59
	18	18.93	3.46	18.50	3.53	16.34	3.87	15.05	4.08	14.10	4.27	11.56	4.73
	20	18.32	3.58	17.82	3.64	15.31	3.95	13.80	4.13	12.93	4.31	10.84	4.73
	21	18.10	3.65	17.56	3.70	14.85	3.93	13.23	4.06	12.39	4.26	10.46	4.75
	22	17.95	3.72	17.58	3.77	15.72	4.02	14.61	4.16	13.41	4.34	10.05	4.77
	24	17.83	3.86	17.17	3.89	13.84	4.08	11.85	4.20	11.05	4.38	9.19	4.79
5.0 + 5.0	16	19.88	3.16	19.50	3.23	17.62	3.58	16.49	3.79	15.43	3.95	12.21	4.34
	18	18.93	3.27	18.50	3.33	16.34	3.66	15.05	3.85	14.10	4.03	11.56	4.47
	20	18.32	3.38	17.82	3.44	15.31	3.73	13.80	3.90	12.93	4.07	10.84	4.47
	21	18.10	3.45	17.56	3.49	14.85	3.71	13.23	3.84	12.39	4.02	10.46	4.48
	22	17.95	3.51	17.58	3.56	15.72	3.79	14.61	3.93	13.41	4.10	10.05	4.50
	24	17.83	3.64	17.17	3.68	13.84	3.86	11.85	3.96	11.05	4.14	9.19	4.52
5.0 + 6.0	16	19.88	3.16	19.50	3.23	17.62	3.58	16.49	3.79	15.43	3.95	12.21	4.34
	18	18.93	3.27	18.50	3.33	16.34	3.66	15.05	3.85	14.10	4.03	11.56	4.47
	20	18.32	3.38	17.82	3.44	15.31	3.73	13.80	3.90	12.93	4.07	10.84	4.47
	21	18.10	3.45	17.56	3.49	14.85	3.71	13.23	3.84	12.39	4.02	10.46	4.48
	22	17.95	3.51	17.58	3.56	15.72	3.79	14.61	3.93	13.41	4.10	10.05	4.50
	24	17.83	3.64	17.17	3.68	13.84	3.86	11.85	3.96	11.05	4.14	9.19	4.52
5.0 + 7.1	16	19.88	3.15	19.50	3.22	17.62	3.57	16.49	3.78	15.43	3.94	12.21	4.33
	18	18.93	3.26	18.50	3.33	16.34	3.65	15.05	3.84	14.10	4.02	11.56	4.46
	20	18.32	3.37	17.82	3.43	15.31	3.72	13.80	3.89	12.93	4.06	10.84	4.46
	21	18.10	3.44	17.56	3.48	14.85	3.70	13.23	3.83	12.39	4.01	10.46	4.47
	22	17.95	3.50	17.58	3.55	15.72	3.78	14.61	3.92	13.41	4.09	10.05	4.49
	24	17.83	3.63	17.17	3.67	13.84	3.85	11.85	3.95	11.05	4.13	9.19	4.51
6.0 + 6.0	16	19.88	3.16	19.50	3.23	17.62	3.58	16.49	3.79	15.43	3.95	12.21	4.34
	18	18.93	3.27	18.50	3.33	16.34	3.66	15.05	3.85	14.10	4.03	11.56	4.47
	20	18.32	3.38	17.82	3.44	15.31	3.73	13.80	3.90	12.93	4.07	10.84	4.47
	21	18.10	3.45	17.56	3.49	14.85	3.71	13.23	3.84	12.39	4.02	10.46	4.48
	22	17.95	3.51	17.58	3.56	15.72	3.79	14.61	3.93	13.41	4.10	10.05	4.50
	24	17.83	3.64	17.17	3.68	13.84	3.86	11.85	3.96	11.05	4.14	9.19	4.52

Combination (Capacity)	Indoor Air Temp. °C DB	Outdoor Air Temp. °C									
		0/-1		-5/-6		-7/-8		-10/-11		-15/-	
		Total Q	Input Power	Total Q	Input Power	Total Q	Input Power	Total Q	Input Power	Total Q	Input Power
4.2 + 6.0	16	11.87	4.64	11.00	4.70	10.66	4.72	10.26	4.49	9.41	4.41
	18	11.26	4.74	10.51	4.69	9.79	4.67	10.07	4.47	9.48	4.40
	20	10.64	4.73	10.13	4.66	9.93	4.63	9.89	4.49	9.35	4.40
	21	10.22	4.74	9.62	4.67	9.38	4.63	9.53	4.51	9.20	4.44
	22	10.00	4.75	9.86	4.67	9.80	4.63	9.74	4.53	8.97	4.44
	24	9.33	4.82	9.68	4.71	9.82	4.67	9.62	4.60	8.39	4.52
4.2 + 7.1	16	11.87	4.62	11.00	4.67	10.66	4.70	10.26	4.47	9.41	4.39
	18	11.26	4.71	10.51	4.67	9.79	4.65	10.07	4.45	9.48	4.38
	20	10.64	4.71	10.13	4.64	9.93	4.61	9.89	4.47	9.35	4.38
	21	10.22	4.72	9.62	4.64	9.38	4.61	9.53	4.48	9.20	4.42
	22	10.00	4.73	9.86	4.65	9.80	4.61	9.74	4.51	8.97	4.42
	24	9.33	4.79	9.68	4.69	9.82	4.65	9.62	4.58	8.39	4.50
5.0 + 5.0	16	11.87	4.36	11.00	4.41	10.66	4.44	10.26	4.22	9.41	4.14
	18	11.26	4.45	10.51	4.41	9.79	4.39	10.07	4.20	9.48	4.13
	20	10.64	4.44	10.13	4.38	9.93	4.36	9.89	4.22	9.35	4.13
	21	10.22	4.46	9.62	4.38	9.38	4.36	9.53	4.23	9.20	4.17
	22	10.00	4.47	9.86	4.39	9.80	4.36	9.74	4.26	8.97	4.17
	24	9.33	4.53	9.68	4.43	9.82	4.39	9.62	4.33	8.39	4.25
5.0 + 6.0	16	11.87	4.36	11.00	4.41	10.66	4.44	10.26	4.22	9.41	4.14
	18	11.26	4.45	10.51	4.41	9.79	4.39	10.07	4.20	9.48	4.13
	20	10.64	4.44	10.13	4.38	9.93	4.36	9.89	4.22	9.35	4.13
	21	10.22	4.46	9.62	4.38	9.38	4.36	9.53	4.23	9.20	4.17
	22	10.00	4.47	9.86	4.39	9.80	4.36	9.74	4.26	8.97	4.17
	24	9.33	4.53	9.68	4.43	9.82	4.39	9.62	4.33	8.39	4.25
5.0 + 7.1	16	11.87	4.35	11.00	4.40	10.66	4.42	10.26	4.21	9.41	4.13
	18	11.26	4.44	10.51	4.39	9.79	4.38	10.07	4.19	9.48	4.12
	20	10.64	4.43	10.13	4.37	9.93	4.34	9.89	4.21	9.35	4.12
	21	10.22	4.44	9.62	4.37	9.38	4.34	9.53	4.22	9.20	4.16
	22	10.00	4.46	9.86	4.38	9.80	4.34	9.74	4.25	8.97	4.16
	24	9.33	4.51	9.68	4.42	9.82	4.38	9.62	4.32	8.39	4.24
6.0 + 6.0	16	11.87	4.36	11.00	4.41	10.66	4.44	10.26	4.22	9.41	4.14
	18	11.26	4.45	10.51	4.41	9.79	4.39	10.07	4.20	9.48	4.13
	20	10.64	4.44	10.13	4.38	9.93	4.36	9.89	4.22	9.35	4.13
	21	10.22	4.46	9.62	4.38	9.38	4.36	9.53	4.23	9.20	4.17
	22	10.00	4.47	9.86	4.39	9.80	4.36	9.74	4.26	8.97	4.17
	24	9.33	4.53	9.68	4.43	9.82	4.39	9.62	4.33	8.39	4.25

Combination (Capacity)	Indoor Air Temp. °C DB	Outdoor Air Temp. °C											
		16/15		15/14		10/9		7/6		6/5		2/1	
		Total Q	Input Power	Total Q	Input Power	Total Q	Input Power	Total Q	Input Power	Total Q	Input Power	Total Q	Input Power
6.0 + 7.1	16	19.88	3.15	19.50	3.22	17.62	3.57	16.49	3.78	15.43	3.94	12.21	4.33
	18	18.93	3.26	18.50	3.33	16.34	3.65	15.05	3.84	14.10	4.02	11.56	4.46
	20	18.32	3.37	17.82	3.43	15.31	3.72	13.80	3.89	12.93	4.06	10.84	4.46
	21	18.10	3.44	17.56	3.48	14.85	3.70	13.23	3.83	12.39	4.01	10.46	4.47
	22	17.95	3.50	17.58	3.55	15.72	3.78	14.61	3.92	13.41	4.09	10.05	4.49
	24	17.83	3.63	17.17	3.67	13.84	3.85	11.85	3.95	11.05	4.13	9.19	4.51
7.1 + 7.1	16	19.88	3.13	19.50	3.20	17.62	3.55	16.49	3.76	15.43	3.92	12.21	4.31
	18	18.93	3.24	18.50	3.31	16.34	3.63	15.05	3.82	14.10	4.00	11.56	4.43
	20	18.32	3.36	17.82	3.41	15.31	3.70	13.80	3.87	12.93	4.04	10.84	4.43
	21	18.10	3.42	17.56	3.46	14.85	3.68	13.23	3.81	12.39	3.99	10.46	4.45
	22	17.95	3.48	17.58	3.53	15.72	3.76	14.61	3.90	13.41	4.07	10.05	4.47
	24	17.83	3.61	17.17	3.65	13.84	3.83	11.85	3.93	11.05	4.11	9.19	4.49
1.6 + 1.6 + 1.6	16	17.72	2.73	17.38	2.80	15.70	3.10	14.70	3.28	13.75	3.42	10.89	3.76
	18	16.87	2.83	16.49	2.89	14.57	3.17	13.41	3.34	12.56	3.49	10.30	3.87
	20	16.33	2.93	15.88	2.98	13.64	3.23	12.30	3.38	11.52	3.53	9.67	3.87
	21	16.13	2.99	15.65	3.02	13.24	3.21	11.79	3.32	11.04	3.48	9.32	3.89
	22	16.00	3.04	15.67	3.08	14.02	3.29	13.03	3.41	11.96	3.55	8.96	3.90
	24	15.89	3.16	15.30	3.19	12.34	3.34	10.56	3.44	9.85	3.59	8.19	3.92
1.6 + 1.6 + 2.0	16	17.72	2.73	17.38	2.79	15.70	3.09	14.70	3.27	13.75	3.41	10.89	3.75
	18	16.87	2.82	16.49	2.88	14.57	3.16	13.41	3.33	12.56	3.48	10.30	3.86
	20	16.33	2.92	15.88	2.97	13.64	3.22	12.30	3.37	11.52	3.52	9.67	3.86
	21	16.13	2.98	15.65	3.02	13.24	3.20	11.79	3.31	11.04	3.47	9.32	3.88
	22	16.00	3.03	15.67	3.07	14.02	3.28	13.03	3.40	11.96	3.54	8.96	3.89
	24	15.89	3.15	15.30	3.18	12.34	3.33	10.56	3.43	9.85	3.58	8.19	3.91
1.6 + 1.6 + 2.5	16	17.72	2.73	17.38	2.79	15.70	3.09	14.70	3.27	13.75	3.41	10.89	3.75
	18	16.87	2.82	16.49	2.88	14.57	3.16	13.41	3.33	12.56	3.48	10.30	3.86
	20	16.33	2.92	15.88	2.97	13.64	3.22	12.30	3.37	11.52	3.52	9.67	3.86
	21	16.13	2.98	15.65	3.02	13.24	3.20	11.79	3.31	11.04	3.47	9.32	3.88
	22	16.00	3.03	15.67	3.07	14.02	3.28	13.03	3.40	11.96	3.54	8.96	3.89
	24	15.89	3.15	15.30	3.18	12.34	3.33	10.56	3.43	9.85	3.58	8.19	3.91
1.6 + 1.6 + 3.5	16	17.72	2.65	17.38	2.71	15.70	3.01	14.70	3.18	13.75	3.32	10.89	3.65
	18	16.87	2.75	16.49	2.80	14.57	3.08	13.41	3.24	12.56	3.39	10.30	3.76
	20	16.33	2.84	15.88	2.89	13.64	3.13	12.30	3.28	11.52	3.42	9.67	3.76
	21	16.13	2.90	15.65	2.94	13.24	3.12	11.79	3.23	11.04	3.38	9.32	3.77
	22	16.00	2.95	15.67	2.99	14.02	3.19	13.03	3.31	11.96	3.45	8.96	3.79
	24	15.89	3.06	15.30	3.09	12.34	3.24	10.56	3.33	9.85	3.48	8.19	3.80



Combination (Capacity)	Indoor Air Temp. °C DB	Outdoor Air Temp. °C									
		0/-1		-5/-6		-7/-8		-10/-11		-15/-	
		Total Q	Input Power	Total Q	Input Power	Total Q	Input Power	Total Q	Input Power	Total Q	Input Power
6.0 + 7.1	16	11.87	4.35	11.00	4.40	10.66	4.42	10.26	4.21	9.41	4.13
	18	11.26	4.44	10.51	4.39	9.79	4.38	10.07	4.19	9.48	4.12
	20	10.64	4.43	10.13	4.37	9.93	4.34	9.89	4.21	9.35	4.12
	21	10.22	4.44	9.62	4.37	9.38	4.34	9.53	4.22	9.20	4.16
	22	10.00	4.46	9.86	4.38	9.80	4.34	9.74	4.25	8.97	4.16
	24	9.33	4.51	9.68	4.42	9.82	4.38	9.62	4.32	8.39	4.24
7.1 + 7.1	16	11.87	4.33	11.00	4.38	10.66	4.40	10.26	4.19	9.41	4.11
	18	11.26	4.42	10.51	4.37	9.79	4.35	10.07	4.17	9.48	4.10
	20	10.64	4.41	10.13	4.35	9.93	4.32	9.89	4.19	9.35	4.10
	21	10.22	4.42	9.62	4.35	9.38	4.32	9.53	4.20	9.20	4.14
	22	10.00	4.43	9.86	4.35	9.80	4.32	9.74	4.23	8.97	4.14
	24	9.33	4.49	9.68	4.39	9.82	4.35	9.62	4.29	8.39	4.22
1.6 + 1.6 + 1.6	16	10.58	3.78	9.81	3.83	9.50	3.84	9.14	3.66	8.39	3.59
	18	10.04	3.86	9.37	3.82	8.73	3.80	8.97	3.64	8.45	3.58
	20	9.48	3.85	9.03	3.80	8.85	3.77	8.82	3.66	8.33	3.58
	21	9.11	3.86	8.58	3.80	8.36	3.77	8.49	3.67	8.20	3.62
	22	8.91	3.87	8.78	3.80	8.73	3.77	8.68	3.69	8.00	3.62
	24	8.31	3.92	8.62	3.84	8.75	3.80	8.57	3.75	7.47	3.68
1.6 + 1.6 + 2.0	16	10.58	3.77	9.81	3.81	9.50	3.83	9.14	3.65	8.39	3.58
	18	10.04	3.85	9.37	3.81	8.73	3.79	8.97	3.63	8.45	3.57
	20	9.48	3.84	9.03	3.79	8.85	3.76	8.82	3.65	8.33	3.57
	21	9.11	3.85	8.58	3.79	8.36	3.76	8.49	3.66	8.20	3.61
	22	8.91	3.86	8.78	3.79	8.73	3.76	8.68	3.68	8.00	3.61
	24	8.31	3.91	8.62	3.83	8.75	3.79	8.57	3.74	7.47	3.67
1.6 + 1.6 + 2.5	16	10.58	3.77	9.81	3.81	9.50	3.83	9.14	3.65	8.39	3.58
	18	10.04	3.85	9.37	3.81	8.73	3.79	8.97	3.63	8.45	3.57
	20	9.48	3.84	9.03	3.79	8.85	3.76	8.82	3.65	8.33	3.57
	21	9.11	3.85	8.58	3.79	8.36	3.76	8.49	3.66	8.20	3.61
	22	8.91	3.86	8.78	3.79	8.73	3.76	8.68	3.68	8.00	3.61
	24	8.31	3.91	8.62	3.83	8.75	3.79	8.57	3.74	7.47	3.67
1.6 + 1.6 + 3.5	16	10.58	3.67	9.81	3.71	9.50	3.73	9.14	3.55	8.39	3.48
	18	10.04	3.74	9.37	3.71	8.73	3.69	8.97	3.53	8.45	3.48
	20	9.48	3.74	9.03	3.68	8.85	3.66	8.82	3.55	8.33	3.48
	21	9.11	3.75	8.58	3.69	8.36	3.66	8.49	3.56	8.20	3.51
	22	8.91	3.76	8.78	3.69	8.73	3.66	8.68	3.58	8.00	3.51
	24	8.31	3.81	8.62	3.72	8.75	3.69	8.57	3.64	7.47	3.58

Combination (Capacity)	Indoor Air Temp. °C DB	Outdoor Air Temp. °C											
		16/15		15/14		10/9		7/6		6/5		2/1	
		Total Q	Input Power	Total Q	Input Power	Total Q	Input Power	Total Q	Input Power	Total Q	Input Power	Total Q	Input Power
1.6 + 1.6 + 4.2	16	17.72	2.65	17.38	2.70	15.70	3.00	14.70	3.18	13.75	3.31	10.89	3.64
	18	16.87	2.74	16.49	2.80	14.57	3.07	13.41	3.23	12.56	3.38	10.30	3.75
	20	16.33	2.84	15.88	2.88	13.64	3.13	12.30	3.27	11.52	3.41	9.67	3.75
	21	16.13	2.89	15.65	2.93	13.24	3.11	11.79	3.22	11.04	3.37	9.32	3.76
	22	16.00	2.94	15.67	2.98	14.02	3.18	13.03	3.30	11.96	3.44	8.96	3.77
	24	15.89	3.05	15.30	3.08	12.34	3.23	10.56	3.32	9.85	3.47	8.19	3.79
1.6 + 1.6 + 5.0	16	18.58	2.72	18.23	2.78	16.47	3.08	15.41	3.26	14.43	3.40	11.42	3.74
	18	17.70	2.82	17.29	2.87	15.28	3.15	14.07	3.32	13.18	3.47	10.81	3.85
	20	17.13	2.91	16.66	2.96	14.31	3.21	12.90	3.36	12.08	3.50	10.14	3.85
	21	16.92	2.97	16.41	3.01	13.89	3.19	12.37	3.31	11.58	3.46	9.78	3.86
	22	16.78	3.03	16.43	3.07	14.70	3.27	13.66	3.39	12.54	3.53	9.40	3.88
	24	16.67	3.14	16.05	3.17	12.94	3.32	11.08	3.42	10.33	3.57	8.59	3.90
1.6 + 1.6 + 6.0	16	19.59	2.99	19.22	3.06	17.36	3.39	16.25	3.59	15.21	3.75	12.04	4.12
	18	18.66	3.10	18.23	3.16	16.11	3.47	14.83	3.65	13.89	3.82	11.39	4.24
	20	18.06	3.21	17.56	3.26	15.09	3.54	13.60	3.70	12.74	3.86	10.69	4.24
	21	17.83	3.27	17.30	3.31	14.64	3.52	13.04	3.64	12.21	3.81	10.31	4.25
	22	17.69	3.33	17.32	3.38	15.50	3.60	14.40	3.73	13.22	3.89	9.91	4.27
	24	17.57	3.45	16.92	3.49	13.64	3.66	11.68	3.76	10.89	3.93	9.05	4.29
1.6 + 1.6 + 7.1	16	19.59	2.93	19.22	2.99	17.36	3.32	16.25	3.51	15.21	3.67	12.04	4.03
	18	18.66	3.03	18.23	3.09	16.11	3.39	14.83	3.57	13.89	3.74	11.39	4.15
	20	18.06	3.14	17.56	3.19	15.09	3.46	13.60	3.62	12.74	3.78	10.69	4.15
	21	17.83	3.20	17.30	3.24	14.64	3.44	13.04	3.56	12.21	3.73	10.31	4.16
	22	17.69	3.26	17.32	3.30	15.50	3.52	14.40	3.65	13.22	3.81	9.91	4.18
	24	17.57	3.38	16.92	3.41	13.64	3.58	11.68	3.68	10.89	3.84	9.05	4.20
1.6 + 2.0 + 2.0	16	17.72	2.72	17.38	2.78	15.70	3.08	14.70	3.26	13.75	3.40	10.89	3.74
	18	16.87	2.82	16.49	2.87	14.57	3.15	13.41	3.32	12.56	3.47	10.30	3.85
	20	16.33	2.91	15.88	2.96	13.64	3.21	12.30	3.36	11.52	3.50	9.67	3.85
	21	16.13	2.97	15.65	3.01	13.24	3.19	11.79	3.31	11.04	3.46	9.32	3.86
	22	16.00	3.03	15.67	3.07	14.02	3.27	13.03	3.39	11.96	3.53	8.96	3.88
	24	15.89	3.14	15.30	3.17	12.34	3.32	10.56	3.42	9.85	3.57	8.19	3.90
1.6 + 2.0 + 2.5	16	17.72	2.72	17.38	2.78	15.70	3.08	14.70	3.26	13.75	3.40	10.89	3.74
	18	16.87	2.82	16.49	2.87	14.57	3.15	13.41	3.32	12.56	3.47	10.30	3.85
	20	16.33	2.91	15.88	2.96	13.64	3.21	12.30	3.36	11.52	3.50	9.67	3.85
	21	16.13	2.97	15.65	3.01	13.24	3.19	11.79	3.31	11.04	3.46	9.32	3.86
	22	16.00	3.03	15.67	3.07	14.02	3.27	13.03	3.39	11.96	3.53	8.96	3.88
	24	15.89	3.14	15.30	3.17	12.34	3.32	10.56	3.42	9.85	3.57	8.19	3.90

Combination (Capacity)	Indoor Air Temp. °C DB	Outdoor Air Temp. °C									
		0/-1		-5/-6		-7/-8		-10/-11		-15/-	
		Total Q	Input Power	Total Q	Input Power	Total Q	Input Power	Total Q	Input Power	Total Q	Input Power
1.6 + 1.6 + 4.2	16	10.58	3.66	9.81	3.70	9.50	3.72	9.14	3.54	8.39	3.47
	18	10.04	3.73	9.37	3.69	8.73	3.68	8.97	3.52	8.45	3.47
	20	9.48	3.73	9.03	3.67	8.85	3.65	8.82	3.54	8.33	3.47
	21	9.11	3.74	8.58	3.68	8.36	3.65	8.49	3.55	8.20	3.50
	22	8.91	3.75	8.78	3.68	8.73	3.65	8.68	3.57	8.00	3.50
	24	8.31	3.79	8.62	3.71	8.75	3.68	8.57	3.63	7.47	3.56
1.6 + 1.6 + 5.0	16	11.09	3.76	10.29	3.80	9.96	3.82	9.59	3.64	8.79	3.57
	18	10.53	3.83	9.83	3.80	9.16	3.78	9.41	3.62	8.87	3.56
	20	9.95	3.83	9.47	3.77	9.28	3.75	9.25	3.64	8.74	3.56
	21	9.56	3.84	8.99	3.78	8.77	3.75	8.91	3.65	8.60	3.60
	22	9.34	3.85	9.21	3.78	9.16	3.75	9.11	3.67	8.39	3.60
	24	8.72	3.90	9.04	3.81	9.18	3.78	8.99	3.73	7.84	3.66
1.6 + 1.6 + 6.0	16	11.70	4.14	10.84	4.19	10.50	4.21	10.11	4.01	9.27	3.93
	18	11.10	4.22	10.36	4.18	9.65	4.16	9.92	3.98	9.35	3.92
	20	10.49	4.22	9.98	4.16	9.78	4.13	9.75	4.01	9.22	3.92
	21	10.07	4.23	9.48	4.16	9.25	4.13	9.39	4.02	9.07	3.96
	22	9.85	4.24	9.71	4.16	9.66	4.13	9.60	4.04	8.84	3.96
	24	9.19	4.29	9.54	4.20	9.67	4.16	9.48	4.11	8.26	4.03
1.6 + 1.6 + 7.1	16	11.70	4.05	10.84	4.10	10.50	4.12	10.11	3.92	9.27	3.85
	18	11.10	4.13	10.36	4.09	9.65	4.07	9.92	3.90	9.35	3.84
	20	10.49	4.12	9.98	4.07	9.78	4.04	9.75	3.92	9.22	3.84
	21	10.07	4.14	9.48	4.07	9.25	4.04	9.39	3.93	9.07	3.87
	22	9.85	4.15	9.71	4.07	9.66	4.04	9.60	3.95	8.84	3.87
	24	9.19	4.20	9.54	4.11	9.67	4.07	9.48	4.02	8.26	3.95
1.6 + 2.0 + 2.0	16	10.58	3.76	9.81	3.80	9.50	3.82	9.14	3.64	8.39	3.57
	18	10.04	3.83	9.37	3.80	8.73	3.78	8.97	3.62	8.45	3.56
	20	9.48	3.83	9.03	3.77	8.85	3.75	8.82	3.64	8.33	3.56
	21	9.11	3.84	8.58	3.78	8.36	3.75	8.49	3.65	8.20	3.60
	22	8.91	3.85	8.78	3.78	8.73	3.75	8.68	3.67	8.00	3.60
	24	8.31	3.90	8.62	3.81	8.75	3.78	8.57	3.73	7.47	3.66
1.6 + 2.0 + 2.5	16	10.58	3.76	9.81	3.80	9.50	3.82	9.14	3.64	8.39	3.57
	18	10.04	3.83	9.37	3.80	8.73	3.78	8.97	3.62	8.45	3.56
	20	9.48	3.83	9.03	3.77	8.85	3.75	8.82	3.64	8.33	3.56
	21	9.11	3.84	8.58	3.78	8.36	3.75	8.49	3.65	8.20	3.60
	22	8.91	3.85	8.78	3.78	8.73	3.75	8.68	3.67	8.00	3.60
	24	8.31	3.90	8.62	3.81	8.75	3.78	8.57	3.73	7.47	3.66

Combination (Capacity)	Indoor Air Temp. °C DB	Outdoor Air Temp. °C											
		16/15		15/14		10/9		7/6		6/5		2/1	
		Total Q	Input Power	Total Q	Input Power	Total Q	Input Power	Total Q	Input Power	Total Q	Input Power	Total Q	Input Power
1.6 + 2.0 + 3.5	16	17.72	2.65	17.38	2.70	15.70	3.00	14.70	3.18	13.75	3.31	10.89	3.64
	18	16.87	2.74	16.49	2.80	14.57	3.07	13.41	3.23	12.56	3.38	10.30	3.75
	20	16.33	2.84	15.88	2.88	13.64	3.13	12.30	3.27	11.52	3.41	9.67	3.75
	21	16.13	2.89	15.65	2.93	13.24	3.11	11.79	3.22	11.04	3.37	9.32	3.76
	22	16.00	2.94	15.67	2.98	14.02	3.18	13.03	3.30	11.96	3.44	8.96	3.77
	24	15.89	3.05	15.30	3.08	12.34	3.23	10.56	3.32	9.85	3.47	8.19	3.79
1.6 + 2.0 + 4.2	16	18.58	2.86	18.23	2.93	16.47	3.25	15.41	3.44	14.43	3.59	11.42	3.94
	18	17.70	2.97	17.29	3.03	15.28	3.32	14.07	3.50	13.18	3.66	10.81	4.06
	20	17.13	3.07	16.66	3.12	14.31	3.38	12.90	3.54	12.08	3.69	10.14	4.06
	21	16.92	3.13	16.41	3.17	13.89	3.36	12.37	3.48	11.58	3.65	9.78	4.07
	22	16.78	3.19	16.43	3.23	14.70	3.44	13.66	3.57	12.54	3.72	9.40	4.09
	24	16.67	3.30	16.05	3.34	12.94	3.50	11.08	3.60	10.33	3.76	8.59	4.11
1.6 + 2.0 + 5.0	16	19.59	2.94	19.22	3.00	17.36	3.33	16.25	3.52	15.21	3.68	12.04	4.04
	18	18.66	3.04	18.23	3.10	16.11	3.40	14.83	3.58	13.89	3.75	11.39	4.16
	20	18.06	3.15	17.56	3.20	15.09	3.47	13.60	3.63	12.74	3.79	10.69	4.16
	21	17.83	3.21	17.30	3.25	14.64	3.45	13.04	3.57	12.21	3.74	10.31	4.17
	22	17.69	3.27	17.32	3.31	15.50	3.53	14.40	3.66	13.22	3.82	9.91	4.19
	24	17.57	3.39	16.92	3.42	13.64	3.59	11.68	3.69	10.89	3.85	9.05	4.21
1.6 + 2.0 + 6.0	16	19.59	2.94	19.22	3.00	17.36	3.33	16.25	3.52	15.21	3.68	12.04	4.04
	18	18.66	3.04	18.23	3.10	16.11	3.40	14.83	3.58	13.89	3.75	11.39	4.16
	20	18.06	3.15	17.56	3.20	15.09	3.47	13.60	3.63	12.74	3.79	10.69	4.16
	21	17.83	3.21	17.30	3.25	14.64	3.45	13.04	3.57	12.21	3.74	10.31	4.17
	22	17.69	3.27	17.32	3.31	15.50	3.53	14.40	3.66	13.22	3.82	9.91	4.19
	24	17.57	3.39	16.92	3.42	13.64	3.59	11.68	3.69	10.89	3.85	9.05	4.21
1.6 + 2.0 + 7.1	16	19.88	3.02	19.50	3.09	17.62	3.42	16.49	3.62	15.43	3.78	12.21	4.15
	18	18.93	3.13	18.50	3.19	16.34	3.50	15.05	3.68	14.10	3.85	11.56	4.27
	20	18.32	3.23	17.82	3.29	15.31	3.56	13.80	3.73	12.93	3.89	10.84	4.27
	21	18.10	3.30	17.56	3.34	14.85	3.54	13.23	3.67	12.39	3.85	10.46	4.29
	22	17.95	3.36	17.58	3.40	15.72	3.63	14.61	3.76	13.41	3.92	10.05	4.30
	24	17.83	3.48	17.17	3.52	13.84	3.69	11.85	3.79	11.05	3.96	9.19	4.33
1.6 + 2.5 + 2.5	16	17.72	2.72	17.38	2.78	15.70	3.08	14.70	3.26	13.75	3.40	10.89	3.74
	18	16.87	2.82	16.49	2.87	14.57	3.15	13.41	3.32	12.56	3.47	10.30	3.85
	20	16.33	2.91	15.88	2.96	13.64	3.21	12.30	3.36	11.52	3.50	9.67	3.85
	21	16.13	2.97	15.65	3.01	13.24	3.19	11.79	3.31	11.04	3.46	9.32	3.86
	22	16.00	3.03	15.67	3.07	14.02	3.27	13.03	3.39	11.96	3.53	8.96	3.88
	24	15.89	3.14	15.30	3.17	12.34	3.32	10.56	3.42	9.85	3.57	8.19	3.90

Combination (Capacity)	Indoor Air Temp. °C DB	Outdoor Air Temp. °C									
		0/-1		-5/-6		-7/-8		-10/-11		-15/-	
		Total Q	Input Power	Total Q	Input Power	Total Q	Input Power	Total Q	Input Power	Total Q	Input Power
1.6 + 2.0 + 3.5	16	10.58	3.66	9.81	3.70	9.50	3.72	9.14	3.54	8.39	3.47
	18	10.04	3.73	9.37	3.69	8.73	3.68	8.97	3.52	8.45	3.47
	20	9.48	3.73	9.03	3.67	8.85	3.65	8.82	3.54	8.33	3.47
	21	9.11	3.74	8.58	3.68	8.36	3.65	8.49	3.55	8.20	3.50
	22	8.91	3.75	8.78	3.68	8.73	3.65	8.68	3.57	8.00	3.50
	24	8.31	3.79	8.62	3.71	8.75	3.68	8.57	3.63	7.47	3.56
1.6 + 2.0 + 4.2	16	11.09	3.96	10.29	4.01	9.96	4.03	9.59	3.83	8.79	3.76
	18	10.53	4.04	9.83	4.00	9.16	3.98	9.41	3.81	8.87	3.75
	20	9.95	4.03	9.47	3.98	9.28	3.95	9.25	3.83	8.74	3.75
	21	9.56	4.04	8.99	3.98	8.77	3.95	8.91	3.84	8.60	3.79
	22	9.34	4.06	9.21	3.98	9.16	3.95	9.11	3.87	8.39	3.79
	24	8.72	4.11	9.04	4.02	9.18	3.98	8.99	3.93	7.84	3.86
1.6 + 2.0 + 5.0	16	11.70	4.06	10.84	4.11	10.50	4.13	10.11	3.93	9.27	3.86
	18	11.10	4.14	10.36	4.10	9.65	4.08	9.92	3.91	9.35	3.85
	20	10.49	4.14	9.98	4.08	9.78	4.05	9.75	3.93	9.22	3.85
	21	10.07	4.15	9.48	4.08	9.25	4.05	9.39	3.94	9.07	3.88
	22	9.85	4.16	9.71	4.08	9.66	4.05	9.60	3.96	8.84	3.88
	24	9.19	4.21	9.54	4.12	9.67	4.08	9.48	4.03	8.26	3.96
1.6 + 2.0 + 6.0	16	11.70	4.06	10.84	4.11	10.50	4.13	10.11	3.93	9.27	3.86
	18	11.10	4.14	10.36	4.10	9.65	4.08	9.92	3.91	9.35	3.85
	20	10.49	4.14	9.98	4.08	9.78	4.05	9.75	3.93	9.22	3.85
	21	10.07	4.15	9.48	4.08	9.25	4.05	9.39	3.94	9.07	3.88
	22	9.85	4.16	9.71	4.08	9.66	4.05	9.60	3.96	8.84	3.88
	24	9.19	4.21	9.54	4.12	9.67	4.08	9.48	4.03	8.26	3.96
1.6 + 2.0 + 7.1	16	11.87	4.17	11.00	4.22	10.66	4.24	10.26	4.04	9.41	3.96
	18	11.26	4.26	10.51	4.21	9.79	4.20	10.07	4.02	9.48	3.95
	20	10.64	4.25	10.13	4.19	9.93	4.17	9.89	4.04	9.35	3.95
	21	10.22	4.26	9.62	4.19	9.38	4.17	9.53	4.05	9.20	3.99
	22	10.00	4.27	9.86	4.20	9.80	4.17	9.74	4.07	8.97	3.99
	24	9.33	4.33	9.68	4.23	9.82	4.20	9.62	4.14	8.39	4.07
1.6 + 2.5 + 2.5	16	10.58	3.76	9.81	3.80	9.50	3.82	9.14	3.64	8.39	3.57
	18	10.04	3.83	9.37	3.80	8.73	3.78	8.97	3.62	8.45	3.56
	20	9.48	3.83	9.03	3.77	8.85	3.75	8.82	3.64	8.33	3.56
	21	9.11	3.84	8.58	3.78	8.36	3.75	8.49	3.65	8.20	3.60
	22	8.91	3.85	8.78	3.78	8.73	3.75	8.68	3.67	8.00	3.60
	24	8.31	3.90	8.62	3.81	8.75	3.78	8.57	3.73	7.47	3.66

Combination (Capacity)	Indoor Air Temp. °C DB	Outdoor Air Temp. °C											
		16/15		15/14		10/9		7/6		6/5		2/1	
		Total Q	Input Power	Total Q	Input Power	Total Q	Input Power	Total Q	Input Power	Total Q	Input Power	Total Q	Input Power
1.6 + 2.5 + 3.5	16	17.72	2.65	17.38	2.70	15.70	3.00	14.70	3.18	13.75	3.31	10.89	3.64
	18	16.87	2.74	16.49	2.80	14.57	3.07	13.41	3.23	12.56	3.38	10.30	3.75
	20	16.33	2.84	15.88	2.88	13.64	3.13	12.30	3.27	11.52	3.41	9.67	3.75
	21	16.13	2.89	15.65	2.93	13.24	3.11	11.79	3.22	11.04	3.37	9.32	3.76
	22	16.00	2.94	15.67	2.98	14.02	3.18	13.03	3.30	11.96	3.44	8.96	3.77
	24	15.89	3.05	15.30	3.08	12.34	3.23	10.56	3.32	9.85	3.47	8.19	3.79
1.6 + 2.5 + 4.2	16	18.58	2.86	18.23	2.93	16.47	3.25	15.41	3.44	14.43	3.59	11.42	3.94
	18	17.70	2.97	17.29	3.03	15.28	3.32	14.07	3.50	13.18	3.66	10.81	4.06
	20	17.13	3.07	16.66	3.12	14.31	3.38	12.90	3.54	12.08	3.69	10.14	4.06
	21	16.92	3.13	16.41	3.17	13.89	3.36	12.37	3.48	11.58	3.65	9.78	4.07
	22	16.78	3.19	16.43	3.23	14.70	3.44	13.66	3.57	12.54	3.72	9.40	4.09
	24	16.67	3.30	16.05	3.34	12.94	3.50	11.08	3.60	10.33	3.76	8.59	4.11
1.6 + 2.5 + 5.0	16	19.59	2.94	19.22	3.00	17.36	3.33	16.25	3.52	15.21	3.68	12.04	4.04
	18	18.66	3.04	18.23	3.10	16.11	3.40	14.83	3.58	13.89	3.75	11.39	4.16
	20	18.06	3.15	17.56	3.20	15.09	3.47	13.60	3.63	12.74	3.79	10.69	4.16
	21	17.83	3.21	17.30	3.25	14.64	3.45	13.04	3.57	12.21	3.74	10.31	4.17
	22	17.69	3.27	17.32	3.31	15.50	3.53	14.40	3.66	13.22	3.82	9.91	4.19
	24	17.57	3.39	16.92	3.42	13.64	3.59	11.68	3.69	10.89	3.85	9.05	4.21
1.6 + 2.5 + 6.0	16	19.59	2.94	19.22	3.00	17.36	3.33	16.25	3.52	15.21	3.68	12.04	4.04
	18	18.66	3.04	18.23	3.10	16.11	3.40	14.83	3.58	13.89	3.75	11.39	4.16
	20	18.06	3.15	17.56	3.20	15.09	3.47	13.60	3.63	12.74	3.79	10.69	4.16
	21	17.83	3.21	17.30	3.25	14.64	3.45	13.04	3.57	12.21	3.74	10.31	4.17
	22	17.69	3.27	17.32	3.31	15.50	3.53	14.40	3.66	13.22	3.82	9.91	4.19
	24	17.57	3.39	16.92	3.42	13.64	3.59	11.68	3.69	10.89	3.85	9.05	4.21
1.6 + 2.5 + 7.1	16	19.88	3.02	19.50	3.09	17.62	3.42	16.49	3.62	15.43	3.78	12.21	4.15
	18	18.93	3.13	18.50	3.19	16.34	3.50	15.05	3.68	14.10	3.85	11.56	4.27
	20	18.32	3.23	17.82	3.29	15.31	3.56	13.80	3.73	12.93	3.89	10.84	4.27
	21	18.10	3.30	17.56	3.34	14.85	3.54	13.23	3.67	12.39	3.85	10.46	4.29
	22	17.95	3.36	17.58	3.40	15.72	3.63	14.61	3.76	13.41	3.92	10.05	4.30
	24	17.83	3.48	17.17	3.52	13.84	3.69	11.85	3.79	11.05	3.96	9.19	4.33
1.6 + 3.5 + 3.5	16	19.59	3.12	19.22	3.19	17.36	3.54	16.25	3.75	15.21	3.91	12.04	4.29
	18	18.66	3.24	18.23	3.30	16.11	3.62	14.83	3.81	13.89	3.99	11.39	4.42
	20	18.06	3.35	17.56	3.40	15.09	3.69	13.60	3.86	12.74	4.03	10.69	4.42
	21	17.83	3.41	17.30	3.45	14.64	3.67	13.04	3.80	12.21	3.98	10.31	4.44
	22	17.69	3.48	17.32	3.52	15.50	3.75	14.40	3.89	13.22	4.06	9.91	4.45
	24	17.57	3.60	16.92	3.64	13.64	3.82	11.68	3.92	10.89	4.10	9.05	4.48

Combination (Capacity)	Indoor Air Temp. °C DB	Outdoor Air Temp. °C									
		0/-1		-5/-6		-7/-8		-10/-11		-15/-	
		Total Q	Input Power	Total Q	Input Power	Total Q	Input Power	Total Q	Input Power	Total Q	Input Power
1.6 + 2.5 + 3.5	16	10.58	3.66	9.81	3.70	9.50	3.72	9.14	3.54	8.39	3.47
	18	10.04	3.73	9.37	3.69	8.73	3.68	8.97	3.52	8.45	3.47
	20	9.48	3.73	9.03	3.67	8.85	3.65	8.82	3.54	8.33	3.47
	21	9.11	3.74	8.58	3.68	8.36	3.65	8.49	3.55	8.20	3.50
	22	8.91	3.75	8.78	3.68	8.73	3.65	8.68	3.57	8.00	3.50
	24	8.31	3.79	8.62	3.71	8.75	3.68	8.57	3.63	7.47	3.56
1.6 + 2.5 + 4.2	16	11.09	3.96	10.29	4.01	9.96	4.03	9.59	3.83	8.79	3.76
	18	10.53	4.04	9.83	4.00	9.16	3.98	9.41	3.81	8.87	3.75
	20	9.95	4.03	9.47	3.98	9.28	3.95	9.25	3.83	8.74	3.75
	21	9.56	4.04	8.99	3.98	8.77	3.95	8.91	3.84	8.60	3.79
	22	9.34	4.06	9.21	3.98	9.16	3.95	9.11	3.87	8.39	3.79
	24	8.72	4.11	9.04	4.02	9.18	3.98	8.99	3.93	7.84	3.86
1.6 + 2.5 + 5.0	16	11.70	4.06	10.84	4.11	10.50	4.13	10.11	3.93	9.27	3.86
	18	11.10	4.14	10.36	4.10	9.65	4.08	9.92	3.91	9.35	3.85
	20	10.49	4.14	9.98	4.08	9.78	4.05	9.75	3.93	9.22	3.85
	21	10.07	4.15	9.48	4.08	9.25	4.05	9.39	3.94	9.07	3.88
	22	9.85	4.16	9.71	4.08	9.66	4.05	9.60	3.96	8.84	3.88
	24	9.19	4.21	9.54	4.12	9.67	4.08	9.48	4.03	8.26	3.96
1.6 + 2.5 + 6.0	16	11.70	4.06	10.84	4.11	10.50	4.13	10.11	3.93	9.27	3.86
	18	11.10	4.14	10.36	4.10	9.65	4.08	9.92	3.91	9.35	3.85
	20	10.49	4.14	9.98	4.08	9.78	4.05	9.75	3.93	9.22	3.85
	21	10.07	4.15	9.48	4.08	9.25	4.05	9.39	3.94	9.07	3.88
	22	9.85	4.16	9.71	4.08	9.66	4.05	9.60	3.96	8.84	3.88
	24	9.19	4.21	9.54	4.12	9.67	4.08	9.48	4.03	8.26	3.96
1.6 + 2.5 + 7.1	16	11.87	4.17	11.00	4.22	10.66	4.24	10.26	4.04	9.41	3.96
	18	11.26	4.26	10.51	4.21	9.79	4.20	10.07	4.02	9.48	3.95
	20	10.64	4.25	10.13	4.19	9.93	4.17	9.89	4.04	9.35	3.95
	21	10.22	4.26	9.62	4.19	9.38	4.17	9.53	4.05	9.20	3.99
	22	10.00	4.27	9.86	4.20	9.80	4.17	9.74	4.07	8.97	3.99
	24	9.33	4.33	9.68	4.23	9.82	4.20	9.62	4.14	8.39	4.07
1.6 + 3.5 + 3.5	16	11.70	4.32	10.84	4.37	10.50	4.39	10.11	4.18	9.27	4.10
	18	11.10	4.40	10.36	4.36	9.65	4.34	9.92	4.16	9.35	4.09
	20	10.49	4.40	9.98	4.34	9.78	4.31	9.75	4.18	9.22	4.09
	21	10.07	4.41	9.48	4.34	9.25	4.31	9.39	4.19	9.07	4.13
	22	9.85	4.42	9.71	4.34	9.66	4.31	9.60	4.21	8.84	4.13
	24	9.19	4.48	9.54	4.38	9.67	4.34	9.48	4.28	8.26	4.21

Combination (Capacity)	Indoor Air Temp. °C DB	Outdoor Air Temp. °C											
		16/15		15/14		10/9		7/6		6/5		2/1	
		Total Q	Input Power	Total Q	Input Power	Total Q	Input Power	Total Q	Input Power	Total Q	Input Power	Total Q	Input Power
1.6 + 3.5 + 4.2	16	19.59	3.12	19.22	3.18	17.36	3.53	16.25	3.74	15.21	3.90	12.04	4.28
	18	18.66	3.23	18.23	3.29	16.11	3.61	14.83	3.80	13.89	3.98	11.39	4.41
	20	18.06	3.34	17.56	3.40	15.09	3.68	13.60	3.85	12.74	4.02	10.69	4.41
	21	17.83	3.40	17.30	3.45	14.64	3.66	13.04	3.79	12.21	3.97	10.31	4.43
	22	17.69	3.47	17.32	3.51	15.50	3.74	14.40	3.88	13.22	4.05	9.91	4.44
	24	17.57	3.59	16.92	3.63	13.64	3.81	11.68	3.91	10.89	4.09	9.05	4.47
1.6 + 3.5 + 5.0	16	19.59	2.90	19.22	2.97	17.36	3.29	16.25	3.49	15.21	3.64	12.04	3.99
	18	18.66	3.01	18.23	3.07	16.11	3.37	14.83	3.55	13.89	3.71	11.39	4.11
	20	18.06	3.11	17.56	3.17	15.09	3.43	13.60	3.59	12.74	3.74	10.69	4.11
	21	17.83	3.17	17.30	3.21	14.64	3.41	13.04	3.53	12.21	3.70	10.31	4.13
	22	17.69	3.23	17.32	3.28	15.50	3.49	14.40	3.62	13.22	3.77	9.91	4.14
	24	17.57	3.35	16.92	3.38	13.64	3.55	11.68	3.65	10.89	3.81	9.05	4.16
1.6 + 3.5 + 6.0	16	19.88	3.00	19.50	3.07	17.62	3.40	16.49	3.60	15.43	3.76	12.21	4.13
	18	18.93	3.11	18.50	3.17	16.34	3.48	15.05	3.66	14.10	3.83	11.56	4.25
	20	18.32	3.22	17.82	3.27	15.31	3.55	13.80	3.71	12.93	3.87	10.84	4.25
	21	18.10	3.28	17.56	3.32	14.85	3.53	13.23	3.65	12.39	3.82	10.46	4.27
	22	17.95	3.34	17.58	3.39	15.72	3.61	14.61	3.74	13.41	3.90	10.05	4.28
	24	17.83	3.46	17.17	3.50	13.84	3.67	11.85	3.77	11.05	3.94	9.19	4.30
1.6 + 3.5 + 7.1	16	19.88	2.99	19.50	3.05	17.62	3.38	16.49	3.58	15.43	3.74	12.21	4.11
	18	18.93	3.09	18.50	3.15	16.34	3.46	15.05	3.64	14.10	3.81	11.56	4.23
	20	18.32	3.20	17.82	3.25	15.31	3.53	13.80	3.69	12.93	3.85	10.84	4.23
	21	18.10	3.26	17.56	3.30	14.85	3.51	13.23	3.63	12.39	3.80	10.46	4.24
	22	17.95	3.32	17.58	3.37	15.72	3.59	14.61	3.72	13.41	3.88	10.05	4.26
	24	17.83	3.45	17.17	3.48	13.84	3.65	11.85	3.75	11.05	3.92	9.19	4.28
1.6 + 4.2 + 4.2	16	19.59	3.06	19.22	3.13	17.36	3.47	16.25	3.67	15.21	3.83	12.04	4.21
	18	18.66	3.17	18.23	3.23	16.11	3.54	14.83	3.73	13.89	3.91	11.39	4.33
	20	18.06	3.28	17.56	3.33	15.09	3.61	13.60	3.78	12.74	3.94	10.69	4.33
	21	17.83	3.34	17.30	3.38	14.64	3.59	13.04	3.72	12.21	3.90	10.31	4.35
	22	17.69	3.40	17.32	3.45	15.50	3.68	14.40	3.81	13.22	3.97	9.91	4.36
	24	17.57	3.53	16.92	3.56	13.64	3.74	11.68	3.84	10.89	4.01	9.05	4.38
1.6 + 4.2 + 5.0	16	19.88	2.99	19.50	3.06	17.62	3.39	16.49	3.59	15.43	3.75	12.21	4.12
	18	18.93	3.10	18.50	3.16	16.34	3.47	15.05	3.65	14.10	3.82	11.56	4.24
	20	18.32	3.21	17.82	3.26	15.31	3.54	13.80	3.70	12.93	3.86	10.84	4.24
	21	18.10	3.27	17.56	3.31	14.85	3.52	13.23	3.64	12.39	3.81	10.46	4.25
	22	17.95	3.33	17.58	3.38	15.72	3.60	14.61	3.73	13.41	3.89	10.05	4.27
	24	17.83	3.45	17.17	3.49	13.84	3.66	11.85	3.76	11.05	3.93	9.19	4.29



Combination (Capacity)	Indoor Air Temp. °C DB	Outdoor Air Temp. °C									
		0/-1		-5/-6		-7/-8		-10/-11		-15/-	
		Total Q	Input Power	Total Q	Input Power	Total Q	Input Power	Total Q	Input Power	Total Q	Input Power
1.6 + 3.5 + 4.2	16	11.70	4.30	10.84	4.36	10.50	4.38	10.11	4.17	9.27	4.09
	18	11.10	4.39	10.36	4.35	9.65	4.33	9.92	4.15	9.35	4.08
	20	10.49	4.39	9.98	4.32	9.78	4.30	9.75	4.17	9.22	4.08
	21	10.07	4.40	9.48	4.33	9.25	4.30	9.39	4.18	9.07	4.12
	22	9.85	4.41	9.71	4.33	9.66	4.30	9.60	4.20	8.84	4.12
	24	9.19	4.47	9.54	4.37	9.67	4.33	9.48	4.27	8.26	4.20
1.6 + 3.5 + 5.0	16	11.70	4.01	10.84	4.06	10.50	4.08	10.11	3.89	9.27	3.81
	18	11.10	4.10	10.36	4.06	9.65	4.04	9.92	3.87	9.35	3.81
	20	10.49	4.09	9.98	4.03	9.78	4.01	9.75	3.89	9.22	3.81
	21	10.07	4.10	9.48	4.04	9.25	4.01	9.39	3.90	9.07	3.84
	22	9.85	4.11	9.71	4.04	9.66	4.01	9.60	3.92	8.84	3.84
	24	9.19	4.17	9.54	4.08	9.67	4.04	9.48	3.98	8.26	3.91
1.6 + 3.5 + 6.0	16	11.87	4.15	11.00	4.20	10.66	4.22	10.26	4.02	9.41	3.94
	18	11.26	4.23	10.51	4.19	9.79	4.17	10.07	3.99	9.48	3.93
	20	10.64	4.23	10.13	4.17	9.93	4.14	9.89	4.02	9.35	3.93
	21	10.22	4.24	9.62	4.17	9.38	4.14	9.53	4.03	9.20	3.97
	22	10.00	4.25	9.86	4.17	9.80	4.14	9.74	4.05	8.97	3.97
	24	9.33	4.31	9.68	4.21	9.82	4.17	9.62	4.12	8.39	4.04
1.6 + 3.5 + 7.1	16	11.87	4.13	11.00	4.18	10.66	4.20	10.26	4.00	9.41	3.92
	18	11.26	4.21	10.51	4.17	9.79	4.15	10.07	3.97	9.48	3.91
	20	10.64	4.20	10.13	4.14	9.93	4.12	9.89	3.99	9.35	3.91
	21	10.22	4.22	9.62	4.15	9.38	4.12	9.53	4.01	9.20	3.95
	22	10.00	4.23	9.86	4.15	9.80	4.12	9.74	4.03	8.97	3.95
	24	9.33	4.28	9.68	4.19	9.82	4.15	9.62	4.09	8.39	4.02
1.6 + 4.2 + 4.2	16	11.70	4.23	10.84	4.28	10.50	4.30	10.11	4.09	9.27	4.02
	18	11.10	4.31	10.36	4.27	9.65	4.25	9.92	4.07	9.35	4.01
	20	10.49	4.31	9.98	4.25	9.78	4.22	9.75	4.09	9.22	4.01
	21	10.07	4.32	9.48	4.25	9.25	4.22	9.39	4.10	9.07	4.04
	22	9.85	4.33	9.71	4.25	9.66	4.22	9.60	4.13	8.84	4.04
	24	9.19	4.39	9.54	4.29	9.67	4.25	9.48	4.19	8.26	4.12
1.6 + 4.2 + 5.0	16	11.87	4.14	11.00	4.19	10.66	4.21	10.26	4.01	9.41	3.93
	18	11.26	4.22	10.51	4.18	9.79	4.16	10.07	3.98	9.48	3.92
	20	10.64	4.22	10.13	4.16	9.93	4.13	9.89	4.01	9.35	3.92
	21	10.22	4.23	9.62	4.16	9.38	4.13	9.53	4.02	9.20	3.96
	22	10.00	4.24	9.86	4.16	9.80	4.13	9.74	4.04	8.97	3.96
	24	9.33	4.29	9.68	4.20	9.82	4.16	9.62	4.11	8.39	4.03

Combination (Capacity)	Indoor Air Temp. °C DB	Outdoor Air Temp. °C											
		16/15		15/14		10/9		7/6		6/5		2/1	
		Total Q	Input Power	Total Q	Input Power	Total Q	Input Power	Total Q	Input Power	Total Q	Input Power	Total Q	Input Power
1.6 + 4.2 + 6.0	16	19.88	2.99	19.50	3.06	17.62	3.39	16.49	3.59	15.43	3.75	12.21	4.12
	18	18.93	3.10	18.50	3.16	16.34	3.47	15.05	3.65	14.10	3.82	11.56	4.24
	20	18.32	3.21	17.82	3.26	15.31	3.54	13.80	3.70	12.93	3.86	10.84	4.24
	21	18.10	3.27	17.56	3.31	14.85	3.52	13.23	3.64	12.39	3.81	10.46	4.25
	22	17.95	3.33	17.58	3.38	15.72	3.60	14.61	3.73	13.41	3.89	10.05	4.27
	24	17.83	3.45	17.17	3.49	13.84	3.66	11.85	3.76	11.05	3.93	9.19	4.29
1.6 + 4.2 + 7.1	16	20.31	3.07	19.92	3.14	18.00	3.48	16.85	3.69	15.77	3.85	12.48	4.23
	18	19.34	3.19	18.90	3.25	16.70	3.56	15.38	3.75	14.40	3.93	11.81	4.35
	20	18.72	3.30	18.21	3.35	15.64	3.63	14.10	3.80	13.21	3.96	11.08	4.35
	21	18.49	3.36	17.94	3.40	15.18	3.61	13.52	3.74	12.66	3.92	10.69	4.37
	22	18.34	3.42	17.96	3.47	16.07	3.69	14.93	3.83	13.71	4.00	10.27	4.39
	24	18.22	3.55	17.54	3.58	14.15	3.76	12.11	3.86	11.29	4.03	9.39	4.41
1.6 + 5.0 + 5.0	16	19.88	2.83	19.50	2.89	17.62	3.21	16.49	3.40	15.43	3.55	12.21	3.89
	18	18.93	2.93	18.50	2.99	16.34	3.28	15.05	3.46	14.10	3.62	11.56	4.01
	20	18.32	3.04	17.82	3.09	15.31	3.35	13.80	3.50	12.93	3.65	10.84	4.01
	21	18.10	3.09	17.56	3.13	14.85	3.33	13.23	3.44	12.39	3.61	10.46	4.02
	22	17.95	3.15	17.58	3.19	15.72	3.40	14.61	3.53	13.41	3.68	10.05	4.04
	24	17.83	3.27	17.17	3.30	13.84	3.46	11.85	3.56	11.05	3.71	9.19	4.06
1.6 + 5.0 + 6.0	16	19.88	2.83	19.50	2.89	17.62	3.21	16.49	3.40	15.43	3.55	12.21	3.89
	18	18.93	2.93	18.50	2.99	16.34	3.28	15.05	3.46	14.10	3.62	11.56	4.01
	20	18.32	3.04	17.82	3.09	15.31	3.35	13.80	3.50	12.93	3.65	10.84	4.01
	21	18.10	3.09	17.56	3.13	14.85	3.33	13.23	3.44	12.39	3.61	10.46	4.02
	22	17.95	3.15	17.58	3.19	15.72	3.40	14.61	3.53	13.41	3.68	10.05	4.04
	24	17.83	3.27	17.17	3.30	13.84	3.46	11.85	3.56	11.05	3.71	9.19	4.06
1.6 + 5.0 + 7.1	16	20.31	2.95	19.92	3.02	18.00	3.35	16.85	3.54	15.77	3.70	12.48	4.06
	18	19.34	3.06	18.90	3.12	16.70	3.42	15.38	3.60	14.40	3.77	11.81	4.18
	20	18.72	3.17	18.21	3.22	15.64	3.49	14.10	3.65	13.21	3.81	11.08	4.18
	21	18.49	3.23	17.94	3.27	15.18	3.47	13.52	3.59	12.66	3.76	10.69	4.20
	22	18.34	3.29	17.96	3.33	16.07	3.55	14.93	3.68	13.71	3.84	10.27	4.21
	24	18.22	3.41	17.54	3.44	14.15	3.61	12.11	3.71	11.29	3.87	9.39	4.23
1.6 + 6.0 + 6.0	16	20.31	2.97	19.92	3.04	18.00	3.37	16.85	3.56	15.77	3.72	12.48	4.08
	18	19.34	3.08	18.90	3.14	16.70	3.44	15.38	3.62	14.40	3.79	11.81	4.20
	20	18.72	3.18	18.21	3.24	15.64	3.51	14.10	3.67	13.21	3.83	11.08	4.20
	21	18.49	3.24	17.94	3.28	15.18	3.49	13.52	3.61	12.66	3.78	10.69	4.22
	22	18.34	3.30	17.96	3.35	16.07	3.57	14.93	3.70	13.71	3.86	10.27	4.24
	24	18.22	3.43	17.54	3.46	14.15	3.63	12.11	3.73	11.29	3.90	9.39	4.26

Combination (Capacity)	Indoor Air Temp. °C DB	Outdoor Air Temp. °C									
		0/-1		-5/-6		-7/-8		-10/-11		-15/-	
		Total Q	Input Power	Total Q	Input Power	Total Q	Input Power	Total Q	Input Power	Total Q	Input Power
1.6 + 4.2 + 6.0	16	11.87	4.14	11.00	4.19	10.66	4.21	10.26	4.01	9.41	3.93
	18	11.26	4.22	10.51	4.18	9.79	4.16	10.07	3.98	9.48	3.92
	20	10.64	4.22	10.13	4.16	9.93	4.13	9.89	4.01	9.35	3.92
	21	10.22	4.23	9.62	4.16	9.38	4.13	9.53	4.02	9.20	3.96
	22	10.00	4.24	9.86	4.16	9.80	4.13	9.74	4.04	8.97	3.96
	24	9.33	4.29	9.68	4.20	9.82	4.16	9.62	4.11	8.39	4.03
1.6 + 4.2 + 7.1	16	12.13	4.25	11.24	4.30	10.89	4.32	10.48	4.12	9.61	4.04
	18	11.51	4.34	10.74	4.29	10.01	4.28	10.28	4.09	9.69	4.03
	20	10.87	4.33	10.35	4.27	10.14	4.24	10.11	4.11	9.55	4.03
	21	10.44	4.34	9.83	4.27	9.59	4.24	9.74	4.13	9.40	4.07
	22	10.21	4.35	10.07	4.28	10.01	4.24	9.96	4.15	9.17	4.07
	24	9.53	4.41	9.89	4.31	10.03	4.28	9.83	4.22	8.57	4.14
1.6 + 5.0 + 5.0	16	11.87	3.91	11.00	3.96	10.66	3.98	10.26	3.79	9.41	3.72
	18	11.26	3.99	10.51	3.95	9.79	3.94	10.07	3.77	9.48	3.71
	20	10.64	3.99	10.13	3.93	9.93	3.91	9.89	3.79	9.35	3.71
	21	10.22	4.00	9.62	3.93	9.38	3.91	9.53	3.80	9.20	3.75
	22	10.00	4.01	9.86	3.94	9.80	3.91	9.74	3.82	8.97	3.75
	24	9.33	4.06	9.68	3.97	9.82	3.94	9.62	3.88	8.39	3.82
1.6 + 5.0 + 6.0	16	11.87	3.91	11.00	3.96	10.66	3.98	10.26	3.79	9.41	3.72
	18	11.26	3.99	10.51	3.95	9.79	3.94	10.07	3.77	9.48	3.71
	20	10.64	3.99	10.13	3.93	9.93	3.91	9.89	3.79	9.35	3.71
	21	10.22	4.00	9.62	3.93	9.38	3.91	9.53	3.80	9.20	3.75
	22	10.00	4.01	9.86	3.94	9.80	3.91	9.74	3.82	8.97	3.75
	24	9.33	4.06	9.68	3.97	9.82	3.94	9.62	3.88	8.39	3.82
1.6 + 5.0 + 7.1	16	12.13	4.08	11.24	4.13	10.89	4.15	10.48	3.95	9.61	3.88
	18	11.51	4.17	10.74	4.12	10.01	4.11	10.28	3.93	9.69	3.87
	20	10.87	4.16	10.35	4.10	10.14	4.08	10.11	3.95	9.55	3.87
	21	10.44	4.17	9.83	4.10	9.59	4.08	9.74	3.96	9.40	3.91
	22	10.21	4.18	10.07	4.11	10.01	4.08	9.96	3.99	9.17	3.91
	24	9.53	4.24	9.89	4.14	10.03	4.11	9.83	4.05	8.57	3.98
1.6 + 6.0 + 6.0	16	12.13	4.10	11.24	4.15	10.89	4.17	10.48	3.97	9.61	3.90
	18	11.51	4.19	10.74	4.15	10.01	4.13	10.28	3.95	9.69	3.89
	20	10.87	4.18	10.35	4.12	10.14	4.10	10.11	3.97	9.55	3.89
	21	10.44	4.19	9.83	4.13	9.59	4.10	9.74	3.98	9.40	3.93
	22	10.21	4.20	10.07	4.13	10.01	4.10	9.96	4.01	9.17	3.93
	24	9.53	4.26	9.89	4.17	10.03	4.13	9.83	4.07	8.57	4.00

Combination (Capacity)	Indoor Air Temp. °C DB	Outdoor Air Temp. °C											
		16/15		15/14		10/9		7/6		6/5		2/1	
		Total Q	Input Power	Total Q	Input Power	Total Q	Input Power	Total Q	Input Power	Total Q	Input Power	Total Q	Input Power
1.6 + 6.0 + 7.1	16	20.31	2.95	19.92	3.02	18.00	3.35	16.85	3.54	15.77	3.70	12.48	4.06
	18	19.34	3.06	18.90	3.12	16.70	3.42	15.38	3.60	14.40	3.77	11.81	4.18
	20	18.72	3.17	18.21	3.22	15.64	3.49	14.10	3.65	13.21	3.81	11.08	4.18
	21	18.49	3.23	17.94	3.27	15.18	3.47	13.52	3.59	12.66	3.76	10.69	4.20
	22	18.34	3.29	17.96	3.33	16.07	3.55	14.93	3.68	13.71	3.84	10.27	4.21
	24	18.22	3.41	17.54	3.44	14.15	3.61	12.11	3.71	11.29	3.87	9.39	4.23
1.6 + 7.1 + 7.1	16	20.74	3.03	20.35	3.10	18.38	3.44	17.20	3.64	16.10	3.80	12.75	4.17
	18	19.75	3.14	19.30	3.21	17.05	3.52	15.70	3.70	14.71	3.87	12.06	4.30
	20	19.12	3.25	18.60	3.31	15.97	3.58	14.40	3.75	13.49	3.91	11.32	4.30
	21	18.88	3.31	18.32	3.36	15.50	3.56	13.81	3.69	12.93	3.87	10.92	4.31
	22	18.73	3.38	18.34	3.42	16.41	3.65	15.25	3.78	14.00	3.94	10.49	4.33
	24	18.61	3.50	17.91	3.54	14.45	3.71	12.37	3.81	11.53	3.98	9.59	4.35
2.0 + 2.0 + 2.0	16	17.72	2.71	17.38	2.77	15.70	3.07	14.70	3.25	13.75	3.39	10.89	3.73
	18	16.87	2.81	16.49	2.86	14.57	3.14	13.41	3.31	12.56	3.46	10.30	3.84
	20	16.33	2.91	15.88	2.95	13.64	3.20	12.30	3.35	11.52	3.49	9.67	3.84
	21	16.13	2.96	15.65	3.00	13.24	3.18	11.79	3.30	11.04	3.45	9.32	3.85
	22	16.00	3.02	15.67	3.06	14.02	3.26	13.03	3.38	11.96	3.52	8.96	3.87
	24	15.89	3.13	15.30	3.16	12.34	3.31	10.56	3.41	9.85	3.56	8.19	3.89
2.0 + 2.0 + 2.5	16	17.72	2.71	17.38	2.77	15.70	3.07	14.70	3.25	13.75	3.39	10.89	3.73
	18	16.87	2.81	16.49	2.86	14.57	3.14	13.41	3.31	12.56	3.46	10.30	3.84
	20	16.33	2.91	15.88	2.95	13.64	3.20	12.30	3.35	11.52	3.49	9.67	3.84
	21	16.13	2.96	15.65	3.00	13.24	3.18	11.79	3.30	11.04	3.45	9.32	3.85
	22	16.00	3.02	15.67	3.06	14.02	3.26	13.03	3.38	11.96	3.52	8.96	3.87
	24	15.89	3.13	15.30	3.16	12.34	3.31	10.56	3.41	9.85	3.56	8.19	3.89
2.0 + 2.0 + 3.5	16	17.72	2.64	17.38	2.70	15.70	2.99	14.70	3.17	13.75	3.30	10.89	3.63
	18	16.87	2.73	16.49	2.79	14.57	3.06	13.41	3.22	12.56	3.37	10.30	3.74
	20	16.33	2.83	15.88	2.88	13.64	3.12	12.30	3.26	11.52	3.40	9.67	3.74
	21	16.13	2.88	15.65	2.92	13.24	3.10	11.79	3.21	11.04	3.36	9.32	3.75
	22	16.00	2.94	15.67	2.97	14.02	3.17	13.03	3.29	11.96	3.43	8.96	3.76
	24	15.89	3.04	15.30	3.07	12.34	3.22	10.56	3.31	9.85	3.46	8.19	3.78
2.0 + 2.0 + 4.2	16	18.58	2.86	18.23	2.92	16.47	3.24	15.41	3.43	14.43	3.58	11.42	3.93
	18	17.70	2.96	17.29	3.02	15.28	3.31	14.07	3.49	13.18	3.65	10.81	4.04
	20	17.13	3.06	16.66	3.11	14.31	3.37	12.90	3.53	12.08	3.68	10.14	4.04
	21	16.92	3.12	16.41	3.16	13.89	3.35	12.37	3.47	11.58	3.64	9.78	4.06
	22	16.78	3.18	16.43	3.22	14.70	3.43	13.66	3.56	12.54	3.71	9.40	4.07
	24	16.67	3.30	16.05	3.33	12.94	3.49	11.08	3.59	10.33	3.75	8.59	4.09

Combination (Capacity)	Indoor Air Temp. °C DB	Outdoor Air Temp. °C									
		0/-1		-5/-6		-7/-8		-10/-11		-15/-	
		Total Q	Input Power	Total Q	Input Power	Total Q	Input Power	Total Q	Input Power	Total Q	Input Power
1.6 + 6.0 + 7.1	16	12.13	4.08	11.24	4.13	10.89	4.15	10.48	3.95	9.61	3.88
	18	11.51	4.17	10.74	4.12	10.01	4.11	10.28	3.93	9.69	3.87
	20	10.87	4.16	10.35	4.10	10.14	4.08	10.11	3.95	9.55	3.87
	21	10.44	4.17	9.83	4.10	9.59	4.08	9.74	3.96	9.40	3.91
	22	10.21	4.18	10.07	4.11	10.01	4.08	9.96	3.99	9.17	3.91
	24	9.53	4.24	9.89	4.14	10.03	4.11	9.83	4.05	8.57	3.98
1.6 + 7.1 + 7.1	16	12.38	4.19	11.48	4.24	11.12	4.27	10.70	4.06	9.82	3.98
	18	11.75	4.28	10.97	4.24	10.22	4.22	10.50	4.04	9.90	3.98
	20	11.10	4.27	10.57	4.21	10.36	4.19	10.32	4.06	9.76	3.98
	21	10.67	4.28	10.04	4.22	9.79	4.19	9.94	4.07	9.60	4.01
	22	10.43	4.30	10.28	4.22	10.22	4.19	10.17	4.09	9.36	4.01
	24	9.73	4.35	10.10	4.26	10.24	4.22	10.04	4.16	8.75	4.09
2.0 + 2.0 + 2.0	16	10.58	3.75	9.81	3.79	9.50	3.81	9.14	3.63	8.39	3.56
	18	10.04	3.82	9.37	3.78	8.73	3.77	8.97	3.61	8.45	3.55
	20	9.48	3.82	9.03	3.76	8.85	3.74	8.82	3.63	8.33	3.55
	21	9.11	3.83	8.58	3.77	8.36	3.74	8.49	3.64	8.20	3.58
	22	8.91	3.84	8.78	3.77	8.73	3.74	8.68	3.66	8.00	3.58
	24	8.31	3.89	8.62	3.80	8.75	3.77	8.57	3.72	7.47	3.65
2.0 + 2.0 + 2.5	16	10.58	3.75	9.81	3.79	9.50	3.81	9.14	3.63	8.39	3.56
	18	10.04	3.82	9.37	3.78	8.73	3.77	8.97	3.61	8.45	3.55
	20	9.48	3.82	9.03	3.76	8.85	3.74	8.82	3.63	8.33	3.55
	21	9.11	3.83	8.58	3.77	8.36	3.74	8.49	3.64	8.20	3.58
	22	8.91	3.84	8.78	3.77	8.73	3.74	8.68	3.66	8.00	3.58
	24	8.31	3.89	8.62	3.80	8.75	3.77	8.57	3.72	7.47	3.65
2.0 + 2.0 + 3.5	16	10.58	3.65	9.81	3.69	9.50	3.71	9.14	3.53	8.39	3.46
	18	10.04	3.72	9.37	3.68	8.73	3.67	8.97	3.51	8.45	3.46
	20	9.48	3.71	9.03	3.66	8.85	3.64	8.82	3.53	8.33	3.46
	21	9.11	3.72	8.58	3.66	8.36	3.64	8.49	3.54	8.20	3.49
	22	8.91	3.74	8.78	3.67	8.73	3.64	8.68	3.56	8.00	3.49
	24	8.31	3.78	8.62	3.70	8.75	3.67	8.57	3.62	7.47	3.55
2.0 + 2.0 + 4.2	16	11.09	3.95	10.29	4.00	9.96	4.02	9.59	3.82	8.79	3.75
	18	10.53	4.03	9.83	3.99	9.16	3.97	9.41	3.80	8.87	3.74
	20	9.95	4.02	9.47	3.96	9.28	3.94	9.25	3.82	8.74	3.74
	21	9.56	4.03	8.99	3.97	8.77	3.94	8.91	3.83	8.60	3.78
	22	9.34	4.04	9.21	3.97	9.16	3.94	9.11	3.85	8.39	3.78
	24	8.72	4.10	9.04	4.01	9.18	3.97	8.99	3.92	7.84	3.85

Combination (Capacity)	Indoor Air Temp. °C DB	Outdoor Air Temp. °C											
		16/15		15/14		10/9		7/6		6/5		2/1	
		Total Q	Input Power	Total Q	Input Power	Total Q	Input Power	Total Q	Input Power	Total Q	Input Power	Total Q	Input Power
2.0 + 2.0 + 5.0	16	19.59	2.93	19.22	2.99	17.36	3.32	16.25	3.51	15.21	3.67	12.04	4.03
	18	18.66	3.03	18.23	3.09	16.11	3.39	14.83	3.57	13.89	3.74	11.39	4.15
	20	18.06	3.14	17.56	3.19	15.09	3.46	13.60	3.62	12.74	3.78	10.69	4.15
	21	17.83	3.20	17.30	3.24	14.64	3.44	13.04	3.56	12.21	3.73	10.31	4.16
	22	17.69	3.26	17.32	3.30	15.50	3.52	14.40	3.65	13.22	3.81	9.91	4.18
	24	17.57	3.38	16.92	3.41	13.64	3.58	11.68	3.68	10.89	3.84	9.05	4.20
2.0 + 2.0 + 6.0	16	19.59	2.93	19.22	2.99	17.36	3.32	16.25	3.51	15.21	3.67	12.04	4.03
	18	18.66	3.03	18.23	3.09	16.11	3.39	14.83	3.57	13.89	3.74	11.39	4.15
	20	18.06	3.14	17.56	3.19	15.09	3.46	13.60	3.62	12.74	3.78	10.69	4.15
	21	17.83	3.20	17.30	3.24	14.64	3.44	13.04	3.56	12.21	3.73	10.31	4.16
	22	17.69	3.26	17.32	3.30	15.50	3.52	14.40	3.65	13.22	3.81	9.91	4.18
	24	17.57	3.38	16.92	3.41	13.64	3.58	11.68	3.68	10.89	3.84	9.05	4.20
2.0 + 2.0 + 7.1	16	19.88	3.00	19.50	3.07	17.62	3.40	16.49	3.60	15.43	3.76	12.21	4.13
	18	18.93	3.11	18.50	3.17	16.34	3.48	15.05	3.66	14.10	3.83	11.56	4.25
	20	18.32	3.22	17.82	3.27	15.31	3.55	13.80	3.71	12.93	3.87	10.84	4.25
	21	18.10	3.28	17.56	3.32	14.85	3.53	13.23	3.65	12.39	3.82	10.46	4.27
	22	17.95	3.34	17.58	3.39	15.72	3.61	14.61	3.74	13.41	3.90	10.05	4.28
	24	17.83	3.46	17.17	3.50	13.84	3.67	11.85	3.77	11.05	3.94	9.19	4.30
2.0 + 2.5 + 2.5	16	17.72	2.71	17.38	2.77	15.70	3.07	14.70	3.25	13.75	3.39	10.89	3.73
	18	16.87	2.81	16.49	2.86	14.57	3.14	13.41	3.31	12.56	3.46	10.30	3.84
	20	16.33	2.91	15.88	2.95	13.64	3.20	12.30	3.35	11.52	3.49	9.67	3.84
	21	16.13	2.96	15.65	3.00	13.24	3.18	11.79	3.30	11.04	3.45	9.32	3.85
	22	16.00	3.02	15.67	3.06	14.02	3.26	13.03	3.38	11.96	3.52	8.96	3.87
	24	15.89	3.13	15.30	3.16	12.34	3.31	10.56	3.41	9.85	3.56	8.19	3.89
2.0 + 2.5 + 3.5	16	18.58	2.86	18.23	2.93	16.47	3.25	15.41	3.44	14.43	3.59	11.42	3.94
	18	17.70	2.97	17.29	3.03	15.28	3.32	14.07	3.50	13.18	3.66	10.81	4.06
	20	17.13	3.07	16.66	3.12	14.31	3.38	12.90	3.54	12.08	3.69	10.14	4.06
	21	16.92	3.13	16.41	3.17	13.89	3.36	12.37	3.48	11.58	3.65	9.78	4.07
	22	16.78	3.19	16.43	3.23	14.70	3.44	13.66	3.57	12.54	3.72	9.40	4.09
	24	16.67	3.30	16.05	3.34	12.94	3.50	11.08	3.60	10.33	3.76	8.59	4.11
2.0 + 2.5 + 4.2	16	19.59	3.13	19.22	3.20	17.36	3.55	16.25	3.76	15.21	3.92	12.04	4.31
	18	18.66	3.24	18.23	3.31	16.11	3.63	14.83	3.82	13.89	4.00	11.39	4.43
	20	18.06	3.36	17.56	3.41	15.09	3.70	13.60	3.87	12.74	4.04	10.69	4.43
	21	17.83	3.42	17.30	3.46	14.64	3.68	13.04	3.81	12.21	3.99	10.31	4.45
	22	17.69	3.48	17.32	3.53	15.50	3.76	14.40	3.90	13.22	4.07	9.91	4.47
	24	17.57	3.61	16.92	3.65	13.64	3.83	11.68	3.93	10.89	4.11	9.05	4.49

Combination (Capacity)	Indoor Air Temp. °C DB	Outdoor Air Temp. °C									
		0/-1		-5/-6		-7/-8		-10/-11		-15/-	
		Total Q	Input Power	Total Q	Input Power	Total Q	Input Power	Total Q	Input Power	Total Q	Input Power
2.0 + 2.0 + 5.0	16	11.70	4.05	10.84	4.10	10.50	4.12	10.11	3.92	9.27	3.85
	18	11.10	4.13	10.36	4.09	9.65	4.07	9.92	3.90	9.35	3.84
	20	10.49	4.12	9.98	4.07	9.78	4.04	9.75	3.92	9.22	3.84
	21	10.07	4.14	9.48	4.07	9.25	4.04	9.39	3.93	9.07	3.87
	22	9.85	4.15	9.71	4.07	9.66	4.04	9.60	3.95	8.84	3.87
	24	9.19	4.20	9.54	4.11	9.67	4.07	9.48	4.02	8.26	3.95
2.0 + 2.0 + 6.0	16	11.70	4.05	10.84	4.10	10.50	4.12	10.11	3.92	9.27	3.85
	18	11.10	4.13	10.36	4.09	9.65	4.07	9.92	3.90	9.35	3.84
	20	10.49	4.12	9.98	4.07	9.78	4.04	9.75	3.92	9.22	3.84
	21	10.07	4.14	9.48	4.07	9.25	4.04	9.39	3.93	9.07	3.87
	22	9.85	4.15	9.71	4.07	9.66	4.04	9.60	3.95	8.84	3.87
	24	9.19	4.20	9.54	4.11	9.67	4.07	9.48	4.02	8.26	3.95
2.0 + 2.0 + 7.1	16	11.87	4.15	11.00	4.20	10.66	4.22	10.26	4.02	9.41	3.94
	18	11.26	4.23	10.51	4.19	9.79	4.17	10.07	3.99	9.48	3.93
	20	10.64	4.23	10.13	4.17	9.93	4.14	9.89	4.02	9.35	3.93
	21	10.22	4.24	9.62	4.17	9.38	4.14	9.53	4.03	9.20	3.97
	22	10.00	4.25	9.86	4.17	9.80	4.14	9.74	4.05	8.97	3.97
	24	9.33	4.31	9.68	4.21	9.82	4.17	9.62	4.12	8.39	4.04
2.0 + 2.5 + 2.5	16	10.58	3.75	9.81	3.79	9.50	3.81	9.14	3.63	8.39	3.56
	18	10.04	3.82	9.37	3.78	8.73	3.77	8.97	3.61	8.45	3.55
	20	9.48	3.82	9.03	3.76	8.85	3.74	8.82	3.63	8.33	3.55
	21	9.11	3.83	8.58	3.77	8.36	3.74	8.49	3.64	8.20	3.58
	22	8.91	3.84	8.78	3.77	8.73	3.74	8.68	3.66	8.00	3.58
	24	8.31	3.89	8.62	3.80	8.75	3.77	8.57	3.72	7.47	3.65
2.0 + 2.5 + 3.5	16	11.09	3.96	10.29	4.01	9.96	4.03	9.59	3.83	8.79	3.76
	18	10.53	4.04	9.83	4.00	9.16	3.98	9.41	3.81	8.87	3.75
	20	9.95	4.03	9.47	3.98	9.28	3.95	9.25	3.83	8.74	3.75
	21	9.56	4.04	8.99	3.98	8.77	3.95	8.91	3.84	8.60	3.79
	22	9.34	4.06	9.21	3.98	9.16	3.95	9.11	3.87	8.39	3.79
	24	8.72	4.11	9.04	4.02	9.18	3.98	8.99	3.93	7.84	3.86
2.0 + 2.5 + 4.2	16	11.70	4.33	10.84	4.38	10.50	4.40	10.11	4.19	9.27	4.11
	18	11.10	4.42	10.36	4.37	9.65	4.35	9.92	4.17	9.35	4.10
	20	10.49	4.41	9.98	4.35	9.78	4.32	9.75	4.19	9.22	4.10
	21	10.07	4.42	9.48	4.35	9.25	4.32	9.39	4.20	9.07	4.14
	22	9.85	4.43	9.71	4.35	9.66	4.32	9.60	4.23	8.84	4.14
	24	9.19	4.49	9.54	4.39	9.67	4.35	9.48	4.29	8.26	4.22

Combination (Capacity)	Indoor Air Temp. °C DB	Outdoor Air Temp. °C											
		16/15		15/14		10/9		7/6		6/5		2/1	
		Total Q	Input Power	Total Q	Input Power	Total Q	Input Power	Total Q	Input Power	Total Q	Input Power	Total Q	Input Power
2.0 + 2.5 + 5.0	16	19.59	2.93	19.22	2.99	17.36	3.32	16.25	3.51	15.21	3.67	12.04	4.03
	18	18.66	3.03	18.23	3.09	16.11	3.39	14.83	3.57	13.89	3.74	11.39	4.15
	20	18.06	3.14	17.56	3.19	15.09	3.46	13.60	3.62	12.74	3.78	10.69	4.15
	21	17.83	3.20	17.30	3.24	14.64	3.44	13.04	3.56	12.21	3.73	10.31	4.16
	22	17.69	3.26	17.32	3.30	15.50	3.52	14.40	3.65	13.22	3.81	9.91	4.18
	24	17.57	3.38	16.92	3.41	13.64	3.58	11.68	3.68	10.89	3.84	9.05	4.20
2.0 + 2.5 + 6.0	16	19.88	3.02	19.50	3.09	17.62	3.42	16.49	3.62	15.43	3.78	12.21	4.15
	18	18.93	3.13	18.50	3.19	16.34	3.50	15.05	3.68	14.10	3.85	11.56	4.27
	20	18.32	3.23	17.82	3.29	15.31	3.56	13.80	3.73	12.93	3.89	10.84	4.27
	21	18.10	3.30	17.56	3.34	14.85	3.54	13.23	3.67	12.39	3.85	10.46	4.29
	22	17.95	3.36	17.58	3.40	15.72	3.63	14.61	3.76	13.41	3.92	10.05	4.30
	24	17.83	3.48	17.17	3.52	13.84	3.69	11.85	3.79	11.05	3.96	9.19	4.33
2.0 + 2.5 + 7.1	16	19.88	3.00	19.50	3.07	17.62	3.40	16.49	3.60	15.43	3.76	12.21	4.13
	18	18.93	3.11	18.50	3.17	16.34	3.48	15.05	3.66	14.10	3.83	11.56	4.25
	20	18.32	3.22	17.82	3.27	15.31	3.55	13.80	3.71	12.93	3.87	10.84	4.25
	21	18.10	3.28	17.56	3.32	14.85	3.53	13.23	3.65	12.39	3.82	10.46	4.27
	22	17.95	3.34	17.58	3.39	15.72	3.61	14.61	3.74	13.41	3.90	10.05	4.28
	24	17.83	3.46	17.17	3.50	13.84	3.67	11.85	3.77	11.05	3.94	9.19	4.30
2.0 + 3.5 + 3.5	16	19.59	3.12	19.22	3.18	17.36	3.53	16.25	3.74	15.21	3.90	12.04	4.28
	18	18.66	3.23	18.23	3.29	16.11	3.61	14.83	3.80	13.89	3.98	11.39	4.41
	20	18.06	3.34	17.56	3.40	15.09	3.68	13.60	3.85	12.74	4.02	10.69	4.41
	21	17.83	3.40	17.30	3.45	14.64	3.66	13.04	3.79	12.21	3.97	10.31	4.43
	22	17.69	3.47	17.32	3.51	15.50	3.74	14.40	3.88	13.22	4.05	9.91	4.44
	24	17.57	3.59	16.92	3.63	13.64	3.81	11.68	3.91	10.89	4.09	9.05	4.47
2.0 + 3.5 + 4.2	16	19.59	3.06	19.22	3.13	17.36	3.47	16.25	3.67	15.21	3.83	12.04	4.21
	18	18.66	3.17	18.23	3.23	16.11	3.54	14.83	3.73	13.89	3.91	11.39	4.33
	20	18.06	3.28	17.56	3.33	15.09	3.61	13.60	3.78	12.74	3.94	10.69	4.33
	21	17.83	3.34	17.30	3.38	14.64	3.59	13.04	3.72	12.21	3.90	10.31	4.35
	22	17.69	3.40	17.32	3.45	15.50	3.68	14.40	3.81	13.22	3.97	9.91	4.36
	24	17.57	3.53	16.92	3.56	13.64	3.74	11.68	3.84	10.89	4.01	9.05	4.38
2.0 + 3.5 + 5.0	16	19.88	2.99	19.50	3.06	17.62	3.39	16.49	3.59	15.43	3.75	12.21	4.12
	18	18.93	3.10	18.50	3.16	16.34	3.47	15.05	3.65	14.10	3.82	11.56	4.24
	20	18.32	3.21	17.82	3.26	15.31	3.54	13.80	3.70	12.93	3.86	10.84	4.24
	21	18.10	3.27	17.56	3.31	14.85	3.52	13.23	3.64	12.39	3.81	10.46	4.25
	22	17.95	3.33	17.58	3.38	15.72	3.60	14.61	3.73	13.41	3.89	10.05	4.27
	24	17.83	3.45	17.17	3.49	13.84	3.66	11.85	3.76	11.05	3.93	9.19	4.29



Combination (Capacity)	Indoor Air Temp. °C DB	Outdoor Air Temp. °C									
		0/-1		-5/-6		-7/-8		-10/-11		-15/-	
		Total Q	Input Power	Total Q	Input Power	Total Q	Input Power	Total Q	Input Power	Total Q	Input Power
2.0 + 2.5 + 5.0	16	11.70	4.05	10.84	4.10	10.50	4.12	10.11	3.92	9.27	3.85
	18	11.10	4.13	10.36	4.09	9.65	4.07	9.92	3.90	9.35	3.84
	20	10.49	4.12	9.98	4.07	9.78	4.04	9.75	3.92	9.22	3.84
	21	10.07	4.14	9.48	4.07	9.25	4.04	9.39	3.93	9.07	3.87
	22	9.85	4.15	9.71	4.07	9.66	4.04	9.60	3.95	8.84	3.87
	24	9.19	4.20	9.54	4.11	9.67	4.07	9.48	4.02	8.26	3.95
2.0 + 2.5 + 6.0	16	11.87	4.17	11.00	4.22	10.66	4.24	10.26	4.04	9.41	3.96
	18	11.26	4.26	10.51	4.21	9.79	4.20	10.07	4.02	9.48	3.95
	20	10.64	4.25	10.13	4.19	9.93	4.17	9.89	4.04	9.35	3.95
	21	10.22	4.26	9.62	4.19	9.38	4.17	9.53	4.05	9.20	3.99
	22	10.00	4.27	9.86	4.20	9.80	4.17	9.74	4.07	8.97	3.99
	24	9.33	4.33	9.68	4.23	9.82	4.20	9.62	4.14	8.39	4.07
2.0 + 2.5 + 7.1	16	11.87	4.15	11.00	4.20	10.66	4.22	10.26	4.02	9.41	3.94
	18	11.26	4.23	10.51	4.19	9.79	4.17	10.07	3.99	9.48	3.93
	20	10.64	4.23	10.13	4.17	9.93	4.14	9.89	4.02	9.35	3.93
	21	10.22	4.24	9.62	4.17	9.38	4.14	9.53	4.03	9.20	3.97
	22	10.00	4.25	9.86	4.17	9.80	4.14	9.74	4.05	8.97	3.97
	24	9.33	4.31	9.68	4.21	9.82	4.17	9.62	4.12	8.39	4.04
2.0 + 3.5 + 3.5	16	11.70	4.30	10.84	4.36	10.50	4.38	10.11	4.17	9.27	4.09
	18	11.10	4.39	10.36	4.35	9.65	4.33	9.92	4.15	9.35	4.08
	20	10.49	4.39	9.98	4.32	9.78	4.30	9.75	4.17	9.22	4.08
	21	10.07	4.40	9.48	4.33	9.25	4.30	9.39	4.18	9.07	4.12
	22	9.85	4.41	9.71	4.33	9.66	4.30	9.60	4.20	8.84	4.12
	24	9.19	4.47	9.54	4.37	9.67	4.33	9.48	4.27	8.26	4.20
2.0 + 3.5 + 4.2	16	11.70	4.23	10.84	4.28	10.50	4.30	10.11	4.09	9.27	4.02
	18	11.10	4.31	10.36	4.27	9.65	4.25	9.92	4.07	9.35	4.01
	20	10.49	4.31	9.98	4.25	9.78	4.22	9.75	4.09	9.22	4.01
	21	10.07	4.32	9.48	4.25	9.25	4.22	9.39	4.10	9.07	4.04
	22	9.85	4.33	9.71	4.25	9.66	4.22	9.60	4.13	8.84	4.04
	24	9.19	4.39	9.54	4.29	9.67	4.25	9.48	4.19	8.26	4.12
2.0 + 3.5 + 5.0	16	11.87	4.14	11.00	4.19	10.66	4.21	10.26	4.01	9.41	3.93
	18	11.26	4.22	10.51	4.18	9.79	4.16	10.07	3.98	9.48	3.92
	20	10.64	4.22	10.13	4.16	9.93	4.13	9.89	4.01	9.35	3.92
	21	10.22	4.23	9.62	4.16	9.38	4.13	9.53	4.02	9.20	3.96
	22	10.00	4.24	9.86	4.16	9.80	4.13	9.74	4.04	8.97	3.96
	24	9.33	4.29	9.68	4.20	9.82	4.16	9.62	4.11	8.39	4.03

Combination (Capacity)	Indoor Air Temp. °C DB	Outdoor Air Temp. °C											
		16/15		15/14		10/9		7/6		6/5		2/1	
		Total Q	Input Power	Total Q	Input Power	Total Q	Input Power	Total Q	Input Power	Total Q	Input Power	Total Q	Input Power
2.0 + 3.5 + 6.0	16	19.88	2.99	19.50	3.06	17.62	3.39	16.49	3.59	15.43	3.75	12.21	4.12
	18	18.93	3.10	18.50	3.16	16.34	3.47	15.05	3.65	14.10	3.82	11.56	4.24
	20	18.32	3.21	17.82	3.26	15.31	3.54	13.80	3.70	12.93	3.86	10.84	4.24
	21	18.10	3.27	17.56	3.31	14.85	3.52	13.23	3.64	12.39	3.81	10.46	4.25
	22	17.95	3.33	17.58	3.38	15.72	3.60	14.61	3.73	13.41	3.89	10.05	4.27
	24	17.83	3.45	17.17	3.49	13.84	3.66	11.85	3.76	11.05	3.93	9.19	4.29
2.0 + 3.5 + 7.1	16	19.88	2.98	19.50	3.04	17.62	3.37	16.49	3.57	15.43	3.73	12.21	4.09
	18	18.93	3.08	18.50	3.15	16.34	3.45	15.05	3.63	14.10	3.80	11.56	4.22
	20	18.32	3.19	17.82	3.25	15.31	3.52	13.80	3.68	12.93	3.84	10.84	4.22
	21	18.10	3.25	17.56	3.29	14.85	3.50	13.23	3.62	12.39	3.79	10.46	4.23
	22	17.95	3.31	17.58	3.36	15.72	3.58	14.61	3.71	13.41	3.87	10.05	4.25
	24	17.83	3.44	17.17	3.47	13.84	3.64	11.85	3.74	11.05	3.91	9.19	4.27
2.0 + 4.2 + 4.2	16	19.59	3.05	19.22	3.12	17.36	3.46	16.25	3.66	15.21	3.82	12.04	4.19
	18	18.66	3.16	18.23	3.22	16.11	3.54	14.83	3.72	13.89	3.90	11.39	4.32
	20	18.06	3.27	17.56	3.33	15.09	3.60	13.60	3.77	12.74	3.93	10.69	4.32
	21	17.83	3.33	17.30	3.37	14.64	3.58	13.04	3.71	12.21	3.89	10.31	4.34
	22	17.69	3.39	17.32	3.44	15.50	3.67	14.40	3.80	13.22	3.96	9.91	4.35
	24	17.57	3.52	16.92	3.55	13.64	3.73	11.68	3.83	10.89	4.00	9.05	4.37
2.0 + 4.2 + 5.0	16	19.88	2.98	19.50	3.04	17.62	3.37	16.49	3.57	15.43	3.73	12.21	4.09
	18	18.93	3.08	18.50	3.15	16.34	3.45	15.05	3.63	14.10	3.80	11.56	4.22
	20	18.32	3.19	17.82	3.25	15.31	3.52	13.80	3.68	12.93	3.84	10.84	4.22
	21	18.10	3.25	17.56	3.29	14.85	3.50	13.23	3.62	12.39	3.79	10.46	4.23
	22	17.95	3.31	17.58	3.36	15.72	3.58	14.61	3.71	13.41	3.87	10.05	4.25
	24	17.83	3.44	17.17	3.47	13.84	3.64	11.85	3.74	11.05	3.91	9.19	4.27
2.0 + 4.2 + 6.0	16	19.88	2.98	19.50	3.04	17.62	3.37	16.49	3.57	15.43	3.73	12.21	4.09
	18	18.93	3.08	18.50	3.15	16.34	3.45	15.05	3.63	14.10	3.80	11.56	4.22
	20	18.32	3.19	17.82	3.25	15.31	3.52	13.80	3.68	12.93	3.84	10.84	4.22
	21	18.10	3.25	17.56	3.29	14.85	3.50	13.23	3.62	12.39	3.79	10.46	4.23
	22	17.95	3.31	17.58	3.36	15.72	3.58	14.61	3.71	13.41	3.87	10.05	4.25
	24	17.83	3.44	17.17	3.47	13.84	3.64	11.85	3.74	11.05	3.91	9.19	4.27
2.0 + 4.2 + 7.1	16	20.31	3.06	19.92	3.13	18.00	3.47	16.85	3.67	15.77	3.83	12.48	4.21
	18	19.34	3.17	18.90	3.23	16.70	3.54	15.38	3.73	14.40	3.91	11.81	4.33
	20	18.72	3.28	18.21	3.33	15.64	3.61	14.10	3.78	13.21	3.94	11.08	4.33
	21	18.49	3.34	17.94	3.38	15.18	3.59	13.52	3.72	12.66	3.90	10.69	4.35
	22	18.34	3.40	17.96	3.45	16.07	3.68	14.93	3.81	13.71	3.97	10.27	4.36
	24	18.22	3.53	17.54	3.56	14.15	3.74	12.11	3.84	11.29	4.01	9.39	4.38

Combination (Capacity)	Indoor Air Temp. °C DB	Outdoor Air Temp. °C									
		0/-1		-5/-6		-7/-8		-10/-11		-15/-	
		Total Q	Input Power	Total Q	Input Power	Total Q	Input Power	Total Q	Input Power	Total Q	Input Power
2.0 + 3.5 + 6.0	16	11.87	4.14	11.00	4.19	10.66	4.21	10.26	4.01	9.41	3.93
	18	11.26	4.22	10.51	4.18	9.79	4.16	10.07	3.98	9.48	3.92
	20	10.64	4.22	10.13	4.16	9.93	4.13	9.89	4.01	9.35	3.92
	21	10.22	4.23	9.62	4.16	9.38	4.13	9.53	4.02	9.20	3.96
	22	10.00	4.24	9.86	4.16	9.80	4.13	9.74	4.04	8.97	3.96
	24	9.33	4.29	9.68	4.20	9.82	4.16	9.62	4.11	8.39	4.03
2.0 + 3.5 + 7.1	16	11.87	4.11	11.00	4.17	10.66	4.19	10.26	3.99	9.41	3.91
	18	11.26	4.20	10.51	4.16	9.79	4.14	10.07	3.96	9.48	3.90
	20	10.64	4.19	10.13	4.13	9.93	4.11	9.89	3.98	9.35	3.90
	21	10.22	4.20	9.62	4.14	9.38	4.11	9.53	4.00	9.20	3.94
	22	10.00	4.22	9.86	4.14	9.80	4.11	9.74	4.02	8.97	3.94
	24	9.33	4.27	9.68	4.18	9.82	4.14	9.62	4.08	8.39	4.01
2.0 + 4.2 + 4.2	16	11.70	4.22	10.84	4.27	10.50	4.29	10.11	4.08	9.27	4.00
	18	11.10	4.30	10.36	4.26	9.65	4.24	9.92	4.06	9.35	4.00
	20	10.49	4.30	9.98	4.23	9.78	4.21	9.75	4.08	9.22	4.00
	21	10.07	4.31	9.48	4.24	9.25	4.21	9.39	4.09	9.07	4.03
	22	9.85	4.32	9.71	4.24	9.66	4.21	9.60	4.12	8.84	4.03
	24	9.19	4.38	9.54	4.28	9.67	4.24	9.48	4.18	8.26	4.11
2.0 + 4.2 + 5.0	16	11.87	4.11	11.00	4.17	10.66	4.19	10.26	3.99	9.41	3.91
	18	11.26	4.20	10.51	4.16	9.79	4.14	10.07	3.96	9.48	3.90
	20	10.64	4.19	10.13	4.13	9.93	4.11	9.89	3.98	9.35	3.90
	21	10.22	4.20	9.62	4.14	9.38	4.11	9.53	4.00	9.20	3.94
	22	10.00	4.22	9.86	4.14	9.80	4.11	9.74	4.02	8.97	3.94
	24	9.33	4.27	9.68	4.18	9.82	4.14	9.62	4.08	8.39	4.01
2.0 + 4.2 + 6.0	16	11.87	4.11	11.00	4.17	10.66	4.19	10.26	3.99	9.41	3.91
	18	11.26	4.20	10.51	4.16	9.79	4.14	10.07	3.96	9.48	3.90
	20	10.64	4.19	10.13	4.13	9.93	4.11	9.89	3.98	9.35	3.90
	21	10.22	4.20	9.62	4.14	9.38	4.11	9.53	4.00	9.20	3.94
	22	10.00	4.22	9.86	4.14	9.80	4.11	9.74	4.02	8.97	3.94
	24	9.33	4.27	9.68	4.18	9.82	4.14	9.62	4.08	8.39	4.01
2.0 + 4.2 + 7.1	16	12.13	4.23	11.24	4.28	10.89	4.30	10.48	4.09	9.61	4.02
	18	11.51	4.31	10.74	4.27	10.01	4.25	10.28	4.07	9.69	4.01
	20	10.87	4.31	10.35	4.25	10.14	4.22	10.11	4.09	9.55	4.01
	21	10.44	4.32	9.83	4.25	9.59	4.22	9.74	4.10	9.40	4.04
	22	10.21	4.33	10.07	4.25	10.01	4.22	9.96	4.13	9.17	4.04
	24	9.53	4.39	9.89	4.29	10.03	4.25	9.83	4.19	8.57	4.12

Combination (Capacity)	Indoor Air Temp. °C DB	Outdoor Air Temp. °C											
		16/15		15/14		10/9		7/6		6/5		2/1	
		Total Q	Input Power	Total Q	Input Power	Total Q	Input Power	Total Q	Input Power	Total Q	Input Power	Total Q	Input Power
2.0 + 5.0 + 5.0	16	19.88	2.82	19.50	2.88	17.62	3.19	16.49	3.38	15.43	3.53	12.21	3.87
	18	18.93	2.92	18.50	2.97	16.34	3.26	15.05	3.44	14.10	3.60	11.56	3.99
	20	18.32	3.02	17.82	3.07	15.31	3.33	13.80	3.48	12.93	3.63	10.84	3.99
	21	18.10	3.08	17.56	3.11	14.85	3.31	13.23	3.42	12.39	3.59	10.46	4.00
	22	17.95	3.13	17.58	3.18	15.72	3.38	14.61	3.51	13.41	3.66	10.05	4.02
	24	17.83	3.25	17.17	3.28	13.84	3.44	11.85	3.54	11.05	3.69	9.19	4.04
2.0 + 5.0 + 6.0	16	20.31	2.95	19.92	3.02	18.00	3.35	16.85	3.54	15.77	3.70	12.48	4.06
	18	19.34	3.06	18.90	3.12	16.70	3.42	15.38	3.60	14.40	3.77	11.81	4.18
	20	18.72	3.17	18.21	3.22	15.64	3.49	14.10	3.65	13.21	3.81	11.08	4.18
	21	18.49	3.23	17.94	3.27	15.18	3.47	13.52	3.59	12.66	3.76	10.69	4.20
	22	18.34	3.29	17.96	3.33	16.07	3.55	14.93	3.68	13.71	3.84	10.27	4.21
	24	18.22	3.41	17.54	3.44	14.15	3.61	12.11	3.71	11.29	3.87	9.39	4.23
2.0 + 5.0 + 7.1	16	20.31	2.95	19.92	3.01	18.00	3.34	16.85	3.53	15.77	3.69	12.48	4.05
	18	19.34	3.05	18.90	3.11	16.70	3.41	15.38	3.59	14.40	3.76	11.81	4.17
	20	18.72	3.16	18.21	3.21	15.64	3.48	14.10	3.64	13.21	3.80	11.08	4.17
	21	18.49	3.22	17.94	3.26	15.18	3.46	13.52	3.58	12.66	3.75	10.69	4.19
	22	18.34	3.28	17.96	3.32	16.07	3.54	14.93	3.67	13.71	3.83	10.27	4.20
	24	18.22	3.40	17.54	3.43	14.15	3.60	12.11	3.70	11.29	3.86	9.39	4.22
2.0 + 6.0 + 6.0	16	20.31	2.95	19.92	3.02	18.00	3.35	16.85	3.54	15.77	3.70	12.48	4.06
	18	19.34	3.06	18.90	3.12	16.70	3.42	15.38	3.60	14.40	3.77	11.81	4.18
	20	18.72	3.17	18.21	3.22	15.64	3.49	14.10	3.65	13.21	3.81	11.08	4.18
	21	18.49	3.23	17.94	3.27	15.18	3.47	13.52	3.59	12.66	3.76	10.69	4.20
	22	18.34	3.29	17.96	3.33	16.07	3.55	14.93	3.68	13.71	3.84	10.27	4.21
	24	18.22	3.41	17.54	3.44	14.15	3.61	12.11	3.71	11.29	3.87	9.39	4.23
2.0 + 6.0 + 7.1	16	20.74	3.03	20.35	3.10	18.38	3.44	17.20	3.64	16.10	3.80	12.75	4.17
	18	19.75	3.14	19.30	3.21	17.05	3.52	15.70	3.70	14.71	3.87	12.06	4.30
	20	19.12	3.25	18.60	3.31	15.97	3.58	14.40	3.75	13.49	3.91	11.32	4.30
	21	18.88	3.31	18.32	3.36	15.50	3.56	13.81	3.69	12.93	3.87	10.92	4.31
	22	18.73	3.38	18.34	3.42	16.41	3.65	15.25	3.78	14.00	3.94	10.49	4.33
	24	18.61	3.50	17.91	3.54	14.45	3.71	12.37	3.81	11.53	3.98	9.59	4.35
2.0 + 7.1 + 7.1	16	20.74	3.03	20.35	3.09	18.38	3.43	17.20	3.63	16.10	3.79	12.75	4.16
	18	19.75	3.13	19.30	3.20	17.05	3.51	15.70	3.69	14.71	3.86	12.06	4.29
	20	19.12	3.24	18.60	3.30	15.97	3.57	14.40	3.74	13.49	3.90	11.32	4.29
	21	18.88	3.31	18.32	3.35	15.50	3.55	13.81	3.68	12.93	3.86	10.92	4.30
	22	18.73	3.37	18.34	3.41	16.41	3.64	15.25	3.77	14.00	3.93	10.49	4.32
	24	18.61	3.49	17.91	3.53	14.45	3.70	12.37	3.80	11.53	3.97	9.59	4.34

Combination (Capacity)	Indoor Air Temp. °C DB	Outdoor Air Temp. °C									
		0/-1		-5/-6		-7/-8		-10/-11		-15/-	
		Total Q	Input Power	Total Q	Input Power	Total Q	Input Power	Total Q	Input Power	Total Q	Input Power
2.0 + 5.0 + 5.0	16	11.87	3.89	11.00	3.94	10.66	3.96	10.26	3.77	9.41	3.70
	18	11.26	3.97	10.51	3.93	9.79	3.92	10.07	3.75	9.48	3.69
	20	10.64	3.96	10.13	3.91	9.93	3.89	9.89	3.77	9.35	3.69
	21	10.22	3.98	9.62	3.91	9.38	3.89	9.53	3.78	9.20	3.72
	22	10.00	3.99	9.86	3.92	9.80	3.89	9.74	3.80	8.97	3.72
	24	9.33	4.04	9.68	3.95	9.82	3.92	9.62	3.86	8.39	3.79
2.0 + 5.0 + 6.0	16	12.13	4.08	11.24	4.13	10.89	4.15	10.48	3.95	9.61	3.88
	18	11.51	4.17	10.74	4.12	10.01	4.11	10.28	3.93	9.69	3.87
	20	10.87	4.16	10.35	4.10	10.14	4.08	10.11	3.95	9.55	3.87
	21	10.44	4.17	9.83	4.10	9.59	4.08	9.74	3.96	9.40	3.91
	22	10.21	4.18	10.07	4.11	10.01	4.08	9.96	3.99	9.17	3.91
	24	9.53	4.24	9.89	4.14	10.03	4.11	9.83	4.05	8.57	3.98
2.0 + 5.0 + 7.1	16	12.13	4.07	11.24	4.12	10.89	4.14	10.48	3.94	9.61	3.87
	18	11.51	4.15	10.74	4.11	10.01	4.10	10.28	3.92	9.69	3.86
	20	10.87	4.15	10.35	4.09	10.14	4.06	10.11	3.94	9.55	3.86
	21	10.44	4.16	9.83	4.09	9.59	4.06	9.74	3.95	9.40	3.89
	22	10.21	4.17	10.07	4.10	10.01	4.06	9.96	3.97	9.17	3.89
	24	9.53	4.22	9.89	4.13	10.03	4.10	9.83	4.04	8.57	3.97
2.0 + 6.0 + 6.0	16	12.13	4.08	11.24	4.13	10.89	4.15	10.48	3.95	9.61	3.88
	18	11.51	4.17	10.74	4.12	10.01	4.11	10.28	3.93	9.69	3.87
	20	10.87	4.16	10.35	4.10	10.14	4.08	10.11	3.95	9.55	3.87
	21	10.44	4.17	9.83	4.10	9.59	4.08	9.74	3.96	9.40	3.91
	22	10.21	4.18	10.07	4.11	10.01	4.08	9.96	3.99	9.17	3.91
	24	9.53	4.24	9.89	4.14	10.03	4.11	9.83	4.05	8.57	3.98
2.0 + 6.0 + 7.1	16	12.38	4.19	11.48	4.24	11.12	4.27	10.70	4.06	9.82	3.98
	18	11.75	4.28	10.97	4.24	10.22	4.22	10.50	4.04	9.90	3.98
	20	11.10	4.27	10.57	4.21	10.36	4.19	10.32	4.06	9.76	3.98
	21	10.67	4.28	10.04	4.22	9.79	4.19	9.94	4.07	9.60	4.01
	22	10.43	4.30	10.28	4.22	10.22	4.19	10.17	4.09	9.36	4.01
	24	9.73	4.35	10.10	4.26	10.24	4.22	10.04	4.16	8.75	4.09
2.0 + 7.1 + 7.1	16	12.38	4.18	11.48	4.23	11.12	4.25	10.70	4.05	9.82	3.97
	18	11.75	4.27	10.97	4.22	10.22	4.21	10.50	4.03	9.90	3.96
	20	11.10	4.26	10.57	4.20	10.36	4.18	10.32	4.05	9.76	3.96
	21	10.67	4.27	10.04	4.20	9.79	4.18	9.94	4.06	9.60	4.00
	22	10.43	4.29	10.28	4.21	10.22	4.18	10.17	4.08	9.36	4.00
	24	9.73	4.34	10.10	4.25	10.24	4.21	10.04	4.15	8.75	4.08

Combination (Capacity)	Indoor Air Temp. °C DB	Outdoor Air Temp. °C											
		16/15		15/14		10/9		7/6		6/5		2/1	
		Total Q	Input Power	Total Q	Input Power	Total Q	Input Power	Total Q	Input Power	Total Q	Input Power	Total Q	Input Power
2.5 + 2.5 + 2.5	16	17.72	2.71	17.38	2.77	15.70	3.07	14.70	3.25	13.75	3.39	10.89	3.73
	18	16.87	2.81	16.49	2.86	14.57	3.14	13.41	3.31	12.56	3.46	10.30	3.84
	20	16.33	2.91	15.88	2.95	13.64	3.20	12.30	3.35	11.52	3.49	9.67	3.84
	21	16.13	2.96	15.65	3.00	13.24	3.18	11.79	3.30	11.04	3.45	9.32	3.85
	22	16.00	3.02	15.67	3.06	14.02	3.26	13.03	3.38	11.96	3.52	8.96	3.87
	24	15.89	3.13	15.30	3.16	12.34	3.31	10.56	3.41	9.85	3.56	8.19	3.89
2.5 + 2.5 + 3.5	16	19.59	3.15	19.22	3.22	17.36	3.57	16.25	3.78	15.21	3.94	12.04	4.33
	18	18.66	3.26	18.23	3.33	16.11	3.65	14.83	3.84	13.89	4.02	11.39	4.46
	20	18.06	3.37	17.56	3.43	15.09	3.72	13.60	3.89	12.74	4.06	10.69	4.46
	21	17.83	3.44	17.30	3.48	14.64	3.70	13.04	3.83	12.21	4.01	10.31	4.47
	22	17.69	3.50	17.32	3.55	15.50	3.78	14.40	3.92	13.22	4.09	9.91	4.49
	24	17.57	3.63	16.92	3.67	13.64	3.85	11.68	3.95	10.89	4.13	9.05	4.51
2.5 + 2.5 + 4.2	16	19.59	3.13	19.22	3.20	17.36	3.55	16.25	3.76	15.21	3.92	12.04	4.31
	18	18.66	3.24	18.23	3.31	16.11	3.63	14.83	3.82	13.89	4.00	11.39	4.43
	20	18.06	3.36	17.56	3.41	15.09	3.70	13.60	3.87	12.74	4.04	10.69	4.43
	21	17.83	3.42	17.30	3.46	14.64	3.68	13.04	3.81	12.21	3.99	10.31	4.45
	22	17.69	3.48	17.32	3.53	15.50	3.76	14.40	3.90	13.22	4.07	9.91	4.47
	24	17.57	3.61	16.92	3.65	13.64	3.83	11.68	3.93	10.89	4.11	9.05	4.49
2.5 + 2.5 + 5.0	16	19.59	2.93	19.22	2.99	17.36	3.32	16.25	3.51	15.21	3.67	12.04	4.03
	18	18.66	3.03	18.23	3.09	16.11	3.39	14.83	3.57	13.89	3.74	11.39	4.15
	20	18.06	3.14	17.56	3.19	15.09	3.46	13.60	3.62	12.74	3.78	10.69	4.15
	21	17.83	3.20	17.30	3.24	14.64	3.44	13.04	3.56	12.21	3.73	10.31	4.16
	22	17.69	3.26	17.32	3.30	15.50	3.52	14.40	3.65	13.22	3.81	9.91	4.18
	24	17.57	3.38	16.92	3.41	13.64	3.58	11.68	3.68	10.89	3.84	9.05	4.20
2.5 + 2.5 + 6.0	16	19.88	3.02	19.50	3.09	17.62	3.42	16.49	3.62	15.43	3.78	12.21	4.15
	18	18.93	3.13	18.50	3.19	16.34	3.50	15.05	3.68	14.10	3.85	11.56	4.27
	20	18.32	3.23	17.82	3.29	15.31	3.56	13.80	3.73	12.93	3.89	10.84	4.27
	21	18.10	3.30	17.56	3.34	14.85	3.54	13.23	3.67	12.39	3.85	10.46	4.29
	22	17.95	3.36	17.58	3.40	15.72	3.63	14.61	3.76	13.41	3.92	10.05	4.30
	24	17.83	3.48	17.17	3.52	13.84	3.69	11.85	3.79	11.05	3.96	9.19	4.33
2.5 + 2.5 + 7.1	16	19.88	3.00	19.50	3.07	17.62	3.40	16.49	3.60	15.43	3.76	12.21	4.13
	18	18.93	3.11	18.50	3.17	16.34	3.48	15.05	3.66	14.10	3.83	11.56	4.25
	20	18.32	3.22	17.82	3.27	15.31	3.55	13.80	3.71	12.93	3.87	10.84	4.25
	21	18.10	3.28	17.56	3.32	14.85	3.53	13.23	3.65	12.39	3.82	10.46	4.27
	22	17.95	3.34	17.58	3.39	15.72	3.61	14.61	3.74	13.41	3.90	10.05	4.28
	24	17.83	3.46	17.17	3.50	13.84	3.67	11.85	3.77	11.05	3.94	9.19	4.30

Combination (Capacity)	Indoor Air Temp. °C DB	Outdoor Air Temp. °C									
		0/-1		-5/-6		-7/-8		-10/-11		-15/-	
		Total Q	Input Power	Total Q	Input Power	Total Q	Input Power	Total Q	Input Power	Total Q	Input Power
2.5 + 2.5 + 2.5	16	10.58	3.75	9.81	3.79	9.50	3.81	9.14	3.63	8.39	3.56
	18	10.04	3.82	9.37	3.78	8.73	3.77	8.97	3.61	8.45	3.55
	20	9.48	3.82	9.03	3.76	8.85	3.74	8.82	3.63	8.33	3.55
	21	9.11	3.83	8.58	3.77	8.36	3.74	8.49	3.64	8.20	3.58
	22	8.91	3.84	8.78	3.77	8.73	3.74	8.68	3.66	8.00	3.58
	24	8.31	3.89	8.62	3.80	8.75	3.77	8.57	3.72	7.47	3.65
2.5 + 2.5 + 3.5	16	11.70	4.35	10.84	4.40	10.50	4.42	10.11	4.21	9.27	4.13
	18	11.10	4.44	10.36	4.39	9.65	4.38	9.92	4.19	9.35	4.12
	20	10.49	4.43	9.98	4.37	9.78	4.34	9.75	4.21	9.22	4.12
	21	10.07	4.44	9.48	4.37	9.25	4.34	9.39	4.22	9.07	4.16
	22	9.85	4.46	9.71	4.38	9.66	4.34	9.60	4.25	8.84	4.16
	24	9.19	4.51	9.54	4.42	9.67	4.38	9.48	4.32	8.26	4.24
2.5 + 2.5 + 4.2	16	11.70	4.33	10.84	4.38	10.50	4.40	10.11	4.19	9.27	4.11
	18	11.10	4.42	10.36	4.37	9.65	4.35	9.92	4.17	9.35	4.10
	20	10.49	4.41	9.98	4.35	9.78	4.32	9.75	4.19	9.22	4.10
	21	10.07	4.42	9.48	4.35	9.25	4.32	9.39	4.20	9.07	4.14
	22	9.85	4.43	9.71	4.35	9.66	4.32	9.60	4.23	8.84	4.14
	24	9.19	4.49	9.54	4.39	9.67	4.35	9.48	4.29	8.26	4.22
2.5 + 2.5 + 5.0	16	11.70	4.05	10.84	4.10	10.50	4.12	10.11	3.92	9.27	3.85
	18	11.10	4.13	10.36	4.09	9.65	4.07	9.92	3.90	9.35	3.84
	20	10.49	4.12	9.98	4.07	9.78	4.04	9.75	3.92	9.22	3.84
	21	10.07	4.14	9.48	4.07	9.25	4.04	9.39	3.93	9.07	3.87
	22	9.85	4.15	9.71	4.07	9.66	4.04	9.60	3.95	8.84	3.87
	24	9.19	4.20	9.54	4.11	9.67	4.07	9.48	4.02	8.26	3.95
2.5 + 2.5 + 6.0	16	11.87	4.17	11.00	4.22	10.66	4.24	10.26	4.04	9.41	3.96
	18	11.26	4.26	10.51	4.21	9.79	4.20	10.07	4.02	9.48	3.95
	20	10.64	4.25	10.13	4.19	9.93	4.17	9.89	4.04	9.35	3.95
	21	10.22	4.26	9.62	4.19	9.38	4.17	9.53	4.05	9.20	3.99
	22	10.00	4.27	9.86	4.20	9.80	4.17	9.74	4.07	8.97	3.99
	24	9.33	4.33	9.68	4.23	9.82	4.20	9.62	4.14	8.39	4.07
2.5 + 2.5 + 7.1	16	11.87	4.15	11.00	4.20	10.66	4.22	10.26	4.02	9.41	3.94
	18	11.26	4.23	10.51	4.19	9.79	4.17	10.07	3.99	9.48	3.93
	20	10.64	4.23	10.13	4.17	9.93	4.14	9.89	4.02	9.35	3.93
	21	10.22	4.24	9.62	4.17	9.38	4.14	9.53	4.03	9.20	3.97
	22	10.00	4.25	9.86	4.17	9.80	4.14	9.74	4.05	8.97	3.97
	24	9.33	4.31	9.68	4.21	9.82	4.17	9.62	4.12	8.39	4.04

Combination (Capacity)	Indoor Air Temp. °C DB	Outdoor Air Temp. °C											
		16/15		15/14		10/9		7/6		6/5		2/1	
		Total Q	Input Power	Total Q	Input Power	Total Q	Input Power	Total Q	Input Power	Total Q	Input Power	Total Q	Input Power
2.5 + 3.5 + 3.5	16	19.59	3.12	19.22	3.18	17.36	3.53	16.25	3.74	15.21	3.90	12.04	4.28
	18	18.66	3.23	18.23	3.29	16.11	3.61	14.83	3.80	13.89	3.98	11.39	4.41
	20	18.06	3.34	17.56	3.40	15.09	3.68	13.60	3.85	12.74	4.02	10.69	4.41
	21	17.83	3.40	17.30	3.45	14.64	3.66	13.04	3.79	12.21	3.97	10.31	4.43
	22	17.69	3.47	17.32	3.51	15.50	3.74	14.40	3.88	13.22	4.05	9.91	4.44
	24	17.57	3.59	16.92	3.63	13.64	3.81	11.68	3.91	10.89	4.09	9.05	4.47
2.5 + 3.5 + 4.2	16	19.59	3.06	19.22	3.13	17.36	3.47	16.25	3.67	15.21	3.83	12.04	4.21
	18	18.66	3.17	18.23	3.23	16.11	3.54	14.83	3.73	13.89	3.91	11.39	4.33
	20	18.06	3.28	17.56	3.33	15.09	3.61	13.60	3.78	12.74	3.94	10.69	4.33
	21	17.83	3.34	17.30	3.38	14.64	3.59	13.04	3.72	12.21	3.90	10.31	4.35
	22	17.69	3.40	17.32	3.45	15.50	3.68	14.40	3.81	13.22	3.97	9.91	4.36
	24	17.57	3.53	16.92	3.56	13.64	3.74	11.68	3.84	10.89	4.01	9.05	4.38
2.5 + 3.5 + 5.0	16	19.88	2.99	19.50	3.06	17.62	3.39	16.49	3.59	15.43	3.75	12.21	4.12
	18	18.93	3.10	18.50	3.16	16.34	3.47	15.05	3.65	14.10	3.82	11.56	4.24
	20	18.32	3.21	17.82	3.26	15.31	3.54	13.80	3.70	12.93	3.86	10.84	4.24
	21	18.10	3.27	17.56	3.31	14.85	3.52	13.23	3.64	12.39	3.81	10.46	4.25
	22	17.95	3.33	17.58	3.38	15.72	3.60	14.61	3.73	13.41	3.89	10.05	4.27
	24	17.83	3.45	17.17	3.49	13.84	3.66	11.85	3.76	11.05	3.93	9.19	4.29
2.5 + 3.5 + 6.0	16	19.88	2.99	19.50	3.06	17.62	3.39	16.49	3.59	15.43	3.75	12.21	4.12
	18	18.93	3.10	18.50	3.16	16.34	3.47	15.05	3.65	14.10	3.82	11.56	4.24
	20	18.32	3.21	17.82	3.26	15.31	3.54	13.80	3.70	12.93	3.86	10.84	4.24
	21	18.10	3.27	17.56	3.31	14.85	3.52	13.23	3.64	12.39	3.81	10.46	4.25
	22	17.95	3.33	17.58	3.38	15.72	3.60	14.61	3.73	13.41	3.89	10.05	4.27
	24	17.83	3.45	17.17	3.49	13.84	3.66	11.85	3.76	11.05	3.93	9.19	4.29
2.5 + 3.5 + 7.1	16	20.31	3.07	19.92	3.14	18.00	3.48	16.85	3.69	15.77	3.85	12.48	4.23
	18	19.34	3.19	18.90	3.25	16.70	3.56	15.38	3.75	14.40	3.93	11.81	4.35
	20	18.72	3.30	18.21	3.35	15.64	3.63	14.10	3.80	13.21	3.96	11.08	4.35
	21	18.49	3.36	17.94	3.40	15.18	3.61	13.52	3.74	12.66	3.92	10.69	4.37
	22	18.34	3.42	17.96	3.47	16.07	3.69	14.93	3.83	13.71	4.00	10.27	4.39
	24	18.22	3.55	17.54	3.58	14.15	3.76	12.11	3.86	11.29	4.03	9.39	4.41
2.5 + 4.2 + 4.2	16	19.88	3.15	19.50	3.22	17.62	3.57	16.49	3.78	15.43	3.94	12.21	4.33
	18	18.93	3.26	18.50	3.33	16.34	3.65	15.05	3.84	14.10	4.02	11.56	4.46
	20	18.32	3.37	17.82	3.43	15.31	3.72	13.80	3.89	12.93	4.06	10.84	4.46
	21	18.10	3.44	17.56	3.48	14.85	3.70	13.23	3.83	12.39	4.01	10.46	4.47
	22	17.95	3.50	17.58	3.55	15.72	3.78	14.61	3.92	13.41	4.09	10.05	4.49
	24	17.83	3.63	17.17	3.67	13.84	3.85	11.85	3.95	11.05	4.13	9.19	4.51



Combination (Capacity)	Indoor Air Temp. °C DB	Outdoor Air Temp. °C									
		0/-1		-5/-6		-7/-8		-10/-11		-15/-	
		Total Q	Input Power	Total Q	Input Power	Total Q	Input Power	Total Q	Input Power	Total Q	Input Power
2.5 + 3.5 + 3.5	16	11.70	4.30	10.84	4.36	10.50	4.38	10.11	4.17	9.27	4.09
	18	11.10	4.39	10.36	4.35	9.65	4.33	9.92	4.15	9.35	4.08
	20	10.49	4.39	9.98	4.32	9.78	4.30	9.75	4.17	9.22	4.08
	21	10.07	4.40	9.48	4.33	9.25	4.30	9.39	4.18	9.07	4.12
	22	9.85	4.41	9.71	4.33	9.66	4.30	9.60	4.20	8.84	4.12
	24	9.19	4.47	9.54	4.37	9.67	4.33	9.48	4.27	8.26	4.20
2.5 + 3.5 + 4.2	16	11.70	4.23	10.84	4.28	10.50	4.30	10.11	4.09	9.27	4.02
	18	11.10	4.31	10.36	4.27	9.65	4.25	9.92	4.07	9.35	4.01
	20	10.49	4.31	9.98	4.25	9.78	4.22	9.75	4.09	9.22	4.01
	21	10.07	4.32	9.48	4.25	9.25	4.22	9.39	4.10	9.07	4.04
	22	9.85	4.33	9.71	4.25	9.66	4.22	9.60	4.13	8.84	4.04
	24	9.19	4.39	9.54	4.29	9.67	4.25	9.48	4.19	8.26	4.12
2.5 + 3.5 + 5.0	16	11.87	4.14	11.00	4.19	10.66	4.21	10.26	4.01	9.41	3.93
	18	11.26	4.22	10.51	4.18	9.79	4.16	10.07	3.98	9.48	3.92
	20	10.64	4.22	10.13	4.16	9.93	4.13	9.89	4.01	9.35	3.92
	21	10.22	4.23	9.62	4.16	9.38	4.13	9.53	4.02	9.20	3.96
	22	10.00	4.24	9.86	4.16	9.80	4.13	9.74	4.04	8.97	3.96
	24	9.33	4.29	9.68	4.20	9.82	4.16	9.62	4.11	8.39	4.03
2.5 + 3.5 + 6.0	16	11.87	4.14	11.00	4.19	10.66	4.21	10.26	4.01	9.41	3.93
	18	11.26	4.22	10.51	4.18	9.79	4.16	10.07	3.98	9.48	3.92
	20	10.64	4.22	10.13	4.16	9.93	4.13	9.89	4.01	9.35	3.92
	21	10.22	4.23	9.62	4.16	9.38	4.13	9.53	4.02	9.20	3.96
	22	10.00	4.24	9.86	4.16	9.80	4.13	9.74	4.04	8.97	3.96
	24	9.33	4.29	9.68	4.20	9.82	4.16	9.62	4.11	8.39	4.03
2.5 + 3.5 + 7.1	16	12.13	4.25	11.24	4.30	10.89	4.32	10.48	4.12	9.61	4.04
	18	11.51	4.34	10.74	4.29	10.01	4.28	10.28	4.09	9.69	4.03
	20	10.87	4.33	10.35	4.27	10.14	4.24	10.11	4.11	9.55	4.03
	21	10.44	4.34	9.83	4.27	9.59	4.24	9.74	4.13	9.40	4.07
	22	10.21	4.35	10.07	4.28	10.01	4.24	9.96	4.15	9.17	4.07
	24	9.53	4.41	9.89	4.31	10.03	4.28	9.83	4.22	8.57	4.14
2.5 + 4.2 + 4.2	16	11.87	4.35	11.00	4.40	10.66	4.42	10.26	4.21	9.41	4.13
	18	11.26	4.44	10.51	4.39	9.79	4.38	10.07	4.19	9.48	4.12
	20	10.64	4.43	10.13	4.37	9.93	4.34	9.89	4.21	9.35	4.12
	21	10.22	4.44	9.62	4.37	9.38	4.34	9.53	4.22	9.20	4.16
	22	10.00	4.46	9.86	4.38	9.80	4.34	9.74	4.25	8.97	4.16
	24	9.33	4.51	9.68	4.42	9.82	4.38	9.62	4.32	8.39	4.24

Combination (Capacity)	Indoor Air Temp. °C DB	Outdoor Air Temp. °C											
		16/15		15/14		10/9		7/6		6/5		2/1	
		Total Q	Input Power	Total Q	Input Power	Total Q	Input Power	Total Q	Input Power	Total Q	Input Power	Total Q	Input Power
2.5 + 4.2 + 5.0	16	19.88	2.98	19.50	3.04	17.62	3.37	16.49	3.57	15.43	3.73	12.21	4.09
	18	18.93	3.08	18.50	3.15	16.34	3.45	15.05	3.63	14.10	3.80	11.56	4.22
	20	18.32	3.19	17.82	3.25	15.31	3.52	13.80	3.68	12.93	3.84	10.84	4.22
	21	18.10	3.25	17.56	3.29	14.85	3.50	13.23	3.62	12.39	3.79	10.46	4.23
	22	17.95	3.31	17.58	3.36	15.72	3.58	14.61	3.71	13.41	3.87	10.05	4.25
	24	17.83	3.44	17.17	3.47	13.84	3.64	11.85	3.74	11.05	3.91	9.19	4.27
2.5 + 4.2 + 6.0	16	20.31	3.07	19.92	3.14	18.00	3.48	16.85	3.69	15.77	3.85	12.48	4.23
	18	19.34	3.19	18.90	3.25	16.70	3.56	15.38	3.75	14.40	3.93	11.81	4.35
	20	18.72	3.30	18.21	3.35	15.64	3.63	14.10	3.80	13.21	3.96	11.08	4.35
	21	18.49	3.36	17.94	3.40	15.18	3.61	13.52	3.74	12.66	3.92	10.69	4.37
	22	18.34	3.42	17.96	3.47	16.07	3.69	14.93	3.83	13.71	4.00	10.27	4.39
	24	18.22	3.55	17.54	3.58	14.15	3.76	12.11	3.86	11.29	4.03	9.39	4.41
2.5 + 4.2 + 7.1	16	20.31	3.06	19.92	3.13	18.00	3.47	16.85	3.67	15.77	3.83	12.48	4.21
	18	19.34	3.17	18.90	3.23	16.70	3.54	15.38	3.73	14.40	3.91	11.81	4.33
	20	18.72	3.28	18.21	3.33	15.64	3.61	14.10	3.78	13.21	3.94	11.08	4.33
	21	18.49	3.34	17.94	3.38	15.18	3.59	13.52	3.72	12.66	3.90	10.69	4.35
	22	18.34	3.40	17.96	3.45	16.07	3.68	14.93	3.81	13.71	3.97	10.27	4.36
	24	18.22	3.53	17.54	3.56	14.15	3.74	12.11	3.84	11.29	4.01	9.39	4.38
2.5 + 5.0 + 5.0	16	19.88	2.82	19.50	2.88	17.62	3.19	16.49	3.38	15.43	3.53	12.21	3.87
	18	18.93	2.92	18.50	2.97	16.34	3.26	15.05	3.44	14.10	3.60	11.56	3.99
	20	18.32	3.02	17.82	3.07	15.31	3.33	13.80	3.48	12.93	3.63	10.84	3.99
	21	18.10	3.08	17.56	3.11	14.85	3.31	13.23	3.42	12.39	3.59	10.46	4.00
	22	17.95	3.13	17.58	3.18	15.72	3.38	14.61	3.51	13.41	3.66	10.05	4.02
	24	17.83	3.25	17.17	3.28	13.84	3.44	11.85	3.54	11.05	3.69	9.19	4.04
2.5 + 5.0 + 6.0	16	20.31	2.95	19.92	3.02	18.00	3.35	16.85	3.54	15.77	3.70	12.48	4.06
	18	19.34	3.06	18.90	3.12	16.70	3.42	15.38	3.60	14.40	3.77	11.81	4.18
	20	18.72	3.17	18.21	3.22	15.64	3.49	14.10	3.65	13.21	3.81	11.08	4.18
	21	18.49	3.23	17.94	3.27	15.18	3.47	13.52	3.59	12.66	3.76	10.69	4.20
	22	18.34	3.29	17.96	3.33	16.07	3.55	14.93	3.68	13.71	3.84	10.27	4.21
	24	18.22	3.41	17.54	3.44	14.15	3.61	12.11	3.71	11.29	3.87	9.39	4.23
2.5 + 5.0 + 7.1	16	20.31	2.95	19.92	3.01	18.00	3.34	16.85	3.53	15.77	3.69	12.48	4.05
	18	19.34	3.05	18.90	3.11	16.70	3.41	15.38	3.59	14.40	3.76	11.81	4.17
	20	18.72	3.16	18.21	3.21	15.64	3.48	14.10	3.64	13.21	3.80	11.08	4.17
	21	18.49	3.22	17.94	3.26	15.18	3.46	13.52	3.58	12.66	3.75	10.69	4.19
	22	18.34	3.28	17.96	3.32	16.07	3.54	14.93	3.67	13.71	3.83	10.27	4.20
	24	18.22	3.40	17.54	3.43	14.15	3.60	12.11	3.70	11.29	3.86	9.39	4.22

Combination (Capacity)	Indoor Air Temp. °C DB	Outdoor Air Temp. °C									
		0/-1		-5/-6		-7/-8		-10/-11		-15/-	
		Total Q	Input Power	Total Q	Input Power	Total Q	Input Power	Total Q	Input Power	Total Q	Input Power
2.5 + 4.2 + 5.0	16	11.87	4.11	11.00	4.17	10.66	4.19	10.26	3.99	9.41	3.91
	18	11.26	4.20	10.51	4.16	9.79	4.14	10.07	3.96	9.48	3.90
	20	10.64	4.19	10.13	4.13	9.93	4.11	9.89	3.98	9.35	3.90
	21	10.22	4.20	9.62	4.14	9.38	4.11	9.53	4.00	9.20	3.94
	22	10.00	4.22	9.86	4.14	9.80	4.11	9.74	4.02	8.97	3.94
	24	9.33	4.27	9.68	4.18	9.82	4.14	9.62	4.08	8.39	4.01
2.5 + 4.2 + 6.0	16	12.13	4.25	11.24	4.30	10.89	4.32	10.48	4.12	9.61	4.04
	18	11.51	4.34	10.74	4.29	10.01	4.28	10.28	4.09	9.69	4.03
	20	10.87	4.33	10.35	4.27	10.14	4.24	10.11	4.11	9.55	4.03
	21	10.44	4.34	9.83	4.27	9.59	4.24	9.74	4.13	9.40	4.07
	22	10.21	4.35	10.07	4.28	10.01	4.24	9.96	4.15	9.17	4.07
	24	9.53	4.41	9.89	4.31	10.03	4.28	9.83	4.22	8.57	4.14
2.5 + 4.2 + 7.1	16	12.13	4.23	11.24	4.28	10.89	4.30	10.48	4.09	9.61	4.02
	18	11.51	4.31	10.74	4.27	10.01	4.25	10.28	4.07	9.69	4.01
	20	10.87	4.31	10.35	4.25	10.14	4.22	10.11	4.09	9.55	4.01
	21	10.44	4.32	9.83	4.25	9.59	4.22	9.74	4.10	9.40	4.04
	22	10.21	4.33	10.07	4.25	10.01	4.22	9.96	4.13	9.17	4.04
	24	9.53	4.39	9.89	4.29	10.03	4.25	9.83	4.19	8.57	4.12
2.5 + 5.0 + 5.0	16	11.87	3.89	11.00	3.94	10.66	3.96	10.26	3.77	9.41	3.70
	18	11.26	3.97	10.51	3.93	9.79	3.92	10.07	3.75	9.48	3.69
	20	10.64	3.96	10.13	3.91	9.93	3.89	9.89	3.77	9.35	3.69
	21	10.22	3.98	9.62	3.91	9.38	3.89	9.53	3.78	9.20	3.72
	22	10.00	3.99	9.86	3.92	9.80	3.89	9.74	3.80	8.97	3.72
	24	9.33	4.04	9.68	3.95	9.82	3.92	9.62	3.86	8.39	3.79
2.5 + 5.0 + 6.0	16	12.13	4.08	11.24	4.13	10.89	4.15	10.48	3.95	9.61	3.88
	18	11.51	4.17	10.74	4.12	10.01	4.11	10.28	3.93	9.69	3.87
	20	10.87	4.16	10.35	4.10	10.14	4.08	10.11	3.95	9.55	3.87
	21	10.44	4.17	9.83	4.10	9.59	4.08	9.74	3.96	9.40	3.91
	22	10.21	4.18	10.07	4.11	10.01	4.08	9.96	3.99	9.17	3.91
	24	9.53	4.24	9.89	4.14	10.03	4.11	9.83	4.05	8.57	3.98
2.5 + 5.0 + 7.1	16	12.13	4.07	11.24	4.12	10.89	4.14	10.48	3.94	9.61	3.87
	18	11.51	4.15	10.74	4.11	10.01	4.10	10.28	3.92	9.69	3.86
	20	10.87	4.15	10.35	4.09	10.14	4.06	10.11	3.94	9.55	3.86
	21	10.44	4.16	9.83	4.09	9.59	4.06	9.74	3.95	9.40	3.89
	22	10.21	4.17	10.07	4.10	10.01	4.06	9.96	3.97	9.17	3.89
	24	9.53	4.22	9.89	4.13	10.03	4.10	9.83	4.04	8.57	3.97

Combination (Capacity)	Indoor Air Temp. °C DB	Outdoor Air Temp. °C											
		16/15		15/14		10/9		7/6		6/5		2/1	
		Total Q	Input Power	Total Q	Input Power	Total Q	Input Power	Total Q	Input Power	Total Q	Input Power	Total Q	Input Power
2.5 + 6.0 + 6.0	16	20.31	2.95	19.92	3.02	18.00	3.35	16.85	3.54	15.77	3.70	12.48	4.06
	18	19.34	3.06	18.90	3.12	16.70	3.42	15.38	3.60	14.40	3.77	11.81	4.18
	20	18.72	3.17	18.21	3.22	15.64	3.49	14.10	3.65	13.21	3.81	11.08	4.18
	21	18.49	3.23	17.94	3.27	15.18	3.47	13.52	3.59	12.66	3.76	10.69	4.20
	22	18.34	3.29	17.96	3.33	16.07	3.55	14.93	3.68	13.71	3.84	10.27	4.21
	24	18.22	3.41	17.54	3.44	14.15	3.61	12.11	3.71	11.29	3.87	9.39	4.23
2.5 + 6.0 + 7.1	16	20.74	3.03	20.35	3.10	18.38	3.44	17.20	3.64	16.10	3.80	12.75	4.17
	18	19.75	3.14	19.30	3.21	17.05	3.52	15.70	3.70	14.71	3.87	12.06	4.30
	20	19.12	3.25	18.60	3.31	15.97	3.58	14.40	3.75	13.49	3.91	11.32	4.30
	21	18.88	3.31	18.32	3.36	15.50	3.56	13.81	3.69	12.93	3.87	10.92	4.31
	22	18.73	3.38	18.34	3.42	16.41	3.65	15.25	3.78	14.00	3.94	10.49	4.33
	24	18.61	3.50	17.91	3.54	14.45	3.71	12.37	3.81	11.53	3.98	9.59	4.35
2.5 + 7.1 + 7.1	16	20.74	3.03	20.35	3.09	18.38	3.43	17.20	3.63	16.10	3.79	12.75	4.16
	18	19.75	3.13	19.30	3.20	17.05	3.51	15.70	3.69	14.71	3.86	12.06	4.29
	20	19.12	3.24	18.60	3.30	15.97	3.57	14.40	3.74	13.49	3.90	11.32	4.29
	21	18.88	3.31	18.32	3.35	15.50	3.55	13.81	3.68	12.93	3.86	10.92	4.30
	22	18.73	3.37	18.34	3.41	16.41	3.64	15.25	3.77	14.00	3.93	10.49	4.32
	24	18.61	3.49	17.91	3.53	14.45	3.70	12.37	3.80	11.53	3.97	9.59	4.34
3.5 + 3.5 + 3.5	16	19.88	3.14	19.50	3.21	17.62	3.56	16.49	3.77	15.43	3.93	12.21	4.32
	18	18.93	3.25	18.50	3.32	16.34	3.64	15.05	3.83	14.10	4.01	11.56	4.45
	20	18.32	3.36	17.82	3.42	15.31	3.71	13.80	3.88	12.93	4.05	10.84	4.45
	21	18.10	3.43	17.56	3.47	14.85	3.69	13.23	3.82	12.39	4.00	10.46	4.46
	22	17.95	3.49	17.58	3.54	15.72	3.77	14.61	3.91	13.41	4.08	10.05	4.48
	24	17.83	3.62	17.17	3.66	13.84	3.84	11.85	3.94	11.05	4.12	9.19	4.50
3.5 + 3.5 + 4.2	16	19.88	3.13	19.50	3.20	17.62	3.55	16.49	3.76	15.43	3.92	12.21	4.31
	18	18.93	3.24	18.50	3.31	16.34	3.63	15.05	3.82	14.10	4.00	11.56	4.43
	20	18.32	3.36	17.82	3.41	15.31	3.70	13.80	3.87	12.93	4.04	10.84	4.43
	21	18.10	3.42	17.56	3.46	14.85	3.68	13.23	3.81	12.39	3.99	10.46	4.45
	22	17.95	3.48	17.58	3.53	15.72	3.76	14.61	3.90	13.41	4.07	10.05	4.47
	24	17.83	3.61	17.17	3.65	13.84	3.83	11.85	3.93	11.05	4.11	9.19	4.49
3.5 + 3.5 + 5.0	16	19.88	2.96	19.50	3.03	17.62	3.36	16.49	3.55	15.43	3.71	12.21	4.07
	18	18.93	3.07	18.50	3.13	16.34	3.43	15.05	3.61	14.10	3.78	11.56	4.19
	20	18.32	3.17	17.82	3.23	15.31	3.50	13.80	3.66	12.93	3.82	10.84	4.19
	21	18.10	3.23	17.56	3.28	14.85	3.48	13.23	3.60	12.39	3.77	10.46	4.21
	22	17.95	3.30	17.58	3.34	15.72	3.56	14.61	3.69	13.41	3.85	10.05	4.22
	24	17.83	3.42	17.17	3.45	13.84	3.62	11.85	3.72	11.05	3.88	9.19	4.25

Combination (Capacity)	Indoor Air Temp. °C DB	Outdoor Air Temp. °C									
		0/-1		-5/-6		-7/-8		-10/-11		-15/-	
		Total Q	Input Power	Total Q	Input Power	Total Q	Input Power	Total Q	Input Power	Total Q	Input Power
2.5 + 6.0 + 6.0	16	12.13	4.08	11.24	4.13	10.89	4.15	10.48	3.95	9.61	3.88
	18	11.51	4.17	10.74	4.12	10.01	4.11	10.28	3.93	9.69	3.87
	20	10.87	4.16	10.35	4.10	10.14	4.08	10.11	3.95	9.55	3.87
	21	10.44	4.17	9.83	4.10	9.59	4.08	9.74	3.96	9.40	3.91
	22	10.21	4.18	10.07	4.11	10.01	4.08	9.96	3.99	9.17	3.91
	24	9.53	4.24	9.89	4.14	10.03	4.11	9.83	4.05	8.57	3.98
2.5 + 6.0 + 7.1	16	12.38	4.19	11.48	4.24	11.12	4.27	10.70	4.06	9.82	3.98
	18	11.75	4.28	10.97	4.24	10.22	4.22	10.50	4.04	9.90	3.98
	20	11.10	4.27	10.57	4.21	10.36	4.19	10.32	4.06	9.76	3.98
	21	10.67	4.28	10.04	4.22	9.79	4.19	9.94	4.07	9.60	4.01
	22	10.43	4.30	10.28	4.22	10.22	4.19	10.17	4.09	9.36	4.01
	24	9.73	4.35	10.10	4.26	10.24	4.22	10.04	4.16	8.75	4.09
2.5 + 7.1 + 7.1	16	12.38	4.18	11.48	4.23	11.12	4.25	10.70	4.05	9.82	3.97
	18	11.75	4.27	10.97	4.22	10.22	4.21	10.50	4.03	9.90	3.96
	20	11.10	4.26	10.57	4.20	10.36	4.18	10.32	4.05	9.76	3.96
	21	10.67	4.27	10.04	4.20	9.79	4.18	9.94	4.06	9.60	4.00
	22	10.43	4.29	10.28	4.21	10.22	4.18	10.17	4.08	9.36	4.00
	24	9.73	4.34	10.10	4.25	10.24	4.21	10.04	4.15	8.75	4.08
3.5 + 3.5 + 3.5	16	11.87	4.34	11.00	4.39	10.66	4.41	10.26	4.20	9.41	4.12
	18	11.26	4.43	10.51	4.38	9.79	4.37	10.07	4.18	9.48	4.11
	20	10.64	4.42	10.13	4.36	9.93	4.33	9.89	4.20	9.35	4.11
	21	10.22	4.43	9.62	4.36	9.38	4.33	9.53	4.21	9.20	4.15
	22	10.00	4.45	9.86	4.37	9.80	4.33	9.74	4.24	8.97	4.15
	24	9.33	4.50	9.68	4.40	9.82	4.37	9.62	4.30	8.39	4.23
3.5 + 3.5 + 4.2	16	11.87	4.33	11.00	4.38	10.66	4.40	10.26	4.19	9.41	4.11
	18	11.26	4.42	10.51	4.37	9.79	4.35	10.07	4.17	9.48	4.10
	20	10.64	4.41	10.13	4.35	9.93	4.32	9.89	4.19	9.35	4.10
	21	10.22	4.42	9.62	4.35	9.38	4.32	9.53	4.20	9.20	4.14
	22	10.00	4.43	9.86	4.35	9.80	4.32	9.74	4.23	8.97	4.14
	24	9.33	4.49	9.68	4.39	9.82	4.35	9.62	4.29	8.39	4.22
3.5 + 3.5 + 5.0	16	11.87	4.09	11.00	4.14	10.66	4.16	10.26	3.96	9.41	3.89
	18	11.26	4.18	10.51	4.13	9.79	4.12	10.07	3.94	9.48	3.88
	20	10.64	4.17	10.13	4.11	9.93	4.09	9.89	3.96	9.35	3.88
	21	10.22	4.18	9.62	4.11	9.38	4.09	9.53	3.97	9.20	3.92
	22	10.00	4.19	9.86	4.12	9.80	4.09	9.74	4.00	8.97	3.92
	24	9.33	4.25	9.68	4.15	9.82	4.12	9.62	4.06	8.39	3.99

Combination (Capacity)	Indoor Air Temp. °C DB	Outdoor Air Temp. °C											
		16/15		15/14		10/9		7/6		6/5		2/1	
		Total Q	Input Power	Total Q	Input Power	Total Q	Input Power	Total Q	Input Power	Total Q	Input Power	Total Q	Input Power
3.5 + 3.5 + 6.0	16	20.31	3.06	19.92	3.13	18.00	3.47	16.85	3.67	15.77	3.83	12.48	4.21
	18	19.34	3.17	18.90	3.23	16.70	3.54	15.38	3.73	14.40	3.91	11.81	4.33
	20	18.72	3.28	18.21	3.33	15.64	3.61	14.10	3.78	13.21	3.94	11.08	4.33
	21	18.49	3.34	17.94	3.38	15.18	3.59	13.52	3.72	12.66	3.90	10.69	4.35
	22	18.34	3.40	17.96	3.45	16.07	3.68	14.93	3.81	13.71	3.97	10.27	4.36
	24	18.22	3.53	17.54	3.56	14.15	3.74	12.11	3.84	11.29	4.01	9.39	4.38
3.5 + 3.5 + 7.1	16	20.31	3.04	19.92	3.11	18.00	3.45	16.85	3.65	15.77	3.81	12.48	4.18
	18	19.34	3.15	18.90	3.21	16.70	3.53	15.38	3.71	14.40	3.88	11.81	4.31
	20	18.72	3.26	18.21	3.32	15.64	3.59	14.10	3.76	13.21	3.92	11.08	4.31
	21	18.49	3.32	17.94	3.36	15.18	3.57	13.52	3.70	12.66	3.88	10.69	4.32
	22	18.34	3.39	17.96	3.43	16.07	3.66	14.93	3.79	13.71	3.95	10.27	4.34
	24	18.22	3.51	17.54	3.55	14.15	3.72	12.11	3.82	11.29	3.99	9.39	4.36
3.5 + 4.2 + 4.2	16	19.88	3.12	19.50	3.18	17.62	3.53	16.49	3.74	15.43	3.90	12.21	4.28
	18	18.93	3.23	18.50	3.29	16.34	3.61	15.05	3.80	14.10	3.98	11.56	4.41
	20	18.32	3.34	17.82	3.40	15.31	3.68	13.80	3.85	12.93	4.02	10.84	4.41
	21	18.10	3.40	17.56	3.45	14.85	3.66	13.23	3.79	12.39	3.97	10.46	4.43
	22	17.95	3.47	17.58	3.51	15.72	3.74	14.61	3.88	13.41	4.05	10.05	4.44
	24	17.83	3.59	17.17	3.63	13.84	3.81	11.85	3.91	11.05	4.09	9.19	4.47
3.5 + 4.2 + 5.0	16	20.31	3.05	19.92	3.12	18.00	3.46	16.85	3.66	15.77	3.82	12.48	4.19
	18	19.34	3.16	18.90	3.22	16.70	3.54	15.38	3.72	14.40	3.90	11.81	4.32
	20	18.72	3.27	18.21	3.33	15.64	3.60	14.10	3.77	13.21	3.93	11.08	4.32
	21	18.49	3.33	17.94	3.37	15.18	3.58	13.52	3.71	12.66	3.89	10.69	4.34
	22	18.34	3.39	17.96	3.44	16.07	3.67	14.93	3.80	13.71	3.96	10.27	4.35
	24	18.22	3.52	17.54	3.55	14.15	3.73	12.11	3.83	11.29	4.00	9.39	4.37
3.5 + 4.2 + 6.0	16	20.31	3.05	19.92	3.12	18.00	3.46	16.85	3.66	15.77	3.82	12.48	4.19
	18	19.34	3.16	18.90	3.22	16.70	3.54	15.38	3.72	14.40	3.90	11.81	4.32
	20	18.72	3.27	18.21	3.33	15.64	3.60	14.10	3.77	13.21	3.93	11.08	4.32
	21	18.49	3.33	17.94	3.37	15.18	3.58	13.52	3.71	12.66	3.89	10.69	4.34
	22	18.34	3.39	17.96	3.44	16.07	3.67	14.93	3.80	13.71	3.96	10.27	4.35
	24	18.22	3.52	17.54	3.55	14.15	3.73	12.11	3.83	11.29	4.00	9.39	4.37
3.5 + 4.2 + 7.1	16	20.31	3.03	19.92	3.10	18.00	3.44	16.85	3.64	15.77	3.80	12.48	4.17
	18	19.34	3.14	18.90	3.21	16.70	3.52	15.38	3.70	14.40	3.87	11.81	4.30
	20	18.72	3.25	18.21	3.31	15.64	3.58	14.10	3.75	13.21	3.91	11.08	4.30
	21	18.49	3.31	17.94	3.36	15.18	3.56	13.52	3.69	12.66	3.87	10.69	4.31
	22	18.34	3.38	17.96	3.42	16.07	3.65	14.93	3.78	13.71	3.94	10.27	4.33
	24	18.22	3.50	17.54	3.54	14.15	3.71	12.11	3.81	11.29	3.98	9.39	4.35

Combination (Capacity)	Indoor Air Temp. °C DB	Outdoor Air Temp. °C									
		0/-1		-5/-6		-7/-8		-10/-11		-15/-	
		Total Q	Input Power	Total Q	Input Power	Total Q	Input Power	Total Q	Input Power	Total Q	Input Power
3.5 + 3.5 + 6.0	16	12.13	4.23	11.24	4.28	10.89	4.30	10.48	4.09	9.61	4.02
	18	11.51	4.31	10.74	4.27	10.01	4.25	10.28	4.07	9.69	4.01
	20	10.87	4.31	10.35	4.25	10.14	4.22	10.11	4.09	9.55	4.01
	21	10.44	4.32	9.83	4.25	9.59	4.22	9.74	4.10	9.40	4.04
	22	10.21	4.33	10.07	4.25	10.01	4.22	9.96	4.13	9.17	4.04
	24	9.53	4.39	9.89	4.29	10.03	4.25	9.83	4.19	8.57	4.12
3.5 + 3.5 + 7.1	16	12.13	4.20	11.24	4.26	10.89	4.28	10.48	4.07	9.61	3.99
	18	11.51	4.29	10.74	4.25	10.01	4.23	10.28	4.05	9.69	3.99
	20	10.87	4.28	10.35	4.22	10.14	4.20	10.11	4.07	9.55	3.99
	21	10.44	4.30	9.83	4.23	9.59	4.20	9.74	4.08	9.40	4.02
	22	10.21	4.31	10.07	4.23	10.01	4.20	9.96	4.11	9.17	4.02
	24	9.53	4.36	9.89	4.27	10.03	4.23	9.83	4.17	8.57	4.10
3.5 + 4.2 + 4.2	16	11.87	4.30	11.00	4.36	10.66	4.38	10.26	4.17	9.41	4.09
	18	11.26	4.39	10.51	4.35	9.79	4.33	10.07	4.15	9.48	4.08
	20	10.64	4.39	10.13	4.32	9.93	4.30	9.89	4.17	9.35	4.08
	21	10.22	4.40	9.62	4.33	9.38	4.30	9.53	4.18	9.20	4.12
	22	10.00	4.41	9.86	4.33	9.80	4.30	9.74	4.20	8.97	4.12
	24	9.33	4.47	9.68	4.37	9.82	4.33	9.62	4.27	8.39	4.20
3.5 + 4.2 + 5.0	16	12.13	4.22	11.24	4.27	10.89	4.29	10.48	4.08	9.61	4.00
	18	11.51	4.30	10.74	4.26	10.01	4.24	10.28	4.06	9.69	4.00
	20	10.87	4.30	10.35	4.23	10.14	4.21	10.11	4.08	9.55	4.00
	21	10.44	4.31	9.83	4.24	9.59	4.21	9.74	4.09	9.40	4.03
	22	10.21	4.32	10.07	4.24	10.01	4.21	9.96	4.12	9.17	4.03
	24	9.53	4.38	9.89	4.28	10.03	4.24	9.83	4.18	8.57	4.11
3.5 + 4.2 + 6.0	16	12.13	4.22	11.24	4.27	10.89	4.29	10.48	4.08	9.61	4.00
	18	11.51	4.30	10.74	4.26	10.01	4.24	10.28	4.06	9.69	4.00
	20	10.87	4.30	10.35	4.23	10.14	4.21	10.11	4.08	9.55	4.00
	21	10.44	4.31	9.83	4.24	9.59	4.21	9.74	4.09	9.40	4.03
	22	10.21	4.32	10.07	4.24	10.01	4.21	9.96	4.12	9.17	4.03
	24	9.53	4.38	9.89	4.28	10.03	4.24	9.83	4.18	8.57	4.11
3.5 + 4.2 + 7.1	16	12.13	4.19	11.24	4.24	10.89	4.27	10.48	4.06	9.61	3.98
	18	11.51	4.28	10.74	4.24	10.01	4.22	10.28	4.04	9.69	3.98
	20	10.87	4.27	10.35	4.21	10.14	4.19	10.11	4.06	9.55	3.98
	21	10.44	4.28	9.83	4.22	9.59	4.19	9.74	4.07	9.40	4.01
	22	10.21	4.30	10.07	4.22	10.01	4.19	9.96	4.09	9.17	4.01
	24	9.53	4.35	9.89	4.26	10.03	4.22	9.83	4.16	8.57	4.09

Combination (Capacity)	Indoor Air Temp. °C DB	Outdoor Air Temp. °C											
		16/15		15/14		10/9		7/6		6/5		2/1	
		Total Q	Input Power	Total Q	Input Power	Total Q	Input Power	Total Q	Input Power	Total Q	Input Power	Total Q	Input Power
3.5 + 5.0 + 5.0	16	20.31	2.93	19.92	2.99	18.00	3.32	16.85	3.51	15.77	3.67	12.48	4.03
	18	19.34	3.03	18.90	3.09	16.70	3.39	15.38	3.57	14.40	3.74	11.81	4.15
	20	18.72	3.14	18.21	3.19	15.64	3.46	14.10	3.62	13.21	3.78	11.08	4.15
	21	18.49	3.20	17.94	3.24	15.18	3.44	13.52	3.56	12.66	3.73	10.69	4.16
	22	18.34	3.26	17.96	3.30	16.07	3.52	14.93	3.65	13.71	3.81	10.27	4.18
	24	18.22	3.38	17.54	3.41	14.15	3.58	12.11	3.68	11.29	3.84	9.39	4.20
3.5 + 5.0 + 6.0	16	20.31	2.93	19.92	2.99	18.00	3.32	16.85	3.51	15.77	3.67	12.48	4.03
	18	19.34	3.03	18.90	3.09	16.70	3.39	15.38	3.57	14.40	3.74	11.81	4.15
	20	18.72	3.14	18.21	3.19	15.64	3.46	14.10	3.62	13.21	3.78	11.08	4.15
	21	18.49	3.20	17.94	3.24	15.18	3.44	13.52	3.56	12.66	3.73	10.69	4.16
	22	18.34	3.26	17.96	3.30	16.07	3.52	14.93	3.65	13.71	3.81	10.27	4.18
	24	18.22	3.38	17.54	3.41	14.15	3.58	12.11	3.68	11.29	3.84	9.39	4.20
3.5 + 5.0 + 7.1	16	20.74	3.01	20.35	3.08	18.38	3.41	17.20	3.61	16.10	3.77	12.75	4.14
	18	19.75	3.12	19.30	3.18	17.05	3.49	15.70	3.67	14.71	3.84	12.06	4.26
	20	19.12	3.23	18.60	3.28	15.97	3.56	14.40	3.72	13.49	3.88	11.32	4.26
	21	18.88	3.29	18.32	3.33	15.50	3.54	13.81	3.66	12.93	3.84	10.92	4.28
	22	18.73	3.35	18.34	3.39	16.41	3.62	15.25	3.75	14.00	3.91	10.49	4.29
	24	18.61	3.47	17.91	3.51	14.45	3.68	12.37	3.78	11.53	3.95	9.59	4.32
3.5 + 6.0 + 6.0	16	20.74	3.03	20.35	3.09	18.38	3.43	17.20	3.63	16.10	3.79	12.75	4.16
	18	19.75	3.13	19.30	3.20	17.05	3.51	15.70	3.69	14.71	3.86	12.06	4.29
	20	19.12	3.24	18.60	3.30	15.97	3.57	14.40	3.74	13.49	3.90	11.32	4.29
	21	18.88	3.31	18.32	3.35	15.50	3.55	13.81	3.68	12.93	3.86	10.92	4.30
	22	18.73	3.37	18.34	3.41	16.41	3.64	15.25	3.77	14.00	3.93	10.49	4.32
	24	18.61	3.49	17.91	3.53	14.45	3.70	12.37	3.80	11.53	3.97	9.59	4.34
3.5 + 6.0 + 7.1	16	20.74	3.01	20.35	3.08	18.38	3.41	17.20	3.61	16.10	3.77	12.75	4.14
	18	19.75	3.12	19.30	3.18	17.05	3.49	15.70	3.67	14.71	3.84	12.06	4.26
	20	19.12	3.23	18.60	3.28	15.97	3.56	14.40	3.72	13.49	3.88	11.32	4.26
	21	18.88	3.29	18.32	3.33	15.50	3.54	13.81	3.66	12.93	3.84	10.92	4.28
	22	18.73	3.35	18.34	3.39	16.41	3.62	15.25	3.75	14.00	3.91	10.49	4.29
	24	18.61	3.47	17.91	3.51	14.45	3.68	12.37	3.78	11.53	3.95	9.59	4.32
3.5 + 7.1 + 7.1	16	20.74	2.99	20.35	3.06	18.38	3.39	17.20	3.59	16.10	3.75	12.75	4.12
	18	19.75	3.10	19.30	3.16	17.05	3.47	15.70	3.65	14.71	3.82	12.06	4.24
	20	19.12	3.21	18.60	3.26	15.97	3.54	14.40	3.70	13.49	3.86	11.32	4.24
	21	18.88	3.27	18.32	3.31	15.50	3.52	13.81	3.64	12.93	3.81	10.92	4.25
	22	18.73	3.33	18.34	3.38	16.41	3.60	15.25	3.73	14.00	3.89	10.49	4.27
	24	18.61	3.45	17.91	3.49	14.45	3.66	12.37	3.76	11.53	3.93	9.59	4.29



Combination (Capacity)	Indoor Air Temp. °C DB	Outdoor Air Temp. °C									
		0/-1		-5/-6		-7/-8		-10/-11		-15/-	
		Total Q	Input Power	Total Q	Input Power	Total Q	Input Power	Total Q	Input Power	Total Q	Input Power
3.5 + 5.0 + 5.0	16	12.13	4.05	11.24	4.10	10.89	4.12	10.48	3.92	9.61	3.85
	18	11.51	4.13	10.74	4.09	10.01	4.07	10.28	3.90	9.69	3.84
	20	10.87	4.12	10.35	4.07	10.14	4.04	10.11	3.92	9.55	3.84
	21	10.44	4.14	9.83	4.07	9.59	4.04	9.74	3.93	9.40	3.87
	22	10.21	4.15	10.07	4.07	10.01	4.04	9.96	3.95	9.17	3.87
	24	9.53	4.20	9.89	4.11	10.03	4.07	9.83	4.02	8.57	3.95
3.5 + 5.0 + 6.0	16	12.13	4.05	11.24	4.10	10.89	4.12	10.48	3.92	9.61	3.85
	18	11.51	4.13	10.74	4.09	10.01	4.07	10.28	3.90	9.69	3.84
	20	10.87	4.12	10.35	4.07	10.14	4.04	10.11	3.92	9.55	3.84
	21	10.44	4.14	9.83	4.07	9.59	4.04	9.74	3.93	9.40	3.87
	22	10.21	4.15	10.07	4.07	10.01	4.04	9.96	3.95	9.17	3.87
	24	9.53	4.20	9.89	4.11	10.03	4.07	9.83	4.02	8.57	3.95
3.5 + 5.0 + 7.1	16	12.38	4.16	11.48	4.21	11.12	4.23	10.70	4.03	9.82	3.95
	18	11.75	4.25	10.97	4.20	10.22	4.19	10.50	4.01	9.90	3.94
	20	11.10	4.24	10.57	4.18	10.36	4.15	10.32	4.03	9.76	3.94
	21	10.67	4.25	10.04	4.18	9.79	4.15	9.94	4.04	9.60	3.98
	22	10.43	4.26	10.28	4.19	10.22	4.15	10.17	4.06	9.36	3.98
	24	9.73	4.32	10.10	4.22	10.24	4.19	10.04	4.13	8.75	4.05
3.5 + 6.0 + 6.0	16	12.38	4.18	11.48	4.23	11.12	4.25	10.70	4.05	9.82	3.97
	18	11.75	4.27	10.97	4.22	10.22	4.21	10.50	4.03	9.90	3.96
	20	11.10	4.26	10.57	4.20	10.36	4.18	10.32	4.05	9.76	3.96
	21	10.67	4.27	10.04	4.20	9.79	4.18	9.94	4.06	9.60	4.00
	22	10.43	4.29	10.28	4.21	10.22	4.18	10.17	4.08	9.36	4.00
	24	9.73	4.34	10.10	4.25	10.24	4.21	10.04	4.15	8.75	4.08
3.5 + 6.0 + 7.1	16	12.38	4.16	11.48	4.21	11.12	4.23	10.70	4.03	9.82	3.95
	18	11.75	4.25	10.97	4.20	10.22	4.19	10.50	4.01	9.90	3.94
	20	11.10	4.24	10.57	4.18	10.36	4.15	10.32	4.03	9.76	3.94
	21	10.67	4.25	10.04	4.18	9.79	4.15	9.94	4.04	9.60	3.98
	22	10.43	4.26	10.28	4.19	10.22	4.15	10.17	4.06	9.36	3.98
	24	9.73	4.32	10.10	4.22	10.24	4.19	10.04	4.13	8.75	4.05
3.5 + 7.1 + 7.1	16	12.38	4.14	11.48	4.19	11.12	4.21	10.70	4.01	9.82	3.93
	18	11.75	4.22	10.97	4.18	10.22	4.16	10.50	3.98	9.90	3.92
	20	11.10	4.22	10.57	4.16	10.36	4.13	10.32	4.01	9.76	3.92
	21	10.67	4.23	10.04	4.16	9.79	4.13	9.94	4.02	9.60	3.96
	22	10.43	4.24	10.28	4.16	10.22	4.13	10.17	4.04	9.36	3.96
	24	9.73	4.29	10.10	4.20	10.24	4.16	10.04	4.11	8.75	4.03

Combination (Capacity)	Indoor Air Temp. °C DB	Outdoor Air Temp. °C											
		16/15		15/14		10/9		7/6		6/5		2/1	
		Total Q	Input Power	Total Q	Input Power	Total Q	Input Power	Total Q	Input Power	Total Q	Input Power	Total Q	Input Power
4.2 + 4.2 + 4.2	16	19.88	3.06	19.50	3.13	17.62	3.47	16.49	3.67	15.43	3.83	12.21	4.21
	18	18.93	3.17	18.50	3.23	16.34	3.54	15.05	3.73	14.10	3.91	11.56	4.33
	20	18.32	3.28	17.82	3.33	15.31	3.61	13.80	3.78	12.93	3.94	10.84	4.33
	21	18.10	3.34	17.56	3.38	14.85	3.59	13.23	3.72	12.39	3.90	10.46	4.35
	22	17.95	3.40	17.58	3.45	15.72	3.68	14.61	3.81	13.41	3.97	10.05	4.36
	24	17.83	3.53	17.17	3.56	13.84	3.74	11.85	3.84	11.05	4.01	9.19	4.38
4.2 + 4.2 + 5.0	16	20.31	3.03	19.92	3.10	18.00	3.44	16.85	3.64	15.77	3.80	12.48	4.17
	18	19.34	3.14	18.90	3.21	16.70	3.52	15.38	3.70	14.40	3.87	11.81	4.30
	20	18.72	3.25	18.21	3.31	15.64	3.58	14.10	3.75	13.21	3.91	11.08	4.30
	21	18.49	3.31	17.94	3.36	15.18	3.56	13.52	3.69	12.66	3.87	10.69	4.31
	22	18.34	3.38	17.96	3.42	16.07	3.65	14.93	3.78	13.71	3.94	10.27	4.33
	24	18.22	3.50	17.54	3.54	14.15	3.71	12.11	3.81	11.29	3.98	9.39	4.35
4.2 + 4.2 + 6.0	16	20.31	3.03	19.92	3.10	18.00	3.44	16.85	3.64	15.77	3.80	12.48	4.17
	18	19.34	3.14	18.90	3.21	16.70	3.52	15.38	3.70	14.40	3.87	11.81	4.30
	20	18.72	3.25	18.21	3.31	15.64	3.58	14.10	3.75	13.21	3.91	11.08	4.30
	21	18.49	3.31	17.94	3.36	15.18	3.56	13.52	3.69	12.66	3.87	10.69	4.31
	22	18.34	3.38	17.96	3.42	16.07	3.65	14.93	3.78	13.71	3.94	10.27	4.33
	24	18.22	3.50	17.54	3.54	14.15	3.71	12.11	3.81	11.29	3.98	9.39	4.35
4.2 + 4.2 + 7.1	16	20.74	3.12	20.35	3.18	18.38	3.53	17.20	3.74	16.10	3.90	12.75	4.28
	18	19.75	3.23	19.30	3.29	17.05	3.61	15.70	3.80	14.71	3.98	12.06	4.41
	20	19.12	3.34	18.60	3.40	15.97	3.68	14.40	3.85	13.49	4.02	11.32	4.41
	21	18.88	3.40	18.32	3.45	15.50	3.66	13.81	3.79	12.93	3.97	10.92	4.43
	22	18.73	3.47	18.34	3.51	16.41	3.74	15.25	3.88	14.00	4.05	10.49	4.44
	24	18.61	3.59	17.91	3.63	14.45	3.81	12.37	3.91	11.53	4.09	9.59	4.47
4.2 + 5.0 + 5.0	16	20.31	2.92	19.92	2.99	18.00	3.31	16.85	3.51	15.77	3.66	12.48	4.02
	18	19.34	3.03	18.90	3.09	16.70	3.39	15.38	3.57	14.40	3.73	11.81	4.14
	20	18.72	3.13	18.21	3.18	15.64	3.45	14.10	3.61	13.21	3.77	11.08	4.14
	21	18.49	3.19	17.94	3.23	15.18	3.43	13.52	3.55	12.66	3.72	10.69	4.15
	22	18.34	3.25	17.96	3.29	16.07	3.51	14.93	3.64	13.71	3.80	10.27	4.17
	24	18.22	3.37	17.54	3.40	14.15	3.57	12.11	3.67	11.29	3.83	9.39	4.19
4.2 + 5.0 + 6.0	16	20.74	3.01	20.35	3.08	18.38	3.41	17.20	3.61	16.10	3.77	12.75	4.14
	18	19.75	3.12	19.30	3.18	17.05	3.49	15.70	3.67	14.71	3.84	12.06	4.26
	20	19.12	3.23	18.60	3.28	15.97	3.56	14.40	3.72	13.49	3.88	11.32	4.26
	21	18.88	3.29	18.32	3.33	15.50	3.54	13.81	3.66	12.93	3.84	10.92	4.28
	22	18.73	3.35	18.34	3.39	16.41	3.62	15.25	3.75	14.00	3.91	10.49	4.29
	24	18.61	3.47	17.91	3.51	14.45	3.68	12.37	3.78	11.53	3.95	9.59	4.32

Combination (Capacity)	Indoor Air Temp. °C DB	Outdoor Air Temp. °C									
		0/-1		-5/-6		-7/-8		-10/-11		-15/-	
		Total Q	Input Power	Total Q	Input Power	Total Q	Input Power	Total Q	Input Power	Total Q	Input Power
4.2 + 4.2 + 4.2	16	11.87	4.23	11.00	4.28	10.66	4.30	10.26	4.09	9.41	4.02
	18	11.26	4.31	10.51	4.27	9.79	4.25	10.07	4.07	9.48	4.01
	20	10.64	4.31	10.13	4.25	9.93	4.22	9.89	4.09	9.35	4.01
	21	10.22	4.32	9.62	4.25	9.38	4.22	9.53	4.10	9.20	4.04
	22	10.00	4.33	9.86	4.25	9.80	4.22	9.74	4.13	8.97	4.04
	24	9.33	4.39	9.68	4.29	9.82	4.25	9.62	4.19	8.39	4.12
4.2 + 4.2 + 5.0	16	12.13	4.19	11.24	4.24	10.89	4.27	10.48	4.06	9.61	3.98
	18	11.51	4.28	10.74	4.24	10.01	4.22	10.28	4.04	9.69	3.98
	20	10.87	4.27	10.35	4.21	10.14	4.19	10.11	4.06	9.55	3.98
	21	10.44	4.28	9.83	4.22	9.59	4.19	9.74	4.07	9.40	4.01
	22	10.21	4.30	10.07	4.22	10.01	4.19	9.96	4.09	9.17	4.01
	24	9.53	4.35	9.89	4.26	10.03	4.22	9.83	4.16	8.57	4.09
4.2 + 4.2 + 6.0	16	12.13	4.19	11.24	4.24	10.89	4.27	10.48	4.06	9.61	3.98
	18	11.51	4.28	10.74	4.24	10.01	4.22	10.28	4.04	9.69	3.98
	20	10.87	4.27	10.35	4.21	10.14	4.19	10.11	4.06	9.55	3.98
	21	10.44	4.28	9.83	4.22	9.59	4.19	9.74	4.07	9.40	4.01
	22	10.21	4.30	10.07	4.22	10.01	4.19	9.96	4.09	9.17	4.01
	24	9.53	4.35	9.89	4.26	10.03	4.22	9.83	4.16	8.57	4.09
4.2 + 4.2 + 7.1	16	12.38	4.30	11.48	4.36	11.12	4.38	10.70	4.17	9.82	4.09
	18	11.75	4.39	10.97	4.35	10.22	4.33	10.50	4.15	9.90	4.08
	20	11.10	4.39	10.57	4.32	10.36	4.30	10.32	4.17	9.76	4.08
	21	10.67	4.40	10.04	4.33	9.79	4.30	9.94	4.18	9.60	4.12
	22	10.43	4.41	10.28	4.33	10.22	4.30	10.17	4.20	9.36	4.12
	24	9.73	4.47	10.10	4.37	10.24	4.33	10.04	4.27	8.75	4.20
4.2 + 5.0 + 5.0	16	12.13	4.04	11.24	4.09	10.89	4.11	10.48	3.91	9.61	3.83
	18	11.51	4.12	10.74	4.08	10.01	4.06	10.28	3.89	9.69	3.83
	20	10.87	4.11	10.35	4.05	10.14	4.03	10.11	3.91	9.55	3.83
	21	10.44	4.12	9.83	4.06	9.59	4.03	9.74	3.92	9.40	3.86
	22	10.21	4.14	10.07	4.06	10.01	4.03	9.96	3.94	9.17	3.86
	24	9.53	4.19	9.89	4.10	10.03	4.06	9.83	4.01	8.57	3.93
4.2 + 5.0 + 6.0	16	12.38	4.16	11.48	4.21	11.12	4.23	10.70	4.03	9.82	3.95
	18	11.75	4.25	10.97	4.20	10.22	4.19	10.50	4.01	9.90	3.94
	20	11.10	4.24	10.57	4.18	10.36	4.15	10.32	4.03	9.76	3.94
	21	10.67	4.25	10.04	4.18	9.79	4.15	9.94	4.04	9.60	3.98
	22	10.43	4.26	10.28	4.19	10.22	4.15	10.17	4.06	9.36	3.98
	24	9.73	4.32	10.10	4.22	10.24	4.19	10.04	4.13	8.75	4.05

Combination (Capacity)	Indoor Air Temp. °C DB	Outdoor Air Temp. °C											
		16/15		15/14		10/9		7/6		6/5		2/1	
		Total Q	Input Power	Total Q	Input Power	Total Q	Input Power	Total Q	Input Power	Total Q	Input Power	Total Q	Input Power
4.2 + 5.0 + 7.1	16	20.74	3.00	20.35	3.07	18.38	3.40	17.20	3.60	16.10	3.76	12.75	4.13
	18	19.75	3.11	19.30	3.17	17.05	3.48	15.70	3.66	14.71	3.83	12.06	4.25
	20	19.12	3.22	18.60	3.27	15.97	3.55	14.40	3.71	13.49	3.87	11.32	4.25
	21	18.88	3.28	18.32	3.32	15.50	3.53	13.81	3.65	12.93	3.82	10.92	4.27
	22	18.73	3.34	18.34	3.39	16.41	3.61	15.25	3.74	14.00	3.90	10.49	4.28
	24	18.61	3.46	17.91	3.50	14.45	3.67	12.37	3.77	11.53	3.94	9.59	4.30
4.2 + 6.0 + 6.0	16	20.74	3.01	20.35	3.08	18.38	3.41	17.20	3.61	16.10	3.77	12.75	4.14
	18	19.75	3.12	19.30	3.18	17.05	3.49	15.70	3.67	14.71	3.84	12.06	4.26
	20	19.12	3.23	18.60	3.28	15.97	3.56	14.40	3.72	13.49	3.88	11.32	4.26
	21	18.88	3.29	18.32	3.33	15.50	3.54	13.81	3.66	12.93	3.84	10.92	4.28
	22	18.73	3.35	18.34	3.39	16.41	3.62	15.25	3.75	14.00	3.91	10.49	4.29
	24	18.61	3.47	17.91	3.51	14.45	3.68	12.37	3.78	11.53	3.95	9.59	4.32
4.2 + 6.0 + 7.1	16	20.74	3.00	20.35	3.07	18.38	3.40	17.20	3.60	16.10	3.76	12.75	4.13
	18	19.75	3.11	19.30	3.17	17.05	3.48	15.70	3.66	14.71	3.83	12.06	4.25
	20	19.12	3.22	18.60	3.27	15.97	3.55	14.40	3.71	13.49	3.87	11.32	4.25
	21	18.88	3.28	18.32	3.32	15.50	3.53	13.81	3.65	12.93	3.82	10.92	4.27
	22	18.73	3.34	18.34	3.39	16.41	3.61	15.25	3.74	14.00	3.90	10.49	4.28
	24	18.61	3.46	17.91	3.50	14.45	3.67	12.37	3.77	11.53	3.94	9.59	4.30
5.0 + 5.0 + 5.0	16	20.74	2.95	20.35	3.01	18.38	3.34	17.20	3.53	16.10	3.69	12.75	4.05
	18	19.75	3.05	19.30	3.11	17.05	3.41	15.70	3.59	14.71	3.76	12.06	4.17
	20	19.12	3.16	18.60	3.21	15.97	3.48	14.40	3.64	13.49	3.80	11.32	4.17
	21	18.88	3.22	18.32	3.26	15.50	3.46	13.81	3.58	12.93	3.75	10.92	4.19
	22	18.73	3.28	18.34	3.32	16.41	3.54	15.25	3.67	14.00	3.83	10.49	4.20
	24	18.61	3.40	17.91	3.43	14.45	3.60	12.37	3.70	11.53	3.86	9.59	4.22
5.0 + 5.0 + 6.0	16	20.74	2.95	20.35	3.01	18.38	3.34	17.20	3.53	16.10	3.69	12.75	4.05
	18	19.75	3.05	19.30	3.11	17.05	3.41	15.70	3.59	14.71	3.76	12.06	4.17
	20	19.12	3.16	18.60	3.21	15.97	3.48	14.40	3.64	13.49	3.80	11.32	4.17
	21	18.88	3.22	18.32	3.26	15.50	3.46	13.81	3.58	12.93	3.75	10.92	4.19
	22	18.73	3.28	18.34	3.32	16.41	3.54	15.25	3.67	14.00	3.83	10.49	4.20
	24	18.61	3.40	17.91	3.43	14.45	3.60	12.37	3.70	11.53	3.86	9.59	4.22
5.0 + 5.0 + 7.1	16	20.74	2.94	20.35	3.00	18.38	3.33	17.20	3.52	16.10	3.68	12.75	4.04
	18	19.75	3.04	19.30	3.10	17.05	3.40	15.70	3.58	14.71	3.75	12.06	4.16
	20	19.12	3.15	18.60	3.20	15.97	3.47	14.40	3.63	13.49	3.79	11.32	4.16
	21	18.88	3.21	18.32	3.25	15.50	3.45	13.81	3.57	12.93	3.74	10.92	4.17
	22	18.73	3.27	18.34	3.31	16.41	3.53	15.25	3.66	14.00	3.82	10.49	4.19
	24	18.61	3.39	17.91	3.42	14.45	3.59	12.37	3.69	11.53	3.85	9.59	4.21

Combination (Capacity)	Indoor Air Temp. °C DB	Outdoor Air Temp. °C									
		0/-1		-5/-6		-7/-8		-10/-11		-15/-	
		Total Q	Input Power	Total Q	Input Power	Total Q	Input Power	Total Q	Input Power	Total Q	Input Power
4.2 + 5.0 + 7.1	16	12.38	4.15	11.48	4.20	11.12	4.22	10.70	4.02	9.82	3.94
	18	11.75	4.23	10.97	4.19	10.22	4.17	10.50	3.99	9.90	3.93
	20	11.10	4.23	10.57	4.17	10.36	4.14	10.32	4.02	9.76	3.93
	21	10.67	4.24	10.04	4.17	9.79	4.14	9.94	4.03	9.60	3.97
	22	10.43	4.25	10.28	4.17	10.22	4.14	10.17	4.05	9.36	3.97
	24	9.73	4.31	10.10	4.21	10.24	4.17	10.04	4.12	8.75	4.04
4.2 + 6.0 + 6.0	16	12.38	4.16	11.48	4.21	11.12	4.23	10.70	4.03	9.82	3.95
	18	11.75	4.25	10.97	4.20	10.22	4.19	10.50	4.01	9.90	3.94
	20	11.10	4.24	10.57	4.18	10.36	4.15	10.32	4.03	9.76	3.94
	21	10.67	4.25	10.04	4.18	9.79	4.15	9.94	4.04	9.60	3.98
	22	10.43	4.26	10.28	4.19	10.22	4.15	10.17	4.06	9.36	3.98
	24	9.73	4.32	10.10	4.22	10.24	4.19	10.04	4.13	8.75	4.05
4.2 + 6.0 + 7.1	16	12.38	4.15	11.48	4.20	11.12	4.22	10.70	4.02	9.82	3.94
	18	11.75	4.23	10.97	4.19	10.22	4.17	10.50	3.99	9.90	3.93
	20	11.10	4.23	10.57	4.17	10.36	4.14	10.32	4.02	9.76	3.93
	21	10.67	4.24	10.04	4.17	9.79	4.14	9.94	4.03	9.60	3.97
	22	10.43	4.25	10.28	4.17	10.22	4.14	10.17	4.05	9.36	3.97
	24	9.73	4.31	10.10	4.21	10.24	4.17	10.04	4.12	8.75	4.04
5.0 + 5.0 + 5.0	16	12.38	4.07	11.48	4.12	11.12	4.14	10.70	3.94	9.82	3.87
	18	11.75	4.15	10.97	4.11	10.22	4.10	10.50	3.92	9.90	3.86
	20	11.10	4.15	10.57	4.09	10.36	4.06	10.32	3.94	9.76	3.86
	21	10.67	4.16	10.04	4.09	9.79	4.06	9.94	3.95	9.60	3.89
	22	10.43	4.17	10.28	4.10	10.22	4.06	10.17	3.97	9.36	3.89
	24	9.73	4.22	10.10	4.13	10.24	4.10	10.04	4.04	8.75	3.97
5.0 + 5.0 + 6.0	16	12.38	4.07	11.48	4.12	11.12	4.14	10.70	3.94	9.82	3.87
	18	11.75	4.15	10.97	4.11	10.22	4.10	10.50	3.92	9.90	3.86
	20	11.10	4.15	10.57	4.09	10.36	4.06	10.32	3.94	9.76	3.86
	21	10.67	4.16	10.04	4.09	9.79	4.06	9.94	3.95	9.60	3.89
	22	10.43	4.17	10.28	4.10	10.22	4.06	10.17	3.97	9.36	3.89
	24	9.73	4.22	10.10	4.13	10.24	4.10	10.04	4.04	8.75	3.97
5.0 + 5.0 + 7.1	16	12.38	4.06	11.48	4.11	11.12	4.13	10.70	3.93	9.82	3.86
	18	11.75	4.14	10.97	4.10	10.22	4.08	10.50	3.91	9.90	3.85
	20	11.10	4.14	10.57	4.08	10.36	4.05	10.32	3.93	9.76	3.85
	21	10.67	4.15	10.04	4.08	9.79	4.05	9.94	3.94	9.60	3.88
	22	10.43	4.16	10.28	4.08	10.22	4.05	10.17	3.96	9.36	3.88
	24	9.73	4.21	10.10	4.12	10.24	4.08	10.04	4.03	8.75	3.96

Combination (Capacity)	Indoor Air Temp. °C DB	Outdoor Air Temp. °C											
		16/15		15/14		10/9		7/6		6/5		2/1	
		Total Q	Input Power	Total Q	Input Power	Total Q	Input Power	Total Q	Input Power	Total Q	Input Power	Total Q	Input Power
5.0 + 6.0 + 6.0	16	20.74	2.95	20.35	3.01	18.38	3.34	17.20	3.53	16.10	3.69	12.75	4.05
	18	19.75	3.05	19.30	3.11	17.05	3.41	15.70	3.59	14.71	3.76	12.06	4.17
	20	19.12	3.16	18.60	3.21	15.97	3.48	14.40	3.64	13.49	3.80	11.32	4.17
	21	18.88	3.22	18.32	3.26	15.50	3.46	13.81	3.58	12.93	3.75	10.92	4.19
	22	18.73	3.28	18.34	3.32	16.41	3.54	15.25	3.67	14.00	3.83	10.49	4.20
	24	18.61	3.40	17.91	3.43	14.45	3.60	12.37	3.70	11.53	3.86	9.59	4.22
5.0 + 6.0 + 7.1	16	20.74	2.94	20.35	3.00	18.38	3.33	17.20	3.52	16.10	3.68	12.75	4.04
	18	19.75	3.04	19.30	3.10	17.05	3.40	15.70	3.58	14.71	3.75	12.06	4.16
	20	19.12	3.15	18.60	3.20	15.97	3.47	14.40	3.63	13.49	3.79	11.32	4.16
	21	18.88	3.21	18.32	3.25	15.50	3.45	13.81	3.57	12.93	3.74	10.92	4.17
	22	18.73	3.27	18.34	3.31	16.41	3.53	15.25	3.66	14.00	3.82	10.49	4.19
	24	18.61	3.39	17.91	3.42	14.45	3.59	12.37	3.69	11.53	3.85	9.59	4.21
6.0 + 6.0 + 6.0	16	20.74	2.95	20.35	3.01	18.38	3.34	17.20	3.53	16.10	3.69	12.75	4.05
	18	19.75	3.05	19.30	3.11	17.05	3.41	15.70	3.59	14.71	3.76	12.06	4.17
	20	19.12	3.16	18.60	3.21	15.97	3.48	14.40	3.64	13.49	3.80	11.32	4.17
	21	18.88	3.22	18.32	3.26	15.50	3.46	13.81	3.58	12.93	3.75	10.92	4.19
	22	18.73	3.28	18.34	3.32	16.41	3.54	15.25	3.67	14.00	3.83	10.49	4.20
	24	18.61	3.40	17.91	3.43	14.45	3.60	12.37	3.70	11.53	3.86	9.59	4.22
1.6 + 1.6 + 1.6 + 1.6	16	19.72	2.99	19.32	3.06	17.29	3.44	16.07	3.67	15.29	3.72	12.14	3.94
	18	18.90	3.11	18.48	3.18	16.39	3.55	15.13	3.76	14.40	3.81	11.47	4.02
	20	18.62	3.20	18.13	3.27	15.67	3.63	14.20	3.84	13.51	3.88	10.73	4.04
	21	18.65	3.23	18.09	3.28	15.33	3.55	13.67	3.71	13.01	3.78	10.34	4.05
	22	18.80	3.25	18.29	3.33	15.70	3.69	14.15	3.91	13.30	3.94	9.92	4.07
	24	19.49	3.28	18.70	3.36	14.75	3.74	12.38	3.97	11.71	4.00	9.03	4.11
1.6 + 1.6 + 1.6 + 2.0	16	19.72	2.98	19.32	3.06	17.29	3.43	16.07	3.66	15.29	3.71	12.14	3.93
	18	18.90	3.10	18.48	3.18	16.39	3.54	15.13	3.75	14.40	3.80	11.47	4.01
	20	18.62	3.19	18.13	3.26	15.67	3.62	14.20	3.83	13.51	3.87	10.73	4.02
	21	18.65	3.22	18.09	3.28	15.33	3.54	13.67	3.70	13.01	3.77	10.34	4.04
	22	18.80	3.25	18.29	3.32	15.70	3.68	14.15	3.90	13.30	3.93	9.92	4.06
	24	19.49	3.28	18.70	3.35	14.75	3.73	12.38	3.96	11.71	3.99	9.03	4.10
1.6 + 1.6 + 1.6 + 2.5	16	19.72	2.98	19.32	3.06	17.29	3.43	16.07	3.66	15.29	3.71	12.14	3.93
	18	18.90	3.10	18.48	3.18	16.39	3.54	15.13	3.75	14.40	3.80	11.47	4.01
	20	18.62	3.19	18.13	3.26	15.67	3.62	14.20	3.83	13.51	3.87	10.73	4.02
	21	18.65	3.22	18.09	3.28	15.33	3.54	13.67	3.70	13.01	3.77	10.34	4.04
	22	18.80	3.25	18.29	3.32	15.70	3.68	14.15	3.90	13.30	3.93	9.92	4.06
	24	19.49	3.28	18.70	3.35	14.75	3.73	12.38	3.96	11.71	3.99	9.03	4.10

Combination (Capacity)	Indoor Air Temp. °C DB	Outdoor Air Temp. °C									
		0/-1		-5/-6		-7/-8		-10/-11		-15/-	
		Total Q	Input Power	Total Q	Input Power	Total Q	Input Power	Total Q	Input Power	Total Q	Input Power
5.0 + 6.0 + 6.0	16	12.38	4.07	11.48	4.12	11.12	4.14	10.70	3.94	9.82	3.87
	18	11.75	4.15	10.97	4.11	10.22	4.10	10.50	3.92	9.90	3.86
	20	11.10	4.15	10.57	4.09	10.36	4.06	10.32	3.94	9.76	3.86
	21	10.67	4.16	10.04	4.09	9.79	4.06	9.94	3.95	9.60	3.89
	22	10.43	4.17	10.28	4.10	10.22	4.06	10.17	3.97	9.36	3.89
	24	9.73	4.22	10.10	4.13	10.24	4.10	10.04	4.04	8.75	3.97
5.0 + 6.0 + 7.1	16	12.38	4.06	11.48	4.11	11.12	4.13	10.70	3.93	9.82	3.86
	18	11.75	4.14	10.97	4.10	10.22	4.08	10.50	3.91	9.90	3.85
	20	11.10	4.14	10.57	4.08	10.36	4.05	10.32	3.93	9.76	3.85
	21	10.67	4.15	10.04	4.08	9.79	4.05	9.94	3.94	9.60	3.88
	22	10.43	4.16	10.28	4.08	10.22	4.05	10.17	3.96	9.36	3.88
	24	9.73	4.21	10.10	4.12	10.24	4.08	10.04	4.03	8.75	3.96
6.0 + 6.0 + 6.0	16	12.38	4.07	11.48	4.12	11.12	4.14	10.70	3.94	9.82	3.87
	18	11.75	4.15	10.97	4.11	10.22	4.10	10.50	3.92	9.90	3.86
	20	11.10	4.15	10.57	4.09	10.36	4.06	10.32	3.94	9.76	3.86
	21	10.67	4.16	10.04	4.09	9.79	4.06	9.94	3.95	9.60	3.89
	22	10.43	4.17	10.28	4.10	10.22	4.06	10.17	3.97	9.36	3.89
	24	9.73	4.22	10.10	4.13	10.24	4.10	10.04	4.04	8.75	3.97
1.6 + 1.6 + 1.6 + 1.6	16	11.79	3.89	10.90	3.77	10.54	3.72	10.13	3.59	9.45	3.37
	18	11.16	3.95	10.39	3.80	9.71	3.73	9.93	3.62	9.67	3.44
	20	10.52	3.97	10.00	3.82	9.79	3.76	9.75	3.67	9.70	3.53
	21	10.09	3.99	9.47	3.84	9.23	3.77	9.38	3.70	9.63	3.57
	22	9.86	4.01	9.71	3.85	9.66	3.79	9.60	3.73	9.51	3.62
	24	9.17	4.05	9.53	3.90	9.67	3.84	9.47	3.79	9.13	3.70
1.6 + 1.6 + 1.6 + 2.0	16	11.79	3.88	10.90	3.76	10.54	3.71	10.13	3.58	9.45	3.36
	18	11.16	3.94	10.39	3.79	9.71	3.72	9.93	3.61	9.67	3.43
	20	10.52	3.96	10.00	3.81	9.79	3.75	9.75	3.66	9.70	3.52
	21	10.09	3.98	9.47	3.83	9.23	3.77	9.38	3.69	9.63	3.56
	22	9.86	4.00	9.71	3.84	9.66	3.78	9.60	3.72	9.51	3.61
	24	9.17	4.04	9.53	3.89	9.67	3.83	9.47	3.78	9.13	3.69
1.6 + 1.6 + 1.6 + 2.5	16	11.79	3.88	10.90	3.76	10.54	3.71	10.13	3.58	9.45	3.36
	18	11.16	3.94	10.39	3.79	9.71	3.72	9.93	3.61	9.67	3.43
	20	10.52	3.96	10.00	3.81	9.79	3.75	9.75	3.66	9.70	3.52
	21	10.09	3.98	9.47	3.83	9.23	3.77	9.38	3.69	9.63	3.56
	22	9.86	4.00	9.71	3.84	9.66	3.78	9.60	3.72	9.51	3.61
	24	9.17	4.04	9.53	3.89	9.67	3.83	9.47	3.78	9.13	3.69

Combination (Capacity)	Indoor Air Temp. °C DB	Outdoor Air Temp. °C											
		16/15		15/14		10/9		7/6		6/5		2/1	
		Total Q	Input Power	Total Q	Input Power	Total Q	Input Power	Total Q	Input Power	Total Q	Input Power	Total Q	Input Power
1.6 + 1.6 + 1.6 + 3.5	16	19.72	2.96	19.32	3.03	17.29	3.41	16.07	3.63	15.29	3.68	12.14	3.90
	18	18.90	3.08	18.48	3.15	16.39	3.51	15.13	3.72	14.40	3.77	11.47	3.98
	20	18.62	3.16	18.13	3.23	15.67	3.59	14.20	3.80	13.51	3.84	10.73	3.99
	21	18.65	3.20	18.09	3.25	15.33	3.52	13.67	3.68	13.01	3.74	10.34	4.01
	22	18.80	3.22	18.29	3.29	15.70	3.65	14.15	3.87	13.30	3.90	9.92	4.03
	24	19.49	3.25	18.70	3.33	14.75	3.70	12.38	3.93	11.71	3.96	9.03	4.07
1.6 + 1.6 + 1.6 + 4.2	16	19.72	2.94	19.32	3.02	17.29	3.39	16.07	3.61	15.29	3.66	12.14	3.88
	18	18.90	3.06	18.48	3.13	16.39	3.49	15.13	3.70	14.40	3.75	11.47	3.95
	20	18.62	3.15	18.13	3.22	15.67	3.57	14.20	3.78	13.51	3.82	10.73	3.97
	21	18.65	3.18	18.09	3.23	15.33	3.50	13.67	3.66	13.01	3.72	10.34	3.99
	22	18.80	3.20	18.29	3.28	15.70	3.63	14.15	3.85	13.30	3.88	9.92	4.01
	24	19.49	3.23	18.70	3.31	14.75	3.68	12.38	3.91	11.71	3.94	9.03	4.05
1.6 + 1.6 + 1.6 + 5.0	16	19.72	2.83	19.32	2.90	17.29	3.26	16.07	3.48	15.29	3.53	12.14	3.74
	18	18.90	2.95	18.48	3.02	16.39	3.36	15.13	3.57	14.40	3.62	11.47	3.81
	20	18.62	3.03	18.13	3.10	15.67	3.44	14.20	3.64	13.51	3.68	10.73	3.83
	21	18.65	3.06	18.09	3.11	15.33	3.37	13.67	3.52	13.01	3.58	10.34	3.84
	22	18.80	3.08	18.29	3.15	15.70	3.50	14.15	3.71	13.30	3.74	9.92	3.86
	24	19.49	3.11	18.70	3.19	14.75	3.55	12.38	3.76	11.71	3.79	9.03	3.90
1.6 + 1.6 + 1.6 + 6.0	16	19.72	2.83	19.32	2.90	17.29	3.26	16.07	3.48	15.29	3.53	12.14	3.74
	18	18.90	2.95	18.48	3.02	16.39	3.36	15.13	3.57	14.40	3.62	11.47	3.81
	20	18.62	3.03	18.13	3.10	15.67	3.44	14.20	3.64	13.51	3.68	10.73	3.83
	21	18.65	3.06	18.09	3.11	15.33	3.37	13.67	3.52	13.01	3.58	10.34	3.84
	22	18.80	3.08	18.29	3.15	15.70	3.50	14.15	3.71	13.30	3.74	9.92	3.86
	24	19.49	3.11	18.70	3.19	14.75	3.55	12.38	3.76	11.71	3.79	9.03	3.90
1.6 + 1.6 + 1.6 + 7.1	16	19.72	2.82	19.32	2.89	17.29	3.24	16.07	3.46	15.29	3.51	12.14	3.71
	18	18.90	2.93	18.48	3.00	16.39	3.34	15.13	3.55	14.40	3.60	11.47	3.79
	20	18.62	3.01	18.13	3.08	15.67	3.42	14.20	3.62	13.51	3.66	10.73	3.80
	21	18.65	3.05	18.09	3.10	15.33	3.35	13.67	3.50	13.01	3.57	10.34	3.82
	22	18.80	3.07	18.29	3.14	15.70	3.48	14.15	3.69	13.30	3.72	9.92	3.84
	24	19.49	3.10	18.70	3.17	14.75	3.53	12.38	3.74	11.71	3.77	9.03	3.88
1.6 + 1.6 + 2.0 + 2.0	16	19.72	2.97	19.32	3.05	17.29	3.42	16.07	3.65	15.29	3.70	12.14	3.92
	18	18.90	3.10	18.48	3.17	16.39	3.53	15.13	3.74	14.40	3.79	11.47	4.00
	20	18.62	3.18	18.13	3.25	15.67	3.61	14.20	3.82	13.51	3.86	10.73	4.01
	21	18.65	3.21	18.09	3.27	15.33	3.53	13.67	3.69	13.01	3.76	10.34	4.03
	22	18.80	3.24	18.29	3.31	15.70	3.67	14.15	3.89	13.30	3.92	9.92	4.05
	24	19.49	3.27	18.70	3.34	14.75	3.72	12.38	3.95	11.71	3.98	9.03	4.09



Combination (Capacity)	Indoor Air Temp. °C DB	Outdoor Air Temp. °C									
		0/-1		-5/-6		-7/-8		-10/-11		-15/-	
		Total Q	Input Power	Total Q	Input Power	Total Q	Input Power	Total Q	Input Power	Total Q	Input Power
1.6 + 1.6 + 1.6 + 3.5	16	11.79	3.85	10.90	3.73	10.54	3.68	10.13	3.55	9.45	3.34
	18	11.16	3.91	10.39	3.76	9.71	3.69	9.93	3.58	9.67	3.40
	20	10.52	3.93	10.00	3.78	9.79	3.72	9.75	3.63	9.70	3.50
	21	10.09	3.95	9.47	3.80	9.23	3.74	9.38	3.66	9.63	3.54
	22	9.86	3.97	9.71	3.81	9.66	3.75	9.60	3.69	9.51	3.58
	24	9.17	4.01	9.53	3.86	9.67	3.80	9.47	3.75	9.13	3.67
1.6 + 1.6 + 1.6 + 4.2	16	11.79	3.83	10.90	3.71	10.54	3.66	10.13	3.53	9.45	3.32
	18	11.16	3.89	10.39	3.74	9.71	3.68	9.93	3.57	9.67	3.38
	20	10.52	3.91	10.00	3.76	9.79	3.70	9.75	3.62	9.70	3.48
	21	10.09	3.93	9.47	3.78	9.23	3.72	9.38	3.64	9.63	3.52
	22	9.86	3.95	9.71	3.79	9.66	3.73	9.60	3.67	9.51	3.56
	24	9.17	3.99	9.53	3.84	9.67	3.78	9.47	3.73	9.13	3.65
1.6 + 1.6 + 1.6 + 5.0	16	11.79	3.69	10.90	3.57	10.54	3.52	10.13	3.40	9.45	3.20
	18	11.16	3.75	10.39	3.60	9.71	3.54	9.93	3.43	9.67	3.26
	20	10.52	3.77	10.00	3.62	9.79	3.56	9.75	3.48	9.70	3.35
	21	10.09	3.78	9.47	3.64	9.23	3.58	9.38	3.51	9.63	3.39
	22	9.86	3.80	9.71	3.65	9.66	3.60	9.60	3.53	9.51	3.43
	24	9.17	3.84	9.53	3.70	9.67	3.64	9.47	3.59	9.13	3.51
1.6 + 1.6 + 1.6 + 6.0	16	11.79	3.69	10.90	3.57	10.54	3.52	10.13	3.40	9.45	3.20
	18	11.16	3.75	10.39	3.60	9.71	3.54	9.93	3.43	9.67	3.26
	20	10.52	3.77	10.00	3.62	9.79	3.56	9.75	3.48	9.70	3.35
	21	10.09	3.78	9.47	3.64	9.23	3.58	9.38	3.51	9.63	3.39
	22	9.86	3.80	9.71	3.65	9.66	3.60	9.60	3.53	9.51	3.43
	24	9.17	3.84	9.53	3.70	9.67	3.64	9.47	3.59	9.13	3.51
1.6 + 1.6 + 1.6 + 7.1	16	11.79	3.67	10.90	3.55	10.54	3.50	10.13	3.38	9.45	3.18
	18	11.16	3.73	10.39	3.58	9.71	3.52	9.93	3.42	9.67	3.24
	20	10.52	3.75	10.00	3.60	9.79	3.54	9.75	3.46	9.70	3.33
	21	10.09	3.76	9.47	3.62	9.23	3.56	9.38	3.49	9.63	3.37
	22	9.86	3.78	9.71	3.63	9.66	3.58	9.60	3.51	9.51	3.41
	24	9.17	3.82	9.53	3.68	9.67	3.62	9.47	3.57	9.13	3.49
1.6 + 1.6 + 2.0 + 2.0	16	11.79	3.87	10.90	3.75	10.54	3.70	10.13	3.57	9.45	3.36
	18	11.16	3.93	10.39	3.78	9.71	3.71	9.93	3.60	9.67	3.42
	20	10.52	3.95	10.00	3.80	9.79	3.74	9.75	3.65	9.70	3.51
	21	10.09	3.97	9.47	3.82	9.23	3.76	9.38	3.68	9.63	3.56
	22	9.86	3.99	9.71	3.83	9.66	3.77	9.60	3.71	9.51	3.60
	24	9.17	4.03	9.53	3.88	9.67	3.82	9.47	3.77	9.13	3.68

Combination (Capacity)	Indoor Air Temp. °C DB	Outdoor Air Temp. °C											
		16/15		15/14		10/9		7/6		6/5		2/1	
		Total Q	Input Power	Total Q	Input Power	Total Q	Input Power	Total Q	Input Power	Total Q	Input Power	Total Q	Input Power
1.6 + 1.6 + 2.0 + 2.5	16	19.72	2.97	19.32	3.05	17.29	3.42	16.07	3.65	15.29	3.70	12.14	3.92
	18	18.90	3.10	18.48	3.17	16.39	3.53	15.13	3.74	14.40	3.79	11.47	4.00
	20	18.62	3.18	18.13	3.25	15.67	3.61	14.20	3.82	13.51	3.86	10.73	4.01
	21	18.65	3.21	18.09	3.27	15.33	3.53	13.67	3.69	13.01	3.76	10.34	4.03
	22	18.80	3.24	18.29	3.31	15.70	3.67	14.15	3.89	13.30	3.92	9.92	4.05
	24	19.49	3.27	18.70	3.34	14.75	3.72	12.38	3.95	11.71	3.98	9.03	4.09
1.6 + 1.6 + 2.0 + 3.5	16	19.72	2.94	19.32	3.02	17.29	3.39	16.07	3.61	15.29	3.66	12.14	3.88
	18	18.90	3.06	18.48	3.13	16.39	3.49	15.13	3.70	14.40	3.75	11.47	3.95
	20	18.62	3.15	18.13	3.22	15.67	3.57	14.20	3.78	13.51	3.82	10.73	3.97
	21	18.65	3.18	18.09	3.23	15.33	3.50	13.67	3.66	13.01	3.72	10.34	3.99
	22	18.80	3.20	18.29	3.28	15.70	3.63	14.15	3.85	13.30	3.88	9.92	4.01
	24	19.49	3.23	18.70	3.31	14.75	3.68	12.38	3.91	11.71	3.94	9.03	4.05
1.6 + 1.6 + 2.0 + 4.2	16	19.72	2.93	19.32	3.01	17.29	3.38	16.07	3.60	15.29	3.65	12.14	3.87
	18	18.90	3.06	18.48	3.13	16.39	3.48	15.13	3.69	14.40	3.74	11.47	3.94
	20	18.62	3.14	18.13	3.21	15.67	3.56	14.20	3.77	13.51	3.81	10.73	3.96
	21	18.65	3.17	18.09	3.22	15.33	3.49	13.67	3.65	13.01	3.71	10.34	3.98
	22	18.80	3.19	18.29	3.27	15.70	3.62	14.15	3.84	13.30	3.87	9.92	4.00
	24	19.49	3.22	18.70	3.30	14.75	3.67	12.38	3.90	11.71	3.93	9.03	4.04
1.6 + 1.6 + 2.0 + 5.0	16	19.72	2.82	19.32	2.90	17.29	3.25	16.07	3.47	15.29	3.52	12.14	3.73
	18	18.90	2.94	18.48	3.01	16.39	3.35	15.13	3.56	14.40	3.61	11.47	3.80
	20	18.62	3.02	18.13	3.09	15.67	3.43	14.20	3.63	13.51	3.67	10.73	3.81
	21	18.65	3.05	18.09	3.10	15.33	3.36	13.67	3.51	13.01	3.58	10.34	3.83
	22	18.80	3.08	18.29	3.15	15.70	3.49	14.15	3.70	13.30	3.73	9.92	3.85
	24	19.49	3.10	18.70	3.18	14.75	3.54	12.38	3.75	11.71	3.78	9.03	3.89
1.6 + 1.6 + 2.0 + 6.0	16	19.72	2.82	19.32	2.90	17.29	3.25	16.07	3.47	15.29	3.52	12.14	3.73
	18	18.90	2.94	18.48	3.01	16.39	3.35	15.13	3.56	14.40	3.61	11.47	3.80
	20	18.62	3.02	18.13	3.09	15.67	3.43	14.20	3.63	13.51	3.67	10.73	3.81
	21	18.65	3.05	18.09	3.10	15.33	3.36	13.67	3.51	13.01	3.58	10.34	3.83
	22	18.80	3.08	18.29	3.15	15.70	3.49	14.15	3.70	13.30	3.73	9.92	3.85
	24	19.49	3.10	18.70	3.18	14.75	3.54	12.38	3.75	11.71	3.78	9.03	3.89
1.6 + 1.6 + 2.0 + 7.1	16	19.72	2.81	19.32	2.88	17.29	3.24	16.07	3.45	15.29	3.50	12.14	3.70
	18	18.90	2.93	18.48	2.99	16.39	3.33	15.13	3.54	14.40	3.59	11.47	3.78
	20	18.62	3.00	18.13	3.07	15.67	3.41	14.20	3.61	13.51	3.65	10.73	3.79
	21	18.65	3.04	18.09	3.09	15.33	3.34	13.67	3.49	13.01	3.56	10.34	3.81
	22	18.80	3.06	18.29	3.13	15.70	3.47	14.15	3.68	13.30	3.71	9.92	3.83
	24	19.49	3.09	18.70	3.16	14.75	3.52	12.38	3.73	11.71	3.76	9.03	3.87

Combination (Capacity)	Indoor Air Temp. °C DB	Outdoor Air Temp. °C									
		0/-1		-5/-6		-7/-8		-10/-11		-15/-	
		Total Q	Input Power	Total Q	Input Power	Total Q	Input Power	Total Q	Input Power	Total Q	Input Power
1.6 + 1.6 + 2.0 + 2.5	16	11.79	3.87	10.90	3.75	10.54	3.70	10.13	3.57	9.45	3.36
	18	11.16	3.93	10.39	3.78	9.71	3.71	9.93	3.60	9.67	3.42
	20	10.52	3.95	10.00	3.80	9.79	3.74	9.75	3.65	9.70	3.51
	21	10.09	3.97	9.47	3.82	9.23	3.76	9.38	3.68	9.63	3.56
	22	9.86	3.99	9.71	3.83	9.66	3.77	9.60	3.71	9.51	3.60
	24	9.17	4.03	9.53	3.88	9.67	3.82	9.47	3.77	9.13	3.68
1.6 + 1.6 + 2.0 + 3.5	16	11.79	3.83	10.90	3.71	10.54	3.66	10.13	3.53	9.45	3.32
	18	11.16	3.89	10.39	3.74	9.71	3.68	9.93	3.57	9.67	3.38
	20	10.52	3.91	10.00	3.76	9.79	3.70	9.75	3.62	9.70	3.48
	21	10.09	3.93	9.47	3.78	9.23	3.72	9.38	3.64	9.63	3.52
	22	9.86	3.95	9.71	3.79	9.66	3.73	9.60	3.67	9.51	3.56
	24	9.17	3.99	9.53	3.84	9.67	3.78	9.47	3.73	9.13	3.65
1.6 + 1.6 + 2.0 + 4.2	16	11.79	3.82	10.90	3.70	10.54	3.65	10.13	3.52	9.45	3.31
	18	11.16	3.88	10.39	3.73	9.71	3.67	9.93	3.56	9.67	3.37
	20	10.52	3.90	10.00	3.75	9.79	3.69	9.75	3.61	9.70	3.47
	21	10.09	3.92	9.47	3.77	9.23	3.71	9.38	3.63	9.63	3.51
	22	9.86	3.94	9.71	3.78	9.66	3.72	9.60	3.66	9.51	3.55
	24	9.17	3.98	9.53	3.83	9.67	3.77	9.47	3.72	9.13	3.64
1.6 + 1.6 + 2.0 + 5.0	16	11.79	3.68	10.90	3.56	10.54	3.51	10.13	3.39	9.45	3.19
	18	11.16	3.74	10.39	3.59	9.71	3.53	9.93	3.42	9.67	3.25
	20	10.52	3.76	10.00	3.61	9.79	3.55	9.75	3.47	9.70	3.34
	21	10.09	3.77	9.47	3.63	9.23	3.57	9.38	3.50	9.63	3.38
	22	9.86	3.79	9.71	3.64	9.66	3.59	9.60	3.52	9.51	3.42
	24	9.17	3.83	9.53	3.69	9.67	3.63	9.47	3.58	9.13	3.50
1.6 + 1.6 + 2.0 + 6.0	16	11.79	3.68	10.90	3.56	10.54	3.51	10.13	3.39	9.45	3.19
	18	11.16	3.74	10.39	3.59	9.71	3.53	9.93	3.42	9.67	3.25
	20	10.52	3.76	10.00	3.61	9.79	3.55	9.75	3.47	9.70	3.34
	21	10.09	3.77	9.47	3.63	9.23	3.57	9.38	3.50	9.63	3.38
	22	9.86	3.79	9.71	3.64	9.66	3.59	9.60	3.52	9.51	3.42
	24	9.17	3.83	9.53	3.69	9.67	3.63	9.47	3.58	9.13	3.50
1.6 + 1.6 + 2.0 + 7.1	16	11.79	3.66	10.90	3.54	10.54	3.49	10.13	3.37	9.45	3.17
	18	11.16	3.72	10.39	3.57	9.71	3.51	9.93	3.41	9.67	3.23
	20	10.52	3.74	10.00	3.59	9.79	3.53	9.75	3.45	9.70	3.32
	21	10.09	3.75	9.47	3.61	9.23	3.55	9.38	3.48	9.63	3.36
	22	9.86	3.77	9.71	3.62	9.66	3.57	9.60	3.50	9.51	3.40
	24	9.17	3.81	9.53	3.67	9.67	3.61	9.47	3.56	9.13	3.48

Combination (Capacity)	Indoor Air Temp. °C DB	Outdoor Air Temp. °C											
		16/15		15/14		10/9		7/6		6/5		2/1	
		Total Q	Input Power	Total Q	Input Power	Total Q	Input Power	Total Q	Input Power	Total Q	Input Power	Total Q	Input Power
1.6 + 1.6 + 2.5 + 2.5	16	19.72	2.97	19.32	3.05	17.29	3.42	16.07	3.65	15.29	3.70	12.14	3.92
	18	18.90	3.10	18.48	3.17	16.39	3.53	15.13	3.74	14.40	3.79	11.47	4.00
	20	18.62	3.18	18.13	3.25	15.67	3.61	14.20	3.82	13.51	3.86	10.73	4.01
	21	18.65	3.21	18.09	3.27	15.33	3.53	13.67	3.69	13.01	3.76	10.34	4.03
	22	18.80	3.24	18.29	3.31	15.70	3.67	14.15	3.89	13.30	3.92	9.92	4.05
	24	19.49	3.27	18.70	3.34	14.75	3.72	12.38	3.95	11.71	3.98	9.03	4.09
1.6 + 1.6 + 2.5 + 3.5	16	19.72	2.94	19.32	3.02	17.29	3.39	16.07	3.61	15.29	3.66	12.14	3.88
	18	18.90	3.06	18.48	3.13	16.39	3.49	15.13	3.70	14.40	3.75	11.47	3.95
	20	18.62	3.15	18.13	3.22	15.67	3.57	14.20	3.78	13.51	3.82	10.73	3.97
	21	18.65	3.18	18.09	3.23	15.33	3.50	13.67	3.66	13.01	3.72	10.34	3.99
	22	18.80	3.20	18.29	3.28	15.70	3.63	14.15	3.85	13.30	3.88	9.92	4.01
	24	19.49	3.23	18.70	3.31	14.75	3.68	12.38	3.91	11.71	3.94	9.03	4.05
1.6 + 1.6 + 2.5 + 4.2	16	19.72	2.93	19.32	3.01	17.29	3.38	16.07	3.60	15.29	3.65	12.14	3.87
	18	18.90	3.06	18.48	3.13	16.39	3.48	15.13	3.69	14.40	3.74	11.47	3.94
	20	18.62	3.14	18.13	3.21	15.67	3.56	14.20	3.77	13.51	3.81	10.73	3.96
	21	18.65	3.17	18.09	3.22	15.33	3.49	13.67	3.65	13.01	3.71	10.34	3.98
	22	18.80	3.19	18.29	3.27	15.70	3.62	14.15	3.84	13.30	3.87	9.92	4.00
	24	19.49	3.22	18.70	3.30	14.75	3.67	12.38	3.90	11.71	3.93	9.03	4.04
1.6 + 1.6 + 2.5 + 5.0	16	19.72	2.82	19.32	2.90	17.29	3.25	16.07	3.47	15.29	3.52	12.14	3.73
	18	18.90	2.94	18.48	3.01	16.39	3.35	15.13	3.56	14.40	3.61	11.47	3.80
	20	18.62	3.02	18.13	3.09	15.67	3.43	14.20	3.63	13.51	3.67	10.73	3.81
	21	18.65	3.05	18.09	3.10	15.33	3.36	13.67	3.51	13.01	3.58	10.34	3.83
	22	18.80	3.08	18.29	3.15	15.70	3.49	14.15	3.70	13.30	3.73	9.92	3.85
	24	19.49	3.10	18.70	3.18	14.75	3.54	12.38	3.75	11.71	3.78	9.03	3.89
1.6 + 1.6 + 2.5 + 6.0	16	19.72	2.82	19.32	2.90	17.29	3.25	16.07	3.47	15.29	3.52	12.14	3.73
	18	18.90	2.94	18.48	3.01	16.39	3.35	15.13	3.56	14.40	3.61	11.47	3.80
	20	18.62	3.02	18.13	3.09	15.67	3.43	14.20	3.63	13.51	3.67	10.73	3.81
	21	18.65	3.05	18.09	3.10	15.33	3.36	13.67	3.51	13.01	3.58	10.34	3.83
	22	18.80	3.08	18.29	3.15	15.70	3.49	14.15	3.70	13.30	3.73	9.92	3.85
	24	19.49	3.10	18.70	3.18	14.75	3.54	12.38	3.75	11.71	3.78	9.03	3.89
1.6 + 1.6 + 2.5 + 7.1	16	20.00	2.86	19.59	2.93	17.53	3.29	16.30	3.51	15.50	3.56	12.31	3.77
	18	19.17	2.97	18.74	3.04	16.62	3.39	15.34	3.60	14.60	3.65	11.63	3.84
	20	18.88	3.05	18.39	3.12	15.89	3.46	14.40	3.67	13.70	3.71	10.88	3.86
	21	18.91	3.09	18.35	3.14	15.55	3.40	13.87	3.55	13.19	3.61	10.48	3.87
	22	19.07	3.11	18.55	3.18	15.92	3.53	14.35	3.74	13.49	3.77	10.06	3.89
	24	19.76	3.14	18.96	3.21	14.96	3.58	12.55	3.79	11.87	3.82	9.15	3.93

Combination (Capacity)	Indoor Air Temp. °C DB	Outdoor Air Temp. °C									
		0/-1		-5/-6		-7/-8		-10/-11		-15/-	
		Total Q	Input Power	Total Q	Input Power	Total Q	Input Power	Total Q	Input Power	Total Q	Input Power
1.6 + 1.6 + 2.5 + 2.5	16	11.79	3.87	10.90	3.75	10.54	3.70	10.13	3.57	9.45	3.36
	18	11.16	3.93	10.39	3.78	9.71	3.71	9.93	3.60	9.67	3.42
	20	10.52	3.95	10.00	3.80	9.79	3.74	9.75	3.65	9.70	3.51
	21	10.09	3.97	9.47	3.82	9.23	3.76	9.38	3.68	9.63	3.56
	22	9.86	3.99	9.71	3.83	9.66	3.77	9.60	3.71	9.51	3.60
	24	9.17	4.03	9.53	3.88	9.67	3.82	9.47	3.77	9.13	3.68
1.6 + 1.6 + 2.5 + 3.5	16	11.79	3.83	10.90	3.71	10.54	3.66	10.13	3.53	9.45	3.32
	18	11.16	3.89	10.39	3.74	9.71	3.68	9.93	3.57	9.67	3.38
	20	10.52	3.91	10.00	3.76	9.79	3.70	9.75	3.62	9.70	3.48
	21	10.09	3.93	9.47	3.78	9.23	3.72	9.38	3.64	9.63	3.52
	22	9.86	3.95	9.71	3.79	9.66	3.73	9.60	3.67	9.51	3.56
	24	9.17	3.99	9.53	3.84	9.67	3.78	9.47	3.73	9.13	3.65
1.6 + 1.6 + 2.5 + 4.2	16	11.79	3.82	10.90	3.70	10.54	3.65	10.13	3.52	9.45	3.31
	18	11.16	3.88	10.39	3.73	9.71	3.67	9.93	3.56	9.67	3.37
	20	10.52	3.90	10.00	3.75	9.79	3.69	9.75	3.61	9.70	3.47
	21	10.09	3.92	9.47	3.77	9.23	3.71	9.38	3.63	9.63	3.51
	22	9.86	3.94	9.71	3.78	9.66	3.72	9.60	3.66	9.51	3.55
	24	9.17	3.98	9.53	3.83	9.67	3.77	9.47	3.72	9.13	3.64
1.6 + 1.6 + 2.5 + 5.0	16	11.79	3.68	10.90	3.56	10.54	3.51	10.13	3.39	9.45	3.19
	18	11.16	3.74	10.39	3.59	9.71	3.53	9.93	3.42	9.67	3.25
	20	10.52	3.76	10.00	3.61	9.79	3.55	9.75	3.47	9.70	3.34
	21	10.09	3.77	9.47	3.63	9.23	3.57	9.38	3.50	9.63	3.38
	22	9.86	3.79	9.71	3.64	9.66	3.59	9.60	3.52	9.51	3.42
	24	9.17	3.83	9.53	3.69	9.67	3.63	9.47	3.58	9.13	3.50
1.6 + 1.6 + 2.5 + 6.0	16	11.79	3.68	10.90	3.56	10.54	3.51	10.13	3.39	9.45	3.19
	18	11.16	3.74	10.39	3.59	9.71	3.53	9.93	3.42	9.67	3.25
	20	10.52	3.76	10.00	3.61	9.79	3.55	9.75	3.47	9.70	3.34
	21	10.09	3.77	9.47	3.63	9.23	3.57	9.38	3.50	9.63	3.38
	22	9.86	3.79	9.71	3.64	9.66	3.59	9.60	3.52	9.51	3.42
	24	9.17	3.83	9.53	3.69	9.67	3.63	9.47	3.58	9.13	3.50
1.6 + 1.6 + 2.5 + 7.1	16	11.95	3.72	11.05	3.60	10.69	3.55	10.27	3.43	9.58	3.22
	18	11.32	3.78	10.54	3.63	9.85	3.57	10.07	3.46	9.81	3.29
	20	10.67	3.80	10.14	3.65	9.93	3.59	9.89	3.51	9.84	3.38
	21	10.23	3.81	9.61	3.67	9.36	3.61	9.51	3.54	9.77	3.42
	22	10.00	3.83	9.85	3.68	9.79	3.62	9.74	3.56	9.64	3.46
	24	9.30	3.87	9.66	3.73	9.81	3.67	9.60	3.62	9.26	3.54

Combination (Capacity)	Indoor Air Temp. °C DB	Outdoor Air Temp. °C											
		16/15		15/14		10/9		7/6		6/5		2/1	
		Total Q	Input Power	Total Q	Input Power	Total Q	Input Power	Total Q	Input Power	Total Q	Input Power	Total Q	Input Power
1.6 + 1.6 + 3.5 + 3.5	16	19.72	2.92	19.32	2.99	17.29	3.36	16.07	3.58	15.29	3.64	12.14	3.85
	18	18.90	3.04	18.48	3.11	16.39	3.46	15.13	3.67	14.40	3.72	11.47	3.92
	20	18.62	3.12	18.13	3.19	15.67	3.54	14.20	3.75	13.51	3.79	10.73	3.94
	21	18.65	3.15	18.09	3.21	15.33	3.47	13.67	3.63	13.01	3.69	10.34	3.96
	22	18.80	3.18	18.29	3.25	15.70	3.61	14.15	3.82	13.30	3.85	9.92	3.98
	24	19.49	3.21	18.70	3.28	14.75	3.65	12.38	3.88	11.71	3.90	9.03	4.02
1.6 + 1.6 + 3.5 + 4.2	16	19.72	2.86	19.32	2.94	17.29	3.30	16.07	3.52	15.29	3.57	12.14	3.78
	18	18.90	2.98	18.48	3.05	16.39	3.40	15.13	3.61	14.40	3.66	11.47	3.85
	20	18.62	3.06	18.13	3.13	15.67	3.47	14.20	3.68	13.51	3.72	10.73	3.87
	21	18.65	3.10	18.09	3.15	15.33	3.40	13.67	3.56	13.01	3.62	10.34	3.88
	22	18.80	3.12	18.29	3.19	15.70	3.54	14.15	3.75	13.30	3.78	9.92	3.90
	24	19.49	3.15	18.70	3.22	14.75	3.59	12.38	3.80	11.71	3.83	9.03	3.94
1.6 + 1.6 + 3.5 + 5.0	16	19.72	2.79	19.32	2.86	17.29	3.22	16.07	3.43	15.29	3.48	12.14	3.68
	18	18.90	2.91	18.48	2.98	16.39	3.32	15.13	3.52	14.40	3.57	11.47	3.76
	20	18.62	2.99	18.13	3.05	15.67	3.39	14.20	3.59	13.51	3.63	10.73	3.77
	21	18.65	3.02	18.09	3.07	15.33	3.32	13.67	3.47	13.01	3.54	10.34	3.79
	22	18.80	3.04	18.29	3.11	15.70	3.45	14.15	3.66	13.30	3.69	9.92	3.81
	24	19.49	3.07	18.70	3.14	14.75	3.50	12.38	3.71	11.71	3.74	9.03	3.84
1.6 + 1.6 + 3.5 + 6.0	16	19.72	2.79	19.32	2.86	17.29	3.22	16.07	3.43	15.29	3.48	12.14	3.68
	18	18.90	2.91	18.48	2.98	16.39	3.32	15.13	3.52	14.40	3.57	11.47	3.76
	20	18.62	2.99	18.13	3.05	15.67	3.39	14.20	3.59	13.51	3.63	10.73	3.77
	21	18.65	3.02	18.09	3.07	15.33	3.32	13.67	3.47	13.01	3.54	10.34	3.79
	22	18.80	3.04	18.29	3.11	15.70	3.45	14.15	3.66	13.30	3.69	9.92	3.81
	24	19.49	3.07	18.70	3.14	14.75	3.50	12.38	3.71	11.71	3.74	9.03	3.84
1.6 + 1.6 + 3.5 + 7.1	16	20.00	2.83	19.59	2.90	17.53	3.26	16.30	3.48	15.50	3.53	12.31	3.74
	18	19.17	2.95	18.74	3.02	16.62	3.36	15.34	3.57	14.60	3.62	11.63	3.81
	20	18.88	3.03	18.39	3.10	15.89	3.44	14.40	3.64	13.70	3.68	10.88	3.83
	21	18.91	3.06	18.35	3.11	15.55	3.37	13.87	3.52	13.19	3.58	10.48	3.84
	22	19.07	3.08	18.55	3.15	15.92	3.50	14.35	3.71	13.49	3.74	10.06	3.86
	24	19.76	3.11	18.96	3.19	14.96	3.55	12.55	3.76	11.87	3.79	9.15	3.90
1.6 + 1.6 + 4.2 + 4.2	16	19.72	2.85	19.32	2.92	17.29	3.28	16.07	3.50	15.29	3.55	12.14	3.76
	18	18.90	2.97	18.48	3.04	16.39	3.38	15.13	3.59	14.40	3.64	11.47	3.83
	20	18.62	3.05	18.13	3.11	15.67	3.46	14.20	3.66	13.51	3.70	10.73	3.85
	21	18.65	3.08	18.09	3.13	15.33	3.39	13.67	3.54	13.01	3.60	10.34	3.86
	22	18.80	3.10	18.29	3.17	15.70	3.52	14.15	3.73	13.30	3.76	9.92	3.88
	24	19.49	3.13	18.70	3.20	14.75	3.57	12.38	3.78	11.71	3.81	9.03	3.92

Combination (Capacity)	Indoor Air Temp. °C DB	Outdoor Air Temp. °C									
		0/-1		-5/-6		-7/-8		-10/-11		-15/-	
		Total Q	Input Power	Total Q	Input Power	Total Q	Input Power	Total Q	Input Power	Total Q	Input Power
1.6 + 1.6 + 3.5 + 3.5	16	11.79	3.80	10.90	3.68	10.54	3.63	10.13	3.50	9.45	3.29
	18	11.16	3.86	10.39	3.71	9.71	3.65	9.93	3.54	9.67	3.36
	20	10.52	3.88	10.00	3.73	9.79	3.67	9.75	3.59	9.70	3.45
	21	10.09	3.90	9.47	3.75	9.23	3.69	9.38	3.61	9.63	3.49
	22	9.86	3.91	9.71	3.76	9.66	3.70	9.60	3.64	9.51	3.53
	24	9.17	3.96	9.53	3.81	9.67	3.75	9.47	3.70	9.13	3.62
1.6 + 1.6 + 3.5 + 4.2	16	11.79	3.73	10.90	3.61	10.54	3.56	10.13	3.44	9.45	3.23
	18	11.16	3.79	10.39	3.64	9.71	3.58	9.93	3.47	9.67	3.29
	20	10.52	3.81	10.00	3.66	9.79	3.60	9.75	3.52	9.70	3.39
	21	10.09	3.82	9.47	3.68	9.23	3.62	9.38	3.55	9.63	3.42
	22	9.86	3.84	9.71	3.69	9.66	3.63	9.60	3.57	9.51	3.46
	24	9.17	3.88	9.53	3.74	9.67	3.68	9.47	3.63	9.13	3.55
1.6 + 1.6 + 3.5 + 5.0	16	11.79	3.64	10.90	3.52	10.54	3.47	10.13	3.35	9.45	3.15
	18	11.16	3.70	10.39	3.55	9.71	3.49	9.93	3.39	9.67	3.21
	20	10.52	3.71	10.00	3.57	9.79	3.51	9.75	3.43	9.70	3.30
	21	10.09	3.73	9.47	3.59	9.23	3.53	9.38	3.46	9.63	3.34
	22	9.86	3.75	9.71	3.60	9.66	3.55	9.60	3.48	9.51	3.38
	24	9.17	3.79	9.53	3.65	9.67	3.59	9.47	3.54	9.13	3.46
1.6 + 1.6 + 3.5 + 6.0	16	11.79	3.64	10.90	3.52	10.54	3.47	10.13	3.35	9.45	3.15
	18	11.16	3.70	10.39	3.55	9.71	3.49	9.93	3.39	9.67	3.21
	20	10.52	3.71	10.00	3.57	9.79	3.51	9.75	3.43	9.70	3.30
	21	10.09	3.73	9.47	3.59	9.23	3.53	9.38	3.46	9.63	3.34
	22	9.86	3.75	9.71	3.60	9.66	3.55	9.60	3.48	9.51	3.38
	24	9.17	3.79	9.53	3.65	9.67	3.59	9.47	3.54	9.13	3.46
1.6 + 1.6 + 3.5 + 7.1	16	11.95	3.69	11.05	3.57	10.69	3.52	10.27	3.40	9.58	3.20
	18	11.32	3.75	10.54	3.60	9.85	3.54	10.07	3.43	9.81	3.26
	20	10.67	3.77	10.14	3.62	9.93	3.56	9.89	3.48	9.84	3.35
	21	10.23	3.78	9.61	3.64	9.36	3.58	9.51	3.51	9.77	3.39
	22	10.00	3.80	9.85	3.65	9.79	3.60	9.74	3.53	9.64	3.43
	24	9.30	3.84	9.66	3.70	9.81	3.64	9.60	3.59	9.26	3.51
1.6 + 1.6 + 4.2 + 4.2	16	11.79	3.71	10.90	3.59	10.54	3.54	10.13	3.42	9.45	3.21
	18	11.16	3.77	10.39	3.62	9.71	3.56	9.93	3.45	9.67	3.28
	20	10.52	3.79	10.00	3.64	9.79	3.58	9.75	3.50	9.70	3.37
	21	10.09	3.80	9.47	3.66	9.23	3.60	9.38	3.53	9.63	3.41
	22	9.86	3.82	9.71	3.67	9.66	3.61	9.60	3.55	9.51	3.45
	24	9.17	3.86	9.53	3.72	9.67	3.66	9.47	3.61	9.13	3.53

Combination (Capacity)	Indoor Air Temp. °C DB	Outdoor Air Temp. °C											
		16/15		15/14		10/9		7/6		6/5		2/1	
		Total Q	Input Power	Total Q	Input Power	Total Q	Input Power	Total Q	Input Power	Total Q	Input Power	Total Q	Input Power
1.6 + 1.6 + 4.2 + 5.0	16	19.72	2.79	19.32	2.86	17.29	3.21	16.07	3.42	15.29	3.47	12.14	3.67
	18	18.90	2.90	18.48	2.97	16.39	3.31	15.13	3.51	14.40	3.56	11.47	3.75
	20	18.62	2.98	18.13	3.05	15.67	3.38	14.20	3.58	13.51	3.62	10.73	3.76
	21	18.65	3.01	18.09	3.06	15.33	3.31	13.67	3.46	13.01	3.53	10.34	3.78
	22	18.80	3.03	18.29	3.10	15.70	3.44	14.15	3.65	13.30	3.68	9.92	3.80
	24	19.49	3.06	18.70	3.13	14.75	3.49	12.38	3.70	11.71	3.73	9.03	3.83
1.6 + 1.6 + 4.2 + 6.0	16	20.00	2.83	19.59	2.90	17.53	3.26	16.30	3.48	15.50	3.53	12.31	3.74
	18	19.17	2.95	18.74	3.02	16.62	3.36	15.34	3.57	14.60	3.62	11.63	3.81
	20	18.88	3.03	18.39	3.10	15.89	3.44	14.40	3.64	13.70	3.68	10.88	3.83
	21	18.91	3.06	18.35	3.11	15.55	3.37	13.87	3.52	13.19	3.58	10.48	3.84
	22	19.07	3.08	18.55	3.15	15.92	3.50	14.35	3.71	13.49	3.74	10.06	3.86
	24	19.76	3.11	18.96	3.19	14.96	3.55	12.55	3.76	11.87	3.79	9.15	3.90
1.6 + 1.6 + 4.2 + 7.1	16	20.00	2.82	19.59	2.89	17.53	3.24	16.30	3.46	15.50	3.51	12.31	3.71
	18	19.17	2.93	18.74	3.00	16.62	3.34	15.34	3.55	14.60	3.60	11.63	3.79
	20	18.88	3.01	18.39	3.08	15.89	3.42	14.40	3.62	13.70	3.66	10.88	3.80
	21	18.91	3.05	18.35	3.10	15.55	3.35	13.87	3.50	13.19	3.57	10.48	3.82
	22	19.07	3.07	18.55	3.14	15.92	3.48	14.35	3.69	13.49	3.72	10.06	3.84
	24	19.76	3.10	18.96	3.17	14.96	3.53	12.55	3.74	11.87	3.77	9.15	3.88
1.6 + 1.6 + 5.0 + 5.0	16	20.00	2.78	19.59	2.85	17.53	3.20	16.30	3.41	15.50	3.46	12.31	3.66
	18	19.17	2.89	18.74	2.96	16.62	3.30	15.34	3.50	14.60	3.55	11.63	3.74
	20	18.88	2.97	18.39	3.04	15.89	3.37	14.40	3.57	13.70	3.61	10.88	3.75
	21	18.91	3.00	18.35	3.05	15.55	3.30	13.87	3.45	13.19	3.52	10.48	3.77
	22	19.07	3.03	18.55	3.09	15.92	3.43	14.35	3.64	13.49	3.67	10.06	3.78
	24	19.76	3.05	18.96	3.12	14.96	3.48	12.55	3.69	11.87	3.72	9.15	3.82
1.6 + 1.6 + 5.0 + 6.0	16	20.00	2.78	19.59	2.85	17.53	3.20	16.30	3.41	15.50	3.46	12.31	3.66
	18	19.17	2.89	18.74	2.96	16.62	3.30	15.34	3.50	14.60	3.55	11.63	3.74
	20	18.88	2.97	18.39	3.04	15.89	3.37	14.40	3.57	13.70	3.61	10.88	3.75
	21	18.91	3.00	18.35	3.05	15.55	3.30	13.87	3.45	13.19	3.52	10.48	3.77
	22	19.07	3.03	18.55	3.09	15.92	3.43	14.35	3.64	13.49	3.67	10.06	3.78
	24	19.76	3.05	18.96	3.12	14.96	3.48	12.55	3.69	11.87	3.72	9.15	3.82
1.6 + 1.6 + 5.0 + 7.1	16	20.00	2.76	19.59	2.83	17.53	3.18	16.30	3.39	15.50	3.44	12.31	3.64
	18	19.17	2.88	18.74	2.94	16.62	3.28	15.34	3.48	14.60	3.53	11.63	3.71
	20	18.88	2.95	18.39	3.02	15.89	3.35	14.40	3.55	13.70	3.59	10.88	3.73
	21	18.91	2.99	18.35	3.04	15.55	3.28	13.87	3.43	13.19	3.50	10.48	3.75
	22	19.07	3.01	18.55	3.08	15.92	3.41	14.35	3.62	13.49	3.65	10.06	3.76
	24	19.76	3.04	18.96	3.11	14.96	3.46	12.55	3.67	11.87	3.70	9.15	3.80



Combination (Capacity)	Indoor Air Temp. °C DB	Outdoor Air Temp. °C									
		0/-1		-5/-6		-7/-8		-10/-11		-15/-	
		Total Q	Input Power	Total Q	Input Power	Total Q	Input Power	Total Q	Input Power	Total Q	Input Power
1.6 + 1.6 + 4.2 + 5.0	16	11.79	3.63	10.90	3.51	10.54	3.46	10.13	3.34	9.45	3.14
	18	11.16	3.69	10.39	3.54	9.71	3.48	9.93	3.38	9.67	3.20
	20	10.52	3.70	10.00	3.56	9.79	3.50	9.75	3.42	9.70	3.29
	21	10.09	3.72	9.47	3.58	9.23	3.52	9.38	3.45	9.63	3.33
	22	9.86	3.74	9.71	3.59	9.66	3.54	9.60	3.47	9.51	3.37
	24	9.17	3.78	9.53	3.64	9.67	3.58	9.47	3.53	9.13	3.45
1.6 + 1.6 + 4.2 + 6.0	16	11.95	3.69	11.05	3.57	10.69	3.52	10.27	3.40	9.58	3.20
	18	11.32	3.75	10.54	3.60	9.85	3.54	10.07	3.43	9.81	3.26
	20	10.67	3.77	10.14	3.62	9.93	3.56	9.89	3.48	9.84	3.35
	21	10.23	3.78	9.61	3.64	9.36	3.58	9.51	3.51	9.77	3.39
	22	10.00	3.80	9.85	3.65	9.79	3.60	9.74	3.53	9.64	3.43
	24	9.30	3.84	9.66	3.70	9.81	3.64	9.60	3.59	9.26	3.51
1.6 + 1.6 + 4.2 + 7.1	16	11.95	3.67	11.05	3.55	10.69	3.50	10.27	3.38	9.58	3.18
	18	11.32	3.73	10.54	3.58	9.85	3.52	10.07	3.42	9.81	3.24
	20	10.67	3.75	10.14	3.60	9.93	3.54	9.89	3.46	9.84	3.33
	21	10.23	3.76	9.61	3.62	9.36	3.56	9.51	3.49	9.77	3.37
	22	10.00	3.78	9.85	3.63	9.79	3.58	9.74	3.51	9.64	3.41
	24	9.30	3.82	9.66	3.68	9.81	3.62	9.60	3.57	9.26	3.49
1.6 + 1.6 + 5.0 + 5.0	16	11.95	3.62	11.05	3.50	10.69	3.45	10.27	3.33	9.58	3.14
	18	11.32	3.68	10.54	3.53	9.85	3.47	10.07	3.37	9.81	3.20
	20	10.67	3.69	10.14	3.55	9.93	3.49	9.89	3.41	9.84	3.28
	21	10.23	3.71	9.61	3.57	9.36	3.51	9.51	3.44	9.77	3.32
	22	10.00	3.73	9.85	3.58	9.79	3.53	9.74	3.46	9.64	3.36
	24	9.30	3.77	9.66	3.63	9.81	3.57	9.60	3.52	9.26	3.44
1.6 + 1.6 + 5.0 + 6.0	16	11.95	3.62	11.05	3.50	10.69	3.45	10.27	3.33	9.58	3.14
	18	11.32	3.68	10.54	3.53	9.85	3.47	10.07	3.37	9.81	3.20
	20	10.67	3.69	10.14	3.55	9.93	3.49	9.89	3.41	9.84	3.28
	21	10.23	3.71	9.61	3.57	9.36	3.51	9.51	3.44	9.77	3.32
	22	10.00	3.73	9.85	3.58	9.79	3.53	9.74	3.46	9.64	3.36
	24	9.30	3.77	9.66	3.63	9.81	3.57	9.60	3.52	9.26	3.44
1.6 + 1.6 + 5.0 + 7.1	16	11.95	3.60	11.05	3.48	10.69	3.44	10.27	3.32	9.58	3.12
	18	11.32	3.66	10.54	3.51	9.85	3.45	10.07	3.35	9.81	3.18
	20	10.67	3.67	10.14	3.53	9.93	3.47	9.89	3.40	9.84	3.27
	21	10.23	3.69	9.61	3.55	9.36	3.49	9.51	3.42	9.77	3.30
	22	10.00	3.71	9.85	3.56	9.79	3.51	9.74	3.44	9.64	3.34
	24	9.30	3.75	9.66	3.61	9.81	3.55	9.60	3.50	9.26	3.42

Combination (Capacity)	Indoor Air Temp. °C DB	Outdoor Air Temp. °C											
		16/15		15/14		10/9		7/6		6/5		2/1	
		Total Q	Input Power	Total Q	Input Power	Total Q	Input Power	Total Q	Input Power	Total Q	Input Power	Total Q	Input Power
1.6 + 1.6 + 6.0 + 6.0	16	20.00	2.78	19.59	2.85	17.53	3.20	16.30	3.41	15.50	3.46	12.31	3.66
	18	19.17	2.89	18.74	2.96	16.62	3.30	15.34	3.50	14.60	3.55	11.63	3.74
	20	18.88	2.97	18.39	3.04	15.89	3.37	14.40	3.57	13.70	3.61	10.88	3.75
	21	18.91	3.00	18.35	3.05	15.55	3.30	13.87	3.45	13.19	3.52	10.48	3.77
	22	19.07	3.03	18.55	3.09	15.92	3.43	14.35	3.64	13.49	3.67	10.06	3.78
	24	19.76	3.05	18.96	3.12	14.96	3.48	12.55	3.69	11.87	3.72	9.15	3.82
1.6 + 1.6 + 6.0 + 7.1	16	20.00	2.76	19.59	2.83	17.53	3.18	16.30	3.39	15.50	3.44	12.31	3.64
	18	19.17	2.88	18.74	2.94	16.62	3.28	15.34	3.48	14.60	3.53	11.63	3.71
	20	18.88	2.95	18.39	3.02	15.89	3.35	14.40	3.55	13.70	3.59	10.88	3.73
	21	18.91	2.99	18.35	3.04	15.55	3.28	13.87	3.43	13.19	3.50	10.48	3.75
	22	19.07	3.01	18.55	3.08	15.92	3.41	14.35	3.62	13.49	3.65	10.06	3.76
	24	19.76	3.04	18.96	3.11	14.96	3.46	12.55	3.67	11.87	3.70	9.15	3.80
1.6 + 1.6 + 7.1 + 7.1	16	20.00	2.80	19.59	2.87	17.53	3.23	16.30	3.44	15.50	3.49	12.31	3.69
	18	19.17	2.92	18.74	2.99	16.62	3.32	15.34	3.53	14.60	3.58	11.63	3.77
	20	18.88	3.00	18.39	3.06	15.89	3.40	14.40	3.60	13.70	3.64	10.88	3.78
	21	18.91	3.03	18.35	3.08	15.55	3.33	13.87	3.48	13.19	3.55	10.48	3.80
	22	19.07	3.05	18.55	3.12	15.92	3.46	14.35	3.67	13.49	3.70	10.06	3.82
	24	19.76	3.08	18.96	3.15	14.96	3.51	12.55	3.72	11.87	3.75	9.15	3.86
1.6 + 2.0 + 2.0 + 2.0	16	19.72	2.96	19.32	3.04	17.29	3.41	16.07	3.64	15.29	3.69	12.14	3.91
	18	18.90	3.09	18.48	3.16	16.39	3.52	15.13	3.73	14.40	3.78	11.47	3.99
	20	18.62	3.17	18.13	3.24	15.67	3.60	14.20	3.81	13.51	3.85	10.73	4.00
	21	18.65	3.21	18.09	3.26	15.33	3.53	13.67	3.69	13.01	3.75	10.34	4.02
	22	18.80	3.23	18.29	3.30	15.70	3.66	14.15	3.88	13.30	3.91	9.92	4.04
	24	19.49	3.26	18.70	3.33	14.75	3.71	12.38	3.94	11.71	3.97	9.03	4.08
1.6 + 2.0 + 2.0 + 2.5	16	19.72	2.96	19.32	3.04	17.29	3.41	16.07	3.64	15.29	3.69	12.14	3.91
	18	18.90	3.09	18.48	3.16	16.39	3.52	15.13	3.73	14.40	3.78	11.47	3.99
	20	18.62	3.17	18.13	3.24	15.67	3.60	14.20	3.81	13.51	3.85	10.73	4.00
	21	18.65	3.21	18.09	3.26	15.33	3.53	13.67	3.69	13.01	3.75	10.34	4.02
	22	18.80	3.23	18.29	3.30	15.70	3.66	14.15	3.88	13.30	3.91	9.92	4.04
	24	19.49	3.26	18.70	3.33	14.75	3.71	12.38	3.94	11.71	3.97	9.03	4.08
1.6 + 2.0 + 2.0 + 3.5	16	19.72	2.93	19.32	3.01	17.29	3.38	16.07	3.60	15.29	3.65	12.14	3.87
	18	18.90	3.06	18.48	3.13	16.39	3.48	15.13	3.69	14.40	3.74	11.47	3.94
	20	18.62	3.14	18.13	3.21	15.67	3.56	14.20	3.77	13.51	3.81	10.73	3.96
	21	18.65	3.17	18.09	3.22	15.33	3.49	13.67	3.65	13.01	3.71	10.34	3.98
	22	18.80	3.19	18.29	3.27	15.70	3.62	14.15	3.84	13.30	3.87	9.92	4.00
	24	19.49	3.22	18.70	3.30	14.75	3.67	12.38	3.90	11.71	3.93	9.03	4.04

Combination (Capacity)	Indoor Air Temp. °C DB	Outdoor Air Temp. °C									
		0/-1		-5/-6		-7/-8		-10/-11		-15/-	
		Total Q	Input Power	Total Q	Input Power	Total Q	Input Power	Total Q	Input Power	Total Q	Input Power
1.6 + 1.6 + 6.0 + 6.0	16	11.95	3.62	11.05	3.50	10.69	3.45	10.27	3.33	9.58	3.14
	18	11.32	3.68	10.54	3.53	9.85	3.47	10.07	3.37	9.81	3.20
	20	10.67	3.69	10.14	3.55	9.93	3.49	9.89	3.41	9.84	3.28
	21	10.23	3.71	9.61	3.57	9.36	3.51	9.51	3.44	9.77	3.32
	22	10.00	3.73	9.85	3.58	9.79	3.53	9.74	3.46	9.64	3.36
	24	9.30	3.77	9.66	3.63	9.81	3.57	9.60	3.52	9.26	3.44
1.6 + 1.6 + 6.0 + 7.1	16	11.95	3.60	11.05	3.48	10.69	3.44	10.27	3.32	9.58	3.12
	18	11.32	3.66	10.54	3.51	9.85	3.45	10.07	3.35	9.81	3.18
	20	10.67	3.67	10.14	3.53	9.93	3.47	9.89	3.40	9.84	3.27
	21	10.23	3.69	9.61	3.55	9.36	3.49	9.51	3.42	9.77	3.30
	22	10.00	3.71	9.85	3.56	9.79	3.51	9.74	3.44	9.64	3.34
	24	9.30	3.75	9.66	3.61	9.81	3.55	9.60	3.50	9.26	3.42
1.6 + 1.6 + 7.1 + 7.1	16	11.95	3.65	11.05	3.53	10.69	3.48	10.27	3.36	9.58	3.16
	18	11.32	3.71	10.54	3.56	9.85	3.50	10.07	3.40	9.81	3.22
	20	10.67	3.73	10.14	3.58	9.93	3.52	9.89	3.44	9.84	3.31
	21	10.23	3.74	9.61	3.60	9.36	3.54	9.51	3.47	9.77	3.35
	22	10.00	3.76	9.85	3.61	9.79	3.56	9.74	3.49	9.64	3.39
	24	9.30	3.80	9.66	3.66	9.81	3.60	9.60	3.55	9.26	3.47
1.6 + 2.0 + 2.0 + 2.0	16	11.79	3.86	10.90	3.74	10.54	3.69	10.13	3.56	9.45	3.35
	18	11.16	3.92	10.39	3.77	9.71	3.70	9.93	3.59	9.67	3.41
	20	10.52	3.94	10.00	3.79	9.79	3.73	9.75	3.64	9.70	3.50
	21	10.09	3.96	9.47	3.81	9.23	3.75	9.38	3.67	9.63	3.55
	22	9.86	3.98	9.71	3.82	9.66	3.76	9.60	3.70	9.51	3.59
	24	9.17	4.02	9.53	3.87	9.67	3.81	9.47	3.76	9.13	3.67
1.6 + 2.0 + 2.0 + 2.5	16	11.79	3.86	10.90	3.74	10.54	3.69	10.13	3.56	9.45	3.35
	18	11.16	3.92	10.39	3.77	9.71	3.70	9.93	3.59	9.67	3.41
	20	10.52	3.94	10.00	3.79	9.79	3.73	9.75	3.64	9.70	3.50
	21	10.09	3.96	9.47	3.81	9.23	3.75	9.38	3.67	9.63	3.55
	22	9.86	3.98	9.71	3.82	9.66	3.76	9.60	3.70	9.51	3.59
	24	9.17	4.02	9.53	3.87	9.67	3.81	9.47	3.76	9.13	3.67
1.6 + 2.0 + 2.0 + 3.5	16	11.79	3.82	10.90	3.70	10.54	3.65	10.13	3.52	9.45	3.31
	18	11.16	3.88	10.39	3.73	9.71	3.67	9.93	3.56	9.67	3.37
	20	10.52	3.90	10.00	3.75	9.79	3.69	9.75	3.61	9.70	3.47
	21	10.09	3.92	9.47	3.77	9.23	3.71	9.38	3.63	9.63	3.51
	22	9.86	3.94	9.71	3.78	9.66	3.72	9.60	3.66	9.51	3.55
	24	9.17	3.98	9.53	3.83	9.67	3.77	9.47	3.72	9.13	3.64

Combination (Capacity)	Indoor Air Temp. °C DB	Outdoor Air Temp. °C											
		16/15		15/14		10/9		7/6		6/5		2/1	
		Total Q	Input Power	Total Q	Input Power	Total Q	Input Power	Total Q	Input Power	Total Q	Input Power	Total Q	Input Power
1.6 + 2.0 + 2.0 + 4.2	16	19.72	2.93	19.32	3.00	17.29	3.37	16.07	3.59	15.29	3.65	12.14	3.86
	18	18.90	3.05	18.48	3.12	16.39	3.47	15.13	3.68	14.40	3.73	11.47	3.93
	20	18.62	3.13	18.13	3.20	15.67	3.55	14.20	3.76	13.51	3.80	10.73	3.95
	21	18.65	3.16	18.09	3.22	15.33	3.48	13.67	3.64	13.01	3.70	10.34	3.97
	22	18.80	3.19	18.29	3.26	15.70	3.62	14.15	3.83	13.30	3.86	9.92	3.99
	24	19.49	3.22	18.70	3.29	14.75	3.66	12.38	3.89	11.71	3.92	9.03	4.03
1.6 + 2.0 + 2.0 + 5.0	16	19.72	2.82	19.32	2.89	17.29	3.24	16.07	3.46	15.29	3.51	12.14	3.71
	18	18.90	2.93	18.48	3.00	16.39	3.34	15.13	3.55	14.40	3.60	11.47	3.79
	20	18.62	3.01	18.13	3.08	15.67	3.42	14.20	3.62	13.51	3.66	10.73	3.80
	21	18.65	3.05	18.09	3.10	15.33	3.35	13.67	3.50	13.01	3.57	10.34	3.82
	22	18.80	3.07	18.29	3.14	15.70	3.48	14.15	3.69	13.30	3.72	9.92	3.84
	24	19.49	3.10	18.70	3.17	14.75	3.53	12.38	3.74	11.71	3.77	9.03	3.88
1.6 + 2.0 + 2.0 + 6.0	16	19.72	2.82	19.32	2.89	17.29	3.24	16.07	3.46	15.29	3.51	12.14	3.71
	18	18.90	2.93	18.48	3.00	16.39	3.34	15.13	3.55	14.40	3.60	11.47	3.79
	20	18.62	3.01	18.13	3.08	15.67	3.42	14.20	3.62	13.51	3.66	10.73	3.80
	21	18.65	3.05	18.09	3.10	15.33	3.35	13.67	3.50	13.01	3.57	10.34	3.82
	22	18.80	3.07	18.29	3.14	15.70	3.48	14.15	3.69	13.30	3.72	9.92	3.84
	24	19.49	3.10	18.70	3.17	14.75	3.53	12.38	3.74	11.71	3.77	9.03	3.88
1.6 + 2.0 + 2.0 + 7.1	16	19.72	2.80	19.32	2.87	17.29	3.23	16.07	3.44	15.29	3.49	12.14	3.69
	18	18.90	2.92	18.48	2.99	16.39	3.32	15.13	3.53	14.40	3.58	11.47	3.77
	20	18.62	3.00	18.13	3.06	15.67	3.40	14.20	3.60	13.51	3.64	10.73	3.78
	21	18.65	3.03	18.09	3.08	15.33	3.33	13.67	3.48	13.01	3.55	10.34	3.80
	22	18.80	3.05	18.29	3.12	15.70	3.46	14.15	3.67	13.30	3.70	9.92	3.82
	24	19.49	3.08	18.70	3.15	14.75	3.51	12.38	3.72	11.71	3.75	9.03	3.86
1.6 + 2.0 + 2.5 + 2.5	16	19.72	2.96	19.32	3.04	17.29	3.41	16.07	3.64	15.29	3.69	12.14	3.91
	18	18.90	3.09	18.48	3.16	16.39	3.52	15.13	3.73	14.40	3.78	11.47	3.99
	20	18.62	3.17	18.13	3.24	15.67	3.60	14.20	3.81	13.51	3.85	10.73	4.00
	21	18.65	3.21	18.09	3.26	15.33	3.53	13.67	3.69	13.01	3.75	10.34	4.02
	22	18.80	3.23	18.29	3.30	15.70	3.66	14.15	3.88	13.30	3.91	9.92	4.04
	24	19.49	3.26	18.70	3.33	14.75	3.71	12.38	3.94	11.71	3.97	9.03	4.08
1.6 + 2.0 + 2.5 + 3.5	16	19.72	2.93	19.32	3.01	17.29	3.38	16.07	3.60	15.29	3.65	12.14	3.87
	18	18.90	3.06	18.48	3.13	16.39	3.48	15.13	3.69	14.40	3.74	11.47	3.94
	20	18.62	3.14	18.13	3.21	15.67	3.56	14.20	3.77	13.51	3.81	10.73	3.96
	21	18.65	3.17	18.09	3.22	15.33	3.49	13.67	3.65	13.01	3.71	10.34	3.98
	22	18.80	3.19	18.29	3.27	15.70	3.62	14.15	3.84	13.30	3.87	9.92	4.00
	24	19.49	3.22	18.70	3.30	14.75	3.67	12.38	3.90	11.71	3.93	9.03	4.04

Combination (Capacity)	Indoor Air Temp. °C DB	Outdoor Air Temp. °C									
		0/-1		-5/-6		-7/-8		-10/-11		-15/-	
		Total Q	Input Power	Total Q	Input Power	Total Q	Input Power	Total Q	Input Power	Total Q	Input Power
1.6 + 2.0 + 2.0 + 4.2	16	11.79	3.81	10.90	3.69	10.54	3.64	10.13	3.51	9.45	3.30
	18	11.16	3.87	10.39	3.72	9.71	3.66	9.93	3.55	9.67	3.37
	20	10.52	3.89	10.00	3.74	9.79	3.68	9.75	3.60	9.70	3.46
	21	10.09	3.91	9.47	3.76	9.23	3.70	9.38	3.62	9.63	3.50
	22	9.86	3.93	9.71	3.77	9.66	3.71	9.60	3.65	9.51	3.54
	24	9.17	3.97	9.53	3.82	9.67	3.76	9.47	3.71	9.13	3.63
1.6 + 2.0 + 2.0 + 5.0	16	11.79	3.67	10.90	3.55	10.54	3.50	10.13	3.38	9.45	3.18
	18	11.16	3.73	10.39	3.58	9.71	3.52	9.93	3.42	9.67	3.24
	20	10.52	3.75	10.00	3.60	9.79	3.54	9.75	3.46	9.70	3.33
	21	10.09	3.76	9.47	3.62	9.23	3.56	9.38	3.49	9.63	3.37
	22	9.86	3.78	9.71	3.63	9.66	3.58	9.60	3.51	9.51	3.41
	24	9.17	3.82	9.53	3.68	9.67	3.62	9.47	3.57	9.13	3.49
1.6 + 2.0 + 2.0 + 6.0	16	11.79	3.67	10.90	3.55	10.54	3.50	10.13	3.38	9.45	3.18
	18	11.16	3.73	10.39	3.58	9.71	3.52	9.93	3.42	9.67	3.24
	20	10.52	3.75	10.00	3.60	9.79	3.54	9.75	3.46	9.70	3.33
	21	10.09	3.76	9.47	3.62	9.23	3.56	9.38	3.49	9.63	3.37
	22	9.86	3.78	9.71	3.63	9.66	3.58	9.60	3.51	9.51	3.41
	24	9.17	3.82	9.53	3.68	9.67	3.62	9.47	3.57	9.13	3.49
1.6 + 2.0 + 2.0 + 7.1	16	11.79	3.65	10.90	3.53	10.54	3.48	10.13	3.36	9.45	3.16
	18	11.16	3.71	10.39	3.56	9.71	3.50	9.93	3.40	9.67	3.22
	20	10.52	3.73	10.00	3.58	9.79	3.52	9.75	3.44	9.70	3.31
	21	10.09	3.74	9.47	3.60	9.23	3.54	9.38	3.47	9.63	3.35
	22	9.86	3.76	9.71	3.61	9.66	3.56	9.60	3.49	9.51	3.39
	24	9.17	3.80	9.53	3.66	9.67	3.60	9.47	3.55	9.13	3.47
1.6 + 2.0 + 2.5 + 2.5	16	11.79	3.86	10.90	3.74	10.54	3.69	10.13	3.56	9.45	3.35
	18	11.16	3.92	10.39	3.77	9.71	3.70	9.93	3.59	9.67	3.41
	20	10.52	3.94	10.00	3.79	9.79	3.73	9.75	3.64	9.70	3.50
	21	10.09	3.96	9.47	3.81	9.23	3.75	9.38	3.67	9.63	3.55
	22	9.86	3.98	9.71	3.82	9.66	3.76	9.60	3.70	9.51	3.59
	24	9.17	4.02	9.53	3.87	9.67	3.81	9.47	3.76	9.13	3.67
1.6 + 2.0 + 2.5 + 3.5	16	11.79	3.82	10.90	3.70	10.54	3.65	10.13	3.52	9.45	3.31
	18	11.16	3.88	10.39	3.73	9.71	3.67	9.93	3.56	9.67	3.37
	20	10.52	3.90	10.00	3.75	9.79	3.69	9.75	3.61	9.70	3.47
	21	10.09	3.92	9.47	3.77	9.23	3.71	9.38	3.63	9.63	3.51
	22	9.86	3.94	9.71	3.78	9.66	3.72	9.60	3.66	9.51	3.55
	24	9.17	3.98	9.53	3.83	9.67	3.77	9.47	3.72	9.13	3.64

Combination (Capacity)	Indoor Air Temp. °C DB	Outdoor Air Temp. °C											
		16/15		15/14		10/9		7/6		6/5		2/1	
		Total Q	Input Power	Total Q	Input Power	Total Q	Input Power	Total Q	Input Power	Total Q	Input Power	Total Q	Input Power
1.6 + 2.0 + 2.5 + 4.2	16	19.72	2.93	19.32	3.00	17.29	3.37	16.07	3.59	15.29	3.65	12.14	3.86
	18	18.90	3.05	18.48	3.12	16.39	3.47	15.13	3.68	14.40	3.73	11.47	3.93
	20	18.62	3.13	18.13	3.20	15.67	3.55	14.20	3.76	13.51	3.80	10.73	3.95
	21	18.65	3.16	18.09	3.22	15.33	3.48	13.67	3.64	13.01	3.70	10.34	3.97
	22	18.80	3.19	18.29	3.26	15.70	3.62	14.15	3.83	13.30	3.86	9.92	3.99
	24	19.49	3.22	18.70	3.29	14.75	3.66	12.38	3.89	11.71	3.92	9.03	4.03
1.6 + 2.0 + 2.5 + 5.0	16	19.72	2.82	19.32	2.89	17.29	3.24	16.07	3.46	15.29	3.51	12.14	3.71
	18	18.90	2.93	18.48	3.00	16.39	3.34	15.13	3.55	14.40	3.60	11.47	3.79
	20	18.62	3.01	18.13	3.08	15.67	3.42	14.20	3.62	13.51	3.66	10.73	3.80
	21	18.65	3.05	18.09	3.10	15.33	3.35	13.67	3.50	13.01	3.57	10.34	3.82
	22	18.80	3.07	18.29	3.14	15.70	3.48	14.15	3.69	13.30	3.72	9.92	3.84
	24	19.49	3.10	18.70	3.17	14.75	3.53	12.38	3.74	11.71	3.77	9.03	3.88
1.6 + 2.0 + 2.5 + 6.0	16	19.72	2.82	19.32	2.89	17.29	3.24	16.07	3.46	15.29	3.51	12.14	3.71
	18	18.90	2.93	18.48	3.00	16.39	3.34	15.13	3.55	14.40	3.60	11.47	3.79
	20	18.62	3.01	18.13	3.08	15.67	3.42	14.20	3.62	13.51	3.66	10.73	3.80
	21	18.65	3.05	18.09	3.10	15.33	3.35	13.67	3.50	13.01	3.57	10.34	3.82
	22	18.80	3.07	18.29	3.14	15.70	3.48	14.15	3.69	13.30	3.72	9.92	3.84
	24	19.49	3.10	18.70	3.17	14.75	3.53	12.38	3.74	11.71	3.77	9.03	3.88
1.6 + 2.0 + 2.5 + 7.1	16	20.00	2.85	19.59	2.92	17.53	3.28	16.30	3.50	15.50	3.55	12.31	3.76
	18	19.17	2.97	18.74	3.04	16.62	3.38	15.34	3.59	14.60	3.64	11.63	3.83
	20	18.88	3.05	18.39	3.11	15.89	3.46	14.40	3.66	13.70	3.70	10.88	3.85
	21	18.91	3.08	18.35	3.13	15.55	3.39	13.87	3.54	13.19	3.60	10.48	3.86
	22	19.07	3.10	18.55	3.17	15.92	3.52	14.35	3.73	13.49	3.76	10.06	3.88
	24	19.76	3.13	18.96	3.20	14.96	3.57	12.55	3.78	11.87	3.81	9.15	3.92
1.6 + 2.0 + 3.5 + 3.5	16	19.72	2.86	19.32	2.94	17.29	3.30	16.07	3.52	15.29	3.57	12.14	3.78
	18	18.90	2.98	18.48	3.05	16.39	3.40	15.13	3.61	14.40	3.66	11.47	3.85
	20	18.62	3.06	18.13	3.13	15.67	3.47	14.20	3.68	13.51	3.72	10.73	3.87
	21	18.65	3.10	18.09	3.15	15.33	3.40	13.67	3.56	13.01	3.62	10.34	3.88
	22	18.80	3.12	18.29	3.19	15.70	3.54	14.15	3.75	13.30	3.78	9.92	3.90
	24	19.49	3.15	18.70	3.22	14.75	3.59	12.38	3.80	11.71	3.83	9.03	3.94
1.6 + 2.0 + 3.5 + 4.2	16	19.72	2.85	19.32	2.92	17.29	3.28	16.07	3.50	15.29	3.55	12.14	3.76
	18	18.90	2.97	18.48	3.04	16.39	3.38	15.13	3.59	14.40	3.64	11.47	3.83
	20	18.62	3.05	18.13	3.11	15.67	3.46	14.20	3.66	13.51	3.70	10.73	3.85
	21	18.65	3.08	18.09	3.13	15.33	3.39	13.67	3.54	13.01	3.60	10.34	3.86
	22	18.80	3.10	18.29	3.17	15.70	3.52	14.15	3.73	13.30	3.76	9.92	3.88
	24	19.49	3.13	18.70	3.20	14.75	3.57	12.38	3.78	11.71	3.81	9.03	3.92

Combination (Capacity)	Indoor Air Temp. °C DB	Outdoor Air Temp. °C									
		0/-1		-5/-6		-7/-8		-10/-11		-15/-	
		Total Q	Input Power	Total Q	Input Power	Total Q	Input Power	Total Q	Input Power	Total Q	Input Power
1.6 + 2.0 + 2.5 + 4.2	16	11.79	3.81	10.90	3.69	10.54	3.64	10.13	3.51	9.45	3.30
	18	11.16	3.87	10.39	3.72	9.71	3.66	9.93	3.55	9.67	3.37
	20	10.52	3.89	10.00	3.74	9.79	3.68	9.75	3.60	9.70	3.46
	21	10.09	3.91	9.47	3.76	9.23	3.70	9.38	3.62	9.63	3.50
	22	9.86	3.93	9.71	3.77	9.66	3.71	9.60	3.65	9.51	3.54
	24	9.17	3.97	9.53	3.82	9.67	3.76	9.47	3.71	9.13	3.63
1.6 + 2.0 + 2.5 + 5.0	16	11.79	3.67	10.90	3.55	10.54	3.50	10.13	3.38	9.45	3.18
	18	11.16	3.73	10.39	3.58	9.71	3.52	9.93	3.42	9.67	3.24
	20	10.52	3.75	10.00	3.60	9.79	3.54	9.75	3.46	9.70	3.33
	21	10.09	3.76	9.47	3.62	9.23	3.56	9.38	3.49	9.63	3.37
	22	9.86	3.78	9.71	3.63	9.66	3.58	9.60	3.51	9.51	3.41
	24	9.17	3.82	9.53	3.68	9.67	3.62	9.47	3.57	9.13	3.49
1.6 + 2.0 + 2.5 + 6.0	16	11.79	3.67	10.90	3.55	10.54	3.50	10.13	3.38	9.45	3.18
	18	11.16	3.73	10.39	3.58	9.71	3.52	9.93	3.42	9.67	3.24
	20	10.52	3.75	10.00	3.60	9.79	3.54	9.75	3.46	9.70	3.33
	21	10.09	3.76	9.47	3.62	9.23	3.56	9.38	3.49	9.63	3.37
	22	9.86	3.78	9.71	3.63	9.66	3.58	9.60	3.51	9.51	3.41
	24	9.17	3.82	9.53	3.68	9.67	3.62	9.47	3.57	9.13	3.49
1.6 + 2.0 + 2.5 + 7.1	16	11.95	3.71	11.05	3.59	10.69	3.54	10.27	3.42	9.58	3.21
	18	11.32	3.77	10.54	3.62	9.85	3.56	10.07	3.45	9.81	3.28
	20	10.67	3.79	10.14	3.64	9.93	3.58	9.89	3.50	9.84	3.37
	21	10.23	3.80	9.61	3.66	9.36	3.60	9.51	3.53	9.77	3.41
	22	10.00	3.82	9.85	3.67	9.79	3.61	9.74	3.55	9.64	3.45
	24	9.30	3.86	9.66	3.72	9.81	3.66	9.60	3.61	9.26	3.53
1.6 + 2.0 + 3.5 + 3.5	16	11.79	3.73	10.90	3.61	10.54	3.56	10.13	3.44	9.45	3.23
	18	11.16	3.79	10.39	3.64	9.71	3.58	9.93	3.47	9.67	3.29
	20	10.52	3.81	10.00	3.66	9.79	3.60	9.75	3.52	9.70	3.39
	21	10.09	3.82	9.47	3.68	9.23	3.62	9.38	3.55	9.63	3.42
	22	9.86	3.84	9.71	3.69	9.66	3.63	9.60	3.57	9.51	3.46
	24	9.17	3.88	9.53	3.74	9.67	3.68	9.47	3.63	9.13	3.55
1.6 + 2.0 + 3.5 + 4.2	16	11.79	3.71	10.90	3.59	10.54	3.54	10.13	3.42	9.45	3.21
	18	11.16	3.77	10.39	3.62	9.71	3.56	9.93	3.45	9.67	3.28
	20	10.52	3.79	10.00	3.64	9.79	3.58	9.75	3.50	9.70	3.37
	21	10.09	3.80	9.47	3.66	9.23	3.60	9.38	3.53	9.63	3.41
	22	9.86	3.82	9.71	3.67	9.66	3.61	9.60	3.55	9.51	3.45
	24	9.17	3.86	9.53	3.72	9.67	3.66	9.47	3.61	9.13	3.53

Combination (Capacity)	Indoor Air Temp. °C DB	Outdoor Air Temp. °C											
		16/15		15/14		10/9		7/6		6/5		2/1	
		Total Q	Input Power	Total Q	Input Power	Total Q	Input Power	Total Q	Input Power	Total Q	Input Power	Total Q	Input Power
1.6 + 2.0 + 3.5 + 5.0	16	19.72	2.79	19.32	2.86	17.29	3.21	16.07	3.42	15.29	3.47	12.14	3.67
	18	18.90	2.90	18.48	2.97	16.39	3.31	15.13	3.51	14.40	3.56	11.47	3.75
	20	18.62	2.98	18.13	3.05	15.67	3.38	14.20	3.58	13.51	3.62	10.73	3.76
	21	18.65	3.01	18.09	3.06	15.33	3.31	13.67	3.46	13.01	3.53	10.34	3.78
	22	18.80	3.03	18.29	3.10	15.70	3.44	14.15	3.65	13.30	3.68	9.92	3.80
	24	19.49	3.06	18.70	3.13	14.75	3.49	12.38	3.70	11.71	3.73	9.03	3.83
1.6 + 2.0 + 3.5 + 6.0	16	20.00	2.83	19.59	2.90	17.53	3.26	16.30	3.48	15.50	3.53	12.31	3.74
	18	19.17	2.95	18.74	3.02	16.62	3.36	15.34	3.57	14.60	3.62	11.63	3.81
	20	18.88	3.03	18.39	3.10	15.89	3.44	14.40	3.64	13.70	3.68	10.88	3.83
	21	18.91	3.06	18.35	3.11	15.55	3.37	13.87	3.52	13.19	3.58	10.48	3.84
	22	19.07	3.08	18.55	3.15	15.92	3.50	14.35	3.71	13.49	3.74	10.06	3.86
	24	19.76	3.11	18.96	3.19	14.96	3.55	12.55	3.76	11.87	3.79	9.15	3.90
1.6 + 2.0 + 3.5 + 7.1	16	20.00	2.82	19.59	2.89	17.53	3.24	16.30	3.46	15.50	3.51	12.31	3.71
	18	19.17	2.93	18.74	3.00	16.62	3.34	15.34	3.55	14.60	3.60	11.63	3.79
	20	18.88	3.01	18.39	3.08	15.89	3.42	14.40	3.62	13.70	3.66	10.88	3.80
	21	18.91	3.05	18.35	3.10	15.55	3.35	13.87	3.50	13.19	3.57	10.48	3.82
	22	19.07	3.07	18.55	3.14	15.92	3.48	14.35	3.69	13.49	3.72	10.06	3.84
	24	19.76	3.10	18.96	3.17	14.96	3.53	12.55	3.74	11.87	3.77	9.15	3.88
1.6 + 2.0 + 4.2 + 4.2	16	19.72	2.84	19.32	2.91	17.29	3.27	16.07	3.49	15.29	3.54	12.14	3.75
	18	18.90	2.96	18.48	3.03	16.39	3.37	15.13	3.58	14.40	3.63	11.47	3.82
	20	18.62	3.04	18.13	3.11	15.67	3.45	14.20	3.65	13.51	3.69	10.73	3.84
	21	18.65	3.07	18.09	3.12	15.33	3.38	13.67	3.53	13.01	3.59	10.34	3.85
	22	18.80	3.09	18.29	3.16	15.70	3.51	14.15	3.72	13.30	3.75	9.92	3.87
	24	19.49	3.12	18.70	3.19	14.75	3.56	12.38	3.77	11.71	3.80	9.03	3.91
1.6 + 2.0 + 4.2 + 5.0	16	20.00	2.82	19.59	2.90	17.53	3.25	16.30	3.47	15.50	3.52	12.31	3.73
	18	19.17	2.94	18.74	3.01	16.62	3.35	15.34	3.56	14.60	3.61	11.63	3.80
	20	18.88	3.02	18.39	3.09	15.89	3.43	14.40	3.63	13.70	3.67	10.88	3.81
	21	18.91	3.05	18.35	3.10	15.55	3.36	13.87	3.51	13.19	3.58	10.48	3.83
	22	19.07	3.08	18.55	3.15	15.92	3.49	14.35	3.70	13.49	3.73	10.06	3.85
	24	19.76	3.10	18.96	3.18	14.96	3.54	12.55	3.75	11.87	3.78	9.15	3.89
1.6 + 2.0 + 4.2 + 6.0	16	20.00	2.82	19.59	2.90	17.53	3.25	16.30	3.47	15.50	3.52	12.31	3.73
	18	19.17	2.94	18.74	3.01	16.62	3.35	15.34	3.56	14.60	3.61	11.63	3.80
	20	18.88	3.02	18.39	3.09	15.89	3.43	14.40	3.63	13.70	3.67	10.88	3.81
	21	18.91	3.05	18.35	3.10	15.55	3.36	13.87	3.51	13.19	3.58	10.48	3.83
	22	19.07	3.08	18.55	3.15	15.92	3.49	14.35	3.70	13.49	3.73	10.06	3.85
	24	19.76	3.10	18.96	3.18	14.96	3.54	12.55	3.75	11.87	3.78	9.15	3.89



Combination (Capacity)	Indoor Air Temp. °C DB	Outdoor Air Temp. °C									
		0/-1		-5/-6		-7/-8		-10/-11		-15/-	
		Total Q	Input Power	Total Q	Input Power	Total Q	Input Power	Total Q	Input Power	Total Q	Input Power
1.6 + 2.0 + 3.5 + 5.0	16	11.79	3.63	10.90	3.51	10.54	3.46	10.13	3.34	9.45	3.14
	18	11.16	3.69	10.39	3.54	9.71	3.48	9.93	3.38	9.67	3.20
	20	10.52	3.70	10.00	3.56	9.79	3.50	9.75	3.42	9.70	3.29
	21	10.09	3.72	9.47	3.58	9.23	3.52	9.38	3.45	9.63	3.33
	22	9.86	3.74	9.71	3.59	9.66	3.54	9.60	3.47	9.51	3.37
	24	9.17	3.78	9.53	3.64	9.67	3.58	9.47	3.53	9.13	3.45
1.6 + 2.0 + 3.5 + 6.0	16	11.95	3.69	11.05	3.57	10.69	3.52	10.27	3.40	9.58	3.20
	18	11.32	3.75	10.54	3.60	9.85	3.54	10.07	3.43	9.81	3.26
	20	10.67	3.77	10.14	3.62	9.93	3.56	9.89	3.48	9.84	3.35
	21	10.23	3.78	9.61	3.64	9.36	3.58	9.51	3.51	9.77	3.39
	22	10.00	3.80	9.85	3.65	9.79	3.60	9.74	3.53	9.64	3.43
	24	9.30	3.84	9.66	3.70	9.81	3.64	9.60	3.59	9.26	3.51
1.6 + 2.0 + 3.5 + 7.1	16	11.95	3.67	11.05	3.55	10.69	3.50	10.27	3.38	9.58	3.18
	18	11.32	3.73	10.54	3.58	9.85	3.52	10.07	3.42	9.81	3.24
	20	10.67	3.75	10.14	3.60	9.93	3.54	9.89	3.46	9.84	3.33
	21	10.23	3.76	9.61	3.62	9.36	3.56	9.51	3.49	9.77	3.37
	22	10.00	3.78	9.85	3.63	9.79	3.58	9.74	3.51	9.64	3.41
	24	9.30	3.82	9.66	3.68	9.81	3.62	9.60	3.57	9.26	3.49
1.6 + 2.0 + 4.2 + 4.2	16	11.79	3.70	10.90	3.58	10.54	3.53	10.13	3.41	9.45	3.21
	18	11.16	3.76	10.39	3.61	9.71	3.55	9.93	3.44	9.67	3.27
	20	10.52	3.78	10.00	3.63	9.79	3.57	9.75	3.49	9.70	3.36
	21	10.09	3.79	9.47	3.65	9.23	3.59	9.38	3.52	9.63	3.40
	22	9.86	3.81	9.71	3.66	9.66	3.61	9.60	3.54	9.51	3.44
	24	9.17	3.85	9.53	3.71	9.67	3.65	9.47	3.60	9.13	3.52
1.6 + 2.0 + 4.2 + 5.0	16	11.95	3.68	11.05	3.56	10.69	3.51	10.27	3.39	9.58	3.19
	18	11.32	3.74	10.54	3.59	9.85	3.53	10.07	3.42	9.81	3.25
	20	10.67	3.76	10.14	3.61	9.93	3.55	9.89	3.47	9.84	3.34
	21	10.23	3.77	9.61	3.63	9.36	3.57	9.51	3.50	9.77	3.38
	22	10.00	3.79	9.85	3.64	9.79	3.59	9.74	3.52	9.64	3.42
	24	9.30	3.83	9.66	3.69	9.81	3.63	9.60	3.58	9.26	3.50
1.6 + 2.0 + 4.2 + 6.0	16	11.95	3.68	11.05	3.56	10.69	3.51	10.27	3.39	9.58	3.19
	18	11.32	3.74	10.54	3.59	9.85	3.53	10.07	3.42	9.81	3.25
	20	10.67	3.76	10.14	3.61	9.93	3.55	9.89	3.47	9.84	3.34
	21	10.23	3.77	9.61	3.63	9.36	3.57	9.51	3.50	9.77	3.38
	22	10.00	3.79	9.85	3.64	9.79	3.59	9.74	3.52	9.64	3.42
	24	9.30	3.83	9.66	3.69	9.81	3.63	9.60	3.58	9.26	3.50

Combination (Capacity)	Indoor Air Temp. °C DB	Outdoor Air Temp. °C											
		16/15		15/14		10/9		7/6		6/5		2/1	
		Total Q	Input Power	Total Q	Input Power	Total Q	Input Power	Total Q	Input Power	Total Q	Input Power	Total Q	Input Power
1.6 + 2.0 + 4.2 + 7.1	16	20.00	2.81	19.59	2.88	17.53	3.24	16.30	3.45	15.50	3.50	12.31	3.70
	18	19.17	2.93	18.74	2.99	16.62	3.33	15.34	3.54	14.60	3.59	11.63	3.78
	20	18.88	3.00	18.39	3.07	15.89	3.41	14.40	3.61	13.70	3.65	10.88	3.79
	21	18.91	3.04	18.35	3.09	15.55	3.34	13.87	3.49	13.19	3.56	10.48	3.81
	22	19.07	3.06	18.55	3.13	15.92	3.47	14.35	3.68	13.49	3.71	10.06	3.83
	24	19.76	3.09	18.96	3.16	14.96	3.52	12.55	3.73	11.87	3.76	9.15	3.87
1.6 + 2.0 + 5.0 + 5.0	16	20.00	2.77	19.59	2.84	17.53	3.19	16.30	3.40	15.50	3.45	12.31	3.65
	18	19.17	2.89	18.74	2.95	16.62	3.29	15.34	3.49	14.60	3.54	11.63	3.72
	20	18.88	2.96	18.39	3.03	15.89	3.36	14.40	3.56	13.70	3.60	10.88	3.74
	21	18.91	3.00	18.35	3.04	15.55	3.29	13.87	3.44	13.19	3.51	10.48	3.76
	22	19.07	3.02	18.55	3.08	15.92	3.42	14.35	3.63	13.49	3.66	10.06	3.77
	24	19.76	3.04	18.96	3.12	14.96	3.47	12.55	3.68	11.87	3.71	9.15	3.81
1.6 + 2.0 + 5.0 + 6.0	16	20.00	2.77	19.59	2.84	17.53	3.19	16.30	3.40	15.50	3.45	12.31	3.65
	18	19.17	2.89	18.74	2.95	16.62	3.29	15.34	3.49	14.60	3.54	11.63	3.72
	20	18.88	2.96	18.39	3.03	15.89	3.36	14.40	3.56	13.70	3.60	10.88	3.74
	21	18.91	3.00	18.35	3.04	15.55	3.29	13.87	3.44	13.19	3.51	10.48	3.76
	22	19.07	3.02	18.55	3.08	15.92	3.42	14.35	3.63	13.49	3.66	10.06	3.77
	24	19.76	3.04	18.96	3.12	14.96	3.47	12.55	3.68	11.87	3.71	9.15	3.81
1.6 + 2.0 + 5.0 + 7.1	16	20.00	2.80	19.59	2.87	17.53	3.23	16.30	3.44	15.50	3.49	12.31	3.69
	18	19.17	2.92	18.74	2.99	16.62	3.32	15.34	3.53	14.60	3.58	11.63	3.77
	20	18.88	3.00	18.39	3.06	15.89	3.40	14.40	3.60	13.70	3.64	10.88	3.78
	21	18.91	3.03	18.35	3.08	15.55	3.33	13.87	3.48	13.19	3.55	10.48	3.80
	22	19.07	3.05	18.55	3.12	15.92	3.46	14.35	3.67	13.49	3.70	10.06	3.82
	24	19.76	3.08	18.96	3.15	14.96	3.51	12.55	3.72	11.87	3.75	9.15	3.86
1.6 + 2.0 + 6.0 + 6.0	16	20.00	2.77	19.59	2.84	17.53	3.19	16.30	3.40	15.50	3.45	12.31	3.65
	18	19.17	2.89	18.74	2.95	16.62	3.29	15.34	3.49	14.60	3.54	11.63	3.72
	20	18.88	2.96	18.39	3.03	15.89	3.36	14.40	3.56	13.70	3.60	10.88	3.74
	21	18.91	3.00	18.35	3.04	15.55	3.29	13.87	3.44	13.19	3.51	10.48	3.76
	22	19.07	3.02	18.55	3.08	15.92	3.42	14.35	3.63	13.49	3.66	10.06	3.77
	24	19.76	3.04	18.96	3.12	14.96	3.47	12.55	3.68	11.87	3.71	9.15	3.81
1.6 + 2.0 + 6.0 + 7.1	16	20.00	2.80	19.59	2.87	17.53	3.23	16.30	3.44	15.50	3.49	12.31	3.69
	18	19.17	2.92	18.74	2.99	16.62	3.32	15.34	3.53	14.60	3.58	11.63	3.77
	20	18.88	3.00	18.39	3.06	15.89	3.40	14.40	3.60	13.70	3.64	10.88	3.78
	21	18.91	3.03	18.35	3.08	15.55	3.33	13.87	3.48	13.19	3.55	10.48	3.80
	22	19.07	3.05	18.55	3.12	15.92	3.46	14.35	3.67	13.49	3.70	10.06	3.82
	24	19.76	3.08	18.96	3.15	14.96	3.51	12.55	3.72	11.87	3.75	9.15	3.86

Combination (Capacity)	Indoor Air Temp. °C DB	Outdoor Air Temp. °C									
		0/-1		-5/-6		-7/-8		-10/-11		-15/-	
		Total Q	Input Power	Total Q	Input Power	Total Q	Input Power	Total Q	Input Power	Total Q	Input Power
1.6 + 2.0 + 4.2 + 7.1	16	11.95	3.66	11.05	3.54	10.69	3.49	10.27	3.37	9.58	3.17
	18	11.32	3.72	10.54	3.57	9.85	3.51	10.07	3.41	9.81	3.23
	20	10.67	3.74	10.14	3.59	9.93	3.53	9.89	3.45	9.84	3.32
	21	10.23	3.75	9.61	3.61	9.36	3.55	9.51	3.48	9.77	3.36
	22	10.00	3.77	9.85	3.62	9.79	3.57	9.74	3.50	9.64	3.40
	24	9.30	3.81	9.66	3.67	9.81	3.61	9.60	3.56	9.26	3.48
1.6 + 2.0 + 5.0 + 5.0	16	11.95	3.61	11.05	3.49	10.69	3.44	10.27	3.33	9.58	3.13
	18	11.32	3.67	10.54	3.52	9.85	3.46	10.07	3.36	9.81	3.19
	20	10.67	3.68	10.14	3.54	9.93	3.48	9.89	3.41	9.84	3.27
	21	10.23	3.70	9.61	3.56	9.36	3.50	9.51	3.43	9.77	3.31
	22	10.00	3.72	9.85	3.57	9.79	3.52	9.74	3.45	9.64	3.35
	24	9.30	3.76	9.66	3.62	9.81	3.56	9.60	3.51	9.26	3.43
1.6 + 2.0 + 5.0 + 6.0	16	11.95	3.61	11.05	3.49	10.69	3.44	10.27	3.33	9.58	3.13
	18	11.32	3.67	10.54	3.52	9.85	3.46	10.07	3.36	9.81	3.19
	20	10.67	3.68	10.14	3.54	9.93	3.48	9.89	3.41	9.84	3.27
	21	10.23	3.70	9.61	3.56	9.36	3.50	9.51	3.43	9.77	3.31
	22	10.00	3.72	9.85	3.57	9.79	3.52	9.74	3.45	9.64	3.35
	24	9.30	3.76	9.66	3.62	9.81	3.56	9.60	3.51	9.26	3.43
1.6 + 2.0 + 5.0 + 7.1	16	11.95	3.65	11.05	3.53	10.69	3.48	10.27	3.36	9.58	3.16
	18	11.32	3.71	10.54	3.56	9.85	3.50	10.07	3.40	9.81	3.22
	20	10.67	3.73	10.14	3.58	9.93	3.52	9.89	3.44	9.84	3.31
	21	10.23	3.74	9.61	3.60	9.36	3.54	9.51	3.47	9.77	3.35
	22	10.00	3.76	9.85	3.61	9.79	3.56	9.74	3.49	9.64	3.39
	24	9.30	3.80	9.66	3.66	9.81	3.60	9.60	3.55	9.26	3.47
1.6 + 2.0 + 6.0 + 6.0	16	11.95	3.61	11.05	3.49	10.69	3.44	10.27	3.33	9.58	3.13
	18	11.32	3.67	10.54	3.52	9.85	3.46	10.07	3.36	9.81	3.19
	20	10.67	3.68	10.14	3.54	9.93	3.48	9.89	3.41	9.84	3.27
	21	10.23	3.70	9.61	3.56	9.36	3.50	9.51	3.43	9.77	3.31
	22	10.00	3.72	9.85	3.57	9.79	3.52	9.74	3.45	9.64	3.35
	24	9.30	3.76	9.66	3.62	9.81	3.56	9.60	3.51	9.26	3.43
1.6 + 2.0 + 6.0 + 7.1	16	11.95	3.65	11.05	3.53	10.69	3.48	10.27	3.36	9.58	3.16
	18	11.32	3.71	10.54	3.56	9.85	3.50	10.07	3.40	9.81	3.22
	20	10.67	3.73	10.14	3.58	9.93	3.52	9.89	3.44	9.84	3.31
	21	10.23	3.74	9.61	3.60	9.36	3.54	9.51	3.47	9.77	3.35
	22	10.00	3.76	9.85	3.61	9.79	3.56	9.74	3.49	9.64	3.39
	24	9.30	3.80	9.66	3.66	9.81	3.60	9.60	3.55	9.26	3.47

Combination (Capacity)	Indoor Air Temp. °C DB	Outdoor Air Temp. °C											
		16/15		15/14		10/9		7/6		6/5		2/1	
		Total Q	Input Power	Total Q	Input Power	Total Q	Input Power	Total Q	Input Power	Total Q	Input Power	Total Q	Input Power
1.6 + 2.0 + 7.1 + 7.1	16	20.00	2.79	19.59	2.86	17.53	3.22	16.30	3.43	15.50	3.48	12.31	3.68
	18	19.17	2.91	18.74	2.98	16.62	3.32	15.34	3.52	14.60	3.57	11.63	3.76
	20	18.88	2.99	18.39	3.05	15.89	3.39	14.40	3.59	13.70	3.63	10.88	3.77
	21	18.91	3.02	18.35	3.07	15.55	3.32	13.87	3.47	13.19	3.54	10.48	3.79
	22	19.07	3.04	18.55	3.11	15.92	3.45	14.35	3.66	13.49	3.69	10.06	3.81
	24	19.76	3.07	18.96	3.14	14.96	3.50	12.55	3.71	11.87	3.74	9.15	3.84
1.6 + 2.5 + 2.5 + 2.5	16	19.72	2.96	19.32	3.04	17.29	3.41	16.07	3.64	15.29	3.69	12.14	3.91
	18	18.90	3.09	18.48	3.16	16.39	3.52	15.13	3.73	14.40	3.78	11.47	3.99
	20	18.62	3.17	18.13	3.24	15.67	3.60	14.20	3.81	13.51	3.85	10.73	4.00
	21	18.65	3.21	18.09	3.26	15.33	3.53	13.67	3.69	13.01	3.75	10.34	4.02
	22	18.80	3.23	18.29	3.30	15.70	3.66	14.15	3.88	13.30	3.91	9.92	4.04
	24	19.49	3.26	18.70	3.33	14.75	3.71	12.38	3.94	11.71	3.97	9.03	4.08
1.6 + 2.5 + 2.5 + 3.5	16	19.72	2.93	19.32	3.01	17.29	3.38	16.07	3.60	15.29	3.65	12.14	3.87
	18	18.90	3.06	18.48	3.13	16.39	3.48	15.13	3.69	14.40	3.74	11.47	3.94
	20	18.62	3.14	18.13	3.21	15.67	3.56	14.20	3.77	13.51	3.81	10.73	3.96
	21	18.65	3.17	18.09	3.22	15.33	3.49	13.67	3.65	13.01	3.71	10.34	3.98
	22	18.80	3.19	18.29	3.27	15.70	3.62	14.15	3.84	13.30	3.87	9.92	4.00
	24	19.49	3.22	18.70	3.30	14.75	3.67	12.38	3.90	11.71	3.93	9.03	4.04
1.6 + 2.5 + 2.5 + 4.2	16	19.72	2.93	19.32	3.00	17.29	3.37	16.07	3.59	15.29	3.65	12.14	3.86
	18	18.90	3.05	18.48	3.12	16.39	3.47	15.13	3.68	14.40	3.73	11.47	3.93
	20	18.62	3.13	18.13	3.20	15.67	3.55	14.20	3.76	13.51	3.80	10.73	3.95
	21	18.65	3.16	18.09	3.22	15.33	3.48	13.67	3.64	13.01	3.70	10.34	3.97
	22	18.80	3.19	18.29	3.26	15.70	3.62	14.15	3.83	13.30	3.86	9.92	3.99
	24	19.49	3.22	18.70	3.29	14.75	3.66	12.38	3.89	11.71	3.92	9.03	4.03
1.6 + 2.5 + 2.5 + 5.0	16	19.72	2.82	19.32	2.89	17.29	3.24	16.07	3.46	15.29	3.51	12.14	3.71
	18	18.90	2.93	18.48	3.00	16.39	3.34	15.13	3.55	14.40	3.60	11.47	3.79
	20	18.62	3.01	18.13	3.08	15.67	3.42	14.20	3.62	13.51	3.66	10.73	3.80
	21	18.65	3.05	18.09	3.10	15.33	3.35	13.67	3.50	13.01	3.57	10.34	3.82
	22	18.80	3.07	18.29	3.14	15.70	3.48	14.15	3.69	13.30	3.72	9.92	3.84
	24	19.49	3.10	18.70	3.17	14.75	3.53	12.38	3.74	11.71	3.77	9.03	3.88
1.6 + 2.5 + 2.5 + 6.0	16	19.72	2.82	19.32	2.89	17.29	3.24	16.07	3.46	15.29	3.51	12.14	3.71
	18	18.90	2.93	18.48	3.00	16.39	3.34	15.13	3.55	14.40	3.60	11.47	3.79
	20	18.62	3.01	18.13	3.08	15.67	3.42	14.20	3.62	13.51	3.66	10.73	3.80
	21	18.65	3.05	18.09	3.10	15.33	3.35	13.67	3.50	13.01	3.57	10.34	3.82
	22	18.80	3.07	18.29	3.14	15.70	3.48	14.15	3.69	13.30	3.72	9.92	3.84
	24	19.49	3.10	18.70	3.17	14.75	3.53	12.38	3.74	11.71	3.77	9.03	3.88

Combination (Capacity)	Indoor Air Temp. °C DB	Outdoor Air Temp. °C									
		0/-1		-5/-6		-7/-8		-10/-11		-15/-	
		Total Q	Input Power	Total Q	Input Power	Total Q	Input Power	Total Q	Input Power	Total Q	Input Power
1.6 + 2.0 + 7.1 + 7.1	16	11.95	3.64	11.05	3.52	10.69	3.47	10.27	3.35	9.58	3.15
	18	11.32	3.70	10.54	3.55	9.85	3.49	10.07	3.39	9.81	3.21
	20	10.67	3.71	10.14	3.57	9.93	3.51	9.89	3.43	9.84	3.30
	21	10.23	3.73	9.61	3.59	9.36	3.53	9.51	3.46	9.77	3.34
	22	10.00	3.75	9.85	3.60	9.79	3.55	9.74	3.48	9.64	3.38
	24	9.30	3.79	9.66	3.65	9.81	3.59	9.60	3.54	9.26	3.46
1.6 + 2.5 + 2.5 + 2.5	16	11.79	3.86	10.90	3.74	10.54	3.69	10.13	3.56	9.45	3.35
	18	11.16	3.92	10.39	3.77	9.71	3.70	9.93	3.59	9.67	3.41
	20	10.52	3.94	10.00	3.79	9.79	3.73	9.75	3.64	9.70	3.50
	21	10.09	3.96	9.47	3.81	9.23	3.75	9.38	3.67	9.63	3.55
	22	9.86	3.98	9.71	3.82	9.66	3.76	9.60	3.70	9.51	3.59
	24	9.17	4.02	9.53	3.87	9.67	3.81	9.47	3.76	9.13	3.67
1.6 + 2.5 + 2.5 + 3.5	16	11.79	3.82	10.90	3.70	10.54	3.65	10.13	3.52	9.45	3.31
	18	11.16	3.88	10.39	3.73	9.71	3.67	9.93	3.56	9.67	3.37
	20	10.52	3.90	10.00	3.75	9.79	3.69	9.75	3.61	9.70	3.47
	21	10.09	3.92	9.47	3.77	9.23	3.71	9.38	3.63	9.63	3.51
	22	9.86	3.94	9.71	3.78	9.66	3.72	9.60	3.66	9.51	3.55
	24	9.17	3.98	9.53	3.83	9.67	3.77	9.47	3.72	9.13	3.64
1.6 + 2.5 + 2.5 + 4.2	16	11.79	3.81	10.90	3.69	10.54	3.64	10.13	3.51	9.45	3.30
	18	11.16	3.87	10.39	3.72	9.71	3.66	9.93	3.55	9.67	3.37
	20	10.52	3.89	10.00	3.74	9.79	3.68	9.75	3.60	9.70	3.46
	21	10.09	3.91	9.47	3.76	9.23	3.70	9.38	3.62	9.63	3.50
	22	9.86	3.93	9.71	3.77	9.66	3.71	9.60	3.65	9.51	3.54
	24	9.17	3.97	9.53	3.82	9.67	3.76	9.47	3.71	9.13	3.63
1.6 + 2.5 + 2.5 + 5.0	16	11.79	3.67	10.90	3.55	10.54	3.50	10.13	3.38	9.45	3.18
	18	11.16	3.73	10.39	3.58	9.71	3.52	9.93	3.42	9.67	3.24
	20	10.52	3.75	10.00	3.60	9.79	3.54	9.75	3.46	9.70	3.33
	21	10.09	3.76	9.47	3.62	9.23	3.56	9.38	3.49	9.63	3.37
	22	9.86	3.78	9.71	3.63	9.66	3.58	9.60	3.51	9.51	3.41
	24	9.17	3.82	9.53	3.68	9.67	3.62	9.47	3.57	9.13	3.49
1.6 + 2.5 + 2.5 + 6.0	16	11.79	3.67	10.90	3.55	10.54	3.50	10.13	3.38	9.45	3.18
	18	11.16	3.73	10.39	3.58	9.71	3.52	9.93	3.42	9.67	3.24
	20	10.52	3.75	10.00	3.60	9.79	3.54	9.75	3.46	9.70	3.33
	21	10.09	3.76	9.47	3.62	9.23	3.56	9.38	3.49	9.63	3.37
	22	9.86	3.78	9.71	3.63	9.66	3.58	9.60	3.51	9.51	3.41
	24	9.17	3.82	9.53	3.68	9.67	3.62	9.47	3.57	9.13	3.49

Combination (Capacity)	Indoor Air Temp. °C DB	Outdoor Air Temp. °C											
		16/15		15/14		10/9		7/6		6/5		2/1	
		Total Q	Input Power	Total Q	Input Power	Total Q	Input Power	Total Q	Input Power	Total Q	Input Power	Total Q	Input Power
1.6 + 2.5 + 2.5 + 7.1	16	20.00	2.85	19.59	2.92	17.53	3.28	16.30	3.50	15.50	3.55	12.31	3.76
	18	19.17	2.97	18.74	3.04	16.62	3.38	15.34	3.59	14.60	3.64	11.63	3.83
	20	18.88	3.05	18.39	3.11	15.89	3.46	14.40	3.66	13.70	3.70	10.88	3.85
	21	18.91	3.08	18.35	3.13	15.55	3.39	13.87	3.54	13.19	3.60	10.48	3.86
	22	19.07	3.10	18.55	3.17	15.92	3.52	14.35	3.73	13.49	3.76	10.06	3.88
	24	19.76	3.13	18.96	3.20	14.96	3.57	12.55	3.78	11.87	3.81	9.15	3.92
1.6 + 2.5 + 3.5 + 3.5	16	19.72	2.86	19.32	2.94	17.29	3.30	16.07	3.52	15.29	3.57	12.14	3.78
	18	18.90	2.98	18.48	3.05	16.39	3.40	15.13	3.61	14.40	3.66	11.47	3.85
	20	18.62	3.06	18.13	3.13	15.67	3.47	14.20	3.68	13.51	3.72	10.73	3.87
	21	18.65	3.10	18.09	3.15	15.33	3.40	13.67	3.56	13.01	3.62	10.34	3.88
	22	18.80	3.12	18.29	3.19	15.70	3.54	14.15	3.75	13.30	3.78	9.92	3.90
	24	19.49	3.15	18.70	3.22	14.75	3.59	12.38	3.80	11.71	3.83	9.03	3.94
1.6 + 2.5 + 3.5 + 4.2	16	19.72	2.85	19.32	2.92	17.29	3.28	16.07	3.50	15.29	3.55	12.14	3.76
	18	18.90	2.97	18.48	3.04	16.39	3.38	15.13	3.59	14.40	3.64	11.47	3.83
	20	18.62	3.05	18.13	3.11	15.67	3.46	14.20	3.66	13.51	3.70	10.73	3.85
	21	18.65	3.08	18.09	3.13	15.33	3.39	13.67	3.54	13.01	3.60	10.34	3.86
	22	18.80	3.10	18.29	3.17	15.70	3.52	14.15	3.73	13.30	3.76	9.92	3.88
	24	19.49	3.13	18.70	3.20	14.75	3.57	12.38	3.78	11.71	3.81	9.03	3.92
1.6 + 2.5 + 3.5 + 5.0	16	19.72	2.79	19.32	2.86	17.29	3.21	16.07	3.42	15.29	3.47	12.14	3.67
	18	18.90	2.90	18.48	2.97	16.39	3.31	15.13	3.51	14.40	3.56	11.47	3.75
	20	18.62	2.98	18.13	3.05	15.67	3.38	14.20	3.58	13.51	3.62	10.73	3.76
	21	18.65	3.01	18.09	3.06	15.33	3.31	13.67	3.46	13.01	3.53	10.34	3.78
	22	18.80	3.03	18.29	3.10	15.70	3.44	14.15	3.65	13.30	3.68	9.92	3.80
	24	19.49	3.06	18.70	3.13	14.75	3.49	12.38	3.70	11.71	3.73	9.03	3.83
1.6 + 2.5 + 3.5 + 6.0	16	20.00	2.83	19.59	2.90	17.53	3.26	16.30	3.48	15.50	3.53	12.31	3.74
	18	19.17	2.95	18.74	3.02	16.62	3.36	15.34	3.57	14.60	3.62	11.63	3.81
	20	18.88	3.03	18.39	3.10	15.89	3.44	14.40	3.64	13.70	3.68	10.88	3.83
	21	18.91	3.06	18.35	3.11	15.55	3.37	13.87	3.52	13.19	3.58	10.48	3.84
	22	19.07	3.08	18.55	3.15	15.92	3.50	14.35	3.71	13.49	3.74	10.06	3.86
	24	19.76	3.11	18.96	3.19	14.96	3.55	12.55	3.76	11.87	3.79	9.15	3.90
1.6 + 2.5 + 3.5 + 7.1	16	20.00	2.82	19.59	2.89	17.53	3.24	16.30	3.46	15.50	3.51	12.31	3.71
	18	19.17	2.93	18.74	3.00	16.62	3.34	15.34	3.55	14.60	3.60	11.63	3.79
	20	18.88	3.01	18.39	3.08	15.89	3.42	14.40	3.62	13.70	3.66	10.88	3.80
	21	18.91	3.05	18.35	3.10	15.55	3.35	13.87	3.50	13.19	3.57	10.48	3.82
	22	19.07	3.07	18.55	3.14	15.92	3.48	14.35	3.69	13.49	3.72	10.06	3.84
	24	19.76	3.10	18.96	3.17	14.96	3.53	12.55	3.74	11.87	3.77	9.15	3.88

Combination (Capacity)	Indoor Air Temp. °C DB	Outdoor Air Temp. °C									
		0/-1		-5/-6		-7/-8		-10/-11		-15/-	
		Total Q	Input Power	Total Q	Input Power	Total Q	Input Power	Total Q	Input Power	Total Q	Input Power
1.6 + 2.5 + 2.5 + 7.1	16	11.95	3.71	11.05	3.59	10.69	3.54	10.27	3.42	9.58	3.21
	18	11.32	3.77	10.54	3.62	9.85	3.56	10.07	3.45	9.81	3.28
	20	10.67	3.79	10.14	3.64	9.93	3.58	9.89	3.50	9.84	3.37
	21	10.23	3.80	9.61	3.66	9.36	3.60	9.51	3.53	9.77	3.41
	22	10.00	3.82	9.85	3.67	9.79	3.61	9.74	3.55	9.64	3.45
	24	9.30	3.86	9.66	3.72	9.81	3.66	9.60	3.61	9.26	3.53
1.6 + 2.5 + 3.5 + 3.5	16	11.79	3.73	10.90	3.61	10.54	3.56	10.13	3.44	9.45	3.23
	18	11.16	3.79	10.39	3.64	9.71	3.58	9.93	3.47	9.67	3.29
	20	10.52	3.81	10.00	3.66	9.79	3.60	9.75	3.52	9.70	3.39
	21	10.09	3.82	9.47	3.68	9.23	3.62	9.38	3.55	9.63	3.42
	22	9.86	3.84	9.71	3.69	9.66	3.63	9.60	3.57	9.51	3.46
	24	9.17	3.88	9.53	3.74	9.67	3.68	9.47	3.63	9.13	3.55
1.6 + 2.5 + 3.5 + 4.2	16	11.79	3.71	10.90	3.59	10.54	3.54	10.13	3.42	9.45	3.21
	18	11.16	3.77	10.39	3.62	9.71	3.56	9.93	3.45	9.67	3.28
	20	10.52	3.79	10.00	3.64	9.79	3.58	9.75	3.50	9.70	3.37
	21	10.09	3.80	9.47	3.66	9.23	3.60	9.38	3.53	9.63	3.41
	22	9.86	3.82	9.71	3.67	9.66	3.61	9.60	3.55	9.51	3.45
	24	9.17	3.86	9.53	3.72	9.67	3.66	9.47	3.61	9.13	3.53
1.6 + 2.5 + 3.5 + 5.0	16	11.79	3.63	10.90	3.51	10.54	3.46	10.13	3.34	9.45	3.14
	18	11.16	3.69	10.39	3.54	9.71	3.48	9.93	3.38	9.67	3.20
	20	10.52	3.70	10.00	3.56	9.79	3.50	9.75	3.42	9.70	3.29
	21	10.09	3.72	9.47	3.58	9.23	3.52	9.38	3.45	9.63	3.33
	22	9.86	3.74	9.71	3.59	9.66	3.54	9.60	3.47	9.51	3.37
	24	9.17	3.78	9.53	3.64	9.67	3.58	9.47	3.53	9.13	3.45
1.6 + 2.5 + 3.5 + 6.0	16	11.95	3.69	11.05	3.57	10.69	3.52	10.27	3.40	9.58	3.20
	18	11.32	3.75	10.54	3.60	9.85	3.54	10.07	3.43	9.81	3.26
	20	10.67	3.77	10.14	3.62	9.93	3.56	9.89	3.48	9.84	3.35
	21	10.23	3.78	9.61	3.64	9.36	3.58	9.51	3.51	9.77	3.39
	22	10.00	3.80	9.85	3.65	9.79	3.60	9.74	3.53	9.64	3.43
	24	9.30	3.84	9.66	3.70	9.81	3.64	9.60	3.59	9.26	3.51
1.6 + 2.5 + 3.5 + 7.1	16	11.95	3.67	11.05	3.55	10.69	3.50	10.27	3.38	9.58	3.18
	18	11.32	3.73	10.54	3.58	9.85	3.52	10.07	3.42	9.81	3.24
	20	10.67	3.75	10.14	3.60	9.93	3.54	9.89	3.46	9.84	3.33
	21	10.23	3.76	9.61	3.62	9.36	3.56	9.51	3.49	9.77	3.37
	22	10.00	3.78	9.85	3.63	9.79	3.58	9.74	3.51	9.64	3.41
	24	9.30	3.82	9.66	3.68	9.81	3.62	9.60	3.57	9.26	3.49

Combination (Capacity)	Indoor Air Temp. °C DB	Outdoor Air Temp. °C											
		16/15		15/14		10/9		7/6		6/5		2/1	
		Total Q	Input Power	Total Q	Input Power	Total Q	Input Power	Total Q	Input Power	Total Q	Input Power	Total Q	Input Power
1.6 + 2.5 + 4.2 + 4.2	16	19.72	2.84	19.32	2.91	17.29	3.27	16.07	3.49	15.29	3.54	12.14	3.75
	18	18.90	2.96	18.48	3.03	16.39	3.37	15.13	3.58	14.40	3.63	11.47	3.82
	20	18.62	3.04	18.13	3.11	15.67	3.45	14.20	3.65	13.51	3.69	10.73	3.84
	21	18.65	3.07	18.09	3.12	15.33	3.38	13.67	3.53	13.01	3.59	10.34	3.85
	22	18.80	3.09	18.29	3.16	15.70	3.51	14.15	3.72	13.30	3.75	9.92	3.87
	24	19.49	3.12	18.70	3.19	14.75	3.56	12.38	3.77	11.71	3.80	9.03	3.91
1.6 + 2.5 + 4.2 + 5.0	16	20.00	2.82	19.59	2.90	17.53	3.25	16.30	3.47	15.50	3.52	12.31	3.73
	18	19.17	2.94	18.74	3.01	16.62	3.35	15.34	3.56	14.60	3.61	11.63	3.80
	20	18.88	3.02	18.39	3.09	15.89	3.43	14.40	3.63	13.70	3.67	10.88	3.81
	21	18.91	3.05	18.35	3.10	15.55	3.36	13.87	3.51	13.19	3.58	10.48	3.83
	22	19.07	3.08	18.55	3.15	15.92	3.49	14.35	3.70	13.49	3.73	10.06	3.85
	24	19.76	3.10	18.96	3.18	14.96	3.54	12.55	3.75	11.87	3.78	9.15	3.89
1.6 + 2.5 + 4.2 + 6.0	16	20.00	2.82	19.59	2.90	17.53	3.25	16.30	3.47	15.50	3.52	12.31	3.73
	18	19.17	2.94	18.74	3.01	16.62	3.35	15.34	3.56	14.60	3.61	11.63	3.80
	20	18.88	3.02	18.39	3.09	15.89	3.43	14.40	3.63	13.70	3.67	10.88	3.81
	21	18.91	3.05	18.35	3.10	15.55	3.36	13.87	3.51	13.19	3.58	10.48	3.83
	22	19.07	3.08	18.55	3.15	15.92	3.49	14.35	3.70	13.49	3.73	10.06	3.85
	24	19.76	3.10	18.96	3.18	14.96	3.54	12.55	3.75	11.87	3.78	9.15	3.89
1.6 + 2.5 + 4.2 + 7.1	16	20.00	2.81	19.59	2.88	17.53	3.24	16.30	3.45	15.50	3.50	12.31	3.70
	18	19.17	2.93	18.74	2.99	16.62	3.33	15.34	3.54	14.60	3.59	11.63	3.78
	20	18.88	3.00	18.39	3.07	15.89	3.41	14.40	3.61	13.70	3.65	10.88	3.79
	21	18.91	3.04	18.35	3.09	15.55	3.34	13.87	3.49	13.19	3.56	10.48	3.81
	22	19.07	3.06	18.55	3.13	15.92	3.47	14.35	3.68	13.49	3.71	10.06	3.83
	24	19.76	3.09	18.96	3.16	14.96	3.52	12.55	3.73	11.87	3.76	9.15	3.87
1.6 + 2.5 + 5.0 + 5.0	16	20.00	2.77	19.59	2.84	17.53	3.19	16.30	3.40	15.50	3.45	12.31	3.65
	18	19.17	2.89	18.74	2.95	16.62	3.29	15.34	3.49	14.60	3.54	11.63	3.72
	20	18.88	2.96	18.39	3.03	15.89	3.36	14.40	3.56	13.70	3.60	10.88	3.74
	21	18.91	3.00	18.35	3.04	15.55	3.29	13.87	3.44	13.19	3.51	10.48	3.76
	22	19.07	3.02	18.55	3.08	15.92	3.42	14.35	3.63	13.49	3.66	10.06	3.77
	24	19.76	3.04	18.96	3.12	14.96	3.47	12.55	3.68	11.87	3.71	9.15	3.81
1.6 + 2.5 + 5.0 + 6.0	16	20.00	2.77	19.59	2.84	17.53	3.19	16.30	3.40	15.50	3.45	12.31	3.65
	18	19.17	2.89	18.74	2.95	16.62	3.29	15.34	3.49	14.60	3.54	11.63	3.72
	20	18.88	2.96	18.39	3.03	15.89	3.36	14.40	3.56	13.70	3.60	10.88	3.74
	21	18.91	3.00	18.35	3.04	15.55	3.29	13.87	3.44	13.19	3.51	10.48	3.76
	22	19.07	3.02	18.55	3.08	15.92	3.42	14.35	3.63	13.49	3.66	10.06	3.77
	24	19.76	3.04	18.96	3.12	14.96	3.47	12.55	3.68	11.87	3.71	9.15	3.81



Combination (Capacity)	Indoor Air Temp. °C DB	Outdoor Air Temp. °C									
		0/-1		-5/-6		-7/-8		-10/-11		-15/-	
		Total Q	Input Power	Total Q	Input Power	Total Q	Input Power	Total Q	Input Power	Total Q	Input Power
1.6 + 2.5 + 4.2 + 4.2	16	11.79	3.70	10.90	3.58	10.54	3.53	10.13	3.41	9.45	3.21
	18	11.16	3.76	10.39	3.61	9.71	3.55	9.93	3.44	9.67	3.27
	20	10.52	3.78	10.00	3.63	9.79	3.57	9.75	3.49	9.70	3.36
	21	10.09	3.79	9.47	3.65	9.23	3.59	9.38	3.52	9.63	3.40
	22	9.86	3.81	9.71	3.66	9.66	3.61	9.60	3.54	9.51	3.44
	24	9.17	3.85	9.53	3.71	9.67	3.65	9.47	3.60	9.13	3.52
1.6 + 2.5 + 4.2 + 5.0	16	11.95	3.68	11.05	3.56	10.69	3.51	10.27	3.39	9.58	3.19
	18	11.32	3.74	10.54	3.59	9.85	3.53	10.07	3.42	9.81	3.25
	20	10.67	3.76	10.14	3.61	9.93	3.55	9.89	3.47	9.84	3.34
	21	10.23	3.77	9.61	3.63	9.36	3.57	9.51	3.50	9.77	3.38
	22	10.00	3.79	9.85	3.64	9.79	3.59	9.74	3.52	9.64	3.42
	24	9.30	3.83	9.66	3.69	9.81	3.63	9.60	3.58	9.26	3.50
1.6 + 2.5 + 4.2 + 6.0	16	11.95	3.68	11.05	3.56	10.69	3.51	10.27	3.39	9.58	3.19
	18	11.32	3.74	10.54	3.59	9.85	3.53	10.07	3.42	9.81	3.25
	20	10.67	3.76	10.14	3.61	9.93	3.55	9.89	3.47	9.84	3.34
	21	10.23	3.77	9.61	3.63	9.36	3.57	9.51	3.50	9.77	3.38
	22	10.00	3.79	9.85	3.64	9.79	3.59	9.74	3.52	9.64	3.42
	24	9.30	3.83	9.66	3.69	9.81	3.63	9.60	3.58	9.26	3.50
1.6 + 2.5 + 4.2 + 7.1	16	11.95	3.66	11.05	3.54	10.69	3.49	10.27	3.37	9.58	3.17
	18	11.32	3.72	10.54	3.57	9.85	3.51	10.07	3.41	9.81	3.23
	20	10.67	3.74	10.14	3.59	9.93	3.53	9.89	3.45	9.84	3.32
	21	10.23	3.75	9.61	3.61	9.36	3.55	9.51	3.48	9.77	3.36
	22	10.00	3.77	9.85	3.62	9.79	3.57	9.74	3.50	9.64	3.40
	24	9.30	3.81	9.66	3.67	9.81	3.61	9.60	3.56	9.26	3.48
1.6 + 2.5 + 5.0 + 5.0	16	11.95	3.61	11.05	3.49	10.69	3.44	10.27	3.33	9.58	3.13
	18	11.32	3.67	10.54	3.52	9.85	3.46	10.07	3.36	9.81	3.19
	20	10.67	3.68	10.14	3.54	9.93	3.48	9.89	3.41	9.84	3.27
	21	10.23	3.70	9.61	3.56	9.36	3.50	9.51	3.43	9.77	3.31
	22	10.00	3.72	9.85	3.57	9.79	3.52	9.74	3.45	9.64	3.35
	24	9.30	3.76	9.66	3.62	9.81	3.56	9.60	3.51	9.26	3.43
1.6 + 2.5 + 5.0 + 6.0	16	11.95	3.61	11.05	3.49	10.69	3.44	10.27	3.33	9.58	3.13
	18	11.32	3.67	10.54	3.52	9.85	3.46	10.07	3.36	9.81	3.19
	20	10.67	3.68	10.14	3.54	9.93	3.48	9.89	3.41	9.84	3.27
	21	10.23	3.70	9.61	3.56	9.36	3.50	9.51	3.43	9.77	3.31
	22	10.00	3.72	9.85	3.57	9.79	3.52	9.74	3.45	9.64	3.35
	24	9.30	3.76	9.66	3.62	9.81	3.56	9.60	3.51	9.26	3.43

Combination (Capacity)	Indoor Air Temp. °C DB	Outdoor Air Temp. °C											
		16/15		15/14		10/9		7/6		6/5		2/1	
		Total Q	Input Power	Total Q	Input Power	Total Q	Input Power	Total Q	Input Power	Total Q	Input Power	Total Q	Input Power
1.6 + 2.5 + 5.0 + 7.1	16	20.00	2.80	19.59	2.87	17.53	3.23	16.30	3.44	15.50	3.49	12.31	3.69
	18	19.17	2.92	18.74	2.99	16.62	3.32	15.34	3.53	14.60	3.58	11.63	3.77
	20	18.88	3.00	18.39	3.06	15.89	3.40	14.40	3.60	13.70	3.64	10.88	3.78
	21	18.91	3.03	18.35	3.08	15.55	3.33	13.87	3.48	13.19	3.55	10.48	3.80
	22	19.07	3.05	18.55	3.12	15.92	3.46	14.35	3.67	13.49	3.70	10.06	3.82
	24	19.76	3.08	18.96	3.15	14.96	3.51	12.55	3.72	11.87	3.75	9.15	3.86
1.6 + 2.5 + 6.0 + 6.0	16	20.00	2.77	19.59	2.84	17.53	3.19	16.30	3.40	15.50	3.45	12.31	3.65
	18	19.17	2.89	18.74	2.95	16.62	3.29	15.34	3.49	14.60	3.54	11.63	3.72
	20	18.88	2.96	18.39	3.03	15.89	3.36	14.40	3.56	13.70	3.60	10.88	3.74
	21	18.91	3.00	18.35	3.04	15.55	3.29	13.87	3.44	13.19	3.51	10.48	3.76
	22	19.07	3.02	18.55	3.08	15.92	3.42	14.35	3.63	13.49	3.66	10.06	3.77
	24	19.76	3.04	18.96	3.12	14.96	3.47	12.55	3.68	11.87	3.71	9.15	3.81
1.6 + 2.5 + 6.0 + 7.1	16	20.00	2.80	19.59	2.87	17.53	3.23	16.30	3.44	15.50	3.49	12.31	3.69
	18	19.17	2.92	18.74	2.99	16.62	3.32	15.34	3.53	14.60	3.58	11.63	3.77
	20	18.88	3.00	18.39	3.06	15.89	3.40	14.40	3.60	13.70	3.64	10.88	3.78
	21	18.91	3.03	18.35	3.08	15.55	3.33	13.87	3.48	13.19	3.55	10.48	3.80
	22	19.07	3.05	18.55	3.12	15.92	3.46	14.35	3.67	13.49	3.70	10.06	3.82
	24	19.76	3.08	18.96	3.15	14.96	3.51	12.55	3.72	11.87	3.75	9.15	3.86
1.6 + 2.5 + 7.1 + 7.1	16	20.00	2.79	19.59	2.86	17.53	3.22	16.30	3.43	15.50	3.48	12.31	3.68
	18	19.17	2.91	18.74	2.98	16.62	3.32	15.34	3.52	14.60	3.57	11.63	3.76
	20	18.88	2.99	18.39	3.05	15.89	3.39	14.40	3.59	13.70	3.63	10.88	3.77
	21	18.91	3.02	18.35	3.07	15.55	3.32	13.87	3.47	13.19	3.54	10.48	3.79
	22	19.07	3.04	18.55	3.11	15.92	3.45	14.35	3.66	13.49	3.69	10.06	3.81
	24	19.76	3.07	18.96	3.14	14.96	3.50	12.55	3.71	11.87	3.74	9.15	3.84
1.6 + 3.5 + 3.5 + 3.5	16	19.72	2.83	19.32	2.90	17.29	3.26	16.07	3.48	15.29	3.53	12.14	3.74
	18	18.90	2.95	18.48	3.02	16.39	3.36	15.13	3.57	14.40	3.62	11.47	3.81
	20	18.62	3.03	18.13	3.10	15.67	3.44	14.20	3.64	13.51	3.68	10.73	3.83
	21	18.65	3.06	18.09	3.11	15.33	3.37	13.67	3.52	13.01	3.58	10.34	3.84
	22	18.80	3.08	18.29	3.15	15.70	3.50	14.15	3.71	13.30	3.74	9.92	3.86
	24	19.49	3.11	18.70	3.19	14.75	3.55	12.38	3.76	11.71	3.79	9.03	3.90
1.6 + 3.5 + 3.5 + 4.2	16	20.00	2.92	19.59	2.99	17.53	3.36	16.30	3.58	15.50	3.64	12.31	3.85
	18	19.17	3.04	18.74	3.11	16.62	3.46	15.34	3.67	14.60	3.72	11.63	3.92
	20	18.88	3.12	18.39	3.19	15.89	3.54	14.40	3.75	13.70	3.79	10.88	3.94
	21	18.91	3.15	18.35	3.21	15.55	3.47	13.87	3.63	13.19	3.69	10.48	3.96
	22	19.07	3.18	18.55	3.25	15.92	3.61	14.35	3.82	13.49	3.85	10.06	3.98
	24	19.76	3.21	18.96	3.28	14.96	3.65	12.55	3.88	11.87	3.90	9.15	4.02

Combination (Capacity)	Indoor Air Temp. °C DB	Outdoor Air Temp. °C									
		0/-1		-5/-6		-7/-8		-10/-11		-15/-	
		Total Q	Input Power	Total Q	Input Power	Total Q	Input Power	Total Q	Input Power	Total Q	Input Power
1.6 + 2.5 + 5.0 + 7.1	16	11.95	3.65	11.05	3.53	10.69	3.48	10.27	3.36	9.58	3.16
	18	11.32	3.71	10.54	3.56	9.85	3.50	10.07	3.40	9.81	3.22
	20	10.67	3.73	10.14	3.58	9.93	3.52	9.89	3.44	9.84	3.31
	21	10.23	3.74	9.61	3.60	9.36	3.54	9.51	3.47	9.77	3.35
	22	10.00	3.76	9.85	3.61	9.79	3.56	9.74	3.49	9.64	3.39
	24	9.30	3.80	9.66	3.66	9.81	3.60	9.60	3.55	9.26	3.47
1.6 + 2.5 + 6.0 + 6.0	16	11.95	3.61	11.05	3.49	10.69	3.44	10.27	3.33	9.58	3.13
	18	11.32	3.67	10.54	3.52	9.85	3.46	10.07	3.36	9.81	3.19
	20	10.67	3.68	10.14	3.54	9.93	3.48	9.89	3.41	9.84	3.27
	21	10.23	3.70	9.61	3.56	9.36	3.50	9.51	3.43	9.77	3.31
	22	10.00	3.72	9.85	3.57	9.79	3.52	9.74	3.45	9.64	3.35
	24	9.30	3.76	9.66	3.62	9.81	3.56	9.60	3.51	9.26	3.43
1.6 + 2.5 + 6.0 + 7.1	16	11.95	3.65	11.05	3.53	10.69	3.48	10.27	3.36	9.58	3.16
	18	11.32	3.71	10.54	3.56	9.85	3.50	10.07	3.40	9.81	3.22
	20	10.67	3.73	10.14	3.58	9.93	3.52	9.89	3.44	9.84	3.31
	21	10.23	3.74	9.61	3.60	9.36	3.54	9.51	3.47	9.77	3.35
	22	10.00	3.76	9.85	3.61	9.79	3.56	9.74	3.49	9.64	3.39
	24	9.30	3.80	9.66	3.66	9.81	3.60	9.60	3.55	9.26	3.47
1.6 + 2.5 + 7.1 + 7.1	16	11.95	3.64	11.05	3.52	10.69	3.47	10.27	3.35	9.58	3.15
	18	11.32	3.70	10.54	3.55	9.85	3.49	10.07	3.39	9.81	3.21
	20	10.67	3.71	10.14	3.57	9.93	3.51	9.89	3.43	9.84	3.30
	21	10.23	3.73	9.61	3.59	9.36	3.53	9.51	3.46	9.77	3.34
	22	10.00	3.75	9.85	3.60	9.79	3.55	9.74	3.48	9.64	3.38
	24	9.30	3.79	9.66	3.65	9.81	3.59	9.60	3.54	9.26	3.46
1.6 + 3.5 + 3.5 + 3.5	16	11.79	3.69	10.90	3.57	10.54	3.52	10.13	3.40	9.45	3.20
	18	11.16	3.75	10.39	3.60	9.71	3.54	9.93	3.43	9.67	3.26
	20	10.52	3.77	10.00	3.62	9.79	3.56	9.75	3.48	9.70	3.35
	21	10.09	3.78	9.47	3.64	9.23	3.58	9.38	3.51	9.63	3.39
	22	9.86	3.80	9.71	3.65	9.66	3.60	9.60	3.53	9.51	3.43
	24	9.17	3.84	9.53	3.70	9.67	3.64	9.47	3.59	9.13	3.51
1.6 + 3.5 + 3.5 + 4.2	16	11.95	3.80	11.05	3.68	10.69	3.63	10.27	3.50	9.58	3.29
	18	11.32	3.86	10.54	3.71	9.85	3.65	10.07	3.54	9.81	3.36
	20	10.67	3.88	10.14	3.73	9.93	3.67	9.89	3.59	9.84	3.45
	21	10.23	3.90	9.61	3.75	9.36	3.69	9.51	3.61	9.77	3.49
	22	10.00	3.91	9.85	3.76	9.79	3.70	9.74	3.64	9.64	3.53
	24	9.30	3.96	9.66	3.81	9.81	3.75	9.60	3.70	9.26	3.62

Combination (Capacity)	Indoor Air Temp. °C DB	Outdoor Air Temp. °C											
		16/15		15/14		10/9		7/6		6/5		2/1	
		Total Q	Input Power	Total Q	Input Power	Total Q	Input Power	Total Q	Input Power	Total Q	Input Power	Total Q	Input Power
1.6 + 3.5 + 3.5 + 5.0	16	20.00	2.81	19.59	2.88	17.53	3.24	16.30	3.45	15.50	3.50	12.31	3.70
	18	19.17	2.93	18.74	2.99	16.62	3.33	15.34	3.54	14.60	3.59	11.63	3.78
	20	18.88	3.00	18.39	3.07	15.89	3.41	14.40	3.61	13.70	3.65	10.88	3.79
	21	18.91	3.04	18.35	3.09	15.55	3.34	13.87	3.49	13.19	3.56	10.48	3.81
	22	19.07	3.06	18.55	3.13	15.92	3.47	14.35	3.68	13.49	3.71	10.06	3.83
	24	19.76	3.09	18.96	3.16	14.96	3.52	12.55	3.73	11.87	3.76	9.15	3.87
1.6 + 3.5 + 3.5 + 6.0	16	20.00	2.81	19.59	2.88	17.53	3.24	16.30	3.45	15.50	3.50	12.31	3.70
	18	19.17	2.93	18.74	2.99	16.62	3.33	15.34	3.54	14.60	3.59	11.63	3.78
	20	18.88	3.00	18.39	3.07	15.89	3.41	14.40	3.61	13.70	3.65	10.88	3.79
	21	18.91	3.04	18.35	3.09	15.55	3.34	13.87	3.49	13.19	3.56	10.48	3.81
	22	19.07	3.06	18.55	3.13	15.92	3.47	14.35	3.68	13.49	3.71	10.06	3.83
	24	19.76	3.09	18.96	3.16	14.96	3.52	12.55	3.73	11.87	3.76	9.15	3.87
1.6 + 3.5 + 3.5 + 7.1	16	20.00	2.84	19.59	2.91	17.53	3.27	16.30	3.49	15.50	3.54	12.31	3.75
	18	19.17	2.96	18.74	3.03	16.62	3.37	15.34	3.58	14.60	3.63	11.63	3.82
	20	18.88	3.04	18.39	3.11	15.89	3.45	14.40	3.65	13.70	3.69	10.88	3.84
	21	18.91	3.07	18.35	3.12	15.55	3.38	13.87	3.53	13.19	3.59	10.48	3.85
	22	19.07	3.09	18.55	3.16	15.92	3.51	14.35	3.72	13.49	3.75	10.06	3.87
	24	19.76	3.12	18.96	3.19	14.96	3.56	12.55	3.77	11.87	3.80	9.15	3.91
1.6 + 3.5 + 4.2 + 4.2	16	20.00	2.90	19.59	2.98	17.53	3.34	16.30	3.56	15.50	3.62	12.31	3.83
	18	19.17	3.02	18.74	3.09	16.62	3.44	15.34	3.66	14.60	3.70	11.63	3.90
	20	18.88	3.10	18.39	3.17	15.89	3.52	14.40	3.73	13.70	3.77	10.88	3.92
	21	18.91	3.14	18.35	3.19	15.55	3.45	13.87	3.61	13.19	3.67	10.48	3.94
	22	19.07	3.16	18.55	3.23	15.92	3.59	14.35	3.80	13.49	3.83	10.06	3.95
	24	19.76	3.19	18.96	3.26	14.96	3.63	12.55	3.86	11.87	3.88	9.15	3.99
1.6 + 3.5 + 4.2 + 5.0	16	20.00	2.84	19.59	2.91	17.53	3.27	16.30	3.49	15.50	3.54	12.31	3.75
	18	19.17	2.96	18.74	3.03	16.62	3.37	15.34	3.58	14.60	3.63	11.63	3.82
	20	18.88	3.04	18.39	3.11	15.89	3.45	14.40	3.65	13.70	3.69	10.88	3.84
	21	18.91	3.07	18.35	3.12	15.55	3.38	13.87	3.53	13.19	3.59	10.48	3.85
	22	19.07	3.09	18.55	3.16	15.92	3.51	14.35	3.72	13.49	3.75	10.06	3.87
	24	19.76	3.12	18.96	3.19	14.96	3.56	12.55	3.77	11.87	3.80	9.15	3.91
1.6 + 3.5 + 4.2 + 6.0	16	20.00	2.84	19.59	2.91	17.53	3.27	16.30	3.49	15.50	3.54	12.31	3.75
	18	19.17	2.96	18.74	3.03	16.62	3.37	15.34	3.58	14.60	3.63	11.63	3.82
	20	18.88	3.04	18.39	3.11	15.89	3.45	14.40	3.65	13.70	3.69	10.88	3.84
	21	18.91	3.07	18.35	3.12	15.55	3.38	13.87	3.53	13.19	3.59	10.48	3.85
	22	19.07	3.09	18.55	3.16	15.92	3.51	14.35	3.72	13.49	3.75	10.06	3.87
	24	19.76	3.12	18.96	3.19	14.96	3.56	12.55	3.77	11.87	3.80	9.15	3.91

Combination (Capacity)	Indoor Air Temp. °C DB	Outdoor Air Temp. °C									
		0/-1		-5/-6		-7/-8		-10/-11		-15/-	
		Total Q	Input Power	Total Q	Input Power	Total Q	Input Power	Total Q	Input Power	Total Q	Input Power
1.6 + 3.5 + 3.5 + 5.0	16	11.95	3.66	11.05	3.54	10.69	3.49	10.27	3.37	9.58	3.17
	18	11.32	3.72	10.54	3.57	9.85	3.51	10.07	3.41	9.81	3.23
	20	10.67	3.74	10.14	3.59	9.93	3.53	9.89	3.45	9.84	3.32
	21	10.23	3.75	9.61	3.61	9.36	3.55	9.51	3.48	9.77	3.36
	22	10.00	3.77	9.85	3.62	9.79	3.57	9.74	3.50	9.64	3.40
	24	9.30	3.81	9.66	3.67	9.81	3.61	9.60	3.56	9.26	3.48
1.6 + 3.5 + 3.5 + 6.0	16	11.95	3.66	11.05	3.54	10.69	3.49	10.27	3.37	9.58	3.17
	18	11.32	3.72	10.54	3.57	9.85	3.51	10.07	3.41	9.81	3.23
	20	10.67	3.74	10.14	3.59	9.93	3.53	9.89	3.45	9.84	3.32
	21	10.23	3.75	9.61	3.61	9.36	3.55	9.51	3.48	9.77	3.36
	22	10.00	3.77	9.85	3.62	9.79	3.57	9.74	3.50	9.64	3.40
	24	9.30	3.81	9.66	3.67	9.81	3.61	9.60	3.56	9.26	3.48
1.6 + 3.5 + 3.5 + 7.1	16	11.95	3.70	11.05	3.58	10.69	3.53	10.27	3.41	9.58	3.21
	18	11.32	3.76	10.54	3.61	9.85	3.55	10.07	3.44	9.81	3.27
	20	10.67	3.78	10.14	3.63	9.93	3.57	9.89	3.49	9.84	3.36
	21	10.23	3.79	9.61	3.65	9.36	3.59	9.51	3.52	9.77	3.40
	22	10.00	3.81	9.85	3.66	9.79	3.61	9.74	3.54	9.64	3.44
	24	9.30	3.85	9.66	3.71	9.81	3.65	9.60	3.60	9.26	3.52
1.6 + 3.5 + 4.2 + 4.2	16	11.95	3.78	11.05	3.66	10.69	3.61	10.27	3.48	9.58	3.28
	18	11.32	3.84	10.54	3.69	9.85	3.63	10.07	3.52	9.81	3.34
	20	10.67	3.86	10.14	3.71	9.93	3.65	9.89	3.57	9.84	3.43
	21	10.23	3.88	9.61	3.73	9.36	3.67	9.51	3.59	9.77	3.47
	22	10.00	3.89	9.85	3.74	9.79	3.68	9.74	3.62	9.64	3.51
	24	9.30	3.94	9.66	3.79	9.81	3.73	9.60	3.68	9.26	3.60
1.6 + 3.5 + 4.2 + 5.0	16	11.95	3.70	11.05	3.58	10.69	3.53	10.27	3.41	9.58	3.21
	18	11.32	3.76	10.54	3.61	9.85	3.55	10.07	3.44	9.81	3.27
	20	10.67	3.78	10.14	3.63	9.93	3.57	9.89	3.49	9.84	3.36
	21	10.23	3.79	9.61	3.65	9.36	3.59	9.51	3.52	9.77	3.40
	22	10.00	3.81	9.85	3.66	9.79	3.61	9.74	3.54	9.64	3.44
	24	9.30	3.85	9.66	3.71	9.81	3.65	9.60	3.60	9.26	3.52
1.6 + 3.5 + 4.2 + 6.0	16	11.95	3.70	11.05	3.58	10.69	3.53	10.27	3.41	9.58	3.21
	18	11.32	3.76	10.54	3.61	9.85	3.55	10.07	3.44	9.81	3.27
	20	10.67	3.78	10.14	3.63	9.93	3.57	9.89	3.49	9.84	3.36
	21	10.23	3.79	9.61	3.65	9.36	3.59	9.51	3.52	9.77	3.40
	22	10.00	3.81	9.85	3.66	9.79	3.61	9.74	3.54	9.64	3.44
	24	9.30	3.85	9.66	3.71	9.81	3.65	9.60	3.60	9.26	3.52

Combination (Capacity)	Indoor Air Temp. °C DB	Outdoor Air Temp. °C											
		16/15		15/14		10/9		7/6		6/5		2/1	
		Total Q	Input Power	Total Q	Input Power	Total Q	Input Power	Total Q	Input Power	Total Q	Input Power	Total Q	Input Power
1.6 + 3.5 + 4.2 + 7.1	16	20.00	2.83	19.59	2.90	17.53	3.26	16.30	3.48	15.50	3.53	12.31	3.74
	18	19.17	2.95	18.74	3.02	16.62	3.36	15.34	3.57	14.60	3.62	11.63	3.81
	20	18.88	3.03	18.39	3.10	15.89	3.44	14.40	3.64	13.70	3.68	10.88	3.83
	21	18.91	3.06	18.35	3.11	15.55	3.37	13.87	3.52	13.19	3.58	10.48	3.84
	22	19.07	3.08	18.55	3.15	15.92	3.50	14.35	3.71	13.49	3.74	10.06	3.86
	24	19.76	3.11	18.96	3.19	14.96	3.55	12.55	3.76	11.87	3.79	9.15	3.90
1.6 + 3.5 + 5.0 + 5.0	16	20.00	2.79	19.59	2.86	17.53	3.22	16.30	3.43	15.50	3.48	12.31	3.68
	18	19.17	2.91	18.74	2.98	16.62	3.32	15.34	3.52	14.60	3.57	11.63	3.76
	20	18.88	2.99	18.39	3.05	15.89	3.39	14.40	3.59	13.70	3.63	10.88	3.77
	21	18.91	3.02	18.35	3.07	15.55	3.32	13.87	3.47	13.19	3.54	10.48	3.79
	22	19.07	3.04	18.55	3.11	15.92	3.45	14.35	3.66	13.49	3.69	10.06	3.81
	24	19.76	3.07	18.96	3.14	14.96	3.50	12.55	3.71	11.87	3.74	9.15	3.84
1.6 + 3.5 + 5.0 + 6.0	16	20.00	2.79	19.59	2.86	17.53	3.22	16.30	3.43	15.50	3.48	12.31	3.68
	18	19.17	2.91	18.74	2.98	16.62	3.32	15.34	3.52	14.60	3.57	11.63	3.76
	20	18.88	2.99	18.39	3.05	15.89	3.39	14.40	3.59	13.70	3.63	10.88	3.77
	21	18.91	3.02	18.35	3.07	15.55	3.32	13.87	3.47	13.19	3.54	10.48	3.79
	22	19.07	3.04	18.55	3.11	15.92	3.45	14.35	3.66	13.49	3.69	10.06	3.81
	24	19.76	3.07	18.96	3.14	14.96	3.50	12.55	3.71	11.87	3.74	9.15	3.84
1.6 + 3.5 + 5.0 + 7.1	16	20.00	2.78	19.59	2.85	17.53	3.20	16.30	3.41	15.50	3.46	12.31	3.66
	18	19.17	2.89	18.74	2.96	16.62	3.30	15.34	3.50	14.60	3.55	11.63	3.74
	20	18.88	2.97	18.39	3.04	15.89	3.37	14.40	3.57	13.70	3.61	10.88	3.75
	21	18.91	3.00	18.35	3.05	15.55	3.30	13.87	3.45	13.19	3.52	10.48	3.77
	22	19.07	3.03	18.55	3.09	15.92	3.43	14.35	3.64	13.49	3.67	10.06	3.78
	24	19.76	3.05	18.96	3.12	14.96	3.48	12.55	3.69	11.87	3.72	9.15	3.82
1.6 + 3.5 + 6.0 + 6.0	16	20.00	2.79	19.59	2.86	17.53	3.22	16.30	3.43	15.50	3.48	12.31	3.68
	18	19.17	2.91	18.74	2.98	16.62	3.32	15.34	3.52	14.60	3.57	11.63	3.76
	20	18.88	2.99	18.39	3.05	15.89	3.39	14.40	3.59	13.70	3.63	10.88	3.77
	21	18.91	3.02	18.35	3.07	15.55	3.32	13.87	3.47	13.19	3.54	10.48	3.79
	22	19.07	3.04	18.55	3.11	15.92	3.45	14.35	3.66	13.49	3.69	10.06	3.81
	24	19.76	3.07	18.96	3.14	14.96	3.50	12.55	3.71	11.87	3.74	9.15	3.84
1.6 + 3.5 + 6.0 + 7.1	16	20.00	2.78	19.59	2.85	17.53	3.20	16.30	3.41	15.50	3.46	12.31	3.66
	18	19.17	2.89	18.74	2.96	16.62	3.30	15.34	3.50	14.60	3.55	11.63	3.74
	20	18.88	2.97	18.39	3.04	15.89	3.37	14.40	3.57	13.70	3.61	10.88	3.75
	21	18.91	3.00	18.35	3.05	15.55	3.30	13.87	3.45	13.19	3.52	10.48	3.77
	22	19.07	3.03	18.55	3.09	15.92	3.43	14.35	3.64	13.49	3.67	10.06	3.78
	24	19.76	3.05	18.96	3.12	14.96	3.48	12.55	3.69	11.87	3.72	9.15	3.82

Combination (Capacity)	Indoor Air Temp. °C DB	Outdoor Air Temp. °C									
		0/-1		-5/-6		-7/-8		-10/-11		-15/-	
		Total Q	Input Power	Total Q	Input Power	Total Q	Input Power	Total Q	Input Power	Total Q	Input Power
1.6 + 3.5 + 4.2 + 7.1	16	11.95	3.69	11.05	3.57	10.69	3.52	10.27	3.40	9.58	3.20
	18	11.32	3.75	10.54	3.60	9.85	3.54	10.07	3.43	9.81	3.26
	20	10.67	3.77	10.14	3.62	9.93	3.56	9.89	3.48	9.84	3.35
	21	10.23	3.78	9.61	3.64	9.36	3.58	9.51	3.51	9.77	3.39
	22	10.00	3.80	9.85	3.65	9.79	3.60	9.74	3.53	9.64	3.43
	24	9.30	3.84	9.66	3.70	9.81	3.64	9.60	3.59	9.26	3.51
1.6 + 3.5 + 5.0 + 5.0	16	11.95	3.64	11.05	3.52	10.69	3.47	10.27	3.35	9.58	3.15
	18	11.32	3.70	10.54	3.55	9.85	3.49	10.07	3.39	9.81	3.21
	20	10.67	3.71	10.14	3.57	9.93	3.51	9.89	3.43	9.84	3.30
	21	10.23	3.73	9.61	3.59	9.36	3.53	9.51	3.46	9.77	3.34
	22	10.00	3.75	9.85	3.60	9.79	3.55	9.74	3.48	9.64	3.38
	24	9.30	3.79	9.66	3.65	9.81	3.59	9.60	3.54	9.26	3.46
1.6 + 3.5 + 5.0 + 6.0	16	11.95	3.64	11.05	3.52	10.69	3.47	10.27	3.35	9.58	3.15
	18	11.32	3.70	10.54	3.55	9.85	3.49	10.07	3.39	9.81	3.21
	20	10.67	3.71	10.14	3.57	9.93	3.51	9.89	3.43	9.84	3.30
	21	10.23	3.73	9.61	3.59	9.36	3.53	9.51	3.46	9.77	3.34
	22	10.00	3.75	9.85	3.60	9.79	3.55	9.74	3.48	9.64	3.38
	24	9.30	3.79	9.66	3.65	9.81	3.59	9.60	3.54	9.26	3.46
1.6 + 3.5 + 5.0 + 7.1	16	11.95	3.62	11.05	3.50	10.69	3.45	10.27	3.33	9.58	3.14
	18	11.32	3.68	10.54	3.53	9.85	3.47	10.07	3.37	9.81	3.20
	20	10.67	3.69	10.14	3.55	9.93	3.49	9.89	3.41	9.84	3.28
	21	10.23	3.71	9.61	3.57	9.36	3.51	9.51	3.44	9.77	3.32
	22	10.00	3.73	9.85	3.58	9.79	3.53	9.74	3.46	9.64	3.36
	24	9.30	3.77	9.66	3.63	9.81	3.57	9.60	3.52	9.26	3.44
1.6 + 3.5 + 6.0 + 6.0	16	11.95	3.64	11.05	3.52	10.69	3.47	10.27	3.35	9.58	3.15
	18	11.32	3.70	10.54	3.55	9.85	3.49	10.07	3.39	9.81	3.21
	20	10.67	3.71	10.14	3.57	9.93	3.51	9.89	3.43	9.84	3.30
	21	10.23	3.73	9.61	3.59	9.36	3.53	9.51	3.46	9.77	3.34
	22	10.00	3.75	9.85	3.60	9.79	3.55	9.74	3.48	9.64	3.38
	24	9.30	3.79	9.66	3.65	9.81	3.59	9.60	3.54	9.26	3.46
1.6 + 3.5 + 6.0 + 7.1	16	11.95	3.62	11.05	3.50	10.69	3.45	10.27	3.33	9.58	3.14
	18	11.32	3.68	10.54	3.53	9.85	3.47	10.07	3.37	9.81	3.20
	20	10.67	3.69	10.14	3.55	9.93	3.49	9.89	3.41	9.84	3.28
	21	10.23	3.71	9.61	3.57	9.36	3.51	9.51	3.44	9.77	3.32
	22	10.00	3.73	9.85	3.58	9.79	3.53	9.74	3.46	9.64	3.36
	24	9.30	3.77	9.66	3.63	9.81	3.57	9.60	3.52	9.26	3.44

Combination (Capacity)	Indoor Air Temp. °C DB	Outdoor Air Temp. °C											
		16/15		15/14		10/9		7/6		6/5		2/1	
		Total Q	Input Power	Total Q	Input Power	Total Q	Input Power	Total Q	Input Power	Total Q	Input Power	Total Q	Input Power
1.6 + 4.2 + 4.2 + 4.2	16	20.00	2.89	19.59	2.97	17.53	3.33	16.30	3.55	15.50	3.61	12.31	3.82
	18	19.17	3.01	18.74	3.09	16.62	3.44	15.34	3.65	14.60	3.69	11.63	3.89
	20	18.88	3.10	18.39	3.16	15.89	3.51	14.40	3.72	13.70	3.76	10.88	3.91
	21	18.91	3.13	18.35	3.18	15.55	3.44	13.87	3.60	13.19	3.66	10.48	3.93
	22	19.07	3.15	18.55	3.22	15.92	3.58	14.35	3.79	13.49	3.82	10.06	3.94
	24	19.76	3.18	18.96	3.26	14.96	3.62	12.55	3.85	11.87	3.87	9.15	3.98
1.6 + 4.2 + 4.2 + 5.0	16	20.00	2.83	19.59	2.90	17.53	3.26	16.30	3.48	15.50	3.53	12.31	3.74
	18	19.17	2.95	18.74	3.02	16.62	3.36	15.34	3.57	14.60	3.62	11.63	3.81
	20	18.88	3.03	18.39	3.10	15.89	3.44	14.40	3.64	13.70	3.68	10.88	3.83
	21	18.91	3.06	18.35	3.11	15.55	3.37	13.87	3.52	13.19	3.58	10.48	3.84
	22	19.07	3.08	18.55	3.15	15.92	3.50	14.35	3.71	13.49	3.74	10.06	3.86
	24	19.76	3.11	18.96	3.19	14.96	3.55	12.55	3.76	11.87	3.79	9.15	3.90
1.6 + 4.2 + 4.2 + 6.0	16	20.00	2.83	19.59	2.90	17.53	3.26	16.30	3.48	15.50	3.53	12.31	3.74
	18	19.17	2.95	18.74	3.02	16.62	3.36	15.34	3.57	14.60	3.62	11.63	3.81
	20	18.88	3.03	18.39	3.10	15.89	3.44	14.40	3.64	13.70	3.68	10.88	3.83
	21	18.91	3.06	18.35	3.11	15.55	3.37	13.87	3.52	13.19	3.58	10.48	3.84
	22	19.07	3.08	18.55	3.15	15.92	3.50	14.35	3.71	13.49	3.74	10.06	3.86
	24	19.76	3.11	18.96	3.19	14.96	3.55	12.55	3.76	11.87	3.79	9.15	3.90
1.6 + 4.2 + 4.2 + 7.1	16	20.00	2.82	19.59	2.90	17.53	3.25	16.30	3.47	15.50	3.52	12.31	3.73
	18	19.17	2.94	18.74	3.01	16.62	3.35	15.34	3.56	14.60	3.61	11.63	3.80
	20	18.88	3.02	18.39	3.09	15.89	3.43	14.40	3.63	13.70	3.67	10.88	3.81
	21	18.91	3.05	18.35	3.10	15.55	3.36	13.87	3.51	13.19	3.58	10.48	3.83
	22	19.07	3.08	18.55	3.15	15.92	3.49	14.35	3.70	13.49	3.73	10.06	3.85
	24	19.76	3.10	18.96	3.18	14.96	3.54	12.55	3.75	11.87	3.78	9.15	3.89
1.6 + 4.2 + 5.0 + 5.0	16	20.00	2.79	19.59	2.86	17.53	3.21	16.30	3.42	15.50	3.47	12.31	3.67
	18	19.17	2.90	18.74	2.97	16.62	3.31	15.34	3.51	14.60	3.56	11.63	3.75
	20	18.88	2.98	18.39	3.05	15.89	3.38	14.40	3.58	13.70	3.62	10.88	3.76
	21	18.91	3.01	18.35	3.06	15.55	3.31	13.87	3.46	13.19	3.53	10.48	3.78
	22	19.07	3.03	18.55	3.10	15.92	3.44	14.35	3.65	13.49	3.68	10.06	3.80
	24	19.76	3.06	18.96	3.13	14.96	3.49	12.55	3.70	11.87	3.73	9.15	3.83
1.6 + 4.2 + 5.0 + 6.0	16	20.00	2.79	19.59	2.86	17.53	3.21	16.30	3.42	15.50	3.47	12.31	3.67
	18	19.17	2.90	18.74	2.97	16.62	3.31	15.34	3.51	14.60	3.56	11.63	3.75
	20	18.88	2.98	18.39	3.05	15.89	3.38	14.40	3.58	13.70	3.62	10.88	3.76
	21	18.91	3.01	18.35	3.06	15.55	3.31	13.87	3.46	13.19	3.53	10.48	3.78
	22	19.07	3.03	18.55	3.10	15.92	3.44	14.35	3.65	13.49	3.68	10.06	3.80
	24	19.76	3.06	18.96	3.13	14.96	3.49	12.55	3.70	11.87	3.73	9.15	3.83



Combination (Capacity)	Indoor Air Temp. °C DB	Outdoor Air Temp. °C									
		0/-1		-5/-6		-7/-8		-10/-11		-15/-	
		Total Q	Input Power	Total Q	Input Power	Total Q	Input Power	Total Q	Input Power	Total Q	Input Power
1.6 + 4.2 + 4.2 + 4.2	16	11.95	3.77	11.05	3.65	10.69	3.60	10.27	3.47	9.58	3.27
	18	11.32	3.83	10.54	3.68	9.85	3.62	10.07	3.51	9.81	3.33
	20	10.67	3.85	10.14	3.70	9.93	3.64	9.89	3.56	9.84	3.42
	21	10.23	3.87	9.61	3.72	9.36	3.66	9.51	3.58	9.77	3.46
	22	10.00	3.88	9.85	3.73	9.79	3.67	9.74	3.61	9.64	3.50
	24	9.30	3.93	9.66	3.78	9.81	3.72	9.60	3.67	9.26	3.59
1.6 + 4.2 + 4.2 + 5.0	16	11.95	3.69	11.05	3.57	10.69	3.52	10.27	3.40	9.58	3.20
	18	11.32	3.75	10.54	3.60	9.85	3.54	10.07	3.43	9.81	3.26
	20	10.67	3.77	10.14	3.62	9.93	3.56	9.89	3.48	9.84	3.35
	21	10.23	3.78	9.61	3.64	9.36	3.58	9.51	3.51	9.77	3.39
	22	10.00	3.80	9.85	3.65	9.79	3.60	9.74	3.53	9.64	3.43
	24	9.30	3.84	9.66	3.70	9.81	3.64	9.60	3.59	9.26	3.51
1.6 + 4.2 + 4.2 + 6.0	16	11.95	3.69	11.05	3.57	10.69	3.52	10.27	3.40	9.58	3.20
	18	11.32	3.75	10.54	3.60	9.85	3.54	10.07	3.43	9.81	3.26
	20	10.67	3.77	10.14	3.62	9.93	3.56	9.89	3.48	9.84	3.35
	21	10.23	3.78	9.61	3.64	9.36	3.58	9.51	3.51	9.77	3.39
	22	10.00	3.80	9.85	3.65	9.79	3.60	9.74	3.53	9.64	3.43
	24	9.30	3.84	9.66	3.70	9.81	3.64	9.60	3.59	9.26	3.51
1.6 + 4.2 + 4.2 + 7.1	16	11.95	3.68	11.05	3.56	10.69	3.51	10.27	3.39	9.58	3.19
	18	11.32	3.74	10.54	3.59	9.85	3.53	10.07	3.42	9.81	3.25
	20	10.67	3.76	10.14	3.61	9.93	3.55	9.89	3.47	9.84	3.34
	21	10.23	3.77	9.61	3.63	9.36	3.57	9.51	3.50	9.77	3.38
	22	10.00	3.79	9.85	3.64	9.79	3.59	9.74	3.52	9.64	3.42
	24	9.30	3.83	9.66	3.69	9.81	3.63	9.60	3.58	9.26	3.50
1.6 + 4.2 + 5.0 + 5.0	16	11.95	3.63	11.05	3.51	10.69	3.46	10.27	3.34	9.58	3.14
	18	11.32	3.69	10.54	3.54	9.85	3.48	10.07	3.38	9.81	3.20
	20	10.67	3.70	10.14	3.56	9.93	3.50	9.89	3.42	9.84	3.29
	21	10.23	3.72	9.61	3.58	9.36	3.52	9.51	3.45	9.77	3.33
	22	10.00	3.74	9.85	3.59	9.79	3.54	9.74	3.47	9.64	3.37
	24	9.30	3.78	9.66	3.64	9.81	3.58	9.60	3.53	9.26	3.45
1.6 + 4.2 + 5.0 + 6.0	16	11.95	3.63	11.05	3.51	10.69	3.46	10.27	3.34	9.58	3.14
	18	11.32	3.69	10.54	3.54	9.85	3.48	10.07	3.38	9.81	3.20
	20	10.67	3.70	10.14	3.56	9.93	3.50	9.89	3.42	9.84	3.29
	21	10.23	3.72	9.61	3.58	9.36	3.52	9.51	3.45	9.77	3.33
	22	10.00	3.74	9.85	3.59	9.79	3.54	9.74	3.47	9.64	3.37
	24	9.30	3.78	9.66	3.64	9.81	3.58	9.60	3.53	9.26	3.45

Combination (Capacity)	Indoor Air Temp. °C DB	Outdoor Air Temp. °C											
		16/15		15/14		10/9		7/6		6/5		2/1	
		Total Q	Input Power	Total Q	Input Power	Total Q	Input Power	Total Q	Input Power	Total Q	Input Power	Total Q	Input Power
1.6 + 4.2 + 5.0 + 7.1	16	20.00	2.77	19.59	2.84	17.53	3.19	16.30	3.40	15.50	3.45	12.31	3.65
	18	19.17	2.89	18.74	2.95	16.62	3.29	15.34	3.49	14.60	3.54	11.63	3.72
	20	18.88	2.96	18.39	3.03	15.89	3.36	14.40	3.56	13.70	3.60	10.88	3.74
	21	18.91	3.00	18.35	3.04	15.55	3.29	13.87	3.44	13.19	3.51	10.48	3.76
	22	19.07	3.02	18.55	3.08	15.92	3.42	14.35	3.63	13.49	3.66	10.06	3.77
	24	19.76	3.04	18.96	3.12	14.96	3.47	12.55	3.68	11.87	3.71	9.15	3.81
1.6 + 4.2 + 6.0 + 6.0	16	20.00	2.79	19.59	2.86	17.53	3.21	16.30	3.42	15.50	3.47	12.31	3.67
	18	19.17	2.90	18.74	2.97	16.62	3.31	15.34	3.51	14.60	3.56	11.63	3.75
	20	18.88	2.98	18.39	3.05	15.89	3.38	14.40	3.58	13.70	3.62	10.88	3.76
	21	18.91	3.01	18.35	3.06	15.55	3.31	13.87	3.46	13.19	3.53	10.48	3.78
	22	19.07	3.03	18.55	3.10	15.92	3.44	14.35	3.65	13.49	3.68	10.06	3.80
	24	19.76	3.06	18.96	3.13	14.96	3.49	12.55	3.70	11.87	3.73	9.15	3.83
1.6 + 5.0 + 5.0 + 5.0	16	20.00	2.79	19.59	2.86	17.53	3.21	16.30	3.42	15.50	3.47	12.31	3.67
	18	19.17	2.90	18.74	2.97	16.62	3.31	15.34	3.51	14.60	3.56	11.63	3.75
	20	18.88	2.98	18.39	3.05	15.89	3.38	14.40	3.58	13.70	3.62	10.88	3.76
	21	18.91	3.01	18.35	3.06	15.55	3.31	13.87	3.46	13.19	3.53	10.48	3.78
	22	19.07	3.03	18.55	3.10	15.92	3.44	14.35	3.65	13.49	3.68	10.06	3.80
	24	19.76	3.06	18.96	3.13	14.96	3.49	12.55	3.70	11.87	3.73	9.15	3.83
1.6 + 5.0 + 5.0 + 6.0	16	20.00	2.79	19.59	2.86	17.53	3.21	16.30	3.42	15.50	3.47	12.31	3.67
	18	19.17	2.90	18.74	2.97	16.62	3.31	15.34	3.51	14.60	3.56	11.63	3.75
	20	18.88	2.98	18.39	3.05	15.89	3.38	14.40	3.58	13.70	3.62	10.88	3.76
	21	18.91	3.01	18.35	3.06	15.55	3.31	13.87	3.46	13.19	3.53	10.48	3.78
	22	19.07	3.03	18.55	3.10	15.92	3.44	14.35	3.65	13.49	3.68	10.06	3.80
	24	19.76	3.06	18.96	3.13	14.96	3.49	12.55	3.70	11.87	3.73	9.15	3.83
2.0 + 2.0 + 2.0 + 2.0	16	19.72	2.95	19.32	3.02	17.29	3.40	16.07	3.62	15.29	3.67	12.14	3.89
	18	18.90	3.07	18.48	3.14	16.39	3.50	15.13	3.71	14.40	3.76	11.47	3.97
	20	18.62	3.15	18.13	3.22	15.67	3.58	14.20	3.79	13.51	3.83	10.73	3.98
	21	18.65	3.19	18.09	3.24	15.33	3.51	13.67	3.67	13.01	3.73	10.34	4.00
	22	18.80	3.21	18.29	3.28	15.70	3.64	14.15	3.86	13.30	3.89	9.92	4.02
	24	19.49	3.24	18.70	3.32	14.75	3.69	12.38	3.92	11.71	3.95	9.03	4.06
2.0 + 2.0 + 2.0 + 2.5	16	19.72	2.95	19.32	3.02	17.29	3.40	16.07	3.62	15.29	3.67	12.14	3.89
	18	18.90	3.07	18.48	3.14	16.39	3.50	15.13	3.71	14.40	3.76	11.47	3.97
	20	18.62	3.15	18.13	3.22	15.67	3.58	14.20	3.79	13.51	3.83	10.73	3.98
	21	18.65	3.19	18.09	3.24	15.33	3.51	13.67	3.67	13.01	3.73	10.34	4.00
	22	18.80	3.21	18.29	3.28	15.70	3.64	14.15	3.86	13.30	3.89	9.92	4.02
	24	19.49	3.24	18.70	3.32	14.75	3.69	12.38	3.92	11.71	3.95	9.03	4.06

Combination (Capacity)	Indoor Air Temp. °C DB	Outdoor Air Temp. °C									
		0/-1		-5/-6		-7/-8		-10/-11		-15/-	
		Total Q	Input Power	Total Q	Input Power	Total Q	Input Power	Total Q	Input Power	Total Q	Input Power
1.6 + 4.2 + 5.0 + 7.1	16	11.95	3.61	11.05	3.49	10.69	3.44	10.27	3.33	9.58	3.13
	18	11.32	3.67	10.54	3.52	9.85	3.46	10.07	3.36	9.81	3.19
	20	10.67	3.68	10.14	3.54	9.93	3.48	9.89	3.41	9.84	3.27
	21	10.23	3.70	9.61	3.56	9.36	3.50	9.51	3.43	9.77	3.31
	22	10.00	3.72	9.85	3.57	9.79	3.52	9.74	3.45	9.64	3.35
	24	9.30	3.76	9.66	3.62	9.81	3.56	9.60	3.51	9.26	3.43
1.6 + 4.2 + 6.0 + 6.0	16	11.95	3.63	11.05	3.51	10.69	3.46	10.27	3.34	9.58	3.14
	18	11.32	3.69	10.54	3.54	9.85	3.48	10.07	3.38	9.81	3.20
	20	10.67	3.70	10.14	3.56	9.93	3.50	9.89	3.42	9.84	3.29
	21	10.23	3.72	9.61	3.58	9.36	3.52	9.51	3.45	9.77	3.33
	22	10.00	3.74	9.85	3.59	9.79	3.54	9.74	3.47	9.64	3.37
	24	9.30	3.78	9.66	3.64	9.81	3.58	9.60	3.53	9.26	3.45
1.6 + 5.0 + 5.0 + 5.0	16	11.95	3.63	11.05	3.51	10.69	3.46	10.27	3.34	9.58	3.14
	18	11.32	3.69	10.54	3.54	9.85	3.48	10.07	3.38	9.81	3.20
	20	10.67	3.70	10.14	3.56	9.93	3.50	9.89	3.42	9.84	3.29
	21	10.23	3.72	9.61	3.58	9.36	3.52	9.51	3.45	9.77	3.33
	22	10.00	3.74	9.85	3.59	9.79	3.54	9.74	3.47	9.64	3.37
	24	9.30	3.78	9.66	3.64	9.81	3.58	9.60	3.53	9.26	3.45
1.6 + 5.0 + 5.0 + 6.0	16	11.95	3.63	11.05	3.51	10.69	3.46	10.27	3.34	9.58	3.14
	18	11.32	3.69	10.54	3.54	9.85	3.48	10.07	3.38	9.81	3.20
	20	10.67	3.70	10.14	3.56	9.93	3.50	9.89	3.42	9.84	3.29
	21	10.23	3.72	9.61	3.58	9.36	3.52	9.51	3.45	9.77	3.33
	22	10.00	3.74	9.85	3.59	9.79	3.54	9.74	3.47	9.64	3.37
	24	9.30	3.78	9.66	3.64	9.81	3.58	9.60	3.53	9.26	3.45
2.0 + 2.0 + 2.0 + 2.0	16	11.79	3.84	10.90	3.72	10.54	3.67	10.13	3.54	9.45	3.33
	18	11.16	3.90	10.39	3.75	9.71	3.68	9.93	3.58	9.67	3.39
	20	10.52	3.92	10.00	3.77	9.79	3.71	9.75	3.63	9.70	3.49
	21	10.09	3.94	9.47	3.79	9.23	3.73	9.38	3.65	9.63	3.53
	22	9.86	3.96	9.71	3.80	9.66	3.74	9.60	3.68	9.51	3.57
	24	9.17	4.00	9.53	3.85	9.67	3.79	9.47	3.74	9.13	3.66
2.0 + 2.0 + 2.0 + 2.5	16	11.79	3.84	10.90	3.72	10.54	3.67	10.13	3.54	9.45	3.33
	18	11.16	3.90	10.39	3.75	9.71	3.68	9.93	3.58	9.67	3.39
	20	10.52	3.92	10.00	3.77	9.79	3.71	9.75	3.63	9.70	3.49
	21	10.09	3.94	9.47	3.79	9.23	3.73	9.38	3.65	9.63	3.53
	22	9.86	3.96	9.71	3.80	9.66	3.74	9.60	3.68	9.51	3.57
	24	9.17	4.00	9.53	3.85	9.67	3.79	9.47	3.74	9.13	3.66

Combination (Capacity)	Indoor Air Temp. °C DB	Outdoor Air Temp. °C											
		16/15		15/14		10/9		7/6		6/5		2/1	
		Total Q	Input Power	Total Q	Input Power	Total Q	Input Power	Total Q	Input Power	Total Q	Input Power	Total Q	Input Power
2.0 + 2.0 + 2.0 + 3.5	16	19.72	2.93	19.32	3.00	17.29	3.37	16.07	3.59	15.29	3.65	12.14	3.86
	18	18.90	3.05	18.48	3.12	16.39	3.47	15.13	3.68	14.40	3.73	11.47	3.93
	20	18.62	3.13	18.13	3.20	15.67	3.55	14.20	3.76	13.51	3.80	10.73	3.95
	21	18.65	3.16	18.09	3.22	15.33	3.48	13.67	3.64	13.01	3.70	10.34	3.97
	22	18.80	3.19	18.29	3.26	15.70	3.62	14.15	3.83	13.30	3.86	9.92	3.99
	24	19.49	3.22	18.70	3.29	14.75	3.66	12.38	3.89	11.71	3.92	9.03	4.03
2.0 + 2.0 + 2.0 + 4.2	16	19.72	2.91	19.32	2.98	17.29	3.35	16.07	3.57	15.29	3.63	12.14	3.84
	18	18.90	3.03	18.48	3.10	16.39	3.45	15.13	3.67	14.40	3.71	11.47	3.91
	20	18.62	3.11	18.13	3.18	15.67	3.53	14.20	3.74	13.51	3.78	10.73	3.93
	21	18.65	3.15	18.09	3.20	15.33	3.46	13.67	3.62	13.01	3.68	10.34	3.95
	22	18.80	3.17	18.29	3.24	15.70	3.60	14.15	3.81	13.30	3.84	9.92	3.96
	24	19.49	3.20	18.70	3.27	14.75	3.64	12.38	3.87	11.71	3.89	9.03	4.01
2.0 + 2.0 + 2.0 + 5.0	16	19.72	2.80	19.32	2.87	17.29	3.23	16.07	3.44	15.29	3.49	12.14	3.69
	18	18.90	2.92	18.48	2.99	16.39	3.32	15.13	3.53	14.40	3.58	11.47	3.77
	20	18.62	3.00	18.13	3.06	15.67	3.40	14.20	3.60	13.51	3.64	10.73	3.78
	21	18.65	3.03	18.09	3.08	15.33	3.33	13.67	3.48	13.01	3.55	10.34	3.80
	22	18.80	3.05	18.29	3.12	15.70	3.46	14.15	3.67	13.30	3.70	9.92	3.82
	24	19.49	3.08	18.70	3.15	14.75	3.51	12.38	3.72	11.71	3.75	9.03	3.86
2.0 + 2.0 + 2.0 + 6.0	16	19.72	2.80	19.32	2.87	17.29	3.23	16.07	3.44	15.29	3.49	12.14	3.69
	18	18.90	2.92	18.48	2.99	16.39	3.32	15.13	3.53	14.40	3.58	11.47	3.77
	20	18.62	3.00	18.13	3.06	15.67	3.40	14.20	3.60	13.51	3.64	10.73	3.78
	21	18.65	3.03	18.09	3.08	15.33	3.33	13.67	3.48	13.01	3.55	10.34	3.80
	22	18.80	3.05	18.29	3.12	15.70	3.46	14.15	3.67	13.30	3.70	9.92	3.82
	24	19.49	3.08	18.70	3.15	14.75	3.51	12.38	3.72	11.71	3.75	9.03	3.86
2.0 + 2.0 + 2.0 + 7.1	16	20.00	2.83	19.59	2.90	17.53	3.26	16.30	3.48	15.50	3.53	12.31	3.74
	18	19.17	2.95	18.74	3.02	16.62	3.36	15.34	3.57	14.60	3.62	11.63	3.81
	20	18.88	3.03	18.39	3.10	15.89	3.44	14.40	3.64	13.70	3.68	10.88	3.83
	21	18.91	3.06	18.35	3.11	15.55	3.37	13.87	3.52	13.19	3.58	10.48	3.84
	22	19.07	3.08	18.55	3.15	15.92	3.50	14.35	3.71	13.49	3.74	10.06	3.86
	24	19.76	3.11	18.96	3.19	14.96	3.55	12.55	3.76	11.87	3.79	9.15	3.90
2.0 + 2.0 + 2.5 + 2.5	16	19.72	2.95	19.32	3.02	17.29	3.40	16.07	3.62	15.29	3.67	12.14	3.89
	18	18.90	3.07	18.48	3.14	16.39	3.50	15.13	3.71	14.40	3.76	11.47	3.97
	20	18.62	3.15	18.13	3.22	15.67	3.58	14.20	3.79	13.51	3.83	10.73	3.98
	21	18.65	3.19	18.09	3.24	15.33	3.51	13.67	3.67	13.01	3.73	10.34	4.00
	22	18.80	3.21	18.29	3.28	15.70	3.64	14.15	3.86	13.30	3.89	9.92	4.02
	24	19.49	3.24	18.70	3.32	14.75	3.69	12.38	3.92	11.71	3.95	9.03	4.06

Combination (Capacity)	Indoor Air Temp. °C DB	Outdoor Air Temp. °C									
		0/-1		-5/-6		-7/-8		-10/-11		-15/-	
		Total Q	Input Power	Total Q	Input Power	Total Q	Input Power	Total Q	Input Power	Total Q	Input Power
2.0 + 2.0 + 2.0 + 3.5	16	11.79	3.81	10.90	3.69	10.54	3.64	10.13	3.51	9.45	3.30
	18	11.16	3.87	10.39	3.72	9.71	3.66	9.93	3.55	9.67	3.37
	20	10.52	3.89	10.00	3.74	9.79	3.68	9.75	3.60	9.70	3.46
	21	10.09	3.91	9.47	3.76	9.23	3.70	9.38	3.62	9.63	3.50
	22	9.86	3.93	9.71	3.77	9.66	3.71	9.60	3.65	9.51	3.54
	24	9.17	3.97	9.53	3.82	9.67	3.76	9.47	3.71	9.13	3.63
2.0 + 2.0 + 2.0 + 4.2	16	11.79	3.79	10.90	3.67	10.54	3.62	10.13	3.49	9.45	3.28
	18	11.16	3.85	10.39	3.70	9.71	3.64	9.93	3.53	9.67	3.35
	20	10.52	3.87	10.00	3.72	9.79	3.66	9.75	3.58	9.70	3.44
	21	10.09	3.89	9.47	3.74	9.23	3.68	9.38	3.60	9.63	3.48
	22	9.86	3.90	9.71	3.75	9.66	3.69	9.60	3.63	9.51	3.52
	24	9.17	3.95	9.53	3.80	9.67	3.74	9.47	3.69	9.13	3.61
2.0 + 2.0 + 2.0 + 5.0	16	11.79	3.65	10.90	3.53	10.54	3.48	10.13	3.36	9.45	3.16
	18	11.16	3.71	10.39	3.56	9.71	3.50	9.93	3.40	9.67	3.22
	20	10.52	3.73	10.00	3.58	9.79	3.52	9.75	3.44	9.70	3.31
	21	10.09	3.74	9.47	3.60	9.23	3.54	9.38	3.47	9.63	3.35
	22	9.86	3.76	9.71	3.61	9.66	3.56	9.60	3.49	9.51	3.39
	24	9.17	3.80	9.53	3.66	9.67	3.60	9.47	3.55	9.13	3.47
2.0 + 2.0 + 2.0 + 6.0	16	11.79	3.65	10.90	3.53	10.54	3.48	10.13	3.36	9.45	3.16
	18	11.16	3.71	10.39	3.56	9.71	3.50	9.93	3.40	9.67	3.22
	20	10.52	3.73	10.00	3.58	9.79	3.52	9.75	3.44	9.70	3.31
	21	10.09	3.74	9.47	3.60	9.23	3.54	9.38	3.47	9.63	3.35
	22	9.86	3.76	9.71	3.61	9.66	3.56	9.60	3.49	9.51	3.39
	24	9.17	3.80	9.53	3.66	9.67	3.60	9.47	3.55	9.13	3.47
2.0 + 2.0 + 2.0 + 7.1	16	11.95	3.69	11.05	3.57	10.69	3.52	10.27	3.40	9.58	3.20
	18	11.32	3.75	10.54	3.60	9.85	3.54	10.07	3.43	9.81	3.26
	20	10.67	3.77	10.14	3.62	9.93	3.56	9.89	3.48	9.84	3.35
	21	10.23	3.78	9.61	3.64	9.36	3.58	9.51	3.51	9.77	3.39
	22	10.00	3.80	9.85	3.65	9.79	3.60	9.74	3.53	9.64	3.43
	24	9.30	3.84	9.66	3.70	9.81	3.64	9.60	3.59	9.26	3.51
2.0 + 2.0 + 2.5 + 2.5	16	11.79	3.84	10.90	3.72	10.54	3.67	10.13	3.54	9.45	3.33
	18	11.16	3.90	10.39	3.75	9.71	3.68	9.93	3.58	9.67	3.39
	20	10.52	3.92	10.00	3.77	9.79	3.71	9.75	3.63	9.70	3.49
	21	10.09	3.94	9.47	3.79	9.23	3.73	9.38	3.65	9.63	3.53
	22	9.86	3.96	9.71	3.80	9.66	3.74	9.60	3.68	9.51	3.57
	24	9.17	4.00	9.53	3.85	9.67	3.79	9.47	3.74	9.13	3.66

Combination (Capacity)	Indoor Air Temp. °C DB	Outdoor Air Temp. °C											
		16/15		15/14		10/9		7/6		6/5		2/1	
		Total Q	Input Power	Total Q	Input Power	Total Q	Input Power	Total Q	Input Power	Total Q	Input Power	Total Q	Input Power
2.0 + 2.0 + 2.5 + 3.5	16	19.72	2.93	19.32	3.00	17.29	3.37	16.07	3.59	15.29	3.65	12.14	3.86
	18	18.90	3.05	18.48	3.12	16.39	3.47	15.13	3.68	14.40	3.73	11.47	3.93
	20	18.62	3.13	18.13	3.20	15.67	3.55	14.20	3.76	13.51	3.80	10.73	3.95
	21	18.65	3.16	18.09	3.22	15.33	3.48	13.67	3.64	13.01	3.70	10.34	3.97
	22	18.80	3.19	18.29	3.26	15.70	3.62	14.15	3.83	13.30	3.86	9.92	3.99
	24	19.49	3.22	18.70	3.29	14.75	3.66	12.38	3.89	11.71	3.92	9.03	4.03
2.0 + 2.0 + 2.5 + 4.2	16	19.72	2.91	19.32	2.98	17.29	3.35	16.07	3.57	15.29	3.63	12.14	3.84
	18	18.90	3.03	18.48	3.10	16.39	3.45	15.13	3.67	14.40	3.71	11.47	3.91
	20	18.62	3.11	18.13	3.18	15.67	3.53	14.20	3.74	13.51	3.78	10.73	3.93
	21	18.65	3.15	18.09	3.20	15.33	3.46	13.67	3.62	13.01	3.68	10.34	3.95
	22	18.80	3.17	18.29	3.24	15.70	3.60	14.15	3.81	13.30	3.84	9.92	3.96
	24	19.49	3.20	18.70	3.27	14.75	3.64	12.38	3.87	11.71	3.89	9.03	4.01
2.0 + 2.0 + 2.5 + 5.0	16	19.72	2.80	19.32	2.87	17.29	3.23	16.07	3.44	15.29	3.49	12.14	3.69
	18	18.90	2.92	18.48	2.99	16.39	3.32	15.13	3.53	14.40	3.58	11.47	3.77
	20	18.62	3.00	18.13	3.06	15.67	3.40	14.20	3.60	13.51	3.64	10.73	3.78
	21	18.65	3.03	18.09	3.08	15.33	3.33	13.67	3.48	13.01	3.55	10.34	3.80
	22	18.80	3.05	18.29	3.12	15.70	3.46	14.15	3.67	13.30	3.70	9.92	3.82
	24	19.49	3.08	18.70	3.15	14.75	3.51	12.38	3.72	11.71	3.75	9.03	3.86
2.0 + 2.0 + 2.5 + 6.0	16	19.72	2.80	19.32	2.87	17.29	3.23	16.07	3.44	15.29	3.49	12.14	3.69
	18	18.90	2.92	18.48	2.99	16.39	3.32	15.13	3.53	14.40	3.58	11.47	3.77
	20	18.62	3.00	18.13	3.06	15.67	3.40	14.20	3.60	13.51	3.64	10.73	3.78
	21	18.65	3.03	18.09	3.08	15.33	3.33	13.67	3.48	13.01	3.55	10.34	3.80
	22	18.80	3.05	18.29	3.12	15.70	3.46	14.15	3.67	13.30	3.70	9.92	3.82
	24	19.49	3.08	18.70	3.15	14.75	3.51	12.38	3.72	11.71	3.75	9.03	3.86
2.0 + 2.0 + 2.5 + 7.1	16	20.00	2.83	19.59	2.90	17.53	3.26	16.30	3.48	15.50	3.53	12.31	3.74
	18	19.17	2.95	18.74	3.02	16.62	3.36	15.34	3.57	14.60	3.62	11.63	3.81
	20	18.88	3.03	18.39	3.10	15.89	3.44	14.40	3.64	13.70	3.68	10.88	3.83
	21	18.91	3.06	18.35	3.11	15.55	3.37	13.87	3.52	13.19	3.58	10.48	3.84
	22	19.07	3.08	18.55	3.15	15.92	3.50	14.35	3.71	13.49	3.74	10.06	3.86
	24	19.76	3.11	18.96	3.19	14.96	3.55	12.55	3.76	11.87	3.79	9.15	3.90
2.0 + 2.0 + 3.5 + 3.5	16	19.72	2.85	19.32	2.92	17.29	3.28	16.07	3.50	15.29	3.55	12.14	3.76
	18	18.90	2.97	18.48	3.04	16.39	3.38	15.13	3.59	14.40	3.64	11.47	3.83
	20	18.62	3.05	18.13	3.11	15.67	3.46	14.20	3.66	13.51	3.70	10.73	3.85
	21	18.65	3.08	18.09	3.13	15.33	3.39	13.67	3.54	13.01	3.60	10.34	3.86
	22	18.80	3.10	18.29	3.17	15.70	3.52	14.15	3.73	13.30	3.76	9.92	3.88
	24	19.49	3.13	18.70	3.20	14.75	3.57	12.38	3.78	11.71	3.81	9.03	3.92

Combination (Capacity)	Indoor Air Temp. °C DB	Outdoor Air Temp. °C									
		0/-1		-5/-6		-7/-8		-10/-11		-15/-	
		Total Q	Input Power	Total Q	Input Power	Total Q	Input Power	Total Q	Input Power	Total Q	Input Power
2.0 + 2.0 + 2.5 + 3.5	16	11.79	3.81	10.90	3.69	10.54	3.64	10.13	3.51	9.45	3.30
	18	11.16	3.87	10.39	3.72	9.71	3.66	9.93	3.55	9.67	3.37
	20	10.52	3.89	10.00	3.74	9.79	3.68	9.75	3.60	9.70	3.46
	21	10.09	3.91	9.47	3.76	9.23	3.70	9.38	3.62	9.63	3.50
	22	9.86	3.93	9.71	3.77	9.66	3.71	9.60	3.65	9.51	3.54
	24	9.17	3.97	9.53	3.82	9.67	3.76	9.47	3.71	9.13	3.63
2.0 + 2.0 + 2.5 + 4.2	16	11.79	3.79	10.90	3.67	10.54	3.62	10.13	3.49	9.45	3.28
	18	11.16	3.85	10.39	3.70	9.71	3.64	9.93	3.53	9.67	3.35
	20	10.52	3.87	10.00	3.72	9.79	3.66	9.75	3.58	9.70	3.44
	21	10.09	3.89	9.47	3.74	9.23	3.68	9.38	3.60	9.63	3.48
	22	9.86	3.90	9.71	3.75	9.66	3.69	9.60	3.63	9.51	3.52
	24	9.17	3.95	9.53	3.80	9.67	3.74	9.47	3.69	9.13	3.61
2.0 + 2.0 + 2.5 + 5.0	16	11.79	3.65	10.90	3.53	10.54	3.48	10.13	3.36	9.45	3.16
	18	11.16	3.71	10.39	3.56	9.71	3.50	9.93	3.40	9.67	3.22
	20	10.52	3.73	10.00	3.58	9.79	3.52	9.75	3.44	9.70	3.31
	21	10.09	3.74	9.47	3.60	9.23	3.54	9.38	3.47	9.63	3.35
	22	9.86	3.76	9.71	3.61	9.66	3.56	9.60	3.49	9.51	3.39
	24	9.17	3.80	9.53	3.66	9.67	3.60	9.47	3.55	9.13	3.47
2.0 + 2.0 + 2.5 + 6.0	16	11.79	3.65	10.90	3.53	10.54	3.48	10.13	3.36	9.45	3.16
	18	11.16	3.71	10.39	3.56	9.71	3.50	9.93	3.40	9.67	3.22
	20	10.52	3.73	10.00	3.58	9.79	3.52	9.75	3.44	9.70	3.31
	21	10.09	3.74	9.47	3.60	9.23	3.54	9.38	3.47	9.63	3.35
	22	9.86	3.76	9.71	3.61	9.66	3.56	9.60	3.49	9.51	3.39
	24	9.17	3.80	9.53	3.66	9.67	3.60	9.47	3.55	9.13	3.47
2.0 + 2.0 + 2.5 + 7.1	16	11.95	3.69	11.05	3.57	10.69	3.52	10.27	3.40	9.58	3.20
	18	11.32	3.75	10.54	3.60	9.85	3.54	10.07	3.43	9.81	3.26
	20	10.67	3.77	10.14	3.62	9.93	3.56	9.89	3.48	9.84	3.35
	21	10.23	3.78	9.61	3.64	9.36	3.58	9.51	3.51	9.77	3.39
	22	10.00	3.80	9.85	3.65	9.79	3.60	9.74	3.53	9.64	3.43
	24	9.30	3.84	9.66	3.70	9.81	3.64	9.60	3.59	9.26	3.51
2.0 + 2.0 + 3.5 + 3.5	16	11.79	3.71	10.90	3.59	10.54	3.54	10.13	3.42	9.45	3.21
	18	11.16	3.77	10.39	3.62	9.71	3.56	9.93	3.45	9.67	3.28
	20	10.52	3.79	10.00	3.64	9.79	3.58	9.75	3.50	9.70	3.37
	21	10.09	3.80	9.47	3.66	9.23	3.60	9.38	3.53	9.63	3.41
	22	9.86	3.82	9.71	3.67	9.66	3.61	9.60	3.55	9.51	3.45
	24	9.17	3.86	9.53	3.72	9.67	3.66	9.47	3.61	9.13	3.53

Combination (Capacity)	Indoor Air Temp. °C DB	Outdoor Air Temp. °C											
		16/15		15/14		10/9		7/6		6/5		2/1	
		Total Q	Input Power	Total Q	Input Power	Total Q	Input Power	Total Q	Input Power	Total Q	Input Power	Total Q	Input Power
2.0 + 2.0 + 3.5 + 4.2	16	19.72	2.84	19.32	2.91	17.29	3.27	16.07	3.49	15.29	3.54	12.14	3.75
	18	18.90	2.96	18.48	3.03	16.39	3.37	15.13	3.58	14.40	3.63	11.47	3.82
	20	18.62	3.04	18.13	3.11	15.67	3.45	14.20	3.65	13.51	3.69	10.73	3.84
	21	18.65	3.07	18.09	3.12	15.33	3.38	13.67	3.53	13.01	3.59	10.34	3.85
	22	18.80	3.09	18.29	3.16	15.70	3.51	14.15	3.72	13.30	3.75	9.92	3.87
	24	19.49	3.12	18.70	3.19	14.75	3.56	12.38	3.77	11.71	3.80	9.03	3.91
2.0 + 2.0 + 3.5 + 5.0	16	19.72	2.78	19.32	2.85	17.29	3.20	16.07	3.41	15.29	3.46	12.14	3.66
	18	18.90	2.89	18.48	2.96	16.39	3.30	15.13	3.50	14.40	3.55	11.47	3.74
	20	18.62	2.97	18.13	3.04	15.67	3.37	14.20	3.57	13.51	3.61	10.73	3.75
	21	18.65	3.00	18.09	3.05	15.33	3.30	13.67	3.45	13.01	3.52	10.34	3.77
	22	18.80	3.03	18.29	3.09	15.70	3.43	14.15	3.64	13.30	3.67	9.92	3.78
	24	19.49	3.05	18.70	3.12	14.75	3.48	12.38	3.69	11.71	3.72	9.03	3.82
2.0 + 2.0 + 3.5 + 6.0	16	20.00	2.82	19.59	2.90	17.53	3.25	16.30	3.47	15.50	3.52	12.31	3.73
	18	19.17	2.94	18.74	3.01	16.62	3.35	15.34	3.56	14.60	3.61	11.63	3.80
	20	18.88	3.02	18.39	3.09	15.89	3.43	14.40	3.63	13.70	3.67	10.88	3.81
	21	18.91	3.05	18.35	3.10	15.55	3.36	13.87	3.51	13.19	3.58	10.48	3.83
	22	19.07	3.08	18.55	3.15	15.92	3.49	14.35	3.70	13.49	3.73	10.06	3.85
	24	19.76	3.10	18.96	3.18	14.96	3.54	12.55	3.75	11.87	3.78	9.15	3.89
2.0 + 2.0 + 3.5 + 7.1	16	20.00	2.81	19.59	2.88	17.53	3.24	16.30	3.45	15.50	3.50	12.31	3.70
	18	19.17	2.93	18.74	2.99	16.62	3.33	15.34	3.54	14.60	3.59	11.63	3.78
	20	18.88	3.00	18.39	3.07	15.89	3.41	14.40	3.61	13.70	3.65	10.88	3.79
	21	18.91	3.04	18.35	3.09	15.55	3.34	13.87	3.49	13.19	3.56	10.48	3.81
	22	19.07	3.06	18.55	3.13	15.92	3.47	14.35	3.68	13.49	3.71	10.06	3.83
	24	19.76	3.09	18.96	3.16	14.96	3.52	12.55	3.73	11.87	3.76	9.15	3.87
2.0 + 2.0 + 4.2 + 4.2	16	19.72	2.83	19.32	2.90	17.29	3.26	16.07	3.48	15.29	3.53	12.14	3.74
	18	18.90	2.95	18.48	3.02	16.39	3.36	15.13	3.57	14.40	3.62	11.47	3.81
	20	18.62	3.03	18.13	3.10	15.67	3.44	14.20	3.64	13.51	3.68	10.73	3.83
	21	18.65	3.06	18.09	3.11	15.33	3.37	13.67	3.52	13.01	3.58	10.34	3.84
	22	18.80	3.08	18.29	3.15	15.70	3.50	14.15	3.71	13.30	3.74	9.92	3.86
	24	19.49	3.11	18.70	3.19	14.75	3.55	12.38	3.76	11.71	3.79	9.03	3.90
2.0 + 2.0 + 4.2 + 5.0	16	20.00	2.82	19.59	2.89	17.53	3.24	16.30	3.46	15.50	3.51	12.31	3.71
	18	19.17	2.93	18.74	3.00	16.62	3.34	15.34	3.55	14.60	3.60	11.63	3.79
	20	18.88	3.01	18.39	3.08	15.89	3.42	14.40	3.62	13.70	3.66	10.88	3.80
	21	18.91	3.05	18.35	3.10	15.55	3.35	13.87	3.50	13.19	3.57	10.48	3.82
	22	19.07	3.07	18.55	3.14	15.92	3.48	14.35	3.69	13.49	3.72	10.06	3.84
	24	19.76	3.10	18.96	3.17	14.96	3.53	12.55	3.74	11.87	3.77	9.15	3.88



Combination (Capacity)	Indoor Air Temp. °C DB	Outdoor Air Temp. °C									
		0/-1		-5/-6		-7/-8		-10/-11		-15/-	
		Total Q	Input Power	Total Q	Input Power	Total Q	Input Power	Total Q	Input Power	Total Q	Input Power
2.0 + 2.0 + 3.5 + 4.2	16	11.79	3.70	10.90	3.58	10.54	3.53	10.13	3.41	9.45	3.21
	18	11.16	3.76	10.39	3.61	9.71	3.55	9.93	3.44	9.67	3.27
	20	10.52	3.78	10.00	3.63	9.79	3.57	9.75	3.49	9.70	3.36
	21	10.09	3.79	9.47	3.65	9.23	3.59	9.38	3.52	9.63	3.40
	22	9.86	3.81	9.71	3.66	9.66	3.61	9.60	3.54	9.51	3.44
	24	9.17	3.85	9.53	3.71	9.67	3.65	9.47	3.60	9.13	3.52
2.0 + 2.0 + 3.5 + 5.0	16	11.79	3.62	10.90	3.50	10.54	3.45	10.13	3.33	9.45	3.14
	18	11.16	3.68	10.39	3.53	9.71	3.47	9.93	3.37	9.67	3.20
	20	10.52	3.69	10.00	3.55	9.79	3.49	9.75	3.41	9.70	3.28
	21	10.09	3.71	9.47	3.57	9.23	3.51	9.38	3.44	9.63	3.32
	22	9.86	3.73	9.71	3.58	9.66	3.53	9.60	3.46	9.51	3.36
	24	9.17	3.77	9.53	3.63	9.67	3.57	9.47	3.52	9.13	3.44
2.0 + 2.0 + 3.5 + 6.0	16	11.95	3.68	11.05	3.56	10.69	3.51	10.27	3.39	9.58	3.19
	18	11.32	3.74	10.54	3.59	9.85	3.53	10.07	3.42	9.81	3.25
	20	10.67	3.76	10.14	3.61	9.93	3.55	9.89	3.47	9.84	3.34
	21	10.23	3.77	9.61	3.63	9.36	3.57	9.51	3.50	9.77	3.38
	22	10.00	3.79	9.85	3.64	9.79	3.59	9.74	3.52	9.64	3.42
	24	9.30	3.83	9.66	3.69	9.81	3.63	9.60	3.58	9.26	3.50
2.0 + 2.0 + 3.5 + 7.1	16	11.95	3.66	11.05	3.54	10.69	3.49	10.27	3.37	9.58	3.17
	18	11.32	3.72	10.54	3.57	9.85	3.51	10.07	3.41	9.81	3.23
	20	10.67	3.74	10.14	3.59	9.93	3.53	9.89	3.45	9.84	3.32
	21	10.23	3.75	9.61	3.61	9.36	3.55	9.51	3.48	9.77	3.36
	22	10.00	3.77	9.85	3.62	9.79	3.57	9.74	3.50	9.64	3.40
	24	9.30	3.81	9.66	3.67	9.81	3.61	9.60	3.56	9.26	3.48
2.0 + 2.0 + 4.2 + 4.2	16	11.79	3.69	10.90	3.57	10.54	3.52	10.13	3.40	9.45	3.20
	18	11.16	3.75	10.39	3.60	9.71	3.54	9.93	3.43	9.67	3.26
	20	10.52	3.77	10.00	3.62	9.79	3.56	9.75	3.48	9.70	3.35
	21	10.09	3.78	9.47	3.64	9.23	3.58	9.38	3.51	9.63	3.39
	22	9.86	3.80	9.71	3.65	9.66	3.60	9.60	3.53	9.51	3.43
	24	9.17	3.84	9.53	3.70	9.67	3.64	9.47	3.59	9.13	3.51
2.0 + 2.0 + 4.2 + 5.0	16	11.95	3.67	11.05	3.55	10.69	3.50	10.27	3.38	9.58	3.18
	18	11.32	3.73	10.54	3.58	9.85	3.52	10.07	3.42	9.81	3.24
	20	10.67	3.75	10.14	3.60	9.93	3.54	9.89	3.46	9.84	3.33
	21	10.23	3.76	9.61	3.62	9.36	3.56	9.51	3.49	9.77	3.37
	22	10.00	3.78	9.85	3.63	9.79	3.58	9.74	3.51	9.64	3.41
	24	9.30	3.82	9.66	3.68	9.81	3.62	9.60	3.57	9.26	3.49

Combination (Capacity)	Indoor Air Temp. °C DB	Outdoor Air Temp. °C											
		16/15		15/14		10/9		7/6		6/5		2/1	
		Total Q	Input Power	Total Q	Input Power	Total Q	Input Power	Total Q	Input Power	Total Q	Input Power	Total Q	Input Power
2.0 + 2.0 + 4.2 + 6.0	16	20.00	2.82	19.59	2.89	17.53	3.24	16.30	3.46	15.50	3.51	12.31	3.71
	18	19.17	2.93	18.74	3.00	16.62	3.34	15.34	3.55	14.60	3.60	11.63	3.79
	20	18.88	3.01	18.39	3.08	15.89	3.42	14.40	3.62	13.70	3.66	10.88	3.80
	21	18.91	3.05	18.35	3.10	15.55	3.35	13.87	3.50	13.19	3.57	10.48	3.82
	22	19.07	3.07	18.55	3.14	15.92	3.48	14.35	3.69	13.49	3.72	10.06	3.84
	24	19.76	3.10	18.96	3.17	14.96	3.53	12.55	3.74	11.87	3.77	9.15	3.88
2.0 + 2.0 + 4.2 + 7.1	16	20.00	2.85	19.59	2.92	17.53	3.28	16.30	3.50	15.50	3.55	12.31	3.76
	18	19.17	2.97	18.74	3.04	16.62	3.38	15.34	3.59	14.60	3.64	11.63	3.83
	20	18.88	3.05	18.39	3.11	15.89	3.46	14.40	3.66	13.70	3.70	10.88	3.85
	21	18.91	3.08	18.35	3.13	15.55	3.39	13.87	3.54	13.19	3.60	10.48	3.86
	22	19.07	3.10	18.55	3.17	15.92	3.52	14.35	3.73	13.49	3.76	10.06	3.88
	24	19.76	3.13	18.96	3.20	14.96	3.57	12.55	3.78	11.87	3.81	9.15	3.92
2.0 + 2.0 + 5.0 + 5.0	16	20.00	2.80	19.59	2.87	17.53	3.23	16.30	3.44	15.50	3.49	12.31	3.69
	18	19.17	2.92	18.74	2.99	16.62	3.32	15.34	3.53	14.60	3.58	11.63	3.77
	20	18.88	3.00	18.39	3.06	15.89	3.40	14.40	3.60	13.70	3.64	10.88	3.78
	21	18.91	3.03	18.35	3.08	15.55	3.33	13.87	3.48	13.19	3.55	10.48	3.80
	22	19.07	3.05	18.55	3.12	15.92	3.46	14.35	3.67	13.49	3.70	10.06	3.82
	24	19.76	3.08	18.96	3.15	14.96	3.51	12.55	3.72	11.87	3.75	9.15	3.86
2.0 + 2.0 + 5.0 + 6.0	16	20.00	2.80	19.59	2.87	17.53	3.23	16.30	3.44	15.50	3.49	12.31	3.69
	18	19.17	2.92	18.74	2.99	16.62	3.32	15.34	3.53	14.60	3.58	11.63	3.77
	20	18.88	3.00	18.39	3.06	15.89	3.40	14.40	3.60	13.70	3.64	10.88	3.78
	21	18.91	3.03	18.35	3.08	15.55	3.33	13.87	3.48	13.19	3.55	10.48	3.80
	22	19.07	3.05	18.55	3.12	15.92	3.46	14.35	3.67	13.49	3.70	10.06	3.82
	24	19.76	3.08	18.96	3.15	14.96	3.51	12.55	3.72	11.87	3.75	9.15	3.86
2.0 + 2.0 + 5.0 + 7.1	16	20.00	2.79	19.59	2.86	17.53	3.22	16.30	3.43	15.50	3.48	12.31	3.68
	18	19.17	2.91	18.74	2.98	16.62	3.32	15.34	3.52	14.60	3.57	11.63	3.76
	20	18.88	2.99	18.39	3.05	15.89	3.39	14.40	3.59	13.70	3.63	10.88	3.77
	21	18.91	3.02	18.35	3.07	15.55	3.32	13.87	3.47	13.19	3.54	10.48	3.79
	22	19.07	3.04	18.55	3.11	15.92	3.45	14.35	3.66	13.49	3.69	10.06	3.81
	24	19.76	3.07	18.96	3.14	14.96	3.50	12.55	3.71	11.87	3.74	9.15	3.84
2.0 + 2.0 + 6.0 + 6.0	16	20.00	2.80	19.59	2.87	17.53	3.23	16.30	3.44	15.50	3.49	12.31	3.69
	18	19.17	2.92	18.74	2.99	16.62	3.32	15.34	3.53	14.60	3.58	11.63	3.77
	20	18.88	3.00	18.39	3.06	15.89	3.40	14.40	3.60	13.70	3.64	10.88	3.78
	21	18.91	3.03	18.35	3.08	15.55	3.33	13.87	3.48	13.19	3.55	10.48	3.80
	22	19.07	3.05	18.55	3.12	15.92	3.46	14.35	3.67	13.49	3.70	10.06	3.82
	24	19.76	3.08	18.96	3.15	14.96	3.51	12.55	3.72	11.87	3.75	9.15	3.86

Combination (Capacity)	Indoor Air Temp. °C DB	Outdoor Air Temp. °C									
		0/-1		-5/-6		-7/-8		-10/-11		-15/-	
		Total Q	Input Power	Total Q	Input Power	Total Q	Input Power	Total Q	Input Power	Total Q	Input Power
2.0 + 2.0 + 4.2 + 6.0	16	11.95	3.67	11.05	3.55	10.69	3.50	10.27	3.38	9.58	3.18
	18	11.32	3.73	10.54	3.58	9.85	3.52	10.07	3.42	9.81	3.24
	20	10.67	3.75	10.14	3.60	9.93	3.54	9.89	3.46	9.84	3.33
	21	10.23	3.76	9.61	3.62	9.36	3.56	9.51	3.49	9.77	3.37
	22	10.00	3.78	9.85	3.63	9.79	3.58	9.74	3.51	9.64	3.41
	24	9.30	3.82	9.66	3.68	9.81	3.62	9.60	3.57	9.26	3.49
2.0 + 2.0 + 4.2 + 7.1	16	11.95	3.71	11.05	3.59	10.69	3.54	10.27	3.42	9.58	3.21
	18	11.32	3.77	10.54	3.62	9.85	3.56	10.07	3.45	9.81	3.28
	20	10.67	3.79	10.14	3.64	9.93	3.58	9.89	3.50	9.84	3.37
	21	10.23	3.80	9.61	3.66	9.36	3.60	9.51	3.53	9.77	3.41
	22	10.00	3.82	9.85	3.67	9.79	3.61	9.74	3.55	9.64	3.45
	24	9.30	3.86	9.66	3.72	9.81	3.66	9.60	3.61	9.26	3.53
2.0 + 2.0 + 5.0 + 5.0	16	11.95	3.65	11.05	3.53	10.69	3.48	10.27	3.36	9.58	3.16
	18	11.32	3.71	10.54	3.56	9.85	3.50	10.07	3.40	9.81	3.22
	20	10.67	3.73	10.14	3.58	9.93	3.52	9.89	3.44	9.84	3.31
	21	10.23	3.74	9.61	3.60	9.36	3.54	9.51	3.47	9.77	3.35
	22	10.00	3.76	9.85	3.61	9.79	3.56	9.74	3.49	9.64	3.39
	24	9.30	3.80	9.66	3.66	9.81	3.60	9.60	3.55	9.26	3.47
2.0 + 2.0 + 5.0 + 6.0	16	11.95	3.65	11.05	3.53	10.69	3.48	10.27	3.36	9.58	3.16
	18	11.32	3.71	10.54	3.56	9.85	3.50	10.07	3.40	9.81	3.22
	20	10.67	3.73	10.14	3.58	9.93	3.52	9.89	3.44	9.84	3.31
	21	10.23	3.74	9.61	3.60	9.36	3.54	9.51	3.47	9.77	3.35
	22	10.00	3.76	9.85	3.61	9.79	3.56	9.74	3.49	9.64	3.39
	24	9.30	3.80	9.66	3.66	9.81	3.60	9.60	3.55	9.26	3.47
2.0 + 2.0 + 5.0 + 7.1	16	11.95	3.64	11.05	3.52	10.69	3.47	10.27	3.35	9.58	3.15
	18	11.32	3.70	10.54	3.55	9.85	3.49	10.07	3.39	9.81	3.21
	20	10.67	3.71	10.14	3.57	9.93	3.51	9.89	3.43	9.84	3.30
	21	10.23	3.73	9.61	3.59	9.36	3.53	9.51	3.46	9.77	3.34
	22	10.00	3.75	9.85	3.60	9.79	3.55	9.74	3.48	9.64	3.38
	24	9.30	3.79	9.66	3.65	9.81	3.59	9.60	3.54	9.26	3.46
2.0 + 2.0 + 6.0 + 6.0	16	11.95	3.65	11.05	3.53	10.69	3.48	10.27	3.36	9.58	3.16
	18	11.32	3.71	10.54	3.56	9.85	3.50	10.07	3.40	9.81	3.22
	20	10.67	3.73	10.14	3.58	9.93	3.52	9.89	3.44	9.84	3.31
	21	10.23	3.74	9.61	3.60	9.36	3.54	9.51	3.47	9.77	3.35
	22	10.00	3.76	9.85	3.61	9.79	3.56	9.74	3.49	9.64	3.39
	24	9.30	3.80	9.66	3.66	9.81	3.60	9.60	3.55	9.26	3.47

Combination (Capacity)	Indoor Air Temp. °C DB	Outdoor Air Temp. °C											
		16/15		15/14		10/9		7/6		6/5		2/1	
		Total Q	Input Power	Total Q	Input Power	Total Q	Input Power	Total Q	Input Power	Total Q	Input Power	Total Q	Input Power
2.0 + 2.0 + 6.0 + 7.1	16	20.00	2.79	19.59	2.86	17.53	3.22	16.30	3.43	15.50	3.48	12.31	3.68
	18	19.17	2.91	18.74	2.98	16.62	3.32	15.34	3.52	14.60	3.57	11.63	3.76
	20	18.88	2.99	18.39	3.05	15.89	3.39	14.40	3.59	13.70	3.63	10.88	3.77
	21	18.91	3.02	18.35	3.07	15.55	3.32	13.87	3.47	13.19	3.54	10.48	3.79
	22	19.07	3.04	18.55	3.11	15.92	3.45	14.35	3.66	13.49	3.69	10.06	3.81
	24	19.76	3.07	18.96	3.14	14.96	3.50	12.55	3.71	11.87	3.74	9.15	3.84
2.0 + 2.0 + 7.1 + 7.1	16	20.00	2.79	19.59	2.86	17.53	3.21	16.30	3.42	15.50	3.47	12.31	3.67
	18	19.17	2.90	18.74	2.97	16.62	3.31	15.34	3.51	14.60	3.56	11.63	3.75
	20	18.88	2.98	18.39	3.05	15.89	3.38	14.40	3.58	13.70	3.62	10.88	3.76
	21	18.91	3.01	18.35	3.06	15.55	3.31	13.87	3.46	13.19	3.53	10.48	3.78
	22	19.07	3.03	18.55	3.10	15.92	3.44	14.35	3.65	13.49	3.68	10.06	3.80
	24	19.76	3.06	18.96	3.13	14.96	3.49	12.55	3.70	11.87	3.73	9.15	3.83
2.0 + 2.5 + 2.5 + 2.5	16	19.72	2.95	19.32	3.02	17.29	3.40	16.07	3.62	15.29	3.67	12.14	3.89
	18	18.90	3.07	18.48	3.14	16.39	3.50	15.13	3.71	14.40	3.76	11.47	3.97
	20	18.62	3.15	18.13	3.22	15.67	3.58	14.20	3.79	13.51	3.83	10.73	3.98
	21	18.65	3.19	18.09	3.24	15.33	3.51	13.67	3.67	13.01	3.73	10.34	4.00
	22	18.80	3.21	18.29	3.28	15.70	3.64	14.15	3.86	13.30	3.89	9.92	4.02
	24	19.49	3.24	18.70	3.32	14.75	3.69	12.38	3.92	11.71	3.95	9.03	4.06
2.0 + 2.5 + 2.5 + 3.5	16	19.72	2.93	19.32	3.00	17.29	3.37	16.07	3.59	15.29	3.65	12.14	3.86
	18	18.90	3.05	18.48	3.12	16.39	3.47	15.13	3.68	14.40	3.73	11.47	3.93
	20	18.62	3.13	18.13	3.20	15.67	3.55	14.20	3.76	13.51	3.80	10.73	3.95
	21	18.65	3.16	18.09	3.22	15.33	3.48	13.67	3.64	13.01	3.70	10.34	3.97
	22	18.80	3.19	18.29	3.26	15.70	3.62	14.15	3.83	13.30	3.86	9.92	3.99
	24	19.49	3.22	18.70	3.29	14.75	3.66	12.38	3.89	11.71	3.92	9.03	4.03
2.0 + 2.5 + 2.5 + 4.2	16	19.72	2.91	19.32	2.98	17.29	3.35	16.07	3.57	15.29	3.63	12.14	3.84
	18	18.90	3.03	18.48	3.10	16.39	3.45	15.13	3.67	14.40	3.71	11.47	3.91
	20	18.62	3.11	18.13	3.18	15.67	3.53	14.20	3.74	13.51	3.78	10.73	3.93
	21	18.65	3.15	18.09	3.20	15.33	3.46	13.67	3.62	13.01	3.68	10.34	3.95
	22	18.80	3.17	18.29	3.24	15.70	3.60	14.15	3.81	13.30	3.84	9.92	3.96
	24	19.49	3.20	18.70	3.27	14.75	3.64	12.38	3.87	11.71	3.89	9.03	4.01
2.0 + 2.5 + 2.5 + 5.0	16	19.72	2.80	19.32	2.87	17.29	3.23	16.07	3.44	15.29	3.49	12.14	3.69
	18	18.90	2.92	18.48	2.99	16.39	3.32	15.13	3.53	14.40	3.58	11.47	3.77
	20	18.62	3.00	18.13	3.06	15.67	3.40	14.20	3.60	13.51	3.64	10.73	3.78
	21	18.65	3.03	18.09	3.08	15.33	3.33	13.67	3.48	13.01	3.55	10.34	3.80
	22	18.80	3.05	18.29	3.12	15.70	3.46	14.15	3.67	13.30	3.70	9.92	3.82
	24	19.49	3.08	18.70	3.15	14.75	3.51	12.38	3.72	11.71	3.75	9.03	3.86

Combination (Capacity)	Indoor Air Temp. °C DB	Outdoor Air Temp. °C									
		0/-1		-5/-6		-7/-8		-10/-11		-15/-	
		Total Q	Input Power	Total Q	Input Power	Total Q	Input Power	Total Q	Input Power	Total Q	Input Power
2.0 + 2.0 + 6.0 + 7.1	16	11.95	3.64	11.05	3.52	10.69	3.47	10.27	3.35	9.58	3.15
	18	11.32	3.70	10.54	3.55	9.85	3.49	10.07	3.39	9.81	3.21
	20	10.67	3.71	10.14	3.57	9.93	3.51	9.89	3.43	9.84	3.30
	21	10.23	3.73	9.61	3.59	9.36	3.53	9.51	3.46	9.77	3.34
	22	10.00	3.75	9.85	3.60	9.79	3.55	9.74	3.48	9.64	3.38
	24	9.30	3.79	9.66	3.65	9.81	3.59	9.60	3.54	9.26	3.46
2.0 + 2.0 + 7.1 + 7.1	16	11.95	3.63	11.05	3.51	10.69	3.46	10.27	3.34	9.58	3.14
	18	11.32	3.69	10.54	3.54	9.85	3.48	10.07	3.38	9.81	3.20
	20	10.67	3.70	10.14	3.56	9.93	3.50	9.89	3.42	9.84	3.29
	21	10.23	3.72	9.61	3.58	9.36	3.52	9.51	3.45	9.77	3.33
	22	10.00	3.74	9.85	3.59	9.79	3.54	9.74	3.47	9.64	3.37
	24	9.30	3.78	9.66	3.64	9.81	3.58	9.60	3.53	9.26	3.45
2.0 + 2.5 + 2.5 + 2.5	16	11.79	3.84	10.90	3.72	10.54	3.67	10.13	3.54	9.45	3.33
	18	11.16	3.90	10.39	3.75	9.71	3.68	9.93	3.58	9.67	3.39
	20	10.52	3.92	10.00	3.77	9.79	3.71	9.75	3.63	9.70	3.49
	21	10.09	3.94	9.47	3.79	9.23	3.73	9.38	3.65	9.63	3.53
	22	9.86	3.96	9.71	3.80	9.66	3.74	9.60	3.68	9.51	3.57
	24	9.17	4.00	9.53	3.85	9.67	3.79	9.47	3.74	9.13	3.66
2.0 + 2.5 + 2.5 + 3.5	16	11.79	3.81	10.90	3.69	10.54	3.64	10.13	3.51	9.45	3.30
	18	11.16	3.87	10.39	3.72	9.71	3.66	9.93	3.55	9.67	3.37
	20	10.52	3.89	10.00	3.74	9.79	3.68	9.75	3.60	9.70	3.46
	21	10.09	3.91	9.47	3.76	9.23	3.70	9.38	3.62	9.63	3.50
	22	9.86	3.93	9.71	3.77	9.66	3.71	9.60	3.65	9.51	3.54
	24	9.17	3.97	9.53	3.82	9.67	3.76	9.47	3.71	9.13	3.63
2.0 + 2.5 + 2.5 + 4.2	16	11.79	3.79	10.90	3.67	10.54	3.62	10.13	3.49	9.45	3.28
	18	11.16	3.85	10.39	3.70	9.71	3.64	9.93	3.53	9.67	3.35
	20	10.52	3.87	10.00	3.72	9.79	3.66	9.75	3.58	9.70	3.44
	21	10.09	3.89	9.47	3.74	9.23	3.68	9.38	3.60	9.63	3.48
	22	9.86	3.90	9.71	3.75	9.66	3.69	9.60	3.63	9.51	3.52
	24	9.17	3.95	9.53	3.80	9.67	3.74	9.47	3.69	9.13	3.61
2.0 + 2.5 + 2.5 + 5.0	16	11.79	3.65	10.90	3.53	10.54	3.48	10.13	3.36	9.45	3.16
	18	11.16	3.71	10.39	3.56	9.71	3.50	9.93	3.40	9.67	3.22
	20	10.52	3.73	10.00	3.58	9.79	3.52	9.75	3.44	9.70	3.31
	21	10.09	3.74	9.47	3.60	9.23	3.54	9.38	3.47	9.63	3.35
	22	9.86	3.76	9.71	3.61	9.66	3.56	9.60	3.49	9.51	3.39
	24	9.17	3.80	9.53	3.66	9.67	3.60	9.47	3.55	9.13	3.47

Combination (Capacity)	Indoor Air Temp. °C DB	Outdoor Air Temp. °C											
		16/15		15/14		10/9		7/6		6/5		2/1	
		Total Q	Input Power	Total Q	Input Power	Total Q	Input Power	Total Q	Input Power	Total Q	Input Power	Total Q	Input Power
2.0 + 2.5 + 2.5 + 6.0	16	20.00	2.85	19.59	2.92	17.53	3.28	16.30	3.50	15.50	3.55	12.31	3.76
	18	19.17	2.97	18.74	3.04	16.62	3.38	15.34	3.59	14.60	3.64	11.63	3.83
	20	18.88	3.05	18.39	3.11	15.89	3.46	14.40	3.66	13.70	3.70	10.88	3.85
	21	18.91	3.08	18.35	3.13	15.55	3.39	13.87	3.54	13.19	3.60	10.48	3.86
	22	19.07	3.10	18.55	3.17	15.92	3.52	14.35	3.73	13.49	3.76	10.06	3.88
	24	19.76	3.13	18.96	3.20	14.96	3.57	12.55	3.78	11.87	3.81	9.15	3.92
2.0 + 2.5 + 2.5 + 7.1	16	20.00	2.83	19.59	2.90	17.53	3.26	16.30	3.48	15.50	3.53	12.31	3.74
	18	19.17	2.95	18.74	3.02	16.62	3.36	15.34	3.57	14.60	3.62	11.63	3.81
	20	18.88	3.03	18.39	3.10	15.89	3.44	14.40	3.64	13.70	3.68	10.88	3.83
	21	18.91	3.06	18.35	3.11	15.55	3.37	13.87	3.52	13.19	3.58	10.48	3.84
	22	19.07	3.08	18.55	3.15	15.92	3.50	14.35	3.71	13.49	3.74	10.06	3.86
	24	19.76	3.11	18.96	3.19	14.96	3.55	12.55	3.76	11.87	3.79	9.15	3.90
2.0 + 2.5 + 3.5 + 3.5	16	19.72	2.85	19.32	2.92	17.29	3.28	16.07	3.50	15.29	3.55	12.14	3.76
	18	18.90	2.97	18.48	3.04	16.39	3.38	15.13	3.59	14.40	3.64	11.47	3.83
	20	18.62	3.05	18.13	3.11	15.67	3.46	14.20	3.66	13.51	3.70	10.73	3.85
	21	18.65	3.08	18.09	3.13	15.33	3.39	13.67	3.54	13.01	3.60	10.34	3.86
	22	18.80	3.10	18.29	3.17	15.70	3.52	14.15	3.73	13.30	3.76	9.92	3.88
	24	19.49	3.13	18.70	3.20	14.75	3.57	12.38	3.78	11.71	3.81	9.03	3.92
2.0 + 2.5 + 3.5 + 4.2	16	19.72	2.84	19.32	2.91	17.29	3.27	16.07	3.49	15.29	3.54	12.14	3.75
	18	18.90	2.96	18.48	3.03	16.39	3.37	15.13	3.58	14.40	3.63	11.47	3.82
	20	18.62	3.04	18.13	3.11	15.67	3.45	14.20	3.65	13.51	3.69	10.73	3.84
	21	18.65	3.07	18.09	3.12	15.33	3.38	13.67	3.53	13.01	3.59	10.34	3.85
	22	18.80	3.09	18.29	3.16	15.70	3.51	14.15	3.72	13.30	3.75	9.92	3.87
	24	19.49	3.12	18.70	3.19	14.75	3.56	12.38	3.77	11.71	3.80	9.03	3.91
2.0 + 2.5 + 3.5 + 5.0	16	20.00	2.82	19.59	2.90	17.53	3.25	16.30	3.47	15.50	3.52	12.31	3.73
	18	19.17	2.94	18.74	3.01	16.62	3.35	15.34	3.56	14.60	3.61	11.63	3.80
	20	18.88	3.02	18.39	3.09	15.89	3.43	14.40	3.63	13.70	3.67	10.88	3.81
	21	18.91	3.05	18.35	3.10	15.55	3.36	13.87	3.51	13.19	3.58	10.48	3.83
	22	19.07	3.08	18.55	3.15	15.92	3.49	14.35	3.70	13.49	3.73	10.06	3.85
	24	19.76	3.10	18.96	3.18	14.96	3.54	12.55	3.75	11.87	3.78	9.15	3.89
2.0 + 2.5 + 3.5 + 6.0	16	20.00	2.82	19.59	2.90	17.53	3.25	16.30	3.47	15.50	3.52	12.31	3.73
	18	19.17	2.94	18.74	3.01	16.62	3.35	15.34	3.56	14.60	3.61	11.63	3.80
	20	18.88	3.02	18.39	3.09	15.89	3.43	14.40	3.63	13.70	3.67	10.88	3.81
	21	18.91	3.05	18.35	3.10	15.55	3.36	13.87	3.51	13.19	3.58	10.48	3.83
	22	19.07	3.08	18.55	3.15	15.92	3.49	14.35	3.70	13.49	3.73	10.06	3.85
	24	19.76	3.10	18.96	3.18	14.96	3.54	12.55	3.75	11.87	3.78	9.15	3.89

Combination (Capacity)	Indoor Air Temp. °C DB	Outdoor Air Temp. °C									
		0/-1		-5/-6		-7/-8		-10/-11		-15/-	
		Total Q	Input Power	Total Q	Input Power	Total Q	Input Power	Total Q	Input Power	Total Q	Input Power
2.0 + 2.5 + 2.5 + 6.0	16	11.95	3.71	11.05	3.59	10.69	3.54	10.27	3.42	9.58	3.21
	18	11.32	3.77	10.54	3.62	9.85	3.56	10.07	3.45	9.81	3.28
	20	10.67	3.79	10.14	3.64	9.93	3.58	9.89	3.50	9.84	3.37
	21	10.23	3.80	9.61	3.66	9.36	3.60	9.51	3.53	9.77	3.41
	22	10.00	3.82	9.85	3.67	9.79	3.61	9.74	3.55	9.64	3.45
	24	9.30	3.86	9.66	3.72	9.81	3.66	9.60	3.61	9.26	3.53
2.0 + 2.5 + 2.5 + 7.1	16	11.95	3.69	11.05	3.57	10.69	3.52	10.27	3.40	9.58	3.20
	18	11.32	3.75	10.54	3.60	9.85	3.54	10.07	3.43	9.81	3.26
	20	10.67	3.77	10.14	3.62	9.93	3.56	9.89	3.48	9.84	3.35
	21	10.23	3.78	9.61	3.64	9.36	3.58	9.51	3.51	9.77	3.39
	22	10.00	3.80	9.85	3.65	9.79	3.60	9.74	3.53	9.64	3.43
	24	9.30	3.84	9.66	3.70	9.81	3.64	9.60	3.59	9.26	3.51
2.0 + 2.5 + 3.5 + 3.5	16	11.79	3.71	10.90	3.59	10.54	3.54	10.13	3.42	9.45	3.21
	18	11.16	3.77	10.39	3.62	9.71	3.56	9.93	3.45	9.67	3.28
	20	10.52	3.79	10.00	3.64	9.79	3.58	9.75	3.50	9.70	3.37
	21	10.09	3.80	9.47	3.66	9.23	3.60	9.38	3.53	9.63	3.41
	22	9.86	3.82	9.71	3.67	9.66	3.61	9.60	3.55	9.51	3.45
	24	9.17	3.86	9.53	3.72	9.67	3.66	9.47	3.61	9.13	3.53
2.0 + 2.5 + 3.5 + 4.2	16	11.79	3.70	10.90	3.58	10.54	3.53	10.13	3.41	9.45	3.21
	18	11.16	3.76	10.39	3.61	9.71	3.55	9.93	3.44	9.67	3.27
	20	10.52	3.78	10.00	3.63	9.79	3.57	9.75	3.49	9.70	3.36
	21	10.09	3.79	9.47	3.65	9.23	3.59	9.38	3.52	9.63	3.40
	22	9.86	3.81	9.71	3.66	9.66	3.61	9.60	3.54	9.51	3.44
	24	9.17	3.85	9.53	3.71	9.67	3.65	9.47	3.60	9.13	3.52
2.0 + 2.5 + 3.5 + 5.0	16	11.95	3.68	11.05	3.56	10.69	3.51	10.27	3.39	9.58	3.19
	18	11.32	3.74	10.54	3.59	9.85	3.53	10.07	3.42	9.81	3.25
	20	10.67	3.76	10.14	3.61	9.93	3.55	9.89	3.47	9.84	3.34
	21	10.23	3.77	9.61	3.63	9.36	3.57	9.51	3.50	9.77	3.38
	22	10.00	3.79	9.85	3.64	9.79	3.59	9.74	3.52	9.64	3.42
	24	9.30	3.83	9.66	3.69	9.81	3.63	9.60	3.58	9.26	3.50
2.0 + 2.5 + 3.5 + 6.0	16	11.95	3.68	11.05	3.56	10.69	3.51	10.27	3.39	9.58	3.19
	18	11.32	3.74	10.54	3.59	9.85	3.53	10.07	3.42	9.81	3.25
	20	10.67	3.76	10.14	3.61	9.93	3.55	9.89	3.47	9.84	3.34
	21	10.23	3.77	9.61	3.63	9.36	3.57	9.51	3.50	9.77	3.38
	22	10.00	3.79	9.85	3.64	9.79	3.59	9.74	3.52	9.64	3.42
	24	9.30	3.83	9.66	3.69	9.81	3.63	9.60	3.58	9.26	3.50

Combination (Capacity)	Indoor Air Temp. °C DB	Outdoor Air Temp. °C											
		16/15		15/14		10/9		7/6		6/5		2/1	
		Total Q	Input Power	Total Q	Input Power	Total Q	Input Power	Total Q	Input Power	Total Q	Input Power	Total Q	Input Power
2.0 + 2.5 + 3.5 + 7.1	16	20.00	2.81	19.59	2.88	17.53	3.24	16.30	3.45	15.50	3.50	12.31	3.70
	18	19.17	2.93	18.74	2.99	16.62	3.33	15.34	3.54	14.60	3.59	11.63	3.78
	20	18.88	3.00	18.39	3.07	15.89	3.41	14.40	3.61	13.70	3.65	10.88	3.79
	21	18.91	3.04	18.35	3.09	15.55	3.34	13.87	3.49	13.19	3.56	10.48	3.81
	22	19.07	3.06	18.55	3.13	15.92	3.47	14.35	3.68	13.49	3.71	10.06	3.83
	24	19.76	3.09	18.96	3.16	14.96	3.52	12.55	3.73	11.87	3.76	9.15	3.87
2.0 + 2.5 + 4.2 + 4.2	16	20.00	2.93	19.59	3.00	17.53	3.37	16.30	3.59	15.50	3.65	12.31	3.86
	18	19.17	3.05	18.74	3.12	16.62	3.47	15.34	3.68	14.60	3.73	11.63	3.93
	20	18.88	3.13	18.39	3.20	15.89	3.55	14.40	3.76	13.70	3.80	10.88	3.95
	21	18.91	3.16	18.35	3.22	15.55	3.48	13.87	3.64	13.19	3.70	10.48	3.97
	22	19.07	3.19	18.55	3.26	15.92	3.62	14.35	3.83	13.49	3.86	10.06	3.99
	24	19.76	3.22	18.96	3.29	14.96	3.66	12.55	3.89	11.87	3.92	9.15	4.03
2.0 + 2.5 + 4.2 + 5.0	16	20.00	2.82	19.59	2.89	17.53	3.24	16.30	3.46	15.50	3.51	12.31	3.71
	18	19.17	2.93	18.74	3.00	16.62	3.34	15.34	3.55	14.60	3.60	11.63	3.79
	20	18.88	3.01	18.39	3.08	15.89	3.42	14.40	3.62	13.70	3.66	10.88	3.80
	21	18.91	3.05	18.35	3.10	15.55	3.35	13.87	3.50	13.19	3.57	10.48	3.82
	22	19.07	3.07	18.55	3.14	15.92	3.48	14.35	3.69	13.49	3.72	10.06	3.84
	24	19.76	3.10	18.96	3.17	14.96	3.53	12.55	3.74	11.87	3.77	9.15	3.88
2.0 + 2.5 + 4.2 + 6.0	16	20.00	2.82	19.59	2.89	17.53	3.24	16.30	3.46	15.50	3.51	12.31	3.71
	18	19.17	2.93	18.74	3.00	16.62	3.34	15.34	3.55	14.60	3.60	11.63	3.79
	20	18.88	3.01	18.39	3.08	15.89	3.42	14.40	3.62	13.70	3.66	10.88	3.80
	21	18.91	3.05	18.35	3.10	15.55	3.35	13.87	3.50	13.19	3.57	10.48	3.82
	22	19.07	3.07	18.55	3.14	15.92	3.48	14.35	3.69	13.49	3.72	10.06	3.84
	24	19.76	3.10	18.96	3.17	14.96	3.53	12.55	3.74	11.87	3.77	9.15	3.88
2.0 + 2.5 + 4.2 + 7.1	16	20.00	2.85	19.59	2.92	17.53	3.28	16.30	3.50	15.50	3.55	12.31	3.76
	18	19.17	2.97	18.74	3.04	16.62	3.38	15.34	3.59	14.60	3.64	11.63	3.83
	20	18.88	3.05	18.39	3.11	15.89	3.46	14.40	3.66	13.70	3.70	10.88	3.85
	21	18.91	3.08	18.35	3.13	15.55	3.39	13.87	3.54	13.19	3.60	10.48	3.86
	22	19.07	3.10	18.55	3.17	15.92	3.52	14.35	3.73	13.49	3.76	10.06	3.88
	24	19.76	3.13	18.96	3.20	14.96	3.57	12.55	3.78	11.87	3.81	9.15	3.92
2.0 + 2.5 + 5.0 + 5.0	16	20.00	2.80	19.59	2.87	17.53	3.23	16.30	3.44	15.50	3.49	12.31	3.69
	18	19.17	2.92	18.74	2.99	16.62	3.32	15.34	3.53	14.60	3.58	11.63	3.77
	20	18.88	3.00	18.39	3.06	15.89	3.40	14.40	3.60	13.70	3.64	10.88	3.78
	21	18.91	3.03	18.35	3.08	15.55	3.33	13.87	3.48	13.19	3.55	10.48	3.80
	22	19.07	3.05	18.55	3.12	15.92	3.46	14.35	3.67	13.49	3.70	10.06	3.82
	24	19.76	3.08	18.96	3.15	14.96	3.51	12.55	3.72	11.87	3.75	9.15	3.86



Combination (Capacity)	Indoor Air Temp. °C DB	Outdoor Air Temp. °C									
		0/-1		-5/-6		-7/-8		-10/-11		-15/-	
		Total Q	Input Power	Total Q	Input Power	Total Q	Input Power	Total Q	Input Power	Total Q	Input Power
2.0 + 2.5 + 3.5 + 7.1	16	11.95	3.66	11.05	3.54	10.69	3.49	10.27	3.37	9.58	3.17
	18	11.32	3.72	10.54	3.57	9.85	3.51	10.07	3.41	9.81	3.23
	20	10.67	3.74	10.14	3.59	9.93	3.53	9.89	3.45	9.84	3.32
	21	10.23	3.75	9.61	3.61	9.36	3.55	9.51	3.48	9.77	3.36
	22	10.00	3.77	9.85	3.62	9.79	3.57	9.74	3.50	9.64	3.40
	24	9.30	3.81	9.66	3.67	9.81	3.61	9.60	3.56	9.26	3.48
2.0 + 2.5 + 4.2 + 4.2	16	11.95	3.81	11.05	3.69	10.69	3.64	10.27	3.51	9.58	3.30
	18	11.32	3.87	10.54	3.72	9.85	3.66	10.07	3.55	9.81	3.37
	20	10.67	3.89	10.14	3.74	9.93	3.68	9.89	3.60	9.84	3.46
	21	10.23	3.91	9.61	3.76	9.36	3.70	9.51	3.62	9.77	3.50
	22	10.00	3.93	9.85	3.77	9.79	3.71	9.74	3.65	9.64	3.54
	24	9.30	3.97	9.66	3.82	9.81	3.76	9.60	3.71	9.26	3.63
2.0 + 2.5 + 4.2 + 5.0	16	11.95	3.67	11.05	3.55	10.69	3.50	10.27	3.38	9.58	3.18
	18	11.32	3.73	10.54	3.58	9.85	3.52	10.07	3.42	9.81	3.24
	20	10.67	3.75	10.14	3.60	9.93	3.54	9.89	3.46	9.84	3.33
	21	10.23	3.76	9.61	3.62	9.36	3.56	9.51	3.49	9.77	3.37
	22	10.00	3.78	9.85	3.63	9.79	3.58	9.74	3.51	9.64	3.41
	24	9.30	3.82	9.66	3.68	9.81	3.62	9.60	3.57	9.26	3.49
2.0 + 2.5 + 4.2 + 6.0	16	11.95	3.67	11.05	3.55	10.69	3.50	10.27	3.38	9.58	3.18
	18	11.32	3.73	10.54	3.58	9.85	3.52	10.07	3.42	9.81	3.24
	20	10.67	3.75	10.14	3.60	9.93	3.54	9.89	3.46	9.84	3.33
	21	10.23	3.76	9.61	3.62	9.36	3.56	9.51	3.49	9.77	3.37
	22	10.00	3.78	9.85	3.63	9.79	3.58	9.74	3.51	9.64	3.41
	24	9.30	3.82	9.66	3.68	9.81	3.62	9.60	3.57	9.26	3.49
2.0 + 2.5 + 4.2 + 7.1	16	11.95	3.71	11.05	3.59	10.69	3.54	10.27	3.42	9.58	3.21
	18	11.32	3.77	10.54	3.62	9.85	3.56	10.07	3.45	9.81	3.28
	20	10.67	3.79	10.14	3.64	9.93	3.58	9.89	3.50	9.84	3.37
	21	10.23	3.80	9.61	3.66	9.36	3.60	9.51	3.53	9.77	3.41
	22	10.00	3.82	9.85	3.67	9.79	3.61	9.74	3.55	9.64	3.45
	24	9.30	3.86	9.66	3.72	9.81	3.66	9.60	3.61	9.26	3.53
2.0 + 2.5 + 5.0 + 5.0	16	11.95	3.65	11.05	3.53	10.69	3.48	10.27	3.36	9.58	3.16
	18	11.32	3.71	10.54	3.56	9.85	3.50	10.07	3.40	9.81	3.22
	20	10.67	3.73	10.14	3.58	9.93	3.52	9.89	3.44	9.84	3.31
	21	10.23	3.74	9.61	3.60	9.36	3.54	9.51	3.47	9.77	3.35
	22	10.00	3.76	9.85	3.61	9.79	3.56	9.74	3.49	9.64	3.39
	24	9.30	3.80	9.66	3.66	9.81	3.60	9.60	3.55	9.26	3.47

Combination (Capacity)	Indoor Air Temp. °C DB	Outdoor Air Temp. °C											
		16/15		15/14		10/9		7/6		6/5		2/1	
		Total Q	Input Power	Total Q	Input Power	Total Q	Input Power	Total Q	Input Power	Total Q	Input Power	Total Q	Input Power
2.0 + 2.5 + 5.0 + 6.0	16	20.00	2.80	19.59	2.87	17.53	3.23	16.30	3.44	15.50	3.49	12.31	3.69
	18	19.17	2.92	18.74	2.99	16.62	3.32	15.34	3.53	14.60	3.58	11.63	3.77
	20	18.88	3.00	18.39	3.06	15.89	3.40	14.40	3.60	13.70	3.64	10.88	3.78
	21	18.91	3.03	18.35	3.08	15.55	3.33	13.87	3.48	13.19	3.55	10.48	3.80
	22	19.07	3.05	18.55	3.12	15.92	3.46	14.35	3.67	13.49	3.70	10.06	3.82
	24	19.76	3.08	18.96	3.15	14.96	3.51	12.55	3.72	11.87	3.75	9.15	3.86
2.0 + 2.5 + 5.0 + 7.1	16	20.00	2.79	19.59	2.86	17.53	3.22	16.30	3.43	15.50	3.48	12.31	3.68
	18	19.17	2.91	18.74	2.98	16.62	3.32	15.34	3.52	14.60	3.57	11.63	3.76
	20	18.88	2.99	18.39	3.05	15.89	3.39	14.40	3.59	13.70	3.63	10.88	3.77
	21	18.91	3.02	18.35	3.07	15.55	3.32	13.87	3.47	13.19	3.54	10.48	3.79
	22	19.07	3.04	18.55	3.11	15.92	3.45	14.35	3.66	13.49	3.69	10.06	3.81
	24	19.76	3.07	18.96	3.14	14.96	3.50	12.55	3.71	11.87	3.74	9.15	3.84
2.0 + 2.5 + 6.0 + 6.0	16	20.00	2.80	19.59	2.87	17.53	3.23	16.30	3.44	15.50	3.49	12.31	3.69
	18	19.17	2.92	18.74	2.99	16.62	3.32	15.34	3.53	14.60	3.58	11.63	3.77
	20	18.88	3.00	18.39	3.06	15.89	3.40	14.40	3.60	13.70	3.64	10.88	3.78
	21	18.91	3.03	18.35	3.08	15.55	3.33	13.87	3.48	13.19	3.55	10.48	3.80
	22	19.07	3.05	18.55	3.12	15.92	3.46	14.35	3.67	13.49	3.70	10.06	3.82
	24	19.76	3.08	18.96	3.15	14.96	3.51	12.55	3.72	11.87	3.75	9.15	3.86
2.0 + 2.5 + 6.0 + 7.1	16	20.00	2.79	19.59	2.86	17.53	3.22	16.30	3.43	15.50	3.48	12.31	3.68
	18	19.17	2.91	18.74	2.98	16.62	3.32	15.34	3.52	14.60	3.57	11.63	3.76
	20	18.88	2.99	18.39	3.05	15.89	3.39	14.40	3.59	13.70	3.63	10.88	3.77
	21	18.91	3.02	18.35	3.07	15.55	3.32	13.87	3.47	13.19	3.54	10.48	3.79
	22	19.07	3.04	18.55	3.11	15.92	3.45	14.35	3.66	13.49	3.69	10.06	3.81
	24	19.76	3.07	18.96	3.14	14.96	3.50	12.55	3.71	11.87	3.74	9.15	3.84
2.0 + 3.5 + 3.5 + 3.5	16	19.72	2.82	19.32	2.90	17.29	3.25	16.07	3.47	15.29	3.52	12.14	3.73
	18	18.90	2.94	18.48	3.01	16.39	3.35	15.13	3.56	14.40	3.61	11.47	3.80
	20	18.62	3.02	18.13	3.09	15.67	3.43	14.20	3.63	13.51	3.67	10.73	3.81
	21	18.65	3.05	18.09	3.10	15.33	3.36	13.67	3.51	13.01	3.58	10.34	3.83
	22	18.80	3.08	18.29	3.15	15.70	3.49	14.15	3.70	13.30	3.73	9.92	3.85
	24	19.49	3.10	18.70	3.18	14.75	3.54	12.38	3.75	11.71	3.78	9.03	3.89
2.0 + 3.5 + 3.5 + 4.2	16	20.00	2.90	19.59	2.98	17.53	3.34	16.30	3.56	15.50	3.62	12.31	3.83
	18	19.17	3.02	18.74	3.09	16.62	3.44	15.34	3.66	14.60	3.70	11.63	3.90
	20	18.88	3.10	18.39	3.17	15.89	3.52	14.40	3.73	13.70	3.77	10.88	3.92
	21	18.91	3.14	18.35	3.19	15.55	3.45	13.87	3.61	13.19	3.67	10.48	3.94
	22	19.07	3.16	18.55	3.23	15.92	3.59	14.35	3.80	13.49	3.83	10.06	3.95
	24	19.76	3.19	18.96	3.26	14.96	3.63	12.55	3.86	11.87	3.88	9.15	3.99

Combination (Capacity)	Indoor Air Temp. °C DB	Outdoor Air Temp. °C									
		0/-1		-5/-6		-7/-8		-10/-11		-15/-	
		Total Q	Input Power	Total Q	Input Power	Total Q	Input Power	Total Q	Input Power	Total Q	Input Power
2.0 + 2.5 + 5.0 + 6.0	16	11.95	3.65	11.05	3.53	10.69	3.48	10.27	3.36	9.58	3.16
	18	11.32	3.71	10.54	3.56	9.85	3.50	10.07	3.40	9.81	3.22
	20	10.67	3.73	10.14	3.58	9.93	3.52	9.89	3.44	9.84	3.31
	21	10.23	3.74	9.61	3.60	9.36	3.54	9.51	3.47	9.77	3.35
	22	10.00	3.76	9.85	3.61	9.79	3.56	9.74	3.49	9.64	3.39
	24	9.30	3.80	9.66	3.66	9.81	3.60	9.60	3.55	9.26	3.47
2.0 + 2.5 + 5.0 + 7.1	16	11.95	3.64	11.05	3.52	10.69	3.47	10.27	3.35	9.58	3.15
	18	11.32	3.70	10.54	3.55	9.85	3.49	10.07	3.39	9.81	3.21
	20	10.67	3.71	10.14	3.57	9.93	3.51	9.89	3.43	9.84	3.30
	21	10.23	3.73	9.61	3.59	9.36	3.53	9.51	3.46	9.77	3.34
	22	10.00	3.75	9.85	3.60	9.79	3.55	9.74	3.48	9.64	3.38
	24	9.30	3.79	9.66	3.65	9.81	3.59	9.60	3.54	9.26	3.46
2.0 + 2.5 + 6.0 + 6.0	16	11.95	3.65	11.05	3.53	10.69	3.48	10.27	3.36	9.58	3.16
	18	11.32	3.71	10.54	3.56	9.85	3.50	10.07	3.40	9.81	3.22
	20	10.67	3.73	10.14	3.58	9.93	3.52	9.89	3.44	9.84	3.31
	21	10.23	3.74	9.61	3.60	9.36	3.54	9.51	3.47	9.77	3.35
	22	10.00	3.76	9.85	3.61	9.79	3.56	9.74	3.49	9.64	3.39
	24	9.30	3.80	9.66	3.66	9.81	3.60	9.60	3.55	9.26	3.47
2.0 + 2.5 + 6.0 + 7.1	16	11.95	3.64	11.05	3.52	10.69	3.47	10.27	3.35	9.58	3.15
	18	11.32	3.70	10.54	3.55	9.85	3.49	10.07	3.39	9.81	3.21
	20	10.67	3.71	10.14	3.57	9.93	3.51	9.89	3.43	9.84	3.30
	21	10.23	3.73	9.61	3.59	9.36	3.53	9.51	3.46	9.77	3.34
	22	10.00	3.75	9.85	3.60	9.79	3.55	9.74	3.48	9.64	3.38
	24	9.30	3.79	9.66	3.65	9.81	3.59	9.60	3.54	9.26	3.46
2.0 + 3.5 + 3.5 + 3.5	16	11.79	3.68	10.90	3.56	10.54	3.51	10.13	3.39	9.45	3.19
	18	11.16	3.74	10.39	3.59	9.71	3.53	9.93	3.42	9.67	3.25
	20	10.52	3.76	10.00	3.61	9.79	3.55	9.75	3.47	9.70	3.34
	21	10.09	3.77	9.47	3.63	9.23	3.57	9.38	3.50	9.63	3.38
	22	9.86	3.79	9.71	3.64	9.66	3.59	9.60	3.52	9.51	3.42
	24	9.17	3.83	9.53	3.69	9.67	3.63	9.47	3.58	9.13	3.50
2.0 + 3.5 + 3.5 + 4.2	16	11.95	3.78	11.05	3.66	10.69	3.61	10.27	3.48	9.58	3.28
	18	11.32	3.84	10.54	3.69	9.85	3.63	10.07	3.52	9.81	3.34
	20	10.67	3.86	10.14	3.71	9.93	3.65	9.89	3.57	9.84	3.43
	21	10.23	3.88	9.61	3.73	9.36	3.67	9.51	3.59	9.77	3.47
	22	10.00	3.89	9.85	3.74	9.79	3.68	9.74	3.62	9.64	3.51
	24	9.30	3.94	9.66	3.79	9.81	3.73	9.60	3.68	9.26	3.60

Combination (Capacity)	Indoor Air Temp. °C DB	Outdoor Air Temp. °C											
		16/15		15/14		10/9		7/6		6/5		2/1	
		Total Q	Input Power	Total Q	Input Power	Total Q	Input Power	Total Q	Input Power	Total Q	Input Power	Total Q	Input Power
2.0 + 3.5 + 3.5 + 5.0	16	20.00	2.84	19.59	2.91	17.53	3.27	16.30	3.49	15.50	3.54	12.31	3.75
	18	19.17	2.96	18.74	3.03	16.62	3.37	15.34	3.58	14.60	3.63	11.63	3.82
	20	18.88	3.04	18.39	3.11	15.89	3.45	14.40	3.65	13.70	3.69	10.88	3.84
	21	18.91	3.07	18.35	3.12	15.55	3.38	13.87	3.53	13.19	3.59	10.48	3.85
	22	19.07	3.09	18.55	3.16	15.92	3.51	14.35	3.72	13.49	3.75	10.06	3.87
	24	19.76	3.12	18.96	3.19	14.96	3.56	12.55	3.77	11.87	3.80	9.15	3.91
2.0 + 3.5 + 3.5 + 6.0	16	20.00	2.84	19.59	2.91	17.53	3.27	16.30	3.49	15.50	3.54	12.31	3.75
	18	19.17	2.96	18.74	3.03	16.62	3.37	15.34	3.58	14.60	3.63	11.63	3.82
	20	18.88	3.04	18.39	3.11	15.89	3.45	14.40	3.65	13.70	3.69	10.88	3.84
	21	18.91	3.07	18.35	3.12	15.55	3.38	13.87	3.53	13.19	3.59	10.48	3.85
	22	19.07	3.09	18.55	3.16	15.92	3.51	14.35	3.72	13.49	3.75	10.06	3.87
	24	19.76	3.12	18.96	3.19	14.96	3.56	12.55	3.77	11.87	3.80	9.15	3.91
2.0 + 3.5 + 3.5 + 7.1	16	20.00	2.83	19.59	2.90	17.53	3.26	16.30	3.48	15.50	3.53	12.31	3.74
	18	19.17	2.95	18.74	3.02	16.62	3.36	15.34	3.57	14.60	3.62	11.63	3.81
	20	18.88	3.03	18.39	3.10	15.89	3.44	14.40	3.64	13.70	3.68	10.88	3.83
	21	18.91	3.06	18.35	3.11	15.55	3.37	13.87	3.52	13.19	3.58	10.48	3.84
	22	19.07	3.08	18.55	3.15	15.92	3.50	14.35	3.71	13.49	3.74	10.06	3.86
	24	19.76	3.11	18.96	3.19	14.96	3.55	12.55	3.76	11.87	3.79	9.15	3.90
2.0 + 3.5 + 4.2 + 4.2	16	20.00	2.89	19.59	2.97	17.53	3.33	16.30	3.55	15.50	3.61	12.31	3.82
	18	19.17	3.01	18.74	3.09	16.62	3.44	15.34	3.65	14.60	3.69	11.63	3.89
	20	18.88	3.10	18.39	3.16	15.89	3.51	14.40	3.72	13.70	3.76	10.88	3.91
	21	18.91	3.13	18.35	3.18	15.55	3.44	13.87	3.60	13.19	3.66	10.48	3.93
	22	19.07	3.15	18.55	3.22	15.92	3.58	14.35	3.79	13.49	3.82	10.06	3.94
	24	19.76	3.18	18.96	3.26	14.96	3.62	12.55	3.85	11.87	3.87	9.15	3.98
2.0 + 3.5 + 4.2 + 5.0	16	20.00	2.83	19.59	2.90	17.53	3.26	16.30	3.48	15.50	3.53	12.31	3.74
	18	19.17	2.95	18.74	3.02	16.62	3.36	15.34	3.57	14.60	3.62	11.63	3.81
	20	18.88	3.03	18.39	3.10	15.89	3.44	14.40	3.64	13.70	3.68	10.88	3.83
	21	18.91	3.06	18.35	3.11	15.55	3.37	13.87	3.52	13.19	3.58	10.48	3.84
	22	19.07	3.08	18.55	3.15	15.92	3.50	14.35	3.71	13.49	3.74	10.06	3.86
	24	19.76	3.11	18.96	3.19	14.96	3.55	12.55	3.76	11.87	3.79	9.15	3.90
2.0 + 3.5 + 4.2 + 6.0	16	20.00	2.83	19.59	2.90	17.53	3.26	16.30	3.48	15.50	3.53	12.31	3.74
	18	19.17	2.95	18.74	3.02	16.62	3.36	15.34	3.57	14.60	3.62	11.63	3.81
	20	18.88	3.03	18.39	3.10	15.89	3.44	14.40	3.64	13.70	3.68	10.88	3.83
	21	18.91	3.06	18.35	3.11	15.55	3.37	13.87	3.52	13.19	3.58	10.48	3.84
	22	19.07	3.08	18.55	3.15	15.92	3.50	14.35	3.71	13.49	3.74	10.06	3.86
	24	19.76	3.11	18.96	3.19	14.96	3.55	12.55	3.76	11.87	3.79	9.15	3.90

Combination (Capacity)	Indoor Air Temp. °C DB	Outdoor Air Temp. °C									
		0/-1		-5/-6		-7/-8		-10/-11		-15/-	
		Total Q	Input Power	Total Q	Input Power	Total Q	Input Power	Total Q	Input Power	Total Q	Input Power
2.0 + 3.5 + 3.5 + 5.0	16	11.95	3.70	11.05	3.58	10.69	3.53	10.27	3.41	9.58	3.21
	18	11.32	3.76	10.54	3.61	9.85	3.55	10.07	3.44	9.81	3.27
	20	10.67	3.78	10.14	3.63	9.93	3.57	9.89	3.49	9.84	3.36
	21	10.23	3.79	9.61	3.65	9.36	3.59	9.51	3.52	9.77	3.40
	22	10.00	3.81	9.85	3.66	9.79	3.61	9.74	3.54	9.64	3.44
	24	9.30	3.85	9.66	3.71	9.81	3.65	9.60	3.60	9.26	3.52
2.0 + 3.5 + 3.5 + 6.0	16	11.95	3.70	11.05	3.58	10.69	3.53	10.27	3.41	9.58	3.21
	18	11.32	3.76	10.54	3.61	9.85	3.55	10.07	3.44	9.81	3.27
	20	10.67	3.78	10.14	3.63	9.93	3.57	9.89	3.49	9.84	3.36
	21	10.23	3.79	9.61	3.65	9.36	3.59	9.51	3.52	9.77	3.40
	22	10.00	3.81	9.85	3.66	9.79	3.61	9.74	3.54	9.64	3.44
	24	9.30	3.85	9.66	3.71	9.81	3.65	9.60	3.60	9.26	3.52
2.0 + 3.5 + 3.5 + 7.1	16	11.95	3.69	11.05	3.57	10.69	3.52	10.27	3.40	9.58	3.20
	18	11.32	3.75	10.54	3.60	9.85	3.54	10.07	3.43	9.81	3.26
	20	10.67	3.77	10.14	3.62	9.93	3.56	9.89	3.48	9.84	3.35
	21	10.23	3.78	9.61	3.64	9.36	3.58	9.51	3.51	9.77	3.39
	22	10.00	3.80	9.85	3.65	9.79	3.60	9.74	3.53	9.64	3.43
	24	9.30	3.84	9.66	3.70	9.81	3.64	9.60	3.59	9.26	3.51
2.0 + 3.5 + 4.2 + 4.2	16	11.95	3.77	11.05	3.65	10.69	3.60	10.27	3.47	9.58	3.27
	18	11.32	3.83	10.54	3.68	9.85	3.62	10.07	3.51	9.81	3.33
	20	10.67	3.85	10.14	3.70	9.93	3.64	9.89	3.56	9.84	3.42
	21	10.23	3.87	9.61	3.72	9.36	3.66	9.51	3.58	9.77	3.46
	22	10.00	3.88	9.85	3.73	9.79	3.67	9.74	3.61	9.64	3.50
	24	9.30	3.93	9.66	3.78	9.81	3.72	9.60	3.67	9.26	3.59
2.0 + 3.5 + 4.2 + 5.0	16	11.95	3.69	11.05	3.57	10.69	3.52	10.27	3.40	9.58	3.20
	18	11.32	3.75	10.54	3.60	9.85	3.54	10.07	3.43	9.81	3.26
	20	10.67	3.77	10.14	3.62	9.93	3.56	9.89	3.48	9.84	3.35
	21	10.23	3.78	9.61	3.64	9.36	3.58	9.51	3.51	9.77	3.39
	22	10.00	3.80	9.85	3.65	9.79	3.60	9.74	3.53	9.64	3.43
	24	9.30	3.84	9.66	3.70	9.81	3.64	9.60	3.59	9.26	3.51
2.0 + 3.5 + 4.2 + 6.0	16	11.95	3.69	11.05	3.57	10.69	3.52	10.27	3.40	9.58	3.20
	18	11.32	3.75	10.54	3.60	9.85	3.54	10.07	3.43	9.81	3.26
	20	10.67	3.77	10.14	3.62	9.93	3.56	9.89	3.48	9.84	3.35
	21	10.23	3.78	9.61	3.64	9.36	3.58	9.51	3.51	9.77	3.39
	22	10.00	3.80	9.85	3.65	9.79	3.60	9.74	3.53	9.64	3.43
	24	9.30	3.84	9.66	3.70	9.81	3.64	9.60	3.59	9.26	3.51

Combination (Capacity)	Indoor Air Temp. °C DB	Outdoor Air Temp. °C											
		16/15		15/14		10/9		7/6		6/5		2/1	
		Total Q	Input Power	Total Q	Input Power	Total Q	Input Power	Total Q	Input Power	Total Q	Input Power	Total Q	Input Power
2.0 + 3.5 + 4.2 + 7.1	16	20.00	2.82	19.59	2.90	17.53	3.25	16.30	3.47	15.50	3.52	12.31	3.73
	18	19.17	2.94	18.74	3.01	16.62	3.35	15.34	3.56	14.60	3.61	11.63	3.80
	20	18.88	3.02	18.39	3.09	15.89	3.43	14.40	3.63	13.70	3.67	10.88	3.81
	21	18.91	3.05	18.35	3.10	15.55	3.36	13.87	3.51	13.19	3.58	10.48	3.83
	22	19.07	3.08	18.55	3.15	15.92	3.49	14.35	3.70	13.49	3.73	10.06	3.85
	24	19.76	3.10	18.96	3.18	14.96	3.54	12.55	3.75	11.87	3.78	9.15	3.89
2.0 + 3.5 + 5.0 + 5.0	16	20.00	2.79	19.59	2.86	17.53	3.21	16.30	3.42	15.50	3.47	12.31	3.67
	18	19.17	2.90	18.74	2.97	16.62	3.31	15.34	3.51	14.60	3.56	11.63	3.75
	20	18.88	2.98	18.39	3.05	15.89	3.38	14.40	3.58	13.70	3.62	10.88	3.76
	21	18.91	3.01	18.35	3.06	15.55	3.31	13.87	3.46	13.19	3.53	10.48	3.78
	22	19.07	3.03	18.55	3.10	15.92	3.44	14.35	3.65	13.49	3.68	10.06	3.80
	24	19.76	3.06	18.96	3.13	14.96	3.49	12.55	3.70	11.87	3.73	9.15	3.83
2.0 + 3.5 + 5.0 + 6.0	16	20.00	2.79	19.59	2.86	17.53	3.21	16.30	3.42	15.50	3.47	12.31	3.67
	18	19.17	2.90	18.74	2.97	16.62	3.31	15.34	3.51	14.60	3.56	11.63	3.75
	20	18.88	2.98	18.39	3.05	15.89	3.38	14.40	3.58	13.70	3.62	10.88	3.76
	21	18.91	3.01	18.35	3.06	15.55	3.31	13.87	3.46	13.19	3.53	10.48	3.78
	22	19.07	3.03	18.55	3.10	15.92	3.44	14.35	3.65	13.49	3.68	10.06	3.80
	24	19.76	3.06	18.96	3.13	14.96	3.49	12.55	3.70	11.87	3.73	9.15	3.83
2.0 + 3.5 + 5.0 + 7.1	16	20.00	2.77	19.59	2.84	17.53	3.19	16.30	3.40	15.50	3.45	12.31	3.65
	18	19.17	2.89	18.74	2.95	16.62	3.29	15.34	3.49	14.60	3.54	11.63	3.72
	20	18.88	2.96	18.39	3.03	15.89	3.36	14.40	3.56	13.70	3.60	10.88	3.74
	21	18.91	3.00	18.35	3.04	15.55	3.29	13.87	3.44	13.19	3.51	10.48	3.76
	22	19.07	3.02	18.55	3.08	15.92	3.42	14.35	3.63	13.49	3.66	10.06	3.77
	24	19.76	3.04	18.96	3.12	14.96	3.47	12.55	3.68	11.87	3.71	9.15	3.81
2.0 + 3.5 + 6.0 + 6.0	16	20.00	2.79	19.59	2.86	17.53	3.21	16.30	3.42	15.50	3.47	12.31	3.67
	18	19.17	2.90	18.74	2.97	16.62	3.31	15.34	3.51	14.60	3.56	11.63	3.75
	20	18.88	2.98	18.39	3.05	15.89	3.38	14.40	3.58	13.70	3.62	10.88	3.76
	21	18.91	3.01	18.35	3.06	15.55	3.31	13.87	3.46	13.19	3.53	10.48	3.78
	22	19.07	3.03	18.55	3.10	15.92	3.44	14.35	3.65	13.49	3.68	10.06	3.80
	24	19.76	3.06	18.96	3.13	14.96	3.49	12.55	3.70	11.87	3.73	9.15	3.83
2.0 + 4.2 + 4.2 + 4.2	16	20.00	2.89	19.59	2.96	17.53	3.33	16.30	3.54	15.50	3.60	12.31	3.81
	18	19.17	3.01	18.74	3.08	16.62	3.43	15.34	3.64	14.60	3.68	11.63	3.88
	20	18.88	3.09	18.39	3.16	15.89	3.50	14.40	3.71	13.70	3.75	10.88	3.90
	21	18.91	3.12	18.35	3.17	15.55	3.43	13.87	3.59	13.19	3.65	10.48	3.92
	22	19.07	3.14	18.55	3.21	15.92	3.57	14.35	3.78	13.49	3.81	10.06	3.93
	24	19.76	3.17	18.96	3.25	14.96	3.61	12.55	3.84	11.87	3.86	9.15	3.97

Combination (Capacity)	Indoor Air Temp. °C DB	Outdoor Air Temp. °C									
		0/-1		-5/-6		-7/-8		-10/-11		-15/-	
		Total Q	Input Power	Total Q	Input Power	Total Q	Input Power	Total Q	Input Power	Total Q	Input Power
2.0 + 3.5 + 4.2 + 7.1	16	11.95	3.68	11.05	3.56	10.69	3.51	10.27	3.39	9.58	3.19
	18	11.32	3.74	10.54	3.59	9.85	3.53	10.07	3.42	9.81	3.25
	20	10.67	3.76	10.14	3.61	9.93	3.55	9.89	3.47	9.84	3.34
	21	10.23	3.77	9.61	3.63	9.36	3.57	9.51	3.50	9.77	3.38
	22	10.00	3.79	9.85	3.64	9.79	3.59	9.74	3.52	9.64	3.42
	24	9.30	3.83	9.66	3.69	9.81	3.63	9.60	3.58	9.26	3.50
2.0 + 3.5 + 5.0 + 5.0	16	11.95	3.63	11.05	3.51	10.69	3.46	10.27	3.34	9.58	3.14
	18	11.32	3.69	10.54	3.54	9.85	3.48	10.07	3.38	9.81	3.20
	20	10.67	3.70	10.14	3.56	9.93	3.50	9.89	3.42	9.84	3.29
	21	10.23	3.72	9.61	3.58	9.36	3.52	9.51	3.45	9.77	3.33
	22	10.00	3.74	9.85	3.59	9.79	3.54	9.74	3.47	9.64	3.37
	24	9.30	3.78	9.66	3.64	9.81	3.58	9.60	3.53	9.26	3.45
2.0 + 3.5 + 5.0 + 6.0	16	11.95	3.63	11.05	3.51	10.69	3.46	10.27	3.34	9.58	3.14
	18	11.32	3.69	10.54	3.54	9.85	3.48	10.07	3.38	9.81	3.20
	20	10.67	3.70	10.14	3.56	9.93	3.50	9.89	3.42	9.84	3.29
	21	10.23	3.72	9.61	3.58	9.36	3.52	9.51	3.45	9.77	3.33
	22	10.00	3.74	9.85	3.59	9.79	3.54	9.74	3.47	9.64	3.37
	24	9.30	3.78	9.66	3.64	9.81	3.58	9.60	3.53	9.26	3.45
2.0 + 3.5 + 5.0 + 7.1	16	11.95	3.61	11.05	3.49	10.69	3.44	10.27	3.33	9.58	3.13
	18	11.32	3.67	10.54	3.52	9.85	3.46	10.07	3.36	9.81	3.19
	20	10.67	3.68	10.14	3.54	9.93	3.48	9.89	3.41	9.84	3.27
	21	10.23	3.70	9.61	3.56	9.36	3.50	9.51	3.43	9.77	3.31
	22	10.00	3.72	9.85	3.57	9.79	3.52	9.74	3.45	9.64	3.35
	24	9.30	3.76	9.66	3.62	9.81	3.56	9.60	3.51	9.26	3.43
2.0 + 3.5 + 6.0 + 6.0	16	11.95	3.63	11.05	3.51	10.69	3.46	10.27	3.34	9.58	3.14
	18	11.32	3.69	10.54	3.54	9.85	3.48	10.07	3.38	9.81	3.20
	20	10.67	3.70	10.14	3.56	9.93	3.50	9.89	3.42	9.84	3.29
	21	10.23	3.72	9.61	3.58	9.36	3.52	9.51	3.45	9.77	3.33
	22	10.00	3.74	9.85	3.59	9.79	3.54	9.74	3.47	9.64	3.37
	24	9.30	3.78	9.66	3.64	9.81	3.58	9.60	3.53	9.26	3.45
2.0 + 4.2 + 4.2 + 4.2	16	11.95	3.76	11.05	3.64	10.69	3.59	10.27	3.47	9.58	3.26
	18	11.32	3.82	10.54	3.67	9.85	3.61	10.07	3.50	9.81	3.32
	20	10.67	3.84	10.14	3.69	9.93	3.63	9.89	3.55	9.84	3.41
	21	10.23	3.86	9.61	3.71	9.36	3.65	9.51	3.57	9.77	3.45
	22	10.00	3.87	9.85	3.72	9.79	3.66	9.74	3.60	9.64	3.49
	24	9.30	3.91	9.66	3.77	9.81	3.71	9.60	3.66	9.26	3.58

Combination (Capacity)	Indoor Air Temp. °C DB	Outdoor Air Temp. °C											
		16/15		15/14		10/9		7/6		6/5		2/1	
		Total Q	Input Power	Total Q	Input Power	Total Q	Input Power	Total Q	Input Power	Total Q	Input Power	Total Q	Input Power
2.0 + 4.2 + 4.2 + 5.0	16	20.00	2.82	19.59	2.90	17.53	3.25	16.30	3.47	15.50	3.52	12.31	3.73
	18	19.17	2.94	18.74	3.01	16.62	3.35	15.34	3.56	14.60	3.61	11.63	3.80
	20	18.88	3.02	18.39	3.09	15.89	3.43	14.40	3.63	13.70	3.67	10.88	3.81
	21	18.91	3.05	18.35	3.10	15.55	3.36	13.87	3.51	13.19	3.58	10.48	3.83
	22	19.07	3.08	18.55	3.15	15.92	3.49	14.35	3.70	13.49	3.73	10.06	3.85
	24	19.76	3.10	18.96	3.18	14.96	3.54	12.55	3.75	11.87	3.78	9.15	3.89
2.0 + 4.2 + 4.2 + 6.0	16	20.00	2.82	19.59	2.90	17.53	3.25	16.30	3.47	15.50	3.52	12.31	3.73
	18	19.17	2.94	18.74	3.01	16.62	3.35	15.34	3.56	14.60	3.61	11.63	3.80
	20	18.88	3.02	18.39	3.09	15.89	3.43	14.40	3.63	13.70	3.67	10.88	3.81
	21	18.91	3.05	18.35	3.10	15.55	3.36	13.87	3.51	13.19	3.58	10.48	3.83
	22	19.07	3.08	18.55	3.15	15.92	3.49	14.35	3.70	13.49	3.73	10.06	3.85
	24	19.76	3.10	18.96	3.18	14.96	3.54	12.55	3.75	11.87	3.78	9.15	3.89
2.0 + 4.2 + 4.2 + 7.1	16	20.00	2.81	19.59	2.88	17.53	3.24	16.30	3.45	15.50	3.50	12.31	3.70
	18	19.17	2.93	18.74	2.99	16.62	3.33	15.34	3.54	14.60	3.59	11.63	3.78
	20	18.88	3.00	18.39	3.07	15.89	3.41	14.40	3.61	13.70	3.65	10.88	3.79
	21	18.91	3.04	18.35	3.09	15.55	3.34	13.87	3.49	13.19	3.56	10.48	3.81
	22	19.07	3.06	18.55	3.13	15.92	3.47	14.35	3.68	13.49	3.71	10.06	3.83
	24	19.76	3.09	18.96	3.16	14.96	3.52	12.55	3.73	11.87	3.76	9.15	3.87
2.0 + 4.2 + 5.0 + 5.0	16	20.00	2.78	19.59	2.85	17.53	3.20	16.30	3.41	15.50	3.46	12.31	3.66
	18	19.17	2.89	18.74	2.96	16.62	3.30	15.34	3.50	14.60	3.55	11.63	3.74
	20	18.88	2.97	18.39	3.04	15.89	3.37	14.40	3.57	13.70	3.61	10.88	3.75
	21	18.91	3.00	18.35	3.05	15.55	3.30	13.87	3.45	13.19	3.52	10.48	3.77
	22	19.07	3.03	18.55	3.09	15.92	3.43	14.35	3.64	13.49	3.67	10.06	3.78
	24	19.76	3.05	18.96	3.12	14.96	3.48	12.55	3.69	11.87	3.72	9.15	3.82
2.0 + 4.2 + 5.0 + 6.0	16	20.00	2.78	19.59	2.85	17.53	3.20	16.30	3.41	15.50	3.46	12.31	3.66
	18	19.17	2.89	18.74	2.96	16.62	3.30	15.34	3.50	14.60	3.55	11.63	3.74
	20	18.88	2.97	18.39	3.04	15.89	3.37	14.40	3.57	13.70	3.61	10.88	3.75
	21	18.91	3.00	18.35	3.05	15.55	3.30	13.87	3.45	13.19	3.52	10.48	3.77
	22	19.07	3.03	18.55	3.09	15.92	3.43	14.35	3.64	13.49	3.67	10.06	3.78
	24	19.76	3.05	18.96	3.12	14.96	3.48	12.55	3.69	11.87	3.72	9.15	3.82
2.0 + 4.2 + 5.0 + 7.1	16	20.00	2.76	19.59	2.83	17.53	3.18	16.30	3.39	15.50	3.44	12.31	3.64
	18	19.17	2.88	18.74	2.94	16.62	3.28	15.34	3.48	14.60	3.53	11.63	3.71
	20	18.88	2.95	18.39	3.02	15.89	3.35	14.40	3.55	13.70	3.59	10.88	3.73
	21	18.91	2.99	18.35	3.04	15.55	3.28	13.87	3.43	13.19	3.50	10.48	3.75
	22	19.07	3.01	18.55	3.08	15.92	3.41	14.35	3.62	13.49	3.65	10.06	3.76
	24	19.76	3.04	18.96	3.11	14.96	3.46	12.55	3.67	11.87	3.70	9.15	3.80



Combination (Capacity)	Indoor Air Temp. °C DB	Outdoor Air Temp. °C									
		0/-1		-5/-6		-7/-8		-10/-11		-15/-	
		Total Q	Input Power	Total Q	Input Power	Total Q	Input Power	Total Q	Input Power	Total Q	Input Power
2.0 + 4.2 + 4.2 + 5.0	16	11.95	3.68	11.05	3.56	10.69	3.51	10.27	3.39	9.58	3.19
	18	11.32	3.74	10.54	3.59	9.85	3.53	10.07	3.42	9.81	3.25
	20	10.67	3.76	10.14	3.61	9.93	3.55	9.89	3.47	9.84	3.34
	21	10.23	3.77	9.61	3.63	9.36	3.57	9.51	3.50	9.77	3.38
	22	10.00	3.79	9.85	3.64	9.79	3.59	9.74	3.52	9.64	3.42
	24	9.30	3.83	9.66	3.69	9.81	3.63	9.60	3.58	9.26	3.50
2.0 + 4.2 + 4.2 + 6.0	16	11.95	3.68	11.05	3.56	10.69	3.51	10.27	3.39	9.58	3.19
	18	11.32	3.74	10.54	3.59	9.85	3.53	10.07	3.42	9.81	3.25
	20	10.67	3.76	10.14	3.61	9.93	3.55	9.89	3.47	9.84	3.34
	21	10.23	3.77	9.61	3.63	9.36	3.57	9.51	3.50	9.77	3.38
	22	10.00	3.79	9.85	3.64	9.79	3.59	9.74	3.52	9.64	3.42
	24	9.30	3.83	9.66	3.69	9.81	3.63	9.60	3.58	9.26	3.50
2.0 + 4.2 + 4.2 + 7.1	16	11.95	3.66	11.05	3.54	10.69	3.49	10.27	3.37	9.58	3.17
	18	11.32	3.72	10.54	3.57	9.85	3.51	10.07	3.41	9.81	3.23
	20	10.67	3.74	10.14	3.59	9.93	3.53	9.89	3.45	9.84	3.32
	21	10.23	3.75	9.61	3.61	9.36	3.55	9.51	3.48	9.77	3.36
	22	10.00	3.77	9.85	3.62	9.79	3.57	9.74	3.50	9.64	3.40
	24	9.30	3.81	9.66	3.67	9.81	3.61	9.60	3.56	9.26	3.48
2.0 + 4.2 + 5.0 + 5.0	16	11.95	3.62	11.05	3.50	10.69	3.45	10.27	3.33	9.58	3.14
	18	11.32	3.68	10.54	3.53	9.85	3.47	10.07	3.37	9.81	3.20
	20	10.67	3.69	10.14	3.55	9.93	3.49	9.89	3.41	9.84	3.28
	21	10.23	3.71	9.61	3.57	9.36	3.51	9.51	3.44	9.77	3.32
	22	10.00	3.73	9.85	3.58	9.79	3.53	9.74	3.46	9.64	3.36
	24	9.30	3.77	9.66	3.63	9.81	3.57	9.60	3.52	9.26	3.44
2.0 + 4.2 + 5.0 + 6.0	16	11.95	3.62	11.05	3.50	10.69	3.45	10.27	3.33	9.58	3.14
	18	11.32	3.68	10.54	3.53	9.85	3.47	10.07	3.37	9.81	3.20
	20	10.67	3.69	10.14	3.55	9.93	3.49	9.89	3.41	9.84	3.28
	21	10.23	3.71	9.61	3.57	9.36	3.51	9.51	3.44	9.77	3.32
	22	10.00	3.73	9.85	3.58	9.79	3.53	9.74	3.46	9.64	3.36
	24	9.30	3.77	9.66	3.63	9.81	3.57	9.60	3.52	9.26	3.44
2.0 + 4.2 + 5.0 + 7.1	16	11.95	3.60	11.05	3.48	10.69	3.44	10.27	3.32	9.58	3.12
	18	11.32	3.66	10.54	3.51	9.85	3.45	10.07	3.35	9.81	3.18
	20	10.67	3.67	10.14	3.53	9.93	3.47	9.89	3.40	9.84	3.27
	21	10.23	3.69	9.61	3.55	9.36	3.49	9.51	3.42	9.77	3.30
	22	10.00	3.71	9.85	3.56	9.79	3.51	9.74	3.44	9.64	3.34
	24	9.30	3.75	9.66	3.61	9.81	3.55	9.60	3.50	9.26	3.42

Combination (Capacity)	Indoor Air Temp. °C DB	Outdoor Air Temp. °C											
		16/15		15/14		10/9		7/6		6/5		2/1	
		Total Q	Input Power	Total Q	Input Power	Total Q	Input Power	Total Q	Input Power	Total Q	Input Power	Total Q	Input Power
2.0 + 4.2 + 6.0 + 6.0	16	20.00	2.78	19.59	2.85	17.53	3.20	16.30	3.41	15.50	3.46	12.31	3.66
	18	19.17	2.89	18.74	2.96	16.62	3.30	15.34	3.50	14.60	3.55	11.63	3.74
	20	18.88	2.97	18.39	3.04	15.89	3.37	14.40	3.57	13.70	3.61	10.88	3.75
	21	18.91	3.00	18.35	3.05	15.55	3.30	13.87	3.45	13.19	3.52	10.48	3.77
	22	19.07	3.03	18.55	3.09	15.92	3.43	14.35	3.64	13.49	3.67	10.06	3.78
	24	19.76	3.05	18.96	3.12	14.96	3.48	12.55	3.69	11.87	3.72	9.15	3.82
2.0 + 5.0 + 5.0 + 5.0	16	20.00	2.78	19.59	2.85	17.53	3.20	16.30	3.41	15.50	3.46	12.31	3.66
	18	19.17	2.89	18.74	2.96	16.62	3.30	15.34	3.50	14.60	3.55	11.63	3.74
	20	18.88	2.97	18.39	3.04	15.89	3.37	14.40	3.57	13.70	3.61	10.88	3.75
	21	18.91	3.00	18.35	3.05	15.55	3.30	13.87	3.45	13.19	3.52	10.48	3.77
	22	19.07	3.03	18.55	3.09	15.92	3.43	14.35	3.64	13.49	3.67	10.06	3.78
	24	19.76	3.05	18.96	3.12	14.96	3.48	12.55	3.69	11.87	3.72	9.15	3.82
2.0 + 5.0 + 5.0 + 6.0	16	20.00	2.78	19.59	2.85	17.53	3.20	16.30	3.41	15.50	3.46	12.31	3.66
	18	19.17	2.89	18.74	2.96	16.62	3.30	15.34	3.50	14.60	3.55	11.63	3.74
	20	18.88	2.97	18.39	3.04	15.89	3.37	14.40	3.57	13.70	3.61	10.88	3.75
	21	18.91	3.00	18.35	3.05	15.55	3.30	13.87	3.45	13.19	3.52	10.48	3.77
	22	19.07	3.03	18.55	3.09	15.92	3.43	14.35	3.64	13.49	3.67	10.06	3.78
	24	19.76	3.05	18.96	3.12	14.96	3.48	12.55	3.69	11.87	3.72	9.15	3.82
2.5 + 2.5 + 2.5 + 2.5	16	19.72	2.95	19.32	3.02	17.29	3.40	16.07	3.62	15.29	3.67	12.14	3.89
	18	18.90	3.07	18.48	3.14	16.39	3.50	15.13	3.71	14.40	3.76	11.47	3.97
	20	18.62	3.15	18.13	3.22	15.67	3.58	14.20	3.79	13.51	3.83	10.73	3.98
	21	18.65	3.19	18.09	3.24	15.33	3.51	13.67	3.67	13.01	3.73	10.34	4.00
	22	18.80	3.21	18.29	3.28	15.70	3.64	14.15	3.86	13.30	3.89	9.92	4.02
	24	19.49	3.24	18.70	3.32	14.75	3.69	12.38	3.92	11.71	3.95	9.03	4.06
2.5 + 2.5 + 2.5 + 3.5	16	19.72	2.93	19.32	3.00	17.29	3.37	16.07	3.59	15.29	3.65	12.14	3.86
	18	18.90	3.05	18.48	3.12	16.39	3.47	15.13	3.68	14.40	3.73	11.47	3.93
	20	18.62	3.13	18.13	3.20	15.67	3.55	14.20	3.76	13.51	3.80	10.73	3.95
	21	18.65	3.16	18.09	3.22	15.33	3.48	13.67	3.64	13.01	3.70	10.34	3.97
	22	18.80	3.19	18.29	3.26	15.70	3.62	14.15	3.83	13.30	3.86	9.92	3.99
	24	19.49	3.22	18.70	3.29	14.75	3.66	12.38	3.89	11.71	3.92	9.03	4.03
2.5 + 2.5 + 2.5 + 4.2	16	19.72	2.91	19.32	2.98	17.29	3.35	16.07	3.57	15.29	3.63	12.14	3.84
	18	18.90	3.03	18.48	3.10	16.39	3.45	15.13	3.67	14.40	3.71	11.47	3.91
	20	18.62	3.11	18.13	3.18	15.67	3.53	14.20	3.74	13.51	3.78	10.73	3.93
	21	18.65	3.15	18.09	3.20	15.33	3.46	13.67	3.62	13.01	3.68	10.34	3.95
	22	18.80	3.17	18.29	3.24	15.70	3.60	14.15	3.81	13.30	3.84	9.92	3.96
	24	19.49	3.20	18.70	3.27	14.75	3.64	12.38	3.87	11.71	3.89	9.03	4.01

Combination (Capacity)	Indoor Air Temp. °C DB	Outdoor Air Temp. °C									
		0/-1		-5/-6		-7/-8		-10/-11		-15/-	
		Total Q	Input Power	Total Q	Input Power	Total Q	Input Power	Total Q	Input Power	Total Q	Input Power
2.0 + 4.2 + 6.0 + 6.0	16	11.95	3.62	11.05	3.50	10.69	3.45	10.27	3.33	9.58	3.14
	18	11.32	3.68	10.54	3.53	9.85	3.47	10.07	3.37	9.81	3.20
	20	10.67	3.69	10.14	3.55	9.93	3.49	9.89	3.41	9.84	3.28
	21	10.23	3.71	9.61	3.57	9.36	3.51	9.51	3.44	9.77	3.32
	22	10.00	3.73	9.85	3.58	9.79	3.53	9.74	3.46	9.64	3.36
	24	9.30	3.77	9.66	3.63	9.81	3.57	9.60	3.52	9.26	3.44
2.0 + 5.0 + 5.0 + 5.0	16	11.95	3.62	11.05	3.50	10.69	3.45	10.27	3.33	9.58	3.14
	18	11.32	3.68	10.54	3.53	9.85	3.47	10.07	3.37	9.81	3.20
	20	10.67	3.69	10.14	3.55	9.93	3.49	9.89	3.41	9.84	3.28
	21	10.23	3.71	9.61	3.57	9.36	3.51	9.51	3.44	9.77	3.32
	22	10.00	3.73	9.85	3.58	9.79	3.53	9.74	3.46	9.64	3.36
	24	9.30	3.77	9.66	3.63	9.81	3.57	9.60	3.52	9.26	3.44
2.0 + 5.0 + 5.0 + 6.0	16	11.95	3.62	11.05	3.50	10.69	3.45	10.27	3.33	9.58	3.14
	18	11.32	3.68	10.54	3.53	9.85	3.47	10.07	3.37	9.81	3.20
	20	10.67	3.69	10.14	3.55	9.93	3.49	9.89	3.41	9.84	3.28
	21	10.23	3.71	9.61	3.57	9.36	3.51	9.51	3.44	9.77	3.32
	22	10.00	3.73	9.85	3.58	9.79	3.53	9.74	3.46	9.64	3.36
	24	9.30	3.77	9.66	3.63	9.81	3.57	9.60	3.52	9.26	3.44
2.5 + 2.5 + 2.5 + 2.5	16	11.79	3.84	10.90	3.72	10.54	3.67	10.13	3.54	9.45	3.33
	18	11.16	3.90	10.39	3.75	9.71	3.68	9.93	3.58	9.67	3.39
	20	10.52	3.92	10.00	3.77	9.79	3.71	9.75	3.63	9.70	3.49
	21	10.09	3.94	9.47	3.79	9.23	3.73	9.38	3.65	9.63	3.53
	22	9.86	3.96	9.71	3.80	9.66	3.74	9.60	3.68	9.51	3.57
	24	9.17	4.00	9.53	3.85	9.67	3.79	9.47	3.74	9.13	3.66
2.5 + 2.5 + 2.5 + 3.5	16	11.79	3.81	10.90	3.69	10.54	3.64	10.13	3.51	9.45	3.30
	18	11.16	3.87	10.39	3.72	9.71	3.66	9.93	3.55	9.67	3.37
	20	10.52	3.89	10.00	3.74	9.79	3.68	9.75	3.60	9.70	3.46
	21	10.09	3.91	9.47	3.76	9.23	3.70	9.38	3.62	9.63	3.50
	22	9.86	3.93	9.71	3.77	9.66	3.71	9.60	3.65	9.51	3.54
	24	9.17	3.97	9.53	3.82	9.67	3.76	9.47	3.71	9.13	3.63
2.5 + 2.5 + 2.5 + 4.2	16	11.79	3.79	10.90	3.67	10.54	3.62	10.13	3.49	9.45	3.28
	18	11.16	3.85	10.39	3.70	9.71	3.64	9.93	3.53	9.67	3.35
	20	10.52	3.87	10.00	3.72	9.79	3.66	9.75	3.58	9.70	3.44
	21	10.09	3.89	9.47	3.74	9.23	3.68	9.38	3.60	9.63	3.48
	22	9.86	3.90	9.71	3.75	9.66	3.69	9.60	3.63	9.51	3.52
	24	9.17	3.95	9.53	3.80	9.67	3.74	9.47	3.69	9.13	3.61

Combination (Capacity)	Indoor Air Temp. °C DB	Outdoor Air Temp. °C											
		16/15		15/14		10/9		7/6		6/5		2/1	
		Total Q	Input Power	Total Q	Input Power	Total Q	Input Power	Total Q	Input Power	Total Q	Input Power	Total Q	Input Power
2.5 + 2.5 + 2.5 + 5.0	16	19.72	2.80	19.32	2.87	17.29	3.23	16.07	3.44	15.29	3.49	12.14	3.69
	18	18.90	2.92	18.48	2.99	16.39	3.32	15.13	3.53	14.40	3.58	11.47	3.77
	20	18.62	3.00	18.13	3.06	15.67	3.40	14.20	3.60	13.51	3.64	10.73	3.78
	21	18.65	3.03	18.09	3.08	15.33	3.33	13.67	3.48	13.01	3.55	10.34	3.80
	22	18.80	3.05	18.29	3.12	15.70	3.46	14.15	3.67	13.30	3.70	9.92	3.82
	24	19.49	3.08	18.70	3.15	14.75	3.51	12.38	3.72	11.71	3.75	9.03	3.86
2.5 + 2.5 + 2.5 + 6.0	16	20.00	2.85	19.59	2.92	17.53	3.28	16.30	3.50	15.50	3.55	12.31	3.76
	18	19.17	2.97	18.74	3.04	16.62	3.38	15.34	3.59	14.60	3.64	11.63	3.83
	20	18.88	3.05	18.39	3.11	15.89	3.46	14.40	3.66	13.70	3.70	10.88	3.85
	21	18.91	3.08	18.35	3.13	15.55	3.39	13.87	3.54	13.19	3.60	10.48	3.86
	22	19.07	3.10	18.55	3.17	15.92	3.52	14.35	3.73	13.49	3.76	10.06	3.88
	24	19.76	3.13	18.96	3.20	14.96	3.57	12.55	3.78	11.87	3.81	9.15	3.92
2.5 + 2.5 + 2.5 + 7.1	16	20.00	2.83	19.59	2.90	17.53	3.26	16.30	3.48	15.50	3.53	12.31	3.74
	18	19.17	2.95	18.74	3.02	16.62	3.36	15.34	3.57	14.60	3.62	11.63	3.81
	20	18.88	3.03	18.39	3.10	15.89	3.44	14.40	3.64	13.70	3.68	10.88	3.83
	21	18.91	3.06	18.35	3.11	15.55	3.37	13.87	3.52	13.19	3.58	10.48	3.84
	22	19.07	3.08	18.55	3.15	15.92	3.50	14.35	3.71	13.49	3.74	10.06	3.86
	24	19.76	3.11	18.96	3.19	14.96	3.55	12.55	3.76	11.87	3.79	9.15	3.90
2.5 + 2.5 + 3.5 + 3.5	16	19.72	2.85	19.32	2.92	17.29	3.28	16.07	3.50	15.29	3.55	12.14	3.76
	18	18.90	2.97	18.48	3.04	16.39	3.38	15.13	3.59	14.40	3.64	11.47	3.83
	20	18.62	3.05	18.13	3.11	15.67	3.46	14.20	3.66	13.51	3.70	10.73	3.85
	21	18.65	3.08	18.09	3.13	15.33	3.39	13.67	3.54	13.01	3.60	10.34	3.86
	22	18.80	3.10	18.29	3.17	15.70	3.52	14.15	3.73	13.30	3.76	9.92	3.88
	24	19.49	3.13	18.70	3.20	14.75	3.57	12.38	3.78	11.71	3.81	9.03	3.92
2.5 + 2.5 + 3.5 + 4.2	16	19.72	2.84	19.32	2.91	17.29	3.27	16.07	3.49	15.29	3.54	12.14	3.75
	18	18.90	2.96	18.48	3.03	16.39	3.37	15.13	3.58	14.40	3.63	11.47	3.82
	20	18.62	3.04	18.13	3.11	15.67	3.45	14.20	3.65	13.51	3.69	10.73	3.84
	21	18.65	3.07	18.09	3.12	15.33	3.38	13.67	3.53	13.01	3.59	10.34	3.85
	22	18.80	3.09	18.29	3.16	15.70	3.51	14.15	3.72	13.30	3.75	9.92	3.87
	24	19.49	3.12	18.70	3.19	14.75	3.56	12.38	3.77	11.71	3.80	9.03	3.91
2.5 + 2.5 + 3.5 + 5.0	16	20.00	2.82	19.59	2.90	17.53	3.25	16.30	3.47	15.50	3.52	12.31	3.73
	18	19.17	2.94	18.74	3.01	16.62	3.35	15.34	3.56	14.60	3.61	11.63	3.80
	20	18.88	3.02	18.39	3.09	15.89	3.43	14.40	3.63	13.70	3.67	10.88	3.81
	21	18.91	3.05	18.35	3.10	15.55	3.36	13.87	3.51	13.19	3.58	10.48	3.83
	22	19.07	3.08	18.55	3.15	15.92	3.49	14.35	3.70	13.49	3.73	10.06	3.85
	24	19.76	3.10	18.96	3.18	14.96	3.54	12.55	3.75	11.87	3.78	9.15	3.89

Combination (Capacity)	Indoor Air Temp. °C DB	Outdoor Air Temp. °C									
		0/-1		-5/-6		-7/-8		-10/-11		-15/-	
		Total Q	Input Power	Total Q	Input Power	Total Q	Input Power	Total Q	Input Power	Total Q	Input Power
2.5 + 2.5 + 2.5 + 5.0	16	11.79	3.65	10.90	3.53	10.54	3.48	10.13	3.36	9.45	3.16
	18	11.16	3.71	10.39	3.56	9.71	3.50	9.93	3.40	9.67	3.22
	20	10.52	3.73	10.00	3.58	9.79	3.52	9.75	3.44	9.70	3.31
	21	10.09	3.74	9.47	3.60	9.23	3.54	9.38	3.47	9.63	3.35
	22	9.86	3.76	9.71	3.61	9.66	3.56	9.60	3.49	9.51	3.39
	24	9.17	3.80	9.53	3.66	9.67	3.60	9.47	3.55	9.13	3.47
2.5 + 2.5 + 2.5 + 6.0	16	11.95	3.71	11.05	3.59	10.69	3.54	10.27	3.42	9.58	3.21
	18	11.32	3.77	10.54	3.62	9.85	3.56	10.07	3.45	9.81	3.28
	20	10.67	3.79	10.14	3.64	9.93	3.58	9.89	3.50	9.84	3.37
	21	10.23	3.80	9.61	3.66	9.36	3.60	9.51	3.53	9.77	3.41
	22	10.00	3.82	9.85	3.67	9.79	3.61	9.74	3.55	9.64	3.45
	24	9.30	3.86	9.66	3.72	9.81	3.66	9.60	3.61	9.26	3.53
2.5 + 2.5 + 2.5 + 7.1	16	11.95	3.69	11.05	3.57	10.69	3.52	10.27	3.40	9.58	3.20
	18	11.32	3.75	10.54	3.60	9.85	3.54	10.07	3.43	9.81	3.26
	20	10.67	3.77	10.14	3.62	9.93	3.56	9.89	3.48	9.84	3.35
	21	10.23	3.78	9.61	3.64	9.36	3.58	9.51	3.51	9.77	3.39
	22	10.00	3.80	9.85	3.65	9.79	3.60	9.74	3.53	9.64	3.43
	24	9.30	3.84	9.66	3.70	9.81	3.64	9.60	3.59	9.26	3.51
2.5 + 2.5 + 3.5 + 3.5	16	11.79	3.71	10.90	3.59	10.54	3.54	10.13	3.42	9.45	3.21
	18	11.16	3.77	10.39	3.62	9.71	3.56	9.93	3.45	9.67	3.28
	20	10.52	3.79	10.00	3.64	9.79	3.58	9.75	3.50	9.70	3.37
	21	10.09	3.80	9.47	3.66	9.23	3.60	9.38	3.53	9.63	3.41
	22	9.86	3.82	9.71	3.67	9.66	3.61	9.60	3.55	9.51	3.45
	24	9.17	3.86	9.53	3.72	9.67	3.66	9.47	3.61	9.13	3.53
2.5 + 2.5 + 3.5 + 4.2	16	11.79	3.70	10.90	3.58	10.54	3.53	10.13	3.41	9.45	3.21
	18	11.16	3.76	10.39	3.61	9.71	3.55	9.93	3.44	9.67	3.27
	20	10.52	3.78	10.00	3.63	9.79	3.57	9.75	3.49	9.70	3.36
	21	10.09	3.79	9.47	3.65	9.23	3.59	9.38	3.52	9.63	3.40
	22	9.86	3.81	9.71	3.66	9.66	3.61	9.60	3.54	9.51	3.44
	24	9.17	3.85	9.53	3.71	9.67	3.65	9.47	3.60	9.13	3.52
2.5 + 2.5 + 3.5 + 5.0	16	11.95	3.68	11.05	3.56	10.69	3.51	10.27	3.39	9.58	3.19
	18	11.32	3.74	10.54	3.59	9.85	3.53	10.07	3.42	9.81	3.25
	20	10.67	3.76	10.14	3.61	9.93	3.55	9.89	3.47	9.84	3.34
	21	10.23	3.77	9.61	3.63	9.36	3.57	9.51	3.50	9.77	3.38
	22	10.00	3.79	9.85	3.64	9.79	3.59	9.74	3.52	9.64	3.42
	24	9.30	3.83	9.66	3.69	9.81	3.63	9.60	3.58	9.26	3.50

Combination (Capacity)	Indoor Air Temp. °C DB	Outdoor Air Temp. °C											
		16/15		15/14		10/9		7/6		6/5		2/1	
		Total Q	Input Power	Total Q	Input Power	Total Q	Input Power	Total Q	Input Power	Total Q	Input Power	Total Q	Input Power
2.5 + 2.5 + 3.5 + 6.0	16	20.00	2.82	19.59	2.90	17.53	3.25	16.30	3.47	15.50	3.52	12.31	3.73
	18	19.17	2.94	18.74	3.01	16.62	3.35	15.34	3.56	14.60	3.61	11.63	3.80
	20	18.88	3.02	18.39	3.09	15.89	3.43	14.40	3.63	13.70	3.67	10.88	3.81
	21	18.91	3.05	18.35	3.10	15.55	3.36	13.87	3.51	13.19	3.58	10.48	3.83
	22	19.07	3.08	18.55	3.15	15.92	3.49	14.35	3.70	13.49	3.73	10.06	3.85
	24	19.76	3.10	18.96	3.18	14.96	3.54	12.55	3.75	11.87	3.78	9.15	3.89
2.5 + 2.5 + 3.5 + 7.1	16	20.00	2.81	19.59	2.88	17.53	3.24	16.30	3.45	15.50	3.50	12.31	3.70
	18	19.17	2.93	18.74	2.99	16.62	3.33	15.34	3.54	14.60	3.59	11.63	3.78
	20	18.88	3.00	18.39	3.07	15.89	3.41	14.40	3.61	13.70	3.65	10.88	3.79
	21	18.91	3.04	18.35	3.09	15.55	3.34	13.87	3.49	13.19	3.56	10.48	3.81
	22	19.07	3.06	18.55	3.13	15.92	3.47	14.35	3.68	13.49	3.71	10.06	3.83
	24	19.76	3.09	18.96	3.16	14.96	3.52	12.55	3.73	11.87	3.76	9.15	3.87
2.5 + 2.5 + 4.2 + 4.2	16	20.00	2.93	19.59	3.00	17.53	3.37	16.30	3.59	15.50	3.65	12.31	3.86
	18	19.17	3.05	18.74	3.12	16.62	3.47	15.34	3.68	14.60	3.73	11.63	3.93
	20	18.88	3.13	18.39	3.20	15.89	3.55	14.40	3.76	13.70	3.80	10.88	3.95
	21	18.91	3.16	18.35	3.22	15.55	3.48	13.87	3.64	13.19	3.70	10.48	3.97
	22	19.07	3.19	18.55	3.26	15.92	3.62	14.35	3.83	13.49	3.86	10.06	3.99
	24	19.76	3.22	18.96	3.29	14.96	3.66	12.55	3.89	11.87	3.92	9.15	4.03
2.5 + 2.5 + 4.2 + 5.0	16	20.00	2.82	19.59	2.89	17.53	3.24	16.30	3.46	15.50	3.51	12.31	3.71
	18	19.17	2.93	18.74	3.00	16.62	3.34	15.34	3.55	14.60	3.60	11.63	3.79
	20	18.88	3.01	18.39	3.08	15.89	3.42	14.40	3.62	13.70	3.66	10.88	3.80
	21	18.91	3.05	18.35	3.10	15.55	3.35	13.87	3.50	13.19	3.57	10.48	3.82
	22	19.07	3.07	18.55	3.14	15.92	3.48	14.35	3.69	13.49	3.72	10.06	3.84
	24	19.76	3.10	18.96	3.17	14.96	3.53	12.55	3.74	11.87	3.77	9.15	3.88
2.5 + 2.5 + 4.2 + 6.0	16	20.00	2.82	19.59	2.89	17.53	3.24	16.30	3.46	15.50	3.51	12.31	3.71
	18	19.17	2.93	18.74	3.00	16.62	3.34	15.34	3.55	14.60	3.60	11.63	3.79
	20	18.88	3.01	18.39	3.08	15.89	3.42	14.40	3.62	13.70	3.66	10.88	3.80
	21	18.91	3.05	18.35	3.10	15.55	3.35	13.87	3.50	13.19	3.57	10.48	3.82
	22	19.07	3.07	18.55	3.14	15.92	3.48	14.35	3.69	13.49	3.72	10.06	3.84
	24	19.76	3.10	18.96	3.17	14.96	3.53	12.55	3.74	11.87	3.77	9.15	3.88
2.5 + 2.5 + 4.2 + 7.1	16	20.00	2.85	19.59	2.92	17.53	3.28	16.30	3.50	15.50	3.55	12.31	3.76
	18	19.17	2.97	18.74	3.04	16.62	3.38	15.34	3.59	14.60	3.64	11.63	3.83
	20	18.88	3.05	18.39	3.11	15.89	3.46	14.40	3.66	13.70	3.70	10.88	3.85
	21	18.91	3.08	18.35	3.13	15.55	3.39	13.87	3.54	13.19	3.60	10.48	3.86
	22	19.07	3.10	18.55	3.17	15.92	3.52	14.35	3.73	13.49	3.76	10.06	3.88
	24	19.76	3.13	18.96	3.20	14.96	3.57	12.55	3.78	11.87	3.81	9.15	3.92

Combination (Capacity)	Indoor Air Temp. °C DB	Outdoor Air Temp. °C									
		0/-1		-5/-6		-7/-8		-10/-11		-15/-	
		Total Q	Input Power	Total Q	Input Power	Total Q	Input Power	Total Q	Input Power	Total Q	Input Power
2.5 + 2.5 + 3.5 + 6.0	16	11.95	3.68	11.05	3.56	10.69	3.51	10.27	3.39	9.58	3.19
	18	11.32	3.74	10.54	3.59	9.85	3.53	10.07	3.42	9.81	3.25
	20	10.67	3.76	10.14	3.61	9.93	3.55	9.89	3.47	9.84	3.34
	21	10.23	3.77	9.61	3.63	9.36	3.57	9.51	3.50	9.77	3.38
	22	10.00	3.79	9.85	3.64	9.79	3.59	9.74	3.52	9.64	3.42
	24	9.30	3.83	9.66	3.69	9.81	3.63	9.60	3.58	9.26	3.50
2.5 + 2.5 + 3.5 + 7.1	16	11.95	3.66	11.05	3.54	10.69	3.49	10.27	3.37	9.58	3.17
	18	11.32	3.72	10.54	3.57	9.85	3.51	10.07	3.41	9.81	3.23
	20	10.67	3.74	10.14	3.59	9.93	3.53	9.89	3.45	9.84	3.32
	21	10.23	3.75	9.61	3.61	9.36	3.55	9.51	3.48	9.77	3.36
	22	10.00	3.77	9.85	3.62	9.79	3.57	9.74	3.50	9.64	3.40
	24	9.30	3.81	9.66	3.67	9.81	3.61	9.60	3.56	9.26	3.48
2.5 + 2.5 + 4.2 + 4.2	16	11.95	3.81	11.05	3.69	10.69	3.64	10.27	3.51	9.58	3.30
	18	11.32	3.87	10.54	3.72	9.85	3.66	10.07	3.55	9.81	3.37
	20	10.67	3.89	10.14	3.74	9.93	3.68	9.89	3.60	9.84	3.46
	21	10.23	3.91	9.61	3.76	9.36	3.70	9.51	3.62	9.77	3.50
	22	10.00	3.93	9.85	3.77	9.79	3.71	9.74	3.65	9.64	3.54
	24	9.30	3.97	9.66	3.82	9.81	3.76	9.60	3.71	9.26	3.63
2.5 + 2.5 + 4.2 + 5.0	16	11.95	3.67	11.05	3.55	10.69	3.50	10.27	3.38	9.58	3.18
	18	11.32	3.73	10.54	3.58	9.85	3.52	10.07	3.42	9.81	3.24
	20	10.67	3.75	10.14	3.60	9.93	3.54	9.89	3.46	9.84	3.33
	21	10.23	3.76	9.61	3.62	9.36	3.56	9.51	3.49	9.77	3.37
	22	10.00	3.78	9.85	3.63	9.79	3.58	9.74	3.51	9.64	3.41
	24	9.30	3.82	9.66	3.68	9.81	3.62	9.60	3.57	9.26	3.49
2.5 + 2.5 + 4.2 + 6.0	16	11.95	3.67	11.05	3.55	10.69	3.50	10.27	3.38	9.58	3.18
	18	11.32	3.73	10.54	3.58	9.85	3.52	10.07	3.42	9.81	3.24
	20	10.67	3.75	10.14	3.60	9.93	3.54	9.89	3.46	9.84	3.33
	21	10.23	3.76	9.61	3.62	9.36	3.56	9.51	3.49	9.77	3.37
	22	10.00	3.78	9.85	3.63	9.79	3.58	9.74	3.51	9.64	3.41
	24	9.30	3.82	9.66	3.68	9.81	3.62	9.60	3.57	9.26	3.49
2.5 + 2.5 + 4.2 + 7.1	16	11.95	3.71	11.05	3.59	10.69	3.54	10.27	3.42	9.58	3.21
	18	11.32	3.77	10.54	3.62	9.85	3.56	10.07	3.45	9.81	3.28
	20	10.67	3.79	10.14	3.64	9.93	3.58	9.89	3.50	9.84	3.37
	21	10.23	3.80	9.61	3.66	9.36	3.60	9.51	3.53	9.77	3.41
	22	10.00	3.82	9.85	3.67	9.79	3.61	9.74	3.55	9.64	3.45
	24	9.30	3.86	9.66	3.72	9.81	3.66	9.60	3.61	9.26	3.53

Combination (Capacity)	Indoor Air Temp. °C DB	Outdoor Air Temp. °C											
		16/15		15/14		10/9		7/6		6/5		2/1	
		Total Q	Input Power	Total Q	Input Power	Total Q	Input Power	Total Q	Input Power	Total Q	Input Power	Total Q	Input Power
2.5 + 2.5 + 5.0 + 5.0	16	20.00	2.80	19.59	2.87	17.53	3.23	16.30	3.44	15.50	3.49	12.31	3.69
	18	19.17	2.92	18.74	2.99	16.62	3.32	15.34	3.53	14.60	3.58	11.63	3.77
	20	18.88	3.00	18.39	3.06	15.89	3.40	14.40	3.60	13.70	3.64	10.88	3.78
	21	18.91	3.03	18.35	3.08	15.55	3.33	13.87	3.48	13.19	3.55	10.48	3.80
	22	19.07	3.05	18.55	3.12	15.92	3.46	14.35	3.67	13.49	3.70	10.06	3.82
	24	19.76	3.08	18.96	3.15	14.96	3.51	12.55	3.72	11.87	3.75	9.15	3.86
2.5 + 2.5 + 5.0 + 6.0	16	20.00	2.80	19.59	2.87	17.53	3.23	16.30	3.44	15.50	3.49	12.31	3.69
	18	19.17	2.92	18.74	2.99	16.62	3.32	15.34	3.53	14.60	3.58	11.63	3.77
	20	18.88	3.00	18.39	3.06	15.89	3.40	14.40	3.60	13.70	3.64	10.88	3.78
	21	18.91	3.03	18.35	3.08	15.55	3.33	13.87	3.48	13.19	3.55	10.48	3.80
	22	19.07	3.05	18.55	3.12	15.92	3.46	14.35	3.67	13.49	3.70	10.06	3.82
	24	19.76	3.08	18.96	3.15	14.96	3.51	12.55	3.72	11.87	3.75	9.15	3.86
2.5 + 2.5 + 5.0 + 7.1	16	20.00	2.79	19.59	2.86	17.53	3.22	16.30	3.43	15.50	3.48	12.31	3.68
	18	19.17	2.91	18.74	2.98	16.62	3.32	15.34	3.52	14.60	3.57	11.63	3.76
	20	18.88	2.99	18.39	3.05	15.89	3.39	14.40	3.59	13.70	3.63	10.88	3.77
	21	18.91	3.02	18.35	3.07	15.55	3.32	13.87	3.47	13.19	3.54	10.48	3.79
	22	19.07	3.04	18.55	3.11	15.92	3.45	14.35	3.66	13.49	3.69	10.06	3.81
	24	19.76	3.07	18.96	3.14	14.96	3.50	12.55	3.71	11.87	3.74	9.15	3.84
2.5 + 2.5 + 6.0 + 6.0	16	20.00	2.80	19.59	2.87	17.53	3.23	16.30	3.44	15.50	3.49	12.31	3.69
	18	19.17	2.92	18.74	2.99	16.62	3.32	15.34	3.53	14.60	3.58	11.63	3.77
	20	18.88	3.00	18.39	3.06	15.89	3.40	14.40	3.60	13.70	3.64	10.88	3.78
	21	18.91	3.03	18.35	3.08	15.55	3.33	13.87	3.48	13.19	3.55	10.48	3.80
	22	19.07	3.05	18.55	3.12	15.92	3.46	14.35	3.67	13.49	3.70	10.06	3.82
	24	19.76	3.08	18.96	3.15	14.96	3.51	12.55	3.72	11.87	3.75	9.15	3.86
2.5 + 2.5 + 6.0 + 7.1	16	20.00	2.79	19.59	2.86	17.53	3.22	16.30	3.43	15.50	3.48	12.31	3.68
	18	19.17	2.91	18.74	2.98	16.62	3.32	15.34	3.52	14.60	3.57	11.63	3.76
	20	18.88	2.99	18.39	3.05	15.89	3.39	14.40	3.59	13.70	3.63	10.88	3.77
	21	18.91	3.02	18.35	3.07	15.55	3.32	13.87	3.47	13.19	3.54	10.48	3.79
	22	19.07	3.04	18.55	3.11	15.92	3.45	14.35	3.66	13.49	3.69	10.06	3.81
	24	19.76	3.07	18.96	3.14	14.96	3.50	12.55	3.71	11.87	3.74	9.15	3.84
2.5 + 3.5 + 3.5 + 3.5	16	20.00	2.92	19.59	2.99	17.53	3.36	16.30	3.58	15.50	3.64	12.31	3.85
	18	19.17	3.04	18.74	3.11	16.62	3.46	15.34	3.67	14.60	3.72	11.63	3.92
	20	18.88	3.12	18.39	3.19	15.89	3.54	14.40	3.75	13.70	3.79	10.88	3.94
	21	18.91	3.15	18.35	3.21	15.55	3.47	13.87	3.63	13.19	3.69	10.48	3.96
	22	19.07	3.18	18.55	3.25	15.92	3.61	14.35	3.82	13.49	3.85	10.06	3.98
	24	19.76	3.21	18.96	3.28	14.96	3.65	12.55	3.88	11.87	3.90	9.15	4.02



Combination (Capacity)	Indoor Air Temp. °C DB	Outdoor Air Temp. °C									
		0/-1		-5/-6		-7/-8		-10/-11		-15/-	
		Total Q	Input Power	Total Q	Input Power	Total Q	Input Power	Total Q	Input Power	Total Q	Input Power
2.5 + 2.5 + 5.0 + 5.0	16	11.95	3.65	11.05	3.53	10.69	3.48	10.27	3.36	9.58	3.16
	18	11.32	3.71	10.54	3.56	9.85	3.50	10.07	3.40	9.81	3.22
	20	10.67	3.73	10.14	3.58	9.93	3.52	9.89	3.44	9.84	3.31
	21	10.23	3.74	9.61	3.60	9.36	3.54	9.51	3.47	9.77	3.35
	22	10.00	3.76	9.85	3.61	9.79	3.56	9.74	3.49	9.64	3.39
	24	9.30	3.80	9.66	3.66	9.81	3.60	9.60	3.55	9.26	3.47
2.5 + 2.5 + 5.0 + 6.0	16	11.95	3.65	11.05	3.53	10.69	3.48	10.27	3.36	9.58	3.16
	18	11.32	3.71	10.54	3.56	9.85	3.50	10.07	3.40	9.81	3.22
	20	10.67	3.73	10.14	3.58	9.93	3.52	9.89	3.44	9.84	3.31
	21	10.23	3.74	9.61	3.60	9.36	3.54	9.51	3.47	9.77	3.35
	22	10.00	3.76	9.85	3.61	9.79	3.56	9.74	3.49	9.64	3.39
	24	9.30	3.80	9.66	3.66	9.81	3.60	9.60	3.55	9.26	3.47
2.5 + 2.5 + 5.0 + 7.1	16	11.95	3.64	11.05	3.52	10.69	3.47	10.27	3.35	9.58	3.15
	18	11.32	3.70	10.54	3.55	9.85	3.49	10.07	3.39	9.81	3.21
	20	10.67	3.71	10.14	3.57	9.93	3.51	9.89	3.43	9.84	3.30
	21	10.23	3.73	9.61	3.59	9.36	3.53	9.51	3.46	9.77	3.34
	22	10.00	3.75	9.85	3.60	9.79	3.55	9.74	3.48	9.64	3.38
	24	9.30	3.79	9.66	3.65	9.81	3.59	9.60	3.54	9.26	3.46
2.5 + 2.5 + 6.0 + 6.0	16	11.95	3.65	11.05	3.53	10.69	3.48	10.27	3.36	9.58	3.16
	18	11.32	3.71	10.54	3.56	9.85	3.50	10.07	3.40	9.81	3.22
	20	10.67	3.73	10.14	3.58	9.93	3.52	9.89	3.44	9.84	3.31
	21	10.23	3.74	9.61	3.60	9.36	3.54	9.51	3.47	9.77	3.35
	22	10.00	3.76	9.85	3.61	9.79	3.56	9.74	3.49	9.64	3.39
	24	9.30	3.80	9.66	3.66	9.81	3.60	9.60	3.55	9.26	3.47
2.5 + 2.5 + 6.0 + 7.1	16	11.95	3.64	11.05	3.52	10.69	3.47	10.27	3.35	9.58	3.15
	18	11.32	3.70	10.54	3.55	9.85	3.49	10.07	3.39	9.81	3.21
	20	10.67	3.71	10.14	3.57	9.93	3.51	9.89	3.43	9.84	3.30
	21	10.23	3.73	9.61	3.59	9.36	3.53	9.51	3.46	9.77	3.34
	22	10.00	3.75	9.85	3.60	9.79	3.55	9.74	3.48	9.64	3.38
	24	9.30	3.79	9.66	3.65	9.81	3.59	9.60	3.54	9.26	3.46
2.5 + 3.5 + 3.5 + 3.5	16	11.95	3.80	11.05	3.68	10.69	3.63	10.27	3.50	9.58	3.29
	18	11.32	3.86	10.54	3.71	9.85	3.65	10.07	3.54	9.81	3.36
	20	10.67	3.88	10.14	3.73	9.93	3.67	9.89	3.59	9.84	3.45
	21	10.23	3.90	9.61	3.75	9.36	3.69	9.51	3.61	9.77	3.49
	22	10.00	3.91	9.85	3.76	9.79	3.70	9.74	3.64	9.64	3.53
	24	9.30	3.96	9.66	3.81	9.81	3.75	9.60	3.70	9.26	3.62

Combination (Capacity)	Indoor Air Temp. °C DB	Outdoor Air Temp. °C											
		16/15		15/14		10/9		7/6		6/5		2/1	
		Total Q	Input Power	Total Q	Input Power	Total Q	Input Power	Total Q	Input Power	Total Q	Input Power	Total Q	Input Power
2.5 + 3.5 + 3.5 + 4.2	16	20.00	2.90	19.59	2.98	17.53	3.34	16.30	3.56	15.50	3.62	12.31	3.83
	18	19.17	3.02	18.74	3.09	16.62	3.44	15.34	3.66	14.60	3.70	11.63	3.90
	20	18.88	3.10	18.39	3.17	15.89	3.52	14.40	3.73	13.70	3.77	10.88	3.92
	21	18.91	3.14	18.35	3.19	15.55	3.45	13.87	3.61	13.19	3.67	10.48	3.94
	22	19.07	3.16	18.55	3.23	15.92	3.59	14.35	3.80	13.49	3.83	10.06	3.95
	24	19.76	3.19	18.96	3.26	14.96	3.63	12.55	3.86	11.87	3.88	9.15	3.99
2.5 + 3.5 + 3.5 + 5.0	16	20.00	2.84	19.59	2.91	17.53	3.27	16.30	3.49	15.50	3.54	12.31	3.75
	18	19.17	2.96	18.74	3.03	16.62	3.37	15.34	3.58	14.60	3.63	11.63	3.82
	20	18.88	3.04	18.39	3.11	15.89	3.45	14.40	3.65	13.70	3.69	10.88	3.84
	21	18.91	3.07	18.35	3.12	15.55	3.38	13.87	3.53	13.19	3.59	10.48	3.85
	22	19.07	3.09	18.55	3.16	15.92	3.51	14.35	3.72	13.49	3.75	10.06	3.87
	24	19.76	3.12	18.96	3.19	14.96	3.56	12.55	3.77	11.87	3.80	9.15	3.91
2.5 + 3.5 + 3.5 + 6.0	16	20.00	2.84	19.59	2.91	17.53	3.27	16.30	3.49	15.50	3.54	12.31	3.75
	18	19.17	2.96	18.74	3.03	16.62	3.37	15.34	3.58	14.60	3.63	11.63	3.82
	20	18.88	3.04	18.39	3.11	15.89	3.45	14.40	3.65	13.70	3.69	10.88	3.84
	21	18.91	3.07	18.35	3.12	15.55	3.38	13.87	3.53	13.19	3.59	10.48	3.85
	22	19.07	3.09	18.55	3.16	15.92	3.51	14.35	3.72	13.49	3.75	10.06	3.87
	24	19.76	3.12	18.96	3.19	14.96	3.56	12.55	3.77	11.87	3.80	9.15	3.91
2.5 + 3.5 + 3.5 + 7.1	16	20.00	2.83	19.59	2.90	17.53	3.26	16.30	3.48	15.50	3.53	12.31	3.74
	18	19.17	2.95	18.74	3.02	16.62	3.36	15.34	3.57	14.60	3.62	11.63	3.81
	20	18.88	3.03	18.39	3.10	15.89	3.44	14.40	3.64	13.70	3.68	10.88	3.83
	21	18.91	3.06	18.35	3.11	15.55	3.37	13.87	3.52	13.19	3.58	10.48	3.84
	22	19.07	3.08	18.55	3.15	15.92	3.50	14.35	3.71	13.49	3.74	10.06	3.86
	24	19.76	3.11	18.96	3.19	14.96	3.55	12.55	3.76	11.87	3.79	9.15	3.90
2.5 + 3.5 + 4.2 + 4.2	16	20.00	2.89	19.59	2.97	17.53	3.33	16.30	3.55	15.50	3.61	12.31	3.82
	18	19.17	3.01	18.74	3.09	16.62	3.44	15.34	3.65	14.60	3.69	11.63	3.89
	20	18.88	3.10	18.39	3.16	15.89	3.51	14.40	3.72	13.70	3.76	10.88	3.91
	21	18.91	3.13	18.35	3.18	15.55	3.44	13.87	3.60	13.19	3.66	10.48	3.93
	22	19.07	3.15	18.55	3.22	15.92	3.58	14.35	3.79	13.49	3.82	10.06	3.94
	24	19.76	3.18	18.96	3.26	14.96	3.62	12.55	3.85	11.87	3.87	9.15	3.98
2.5 + 3.5 + 4.2 + 5.0	16	20.00	2.83	19.59	2.90	17.53	3.26	16.30	3.48	15.50	3.53	12.31	3.74
	18	19.17	2.95	18.74	3.02	16.62	3.36	15.34	3.57	14.60	3.62	11.63	3.81
	20	18.88	3.03	18.39	3.10	15.89	3.44	14.40	3.64	13.70	3.68	10.88	3.83
	21	18.91	3.06	18.35	3.11	15.55	3.37	13.87	3.52	13.19	3.58	10.48	3.84
	22	19.07	3.08	18.55	3.15	15.92	3.50	14.35	3.71	13.49	3.74	10.06	3.86
	24	19.76	3.11	18.96	3.19	14.96	3.55	12.55	3.76	11.87	3.79	9.15	3.90

Combination (Capacity)	Indoor Air Temp. °C DB	Outdoor Air Temp. °C									
		0/-1		-5/-6		-7/-8		-10/-11		-15/-	
		Total Q	Input Power	Total Q	Input Power	Total Q	Input Power	Total Q	Input Power	Total Q	Input Power
2.5 + 3.5 + 3.5 + 4.2	16	11.95	3.78	11.05	3.66	10.69	3.61	10.27	3.48	9.58	3.28
	18	11.32	3.84	10.54	3.69	9.85	3.63	10.07	3.52	9.81	3.34
	20	10.67	3.86	10.14	3.71	9.93	3.65	9.89	3.57	9.84	3.43
	21	10.23	3.88	9.61	3.73	9.36	3.67	9.51	3.59	9.77	3.47
	22	10.00	3.89	9.85	3.74	9.79	3.68	9.74	3.62	9.64	3.51
	24	9.30	3.94	9.66	3.79	9.81	3.73	9.60	3.68	9.26	3.60
2.5 + 3.5 + 3.5 + 5.0	16	11.95	3.70	11.05	3.58	10.69	3.53	10.27	3.41	9.58	3.21
	18	11.32	3.76	10.54	3.61	9.85	3.55	10.07	3.44	9.81	3.27
	20	10.67	3.78	10.14	3.63	9.93	3.57	9.89	3.49	9.84	3.36
	21	10.23	3.79	9.61	3.65	9.36	3.59	9.51	3.52	9.77	3.40
	22	10.00	3.81	9.85	3.66	9.79	3.61	9.74	3.54	9.64	3.44
	24	9.30	3.85	9.66	3.71	9.81	3.65	9.60	3.60	9.26	3.52
2.5 + 3.5 + 3.5 + 6.0	16	11.95	3.70	11.05	3.58	10.69	3.53	10.27	3.41	9.58	3.21
	18	11.32	3.76	10.54	3.61	9.85	3.55	10.07	3.44	9.81	3.27
	20	10.67	3.78	10.14	3.63	9.93	3.57	9.89	3.49	9.84	3.36
	21	10.23	3.79	9.61	3.65	9.36	3.59	9.51	3.52	9.77	3.40
	22	10.00	3.81	9.85	3.66	9.79	3.61	9.74	3.54	9.64	3.44
	24	9.30	3.85	9.66	3.71	9.81	3.65	9.60	3.60	9.26	3.52
2.5 + 3.5 + 3.5 + 7.1	16	11.95	3.69	11.05	3.57	10.69	3.52	10.27	3.40	9.58	3.20
	18	11.32	3.75	10.54	3.60	9.85	3.54	10.07	3.43	9.81	3.26
	20	10.67	3.77	10.14	3.62	9.93	3.56	9.89	3.48	9.84	3.35
	21	10.23	3.78	9.61	3.64	9.36	3.58	9.51	3.51	9.77	3.39
	22	10.00	3.80	9.85	3.65	9.79	3.60	9.74	3.53	9.64	3.43
	24	9.30	3.84	9.66	3.70	9.81	3.64	9.60	3.59	9.26	3.51
2.5 + 3.5 + 4.2 + 4.2	16	11.95	3.77	11.05	3.65	10.69	3.60	10.27	3.47	9.58	3.27
	18	11.32	3.83	10.54	3.68	9.85	3.62	10.07	3.51	9.81	3.33
	20	10.67	3.85	10.14	3.70	9.93	3.64	9.89	3.56	9.84	3.42
	21	10.23	3.87	9.61	3.72	9.36	3.66	9.51	3.58	9.77	3.46
	22	10.00	3.88	9.85	3.73	9.79	3.67	9.74	3.61	9.64	3.50
	24	9.30	3.93	9.66	3.78	9.81	3.72	9.60	3.67	9.26	3.59
2.5 + 3.5 + 4.2 + 5.0	16	11.95	3.69	11.05	3.57	10.69	3.52	10.27	3.40	9.58	3.20
	18	11.32	3.75	10.54	3.60	9.85	3.54	10.07	3.43	9.81	3.26
	20	10.67	3.77	10.14	3.62	9.93	3.56	9.89	3.48	9.84	3.35
	21	10.23	3.78	9.61	3.64	9.36	3.58	9.51	3.51	9.77	3.39
	22	10.00	3.80	9.85	3.65	9.79	3.60	9.74	3.53	9.64	3.43
	24	9.30	3.84	9.66	3.70	9.81	3.64	9.60	3.59	9.26	3.51

Combination (Capacity)	Indoor Air Temp. °C DB	Outdoor Air Temp. °C											
		16/15		15/14		10/9		7/6		6/5		2/1	
		Total Q	Input Power	Total Q	Input Power	Total Q	Input Power	Total Q	Input Power	Total Q	Input Power	Total Q	Input Power
2.5 + 3.5 + 4.2 + 6.0	16	20.00	2.83	19.59	2.90	17.53	3.26	16.30	3.48	15.50	3.53	12.31	3.74
	18	19.17	2.95	18.74	3.02	16.62	3.36	15.34	3.57	14.60	3.62	11.63	3.81
	20	18.88	3.03	18.39	3.10	15.89	3.44	14.40	3.64	13.70	3.68	10.88	3.83
	21	18.91	3.06	18.35	3.11	15.55	3.37	13.87	3.52	13.19	3.58	10.48	3.84
	22	19.07	3.08	18.55	3.15	15.92	3.50	14.35	3.71	13.49	3.74	10.06	3.86
	24	19.76	3.11	18.96	3.19	14.96	3.55	12.55	3.76	11.87	3.79	9.15	3.90
2.5 + 3.5 + 4.2 + 7.1	16	20.00	2.82	19.59	2.90	17.53	3.25	16.30	3.47	15.50	3.52	12.31	3.73
	18	19.17	2.94	18.74	3.01	16.62	3.35	15.34	3.56	14.60	3.61	11.63	3.80
	20	18.88	3.02	18.39	3.09	15.89	3.43	14.40	3.63	13.70	3.67	10.88	3.81
	21	18.91	3.05	18.35	3.10	15.55	3.36	13.87	3.51	13.19	3.58	10.48	3.83
	22	19.07	3.08	18.55	3.15	15.92	3.49	14.35	3.70	13.49	3.73	10.06	3.85
	24	19.76	3.10	18.96	3.18	14.96	3.54	12.55	3.75	11.87	3.78	9.15	3.89
2.5 + 3.5 + 5.0 + 5.0	16	20.00	2.79	19.59	2.86	17.53	3.21	16.30	3.42	15.50	3.47	12.31	3.67
	18	19.17	2.90	18.74	2.97	16.62	3.31	15.34	3.51	14.60	3.56	11.63	3.75
	20	18.88	2.98	18.39	3.05	15.89	3.38	14.40	3.58	13.70	3.62	10.88	3.76
	21	18.91	3.01	18.35	3.06	15.55	3.31	13.87	3.46	13.19	3.53	10.48	3.78
	22	19.07	3.03	18.55	3.10	15.92	3.44	14.35	3.65	13.49	3.68	10.06	3.80
	24	19.76	3.06	18.96	3.13	14.96	3.49	12.55	3.70	11.87	3.73	9.15	3.83
2.5 + 3.5 + 5.0 + 6.0	16	20.00	2.79	19.59	2.86	17.53	3.21	16.30	3.42	15.50	3.47	12.31	3.67
	18	19.17	2.90	18.74	2.97	16.62	3.31	15.34	3.51	14.60	3.56	11.63	3.75
	20	18.88	2.98	18.39	3.05	15.89	3.38	14.40	3.58	13.70	3.62	10.88	3.76
	21	18.91	3.01	18.35	3.06	15.55	3.31	13.87	3.46	13.19	3.53	10.48	3.78
	22	19.07	3.03	18.55	3.10	15.92	3.44	14.35	3.65	13.49	3.68	10.06	3.80
	24	19.76	3.06	18.96	3.13	14.96	3.49	12.55	3.70	11.87	3.73	9.15	3.83
2.5 + 3.5 + 5.0 + 7.1	16	20.00	2.77	19.59	2.84	17.53	3.19	16.30	3.40	15.50	3.45	12.31	3.65
	18	19.17	2.89	18.74	2.95	16.62	3.29	15.34	3.49	14.60	3.54	11.63	3.72
	20	18.88	2.96	18.39	3.03	15.89	3.36	14.40	3.56	13.70	3.60	10.88	3.74
	21	18.91	3.00	18.35	3.04	15.55	3.29	13.87	3.44	13.19	3.51	10.48	3.76
	22	19.07	3.02	18.55	3.08	15.92	3.42	14.35	3.63	13.49	3.66	10.06	3.77
	24	19.76	3.04	18.96	3.12	14.96	3.47	12.55	3.68	11.87	3.71	9.15	3.81
2.5 + 3.5 + 6.0 + 6.0	16	20.00	2.79	19.59	2.86	17.53	3.21	16.30	3.42	15.50	3.47	12.31	3.67
	18	19.17	2.90	18.74	2.97	16.62	3.31	15.34	3.51	14.60	3.56	11.63	3.75
	20	18.88	2.98	18.39	3.05	15.89	3.38	14.40	3.58	13.70	3.62	10.88	3.76
	21	18.91	3.01	18.35	3.06	15.55	3.31	13.87	3.46	13.19	3.53	10.48	3.78
	22	19.07	3.03	18.55	3.10	15.92	3.44	14.35	3.65	13.49	3.68	10.06	3.80
	24	19.76	3.06	18.96	3.13	14.96	3.49	12.55	3.70	11.87	3.73	9.15	3.83

Combination (Capacity)	Indoor Air Temp. °C DB	Outdoor Air Temp. °C									
		0/-1		-5/-6		-7/-8		-10/-11		-15/-	
		Total Q	Input Power	Total Q	Input Power	Total Q	Input Power	Total Q	Input Power	Total Q	Input Power
2.5 + 3.5 + 4.2 + 6.0	16	11.95	3.69	11.05	3.57	10.69	3.52	10.27	3.40	9.58	3.20
	18	11.32	3.75	10.54	3.60	9.85	3.54	10.07	3.43	9.81	3.26
	20	10.67	3.77	10.14	3.62	9.93	3.56	9.89	3.48	9.84	3.35
	21	10.23	3.78	9.61	3.64	9.36	3.58	9.51	3.51	9.77	3.39
	22	10.00	3.80	9.85	3.65	9.79	3.60	9.74	3.53	9.64	3.43
	24	9.30	3.84	9.66	3.70	9.81	3.64	9.60	3.59	9.26	3.51
2.5 + 3.5 + 4.2 + 7.1	16	11.95	3.68	11.05	3.56	10.69	3.51	10.27	3.39	9.58	3.19
	18	11.32	3.74	10.54	3.59	9.85	3.53	10.07	3.42	9.81	3.25
	20	10.67	3.76	10.14	3.61	9.93	3.55	9.89	3.47	9.84	3.34
	21	10.23	3.77	9.61	3.63	9.36	3.57	9.51	3.50	9.77	3.38
	22	10.00	3.79	9.85	3.64	9.79	3.59	9.74	3.52	9.64	3.42
	24	9.30	3.83	9.66	3.69	9.81	3.63	9.60	3.58	9.26	3.50
2.5 + 3.5 + 5.0 + 5.0	16	11.95	3.63	11.05	3.51	10.69	3.46	10.27	3.34	9.58	3.14
	18	11.32	3.69	10.54	3.54	9.85	3.48	10.07	3.38	9.81	3.20
	20	10.67	3.70	10.14	3.56	9.93	3.50	9.89	3.42	9.84	3.29
	21	10.23	3.72	9.61	3.58	9.36	3.52	9.51	3.45	9.77	3.33
	22	10.00	3.74	9.85	3.59	9.79	3.54	9.74	3.47	9.64	3.37
	24	9.30	3.78	9.66	3.64	9.81	3.58	9.60	3.53	9.26	3.45
2.5 + 3.5 + 5.0 + 6.0	16	11.95	3.63	11.05	3.51	10.69	3.46	10.27	3.34	9.58	3.14
	18	11.32	3.69	10.54	3.54	9.85	3.48	10.07	3.38	9.81	3.20
	20	10.67	3.70	10.14	3.56	9.93	3.50	9.89	3.42	9.84	3.29
	21	10.23	3.72	9.61	3.58	9.36	3.52	9.51	3.45	9.77	3.33
	22	10.00	3.74	9.85	3.59	9.79	3.54	9.74	3.47	9.64	3.37
	24	9.30	3.78	9.66	3.64	9.81	3.58	9.60	3.53	9.26	3.45
2.5 + 3.5 + 5.0 + 7.1	16	11.95	3.61	11.05	3.49	10.69	3.44	10.27	3.33	9.58	3.13
	18	11.32	3.67	10.54	3.52	9.85	3.46	10.07	3.36	9.81	3.19
	20	10.67	3.68	10.14	3.54	9.93	3.48	9.89	3.41	9.84	3.27
	21	10.23	3.70	9.61	3.56	9.36	3.50	9.51	3.43	9.77	3.31
	22	10.00	3.72	9.85	3.57	9.79	3.52	9.74	3.45	9.64	3.35
	24	9.30	3.76	9.66	3.62	9.81	3.56	9.60	3.51	9.26	3.43
2.5 + 3.5 + 6.0 + 6.0	16	11.95	3.63	11.05	3.51	10.69	3.46	10.27	3.34	9.58	3.14
	18	11.32	3.69	10.54	3.54	9.85	3.48	10.07	3.38	9.81	3.20
	20	10.67	3.70	10.14	3.56	9.93	3.50	9.89	3.42	9.84	3.29
	21	10.23	3.72	9.61	3.58	9.36	3.52	9.51	3.45	9.77	3.33
	22	10.00	3.74	9.85	3.59	9.79	3.54	9.74	3.47	9.64	3.37
	24	9.30	3.78	9.66	3.64	9.81	3.58	9.60	3.53	9.26	3.45

Combination (Capacity)	Indoor Air Temp. °C DB	Outdoor Air Temp. °C											
		16/15		15/14		10/9		7/6		6/5		2/1	
		Total Q	Input Power	Total Q	Input Power	Total Q	Input Power	Total Q	Input Power	Total Q	Input Power	Total Q	Input Power
2.5 + 4.2 + 4.2 + 4.2	16	20.00	2.89	19.59	2.96	17.53	3.33	16.30	3.54	15.50	3.60	12.31	3.81
	18	19.17	3.01	18.74	3.08	16.62	3.43	15.34	3.64	14.60	3.68	11.63	3.88
	20	18.88	3.09	18.39	3.16	15.89	3.50	14.40	3.71	13.70	3.75	10.88	3.90
	21	18.91	3.12	18.35	3.17	15.55	3.43	13.87	3.59	13.19	3.65	10.48	3.92
	22	19.07	3.14	18.55	3.21	15.92	3.57	14.35	3.78	13.49	3.81	10.06	3.93
	24	19.76	3.17	18.96	3.25	14.96	3.61	12.55	3.84	11.87	3.86	9.15	3.97
2.5 + 4.2 + 4.2 + 5.0	16	20.00	2.82	19.59	2.90	17.53	3.25	16.30	3.47	15.50	3.52	12.31	3.73
	18	19.17	2.94	18.74	3.01	16.62	3.35	15.34	3.56	14.60	3.61	11.63	3.80
	20	18.88	3.02	18.39	3.09	15.89	3.43	14.40	3.63	13.70	3.67	10.88	3.81
	21	18.91	3.05	18.35	3.10	15.55	3.36	13.87	3.51	13.19	3.58	10.48	3.83
	22	19.07	3.08	18.55	3.15	15.92	3.49	14.35	3.70	13.49	3.73	10.06	3.85
	24	19.76	3.10	18.96	3.18	14.96	3.54	12.55	3.75	11.87	3.78	9.15	3.89
2.5 + 4.2 + 4.2 + 6.0	16	20.00	2.82	19.59	2.90	17.53	3.25	16.30	3.47	15.50	3.52	12.31	3.73
	18	19.17	2.94	18.74	3.01	16.62	3.35	15.34	3.56	14.60	3.61	11.63	3.80
	20	18.88	3.02	18.39	3.09	15.89	3.43	14.40	3.63	13.70	3.67	10.88	3.81
	21	18.91	3.05	18.35	3.10	15.55	3.36	13.87	3.51	13.19	3.58	10.48	3.83
	22	19.07	3.08	18.55	3.15	15.92	3.49	14.35	3.70	13.49	3.73	10.06	3.85
	24	19.76	3.10	18.96	3.18	14.96	3.54	12.55	3.75	11.87	3.78	9.15	3.89
2.5 + 4.2 + 4.2 + 7.1	16	20.00	2.81	19.59	2.88	17.53	3.24	16.30	3.45	15.50	3.50	12.31	3.70
	18	19.17	2.93	18.74	2.99	16.62	3.33	15.34	3.54	14.60	3.59	11.63	3.78
	20	18.88	3.00	18.39	3.07	15.89	3.41	14.40	3.61	13.70	3.65	10.88	3.79
	21	18.91	3.04	18.35	3.09	15.55	3.34	13.87	3.49	13.19	3.56	10.48	3.81
	22	19.07	3.06	18.55	3.13	15.92	3.47	14.35	3.68	13.49	3.71	10.06	3.83
	24	19.76	3.09	18.96	3.16	14.96	3.52	12.55	3.73	11.87	3.76	9.15	3.87
2.5 + 4.2 + 5.0 + 5.0	16	20.00	2.78	19.59	2.85	17.53	3.20	16.30	3.41	15.50	3.46	12.31	3.66
	18	19.17	2.89	18.74	2.96	16.62	3.30	15.34	3.50	14.60	3.55	11.63	3.74
	20	18.88	2.97	18.39	3.04	15.89	3.37	14.40	3.57	13.70	3.61	10.88	3.75
	21	18.91	3.00	18.35	3.05	15.55	3.30	13.87	3.45	13.19	3.52	10.48	3.77
	22	19.07	3.03	18.55	3.09	15.92	3.43	14.35	3.64	13.49	3.67	10.06	3.78
	24	19.76	3.05	18.96	3.12	14.96	3.48	12.55	3.69	11.87	3.72	9.15	3.82
2.5 + 4.2 + 5.0 + 6.0	16	20.00	2.78	19.59	2.85	17.53	3.20	16.30	3.41	15.50	3.46	12.31	3.66
	18	19.17	2.89	18.74	2.96	16.62	3.30	15.34	3.50	14.60	3.55	11.63	3.74
	20	18.88	2.97	18.39	3.04	15.89	3.37	14.40	3.57	13.70	3.61	10.88	3.75
	21	18.91	3.00	18.35	3.05	15.55	3.30	13.87	3.45	13.19	3.52	10.48	3.77
	22	19.07	3.03	18.55	3.09	15.92	3.43	14.35	3.64	13.49	3.67	10.06	3.78
	24	19.76	3.05	18.96	3.12	14.96	3.48	12.55	3.69	11.87	3.72	9.15	3.82

Combination (Capacity)	Indoor Air Temp. °C DB	Outdoor Air Temp. °C									
		0/-1		-5/-6		-7/-8		-10/-11		-15/-	
		Total Q	Input Power	Total Q	Input Power	Total Q	Input Power	Total Q	Input Power	Total Q	Input Power
2.5 + 4.2 + 4.2 + 4.2	16	11.95	3.76	11.05	3.64	10.69	3.59	10.27	3.47	9.58	3.26
	18	11.32	3.82	10.54	3.67	9.85	3.61	10.07	3.50	9.81	3.32
	20	10.67	3.84	10.14	3.69	9.93	3.63	9.89	3.55	9.84	3.41
	21	10.23	3.86	9.61	3.71	9.36	3.65	9.51	3.57	9.77	3.45
	22	10.00	3.87	9.85	3.72	9.79	3.66	9.74	3.60	9.64	3.49
	24	9.30	3.91	9.66	3.77	9.81	3.71	9.60	3.66	9.26	3.58
2.5 + 4.2 + 4.2 + 5.0	16	11.95	3.68	11.05	3.56	10.69	3.51	10.27	3.39	9.58	3.19
	18	11.32	3.74	10.54	3.59	9.85	3.53	10.07	3.42	9.81	3.25
	20	10.67	3.76	10.14	3.61	9.93	3.55	9.89	3.47	9.84	3.34
	21	10.23	3.77	9.61	3.63	9.36	3.57	9.51	3.50	9.77	3.38
	22	10.00	3.79	9.85	3.64	9.79	3.59	9.74	3.52	9.64	3.42
	24	9.30	3.83	9.66	3.69	9.81	3.63	9.60	3.58	9.26	3.50
2.5 + 4.2 + 4.2 + 6.0	16	11.95	3.68	11.05	3.56	10.69	3.51	10.27	3.39	9.58	3.19
	18	11.32	3.74	10.54	3.59	9.85	3.53	10.07	3.42	9.81	3.25
	20	10.67	3.76	10.14	3.61	9.93	3.55	9.89	3.47	9.84	3.34
	21	10.23	3.77	9.61	3.63	9.36	3.57	9.51	3.50	9.77	3.38
	22	10.00	3.79	9.85	3.64	9.79	3.59	9.74	3.52	9.64	3.42
	24	9.30	3.83	9.66	3.69	9.81	3.63	9.60	3.58	9.26	3.50
2.5 + 4.2 + 4.2 + 7.1	16	11.95	3.66	11.05	3.54	10.69	3.49	10.27	3.37	9.58	3.17
	18	11.32	3.72	10.54	3.57	9.85	3.51	10.07	3.41	9.81	3.23
	20	10.67	3.74	10.14	3.59	9.93	3.53	9.89	3.45	9.84	3.32
	21	10.23	3.75	9.61	3.61	9.36	3.55	9.51	3.48	9.77	3.36
	22	10.00	3.77	9.85	3.62	9.79	3.57	9.74	3.50	9.64	3.40
	24	9.30	3.81	9.66	3.67	9.81	3.61	9.60	3.56	9.26	3.48
2.5 + 4.2 + 5.0 + 5.0	16	11.95	3.62	11.05	3.50	10.69	3.45	10.27	3.33	9.58	3.14
	18	11.32	3.68	10.54	3.53	9.85	3.47	10.07	3.37	9.81	3.20
	20	10.67	3.69	10.14	3.55	9.93	3.49	9.89	3.41	9.84	3.28
	21	10.23	3.71	9.61	3.57	9.36	3.51	9.51	3.44	9.77	3.32
	22	10.00	3.73	9.85	3.58	9.79	3.53	9.74	3.46	9.64	3.36
	24	9.30	3.77	9.66	3.63	9.81	3.57	9.60	3.52	9.26	3.44
2.5 + 4.2 + 5.0 + 6.0	16	11.95	3.62	11.05	3.50	10.69	3.45	10.27	3.33	9.58	3.14
	18	11.32	3.68	10.54	3.53	9.85	3.47	10.07	3.37	9.81	3.20
	20	10.67	3.69	10.14	3.55	9.93	3.49	9.89	3.41	9.84	3.28
	21	10.23	3.71	9.61	3.57	9.36	3.51	9.51	3.44	9.77	3.32
	22	10.00	3.73	9.85	3.58	9.79	3.53	9.74	3.46	9.64	3.36
	24	9.30	3.77	9.66	3.63	9.81	3.57	9.60	3.52	9.26	3.44

Combination (Capacity)	Indoor Air Temp. °C DB	Outdoor Air Temp. °C											
		16/15		15/14		10/9		7/6		6/5		2/1	
		Total Q	Input Power	Total Q	Input Power	Total Q	Input Power	Total Q	Input Power	Total Q	Input Power	Total Q	Input Power
2.5 + 5.0 + 5.0 + 5.0	16	20.00	2.78	19.59	2.85	17.53	3.20	16.30	3.41	15.50	3.46	12.31	3.66
	18	19.17	2.89	18.74	2.96	16.62	3.30	15.34	3.50	14.60	3.55	11.63	3.74
	20	18.88	2.97	18.39	3.04	15.89	3.37	14.40	3.57	13.70	3.61	10.88	3.75
	21	18.91	3.00	18.35	3.05	15.55	3.30	13.87	3.45	13.19	3.52	10.48	3.77
	22	19.07	3.03	18.55	3.09	15.92	3.43	14.35	3.64	13.49	3.67	10.06	3.78
	24	19.76	3.05	18.96	3.12	14.96	3.48	12.55	3.69	11.87	3.72	9.15	3.82
3.5 + 3.5 + 3.5 + 3.5	16	20.00	2.89	19.59	2.96	17.53	3.33	16.30	3.54	15.50	3.60	12.31	3.81
	18	19.17	3.01	18.74	3.08	16.62	3.43	15.34	3.64	14.60	3.68	11.63	3.88
	20	18.88	3.09	18.39	3.16	15.89	3.50	14.40	3.71	13.70	3.75	10.88	3.90
	21	18.91	3.12	18.35	3.17	15.55	3.43	13.87	3.59	13.19	3.65	10.48	3.92
	22	19.07	3.14	18.55	3.21	15.92	3.57	14.35	3.78	13.49	3.81	10.06	3.93
	24	19.76	3.17	18.96	3.25	14.96	3.61	12.55	3.84	11.87	3.86	9.15	3.97
3.5 + 3.5 + 3.5 + 4.2	16	20.00	2.88	19.59	2.95	17.53	3.32	16.30	3.53	15.50	3.59	12.31	3.80
	18	19.17	3.00	18.74	3.07	16.62	3.42	15.34	3.63	14.60	3.67	11.63	3.87
	20	18.88	3.08	18.39	3.15	15.89	3.49	14.40	3.70	13.70	3.74	10.88	3.89
	21	18.91	3.11	18.35	3.16	15.55	3.42	13.87	3.58	13.19	3.64	10.48	3.91
	22	19.07	3.14	18.55	3.21	15.92	3.56	14.35	3.77	13.49	3.80	10.06	3.92
	24	19.76	3.16	18.96	3.24	14.96	3.60	12.55	3.83	11.87	3.85	9.15	3.96
3.5 + 3.5 + 3.5 + 5.0	16	20.00	2.82	19.59	2.89	17.53	3.24	16.30	3.46	15.50	3.51	12.31	3.71
	18	19.17	2.93	18.74	3.00	16.62	3.34	15.34	3.55	14.60	3.60	11.63	3.79
	20	18.88	3.01	18.39	3.08	15.89	3.42	14.40	3.62	13.70	3.66	10.88	3.80
	21	18.91	3.05	18.35	3.10	15.55	3.35	13.87	3.50	13.19	3.57	10.48	3.82
	22	19.07	3.07	18.55	3.14	15.92	3.48	14.35	3.69	13.49	3.72	10.06	3.84
	24	19.76	3.10	18.96	3.17	14.96	3.53	12.55	3.74	11.87	3.77	9.15	3.88
3.5 + 3.5 + 3.5 + 6.0	16	20.00	2.82	19.59	2.89	17.53	3.24	16.30	3.46	15.50	3.51	12.31	3.71
	18	19.17	2.93	18.74	3.00	16.62	3.34	15.34	3.55	14.60	3.60	11.63	3.79
	20	18.88	3.01	18.39	3.08	15.89	3.42	14.40	3.62	13.70	3.66	10.88	3.80
	21	18.91	3.05	18.35	3.10	15.55	3.35	13.87	3.50	13.19	3.57	10.48	3.82
	22	19.07	3.07	18.55	3.14	15.92	3.48	14.35	3.69	13.49	3.72	10.06	3.84
	24	19.76	3.10	18.96	3.17	14.96	3.53	12.55	3.74	11.87	3.77	9.15	3.88
3.5 + 3.5 + 3.5 + 7.1	16	20.00	2.81	19.59	2.88	17.53	3.24	16.30	3.45	15.50	3.50	12.31	3.70
	18	19.17	2.93	18.74	2.99	16.62	3.33	15.34	3.54	14.60	3.59	11.63	3.78
	20	18.88	3.00	18.39	3.07	15.89	3.41	14.40	3.61	13.70	3.65	10.88	3.79
	21	18.91	3.04	18.35	3.09	15.55	3.34	13.87	3.49	13.19	3.56	10.48	3.81
	22	19.07	3.06	18.55	3.13	15.92	3.47	14.35	3.68	13.49	3.71	10.06	3.83
	24	19.76	3.09	18.96	3.16	14.96	3.52	12.55	3.73	11.87	3.76	9.15	3.87



Combination (Capacity)	Indoor Air Temp. °C DB	Outdoor Air Temp. °C									
		0/-1		-5/-6		-7/-8		-10/-11		-15/-	
		Total Q	Input Power	Total Q	Input Power	Total Q	Input Power	Total Q	Input Power	Total Q	Input Power
2.5 + 5.0 + 5.0 + 5.0	16	11.95	3.62	11.05	3.50	10.69	3.45	10.27	3.33	9.58	3.14
	18	11.32	3.68	10.54	3.53	9.85	3.47	10.07	3.37	9.81	3.20
	20	10.67	3.69	10.14	3.55	9.93	3.49	9.89	3.41	9.84	3.28
	21	10.23	3.71	9.61	3.57	9.36	3.51	9.51	3.44	9.77	3.32
	22	10.00	3.73	9.85	3.58	9.79	3.53	9.74	3.46	9.64	3.36
	24	9.30	3.77	9.66	3.63	9.81	3.57	9.60	3.52	9.26	3.44
3.5 + 3.5 + 3.5 + 3.5	16	11.95	3.76	11.05	3.64	10.69	3.59	10.27	3.47	9.58	3.26
	18	11.32	3.82	10.54	3.67	9.85	3.61	10.07	3.50	9.81	3.32
	20	10.67	3.84	10.14	3.69	9.93	3.63	9.89	3.55	9.84	3.41
	21	10.23	3.86	9.61	3.71	9.36	3.65	9.51	3.57	9.77	3.45
	22	10.00	3.87	9.85	3.72	9.79	3.66	9.74	3.60	9.64	3.49
	24	9.30	3.91	9.66	3.77	9.81	3.71	9.60	3.66	9.26	3.58
3.5 + 3.5 + 3.5 + 4.2	16	11.95	3.75	11.05	3.63	10.69	3.58	10.27	3.46	9.58	3.25
	18	11.32	3.81	10.54	3.66	9.85	3.60	10.07	3.49	9.81	3.31
	20	10.67	3.83	10.14	3.68	9.93	3.62	9.89	3.54	9.84	3.40
	21	10.23	3.85	9.61	3.70	9.36	3.64	9.51	3.56	9.77	3.44
	22	10.00	3.86	9.85	3.71	9.79	3.65	9.74	3.59	9.64	3.48
	24	9.30	3.90	9.66	3.76	9.81	3.70	9.60	3.65	9.26	3.57
3.5 + 3.5 + 3.5 + 5.0	16	11.95	3.67	11.05	3.55	10.69	3.50	10.27	3.38	9.58	3.18
	18	11.32	3.73	10.54	3.58	9.85	3.52	10.07	3.42	9.81	3.24
	20	10.67	3.75	10.14	3.60	9.93	3.54	9.89	3.46	9.84	3.33
	21	10.23	3.76	9.61	3.62	9.36	3.56	9.51	3.49	9.77	3.37
	22	10.00	3.78	9.85	3.63	9.79	3.58	9.74	3.51	9.64	3.41
	24	9.30	3.82	9.66	3.68	9.81	3.62	9.60	3.57	9.26	3.49
3.5 + 3.5 + 3.5 + 6.0	16	11.95	3.67	11.05	3.55	10.69	3.50	10.27	3.38	9.58	3.18
	18	11.32	3.73	10.54	3.58	9.85	3.52	10.07	3.42	9.81	3.24
	20	10.67	3.75	10.14	3.60	9.93	3.54	9.89	3.46	9.84	3.33
	21	10.23	3.76	9.61	3.62	9.36	3.56	9.51	3.49	9.77	3.37
	22	10.00	3.78	9.85	3.63	9.79	3.58	9.74	3.51	9.64	3.41
	24	9.30	3.82	9.66	3.68	9.81	3.62	9.60	3.57	9.26	3.49
3.5 + 3.5 + 3.5 + 7.1	16	11.95	3.66	11.05	3.54	10.69	3.49	10.27	3.37	9.58	3.17
	18	11.32	3.72	10.54	3.57	9.85	3.51	10.07	3.41	9.81	3.23
	20	10.67	3.74	10.14	3.59	9.93	3.53	9.89	3.45	9.84	3.32
	21	10.23	3.75	9.61	3.61	9.36	3.55	9.51	3.48	9.77	3.36
	22	10.00	3.77	9.85	3.62	9.79	3.57	9.74	3.50	9.64	3.40
	24	9.30	3.81	9.66	3.67	9.81	3.61	9.60	3.56	9.26	3.48

Combination (Capacity)	Indoor Air Temp. °C DB	Outdoor Air Temp. °C											
		16/15		15/14		10/9		7/6		6/5		2/1	
		Total Q	Input Power	Total Q	Input Power	Total Q	Input Power	Total Q	Input Power	Total Q	Input Power	Total Q	Input Power
3.5 + 3.5 + 4.2 + 4.2	16	20.00	2.87	19.59	2.94	17.53	3.31	16.30	3.53	15.50	3.58	12.31	3.79
	18	19.17	2.99	18.74	3.06	16.62	3.41	15.34	3.62	14.60	3.66	11.63	3.86
	20	18.88	3.07	18.39	3.14	15.89	3.48	14.40	3.69	13.70	3.73	10.88	3.88
	21	18.91	3.10	18.35	3.16	15.55	3.41	13.87	3.57	13.19	3.63	10.48	3.89
	22	19.07	3.13	18.55	3.20	15.92	3.55	14.35	3.76	13.49	3.79	10.06	3.91
	24	19.76	3.16	18.96	3.23	14.96	3.60	12.55	3.82	11.87	3.84	9.15	3.95
3.5 + 3.5 + 4.2 + 5.0	16	20.00	2.81	19.59	2.88	17.53	3.24	16.30	3.45	15.50	3.50	12.31	3.70
	18	19.17	2.93	18.74	2.99	16.62	3.33	15.34	3.54	14.60	3.59	11.63	3.78
	20	18.88	3.00	18.39	3.07	15.89	3.41	14.40	3.61	13.70	3.65	10.88	3.79
	21	18.91	3.04	18.35	3.09	15.55	3.34	13.87	3.49	13.19	3.56	10.48	3.81
	22	19.07	3.06	18.55	3.13	15.92	3.47	14.35	3.68	13.49	3.71	10.06	3.83
	24	19.76	3.09	18.96	3.16	14.96	3.52	12.55	3.73	11.87	3.76	9.15	3.87
3.5 + 3.5 + 4.2 + 6.0	16	20.00	2.81	19.59	2.88	17.53	3.24	16.30	3.45	15.50	3.50	12.31	3.70
	18	19.17	2.93	18.74	2.99	16.62	3.33	15.34	3.54	14.60	3.59	11.63	3.78
	20	18.88	3.00	18.39	3.07	15.89	3.41	14.40	3.61	13.70	3.65	10.88	3.79
	21	18.91	3.04	18.35	3.09	15.55	3.34	13.87	3.49	13.19	3.56	10.48	3.81
	22	19.07	3.06	18.55	3.13	15.92	3.47	14.35	3.68	13.49	3.71	10.06	3.83
	24	19.76	3.09	18.96	3.16	14.96	3.52	12.55	3.73	11.87	3.76	9.15	3.87
3.5 + 3.5 + 4.2 + 7.1	16	20.00	2.80	19.59	2.87	17.53	3.23	16.30	3.44	15.50	3.49	12.31	3.69
	18	19.17	2.92	18.74	2.99	16.62	3.32	15.34	3.53	14.60	3.58	11.63	3.77
	20	18.88	3.00	18.39	3.06	15.89	3.40	14.40	3.60	13.70	3.64	10.88	3.78
	21	18.91	3.03	18.35	3.08	15.55	3.33	13.87	3.48	13.19	3.55	10.48	3.80
	22	19.07	3.05	18.55	3.12	15.92	3.46	14.35	3.67	13.49	3.70	10.06	3.82
	24	19.76	3.08	18.96	3.15	14.96	3.51	12.55	3.72	11.87	3.75	9.15	3.86
3.5 + 3.5 + 5.0 + 5.0	16	20.00	2.76	19.59	2.83	17.53	3.18	16.30	3.39	15.50	3.44	12.31	3.64
	18	19.17	2.88	18.74	2.94	16.62	3.28	15.34	3.48	14.60	3.53	11.63	3.71
	20	18.88	2.95	18.39	3.02	15.89	3.35	14.40	3.55	13.70	3.59	10.88	3.73
	21	18.91	2.99	18.35	3.04	15.55	3.28	13.87	3.43	13.19	3.50	10.48	3.75
	22	19.07	3.01	18.55	3.08	15.92	3.41	14.35	3.62	13.49	3.65	10.06	3.76
	24	19.76	3.04	18.96	3.11	14.96	3.46	12.55	3.67	11.87	3.70	9.15	3.80
3.5 + 3.5 + 5.0 + 6.0	16	20.00	2.76	19.59	2.83	17.53	3.18	16.30	3.39	15.50	3.44	12.31	3.64
	18	19.17	2.88	18.74	2.94	16.62	3.28	15.34	3.48	14.60	3.53	11.63	3.71
	20	18.88	2.95	18.39	3.02	15.89	3.35	14.40	3.55	13.70	3.59	10.88	3.73
	21	18.91	2.99	18.35	3.04	15.55	3.28	13.87	3.43	13.19	3.50	10.48	3.75
	22	19.07	3.01	18.55	3.08	15.92	3.41	14.35	3.62	13.49	3.65	10.06	3.76
	24	19.76	3.04	18.96	3.11	14.96	3.46	12.55	3.67	11.87	3.70	9.15	3.80

Combination (Capacity)	Indoor Air Temp. °C DB	Outdoor Air Temp. °C									
		0/-1		-5/-6		-7/-8		-10/-11		-15/-	
		Total Q	Input Power	Total Q	Input Power	Total Q	Input Power	Total Q	Input Power	Total Q	Input Power
3.5 + 3.5 + 4.2 + 4.2	16	11.95	3.74	11.05	3.62	10.69	3.57	10.27	3.45	9.58	3.24
	18	11.32	3.80	10.54	3.65	9.85	3.59	10.07	3.48	9.81	3.30
	20	10.67	3.82	10.14	3.67	9.93	3.61	9.89	3.53	9.84	3.39
	21	10.23	3.84	9.61	3.69	9.36	3.63	9.51	3.55	9.77	3.43
	22	10.00	3.85	9.85	3.70	9.79	3.64	9.74	3.58	9.64	3.47
	24	9.30	3.89	9.66	3.75	9.81	3.69	9.60	3.64	9.26	3.56
3.5 + 3.5 + 4.2 + 5.0	16	11.95	3.66	11.05	3.54	10.69	3.49	10.27	3.37	9.58	3.17
	18	11.32	3.72	10.54	3.57	9.85	3.51	10.07	3.41	9.81	3.23
	20	10.67	3.74	10.14	3.59	9.93	3.53	9.89	3.45	9.84	3.32
	21	10.23	3.75	9.61	3.61	9.36	3.55	9.51	3.48	9.77	3.36
	22	10.00	3.77	9.85	3.62	9.79	3.57	9.74	3.50	9.64	3.40
	24	9.30	3.81	9.66	3.67	9.81	3.61	9.60	3.56	9.26	3.48
3.5 + 3.5 + 4.2 + 6.0	16	11.95	3.66	11.05	3.54	10.69	3.49	10.27	3.37	9.58	3.17
	18	11.32	3.72	10.54	3.57	9.85	3.51	10.07	3.41	9.81	3.23
	20	10.67	3.74	10.14	3.59	9.93	3.53	9.89	3.45	9.84	3.32
	21	10.23	3.75	9.61	3.61	9.36	3.55	9.51	3.48	9.77	3.36
	22	10.00	3.77	9.85	3.62	9.79	3.57	9.74	3.50	9.64	3.40
	24	9.30	3.81	9.66	3.67	9.81	3.61	9.60	3.56	9.26	3.48
3.5 + 3.5 + 4.2 + 7.1	16	11.95	3.65	11.05	3.53	10.69	3.48	10.27	3.36	9.58	3.16
	18	11.32	3.71	10.54	3.56	9.85	3.50	10.07	3.40	9.81	3.22
	20	10.67	3.73	10.14	3.58	9.93	3.52	9.89	3.44	9.84	3.31
	21	10.23	3.74	9.61	3.60	9.36	3.54	9.51	3.47	9.77	3.35
	22	10.00	3.76	9.85	3.61	9.79	3.56	9.74	3.49	9.64	3.39
	24	9.30	3.80	9.66	3.66	9.81	3.60	9.60	3.55	9.26	3.47
3.5 + 3.5 + 5.0 + 5.0	16	11.95	3.60	11.05	3.48	10.69	3.44	10.27	3.32	9.58	3.12
	18	11.32	3.66	10.54	3.51	9.85	3.45	10.07	3.35	9.81	3.18
	20	10.67	3.67	10.14	3.53	9.93	3.47	9.89	3.40	9.84	3.27
	21	10.23	3.69	9.61	3.55	9.36	3.49	9.51	3.42	9.77	3.30
	22	10.00	3.71	9.85	3.56	9.79	3.51	9.74	3.44	9.64	3.34
	24	9.30	3.75	9.66	3.61	9.81	3.55	9.60	3.50	9.26	3.42
3.5 + 3.5 + 5.0 + 6.0	16	11.95	3.60	11.05	3.48	10.69	3.44	10.27	3.32	9.58	3.12
	18	11.32	3.66	10.54	3.51	9.85	3.45	10.07	3.35	9.81	3.18
	20	10.67	3.67	10.14	3.53	9.93	3.47	9.89	3.40	9.84	3.27
	21	10.23	3.69	9.61	3.55	9.36	3.49	9.51	3.42	9.77	3.30
	22	10.00	3.71	9.85	3.56	9.79	3.51	9.74	3.44	9.64	3.34
	24	9.30	3.75	9.66	3.61	9.81	3.55	9.60	3.50	9.26	3.42

Combination (Capacity)	Indoor Air Temp. °C DB	Outdoor Air Temp. °C											
		16/15		15/14		10/9		7/6		6/5		2/1	
		Total Q	Input Power	Total Q	Input Power	Total Q	Input Power	Total Q	Input Power	Total Q	Input Power	Total Q	Input Power
3.5 + 4.2 + 4.2 + 4.2	16	20.00	2.86	19.59	2.93	17.53	3.29	16.30	3.51	15.50	3.56	12.31	3.77
	18	19.17	2.97	18.74	3.04	16.62	3.39	15.34	3.60	14.60	3.65	11.63	3.84
	20	18.88	3.05	18.39	3.12	15.89	3.46	14.40	3.67	13.70	3.71	10.88	3.86
	21	18.91	3.09	18.35	3.14	15.55	3.40	13.87	3.55	13.19	3.61	10.48	3.87
	22	19.07	3.11	18.55	3.18	15.92	3.53	14.35	3.74	13.49	3.77	10.06	3.89
	24	19.76	3.14	18.96	3.21	14.96	3.58	12.55	3.79	11.87	3.82	9.15	3.93
3.5 + 4.2 + 4.2 + 5.0	16	20.00	2.80	19.59	2.87	17.53	3.23	16.30	3.44	15.50	3.49	12.31	3.69
	18	19.17	2.92	18.74	2.99	16.62	3.32	15.34	3.53	14.60	3.58	11.63	3.77
	20	18.88	3.00	18.39	3.06	15.89	3.40	14.40	3.60	13.70	3.64	10.88	3.78
	21	18.91	3.03	18.35	3.08	15.55	3.33	13.87	3.48	13.19	3.55	10.48	3.80
	22	19.07	3.05	18.55	3.12	15.92	3.46	14.35	3.67	13.49	3.70	10.06	3.82
	24	19.76	3.08	18.96	3.15	14.96	3.51	12.55	3.72	11.87	3.75	9.15	3.86
3.5 + 4.2 + 4.2 + 6.0	16	20.00	2.80	19.59	2.87	17.53	3.23	16.30	3.44	15.50	3.49	12.31	3.69
	18	19.17	2.92	18.74	2.99	16.62	3.32	15.34	3.53	14.60	3.58	11.63	3.77
	20	18.88	3.00	18.39	3.06	15.89	3.40	14.40	3.60	13.70	3.64	10.88	3.78
	21	18.91	3.03	18.35	3.08	15.55	3.33	13.87	3.48	13.19	3.55	10.48	3.80
	22	19.07	3.05	18.55	3.12	15.92	3.46	14.35	3.67	13.49	3.70	10.06	3.82
	24	19.76	3.08	18.96	3.15	14.96	3.51	12.55	3.72	11.87	3.75	9.15	3.86
3.5 + 4.2 + 5.0 + 5.0	16	20.00	2.75	19.59	2.82	17.53	3.17	16.30	3.38	15.50	3.43	12.31	3.63
	18	19.17	2.87	18.74	2.94	16.62	3.27	15.34	3.47	14.60	3.52	11.63	3.70
	20	18.88	2.95	18.39	3.01	15.89	3.34	14.40	3.54	13.70	3.58	10.88	3.72
	21	18.91	2.98	18.35	3.03	15.55	3.28	13.87	3.42	13.19	3.49	10.48	3.74
	22	19.07	3.00	18.55	3.07	15.92	3.40	14.35	3.61	13.49	3.63	10.06	3.75
	24	19.76	3.03	18.96	3.10	14.96	3.45	12.55	3.66	11.87	3.69	9.15	3.79
4.2 + 4.2 + 4.2 + 4.2	16	20.00	2.85	19.59	2.92	17.53	3.28	16.30	3.50	15.50	3.55	12.31	3.76
	18	19.17	2.97	18.74	3.04	16.62	3.38	15.34	3.59	14.60	3.64	11.63	3.83
	20	18.88	3.05	18.39	3.11	15.89	3.46	14.40	3.66	13.70	3.70	10.88	3.85
	21	18.91	3.08	18.35	3.13	15.55	3.39	13.87	3.54	13.19	3.60	10.48	3.86
	22	19.07	3.10	18.55	3.17	15.92	3.52	14.35	3.73	13.49	3.76	10.06	3.88
	24	19.76	3.13	18.96	3.20	14.96	3.57	12.55	3.78	11.87	3.81	9.15	3.92
4.2 + 4.2 + 4.2 + 5.0	16	20.00	2.79	19.59	2.86	17.53	3.22	16.30	3.43	15.50	3.48	12.31	3.68
	18	19.17	2.91	18.74	2.98	16.62	3.32	15.34	3.52	14.60	3.57	11.63	3.76
	20	18.88	2.99	18.39	3.05	15.89	3.39	14.40	3.59	13.70	3.63	10.88	3.77
	21	18.91	3.02	18.35	3.07	15.55	3.32	13.87	3.47	13.19	3.54	10.48	3.79
	22	19.07	3.04	18.55	3.11	15.92	3.45	14.35	3.66	13.49	3.69	10.06	3.81
	24	19.76	3.07	18.96	3.14	14.96	3.50	12.55	3.71	11.87	3.74	9.15	3.84

Combination (Capacity)	Indoor Air Temp. °C DB	Outdoor Air Temp. °C									
		0/-1		-5/-6		-7/-8		-10/-11		-15/-	
		Total Q	Input Power	Total Q	Input Power	Total Q	Input Power	Total Q	Input Power	Total Q	Input Power
3.5 + 4.2 + 4.2 + 4.2	16	11.95	3.72	11.05	3.60	10.69	3.55	10.27	3.43	9.58	3.22
	18	11.32	3.78	10.54	3.63	9.85	3.57	10.07	3.46	9.81	3.29
	20	10.67	3.80	10.14	3.65	9.93	3.59	9.89	3.51	9.84	3.38
	21	10.23	3.81	9.61	3.67	9.36	3.61	9.51	3.54	9.77	3.42
	22	10.00	3.83	9.85	3.68	9.79	3.62	9.74	3.56	9.64	3.46
	24	9.30	3.87	9.66	3.73	9.81	3.67	9.60	3.62	9.26	3.54
3.5 + 4.2 + 4.2 + 5.0	16	11.95	3.65	11.05	3.53	10.69	3.48	10.27	3.36	9.58	3.16
	18	11.32	3.71	10.54	3.56	9.85	3.50	10.07	3.40	9.81	3.22
	20	10.67	3.73	10.14	3.58	9.93	3.52	9.89	3.44	9.84	3.31
	21	10.23	3.74	9.61	3.60	9.36	3.54	9.51	3.47	9.77	3.35
	22	10.00	3.76	9.85	3.61	9.79	3.56	9.74	3.49	9.64	3.39
	24	9.30	3.80	9.66	3.66	9.81	3.60	9.60	3.55	9.26	3.47
3.5 + 4.2 + 4.2 + 6.0	16	11.95	3.65	11.05	3.53	10.69	3.48	10.27	3.36	9.58	3.16
	18	11.32	3.71	10.54	3.56	9.85	3.50	10.07	3.40	9.81	3.22
	20	10.67	3.73	10.14	3.58	9.93	3.52	9.89	3.44	9.84	3.31
	21	10.23	3.74	9.61	3.60	9.36	3.54	9.51	3.47	9.77	3.35
	22	10.00	3.76	9.85	3.61	9.79	3.56	9.74	3.49	9.64	3.39
	24	9.30	3.80	9.66	3.66	9.81	3.60	9.60	3.55	9.26	3.47
3.5 + 4.2 + 5.0 + 5.0	16	11.95	3.59	11.05	3.47	10.69	3.43	10.27	3.31	9.58	3.11
	18	11.32	3.65	10.54	3.50	9.85	3.44	10.07	3.34	9.81	3.17
	20	10.67	3.66	10.14	3.52	9.93	3.46	9.89	3.39	9.84	3.26
	21	10.23	3.68	9.61	3.54	9.36	3.48	9.51	3.41	9.77	3.29
	22	10.00	3.70	9.85	3.55	9.79	3.50	9.74	3.44	9.64	3.33
	24	9.30	3.74	9.66	3.60	9.81	3.54	9.60	3.49	9.26	3.41
4.2 + 4.2 + 4.2 + 4.2	16	11.95	3.71	11.05	3.59	10.69	3.54	10.27	3.42	9.58	3.21
	18	11.32	3.77	10.54	3.62	9.85	3.56	10.07	3.45	9.81	3.28
	20	10.67	3.79	10.14	3.64	9.93	3.58	9.89	3.50	9.84	3.37
	21	10.23	3.80	9.61	3.66	9.36	3.60	9.51	3.53	9.77	3.41
	22	10.00	3.82	9.85	3.67	9.79	3.61	9.74	3.55	9.64	3.45
	24	9.30	3.86	9.66	3.72	9.81	3.66	9.60	3.61	9.26	3.53
4.2 + 4.2 + 4.2 + 5.0	16	11.95	3.64	11.05	3.52	10.69	3.47	10.27	3.35	9.58	3.15
	18	11.32	3.70	10.54	3.55	9.85	3.49	10.07	3.39	9.81	3.21
	20	10.67	3.71	10.14	3.57	9.93	3.51	9.89	3.43	9.84	3.30
	21	10.23	3.73	9.61	3.59	9.36	3.53	9.51	3.46	9.77	3.34
	22	10.00	3.75	9.85	3.60	9.79	3.55	9.74	3.48	9.64	3.38
	24	9.30	3.79	9.66	3.65	9.81	3.59	9.60	3.54	9.26	3.46

Combination (Capacity)	Indoor Air Temp. °C DB	Outdoor Air Temp. °C											
		16/15		15/14		10/9		7/6		6/5		2/1	
		Total Q	Input Power	Total Q	Input Power	Total Q	Input Power	Total Q	Input Power	Total Q	Input Power	Total Q	Input Power
1.6 + 1.6 + 1.6 + 1.6 + 1.6	16	20.14	2.86	19.73	2.93	17.66	3.29	16.41	3.51	15.61	3.56	12.40	3.77
	18	19.30	2.97	18.87	3.04	16.73	3.39	15.45	3.60	14.70	3.65	11.71	3.84
	20	19.01	3.05	18.51	3.12	16.00	3.46	14.50	3.67	13.79	3.71	10.96	3.86
	21	19.04	3.09	18.48	3.14	15.66	3.40	13.96	3.55	13.28	3.61	10.56	3.87
	22	19.20	3.11	18.67	3.18	16.03	3.53	14.45	3.74	13.58	3.77	10.13	3.89
	24	19.90	3.14	19.09	3.21	15.06	3.58	12.64	3.79	11.96	3.82	9.22	3.93
1.6 + 1.6 + 1.6 + 1.6 + 2.0	16	20.14	2.85	19.73	2.92	17.66	3.28	16.41	3.50	15.61	3.55	12.40	3.76
	18	19.30	2.97	18.87	3.04	16.73	3.38	15.45	3.59	14.70	3.64	11.71	3.83
	20	19.01	3.05	18.51	3.11	16.00	3.46	14.50	3.66	13.79	3.70	10.96	3.85
	21	19.04	3.08	18.48	3.13	15.66	3.39	13.96	3.54	13.28	3.60	10.56	3.86
	22	19.20	3.10	18.67	3.17	16.03	3.52	14.45	3.73	13.58	3.76	10.13	3.88
	24	19.90	3.13	19.09	3.20	15.06	3.57	12.64	3.78	11.96	3.81	9.22	3.92
1.6 + 1.6 + 1.6 + 1.6 + 2.5	16	20.14	2.85	19.73	2.92	17.66	3.28	16.41	3.50	15.61	3.55	12.40	3.76
	18	19.30	2.97	18.87	3.04	16.73	3.38	15.45	3.59	14.70	3.64	11.71	3.83
	20	19.01	3.05	18.51	3.11	16.00	3.46	14.50	3.66	13.79	3.70	10.96	3.85
	21	19.04	3.08	18.48	3.13	15.66	3.39	13.96	3.54	13.28	3.60	10.56	3.86
	22	19.20	3.10	18.67	3.17	16.03	3.52	14.45	3.73	13.58	3.76	10.13	3.88
	24	19.90	3.13	19.09	3.20	15.06	3.57	12.64	3.78	11.96	3.81	9.22	3.92
1.6 + 1.6 + 1.6 + 1.6 + 3.5	16	20.14	2.82	19.73	2.90	17.66	3.25	16.41	3.47	15.61	3.52	12.40	3.73
	18	19.30	2.94	18.87	3.01	16.73	3.35	15.45	3.56	14.70	3.61	11.71	3.80
	20	19.01	3.02	18.51	3.09	16.00	3.43	14.50	3.63	13.79	3.67	10.96	3.81
	21	19.04	3.05	18.48	3.10	15.66	3.36	13.96	3.51	13.28	3.58	10.56	3.83
	22	19.20	3.08	18.67	3.15	16.03	3.49	14.45	3.70	13.58	3.73	10.13	3.85
	24	19.90	3.10	19.09	3.18	15.06	3.54	12.64	3.75	11.96	3.78	9.22	3.89
1.6 + 1.6 + 1.6 + 1.6 + 4.2	16	20.14	2.86	19.73	2.93	17.66	3.29	16.41	3.51	15.61	3.56	12.40	3.77
	18	19.30	2.97	18.87	3.04	16.73	3.39	15.45	3.60	14.70	3.65	11.71	3.84
	20	19.01	3.05	18.51	3.12	16.00	3.46	14.50	3.67	13.79	3.71	10.96	3.86
	21	19.04	3.09	18.48	3.14	15.66	3.40	13.96	3.55	13.28	3.61	10.56	3.87
	22	19.20	3.11	18.67	3.18	16.03	3.53	14.45	3.74	13.58	3.77	10.13	3.89
	24	19.90	3.14	19.09	3.21	15.06	3.58	12.64	3.79	11.96	3.82	9.22	3.93
1.6 + 1.6 + 1.6 + 1.6 + 5.0	16	20.14	2.81	19.73	2.88	17.66	3.24	16.41	3.45	15.61	3.50	12.40	3.70
	18	19.30	2.93	18.87	2.99	16.73	3.33	15.45	3.54	14.70	3.59	11.71	3.78
	20	19.01	3.00	18.51	3.07	16.00	3.41	14.50	3.61	13.79	3.65	10.96	3.79
	21	19.04	3.04	18.48	3.09	15.66	3.34	13.96	3.49	13.28	3.56	10.56	3.81
	22	19.20	3.06	18.67	3.13	16.03	3.47	14.45	3.68	13.58	3.71	10.13	3.83
	24	19.90	3.09	19.09	3.16	15.06	3.52	12.64	3.73	11.96	3.76	9.22	3.87

Combination (Capacity)	Indoor Air Temp. °C DB	Outdoor Air Temp. °C									
		0/-1		-5/-6		-7/-8		-10/-11		-15/-	
		Total Q	Input Power	Total Q	Input Power	Total Q	Input Power	Total Q	Input Power	Total Q	Input Power
1.6 + 1.6 + 1.6 + 1.6 + 1.6	16	12.04	3.72	11.13	3.60	10.76	3.55	10.34	3.43	9.65	3.22
	18	11.40	3.78	10.61	3.63	9.92	3.57	10.14	3.46	9.88	3.29
	20	10.75	3.80	10.21	3.65	9.99	3.59	9.96	3.51	9.91	3.38
	21	10.31	3.81	9.67	3.67	9.42	3.61	9.58	3.54	9.83	3.42
	22	10.07	3.83	9.92	3.68	9.86	3.62	9.80	3.56	9.71	3.46
	24	9.36	3.87	9.73	3.73	9.88	3.67	9.67	3.62	9.32	3.54
1.6 + 1.6 + 1.6 + 1.6 + 2.0	16	12.04	3.71	11.13	3.59	10.76	3.54	10.34	3.42	9.65	3.21
	18	11.40	3.77	10.61	3.62	9.92	3.56	10.14	3.45	9.88	3.28
	20	10.75	3.79	10.21	3.64	9.99	3.58	9.96	3.50	9.91	3.37
	21	10.31	3.80	9.67	3.66	9.42	3.60	9.58	3.53	9.83	3.41
	22	10.07	3.82	9.92	3.67	9.86	3.61	9.80	3.55	9.71	3.45
	24	9.36	3.86	9.73	3.72	9.88	3.66	9.67	3.61	9.32	3.53
1.6 + 1.6 + 1.6 + 1.6 + 2.5	16	12.04	3.71	11.13	3.59	10.76	3.54	10.34	3.42	9.65	3.21
	18	11.40	3.77	10.61	3.62	9.92	3.56	10.14	3.45	9.88	3.28
	20	10.75	3.79	10.21	3.64	9.99	3.58	9.96	3.50	9.91	3.37
	21	10.31	3.80	9.67	3.66	9.42	3.60	9.58	3.53	9.83	3.41
	22	10.07	3.82	9.92	3.67	9.86	3.61	9.80	3.55	9.71	3.45
	24	9.36	3.86	9.73	3.72	9.88	3.66	9.67	3.61	9.32	3.53
1.6 + 1.6 + 1.6 + 1.6 + 3.5	16	12.04	3.68	11.13	3.56	10.76	3.51	10.34	3.39	9.65	3.19
	18	11.40	3.74	10.61	3.59	9.92	3.53	10.14	3.42	9.88	3.25
	20	10.75	3.76	10.21	3.61	9.99	3.55	9.96	3.47	9.91	3.34
	21	10.31	3.77	9.67	3.63	9.42	3.57	9.58	3.50	9.83	3.38
	22	10.07	3.79	9.92	3.64	9.86	3.59	9.80	3.52	9.71	3.42
	24	9.36	3.83	9.73	3.69	9.88	3.63	9.67	3.58	9.32	3.50
1.6 + 1.6 + 1.6 + 1.6 + 4.2	16	12.04	3.72	11.13	3.60	10.76	3.55	10.34	3.43	9.65	3.22
	18	11.40	3.78	10.61	3.63	9.92	3.57	10.14	3.46	9.88	3.29
	20	10.75	3.80	10.21	3.65	9.99	3.59	9.96	3.51	9.91	3.38
	21	10.31	3.81	9.67	3.67	9.42	3.61	9.58	3.54	9.83	3.42
	22	10.07	3.83	9.92	3.68	9.86	3.62	9.80	3.56	9.71	3.46
	24	9.36	3.87	9.73	3.73	9.88	3.67	9.67	3.62	9.32	3.54
1.6 + 1.6 + 1.6 + 1.6 + 5.0	16	12.04	3.66	11.13	3.54	10.76	3.49	10.34	3.37	9.65	3.17
	18	11.40	3.72	10.61	3.57	9.92	3.51	10.14	3.41	9.88	3.23
	20	10.75	3.74	10.21	3.59	9.99	3.53	9.96	3.45	9.91	3.32
	21	10.31	3.75	9.67	3.61	9.42	3.55	9.58	3.48	9.83	3.36
	22	10.07	3.77	9.92	3.62	9.86	3.57	9.80	3.50	9.71	3.40
	24	9.36	3.81	9.73	3.67	9.88	3.61	9.67	3.56	9.32	3.48

Combination (Capacity)	Indoor Air Temp. °C DB	Outdoor Air Temp. °C											
		16/15		15/14		10/9		7/6		6/5		2/1	
		Total Q	Input Power	Total Q	Input Power	Total Q	Input Power	Total Q	Input Power	Total Q	Input Power	Total Q	Input Power
1.6 + 1.6 + 1.6 + 1.6 + 6.0	16	20.14	2.81	19.73	2.88	17.66	3.24	16.41	3.45	15.61	3.50	12.40	3.70
	18	19.30	2.93	18.87	2.99	16.73	3.33	15.45	3.54	14.70	3.59	11.71	3.78
	20	19.01	3.00	18.51	3.07	16.00	3.41	14.50	3.61	13.79	3.65	10.96	3.79
	21	19.04	3.04	18.48	3.09	15.66	3.34	13.96	3.49	13.28	3.56	10.56	3.81
	22	19.20	3.06	18.67	3.13	16.03	3.47	14.45	3.68	13.58	3.71	10.13	3.83
	24	19.90	3.09	19.09	3.16	15.06	3.52	12.64	3.73	11.96	3.76	9.22	3.87
1.6 + 1.6 + 1.6 + 1.6 + 7.1	16	20.14	2.80	19.73	2.87	17.66	3.23	16.41	3.44	15.61	3.49	12.40	3.69
	18	19.30	2.92	18.87	2.99	16.73	3.32	15.45	3.53	14.70	3.58	11.71	3.77
	20	19.01	3.00	18.51	3.06	16.00	3.40	14.50	3.60	13.79	3.64	10.96	3.78
	21	19.04	3.03	18.48	3.08	15.66	3.33	13.96	3.48	13.28	3.55	10.56	3.80
	22	19.20	3.05	18.67	3.12	16.03	3.46	14.45	3.67	13.58	3.70	10.13	3.82
	24	19.90	3.08	19.09	3.15	15.06	3.51	12.64	3.72	11.96	3.75	9.22	3.86
1.6 + 1.6 + 1.6 + 2.0 + 2.0	16	20.14	2.84	19.73	2.91	17.66	3.27	16.41	3.49	15.61	3.54	12.40	3.75
	18	19.30	2.96	18.87	3.03	16.73	3.37	15.45	3.58	14.70	3.63	11.71	3.82
	20	19.01	3.04	18.51	3.11	16.00	3.45	14.50	3.65	13.79	3.69	10.96	3.84
	21	19.04	3.07	18.48	3.12	15.66	3.38	13.96	3.53	13.28	3.59	10.56	3.85
	22	19.20	3.09	18.67	3.16	16.03	3.51	14.45	3.72	13.58	3.75	10.13	3.87
	24	19.90	3.12	19.09	3.19	15.06	3.56	12.64	3.77	11.96	3.80	9.22	3.91
1.6 + 1.6 + 1.6 + 2.0 + 2.5	16	20.14	2.84	19.73	2.91	17.66	3.27	16.41	3.49	15.61	3.54	12.40	3.75
	18	19.30	2.96	18.87	3.03	16.73	3.37	15.45	3.58	14.70	3.63	11.71	3.82
	20	19.01	3.04	18.51	3.11	16.00	3.45	14.50	3.65	13.79	3.69	10.96	3.84
	21	19.04	3.07	18.48	3.12	15.66	3.38	13.96	3.53	13.28	3.59	10.56	3.85
	22	19.20	3.09	18.67	3.16	16.03	3.51	14.45	3.72	13.58	3.75	10.13	3.87
	24	19.90	3.12	19.09	3.19	15.06	3.56	12.64	3.77	11.96	3.80	9.22	3.91
1.6 + 1.6 + 1.6 + 2.0 + 3.5	16	20.14	2.86	19.73	2.93	17.66	3.29	16.41	3.51	15.61	3.56	12.40	3.77
	18	19.30	2.97	18.87	3.04	16.73	3.39	15.45	3.60	14.70	3.65	11.71	3.84
	20	19.01	3.05	18.51	3.12	16.00	3.46	14.50	3.67	13.79	3.71	10.96	3.86
	21	19.04	3.09	18.48	3.14	15.66	3.40	13.96	3.55	13.28	3.61	10.56	3.87
	22	19.20	3.11	18.67	3.18	16.03	3.53	14.45	3.74	13.58	3.77	10.13	3.89
	24	19.90	3.14	19.09	3.21	15.06	3.58	12.64	3.79	11.96	3.82	9.22	3.93
1.6 + 1.6 + 1.6 + 2.0 + 4.2	16	20.14	2.85	19.73	2.92	17.66	3.28	16.41	3.50	15.61	3.55	12.40	3.76
	18	19.30	2.97	18.87	3.04	16.73	3.38	15.45	3.59	14.70	3.64	11.71	3.83
	20	19.01	3.05	18.51	3.11	16.00	3.46	14.50	3.66	13.79	3.70	10.96	3.85
	21	19.04	3.08	18.48	3.13	15.66	3.39	13.96	3.54	13.28	3.60	10.56	3.86
	22	19.20	3.10	18.67	3.17	16.03	3.52	14.45	3.73	13.58	3.76	10.13	3.88
	24	19.90	3.13	19.09	3.20	15.06	3.57	12.64	3.78	11.96	3.81	9.22	3.92



Combination (Capacity)	Indoor Air Temp. °C DB	Outdoor Air Temp. °C									
		0/-1		-5/-6		-7/-8		-10/-11		-15/-	
		Total Q	Input Power	Total Q	Input Power	Total Q	Input Power	Total Q	Input Power	Total Q	Input Power
1.6 + 1.6 + 1.6 + 1.6 + 6.0	16	12.04	3.66	11.13	3.54	10.76	3.49	10.34	3.37	9.65	3.17
	18	11.40	3.72	10.61	3.57	9.92	3.51	10.14	3.41	9.88	3.23
	20	10.75	3.74	10.21	3.59	9.99	3.53	9.96	3.45	9.91	3.32
	21	10.31	3.75	9.67	3.61	9.42	3.55	9.58	3.48	9.83	3.36
	22	10.07	3.77	9.92	3.62	9.86	3.57	9.80	3.50	9.71	3.40
	24	9.36	3.81	9.73	3.67	9.88	3.61	9.67	3.56	9.32	3.48
1.6 + 1.6 + 1.6 + 1.6 + 7.1	16	12.04	3.65	11.13	3.53	10.76	3.48	10.34	3.36	9.65	3.16
	18	11.40	3.71	10.61	3.56	9.92	3.50	10.14	3.40	9.88	3.22
	20	10.75	3.73	10.21	3.58	9.99	3.52	9.96	3.44	9.91	3.31
	21	10.31	3.74	9.67	3.60	9.42	3.54	9.58	3.47	9.83	3.35
	22	10.07	3.76	9.92	3.61	9.86	3.56	9.80	3.49	9.71	3.39
	24	9.36	3.80	9.73	3.66	9.88	3.60	9.67	3.55	9.32	3.47
1.6 + 1.6 + 1.6 + 2.0 + 2.0	16	12.04	3.70	11.13	3.58	10.76	3.53	10.34	3.41	9.65	3.21
	18	11.40	3.76	10.61	3.61	9.92	3.55	10.14	3.44	9.88	3.27
	20	10.75	3.78	10.21	3.63	9.99	3.57	9.96	3.49	9.91	3.36
	21	10.31	3.79	9.67	3.65	9.42	3.59	9.58	3.52	9.83	3.40
	22	10.07	3.81	9.92	3.66	9.86	3.61	9.80	3.54	9.71	3.44
	24	9.36	3.85	9.73	3.71	9.88	3.65	9.67	3.60	9.32	3.52
1.6 + 1.6 + 1.6 + 2.0 + 2.5	16	12.04	3.70	11.13	3.58	10.76	3.53	10.34	3.41	9.65	3.21
	18	11.40	3.76	10.61	3.61	9.92	3.55	10.14	3.44	9.88	3.27
	20	10.75	3.78	10.21	3.63	9.99	3.57	9.96	3.49	9.91	3.36
	21	10.31	3.79	9.67	3.65	9.42	3.59	9.58	3.52	9.83	3.40
	22	10.07	3.81	9.92	3.66	9.86	3.61	9.80	3.54	9.71	3.44
	24	9.36	3.85	9.73	3.71	9.88	3.65	9.67	3.60	9.32	3.52
1.6 + 1.6 + 1.6 + 2.0 + 3.5	16	12.04	3.72	11.13	3.60	10.76	3.55	10.34	3.43	9.65	3.22
	18	11.40	3.78	10.61	3.63	9.92	3.57	10.14	3.46	9.88	3.29
	20	10.75	3.80	10.21	3.65	9.99	3.59	9.96	3.51	9.91	3.38
	21	10.31	3.81	9.67	3.67	9.42	3.61	9.58	3.54	9.83	3.42
	22	10.07	3.83	9.92	3.68	9.86	3.62	9.80	3.56	9.71	3.46
	24	9.36	3.87	9.73	3.73	9.88	3.67	9.67	3.62	9.32	3.54
1.6 + 1.6 + 1.6 + 2.0 + 4.2	16	12.04	3.71	11.13	3.59	10.76	3.54	10.34	3.42	9.65	3.21
	18	11.40	3.77	10.61	3.62	9.92	3.56	10.14	3.45	9.88	3.28
	20	10.75	3.79	10.21	3.64	9.99	3.58	9.96	3.50	9.91	3.37
	21	10.31	3.80	9.67	3.66	9.42	3.60	9.58	3.53	9.83	3.41
	22	10.07	3.82	9.92	3.67	9.86	3.61	9.80	3.55	9.71	3.45
	24	9.36	3.86	9.73	3.72	9.88	3.66	9.67	3.61	9.32	3.53

Combination (Capacity)	Indoor Air Temp. °C DB	Outdoor Air Temp. °C											
		16/15		15/14		10/9		7/6		6/5		2/1	
		Total Q	Input Power	Total Q	Input Power	Total Q	Input Power	Total Q	Input Power	Total Q	Input Power	Total Q	Input Power
1.6 + 1.6 + 1.6 + 2.0 + 5.0	16	20.14	2.80	19.73	2.87	17.66	3.23	16.41	3.44	15.61	3.49	12.40	3.69
	18	19.30	2.92	18.87	2.99	16.73	3.32	15.45	3.53	14.70	3.58	11.71	3.77
	20	19.01	3.00	18.51	3.06	16.00	3.40	14.50	3.60	13.79	3.64	10.96	3.78
	21	19.04	3.03	18.48	3.08	15.66	3.33	13.96	3.48	13.28	3.55	10.56	3.80
	22	19.20	3.05	18.67	3.12	16.03	3.46	14.45	3.67	13.58	3.70	10.13	3.82
	24	19.90	3.08	19.09	3.15	15.06	3.51	12.64	3.72	11.96	3.75	9.22	3.86
1.6 + 1.6 + 1.6 + 2.0 + 6.0	16	20.14	2.80	19.73	2.87	17.66	3.23	16.41	3.44	15.61	3.49	12.40	3.69
	18	19.30	2.92	18.87	2.99	16.73	3.32	15.45	3.53	14.70	3.58	11.71	3.77
	20	19.01	3.00	18.51	3.06	16.00	3.40	14.50	3.60	13.79	3.64	10.96	3.78
	21	19.04	3.03	18.48	3.08	15.66	3.33	13.96	3.48	13.28	3.55	10.56	3.80
	22	19.20	3.05	18.67	3.12	16.03	3.46	14.45	3.67	13.58	3.70	10.13	3.82
	24	19.90	3.08	19.09	3.15	15.06	3.51	12.64	3.72	11.96	3.75	9.22	3.86
1.6 + 1.6 + 1.6 + 2.0 + 7.1	16	20.14	2.79	19.73	2.86	17.66	3.22	16.41	3.43	15.61	3.48	12.40	3.68
	18	19.30	2.91	18.87	2.98	16.73	3.32	15.45	3.52	14.70	3.57	11.71	3.76
	20	19.01	2.99	18.51	3.05	16.00	3.39	14.50	3.59	13.79	3.63	10.96	3.77
	21	19.04	3.02	18.48	3.07	15.66	3.32	13.96	3.47	13.28	3.54	10.56	3.79
	22	19.20	3.04	18.67	3.11	16.03	3.45	14.45	3.66	13.58	3.69	10.13	3.81
	24	19.90	3.07	19.09	3.14	15.06	3.50	12.64	3.71	11.96	3.74	9.22	3.84
1.6 + 1.6 + 1.6 + 2.5 + 2.5	16	20.14	2.84	19.73	2.91	17.66	3.27	16.41	3.49	15.61	3.54	12.40	3.75
	18	19.30	2.96	18.87	3.03	16.73	3.37	15.45	3.58	14.70	3.63	11.71	3.82
	20	19.01	3.04	18.51	3.11	16.00	3.45	14.50	3.65	13.79	3.69	10.96	3.84
	21	19.04	3.07	18.48	3.12	15.66	3.38	13.96	3.53	13.28	3.59	10.56	3.85
	22	19.20	3.09	18.67	3.16	16.03	3.51	14.45	3.72	13.58	3.75	10.13	3.87
	24	19.90	3.12	19.09	3.19	15.06	3.56	12.64	3.77	11.96	3.80	9.22	3.91
1.6 + 1.6 + 1.6 + 2.5 + 3.5	16	20.14	2.86	19.73	2.93	17.66	3.29	16.41	3.51	15.61	3.56	12.40	3.77
	18	19.30	2.97	18.87	3.04	16.73	3.39	15.45	3.60	14.70	3.65	11.71	3.84
	20	19.01	3.05	18.51	3.12	16.00	3.46	14.50	3.67	13.79	3.71	10.96	3.86
	21	19.04	3.09	18.48	3.14	15.66	3.40	13.96	3.55	13.28	3.61	10.56	3.87
	22	19.20	3.11	18.67	3.18	16.03	3.53	14.45	3.74	13.58	3.77	10.13	3.89
	24	19.90	3.14	19.09	3.21	15.06	3.58	12.64	3.79	11.96	3.82	9.22	3.93
1.6 + 1.6 + 1.6 + 2.5 + 4.2	16	20.14	2.85	19.73	2.92	17.66	3.28	16.41	3.50	15.61	3.55	12.40	3.76
	18	19.30	2.97	18.87	3.04	16.73	3.38	15.45	3.59	14.70	3.64	11.71	3.83
	20	19.01	3.05	18.51	3.11	16.00	3.46	14.50	3.66	13.79	3.70	10.96	3.85
	21	19.04	3.08	18.48	3.13	15.66	3.39	13.96	3.54	13.28	3.60	10.56	3.86
	22	19.20	3.10	18.67	3.17	16.03	3.52	14.45	3.73	13.58	3.76	10.13	3.88
	24	19.90	3.13	19.09	3.20	15.06	3.57	12.64	3.78	11.96	3.81	9.22	3.92

Combination (Capacity)	Indoor Air Temp. °C DB	Outdoor Air Temp. °C									
		0/-1		-5/-6		-7/-8		-10/-11		-15/-	
		Total Q	Input Power	Total Q	Input Power	Total Q	Input Power	Total Q	Input Power	Total Q	Input Power
1.6 + 1.6 + 1.6 + 2.0 + 5.0	16	12.04	3.65	11.13	3.53	10.76	3.48	10.34	3.36	9.65	3.16
	18	11.40	3.71	10.61	3.56	9.92	3.50	10.14	3.40	9.88	3.22
	20	10.75	3.73	10.21	3.58	9.99	3.52	9.96	3.44	9.91	3.31
	21	10.31	3.74	9.67	3.60	9.42	3.54	9.58	3.47	9.83	3.35
	22	10.07	3.76	9.92	3.61	9.86	3.56	9.80	3.49	9.71	3.39
	24	9.36	3.80	9.73	3.66	9.88	3.60	9.67	3.55	9.32	3.47
1.6 + 1.6 + 1.6 + 2.0 + 6.0	16	12.04	3.65	11.13	3.53	10.76	3.48	10.34	3.36	9.65	3.16
	18	11.40	3.71	10.61	3.56	9.92	3.50	10.14	3.40	9.88	3.22
	20	10.75	3.73	10.21	3.58	9.99	3.52	9.96	3.44	9.91	3.31
	21	10.31	3.74	9.67	3.60	9.42	3.54	9.58	3.47	9.83	3.35
	22	10.07	3.76	9.92	3.61	9.86	3.56	9.80	3.49	9.71	3.39
	24	9.36	3.80	9.73	3.66	9.88	3.60	9.67	3.55	9.32	3.47
1.6 + 1.6 + 1.6 + 2.0 + 7.1	16	12.04	3.64	11.13	3.52	10.76	3.47	10.34	3.35	9.65	3.15
	18	11.40	3.70	10.61	3.55	9.92	3.49	10.14	3.39	9.88	3.21
	20	10.75	3.71	10.21	3.57	9.99	3.51	9.96	3.43	9.91	3.30
	21	10.31	3.73	9.67	3.59	9.42	3.53	9.58	3.46	9.83	3.34
	22	10.07	3.75	9.92	3.60	9.86	3.55	9.80	3.48	9.71	3.38
	24	9.36	3.79	9.73	3.65	9.88	3.59	9.67	3.54	9.32	3.46
1.6 + 1.6 + 1.6 + 2.5 + 2.5	16	12.04	3.70	11.13	3.58	10.76	3.53	10.34	3.41	9.65	3.21
	18	11.40	3.76	10.61	3.61	9.92	3.55	10.14	3.44	9.88	3.27
	20	10.75	3.78	10.21	3.63	9.99	3.57	9.96	3.49	9.91	3.36
	21	10.31	3.79	9.67	3.65	9.42	3.59	9.58	3.52	9.83	3.40
	22	10.07	3.81	9.92	3.66	9.86	3.61	9.80	3.54	9.71	3.44
	24	9.36	3.85	9.73	3.71	9.88	3.65	9.67	3.60	9.32	3.52
1.6 + 1.6 + 1.6 + 2.5 + 3.5	16	12.04	3.72	11.13	3.60	10.76	3.55	10.34	3.43	9.65	3.22
	18	11.40	3.78	10.61	3.63	9.92	3.57	10.14	3.46	9.88	3.29
	20	10.75	3.80	10.21	3.65	9.99	3.59	9.96	3.51	9.91	3.38
	21	10.31	3.81	9.67	3.67	9.42	3.61	9.58	3.54	9.83	3.42
	22	10.07	3.83	9.92	3.68	9.86	3.62	9.80	3.56	9.71	3.46
	24	9.36	3.87	9.73	3.73	9.88	3.67	9.67	3.62	9.32	3.54
1.6 + 1.6 + 1.6 + 2.5 + 4.2	16	12.04	3.71	11.13	3.59	10.76	3.54	10.34	3.42	9.65	3.21
	18	11.40	3.77	10.61	3.62	9.92	3.56	10.14	3.45	9.88	3.28
	20	10.75	3.79	10.21	3.64	9.99	3.58	9.96	3.50	9.91	3.37
	21	10.31	3.80	9.67	3.66	9.42	3.60	9.58	3.53	9.83	3.41
	22	10.07	3.82	9.92	3.67	9.86	3.61	9.80	3.55	9.71	3.45
	24	9.36	3.86	9.73	3.72	9.88	3.66	9.67	3.61	9.32	3.53

Combination (Capacity)	Indoor Air Temp. °C DB	Outdoor Air Temp. °C											
		16/15		15/14		10/9		7/6		6/5		2/1	
		Total Q	Input Power	Total Q	Input Power	Total Q	Input Power	Total Q	Input Power	Total Q	Input Power	Total Q	Input Power
1.6 + 1.6 + 1.6 + 2.5 + 5.0	16	20.14	2.80	19.73	2.87	17.66	3.23	16.41	3.44	15.61	3.49	12.40	3.69
	18	19.30	2.92	18.87	2.99	16.73	3.32	15.45	3.53	14.70	3.58	11.71	3.77
	20	19.01	3.00	18.51	3.06	16.00	3.40	14.50	3.60	13.79	3.64	10.96	3.78
	21	19.04	3.03	18.48	3.08	15.66	3.33	13.96	3.48	13.28	3.55	10.56	3.80
	22	19.20	3.05	18.67	3.12	16.03	3.46	14.45	3.67	13.58	3.70	10.13	3.82
	24	19.90	3.08	19.09	3.15	15.06	3.51	12.64	3.72	11.96	3.75	9.22	3.86
1.6 + 1.6 + 1.6 + 2.5 + 6.0	16	20.14	2.80	19.73	2.87	17.66	3.23	16.41	3.44	15.61	3.49	12.40	3.69
	18	19.30	2.92	18.87	2.99	16.73	3.32	15.45	3.53	14.70	3.58	11.71	3.77
	20	19.01	3.00	18.51	3.06	16.00	3.40	14.50	3.60	13.79	3.64	10.96	3.78
	21	19.04	3.03	18.48	3.08	15.66	3.33	13.96	3.48	13.28	3.55	10.56	3.80
	22	19.20	3.05	18.67	3.12	16.03	3.46	14.45	3.67	13.58	3.70	10.13	3.82
	24	19.90	3.08	19.09	3.15	15.06	3.51	12.64	3.72	11.96	3.75	9.22	3.86
1.6 + 1.6 + 1.6 + 2.5 + 7.1	16	20.14	2.79	19.73	2.86	17.66	3.22	16.41	3.43	15.61	3.48	12.40	3.68
	18	19.30	2.91	18.87	2.98	16.73	3.32	15.45	3.52	14.70	3.57	11.71	3.76
	20	19.01	2.99	18.51	3.05	16.00	3.39	14.50	3.59	13.79	3.63	10.96	3.77
	21	19.04	3.02	18.48	3.07	15.66	3.32	13.96	3.47	13.28	3.54	10.56	3.79
	22	19.20	3.04	18.67	3.11	16.03	3.45	14.45	3.66	13.58	3.69	10.13	3.81
	24	19.90	3.07	19.09	3.14	15.06	3.50	12.64	3.71	11.96	3.74	9.22	3.84
1.6 + 1.6 + 1.6 + 3.5 + 3.5	16	20.14	2.83	19.73	2.90	17.66	3.26	16.41	3.48	15.61	3.53	12.40	3.74
	18	19.30	2.95	18.87	3.02	16.73	3.36	15.45	3.57	14.70	3.62	11.71	3.81
	20	19.01	3.03	18.51	3.10	16.00	3.44	14.50	3.64	13.79	3.68	10.96	3.83
	21	19.04	3.06	18.48	3.11	15.66	3.37	13.96	3.52	13.28	3.58	10.56	3.84
	22	19.20	3.08	18.67	3.15	16.03	3.50	14.45	3.71	13.58	3.74	10.13	3.86
	24	19.90	3.11	19.09	3.19	15.06	3.55	12.64	3.76	11.96	3.79	9.22	3.90
1.6 + 1.6 + 1.6 + 3.5 + 4.2	16	20.14	2.82	19.73	2.90	17.66	3.25	16.41	3.47	15.61	3.52	12.40	3.73
	18	19.30	2.94	18.87	3.01	16.73	3.35	15.45	3.56	14.70	3.61	11.71	3.80
	20	19.01	3.02	18.51	3.09	16.00	3.43	14.50	3.63	13.79	3.67	10.96	3.81
	21	19.04	3.05	18.48	3.10	15.66	3.36	13.96	3.51	13.28	3.58	10.56	3.83
	22	19.20	3.08	18.67	3.15	16.03	3.49	14.45	3.70	13.58	3.73	10.13	3.85
	24	19.90	3.10	19.09	3.18	15.06	3.54	12.64	3.75	11.96	3.78	9.22	3.89
1.6 + 1.6 + 1.6 + 3.5 + 5.0	16	20.14	2.82	19.73	2.90	17.66	3.25	16.41	3.47	15.61	3.52	12.40	3.73
	18	19.30	2.94	18.87	3.01	16.73	3.35	15.45	3.56	14.70	3.61	11.71	3.80
	20	19.01	3.02	18.51	3.09	16.00	3.43	14.50	3.63	13.79	3.67	10.96	3.81
	21	19.04	3.05	18.48	3.10	15.66	3.36	13.96	3.51	13.28	3.58	10.56	3.83
	22	19.20	3.08	18.67	3.15	16.03	3.49	14.45	3.70	13.58	3.73	10.13	3.85
	24	19.90	3.10	19.09	3.18	15.06	3.54	12.64	3.75	11.96	3.78	9.22	3.89

Combination (Capacity)	Indoor Air Temp. °C DB	Outdoor Air Temp. °C									
		0/-1		-5/-6		-7/-8		-10/-11		-15/-	
		Total Q	Input Power	Total Q	Input Power	Total Q	Input Power	Total Q	Input Power	Total Q	Input Power
1.6 + 1.6 + 1.6 + 2.5 + 5.0	16	12.04	3.65	11.13	3.53	10.76	3.48	10.34	3.36	9.65	3.16
	18	11.40	3.71	10.61	3.56	9.92	3.50	10.14	3.40	9.88	3.22
	20	10.75	3.73	10.21	3.58	9.99	3.52	9.96	3.44	9.91	3.31
	21	10.31	3.74	9.67	3.60	9.42	3.54	9.58	3.47	9.83	3.35
	22	10.07	3.76	9.92	3.61	9.86	3.56	9.80	3.49	9.71	3.39
	24	9.36	3.80	9.73	3.66	9.88	3.60	9.67	3.55	9.32	3.47
1.6 + 1.6 + 1.6 + 2.5 + 6.0	16	12.04	3.65	11.13	3.53	10.76	3.48	10.34	3.36	9.65	3.16
	18	11.40	3.71	10.61	3.56	9.92	3.50	10.14	3.40	9.88	3.22
	20	10.75	3.73	10.21	3.58	9.99	3.52	9.96	3.44	9.91	3.31
	21	10.31	3.74	9.67	3.60	9.42	3.54	9.58	3.47	9.83	3.35
	22	10.07	3.76	9.92	3.61	9.86	3.56	9.80	3.49	9.71	3.39
	24	9.36	3.80	9.73	3.66	9.88	3.60	9.67	3.55	9.32	3.47
1.6 + 1.6 + 1.6 + 2.5 + 7.1	16	12.04	3.64	11.13	3.52	10.76	3.47	10.34	3.35	9.65	3.15
	18	11.40	3.70	10.61	3.55	9.92	3.49	10.14	3.39	9.88	3.21
	20	10.75	3.71	10.21	3.57	9.99	3.51	9.96	3.43	9.91	3.30
	21	10.31	3.73	9.67	3.59	9.42	3.53	9.58	3.46	9.83	3.34
	22	10.07	3.75	9.92	3.60	9.86	3.55	9.80	3.48	9.71	3.38
	24	9.36	3.79	9.73	3.65	9.88	3.59	9.67	3.54	9.32	3.46
1.6 + 1.6 + 1.6 + 3.5 + 3.5	16	12.04	3.69	11.13	3.57	10.76	3.52	10.34	3.40	9.65	3.20
	18	11.40	3.75	10.61	3.60	9.92	3.54	10.14	3.43	9.88	3.26
	20	10.75	3.77	10.21	3.62	9.99	3.56	9.96	3.48	9.91	3.35
	21	10.31	3.78	9.67	3.64	9.42	3.58	9.58	3.51	9.83	3.39
	22	10.07	3.80	9.92	3.65	9.86	3.60	9.80	3.53	9.71	3.43
	24	9.36	3.84	9.73	3.70	9.88	3.64	9.67	3.59	9.32	3.51
1.6 + 1.6 + 1.6 + 3.5 + 4.2	16	12.04	3.68	11.13	3.56	10.76	3.51	10.34	3.39	9.65	3.19
	18	11.40	3.74	10.61	3.59	9.92	3.53	10.14	3.42	9.88	3.25
	20	10.75	3.76	10.21	3.61	9.99	3.55	9.96	3.47	9.91	3.34
	21	10.31	3.77	9.67	3.63	9.42	3.57	9.58	3.50	9.83	3.38
	22	10.07	3.79	9.92	3.64	9.86	3.59	9.80	3.52	9.71	3.42
	24	9.36	3.83	9.73	3.69	9.88	3.63	9.67	3.58	9.32	3.50
1.6 + 1.6 + 1.6 + 3.5 + 5.0	16	12.04	3.68	11.13	3.56	10.76	3.51	10.34	3.39	9.65	3.19
	18	11.40	3.74	10.61	3.59	9.92	3.53	10.14	3.42	9.88	3.25
	20	10.75	3.76	10.21	3.61	9.99	3.55	9.96	3.47	9.91	3.34
	21	10.31	3.77	9.67	3.63	9.42	3.57	9.58	3.50	9.83	3.38
	22	10.07	3.79	9.92	3.64	9.86	3.59	9.80	3.52	9.71	3.42
	24	9.36	3.83	9.73	3.69	9.88	3.63	9.67	3.58	9.32	3.50

Combination (Capacity)	Indoor Air Temp. °C DB	Outdoor Air Temp. °C											
		16/15		15/14		10/9		7/6		6/5		2/1	
		Total Q	Input Power	Total Q	Input Power	Total Q	Input Power	Total Q	Input Power	Total Q	Input Power	Total Q	Input Power
1.6 + 1.6 + 1.6 + 3.5 + 6.0	16	20.14	2.82	19.73	2.90	17.66	3.25	16.41	3.47	15.61	3.52	12.40	3.73
	18	19.30	2.94	18.87	3.01	16.73	3.35	15.45	3.56	14.70	3.61	11.71	3.80
	20	19.01	3.02	18.51	3.09	16.00	3.43	14.50	3.63	13.79	3.67	10.96	3.81
	21	19.04	3.05	18.48	3.10	15.66	3.36	13.96	3.51	13.28	3.58	10.56	3.83
	22	19.20	3.08	18.67	3.15	16.03	3.49	14.45	3.70	13.58	3.73	10.13	3.85
	24	19.90	3.10	19.09	3.18	15.06	3.54	12.64	3.75	11.96	3.78	9.22	3.89
1.6 + 1.6 + 1.6 + 3.5 + 7.1	16	20.14	2.82	19.73	2.89	17.66	3.24	16.41	3.46	15.61	3.51	12.40	3.71
	18	19.30	2.93	18.87	3.00	16.73	3.34	15.45	3.55	14.70	3.60	11.71	3.79
	20	19.01	3.01	18.51	3.08	16.00	3.42	14.50	3.62	13.79	3.66	10.96	3.80
	21	19.04	3.05	18.48	3.10	15.66	3.35	13.96	3.50	13.28	3.57	10.56	3.82
	22	19.20	3.07	18.67	3.14	16.03	3.48	14.45	3.69	13.58	3.72	10.13	3.84
	24	19.90	3.10	19.09	3.17	15.06	3.53	12.64	3.74	11.96	3.77	9.22	3.88
1.6 + 1.6 + 1.6 + 4.2 + 4.2	16	20.14	2.82	19.73	2.89	17.66	3.24	16.41	3.46	15.61	3.51	12.40	3.71
	18	19.30	2.93	18.87	3.00	16.73	3.34	15.45	3.55	14.70	3.60	11.71	3.79
	20	19.01	3.01	18.51	3.08	16.00	3.42	14.50	3.62	13.79	3.66	10.96	3.80
	21	19.04	3.05	18.48	3.10	15.66	3.35	13.96	3.50	13.28	3.57	10.56	3.82
	22	19.20	3.07	18.67	3.14	16.03	3.48	14.45	3.69	13.58	3.72	10.13	3.84
	24	19.90	3.10	19.09	3.17	15.06	3.53	12.64	3.74	11.96	3.77	9.22	3.88
1.6 + 1.6 + 1.6 + 4.2 + 5.0	16	20.14	2.82	19.73	2.89	17.66	3.24	16.41	3.46	15.61	3.51	12.40	3.71
	18	19.30	2.93	18.87	3.00	16.73	3.34	15.45	3.55	14.70	3.60	11.71	3.79
	20	19.01	3.01	18.51	3.08	16.00	3.42	14.50	3.62	13.79	3.66	10.96	3.80
	21	19.04	3.05	18.48	3.10	15.66	3.35	13.96	3.50	13.28	3.57	10.56	3.82
	22	19.20	3.07	18.67	3.14	16.03	3.48	14.45	3.69	13.58	3.72	10.13	3.84
	24	19.90	3.10	19.09	3.17	15.06	3.53	12.64	3.74	11.96	3.77	9.22	3.88
1.6 + 1.6 + 1.6 + 4.2 + 6.0	16	20.14	2.82	19.73	2.89	17.66	3.24	16.41	3.46	15.61	3.51	12.40	3.71
	18	19.30	2.93	18.87	3.00	16.73	3.34	15.45	3.55	14.70	3.60	11.71	3.79
	20	19.01	3.01	18.51	3.08	16.00	3.42	14.50	3.62	13.79	3.66	10.96	3.80
	21	19.04	3.05	18.48	3.10	15.66	3.35	13.96	3.50	13.28	3.57	10.56	3.82
	22	19.20	3.07	18.67	3.14	16.03	3.48	14.45	3.69	13.58	3.72	10.13	3.84
	24	19.90	3.10	19.09	3.17	15.06	3.53	12.64	3.74	11.96	3.77	9.22	3.88
1.6 + 1.6 + 1.6 + 4.2 + 7.1	16	20.14	2.81	19.73	2.88	17.66	3.24	16.41	3.45	15.61	3.50	12.40	3.70
	18	19.30	2.93	18.87	2.99	16.73	3.33	15.45	3.54	14.70	3.59	11.71	3.78
	20	19.01	3.00	18.51	3.07	16.00	3.41	14.50	3.61	13.79	3.65	10.96	3.79
	21	19.04	3.04	18.48	3.09	15.66	3.34	13.96	3.49	13.28	3.56	10.56	3.81
	22	19.20	3.06	18.67	3.13	16.03	3.47	14.45	3.68	13.58	3.71	10.13	3.83
	24	19.90	3.09	19.09	3.16	15.06	3.52	12.64	3.73	11.96	3.76	9.22	3.87

Combination (Capacity)	Indoor Air Temp. °C DB	Outdoor Air Temp. °C									
		0/-1		-5/-6		-7/-8		-10/-11		-15/-	
		Total Q	Input Power	Total Q	Input Power	Total Q	Input Power	Total Q	Input Power	Total Q	Input Power
1.6 + 1.6 + 1.6 + 3.5 + 6.0	16	12.04	3.68	11.13	3.56	10.76	3.51	10.34	3.39	9.65	3.19
	18	11.40	3.74	10.61	3.59	9.92	3.53	10.14	3.42	9.88	3.25
	20	10.75	3.76	10.21	3.61	9.99	3.55	9.96	3.47	9.91	3.34
	21	10.31	3.77	9.67	3.63	9.42	3.57	9.58	3.50	9.83	3.38
	22	10.07	3.79	9.92	3.64	9.86	3.59	9.80	3.52	9.71	3.42
	24	9.36	3.83	9.73	3.69	9.88	3.63	9.67	3.58	9.32	3.50
1.6 + 1.6 + 1.6 + 3.5 + 7.1	16	12.04	3.67	11.13	3.55	10.76	3.50	10.34	3.38	9.65	3.18
	18	11.40	3.73	10.61	3.58	9.92	3.52	10.14	3.42	9.88	3.24
	20	10.75	3.75	10.21	3.60	9.99	3.54	9.96	3.46	9.91	3.33
	21	10.31	3.76	9.67	3.62	9.42	3.56	9.58	3.49	9.83	3.37
	22	10.07	3.78	9.92	3.63	9.86	3.58	9.80	3.51	9.71	3.41
	24	9.36	3.82	9.73	3.68	9.88	3.62	9.67	3.57	9.32	3.49
1.6 + 1.6 + 1.6 + 4.2 + 4.2	16	12.04	3.67	11.13	3.55	10.76	3.50	10.34	3.38	9.65	3.18
	18	11.40	3.73	10.61	3.58	9.92	3.52	10.14	3.42	9.88	3.24
	20	10.75	3.75	10.21	3.60	9.99	3.54	9.96	3.46	9.91	3.33
	21	10.31	3.76	9.67	3.62	9.42	3.56	9.58	3.49	9.83	3.37
	22	10.07	3.78	9.92	3.63	9.86	3.58	9.80	3.51	9.71	3.41
	24	9.36	3.82	9.73	3.68	9.88	3.62	9.67	3.57	9.32	3.49
1.6 + 1.6 + 1.6 + 4.2 + 5.0	16	12.04	3.67	11.13	3.55	10.76	3.50	10.34	3.38	9.65	3.18
	18	11.40	3.73	10.61	3.58	9.92	3.52	10.14	3.42	9.88	3.24
	20	10.75	3.75	10.21	3.60	9.99	3.54	9.96	3.46	9.91	3.33
	21	10.31	3.76	9.67	3.62	9.42	3.56	9.58	3.49	9.83	3.37
	22	10.07	3.78	9.92	3.63	9.86	3.58	9.80	3.51	9.71	3.41
	24	9.36	3.82	9.73	3.68	9.88	3.62	9.67	3.57	9.32	3.49
1.6 + 1.6 + 1.6 + 4.2 + 6.0	16	12.04	3.67	11.13	3.55	10.76	3.50	10.34	3.38	9.65	3.18
	18	11.40	3.73	10.61	3.58	9.92	3.52	10.14	3.42	9.88	3.24
	20	10.75	3.75	10.21	3.60	9.99	3.54	9.96	3.46	9.91	3.33
	21	10.31	3.76	9.67	3.62	9.42	3.56	9.58	3.49	9.83	3.37
	22	10.07	3.78	9.92	3.63	9.86	3.58	9.80	3.51	9.71	3.41
	24	9.36	3.82	9.73	3.68	9.88	3.62	9.67	3.57	9.32	3.49
1.6 + 1.6 + 1.6 + 4.2 + 7.1	16	12.04	3.66	11.13	3.54	10.76	3.49	10.34	3.37	9.65	3.17
	18	11.40	3.72	10.61	3.57	9.92	3.51	10.14	3.41	9.88	3.23
	20	10.75	3.74	10.21	3.59	9.99	3.53	9.96	3.45	9.91	3.32
	21	10.31	3.75	9.67	3.61	9.42	3.55	9.58	3.48	9.83	3.36
	22	10.07	3.77	9.92	3.62	9.86	3.57	9.80	3.50	9.71	3.40
	24	9.36	3.81	9.73	3.67	9.88	3.61	9.67	3.56	9.32	3.48

Combination (Capacity)	Indoor Air Temp. °C DB	Outdoor Air Temp. °C											
		16/15		15/14		10/9		7/6		6/5		2/1	
		Total Q	Input Power	Total Q	Input Power	Total Q	Input Power	Total Q	Input Power	Total Q	Input Power	Total Q	Input Power
1.6 + 1.6 + 1.6 + 5.0 + 5.0	16	20.14	2.82	19.73	2.90	17.66	3.25	16.41	3.47	15.61	3.52	12.40	3.73
	18	19.30	2.94	18.87	3.01	16.73	3.35	15.45	3.56	14.70	3.61	11.71	3.80
	20	19.01	3.02	18.51	3.09	16.00	3.43	14.50	3.63	13.79	3.67	10.96	3.81
	21	19.04	3.05	18.48	3.10	15.66	3.36	13.96	3.51	13.28	3.58	10.56	3.83
	22	19.20	3.08	18.67	3.15	16.03	3.49	14.45	3.70	13.58	3.73	10.13	3.85
	24	19.90	3.10	19.09	3.18	15.06	3.54	12.64	3.75	11.96	3.78	9.22	3.89
1.6 + 1.6 + 1.6 + 5.0 + 6.0	16	20.14	2.82	19.73	2.90	17.66	3.25	16.41	3.47	15.61	3.52	12.40	3.73
	18	19.30	2.94	18.87	3.01	16.73	3.35	15.45	3.56	14.70	3.61	11.71	3.80
	20	19.01	3.02	18.51	3.09	16.00	3.43	14.50	3.63	13.79	3.67	10.96	3.81
	21	19.04	3.05	18.48	3.10	15.66	3.36	13.96	3.51	13.28	3.58	10.56	3.83
	22	19.20	3.08	18.67	3.15	16.03	3.49	14.45	3.70	13.58	3.73	10.13	3.85
	24	19.90	3.10	19.09	3.18	15.06	3.54	12.64	3.75	11.96	3.78	9.22	3.89
1.6 + 1.6 + 1.6 + 5.0 + 7.1	16	20.14	2.82	19.73	2.89	17.66	3.24	16.41	3.46	15.61	3.51	12.40	3.71
	18	19.30	2.93	18.87	3.00	16.73	3.34	15.45	3.55	14.70	3.60	11.71	3.79
	20	19.01	3.01	18.51	3.08	16.00	3.42	14.50	3.62	13.79	3.66	10.96	3.80
	21	19.04	3.05	18.48	3.10	15.66	3.35	13.96	3.50	13.28	3.57	10.56	3.82
	22	19.20	3.07	18.67	3.14	16.03	3.48	14.45	3.69	13.58	3.72	10.13	3.84
	24	19.90	3.10	19.09	3.17	15.06	3.53	12.64	3.74	11.96	3.77	9.22	3.88
1.6 + 1.6 + 1.6 + 6.0 + 6.0	16	20.14	2.82	19.73	2.90	17.66	3.25	16.41	3.47	15.61	3.52	12.40	3.73
	18	19.30	2.94	18.87	3.01	16.73	3.35	15.45	3.56	14.70	3.61	11.71	3.80
	20	19.01	3.02	18.51	3.09	16.00	3.43	14.50	3.63	13.79	3.67	10.96	3.81
	21	19.04	3.05	18.48	3.10	15.66	3.36	13.96	3.51	13.28	3.58	10.56	3.83
	22	19.20	3.08	18.67	3.15	16.03	3.49	14.45	3.70	13.58	3.73	10.13	3.85
	24	19.90	3.10	19.09	3.18	15.06	3.54	12.64	3.75	11.96	3.78	9.22	3.89
1.6 + 1.6 + 1.6 + 6.0 + 7.1	16	20.14	2.82	19.73	2.89	17.66	3.24	16.41	3.46	15.61	3.51	12.40	3.71
	18	19.30	2.93	18.87	3.00	16.73	3.34	15.45	3.55	14.70	3.60	11.71	3.79
	20	19.01	3.01	18.51	3.08	16.00	3.42	14.50	3.62	13.79	3.66	10.96	3.80
	21	19.04	3.05	18.48	3.10	15.66	3.35	13.96	3.50	13.28	3.57	10.56	3.82
	22	19.20	3.07	18.67	3.14	16.03	3.48	14.45	3.69	13.58	3.72	10.13	3.84
	24	19.90	3.10	19.09	3.17	15.06	3.53	12.64	3.74	11.96	3.77	9.22	3.88
1.6 + 1.6 + 2.0 + 2.0 + 2.0	16	20.14	2.83	19.73	2.90	17.66	3.26	16.41	3.48	15.61	3.53	12.40	3.74
	18	19.30	2.95	18.87	3.02	16.73	3.36	15.45	3.57	14.70	3.62	11.71	3.81
	20	19.01	3.03	18.51	3.10	16.00	3.44	14.50	3.64	13.79	3.68	10.96	3.83
	21	19.04	3.06	18.48	3.11	15.66	3.37	13.96	3.52	13.28	3.58	10.56	3.84
	22	19.20	3.08	18.67	3.15	16.03	3.50	14.45	3.71	13.58	3.74	10.13	3.86
	24	19.90	3.11	19.09	3.19	15.06	3.55	12.64	3.76	11.96	3.79	9.22	3.90



Combination (Capacity)	Indoor Air Temp. °C DB	Outdoor Air Temp. °C									
		0/-1		-5/-6		-7/-8		-10/-11		-15/-	
		Total Q	Input Power	Total Q	Input Power	Total Q	Input Power	Total Q	Input Power	Total Q	Input Power
1.6 + 1.6 + 1.6 + 5.0 + 5.0	16	12.04	3.68	11.13	3.56	10.76	3.51	10.34	3.39	9.65	3.19
	18	11.40	3.74	10.61	3.59	9.92	3.53	10.14	3.42	9.88	3.25
	20	10.75	3.76	10.21	3.61	9.99	3.55	9.96	3.47	9.91	3.34
	21	10.31	3.77	9.67	3.63	9.42	3.57	9.58	3.50	9.83	3.38
	22	10.07	3.79	9.92	3.64	9.86	3.59	9.80	3.52	9.71	3.42
	24	9.36	3.83	9.73	3.69	9.88	3.63	9.67	3.58	9.32	3.50
1.6 + 1.6 + 1.6 + 5.0 + 6.0	16	12.04	3.68	11.13	3.56	10.76	3.51	10.34	3.39	9.65	3.19
	18	11.40	3.74	10.61	3.59	9.92	3.53	10.14	3.42	9.88	3.25
	20	10.75	3.76	10.21	3.61	9.99	3.55	9.96	3.47	9.91	3.34
	21	10.31	3.77	9.67	3.63	9.42	3.57	9.58	3.50	9.83	3.38
	22	10.07	3.79	9.92	3.64	9.86	3.59	9.80	3.52	9.71	3.42
	24	9.36	3.83	9.73	3.69	9.88	3.63	9.67	3.58	9.32	3.50
1.6 + 1.6 + 1.6 + 5.0 + 7.1	16	12.04	3.67	11.13	3.55	10.76	3.50	10.34	3.38	9.65	3.18
	18	11.40	3.73	10.61	3.58	9.92	3.52	10.14	3.42	9.88	3.24
	20	10.75	3.75	10.21	3.60	9.99	3.54	9.96	3.46	9.91	3.33
	21	10.31	3.76	9.67	3.62	9.42	3.56	9.58	3.49	9.83	3.37
	22	10.07	3.78	9.92	3.63	9.86	3.58	9.80	3.51	9.71	3.41
	24	9.36	3.82	9.73	3.68	9.88	3.62	9.67	3.57	9.32	3.49
1.6 + 1.6 + 1.6 + 6.0 + 6.0	16	12.04	3.68	11.13	3.56	10.76	3.51	10.34	3.39	9.65	3.19
	18	11.40	3.74	10.61	3.59	9.92	3.53	10.14	3.42	9.88	3.25
	20	10.75	3.76	10.21	3.61	9.99	3.55	9.96	3.47	9.91	3.34
	21	10.31	3.77	9.67	3.63	9.42	3.57	9.58	3.50	9.83	3.38
	22	10.07	3.79	9.92	3.64	9.86	3.59	9.80	3.52	9.71	3.42
	24	9.36	3.83	9.73	3.69	9.88	3.63	9.67	3.58	9.32	3.50
1.6 + 1.6 + 1.6 + 6.0 + 7.1	16	12.04	3.67	11.13	3.55	10.76	3.50	10.34	3.38	9.65	3.18
	18	11.40	3.73	10.61	3.58	9.92	3.52	10.14	3.42	9.88	3.24
	20	10.75	3.75	10.21	3.60	9.99	3.54	9.96	3.46	9.91	3.33
	21	10.31	3.76	9.67	3.62	9.42	3.56	9.58	3.49	9.83	3.37
	22	10.07	3.78	9.92	3.63	9.86	3.58	9.80	3.51	9.71	3.41
	24	9.36	3.82	9.73	3.68	9.88	3.62	9.67	3.57	9.32	3.49
1.6 + 1.6 + 2.0 + 2.0 + 2.0	16	12.04	3.69	11.13	3.57	10.76	3.52	10.34	3.40	9.65	3.20
	18	11.40	3.75	10.61	3.60	9.92	3.54	10.14	3.43	9.88	3.26
	20	10.75	3.77	10.21	3.62	9.99	3.56	9.96	3.48	9.91	3.35
	21	10.31	3.78	9.67	3.64	9.42	3.58	9.58	3.51	9.83	3.39
	22	10.07	3.80	9.92	3.65	9.86	3.60	9.80	3.53	9.71	3.43
	24	9.36	3.84	9.73	3.70	9.88	3.64	9.67	3.59	9.32	3.51

Combination (Capacity)	Indoor Air Temp. °C DB	Outdoor Air Temp. °C											
		16/15		15/14		10/9		7/6		6/5		2/1	
		Total Q	Input Power	Total Q	Input Power	Total Q	Input Power	Total Q	Input Power	Total Q	Input Power	Total Q	Input Power
1.6 + 1.6 + 2.0 + 2.0 + 2.5	16	20.14	2.83	19.73	2.90	17.66	3.26	16.41	3.48	15.61	3.53	12.40	3.74
	18	19.30	2.95	18.87	3.02	16.73	3.36	15.45	3.57	14.70	3.62	11.71	3.81
	20	19.01	3.03	18.51	3.10	16.00	3.44	14.50	3.64	13.79	3.68	10.96	3.83
	21	19.04	3.06	18.48	3.11	15.66	3.37	13.96	3.52	13.28	3.58	10.56	3.84
	22	19.20	3.08	18.67	3.15	16.03	3.50	14.45	3.71	13.58	3.74	10.13	3.86
	24	19.90	3.11	19.09	3.19	15.06	3.55	12.64	3.76	11.96	3.79	9.22	3.90
1.6 + 1.6 + 2.0 + 2.0 + 3.5	16	20.14	2.85	19.73	2.92	17.66	3.28	16.41	3.50	15.61	3.55	12.40	3.76
	18	19.30	2.97	18.87	3.04	16.73	3.38	15.45	3.59	14.70	3.64	11.71	3.83
	20	19.01	3.05	18.51	3.11	16.00	3.46	14.50	3.66	13.79	3.70	10.96	3.85
	21	19.04	3.08	18.48	3.13	15.66	3.39	13.96	3.54	13.28	3.60	10.56	3.86
	22	19.20	3.10	18.67	3.17	16.03	3.52	14.45	3.73	13.58	3.76	10.13	3.88
	24	19.90	3.13	19.09	3.20	15.06	3.57	12.64	3.78	11.96	3.81	9.22	3.92
1.6 + 1.6 + 2.0 + 2.0 + 4.2	16	20.14	2.84	19.73	2.91	17.66	3.27	16.41	3.49	15.61	3.54	12.40	3.75
	18	19.30	2.96	18.87	3.03	16.73	3.37	15.45	3.58	14.70	3.63	11.71	3.82
	20	19.01	3.04	18.51	3.11	16.00	3.45	14.50	3.65	13.79	3.69	10.96	3.84
	21	19.04	3.07	18.48	3.12	15.66	3.38	13.96	3.53	13.28	3.59	10.56	3.85
	22	19.20	3.09	18.67	3.16	16.03	3.51	14.45	3.72	13.58	3.75	10.13	3.87
	24	19.90	3.12	19.09	3.19	15.06	3.56	12.64	3.77	11.96	3.80	9.22	3.91
1.6 + 1.6 + 2.0 + 2.0 + 5.0	16	20.14	2.79	19.73	2.86	17.66	3.22	16.41	3.43	15.61	3.48	12.40	3.68
	18	19.30	2.91	18.87	2.98	16.73	3.32	15.45	3.52	14.70	3.57	11.71	3.76
	20	19.01	2.99	18.51	3.05	16.00	3.39	14.50	3.59	13.79	3.63	10.96	3.77
	21	19.04	3.02	18.48	3.07	15.66	3.32	13.96	3.47	13.28	3.54	10.56	3.79
	22	19.20	3.04	18.67	3.11	16.03	3.45	14.45	3.66	13.58	3.69	10.13	3.81
	24	19.90	3.07	19.09	3.14	15.06	3.50	12.64	3.71	11.96	3.74	9.22	3.84
1.6 + 1.6 + 2.0 + 2.0 + 6.0	16	20.14	2.79	19.73	2.86	17.66	3.22	16.41	3.43	15.61	3.48	12.40	3.68
	18	19.30	2.91	18.87	2.98	16.73	3.32	15.45	3.52	14.70	3.57	11.71	3.76
	20	19.01	2.99	18.51	3.05	16.00	3.39	14.50	3.59	13.79	3.63	10.96	3.77
	21	19.04	3.02	18.48	3.07	15.66	3.32	13.96	3.47	13.28	3.54	10.56	3.79
	22	19.20	3.04	18.67	3.11	16.03	3.45	14.45	3.66	13.58	3.69	10.13	3.81
	24	19.90	3.07	19.09	3.14	15.06	3.50	12.64	3.71	11.96	3.74	9.22	3.84
1.6 + 1.6 + 2.0 + 2.0 + 7.1	16	20.14	2.79	19.73	2.86	17.66	3.21	16.41	3.42	15.61	3.47	12.40	3.67
	18	19.30	2.90	18.87	2.97	16.73	3.31	15.45	3.51	14.70	3.56	11.71	3.75
	20	19.01	2.98	18.51	3.05	16.00	3.38	14.50	3.58	13.79	3.62	10.96	3.76
	21	19.04	3.01	18.48	3.06	15.66	3.31	13.96	3.46	13.28	3.53	10.56	3.78
	22	19.20	3.03	18.67	3.10	16.03	3.44	14.45	3.65	13.58	3.68	10.13	3.80
	24	19.90	3.06	19.09	3.13	15.06	3.49	12.64	3.70	11.96	3.73	9.22	3.83

Combination (Capacity)	Indoor Air Temp. °C DB	Outdoor Air Temp. °C									
		0/-1		-5/-6		-7/-8		-10/-11		-15/-	
		Total Q	Input Power	Total Q	Input Power	Total Q	Input Power	Total Q	Input Power	Total Q	Input Power
1.6 + 1.6 + 2.0 + 2.0 + 2.5	16	12.04	3.69	11.13	3.57	10.76	3.52	10.34	3.40	9.65	3.20
	18	11.40	3.75	10.61	3.60	9.92	3.54	10.14	3.43	9.88	3.26
	20	10.75	3.77	10.21	3.62	9.99	3.56	9.96	3.48	9.91	3.35
	21	10.31	3.78	9.67	3.64	9.42	3.58	9.58	3.51	9.83	3.39
	22	10.07	3.80	9.92	3.65	9.86	3.60	9.80	3.53	9.71	3.43
	24	9.36	3.84	9.73	3.70	9.88	3.64	9.67	3.59	9.32	3.51
1.6 + 1.6 + 2.0 + 2.0 + 3.5	16	12.04	3.71	11.13	3.59	10.76	3.54	10.34	3.42	9.65	3.21
	18	11.40	3.77	10.61	3.62	9.92	3.56	10.14	3.45	9.88	3.28
	20	10.75	3.79	10.21	3.64	9.99	3.58	9.96	3.50	9.91	3.37
	21	10.31	3.80	9.67	3.66	9.42	3.60	9.58	3.53	9.83	3.41
	22	10.07	3.82	9.92	3.67	9.86	3.61	9.80	3.55	9.71	3.45
	24	9.36	3.86	9.73	3.72	9.88	3.66	9.67	3.61	9.32	3.53
1.6 + 1.6 + 2.0 + 2.0 + 4.2	16	12.04	3.70	11.13	3.58	10.76	3.53	10.34	3.41	9.65	3.21
	18	11.40	3.76	10.61	3.61	9.92	3.55	10.14	3.44	9.88	3.27
	20	10.75	3.78	10.21	3.63	9.99	3.57	9.96	3.49	9.91	3.36
	21	10.31	3.79	9.67	3.65	9.42	3.59	9.58	3.52	9.83	3.40
	22	10.07	3.81	9.92	3.66	9.86	3.61	9.80	3.54	9.71	3.44
	24	9.36	3.85	9.73	3.71	9.88	3.65	9.67	3.60	9.32	3.52
1.6 + 1.6 + 2.0 + 2.0 + 5.0	16	12.04	3.64	11.13	3.52	10.76	3.47	10.34	3.35	9.65	3.15
	18	11.40	3.70	10.61	3.55	9.92	3.49	10.14	3.39	9.88	3.21
	20	10.75	3.71	10.21	3.57	9.99	3.51	9.96	3.43	9.91	3.30
	21	10.31	3.73	9.67	3.59	9.42	3.53	9.58	3.46	9.83	3.34
	22	10.07	3.75	9.92	3.60	9.86	3.55	9.80	3.48	9.71	3.38
	24	9.36	3.79	9.73	3.65	9.88	3.59	9.67	3.54	9.32	3.46
1.6 + 1.6 + 2.0 + 2.0 + 6.0	16	12.04	3.64	11.13	3.52	10.76	3.47	10.34	3.35	9.65	3.15
	18	11.40	3.70	10.61	3.55	9.92	3.49	10.14	3.39	9.88	3.21
	20	10.75	3.71	10.21	3.57	9.99	3.51	9.96	3.43	9.91	3.30
	21	10.31	3.73	9.67	3.59	9.42	3.53	9.58	3.46	9.83	3.34
	22	10.07	3.75	9.92	3.60	9.86	3.55	9.80	3.48	9.71	3.38
	24	9.36	3.79	9.73	3.65	9.88	3.59	9.67	3.54	9.32	3.46
1.6 + 1.6 + 2.0 + 2.0 + 7.1	16	12.04	3.63	11.13	3.51	10.76	3.46	10.34	3.34	9.65	3.14
	18	11.40	3.69	10.61	3.54	9.92	3.48	10.14	3.38	9.88	3.20
	20	10.75	3.70	10.21	3.56	9.99	3.50	9.96	3.42	9.91	3.29
	21	10.31	3.72	9.67	3.58	9.42	3.52	9.58	3.45	9.83	3.33
	22	10.07	3.74	9.92	3.59	9.86	3.54	9.80	3.47	9.71	3.37
	24	9.36	3.78	9.73	3.64	9.88	3.58	9.67	3.53	9.32	3.45

Combination (Capacity)	Indoor Air Temp. °C DB	Outdoor Air Temp. °C											
		16/15		15/14		10/9		7/6		6/5		2/1	
		Total Q	Input Power	Total Q	Input Power	Total Q	Input Power	Total Q	Input Power	Total Q	Input Power	Total Q	Input Power
1.6 + 1.6 + 2.0 + 2.5 + 2.5	16	20.14	2.83	19.73	2.90	17.66	3.26	16.41	3.48	15.61	3.53	12.40	3.74
	18	19.30	2.95	18.87	3.02	16.73	3.36	15.45	3.57	14.70	3.62	11.71	3.81
	20	19.01	3.03	18.51	3.10	16.00	3.44	14.50	3.64	13.79	3.68	10.96	3.83
	21	19.04	3.06	18.48	3.11	15.66	3.37	13.96	3.52	13.28	3.58	10.56	3.84
	22	19.20	3.08	18.67	3.15	16.03	3.50	14.45	3.71	13.58	3.74	10.13	3.86
	24	19.90	3.11	19.09	3.19	15.06	3.55	12.64	3.76	11.96	3.79	9.22	3.90
1.6 + 1.6 + 2.0 + 2.5 + 3.5	16	20.14	2.85	19.73	2.92	17.66	3.28	16.41	3.50	15.61	3.55	12.40	3.76
	18	19.30	2.97	18.87	3.04	16.73	3.38	15.45	3.59	14.70	3.64	11.71	3.83
	20	19.01	3.05	18.51	3.11	16.00	3.46	14.50	3.66	13.79	3.70	10.96	3.85
	21	19.04	3.08	18.48	3.13	15.66	3.39	13.96	3.54	13.28	3.60	10.56	3.86
	22	19.20	3.10	18.67	3.17	16.03	3.52	14.45	3.73	13.58	3.76	10.13	3.88
	24	19.90	3.13	19.09	3.20	15.06	3.57	12.64	3.78	11.96	3.81	9.22	3.92
1.6 + 1.6 + 2.0 + 2.5 + 4.2	16	20.14	2.84	19.73	2.91	17.66	3.27	16.41	3.49	15.61	3.54	12.40	3.75
	18	19.30	2.96	18.87	3.03	16.73	3.37	15.45	3.58	14.70	3.63	11.71	3.82
	20	19.01	3.04	18.51	3.11	16.00	3.45	14.50	3.65	13.79	3.69	10.96	3.84
	21	19.04	3.07	18.48	3.12	15.66	3.38	13.96	3.53	13.28	3.59	10.56	3.85
	22	19.20	3.09	18.67	3.16	16.03	3.51	14.45	3.72	13.58	3.75	10.13	3.87
	24	19.90	3.12	19.09	3.19	15.06	3.56	12.64	3.77	11.96	3.80	9.22	3.91
1.6 + 1.6 + 2.0 + 2.5 + 5.0	16	20.14	2.79	19.73	2.86	17.66	3.22	16.41	3.43	15.61	3.48	12.40	3.68
	18	19.30	2.91	18.87	2.98	16.73	3.32	15.45	3.52	14.70	3.57	11.71	3.76
	20	19.01	2.99	18.51	3.05	16.00	3.39	14.50	3.59	13.79	3.63	10.96	3.77
	21	19.04	3.02	18.48	3.07	15.66	3.32	13.96	3.47	13.28	3.54	10.56	3.79
	22	19.20	3.04	18.67	3.11	16.03	3.45	14.45	3.66	13.58	3.69	10.13	3.81
	24	19.90	3.07	19.09	3.14	15.06	3.50	12.64	3.71	11.96	3.74	9.22	3.84
1.6 + 1.6 + 2.0 + 2.5 + 6.0	16	20.14	2.79	19.73	2.86	17.66	3.22	16.41	3.43	15.61	3.48	12.40	3.68
	18	19.30	2.91	18.87	2.98	16.73	3.32	15.45	3.52	14.70	3.57	11.71	3.76
	20	19.01	2.99	18.51	3.05	16.00	3.39	14.50	3.59	13.79	3.63	10.96	3.77
	21	19.04	3.02	18.48	3.07	15.66	3.32	13.96	3.47	13.28	3.54	10.56	3.79
	22	19.20	3.04	18.67	3.11	16.03	3.45	14.45	3.66	13.58	3.69	10.13	3.81
	24	19.90	3.07	19.09	3.14	15.06	3.50	12.64	3.71	11.96	3.74	9.22	3.84
1.6 + 1.6 + 2.0 + 2.5 + 7.1	16	20.14	2.79	19.73	2.86	17.66	3.21	16.41	3.42	15.61	3.47	12.40	3.67
	18	19.30	2.90	18.87	2.97	16.73	3.31	15.45	3.51	14.70	3.56	11.71	3.75
	20	19.01	2.98	18.51	3.05	16.00	3.38	14.50	3.58	13.79	3.62	10.96	3.76
	21	19.04	3.01	18.48	3.06	15.66	3.31	13.96	3.46	13.28	3.53	10.56	3.78
	22	19.20	3.03	18.67	3.10	16.03	3.44	14.45	3.65	13.58	3.68	10.13	3.80
	24	19.90	3.06	19.09	3.13	15.06	3.49	12.64	3.70	11.96	3.73	9.22	3.83

Combination (Capacity)	Indoor Air Temp. °C DB	Outdoor Air Temp. °C									
		0/-1		-5/-6		-7/-8		-10/-11		-15/-	
		Total Q	Input Power	Total Q	Input Power	Total Q	Input Power	Total Q	Input Power	Total Q	Input Power
1.6 + 1.6 + 2.0 + 2.5 + 2.5	16	12.04	3.69	11.13	3.57	10.76	3.52	10.34	3.40	9.65	3.20
	18	11.40	3.75	10.61	3.60	9.92	3.54	10.14	3.43	9.88	3.26
	20	10.75	3.77	10.21	3.62	9.99	3.56	9.96	3.48	9.91	3.35
	21	10.31	3.78	9.67	3.64	9.42	3.58	9.58	3.51	9.83	3.39
	22	10.07	3.80	9.92	3.65	9.86	3.60	9.80	3.53	9.71	3.43
	24	9.36	3.84	9.73	3.70	9.88	3.64	9.67	3.59	9.32	3.51
1.6 + 1.6 + 2.0 + 2.5 + 3.5	16	12.04	3.71	11.13	3.59	10.76	3.54	10.34	3.42	9.65	3.21
	18	11.40	3.77	10.61	3.62	9.92	3.56	10.14	3.45	9.88	3.28
	20	10.75	3.79	10.21	3.64	9.99	3.58	9.96	3.50	9.91	3.37
	21	10.31	3.80	9.67	3.66	9.42	3.60	9.58	3.53	9.83	3.41
	22	10.07	3.82	9.92	3.67	9.86	3.61	9.80	3.55	9.71	3.45
	24	9.36	3.86	9.73	3.72	9.88	3.66	9.67	3.61	9.32	3.53
1.6 + 1.6 + 2.0 + 2.5 + 4.2	16	12.04	3.70	11.13	3.58	10.76	3.53	10.34	3.41	9.65	3.21
	18	11.40	3.76	10.61	3.61	9.92	3.55	10.14	3.44	9.88	3.27
	20	10.75	3.78	10.21	3.63	9.99	3.57	9.96	3.49	9.91	3.36
	21	10.31	3.79	9.67	3.65	9.42	3.59	9.58	3.52	9.83	3.40
	22	10.07	3.81	9.92	3.66	9.86	3.61	9.80	3.54	9.71	3.44
	24	9.36	3.85	9.73	3.71	9.88	3.65	9.67	3.60	9.32	3.52
1.6 + 1.6 + 2.0 + 2.5 + 5.0	16	12.04	3.64	11.13	3.52	10.76	3.47	10.34	3.35	9.65	3.15
	18	11.40	3.70	10.61	3.55	9.92	3.49	10.14	3.39	9.88	3.21
	20	10.75	3.71	10.21	3.57	9.99	3.51	9.96	3.43	9.91	3.30
	21	10.31	3.73	9.67	3.59	9.42	3.53	9.58	3.46	9.83	3.34
	22	10.07	3.75	9.92	3.60	9.86	3.55	9.80	3.48	9.71	3.38
	24	9.36	3.79	9.73	3.65	9.88	3.59	9.67	3.54	9.32	3.46
1.6 + 1.6 + 2.0 + 2.5 + 6.0	16	12.04	3.64	11.13	3.52	10.76	3.47	10.34	3.35	9.65	3.15
	18	11.40	3.70	10.61	3.55	9.92	3.49	10.14	3.39	9.88	3.21
	20	10.75	3.71	10.21	3.57	9.99	3.51	9.96	3.43	9.91	3.30
	21	10.31	3.73	9.67	3.59	9.42	3.53	9.58	3.46	9.83	3.34
	22	10.07	3.75	9.92	3.60	9.86	3.55	9.80	3.48	9.71	3.38
	24	9.36	3.79	9.73	3.65	9.88	3.59	9.67	3.54	9.32	3.46
1.6 + 1.6 + 2.0 + 2.5 + 7.1	16	12.04	3.63	11.13	3.51	10.76	3.46	10.34	3.34	9.65	3.14
	18	11.40	3.69	10.61	3.54	9.92	3.48	10.14	3.38	9.88	3.20
	20	10.75	3.70	10.21	3.56	9.99	3.50	9.96	3.42	9.91	3.29
	21	10.31	3.72	9.67	3.58	9.42	3.52	9.58	3.45	9.83	3.33
	22	10.07	3.74	9.92	3.59	9.86	3.54	9.80	3.47	9.71	3.37
	24	9.36	3.78	9.73	3.64	9.88	3.58	9.67	3.53	9.32	3.45

Combination (Capacity)	Indoor Air Temp. °C DB	Outdoor Air Temp. °C											
		16/15		15/14		10/9		7/6		6/5		2/1	
		Total Q	Input Power	Total Q	Input Power	Total Q	Input Power	Total Q	Input Power	Total Q	Input Power	Total Q	Input Power
1.6 + 1.6 + 2.0 + 3.5 + 3.5	16	20.14	2.82	19.73	2.90	17.66	3.25	16.41	3.47	15.61	3.52	12.40	3.73
	18	19.30	2.94	18.87	3.01	16.73	3.35	15.45	3.56	14.70	3.61	11.71	3.80
	20	19.01	3.02	18.51	3.09	16.00	3.43	14.50	3.63	13.79	3.67	10.96	3.81
	21	19.04	3.05	18.48	3.10	15.66	3.36	13.96	3.51	13.28	3.58	10.56	3.83
	22	19.20	3.08	18.67	3.15	16.03	3.49	14.45	3.70	13.58	3.73	10.13	3.85
	24	19.90	3.10	19.09	3.18	15.06	3.54	12.64	3.75	11.96	3.78	9.22	3.89
1.6 + 1.6 + 2.0 + 3.5 + 4.2	16	20.14	2.82	19.73	2.89	17.66	3.24	16.41	3.46	15.61	3.51	12.40	3.71
	18	19.30	2.93	18.87	3.00	16.73	3.34	15.45	3.55	14.70	3.60	11.71	3.79
	20	19.01	3.01	18.51	3.08	16.00	3.42	14.50	3.62	13.79	3.66	10.96	3.80
	21	19.04	3.05	18.48	3.10	15.66	3.35	13.96	3.50	13.28	3.57	10.56	3.82
	22	19.20	3.07	18.67	3.14	16.03	3.48	14.45	3.69	13.58	3.72	10.13	3.84
	24	19.90	3.10	19.09	3.17	15.06	3.53	12.64	3.74	11.96	3.77	9.22	3.88
1.6 + 1.6 + 2.0 + 3.5 + 5.0	16	20.14	2.82	19.73	2.89	17.66	3.24	16.41	3.46	15.61	3.51	12.40	3.71
	18	19.30	2.93	18.87	3.00	16.73	3.34	15.45	3.55	14.70	3.60	11.71	3.79
	20	19.01	3.01	18.51	3.08	16.00	3.42	14.50	3.62	13.79	3.66	10.96	3.80
	21	19.04	3.05	18.48	3.10	15.66	3.35	13.96	3.50	13.28	3.57	10.56	3.82
	22	19.20	3.07	18.67	3.14	16.03	3.48	14.45	3.69	13.58	3.72	10.13	3.84
	24	19.90	3.10	19.09	3.17	15.06	3.53	12.64	3.74	11.96	3.77	9.22	3.88
1.6 + 1.6 + 2.0 + 3.5 + 6.0	16	20.14	2.82	19.73	2.89	17.66	3.24	16.41	3.46	15.61	3.51	12.40	3.71
	18	19.30	2.93	18.87	3.00	16.73	3.34	15.45	3.55	14.70	3.60	11.71	3.79
	20	19.01	3.01	18.51	3.08	16.00	3.42	14.50	3.62	13.79	3.66	10.96	3.80
	21	19.04	3.05	18.48	3.10	15.66	3.35	13.96	3.50	13.28	3.57	10.56	3.82
	22	19.20	3.07	18.67	3.14	16.03	3.48	14.45	3.69	13.58	3.72	10.13	3.84
	24	19.90	3.10	19.09	3.17	15.06	3.53	12.64	3.74	11.96	3.77	9.22	3.88
1.6 + 1.6 + 2.0 + 3.5 + 7.1	16	20.14	2.81	19.73	2.88	17.66	3.24	16.41	3.45	15.61	3.50	12.40	3.70
	18	19.30	2.93	18.87	2.99	16.73	3.33	15.45	3.54	14.70	3.59	11.71	3.78
	20	19.01	3.00	18.51	3.07	16.00	3.41	14.50	3.61	13.79	3.65	10.96	3.79
	21	19.04	3.04	18.48	3.09	15.66	3.34	13.96	3.49	13.28	3.56	10.56	3.81
	22	19.20	3.06	18.67	3.13	16.03	3.47	14.45	3.68	13.58	3.71	10.13	3.83
	24	19.90	3.09	19.09	3.16	15.06	3.52	12.64	3.73	11.96	3.76	9.22	3.87
1.6 + 1.6 + 2.0 + 4.2 + 4.2	16	20.14	2.81	19.73	2.88	17.66	3.24	16.41	3.45	15.61	3.50	12.40	3.70
	18	19.30	2.93	18.87	2.99	16.73	3.33	15.45	3.54	14.70	3.59	11.71	3.78
	20	19.01	3.00	18.51	3.07	16.00	3.41	14.50	3.61	13.79	3.65	10.96	3.79
	21	19.04	3.04	18.48	3.09	15.66	3.34	13.96	3.49	13.28	3.56	10.56	3.81
	22	19.20	3.06	18.67	3.13	16.03	3.47	14.45	3.68	13.58	3.71	10.13	3.83
	24	19.90	3.09	19.09	3.16	15.06	3.52	12.64	3.73	11.96	3.76	9.22	3.87

Combination (Capacity)	Indoor Air Temp. °C DB	Outdoor Air Temp. °C									
		0/-1		-5/-6		-7/-8		-10/-11		-15/-	
		Total Q	Input Power	Total Q	Input Power	Total Q	Input Power	Total Q	Input Power	Total Q	Input Power
1.6 + 1.6 + 2.0 + 3.5 + 3.5	16	12.04	3.68	11.13	3.56	10.76	3.51	10.34	3.39	9.65	3.19
	18	11.40	3.74	10.61	3.59	9.92	3.53	10.14	3.42	9.88	3.25
	20	10.75	3.76	10.21	3.61	9.99	3.55	9.96	3.47	9.91	3.34
	21	10.31	3.77	9.67	3.63	9.42	3.57	9.58	3.50	9.83	3.38
	22	10.07	3.79	9.92	3.64	9.86	3.59	9.80	3.52	9.71	3.42
	24	9.36	3.83	9.73	3.69	9.88	3.63	9.67	3.58	9.32	3.50
1.6 + 1.6 + 2.0 + 3.5 + 4.2	16	12.04	3.67	11.13	3.55	10.76	3.50	10.34	3.38	9.65	3.18
	18	11.40	3.73	10.61	3.58	9.92	3.52	10.14	3.42	9.88	3.24
	20	10.75	3.75	10.21	3.60	9.99	3.54	9.96	3.46	9.91	3.33
	21	10.31	3.76	9.67	3.62	9.42	3.56	9.58	3.49	9.83	3.37
	22	10.07	3.78	9.92	3.63	9.86	3.58	9.80	3.51	9.71	3.41
	24	9.36	3.82	9.73	3.68	9.88	3.62	9.67	3.57	9.32	3.49
1.6 + 1.6 + 2.0 + 3.5 + 5.0	16	12.04	3.67	11.13	3.55	10.76	3.50	10.34	3.38	9.65	3.18
	18	11.40	3.73	10.61	3.58	9.92	3.52	10.14	3.42	9.88	3.24
	20	10.75	3.75	10.21	3.60	9.99	3.54	9.96	3.46	9.91	3.33
	21	10.31	3.76	9.67	3.62	9.42	3.56	9.58	3.49	9.83	3.37
	22	10.07	3.78	9.92	3.63	9.86	3.58	9.80	3.51	9.71	3.41
	24	9.36	3.82	9.73	3.68	9.88	3.62	9.67	3.57	9.32	3.49
1.6 + 1.6 + 2.0 + 3.5 + 6.0	16	12.04	3.67	11.13	3.55	10.76	3.50	10.34	3.38	9.65	3.18
	18	11.40	3.73	10.61	3.58	9.92	3.52	10.14	3.42	9.88	3.24
	20	10.75	3.75	10.21	3.60	9.99	3.54	9.96	3.46	9.91	3.33
	21	10.31	3.76	9.67	3.62	9.42	3.56	9.58	3.49	9.83	3.37
	22	10.07	3.78	9.92	3.63	9.86	3.58	9.80	3.51	9.71	3.41
	24	9.36	3.82	9.73	3.68	9.88	3.62	9.67	3.57	9.32	3.49
1.6 + 1.6 + 2.0 + 3.5 + 7.1	16	12.04	3.66	11.13	3.54	10.76	3.49	10.34	3.37	9.65	3.17
	18	11.40	3.72	10.61	3.57	9.92	3.51	10.14	3.41	9.88	3.23
	20	10.75	3.74	10.21	3.59	9.99	3.53	9.96	3.45	9.91	3.32
	21	10.31	3.75	9.67	3.61	9.42	3.55	9.58	3.48	9.83	3.36
	22	10.07	3.77	9.92	3.62	9.86	3.57	9.80	3.50	9.71	3.40
	24	9.36	3.81	9.73	3.67	9.88	3.61	9.67	3.56	9.32	3.48
1.6 + 1.6 + 2.0 + 4.2 + 4.2	16	12.04	3.66	11.13	3.54	10.76	3.49	10.34	3.37	9.65	3.17
	18	11.40	3.72	10.61	3.57	9.92	3.51	10.14	3.41	9.88	3.23
	20	10.75	3.74	10.21	3.59	9.99	3.53	9.96	3.45	9.91	3.32
	21	10.31	3.75	9.67	3.61	9.42	3.55	9.58	3.48	9.83	3.36
	22	10.07	3.77	9.92	3.62	9.86	3.57	9.80	3.50	9.71	3.40
	24	9.36	3.81	9.73	3.67	9.88	3.61	9.67	3.56	9.32	3.48

Combination (Capacity)	Indoor Air Temp. °C DB	Outdoor Air Temp. °C											
		16/15		15/14		10/9		7/6		6/5		2/1	
		Total Q	Input Power	Total Q	Input Power	Total Q	Input Power	Total Q	Input Power	Total Q	Input Power	Total Q	Input Power
1.6 + 1.6 + 2.0 + 4.2 + 5.0	16	20.14	2.81	19.73	2.88	17.66	3.24	16.41	3.45	15.61	3.50	12.40	3.70
	18	19.30	2.93	18.87	2.99	16.73	3.33	15.45	3.54	14.70	3.59	11.71	3.78
	20	19.01	3.00	18.51	3.07	16.00	3.41	14.50	3.61	13.79	3.65	10.96	3.79
	21	19.04	3.04	18.48	3.09	15.66	3.34	13.96	3.49	13.28	3.56	10.56	3.81
	22	19.20	3.06	18.67	3.13	16.03	3.47	14.45	3.68	13.58	3.71	10.13	3.83
	24	19.90	3.09	19.09	3.16	15.06	3.52	12.64	3.73	11.96	3.76	9.22	3.87
1.6 + 1.6 + 2.0 + 4.2 + 6.0	16	20.14	2.81	19.73	2.88	17.66	3.24	16.41	3.45	15.61	3.50	12.40	3.70
	18	19.30	2.93	18.87	2.99	16.73	3.33	15.45	3.54	14.70	3.59	11.71	3.78
	20	19.01	3.00	18.51	3.07	16.00	3.41	14.50	3.61	13.79	3.65	10.96	3.79
	21	19.04	3.04	18.48	3.09	15.66	3.34	13.96	3.49	13.28	3.56	10.56	3.81
	22	19.20	3.06	18.67	3.13	16.03	3.47	14.45	3.68	13.58	3.71	10.13	3.83
	24	19.90	3.09	19.09	3.16	15.06	3.52	12.64	3.73	11.96	3.76	9.22	3.87
1.6 + 1.6 + 2.0 + 4.2 + 7.1	16	20.14	2.80	19.73	2.87	17.66	3.23	16.41	3.44	15.61	3.49	12.40	3.69
	18	19.30	2.92	18.87	2.99	16.73	3.32	15.45	3.53	14.70	3.58	11.71	3.77
	20	19.01	3.00	18.51	3.06	16.00	3.40	14.50	3.60	13.79	3.64	10.96	3.78
	21	19.04	3.03	18.48	3.08	15.66	3.33	13.96	3.48	13.28	3.55	10.56	3.80
	22	19.20	3.05	18.67	3.12	16.03	3.46	14.45	3.67	13.58	3.70	10.13	3.82
	24	19.90	3.08	19.09	3.15	15.06	3.51	12.64	3.72	11.96	3.75	9.22	3.86
1.6 + 1.6 + 2.0 + 5.0 + 5.0	16	20.14	2.82	19.73	2.89	17.66	3.24	16.41	3.46	15.61	3.51	12.40	3.71
	18	19.30	2.93	18.87	3.00	16.73	3.34	15.45	3.55	14.70	3.60	11.71	3.79
	20	19.01	3.01	18.51	3.08	16.00	3.42	14.50	3.62	13.79	3.66	10.96	3.80
	21	19.04	3.05	18.48	3.10	15.66	3.35	13.96	3.50	13.28	3.57	10.56	3.82
	22	19.20	3.07	18.67	3.14	16.03	3.48	14.45	3.69	13.58	3.72	10.13	3.84
	24	19.90	3.10	19.09	3.17	15.06	3.53	12.64	3.74	11.96	3.77	9.22	3.88
1.6 + 1.6 + 2.0 + 5.0 + 6.0	16	20.14	2.82	19.73	2.89	17.66	3.24	16.41	3.46	15.61	3.51	12.40	3.71
	18	19.30	2.93	18.87	3.00	16.73	3.34	15.45	3.55	14.70	3.60	11.71	3.79
	20	19.01	3.01	18.51	3.08	16.00	3.42	14.50	3.62	13.79	3.66	10.96	3.80
	21	19.04	3.05	18.48	3.10	15.66	3.35	13.96	3.50	13.28	3.57	10.56	3.82
	22	19.20	3.07	18.67	3.14	16.03	3.48	14.45	3.69	13.58	3.72	10.13	3.84
	24	19.90	3.10	19.09	3.17	15.06	3.53	12.64	3.74	11.96	3.77	9.22	3.88
1.6 + 1.6 + 2.0 + 5.0 + 7.1	16	20.14	2.85	19.73	2.92	17.66	3.28	16.41	3.50	15.61	3.55	12.40	3.76
	18	19.30	2.97	18.87	3.04	16.73	3.38	15.45	3.59	14.70	3.64	11.71	3.83
	20	19.01	3.05	18.51	3.11	16.00	3.46	14.50	3.66	13.79	3.70	10.96	3.85
	21	19.04	3.08	18.48	3.13	15.66	3.39	13.96	3.54	13.28	3.60	10.56	3.86
	22	19.20	3.10	18.67	3.17	16.03	3.52	14.45	3.73	13.58	3.76	10.13	3.88
	24	19.90	3.13	19.09	3.20	15.06	3.57	12.64	3.78	11.96	3.81	9.22	3.92



Combination (Capacity)	Indoor Air Temp. °C DB	Outdoor Air Temp. °C									
		0/-1		-5/-6		-7/-8		-10/-11		-15/-	
		Total Q	Input Power	Total Q	Input Power	Total Q	Input Power	Total Q	Input Power	Total Q	Input Power
1.6 + 1.6 + 2.0 + 4.2 + 5.0	16	12.04	3.66	11.13	3.54	10.76	3.49	10.34	3.37	9.65	3.17
	18	11.40	3.72	10.61	3.57	9.92	3.51	10.14	3.41	9.88	3.23
	20	10.75	3.74	10.21	3.59	9.99	3.53	9.96	3.45	9.91	3.32
	21	10.31	3.75	9.67	3.61	9.42	3.55	9.58	3.48	9.83	3.36
	22	10.07	3.77	9.92	3.62	9.86	3.57	9.80	3.50	9.71	3.40
	24	9.36	3.81	9.73	3.67	9.88	3.61	9.67	3.56	9.32	3.48
1.6 + 1.6 + 2.0 + 4.2 + 6.0	16	12.04	3.66	11.13	3.54	10.76	3.49	10.34	3.37	9.65	3.17
	18	11.40	3.72	10.61	3.57	9.92	3.51	10.14	3.41	9.88	3.23
	20	10.75	3.74	10.21	3.59	9.99	3.53	9.96	3.45	9.91	3.32
	21	10.31	3.75	9.67	3.61	9.42	3.55	9.58	3.48	9.83	3.36
	22	10.07	3.77	9.92	3.62	9.86	3.57	9.80	3.50	9.71	3.40
	24	9.36	3.81	9.73	3.67	9.88	3.61	9.67	3.56	9.32	3.48
1.6 + 1.6 + 2.0 + 4.2 + 7.1	16	12.04	3.65	11.13	3.53	10.76	3.48	10.34	3.36	9.65	3.16
	18	11.40	3.71	10.61	3.56	9.92	3.50	10.14	3.40	9.88	3.22
	20	10.75	3.73	10.21	3.58	9.99	3.52	9.96	3.44	9.91	3.31
	21	10.31	3.74	9.67	3.60	9.42	3.54	9.58	3.47	9.83	3.35
	22	10.07	3.76	9.92	3.61	9.86	3.56	9.80	3.49	9.71	3.39
	24	9.36	3.80	9.73	3.66	9.88	3.60	9.67	3.55	9.32	3.47
1.6 + 1.6 + 2.0 + 5.0 + 5.0	16	12.04	3.67	11.13	3.55	10.76	3.50	10.34	3.38	9.65	3.18
	18	11.40	3.73	10.61	3.58	9.92	3.52	10.14	3.42	9.88	3.24
	20	10.75	3.75	10.21	3.60	9.99	3.54	9.96	3.46	9.91	3.33
	21	10.31	3.76	9.67	3.62	9.42	3.56	9.58	3.49	9.83	3.37
	22	10.07	3.78	9.92	3.63	9.86	3.58	9.80	3.51	9.71	3.41
	24	9.36	3.82	9.73	3.68	9.88	3.62	9.67	3.57	9.32	3.49
1.6 + 1.6 + 2.0 + 5.0 + 6.0	16	12.04	3.67	11.13	3.55	10.76	3.50	10.34	3.38	9.65	3.18
	18	11.40	3.73	10.61	3.58	9.92	3.52	10.14	3.42	9.88	3.24
	20	10.75	3.75	10.21	3.60	9.99	3.54	9.96	3.46	9.91	3.33
	21	10.31	3.76	9.67	3.62	9.42	3.56	9.58	3.49	9.83	3.37
	22	10.07	3.78	9.92	3.63	9.86	3.58	9.80	3.51	9.71	3.41
	24	9.36	3.82	9.73	3.68	9.88	3.62	9.67	3.57	9.32	3.49
1.6 + 1.6 + 2.0 + 5.0 + 7.1	16	12.04	3.71	11.13	3.59	10.76	3.54	10.34	3.42	9.65	3.21
	18	11.40	3.77	10.61	3.62	9.92	3.56	10.14	3.45	9.88	3.28
	20	10.75	3.79	10.21	3.64	9.99	3.58	9.96	3.50	9.91	3.37
	21	10.31	3.80	9.67	3.66	9.42	3.60	9.58	3.53	9.83	3.41
	22	10.07	3.82	9.92	3.67	9.86	3.61	9.80	3.55	9.71	3.45
	24	9.36	3.86	9.73	3.72	9.88	3.66	9.67	3.61	9.32	3.53

Combination (Capacity)	Indoor Air Temp. °C DB	Outdoor Air Temp. °C											
		16/15		15/14		10/9		7/6		6/5		2/1	
		Total Q	Input Power	Total Q	Input Power	Total Q	Input Power	Total Q	Input Power	Total Q	Input Power	Total Q	Input Power
1.6 + 1.6 + 2.0 + 6.0 + 6.0	16	20.14	2.82	19.73	2.89	17.66	3.24	16.41	3.46	15.61	3.51	12.40	3.71
	18	19.30	2.93	18.87	3.00	16.73	3.34	15.45	3.55	14.70	3.60	11.71	3.79
	20	19.01	3.01	18.51	3.08	16.00	3.42	14.50	3.62	13.79	3.66	10.96	3.80
	21	19.04	3.05	18.48	3.10	15.66	3.35	13.96	3.50	13.28	3.57	10.56	3.82
	22	19.20	3.07	18.67	3.14	16.03	3.48	14.45	3.69	13.58	3.72	10.13	3.84
	24	19.90	3.10	19.09	3.17	15.06	3.53	12.64	3.74	11.96	3.77	9.22	3.88
1.6 + 1.6 + 2.0 + 6.0 + 7.1	16	20.14	2.85	19.73	2.92	17.66	3.28	16.41	3.50	15.61	3.55	12.40	3.76
	18	19.30	2.97	18.87	3.04	16.73	3.38	15.45	3.59	14.70	3.64	11.71	3.83
	20	19.01	3.05	18.51	3.11	16.00	3.46	14.50	3.66	13.79	3.70	10.96	3.85
	21	19.04	3.08	18.48	3.13	15.66	3.39	13.96	3.54	13.28	3.60	10.56	3.86
	22	19.20	3.10	18.67	3.17	16.03	3.52	14.45	3.73	13.58	3.76	10.13	3.88
	24	19.90	3.13	19.09	3.20	15.06	3.57	12.64	3.78	11.96	3.81	9.22	3.92
1.6 + 1.6 + 2.5 + 2.5 + 2.5	16	20.14	2.83	19.73	2.90	17.66	3.26	16.41	3.48	15.61	3.53	12.40	3.74
	18	19.30	2.95	18.87	3.02	16.73	3.36	15.45	3.57	14.70	3.62	11.71	3.81
	20	19.01	3.03	18.51	3.10	16.00	3.44	14.50	3.64	13.79	3.68	10.96	3.83
	21	19.04	3.06	18.48	3.11	15.66	3.37	13.96	3.52	13.28	3.58	10.56	3.84
	22	19.20	3.08	18.67	3.15	16.03	3.50	14.45	3.71	13.58	3.74	10.13	3.86
	24	19.90	3.11	19.09	3.19	15.06	3.55	12.64	3.76	11.96	3.79	9.22	3.90
1.6 + 1.6 + 2.5 + 2.5 + 3.5	16	20.14	2.85	19.73	2.92	17.66	3.28	16.41	3.50	15.61	3.55	12.40	3.76
	18	19.30	2.97	18.87	3.04	16.73	3.38	15.45	3.59	14.70	3.64	11.71	3.83
	20	19.01	3.05	18.51	3.11	16.00	3.46	14.50	3.66	13.79	3.70	10.96	3.85
	21	19.04	3.08	18.48	3.13	15.66	3.39	13.96	3.54	13.28	3.60	10.56	3.86
	22	19.20	3.10	18.67	3.17	16.03	3.52	14.45	3.73	13.58	3.76	10.13	3.88
	24	19.90	3.13	19.09	3.20	15.06	3.57	12.64	3.78	11.96	3.81	9.22	3.92
1.6 + 1.6 + 2.5 + 2.5 + 4.2	16	20.14	2.84	19.73	2.91	17.66	3.27	16.41	3.49	15.61	3.54	12.40	3.75
	18	19.30	2.96	18.87	3.03	16.73	3.37	15.45	3.58	14.70	3.63	11.71	3.82
	20	19.01	3.04	18.51	3.11	16.00	3.45	14.50	3.65	13.79	3.69	10.96	3.84
	21	19.04	3.07	18.48	3.12	15.66	3.38	13.96	3.53	13.28	3.59	10.56	3.85
	22	19.20	3.09	18.67	3.16	16.03	3.51	14.45	3.72	13.58	3.75	10.13	3.87
	24	19.90	3.12	19.09	3.19	15.06	3.56	12.64	3.77	11.96	3.80	9.22	3.91
1.6 + 1.6 + 2.5 + 2.5 + 5.0	16	20.14	2.79	19.73	2.86	17.66	3.22	16.41	3.43	15.61	3.48	12.40	3.68
	18	19.30	2.91	18.87	2.98	16.73	3.32	15.45	3.52	14.70	3.57	11.71	3.76
	20	19.01	2.99	18.51	3.05	16.00	3.39	14.50	3.59	13.79	3.63	10.96	3.77
	21	19.04	3.02	18.48	3.07	15.66	3.32	13.96	3.47	13.28	3.54	10.56	3.79
	22	19.20	3.04	18.67	3.11	16.03	3.45	14.45	3.66	13.58	3.69	10.13	3.81
	24	19.90	3.07	19.09	3.14	15.06	3.50	12.64	3.71	11.96	3.74	9.22	3.84

Combination (Capacity)	Indoor Air Temp. °C DB	Outdoor Air Temp. °C									
		0/-1		-5/-6		-7/-8		-10/-11		-15/-	
		Total Q	Input Power	Total Q	Input Power	Total Q	Input Power	Total Q	Input Power	Total Q	Input Power
1.6 + 1.6 + 2.0 + 6.0 + 6.0	16	12.04	3.67	11.13	3.55	10.76	3.50	10.34	3.38	9.65	3.18
	18	11.40	3.73	10.61	3.58	9.92	3.52	10.14	3.42	9.88	3.24
	20	10.75	3.75	10.21	3.60	9.99	3.54	9.96	3.46	9.91	3.33
	21	10.31	3.76	9.67	3.62	9.42	3.56	9.58	3.49	9.83	3.37
	22	10.07	3.78	9.92	3.63	9.86	3.58	9.80	3.51	9.71	3.41
	24	9.36	3.82	9.73	3.68	9.88	3.62	9.67	3.57	9.32	3.49
1.6 + 1.6 + 2.0 + 6.0 + 7.1	16	12.04	3.71	11.13	3.59	10.76	3.54	10.34	3.42	9.65	3.21
	18	11.40	3.77	10.61	3.62	9.92	3.56	10.14	3.45	9.88	3.28
	20	10.75	3.79	10.21	3.64	9.99	3.58	9.96	3.50	9.91	3.37
	21	10.31	3.80	9.67	3.66	9.42	3.60	9.58	3.53	9.83	3.41
	22	10.07	3.82	9.92	3.67	9.86	3.61	9.80	3.55	9.71	3.45
	24	9.36	3.86	9.73	3.72	9.88	3.66	9.67	3.61	9.32	3.53
1.6 + 1.6 + 2.5 + 2.5 + 2.5	16	12.04	3.69	11.13	3.57	10.76	3.52	10.34	3.40	9.65	3.20
	18	11.40	3.75	10.61	3.60	9.92	3.54	10.14	3.43	9.88	3.26
	20	10.75	3.77	10.21	3.62	9.99	3.56	9.96	3.48	9.91	3.35
	21	10.31	3.78	9.67	3.64	9.42	3.58	9.58	3.51	9.83	3.39
	22	10.07	3.80	9.92	3.65	9.86	3.60	9.80	3.53	9.71	3.43
	24	9.36	3.84	9.73	3.70	9.88	3.64	9.67	3.59	9.32	3.51
1.6 + 1.6 + 2.5 + 2.5 + 3.5	16	12.04	3.71	11.13	3.59	10.76	3.54	10.34	3.42	9.65	3.21
	18	11.40	3.77	10.61	3.62	9.92	3.56	10.14	3.45	9.88	3.28
	20	10.75	3.79	10.21	3.64	9.99	3.58	9.96	3.50	9.91	3.37
	21	10.31	3.80	9.67	3.66	9.42	3.60	9.58	3.53	9.83	3.41
	22	10.07	3.82	9.92	3.67	9.86	3.61	9.80	3.55	9.71	3.45
	24	9.36	3.86	9.73	3.72	9.88	3.66	9.67	3.61	9.32	3.53
1.6 + 1.6 + 2.5 + 2.5 + 4.2	16	12.04	3.70	11.13	3.58	10.76	3.53	10.34	3.41	9.65	3.21
	18	11.40	3.76	10.61	3.61	9.92	3.55	10.14	3.44	9.88	3.27
	20	10.75	3.78	10.21	3.63	9.99	3.57	9.96	3.49	9.91	3.36
	21	10.31	3.79	9.67	3.65	9.42	3.59	9.58	3.52	9.83	3.40
	22	10.07	3.81	9.92	3.66	9.86	3.61	9.80	3.54	9.71	3.44
	24	9.36	3.85	9.73	3.71	9.88	3.65	9.67	3.60	9.32	3.52
1.6 + 1.6 + 2.5 + 2.5 + 5.0	16	12.04	3.64	11.13	3.52	10.76	3.47	10.34	3.35	9.65	3.15
	18	11.40	3.70	10.61	3.55	9.92	3.49	10.14	3.39	9.88	3.21
	20	10.75	3.71	10.21	3.57	9.99	3.51	9.96	3.43	9.91	3.30
	21	10.31	3.73	9.67	3.59	9.42	3.53	9.58	3.46	9.83	3.34
	22	10.07	3.75	9.92	3.60	9.86	3.55	9.80	3.48	9.71	3.38
	24	9.36	3.79	9.73	3.65	9.88	3.59	9.67	3.54	9.32	3.46

Combination (Capacity)	Indoor Air Temp. °C DB	Outdoor Air Temp. °C											
		16/15		15/14		10/9		7/6		6/5		2/1	
		Total Q	Input Power	Total Q	Input Power	Total Q	Input Power	Total Q	Input Power	Total Q	Input Power	Total Q	Input Power
1.6 + 1.6 + 2.5 + 2.5 + 6.0	16	20.14	2.79	19.73	2.86	17.66	3.22	16.41	3.43	15.61	3.48	12.40	3.68
	18	19.30	2.91	18.87	2.98	16.73	3.32	15.45	3.52	14.70	3.57	11.71	3.76
	20	19.01	2.99	18.51	3.05	16.00	3.39	14.50	3.59	13.79	3.63	10.96	3.77
	21	19.04	3.02	18.48	3.07	15.66	3.32	13.96	3.47	13.28	3.54	10.56	3.79
	22	19.20	3.04	18.67	3.11	16.03	3.45	14.45	3.66	13.58	3.69	10.13	3.81
	24	19.90	3.07	19.09	3.14	15.06	3.50	12.64	3.71	11.96	3.74	9.22	3.84
1.6 + 1.6 + 2.5 + 2.5 + 7.1	16	20.14	2.79	19.73	2.86	17.66	3.21	16.41	3.42	15.61	3.47	12.40	3.67
	18	19.30	2.90	18.87	2.97	16.73	3.31	15.45	3.51	14.70	3.56	11.71	3.75
	20	19.01	2.98	18.51	3.05	16.00	3.38	14.50	3.58	13.79	3.62	10.96	3.76
	21	19.04	3.01	18.48	3.06	15.66	3.31	13.96	3.46	13.28	3.53	10.56	3.78
	22	19.20	3.03	18.67	3.10	16.03	3.44	14.45	3.65	13.58	3.68	10.13	3.80
	24	19.90	3.06	19.09	3.13	15.06	3.49	12.64	3.70	11.96	3.73	9.22	3.83
1.6 + 1.6 + 2.5 + 3.5 + 3.5	16	20.14	2.82	19.73	2.90	17.66	3.25	16.41	3.47	15.61	3.52	12.40	3.73
	18	19.30	2.94	18.87	3.01	16.73	3.35	15.45	3.56	14.70	3.61	11.71	3.80
	20	19.01	3.02	18.51	3.09	16.00	3.43	14.50	3.63	13.79	3.67	10.96	3.81
	21	19.04	3.05	18.48	3.10	15.66	3.36	13.96	3.51	13.28	3.58	10.56	3.83
	22	19.20	3.08	18.67	3.15	16.03	3.49	14.45	3.70	13.58	3.73	10.13	3.85
	24	19.90	3.10	19.09	3.18	15.06	3.54	12.64	3.75	11.96	3.78	9.22	3.89
1.6 + 1.6 + 2.5 + 3.5 + 4.2	16	20.14	2.82	19.73	2.89	17.66	3.24	16.41	3.46	15.61	3.51	12.40	3.71
	18	19.30	2.93	18.87	3.00	16.73	3.34	15.45	3.55	14.70	3.60	11.71	3.79
	20	19.01	3.01	18.51	3.08	16.00	3.42	14.50	3.62	13.79	3.66	10.96	3.80
	21	19.04	3.05	18.48	3.10	15.66	3.35	13.96	3.50	13.28	3.57	10.56	3.82
	22	19.20	3.07	18.67	3.14	16.03	3.48	14.45	3.69	13.58	3.72	10.13	3.84
	24	19.90	3.10	19.09	3.17	15.06	3.53	12.64	3.74	11.96	3.77	9.22	3.88
1.6 + 1.6 + 2.5 + 3.5 + 5.0	16	20.14	2.82	19.73	2.89	17.66	3.24	16.41	3.46	15.61	3.51	12.40	3.71
	18	19.30	2.93	18.87	3.00	16.73	3.34	15.45	3.55	14.70	3.60	11.71	3.79
	20	19.01	3.01	18.51	3.08	16.00	3.42	14.50	3.62	13.79	3.66	10.96	3.80
	21	19.04	3.05	18.48	3.10	15.66	3.35	13.96	3.50	13.28	3.57	10.56	3.82
	22	19.20	3.07	18.67	3.14	16.03	3.48	14.45	3.69	13.58	3.72	10.13	3.84
	24	19.90	3.10	19.09	3.17	15.06	3.53	12.64	3.74	11.96	3.77	9.22	3.88
1.6 + 1.6 + 2.5 + 3.5 + 6.0	16	20.14	2.82	19.73	2.89	17.66	3.24	16.41	3.46	15.61	3.51	12.40	3.71
	18	19.30	2.93	18.87	3.00	16.73	3.34	15.45	3.55	14.70	3.60	11.71	3.79
	20	19.01	3.01	18.51	3.08	16.00	3.42	14.50	3.62	13.79	3.66	10.96	3.80
	21	19.04	3.05	18.48	3.10	15.66	3.35	13.96	3.50	13.28	3.57	10.56	3.82
	22	19.20	3.07	18.67	3.14	16.03	3.48	14.45	3.69	13.58	3.72	10.13	3.84
	24	19.90	3.10	19.09	3.17	15.06	3.53	12.64	3.74	11.96	3.77	9.22	3.88

Combination (Capacity)	Indoor Air Temp. °C DB	Outdoor Air Temp. °C									
		0/-1		-5/-6		-7/-8		-10/-11		-15/-	
		Total Q	Input Power	Total Q	Input Power	Total Q	Input Power	Total Q	Input Power	Total Q	Input Power
1.6 + 1.6 + 2.5 + 2.5 + 6.0	16	12.04	3.64	11.13	3.52	10.76	3.47	10.34	3.35	9.65	3.15
	18	11.40	3.70	10.61	3.55	9.92	3.49	10.14	3.39	9.88	3.21
	20	10.75	3.71	10.21	3.57	9.99	3.51	9.96	3.43	9.91	3.30
	21	10.31	3.73	9.67	3.59	9.42	3.53	9.58	3.46	9.83	3.34
	22	10.07	3.75	9.92	3.60	9.86	3.55	9.80	3.48	9.71	3.38
	24	9.36	3.79	9.73	3.65	9.88	3.59	9.67	3.54	9.32	3.46
1.6 + 1.6 + 1.6 + 5.0 + 7.1	16	12.04	3.63	11.13	3.51	10.76	3.46	10.34	3.34	9.65	3.14
	18	11.40	3.69	10.61	3.54	9.92	3.48	10.14	3.38	9.88	3.20
	20	10.75	3.70	10.21	3.56	9.99	3.50	9.96	3.42	9.91	3.29
	21	10.31	3.72	9.67	3.58	9.42	3.52	9.58	3.45	9.83	3.33
	22	10.07	3.74	9.92	3.59	9.86	3.54	9.80	3.47	9.71	3.37
	24	9.36	3.78	9.73	3.64	9.88	3.58	9.67	3.53	9.32	3.45
1.6 + 1.6 + 2.5 + 3.5 + 3.5	16	12.04	3.68	11.13	3.56	10.76	3.51	10.34	3.39	9.65	3.19
	18	11.40	3.74	10.61	3.59	9.92	3.53	10.14	3.42	9.88	3.25
	20	10.75	3.76	10.21	3.61	9.99	3.55	9.96	3.47	9.91	3.34
	21	10.31	3.77	9.67	3.63	9.42	3.57	9.58	3.50	9.83	3.38
	22	10.07	3.79	9.92	3.64	9.86	3.59	9.80	3.52	9.71	3.42
	24	9.36	3.83	9.73	3.69	9.88	3.63	9.67	3.58	9.32	3.50
1.6 + 1.6 + 2.5 + 3.5 + 4.2	16	12.04	3.67	11.13	3.55	10.76	3.50	10.34	3.38	9.65	3.18
	18	11.40	3.73	10.61	3.58	9.92	3.52	10.14	3.42	9.88	3.24
	20	10.75	3.75	10.21	3.60	9.99	3.54	9.96	3.46	9.91	3.33
	21	10.31	3.76	9.67	3.62	9.42	3.56	9.58	3.49	9.83	3.37
	22	10.07	3.78	9.92	3.63	9.86	3.58	9.80	3.51	9.71	3.41
	24	9.36	3.82	9.73	3.68	9.88	3.62	9.67	3.57	9.32	3.49
1.6 + 1.6 + 2.5 + 3.5 + 5.0	16	12.04	3.67	11.13	3.55	10.76	3.50	10.34	3.38	9.65	3.18
	18	11.40	3.73	10.61	3.58	9.92	3.52	10.14	3.42	9.88	3.24
	20	10.75	3.75	10.21	3.60	9.99	3.54	9.96	3.46	9.91	3.33
	21	10.31	3.76	9.67	3.62	9.42	3.56	9.58	3.49	9.83	3.37
	22	10.07	3.78	9.92	3.63	9.86	3.58	9.80	3.51	9.71	3.41
	24	9.36	3.82	9.73	3.68	9.88	3.62	9.67	3.57	9.32	3.49
1.6 + 1.6 + 2.5 + 3.5 + 6.0	16	12.04	3.67	11.13	3.55	10.76	3.50	10.34	3.38	9.65	3.18
	18	11.40	3.73	10.61	3.58	9.92	3.52	10.14	3.42	9.88	3.24
	20	10.75	3.75	10.21	3.60	9.99	3.54	9.96	3.46	9.91	3.33
	21	10.31	3.76	9.67	3.62	9.42	3.56	9.58	3.49	9.83	3.37
	22	10.07	3.78	9.92	3.63	9.86	3.58	9.80	3.51	9.71	3.41
	24	9.36	3.82	9.73	3.68	9.88	3.62	9.67	3.57	9.32	3.49

Combination (Capacity)	Indoor Air Temp. °C DB	Outdoor Air Temp. °C											
		16/15		15/14		10/9		7/6		6/5		2/1	
		Total Q	Input Power	Total Q	Input Power	Total Q	Input Power	Total Q	Input Power	Total Q	Input Power	Total Q	Input Power
1.6 + 1.6 + 2.5 + 3.5 + 7.1	16	20.14	2.81	19.73	2.88	17.66	3.24	16.41	3.45	15.61	3.50	12.40	3.70
	18	19.30	2.93	18.87	2.99	16.73	3.33	15.45	3.54	14.70	3.59	11.71	3.78
	20	19.01	3.00	18.51	3.07	16.00	3.41	14.50	3.61	13.79	3.65	10.96	3.79
	21	19.04	3.04	18.48	3.09	15.66	3.34	13.96	3.49	13.28	3.56	10.56	3.81
	22	19.20	3.06	18.67	3.13	16.03	3.47	14.45	3.68	13.58	3.71	10.13	3.83
	24	19.90	3.09	19.09	3.16	15.06	3.52	12.64	3.73	11.96	3.76	9.22	3.87
1.6 + 1.6 + 2.5 + 4.2 + 4.2	16	20.14	2.81	19.73	2.88	17.66	3.24	16.41	3.45	15.61	3.50	12.40	3.70
	18	19.30	2.93	18.87	2.99	16.73	3.33	15.45	3.54	14.70	3.59	11.71	3.78
	20	19.01	3.00	18.51	3.07	16.00	3.41	14.50	3.61	13.79	3.65	10.96	3.79
	21	19.04	3.04	18.48	3.09	15.66	3.34	13.96	3.49	13.28	3.56	10.56	3.81
	22	19.20	3.06	18.67	3.13	16.03	3.47	14.45	3.68	13.58	3.71	10.13	3.83
	24	19.90	3.09	19.09	3.16	15.06	3.52	12.64	3.73	11.96	3.76	9.22	3.87
1.6 + 1.6 + 2.5 + 4.2 + 5.0	16	20.14	2.81	19.73	2.88	17.66	3.24	16.41	3.45	15.61	3.50	12.40	3.70
	18	19.30	2.93	18.87	2.99	16.73	3.33	15.45	3.54	14.70	3.59	11.71	3.78
	20	19.01	3.00	18.51	3.07	16.00	3.41	14.50	3.61	13.79	3.65	10.96	3.79
	21	19.04	3.04	18.48	3.09	15.66	3.34	13.96	3.49	13.28	3.56	10.56	3.81
	22	19.20	3.06	18.67	3.13	16.03	3.47	14.45	3.68	13.58	3.71	10.13	3.83
	24	19.90	3.09	19.09	3.16	15.06	3.52	12.64	3.73	11.96	3.76	9.22	3.87
1.6 + 1.6 + 2.5 + 4.2 + 6.0	16	20.14	2.81	19.73	2.88	17.66	3.24	16.41	3.45	15.61	3.50	12.40	3.70
	18	19.30	2.93	18.87	2.99	16.73	3.33	15.45	3.54	14.70	3.59	11.71	3.78
	20	19.01	3.00	18.51	3.07	16.00	3.41	14.50	3.61	13.79	3.65	10.96	3.79
	21	19.04	3.04	18.48	3.09	15.66	3.34	13.96	3.49	13.28	3.56	10.56	3.81
	22	19.20	3.06	18.67	3.13	16.03	3.47	14.45	3.68	13.58	3.71	10.13	3.83
	24	19.90	3.09	19.09	3.16	15.06	3.52	12.64	3.73	11.96	3.76	9.22	3.87
1.6 + 1.6 + 2.5 + 4.2 + 7.1	16	20.14	2.80	19.73	2.87	17.66	3.23	16.41	3.44	15.61	3.49	12.40	3.69
	18	19.30	2.92	18.87	2.99	16.73	3.32	15.45	3.53	14.70	3.58	11.71	3.77
	20	19.01	3.00	18.51	3.06	16.00	3.40	14.50	3.60	13.79	3.64	10.96	3.78
	21	19.04	3.03	18.48	3.08	15.66	3.33	13.96	3.48	13.28	3.55	10.56	3.80
	22	19.20	3.05	18.67	3.12	16.03	3.46	14.45	3.67	13.58	3.70	10.13	3.82
	24	19.90	3.08	19.09	3.15	15.06	3.51	12.64	3.72	11.96	3.75	9.22	3.86
1.6 + 1.6 + 2.5 + 5.0 + 5.0	16	20.14	2.82	19.73	2.89	17.66	3.24	16.41	3.46	15.61	3.51	12.40	3.71
	18	19.30	2.93	18.87	3.00	16.73	3.34	15.45	3.55	14.70	3.60	11.71	3.79
	20	19.01	3.01	18.51	3.08	16.00	3.42	14.50	3.62	13.79	3.66	10.96	3.80
	21	19.04	3.05	18.48	3.10	15.66	3.35	13.96	3.50	13.28	3.57	10.56	3.82
	22	19.20	3.07	18.67	3.14	16.03	3.48	14.45	3.69	13.58	3.72	10.13	3.84
	24	19.90	3.10	19.09	3.17	15.06	3.53	12.64	3.74	11.96	3.77	9.22	3.88

Combination (Capacity)	Indoor Air Temp. °C DB	Outdoor Air Temp. °C									
		0/-1		-5/-6		-7/-8		-10/-11		-15/-	
		Total Q	Input Power	Total Q	Input Power	Total Q	Input Power	Total Q	Input Power	Total Q	Input Power
1.6 + 1.6 + 2.5 + 3.5 + 7.1	16	12.04	3.66	11.13	3.54	10.76	3.49	10.34	3.37	9.65	3.17
	18	11.40	3.72	10.61	3.57	9.92	3.51	10.14	3.41	9.88	3.23
	20	10.75	3.74	10.21	3.59	9.99	3.53	9.96	3.45	9.91	3.32
	21	10.31	3.75	9.67	3.61	9.42	3.55	9.58	3.48	9.83	3.36
	22	10.07	3.77	9.92	3.62	9.86	3.57	9.80	3.50	9.71	3.40
	24	9.36	3.81	9.73	3.67	9.88	3.61	9.67	3.56	9.32	3.48
1.6 + 1.6 + 2.5 + 4.2 + 4.2	16	12.04	3.66	11.13	3.54	10.76	3.49	10.34	3.37	9.65	3.17
	18	11.40	3.72	10.61	3.57	9.92	3.51	10.14	3.41	9.88	3.23
	20	10.75	3.74	10.21	3.59	9.99	3.53	9.96	3.45	9.91	3.32
	21	10.31	3.75	9.67	3.61	9.42	3.55	9.58	3.48	9.83	3.36
	22	10.07	3.77	9.92	3.62	9.86	3.57	9.80	3.50	9.71	3.40
	24	9.36	3.81	9.73	3.67	9.88	3.61	9.67	3.56	9.32	3.48
1.6 + 1.6 + 2.5 + 4.2 + 5.0	16	12.04	3.66	11.13	3.54	10.76	3.49	10.34	3.37	9.65	3.17
	18	11.40	3.72	10.61	3.57	9.92	3.51	10.14	3.41	9.88	3.23
	20	10.75	3.74	10.21	3.59	9.99	3.53	9.96	3.45	9.91	3.32
	21	10.31	3.75	9.67	3.61	9.42	3.55	9.58	3.48	9.83	3.36
	22	10.07	3.77	9.92	3.62	9.86	3.57	9.80	3.50	9.71	3.40
	24	9.36	3.81	9.73	3.67	9.88	3.61	9.67	3.56	9.32	3.48
1.6 + 1.6 + 2.5 + 4.2 + 6.0	16	12.04	3.66	11.13	3.54	10.76	3.49	10.34	3.37	9.65	3.17
	18	11.40	3.72	10.61	3.57	9.92	3.51	10.14	3.41	9.88	3.23
	20	10.75	3.74	10.21	3.59	9.99	3.53	9.96	3.45	9.91	3.32
	21	10.31	3.75	9.67	3.61	9.42	3.55	9.58	3.48	9.83	3.36
	22	10.07	3.77	9.92	3.62	9.86	3.57	9.80	3.50	9.71	3.40
	24	9.36	3.81	9.73	3.67	9.88	3.61	9.67	3.56	9.32	3.48
1.6 + 1.6 + 2.5 + 4.2 + 7.1	16	12.04	3.65	11.13	3.53	10.76	3.48	10.34	3.36	9.65	3.16
	18	11.40	3.71	10.61	3.56	9.92	3.50	10.14	3.40	9.88	3.22
	20	10.75	3.73	10.21	3.58	9.99	3.52	9.96	3.44	9.91	3.31
	21	10.31	3.74	9.67	3.60	9.42	3.54	9.58	3.47	9.83	3.35
	22	10.07	3.76	9.92	3.61	9.86	3.56	9.80	3.49	9.71	3.39
	24	9.36	3.80	9.73	3.66	9.88	3.60	9.67	3.55	9.32	3.47
1.6 + 1.6 + 2.5 + 5.0 + 5.0	16	12.04	3.67	11.13	3.55	10.76	3.50	10.34	3.38	9.65	3.18
	18	11.40	3.73	10.61	3.58	9.92	3.52	10.14	3.42	9.88	3.24
	20	10.75	3.75	10.21	3.60	9.99	3.54	9.96	3.46	9.91	3.33
	21	10.31	3.76	9.67	3.62	9.42	3.56	9.58	3.49	9.83	3.37
	22	10.07	3.78	9.92	3.63	9.86	3.58	9.80	3.51	9.71	3.41
	24	9.36	3.82	9.73	3.68	9.88	3.62	9.67	3.57	9.32	3.49

Combination (Capacity)	Indoor Air Temp. °C DB	Outdoor Air Temp. °C											
		16/15		15/14		10/9		7/6		6/5		2/1	
		Total Q	Input Power	Total Q	Input Power	Total Q	Input Power	Total Q	Input Power	Total Q	Input Power	Total Q	Input Power
1.6 + 1.6 + 2.5 + 5.0 + 6.0	16	20.14	2.82	19.73	2.89	17.66	3.24	16.41	3.46	15.61	3.51	12.40	3.71
	18	19.30	2.93	18.87	3.00	16.73	3.34	15.45	3.55	14.70	3.60	11.71	3.79
	20	19.01	3.01	18.51	3.08	16.00	3.42	14.50	3.62	13.79	3.66	10.96	3.80
	21	19.04	3.05	18.48	3.10	15.66	3.35	13.96	3.50	13.28	3.57	10.56	3.82
	22	19.20	3.07	18.67	3.14	16.03	3.48	14.45	3.69	13.58	3.72	10.13	3.84
	24	19.90	3.10	19.09	3.17	15.06	3.53	12.64	3.74	11.96	3.77	9.22	3.88
1.6 + 1.6 + 2.5 + 5.0 + 7.1	16	20.14	2.85	19.73	2.92	17.66	3.28	16.41	3.50	15.61	3.55	12.40	3.76
	18	19.30	2.97	18.87	3.04	16.73	3.38	15.45	3.59	14.70	3.64	11.71	3.83
	20	19.01	3.05	18.51	3.11	16.00	3.46	14.50	3.66	13.79	3.70	10.96	3.85
	21	19.04	3.08	18.48	3.13	15.66	3.39	13.96	3.54	13.28	3.60	10.56	3.86
	22	19.20	3.10	18.67	3.17	16.03	3.52	14.45	3.73	13.58	3.76	10.13	3.88
	24	19.90	3.13	19.09	3.20	15.06	3.57	12.64	3.78	11.96	3.81	9.22	3.92
1.6 + 1.6 + 2.5 + 6.0 + 6.0	16	20.14	2.82	19.73	2.89	17.66	3.24	16.41	3.46	15.61	3.51	12.40	3.71
	18	19.30	2.93	18.87	3.00	16.73	3.34	15.45	3.55	14.70	3.60	11.71	3.79
	20	19.01	3.01	18.51	3.08	16.00	3.42	14.50	3.62	13.79	3.66	10.96	3.80
	21	19.04	3.05	18.48	3.10	15.66	3.35	13.96	3.50	13.28	3.57	10.56	3.82
	22	19.20	3.07	18.67	3.14	16.03	3.48	14.45	3.69	13.58	3.72	10.13	3.84
	24	19.90	3.10	19.09	3.17	15.06	3.53	12.64	3.74	11.96	3.77	9.22	3.88
1.6 + 1.6 + 3.5 + 3.5 + 3.5	16	20.14	2.80	19.73	2.87	17.66	3.23	16.41	3.44	15.61	3.49	12.40	3.69
	18	19.30	2.92	18.87	2.99	16.73	3.32	15.45	3.53	14.70	3.58	11.71	3.77
	20	19.01	3.00	18.51	3.06	16.00	3.40	14.50	3.60	13.79	3.64	10.96	3.78
	21	19.04	3.03	18.48	3.08	15.66	3.33	13.96	3.48	13.28	3.55	10.56	3.80
	22	19.20	3.05	18.67	3.12	16.03	3.46	14.45	3.67	13.58	3.70	10.13	3.82
	24	19.90	3.08	19.09	3.15	15.06	3.51	12.64	3.72	11.96	3.75	9.22	3.86
1.6 + 1.6 + 3.5 + 3.5 + 4.2	16	20.14	2.79	19.73	2.86	17.66	3.22	16.41	3.43	15.61	3.48	12.40	3.68
	18	19.30	2.91	18.87	2.98	16.73	3.32	15.45	3.52	14.70	3.57	11.71	3.76
	20	19.01	2.99	18.51	3.05	16.00	3.39	14.50	3.59	13.79	3.63	10.96	3.77
	21	19.04	3.02	18.48	3.07	15.66	3.32	13.96	3.47	13.28	3.54	10.56	3.79
	22	19.20	3.04	18.67	3.11	16.03	3.45	14.45	3.66	13.58	3.69	10.13	3.81
	24	19.90	3.07	19.09	3.14	15.06	3.50	12.64	3.71	11.96	3.74	9.22	3.84
1.6 + 1.6 + 3.5 + 3.5 + 5.0	16	20.14	2.79	19.73	2.86	17.66	3.22	16.41	3.43	15.61	3.48	12.40	3.68
	18	19.30	2.91	18.87	2.98	16.73	3.32	15.45	3.52	14.70	3.57	11.71	3.76
	20	19.01	2.99	18.51	3.05	16.00	3.39	14.50	3.59	13.79	3.63	10.96	3.77
	21	19.04	3.02	18.48	3.07	15.66	3.32	13.96	3.47	13.28	3.54	10.56	3.79
	22	19.20	3.04	18.67	3.11	16.03	3.45	14.45	3.66	13.58	3.69	10.13	3.81
	24	19.90	3.07	19.09	3.14	15.06	3.50	12.64	3.71	11.96	3.74	9.22	3.84



Combination (Capacity)	Indoor Air Temp. °C DB	Outdoor Air Temp. °C									
		0/-1		-5/-6		-7/-8		-10/-11		-15/-	
		Total Q	Input Power	Total Q	Input Power	Total Q	Input Power	Total Q	Input Power	Total Q	Input Power
1.6 + 1.6 + 2.5 + 5.0 + 6.0	16	12.04	3.67	11.13	3.55	10.76	3.50	10.34	3.38	9.65	3.18
	18	11.40	3.73	10.61	3.58	9.92	3.52	10.14	3.42	9.88	3.24
	20	10.75	3.75	10.21	3.60	9.99	3.54	9.96	3.46	9.91	3.33
	21	10.31	3.76	9.67	3.62	9.42	3.56	9.58	3.49	9.83	3.37
	22	10.07	3.78	9.92	3.63	9.86	3.58	9.80	3.51	9.71	3.41
	24	9.36	3.82	9.73	3.68	9.88	3.62	9.67	3.57	9.32	3.49
1.6 + 1.6 + 2.5 + 5.0 + 7.1	16	12.04	3.71	11.13	3.59	10.76	3.54	10.34	3.42	9.65	3.21
	18	11.40	3.77	10.61	3.62	9.92	3.56	10.14	3.45	9.88	3.28
	20	10.75	3.79	10.21	3.64	9.99	3.58	9.96	3.50	9.91	3.37
	21	10.31	3.80	9.67	3.66	9.42	3.60	9.58	3.53	9.83	3.41
	22	10.07	3.82	9.92	3.67	9.86	3.61	9.80	3.55	9.71	3.45
	24	9.36	3.86	9.73	3.72	9.88	3.66	9.67	3.61	9.32	3.53
1.6 + 1.6 + 2.5 + 6.0 + 6.0	16	12.04	3.67	11.13	3.55	10.76	3.50	10.34	3.38	9.65	3.18
	18	11.40	3.73	10.61	3.58	9.92	3.52	10.14	3.42	9.88	3.24
	20	10.75	3.75	10.21	3.60	9.99	3.54	9.96	3.46	9.91	3.33
	21	10.31	3.76	9.67	3.62	9.42	3.56	9.58	3.49	9.83	3.37
	22	10.07	3.78	9.92	3.63	9.86	3.58	9.80	3.51	9.71	3.41
	24	9.36	3.82	9.73	3.68	9.88	3.62	9.67	3.57	9.32	3.49
1.6 + 1.6 + 3.5 + 3.5 + 3.5	16	12.04	3.65	11.13	3.53	10.76	3.48	10.34	3.36	9.65	3.16
	18	11.40	3.71	10.61	3.56	9.92	3.50	10.14	3.40	9.88	3.22
	20	10.75	3.73	10.21	3.58	9.99	3.52	9.96	3.44	9.91	3.31
	21	10.31	3.74	9.67	3.60	9.42	3.54	9.58	3.47	9.83	3.35
	22	10.07	3.76	9.92	3.61	9.86	3.56	9.80	3.49	9.71	3.39
	24	9.36	3.80	9.73	3.66	9.88	3.60	9.67	3.55	9.32	3.47
1.6 + 1.6 + 3.5 + 3.5 + 4.2	16	12.04	3.64	11.13	3.52	10.76	3.47	10.34	3.35	9.65	3.15
	18	11.40	3.70	10.61	3.55	9.92	3.49	10.14	3.39	9.88	3.21
	20	10.75	3.71	10.21	3.57	9.99	3.51	9.96	3.43	9.91	3.30
	21	10.31	3.73	9.67	3.59	9.42	3.53	9.58	3.46	9.83	3.34
	22	10.07	3.75	9.92	3.60	9.86	3.55	9.80	3.48	9.71	3.38
	24	9.36	3.79	9.73	3.65	9.88	3.59	9.67	3.54	9.32	3.46
1.6 + 1.6 + 3.5 + 3.5 + 5.0	16	12.04	3.64	11.13	3.52	10.76	3.47	10.34	3.35	9.65	3.15
	18	11.40	3.70	10.61	3.55	9.92	3.49	10.14	3.39	9.88	3.21
	20	10.75	3.71	10.21	3.57	9.99	3.51	9.96	3.43	9.91	3.30
	21	10.31	3.73	9.67	3.59	9.42	3.53	9.58	3.46	9.83	3.34
	22	10.07	3.75	9.92	3.60	9.86	3.55	9.80	3.48	9.71	3.38
	24	9.36	3.79	9.73	3.65	9.88	3.59	9.67	3.54	9.32	3.46

Combination (Capacity)	Indoor Air Temp. °C DB	Outdoor Air Temp. °C											
		16/15		15/14		10/9		7/6		6/5		2/1	
		Total Q	Input Power	Total Q	Input Power	Total Q	Input Power	Total Q	Input Power	Total Q	Input Power	Total Q	Input Power
1.6 + 1.6 + 3.5 + 3.5 + 6.0	16	20.14	2.79	19.73	2.86	17.66	3.22	16.41	3.43	15.61	3.48	12.40	3.68
	18	19.30	2.91	18.87	2.98	16.73	3.32	15.45	3.52	14.70	3.57	11.71	3.76
	20	19.01	2.99	18.51	3.05	16.00	3.39	14.50	3.59	13.79	3.63	10.96	3.77
	21	19.04	3.02	18.48	3.07	15.66	3.32	13.96	3.47	13.28	3.54	10.56	3.79
	22	19.20	3.04	18.67	3.11	16.03	3.45	14.45	3.66	13.58	3.69	10.13	3.81
	24	19.90	3.07	19.09	3.14	15.06	3.50	12.64	3.71	11.96	3.74	9.22	3.84
1.6 + 1.6 + 3.5 + 3.5 + 7.1	16	20.14	2.79	19.73	2.86	17.66	3.21	16.41	3.42	15.61	3.47	12.40	3.67
	18	19.30	2.90	18.87	2.97	16.73	3.31	15.45	3.51	14.70	3.56	11.71	3.75
	20	19.01	2.98	18.51	3.05	16.00	3.38	14.50	3.58	13.79	3.62	10.96	3.76
	21	19.04	3.01	18.48	3.06	15.66	3.31	13.96	3.46	13.28	3.53	10.56	3.78
	22	19.20	3.03	18.67	3.10	16.03	3.44	14.45	3.65	13.58	3.68	10.13	3.80
	24	19.90	3.06	19.09	3.13	15.06	3.49	12.64	3.70	11.96	3.73	9.22	3.83
1.6 + 1.6 + 3.5 + 4.2 + 4.2	16	20.14	2.83	19.73	2.90	17.66	3.26	16.41	3.48	15.61	3.53	12.40	3.74
	18	19.30	2.95	18.87	3.02	16.73	3.36	15.45	3.57	14.70	3.62	11.71	3.81
	20	19.01	3.03	18.51	3.10	16.00	3.44	14.50	3.64	13.79	3.68	10.96	3.83
	21	19.04	3.06	18.48	3.11	15.66	3.37	13.96	3.52	13.28	3.58	10.56	3.84
	22	19.20	3.08	18.67	3.15	16.03	3.50	14.45	3.71	13.58	3.74	10.13	3.86
	24	19.90	3.11	19.09	3.19	15.06	3.55	12.64	3.76	11.96	3.79	9.22	3.90
1.6 + 1.6 + 3.5 + 4.2 + 5.0	16	20.14	2.79	19.73	2.86	17.66	3.22	16.41	3.43	15.61	3.48	12.40	3.68
	18	19.30	2.91	18.87	2.98	16.73	3.32	15.45	3.52	14.70	3.57	11.71	3.76
	20	19.01	2.99	18.51	3.05	16.00	3.39	14.50	3.59	13.79	3.63	10.96	3.77
	21	19.04	3.02	18.48	3.07	15.66	3.32	13.96	3.47	13.28	3.54	10.56	3.79
	22	19.20	3.04	18.67	3.11	16.03	3.45	14.45	3.66	13.58	3.69	10.13	3.81
	24	19.90	3.07	19.09	3.14	15.06	3.50	12.64	3.71	11.96	3.74	9.22	3.84
1.6 + 1.6 + 3.5 + 4.2 + 6.0	16	20.14	2.79	19.73	2.86	17.66	3.22	16.41	3.43	15.61	3.48	12.40	3.68
	18	19.30	2.91	18.87	2.98	16.73	3.32	15.45	3.52	14.70	3.57	11.71	3.76
	20	19.01	2.99	18.51	3.05	16.00	3.39	14.50	3.59	13.79	3.63	10.96	3.77
	21	19.04	3.02	18.48	3.07	15.66	3.32	13.96	3.47	13.28	3.54	10.56	3.79
	22	19.20	3.04	18.67	3.11	16.03	3.45	14.45	3.66	13.58	3.69	10.13	3.81
	24	19.90	3.07	19.09	3.14	15.06	3.50	12.64	3.71	11.96	3.74	9.22	3.84
1.6 + 1.6 + 3.5 + 4.2 + 7.1	16	20.14	2.82	19.73	2.90	17.66	3.25	16.41	3.47	15.61	3.52	12.40	3.73
	18	19.30	2.94	18.87	3.01	16.73	3.35	15.45	3.56	14.70	3.61	11.71	3.80
	20	19.01	3.02	18.51	3.09	16.00	3.43	14.50	3.63	13.79	3.67	10.96	3.81
	21	19.04	3.05	18.48	3.10	15.66	3.36	13.96	3.51	13.28	3.58	10.56	3.83
	22	19.20	3.08	18.67	3.15	16.03	3.49	14.45	3.70	13.58	3.73	10.13	3.85
	24	19.90	3.10	19.09	3.18	15.06	3.54	12.64	3.75	11.96	3.78	9.22	3.89

Combination (Capacity)	Indoor Air Temp. °C DB	Outdoor Air Temp. °C									
		0/-1		-5/-6		-7/-8		-10/-11		-15/-	
		Total Q	Input Power	Total Q	Input Power	Total Q	Input Power	Total Q	Input Power	Total Q	Input Power
1.6 + 1.6 + 3.5 + 3.5 + 6.0	16	12.04	3.64	11.13	3.52	10.76	3.47	10.34	3.35	9.65	3.15
	18	11.40	3.70	10.61	3.55	9.92	3.49	10.14	3.39	9.88	3.21
	20	10.75	3.71	10.21	3.57	9.99	3.51	9.96	3.43	9.91	3.30
	21	10.31	3.73	9.67	3.59	9.42	3.53	9.58	3.46	9.83	3.34
	22	10.07	3.75	9.92	3.60	9.86	3.55	9.80	3.48	9.71	3.38
	24	9.36	3.79	9.73	3.65	9.88	3.59	9.67	3.54	9.32	3.46
1.6 + 1.6 + 3.5 + 3.5 + 7.1	16	12.04	3.63	11.13	3.51	10.76	3.46	10.34	3.34	9.65	3.14
	18	11.40	3.69	10.61	3.54	9.92	3.48	10.14	3.38	9.88	3.20
	20	10.75	3.70	10.21	3.56	9.99	3.50	9.96	3.42	9.91	3.29
	21	10.31	3.72	9.67	3.58	9.42	3.52	9.58	3.45	9.83	3.33
	22	10.07	3.74	9.92	3.59	9.86	3.54	9.80	3.47	9.71	3.37
	24	9.36	3.78	9.73	3.64	9.88	3.58	9.67	3.53	9.32	3.45
1.6 + 1.6 + 3.5 + 4.2 + 4.2	16	12.04	3.69	11.13	3.57	10.76	3.52	10.34	3.40	9.65	3.20
	18	11.40	3.75	10.61	3.60	9.92	3.54	10.14	3.43	9.88	3.26
	20	10.75	3.77	10.21	3.62	9.99	3.56	9.96	3.48	9.91	3.35
	21	10.31	3.78	9.67	3.64	9.42	3.58	9.58	3.51	9.83	3.39
	22	10.07	3.80	9.92	3.65	9.86	3.60	9.80	3.53	9.71	3.43
	24	9.36	3.84	9.73	3.70	9.88	3.64	9.67	3.59	9.32	3.51
1.6 + 1.6 + 3.5 + 4.2 + 5.0	16	12.04	3.64	11.13	3.52	10.76	3.47	10.34	3.35	9.65	3.15
	18	11.40	3.70	10.61	3.55	9.92	3.49	10.14	3.39	9.88	3.21
	20	10.75	3.71	10.21	3.57	9.99	3.51	9.96	3.43	9.91	3.30
	21	10.31	3.73	9.67	3.59	9.42	3.53	9.58	3.46	9.83	3.34
	22	10.07	3.75	9.92	3.60	9.86	3.55	9.80	3.48	9.71	3.38
	24	9.36	3.79	9.73	3.65	9.88	3.59	9.67	3.54	9.32	3.46
1.6 + 1.6 + 3.5 + 4.2 + 6.0	16	12.04	3.64	11.13	3.52	10.76	3.47	10.34	3.35	9.65	3.15
	18	11.40	3.70	10.61	3.55	9.92	3.49	10.14	3.39	9.88	3.21
	20	10.75	3.71	10.21	3.57	9.99	3.51	9.96	3.43	9.91	3.30
	21	10.31	3.73	9.67	3.59	9.42	3.53	9.58	3.46	9.83	3.34
	22	10.07	3.75	9.92	3.60	9.86	3.55	9.80	3.48	9.71	3.38
	24	9.36	3.79	9.73	3.65	9.88	3.59	9.67	3.54	9.32	3.46
1.6 + 1.6 + 3.5 + 4.2 + 7.1	16	12.04	3.68	11.13	3.56	10.76	3.51	10.34	3.39	9.65	3.19
	18	11.40	3.74	10.61	3.59	9.92	3.53	10.14	3.42	9.88	3.25
	20	10.75	3.76	10.21	3.61	9.99	3.55	9.96	3.47	9.91	3.34
	21	10.31	3.77	9.67	3.63	9.42	3.57	9.58	3.50	9.83	3.38
	22	10.07	3.79	9.92	3.64	9.86	3.59	9.80	3.52	9.71	3.42
	24	9.36	3.83	9.73	3.69	9.88	3.63	9.67	3.58	9.32	3.50

Combination (Capacity)	Indoor Air Temp. °C DB	Outdoor Air Temp. °C											
		16/15		15/14		10/9		7/6		6/5		2/1	
		Total Q	Input Power	Total Q	Input Power	Total Q	Input Power	Total Q	Input Power	Total Q	Input Power	Total Q	Input Power
1.6 + 1.6 + 3.5 + 5.0 + 5.0	16	20.14	2.84	19.73	2.91	17.66	3.27	16.41	3.49	15.61	3.54	12.40	3.75
	18	19.30	2.96	18.87	3.03	16.73	3.37	15.45	3.58	14.70	3.63	11.71	3.82
	20	19.01	3.04	18.51	3.11	16.00	3.45	14.50	3.65	13.79	3.69	10.96	3.84
	21	19.04	3.07	18.48	3.12	15.66	3.38	13.96	3.53	13.28	3.59	10.56	3.85
	22	19.20	3.09	18.67	3.16	16.03	3.51	14.45	3.72	13.58	3.75	10.13	3.87
	24	19.90	3.12	19.09	3.19	15.06	3.56	12.64	3.77	11.96	3.80	9.22	3.91
1.6 + 1.6 + 3.5 + 5.0 + 6.0	16	20.14	2.84	19.73	2.91	17.66	3.27	16.41	3.49	15.61	3.54	12.40	3.75
	18	19.30	2.96	18.87	3.03	16.73	3.37	15.45	3.58	14.70	3.63	11.71	3.82
	20	19.01	3.04	18.51	3.11	16.00	3.45	14.50	3.65	13.79	3.69	10.96	3.84
	21	19.04	3.07	18.48	3.12	15.66	3.38	13.96	3.53	13.28	3.59	10.56	3.85
	22	19.20	3.09	18.67	3.16	16.03	3.51	14.45	3.72	13.58	3.75	10.13	3.87
	24	19.90	3.12	19.09	3.19	15.06	3.56	12.64	3.77	11.96	3.80	9.22	3.91
1.6 + 1.6 + 4.2 + 4.2 + 4.2	16	20.14	2.82	19.73	2.90	17.66	3.25	16.41	3.47	15.61	3.52	12.40	3.73
	18	19.30	2.94	18.87	3.01	16.73	3.35	15.45	3.56	14.70	3.61	11.71	3.80
	20	19.01	3.02	18.51	3.09	16.00	3.43	14.50	3.63	13.79	3.67	10.96	3.81
	21	19.04	3.05	18.48	3.10	15.66	3.36	13.96	3.51	13.28	3.58	10.56	3.83
	22	19.20	3.08	18.67	3.15	16.03	3.49	14.45	3.70	13.58	3.73	10.13	3.85
	24	19.90	3.10	19.09	3.18	15.06	3.54	12.64	3.75	11.96	3.78	9.22	3.89
1.6 + 1.6 + 4.2 + 4.2 + 5.0	16	20.14	2.82	19.73	2.90	17.66	3.25	16.41	3.47	15.61	3.52	12.40	3.73
	18	19.30	2.94	18.87	3.01	16.73	3.35	15.45	3.56	14.70	3.61	11.71	3.80
	20	19.01	3.02	18.51	3.09	16.00	3.43	14.50	3.63	13.79	3.67	10.96	3.81
	21	19.04	3.05	18.48	3.10	15.66	3.36	13.96	3.51	13.28	3.58	10.56	3.83
	22	19.20	3.08	18.67	3.15	16.03	3.49	14.45	3.70	13.58	3.73	10.13	3.85
	24	19.90	3.10	19.09	3.18	15.06	3.54	12.64	3.75	11.96	3.78	9.22	3.89
1.6 + 1.6 + 4.2 + 4.2 + 6.0	16	20.14	2.82	19.73	2.90	17.66	3.25	16.41	3.47	15.61	3.52	12.40	3.73
	18	19.30	2.94	18.87	3.01	16.73	3.35	15.45	3.56	14.70	3.61	11.71	3.80
	20	19.01	3.02	18.51	3.09	16.00	3.43	14.50	3.63	13.79	3.67	10.96	3.81
	21	19.04	3.05	18.48	3.10	15.66	3.36	13.96	3.51	13.28	3.58	10.56	3.83
	22	19.20	3.08	18.67	3.15	16.03	3.49	14.45	3.70	13.58	3.73	10.13	3.85
	24	19.90	3.10	19.09	3.18	15.06	3.54	12.64	3.75	11.96	3.78	9.22	3.89
1.6 + 1.6 + 4.2 + 5.0 + 5.0	16	20.14	2.84	19.73	2.91	17.66	3.27	16.41	3.49	15.61	3.54	12.40	3.75
	18	19.30	2.96	18.87	3.03	16.73	3.37	15.45	3.58	14.70	3.63	11.71	3.82
	20	19.01	3.04	18.51	3.11	16.00	3.45	14.50	3.65	13.79	3.69	10.96	3.84
	21	19.04	3.07	18.48	3.12	15.66	3.38	13.96	3.53	13.28	3.59	10.56	3.85
	22	19.20	3.09	18.67	3.16	16.03	3.51	14.45	3.72	13.58	3.75	10.13	3.87
	24	19.90	3.12	19.09	3.19	15.06	3.56	12.64	3.77	11.96	3.80	9.22	3.91

Combination (Capacity)	Indoor Air Temp. °C DB	Outdoor Air Temp. °C									
		0/-1		-5/-6		-7/-8		-10/-11		-15/-	
		Total Q	Input Power	Total Q	Input Power	Total Q	Input Power	Total Q	Input Power	Total Q	Input Power
1.6 + 1.6 + 3.5 + 5.0 + 5.0	16	12.04	3.70	11.13	3.58	10.76	3.53	10.34	3.41	9.65	3.21
	18	11.40	3.76	10.61	3.61	9.92	3.55	10.14	3.44	9.88	3.27
	20	10.75	3.78	10.21	3.63	9.99	3.57	9.96	3.49	9.91	3.36
	21	10.31	3.79	9.67	3.65	9.42	3.59	9.58	3.52	9.83	3.40
	22	10.07	3.81	9.92	3.66	9.86	3.61	9.80	3.54	9.71	3.44
	24	9.36	3.85	9.73	3.71	9.88	3.65	9.67	3.60	9.32	3.52
1.6 + 1.6 + 3.5 + 5.0 + 6.0	16	12.04	3.70	11.13	3.58	10.76	3.53	10.34	3.41	9.65	3.21
	18	11.40	3.76	10.61	3.61	9.92	3.55	10.14	3.44	9.88	3.27
	20	10.75	3.78	10.21	3.63	9.99	3.57	9.96	3.49	9.91	3.36
	21	10.31	3.79	9.67	3.65	9.42	3.59	9.58	3.52	9.83	3.40
	22	10.07	3.81	9.92	3.66	9.86	3.61	9.80	3.54	9.71	3.44
	24	9.36	3.85	9.73	3.71	9.88	3.65	9.67	3.60	9.32	3.52
1.6 + 1.6 + 4.2 + 4.2 + 4.2	16	12.04	3.68	11.13	3.56	10.76	3.51	10.34	3.39	9.65	3.19
	18	11.40	3.74	10.61	3.59	9.92	3.53	10.14	3.42	9.88	3.25
	20	10.75	3.76	10.21	3.61	9.99	3.55	9.96	3.47	9.91	3.34
	21	10.31	3.77	9.67	3.63	9.42	3.57	9.58	3.50	9.83	3.38
	22	10.07	3.79	9.92	3.64	9.86	3.59	9.80	3.52	9.71	3.42
	24	9.36	3.83	9.73	3.69	9.88	3.63	9.67	3.58	9.32	3.50
1.6 + 1.6 + 4.2 + 4.2 + 5.0	16	12.04	3.68	11.13	3.56	10.76	3.51	10.34	3.39	9.65	3.19
	18	11.40	3.74	10.61	3.59	9.92	3.53	10.14	3.42	9.88	3.25
	20	10.75	3.76	10.21	3.61	9.99	3.55	9.96	3.47	9.91	3.34
	21	10.31	3.77	9.67	3.63	9.42	3.57	9.58	3.50	9.83	3.38
	22	10.07	3.79	9.92	3.64	9.86	3.59	9.80	3.52	9.71	3.42
	24	9.36	3.83	9.73	3.69	9.88	3.63	9.67	3.58	9.32	3.50
1.6 + 1.6 + 4.2 + 4.2 + 6.0	16	12.04	3.68	11.13	3.56	10.76	3.51	10.34	3.39	9.65	3.19
	18	11.40	3.74	10.61	3.59	9.92	3.53	10.14	3.42	9.88	3.25
	20	10.75	3.76	10.21	3.61	9.99	3.55	9.96	3.47	9.91	3.34
	21	10.31	3.77	9.67	3.63	9.42	3.57	9.58	3.50	9.83	3.38
	22	10.07	3.79	9.92	3.64	9.86	3.59	9.80	3.52	9.71	3.42
	24	9.36	3.83	9.73	3.69	9.88	3.63	9.67	3.58	9.32	3.50
1.6 + 1.6 + 4.2 + 5.0 + 5.0	16	12.04	3.70	11.13	3.58	10.76	3.53	10.34	3.41	9.65	3.21
	18	11.40	3.76	10.61	3.61	9.92	3.55	10.14	3.44	9.88	3.27
	20	10.75	3.78	10.21	3.63	9.99	3.57	9.96	3.49	9.91	3.36
	21	10.31	3.79	9.67	3.65	9.42	3.59	9.58	3.52	9.83	3.40
	22	10.07	3.81	9.92	3.66	9.86	3.61	9.80	3.54	9.71	3.44
	24	9.36	3.85	9.73	3.71	9.88	3.65	9.67	3.60	9.32	3.52

Combination (Capacity)	Indoor Air Temp. °C DB	Outdoor Air Temp. °C											
		16/15		15/14		10/9		7/6		6/5		2/1	
		Total Q	Input Power	Total Q	Input Power	Total Q	Input Power	Total Q	Input Power	Total Q	Input Power	Total Q	Input Power
1.6 + 1.6 + 5.0 + 5.0 + 5.0	16	20.14	2.90	19.73	2.98	17.66	3.34	16.41	3.56	15.61	3.62	12.40	3.83
	18	19.30	3.02	18.87	3.09	16.73	3.44	15.45	3.66	14.70	3.70	11.71	3.90
	20	19.01	3.10	18.51	3.17	16.00	3.52	14.50	3.73	13.79	3.77	10.96	3.92
	21	19.04	3.14	18.48	3.19	15.66	3.45	13.96	3.61	13.28	3.67	10.56	3.94
	22	19.20	3.16	18.67	3.23	16.03	3.59	14.45	3.80	13.58	3.83	10.13	3.95
	24	19.90	3.19	19.09	3.26	15.06	3.63	12.64	3.86	11.96	3.88	9.22	3.99
1.6 + 2.0 + 2.0 + 2.0 + 2.0	16	20.14	2.86	19.73	2.94	17.66	3.30	16.41	3.52	15.61	3.57	12.40	3.78
	18	19.30	2.98	18.87	3.05	16.73	3.40	15.45	3.61	14.70	3.66	11.71	3.85
	20	19.01	3.06	18.51	3.13	16.00	3.47	14.50	3.68	13.79	3.72	10.96	3.87
	21	19.04	3.10	18.48	3.15	15.66	3.40	13.96	3.56	13.28	3.62	10.56	3.88
	22	19.20	3.12	18.67	3.19	16.03	3.54	14.45	3.75	13.58	3.78	10.13	3.90
	24	19.90	3.15	19.09	3.22	15.06	3.59	12.64	3.80	11.96	3.83	9.22	3.94
1.6 + 2.0 + 2.0 + 2.0 + 2.5	16	20.14	2.86	19.73	2.94	17.66	3.30	16.41	3.52	15.61	3.57	12.40	3.78
	18	19.30	2.98	18.87	3.05	16.73	3.40	15.45	3.61	14.70	3.66	11.71	3.85
	20	19.01	3.06	18.51	3.13	16.00	3.47	14.50	3.68	13.79	3.72	10.96	3.87
	21	19.04	3.10	18.48	3.15	15.66	3.40	13.96	3.56	13.28	3.62	10.56	3.88
	22	19.20	3.12	18.67	3.19	16.03	3.54	14.45	3.75	13.58	3.78	10.13	3.90
	24	19.90	3.15	19.09	3.22	15.06	3.59	12.64	3.80	11.96	3.83	9.22	3.94
1.6 + 2.0 + 2.0 + 2.0 + 3.5	16	20.14	2.84	19.73	2.91	17.66	3.27	16.41	3.49	15.61	3.54	12.40	3.75
	18	19.30	2.96	18.87	3.03	16.73	3.37	15.45	3.58	14.70	3.63	11.71	3.82
	20	19.01	3.04	18.51	3.11	16.00	3.45	14.50	3.65	13.79	3.69	10.96	3.84
	21	19.04	3.07	18.48	3.12	15.66	3.38	13.96	3.53	13.28	3.59	10.56	3.85
	22	19.20	3.09	18.67	3.16	16.03	3.51	14.45	3.72	13.58	3.75	10.13	3.87
	24	19.90	3.12	19.09	3.19	15.06	3.56	12.64	3.77	11.96	3.80	9.22	3.91
1.6 + 2.0 + 2.0 + 2.0 + 4.2	16	20.14	2.83	19.73	2.90	17.66	3.26	16.41	3.48	15.61	3.53	12.40	3.74
	18	19.30	2.95	18.87	3.02	16.73	3.36	15.45	3.57	14.70	3.62	11.71	3.81
	20	19.01	3.03	18.51	3.10	16.00	3.44	14.50	3.64	13.79	3.68	10.96	3.83
	21	19.04	3.06	18.48	3.11	15.66	3.37	13.96	3.52	13.28	3.58	10.56	3.84
	22	19.20	3.08	18.67	3.15	16.03	3.50	14.45	3.71	13.58	3.74	10.13	3.86
	24	19.90	3.11	19.09	3.19	15.06	3.55	12.64	3.76	11.96	3.79	9.22	3.90
1.6 + 2.0 + 2.0 + 2.0 + 5.0	16	20.14	2.79	19.73	2.86	17.66	3.21	16.41	3.42	15.61	3.47	12.40	3.67
	18	19.30	2.90	18.87	2.97	16.73	3.31	15.45	3.51	14.70	3.56	11.71	3.75
	20	19.01	2.98	18.51	3.05	16.00	3.38	14.50	3.58	13.79	3.62	10.96	3.76
	21	19.04	3.01	18.48	3.06	15.66	3.31	13.96	3.46	13.28	3.53	10.56	3.78
	22	19.20	3.03	18.67	3.10	16.03	3.44	14.45	3.65	13.58	3.68	10.13	3.80
	24	19.90	3.06	19.09	3.13	15.06	3.49	12.64	3.70	11.96	3.73	9.22	3.83

Combination (Capacity)	Indoor Air Temp. °C DB	Outdoor Air Temp. °C									
		0/-1		-5/-6		-7/-8		-10/-11		-15/-	
		Total Q	Input Power	Total Q	Input Power	Total Q	Input Power	Total Q	Input Power	Total Q	Input Power
1.6 + 1.6 + 5.0 + 5.0 + 5.0	16	12.04	3.78	11.13	3.66	10.76	3.61	10.34	3.48	9.65	3.28
	18	11.40	3.84	10.61	3.69	9.92	3.63	10.14	3.52	9.88	3.34
	20	10.75	3.86	10.21	3.71	9.99	3.65	9.96	3.57	9.91	3.43
	21	10.31	3.88	9.67	3.73	9.42	3.67	9.58	3.59	9.83	3.47
	22	10.07	3.89	9.92	3.74	9.86	3.68	9.80	3.62	9.71	3.51
	24	9.36	3.94	9.73	3.79	9.88	3.73	9.67	3.68	9.32	3.60
1.6 + 2.0 + 2.0 + 2.0 + 2.0	16	12.04	3.73	11.13	3.61	10.76	3.56	10.34	3.44	9.65	3.23
	18	11.40	3.79	10.61	3.64	9.92	3.58	10.14	3.47	9.88	3.29
	20	10.75	3.81	10.21	3.66	9.99	3.60	9.96	3.52	9.91	3.39
	21	10.31	3.82	9.67	3.68	9.42	3.62	9.58	3.55	9.83	3.42
	22	10.07	3.84	9.92	3.69	9.86	3.63	9.80	3.57	9.71	3.46
	24	9.36	3.88	9.73	3.74	9.88	3.68	9.67	3.63	9.32	3.55
1.6 + 2.0 + 2.0 + 2.0 + 2.5	16	12.04	3.73	11.13	3.61	10.76	3.56	10.34	3.44	9.65	3.23
	18	11.40	3.79	10.61	3.64	9.92	3.58	10.14	3.47	9.88	3.29
	20	10.75	3.81	10.21	3.66	9.99	3.60	9.96	3.52	9.91	3.39
	21	10.31	3.82	9.67	3.68	9.42	3.62	9.58	3.55	9.83	3.42
	22	10.07	3.84	9.92	3.69	9.86	3.63	9.80	3.57	9.71	3.46
	24	9.36	3.88	9.73	3.74	9.88	3.68	9.67	3.63	9.32	3.55
1.6 + 2.0 + 2.0 + 2.0 + 3.5	16	12.04	3.70	11.13	3.58	10.76	3.53	10.34	3.41	9.65	3.21
	18	11.40	3.76	10.61	3.61	9.92	3.55	10.14	3.44	9.88	3.27
	20	10.75	3.78	10.21	3.63	9.99	3.57	9.96	3.49	9.91	3.36
	21	10.31	3.79	9.67	3.65	9.42	3.59	9.58	3.52	9.83	3.40
	22	10.07	3.81	9.92	3.66	9.86	3.61	9.80	3.54	9.71	3.44
	24	9.36	3.85	9.73	3.71	9.88	3.65	9.67	3.60	9.32	3.52
1.6 + 2.0 + 2.0 + 2.0 + 4.2	16	12.04	3.69	11.13	3.57	10.76	3.52	10.34	3.40	9.65	3.20
	18	11.40	3.75	10.61	3.60	9.92	3.54	10.14	3.43	9.88	3.26
	20	10.75	3.77	10.21	3.62	9.99	3.56	9.96	3.48	9.91	3.35
	21	10.31	3.78	9.67	3.64	9.42	3.58	9.58	3.51	9.83	3.39
	22	10.07	3.80	9.92	3.65	9.86	3.60	9.80	3.53	9.71	3.43
	24	9.36	3.84	9.73	3.70	9.88	3.64	9.67	3.59	9.32	3.51
1.6 + 2.0 + 2.0 + 2.0 + 5.0	16	12.04	3.63	11.13	3.51	10.76	3.46	10.34	3.34	9.65	3.14
	18	11.40	3.69	10.61	3.54	9.92	3.48	10.14	3.38	9.88	3.20
	20	10.75	3.70	10.21	3.56	9.99	3.50	9.96	3.42	9.91	3.29
	21	10.31	3.72	9.67	3.58	9.42	3.52	9.58	3.45	9.83	3.33
	22	10.07	3.74	9.92	3.59	9.86	3.54	9.80	3.47	9.71	3.37
	24	9.36	3.78	9.73	3.64	9.88	3.58	9.67	3.53	9.32	3.45

Combination (Capacity)	Indoor Air Temp. °C DB	Outdoor Air Temp. °C											
		16/15		15/14		10/9		7/6		6/5		2/1	
		Total Q	Input Power	Total Q	Input Power	Total Q	Input Power	Total Q	Input Power	Total Q	Input Power	Total Q	Input Power
1.6 + 2.0 + 2.0 + 2.0 + 6.0	16	20.14	2.79	19.73	2.86	17.66	3.21	16.41	3.42	15.61	3.47	12.40	3.67
	18	19.30	2.90	18.87	2.97	16.73	3.31	15.45	3.51	14.70	3.56	11.71	3.75
	20	19.01	2.98	18.51	3.05	16.00	3.38	14.50	3.58	13.79	3.62	10.96	3.76
	21	19.04	3.01	18.48	3.06	15.66	3.31	13.96	3.46	13.28	3.53	10.56	3.78
	22	19.20	3.03	18.67	3.10	16.03	3.44	14.45	3.65	13.58	3.68	10.13	3.80
	24	19.90	3.06	19.09	3.13	15.06	3.49	12.64	3.70	11.96	3.73	9.22	3.83
1.6 + 2.0 + 2.0 + 2.0 + 7.1	16	20.14	2.82	19.73	2.89	17.66	3.24	16.41	3.46	15.61	3.51	12.40	3.71
	18	19.30	2.93	18.87	3.00	16.73	3.34	15.45	3.55	14.70	3.60	11.71	3.79
	20	19.01	3.01	18.51	3.08	16.00	3.42	14.50	3.62	13.79	3.66	10.96	3.80
	21	19.04	3.05	18.48	3.10	15.66	3.35	13.96	3.50	13.28	3.57	10.56	3.82
	22	19.20	3.07	18.67	3.14	16.03	3.48	14.45	3.69	13.58	3.72	10.13	3.84
	24	19.90	3.10	19.09	3.17	15.06	3.53	12.64	3.74	11.96	3.77	9.22	3.88
1.6 + 2.0 + 2.0 + 2.5 + 2.5	16	20.14	2.86	19.73	2.94	17.66	3.30	16.41	3.52	15.61	3.57	12.40	3.78
	18	19.30	2.98	18.87	3.05	16.73	3.40	15.45	3.61	14.70	3.66	11.71	3.85
	20	19.01	3.06	18.51	3.13	16.00	3.47	14.50	3.68	13.79	3.72	10.96	3.87
	21	19.04	3.10	18.48	3.15	15.66	3.40	13.96	3.56	13.28	3.62	10.56	3.88
	22	19.20	3.12	18.67	3.19	16.03	3.54	14.45	3.75	13.58	3.78	10.13	3.90
	24	19.90	3.15	19.09	3.22	15.06	3.59	12.64	3.80	11.96	3.83	9.22	3.94
1.6 + 2.0 + 2.0 + 2.5 + 3.5	16	20.14	2.84	19.73	2.91	17.66	3.27	16.41	3.49	15.61	3.54	12.40	3.75
	18	19.30	2.96	18.87	3.03	16.73	3.37	15.45	3.58	14.70	3.63	11.71	3.82
	20	19.01	3.04	18.51	3.11	16.00	3.45	14.50	3.65	13.79	3.69	10.96	3.84
	21	19.04	3.07	18.48	3.12	15.66	3.38	13.96	3.53	13.28	3.59	10.56	3.85
	22	19.20	3.09	18.67	3.16	16.03	3.51	14.45	3.72	13.58	3.75	10.13	3.87
	24	19.90	3.12	19.09	3.19	15.06	3.56	12.64	3.77	11.96	3.80	9.22	3.91
1.6 + 2.0 + 2.0 + 2.5 + 4.2	16	20.14	2.83	19.73	2.90	17.66	3.26	16.41	3.48	15.61	3.53	12.40	3.74
	18	19.30	2.95	18.87	3.02	16.73	3.36	15.45	3.57	14.70	3.62	11.71	3.81
	20	19.01	3.03	18.51	3.10	16.00	3.44	14.50	3.64	13.79	3.68	10.96	3.83
	21	19.04	3.06	18.48	3.11	15.66	3.37	13.96	3.52	13.28	3.58	10.56	3.84
	22	19.20	3.08	18.67	3.15	16.03	3.50	14.45	3.71	13.58	3.74	10.13	3.86
	24	19.90	3.11	19.09	3.19	15.06	3.55	12.64	3.76	11.96	3.79	9.22	3.90
1.6 + 2.0 + 2.0 + 2.5 + 5.0	16	20.14	2.79	19.73	2.86	17.66	3.21	16.41	3.42	15.61	3.47	12.40	3.67
	18	19.30	2.90	18.87	2.97	16.73	3.31	15.45	3.51	14.70	3.56	11.71	3.75
	20	19.01	2.98	18.51	3.05	16.00	3.38	14.50	3.58	13.79	3.62	10.96	3.76
	21	19.04	3.01	18.48	3.06	15.66	3.31	13.96	3.46	13.28	3.53	10.56	3.78
	22	19.20	3.03	18.67	3.10	16.03	3.44	14.45	3.65	13.58	3.68	10.13	3.80
	24	19.90	3.06	19.09	3.13	15.06	3.49	12.64	3.70	11.96	3.73	9.22	3.83



Combination (Capacity)	Indoor Air Temp. °C DB	Outdoor Air Temp. °C									
		0/-1		-5/-6		-7/-8		-10/-11		-15/-	
		Total Q	Input Power	Total Q	Input Power	Total Q	Input Power	Total Q	Input Power	Total Q	Input Power
1.6 + 2.0 + 2.0 + 2.0 + 6.0	16	12.04	3.63	11.13	3.51	10.76	3.46	10.34	3.34	9.65	3.14
	18	11.40	3.69	10.61	3.54	9.92	3.48	10.14	3.38	9.88	3.20
	20	10.75	3.70	10.21	3.56	9.99	3.50	9.96	3.42	9.91	3.29
	21	10.31	3.72	9.67	3.58	9.42	3.52	9.58	3.45	9.83	3.33
	22	10.07	3.74	9.92	3.59	9.86	3.54	9.80	3.47	9.71	3.37
	24	9.36	3.78	9.73	3.64	9.88	3.58	9.67	3.53	9.32	3.45
1.6 + 2.0 + 2.0 + 2.0 + 7.1	16	12.04	3.67	11.13	3.55	10.76	3.50	10.34	3.38	9.65	3.18
	18	11.40	3.73	10.61	3.58	9.92	3.52	10.14	3.42	9.88	3.24
	20	10.75	3.75	10.21	3.60	9.99	3.54	9.96	3.46	9.91	3.33
	21	10.31	3.76	9.67	3.62	9.42	3.56	9.58	3.49	9.83	3.37
	22	10.07	3.78	9.92	3.63	9.86	3.58	9.80	3.51	9.71	3.41
	24	9.36	3.82	9.73	3.68	9.88	3.62	9.67	3.57	9.32	3.49
1.6 + 2.0 + 2.0 + 2.5 + 2.5	16	12.04	3.73	11.13	3.61	10.76	3.56	10.34	3.44	9.65	3.23
	18	11.40	3.79	10.61	3.64	9.92	3.58	10.14	3.47	9.88	3.29
	20	10.75	3.81	10.21	3.66	9.99	3.60	9.96	3.52	9.91	3.39
	21	10.31	3.82	9.67	3.68	9.42	3.62	9.58	3.55	9.83	3.42
	22	10.07	3.84	9.92	3.69	9.86	3.63	9.80	3.57	9.71	3.46
	24	9.36	3.88	9.73	3.74	9.88	3.68	9.67	3.63	9.32	3.55
1.6 + 2.0 + 2.0 + 2.5 + 3.5	16	12.04	3.70	11.13	3.58	10.76	3.53	10.34	3.41	9.65	3.21
	18	11.40	3.76	10.61	3.61	9.92	3.55	10.14	3.44	9.88	3.27
	20	10.75	3.78	10.21	3.63	9.99	3.57	9.96	3.49	9.91	3.36
	21	10.31	3.79	9.67	3.65	9.42	3.59	9.58	3.52	9.83	3.40
	22	10.07	3.81	9.92	3.66	9.86	3.61	9.80	3.54	9.71	3.44
	24	9.36	3.85	9.73	3.71	9.88	3.65	9.67	3.60	9.32	3.52
1.6 + 2.0 + 2.0 + 2.5 + 4.2	16	12.04	3.69	11.13	3.57	10.76	3.52	10.34	3.40	9.65	3.20
	18	11.40	3.75	10.61	3.60	9.92	3.54	10.14	3.43	9.88	3.26
	20	10.75	3.77	10.21	3.62	9.99	3.56	9.96	3.48	9.91	3.35
	21	10.31	3.78	9.67	3.64	9.42	3.58	9.58	3.51	9.83	3.39
	22	10.07	3.80	9.92	3.65	9.86	3.60	9.80	3.53	9.71	3.43
	24	9.36	3.84	9.73	3.70	9.88	3.64	9.67	3.59	9.32	3.51
1.6 + 2.0 + 2.0 + 2.5 + 5.0	16	12.04	3.63	11.13	3.51	10.76	3.46	10.34	3.34	9.65	3.14
	18	11.40	3.69	10.61	3.54	9.92	3.48	10.14	3.38	9.88	3.20
	20	10.75	3.70	10.21	3.56	9.99	3.50	9.96	3.42	9.91	3.29
	21	10.31	3.72	9.67	3.58	9.42	3.52	9.58	3.45	9.83	3.33
	22	10.07	3.74	9.92	3.59	9.86	3.54	9.80	3.47	9.71	3.37
	24	9.36	3.78	9.73	3.64	9.88	3.58	9.67	3.53	9.32	3.45

Combination (Capacity)	Indoor Air Temp. °C DB	Outdoor Air Temp. °C											
		16/15		15/14		10/9		7/6		6/5		2/1	
		Total Q	Input Power	Total Q	Input Power	Total Q	Input Power	Total Q	Input Power	Total Q	Input Power	Total Q	Input Power
1.6 + 2.0 + 2.0 + 2.5 + 6.0	16	20.14	2.79	19.73	2.86	17.66	3.21	16.41	3.42	15.61	3.47	12.40	3.67
	18	19.30	2.90	18.87	2.97	16.73	3.31	15.45	3.51	14.70	3.56	11.71	3.75
	20	19.01	2.98	18.51	3.05	16.00	3.38	14.50	3.58	13.79	3.62	10.96	3.76
	21	19.04	3.01	18.48	3.06	15.66	3.31	13.96	3.46	13.28	3.53	10.56	3.78
	22	19.20	3.03	18.67	3.10	16.03	3.44	14.45	3.65	13.58	3.68	10.13	3.80
	24	19.90	3.06	19.09	3.13	15.06	3.49	12.64	3.70	11.96	3.73	9.22	3.83
1.6 + 2.0 + 2.0 + 2.5 + 7.1	16	20.14	2.82	19.73	2.89	17.66	3.24	16.41	3.46	15.61	3.51	12.40	3.71
	18	19.30	2.93	18.87	3.00	16.73	3.34	15.45	3.55	14.70	3.60	11.71	3.79
	20	19.01	3.01	18.51	3.08	16.00	3.42	14.50	3.62	13.79	3.66	10.96	3.80
	21	19.04	3.05	18.48	3.10	15.66	3.35	13.96	3.50	13.28	3.57	10.56	3.82
	22	19.20	3.07	18.67	3.14	16.03	3.48	14.45	3.69	13.58	3.72	10.13	3.84
	24	19.90	3.10	19.09	3.17	15.06	3.53	12.64	3.74	11.96	3.77	9.22	3.88
1.6 + 2.0 + 2.0 + 3.5 + 3.5	16	20.14	2.82	19.73	2.89	17.66	3.24	16.41	3.46	15.61	3.51	12.40	3.71
	18	19.30	2.93	18.87	3.00	16.73	3.34	15.45	3.55	14.70	3.60	11.71	3.79
	20	19.01	3.01	18.51	3.08	16.00	3.42	14.50	3.62	13.79	3.66	10.96	3.80
	21	19.04	3.05	18.48	3.10	15.66	3.35	13.96	3.50	13.28	3.57	10.56	3.82
	22	19.20	3.07	18.67	3.14	16.03	3.48	14.45	3.69	13.58	3.72	10.13	3.84
	24	19.90	3.10	19.09	3.17	15.06	3.53	12.64	3.74	11.96	3.77	9.22	3.88
1.6 + 2.0 + 2.0 + 3.5 + 4.2	16	20.14	2.81	19.73	2.88	17.66	3.24	16.41	3.45	15.61	3.50	12.40	3.70
	18	19.30	2.93	18.87	2.99	16.73	3.33	15.45	3.54	14.70	3.59	11.71	3.78
	20	19.01	3.00	18.51	3.07	16.00	3.41	14.50	3.61	13.79	3.65	10.96	3.79
	21	19.04	3.04	18.48	3.09	15.66	3.34	13.96	3.49	13.28	3.56	10.56	3.81
	22	19.20	3.06	18.67	3.13	16.03	3.47	14.45	3.68	13.58	3.71	10.13	3.83
	24	19.90	3.09	19.09	3.16	15.06	3.52	12.64	3.73	11.96	3.76	9.22	3.87
1.6 + 2.0 + 2.0 + 3.5 + 5.0	16	20.14	2.81	19.73	2.88	17.66	3.24	16.41	3.45	15.61	3.50	12.40	3.70
	18	19.30	2.93	18.87	2.99	16.73	3.33	15.45	3.54	14.70	3.59	11.71	3.78
	20	19.01	3.00	18.51	3.07	16.00	3.41	14.50	3.61	13.79	3.65	10.96	3.79
	21	19.04	3.04	18.48	3.09	15.66	3.34	13.96	3.49	13.28	3.56	10.56	3.81
	22	19.20	3.06	18.67	3.13	16.03	3.47	14.45	3.68	13.58	3.71	10.13	3.83
	24	19.90	3.09	19.09	3.16	15.06	3.52	12.64	3.73	11.96	3.76	9.22	3.87
1.6 + 2.0 + 2.0 + 3.5 + 6.0	16	20.14	2.81	19.73	2.88	17.66	3.24	16.41	3.45	15.61	3.50	12.40	3.70
	18	19.30	2.93	18.87	2.99	16.73	3.33	15.45	3.54	14.70	3.59	11.71	3.78
	20	19.01	3.00	18.51	3.07	16.00	3.41	14.50	3.61	13.79	3.65	10.96	3.79
	21	19.04	3.04	18.48	3.09	15.66	3.34	13.96	3.49	13.28	3.56	10.56	3.81
	22	19.20	3.06	18.67	3.13	16.03	3.47	14.45	3.68	13.58	3.71	10.13	3.83
	24	19.90	3.09	19.09	3.16	15.06	3.52	12.64	3.73	11.96	3.76	9.22	3.87

Combination (Capacity)	Indoor Air Temp. °C DB	Outdoor Air Temp. °C									
		0/-1		-5/-6		-7/-8		-10/-11		-15/-	
		Total Q	Input Power	Total Q	Input Power	Total Q	Input Power	Total Q	Input Power	Total Q	Input Power
1.6 + 2.0 + 2.0 + 2.5 + 6.0	16	12.04	3.63	11.13	3.51	10.76	3.46	10.34	3.34	9.65	3.14
	18	11.40	3.69	10.61	3.54	9.92	3.48	10.14	3.38	9.88	3.20
	20	10.75	3.70	10.21	3.56	9.99	3.50	9.96	3.42	9.91	3.29
	21	10.31	3.72	9.67	3.58	9.42	3.52	9.58	3.45	9.83	3.33
	22	10.07	3.74	9.92	3.59	9.86	3.54	9.80	3.47	9.71	3.37
	24	9.36	3.78	9.73	3.64	9.88	3.58	9.67	3.53	9.32	3.45
1.6 + 2.0 + 2.0 + 2.5 + 7.1	16	12.04	3.67	11.13	3.55	10.76	3.50	10.34	3.38	9.65	3.18
	18	11.40	3.73	10.61	3.58	9.92	3.52	10.14	3.42	9.88	3.24
	20	10.75	3.75	10.21	3.60	9.99	3.54	9.96	3.46	9.91	3.33
	21	10.31	3.76	9.67	3.62	9.42	3.56	9.58	3.49	9.83	3.37
	22	10.07	3.78	9.92	3.63	9.86	3.58	9.80	3.51	9.71	3.41
	24	9.36	3.82	9.73	3.68	9.88	3.62	9.67	3.57	9.32	3.49
1.6 + 2.0 + 2.0 + 3.5 + 3.5	16	12.04	3.67	11.13	3.55	10.76	3.50	10.34	3.38	9.65	3.18
	18	11.40	3.73	10.61	3.58	9.92	3.52	10.14	3.42	9.88	3.24
	20	10.75	3.75	10.21	3.60	9.99	3.54	9.96	3.46	9.91	3.33
	21	10.31	3.76	9.67	3.62	9.42	3.56	9.58	3.49	9.83	3.37
	22	10.07	3.78	9.92	3.63	9.86	3.58	9.80	3.51	9.71	3.41
	24	9.36	3.82	9.73	3.68	9.88	3.62	9.67	3.57	9.32	3.49
1.6 + 2.0 + 2.0 + 3.5 + 4.2	16	12.04	3.66	11.13	3.54	10.76	3.49	10.34	3.37	9.65	3.17
	18	11.40	3.72	10.61	3.57	9.92	3.51	10.14	3.41	9.88	3.23
	20	10.75	3.74	10.21	3.59	9.99	3.53	9.96	3.45	9.91	3.32
	21	10.31	3.75	9.67	3.61	9.42	3.55	9.58	3.48	9.83	3.36
	22	10.07	3.77	9.92	3.62	9.86	3.57	9.80	3.50	9.71	3.40
	24	9.36	3.81	9.73	3.67	9.88	3.61	9.67	3.56	9.32	3.48
1.6 + 2.0 + 2.0 + 3.5 + 5.0	16	12.04	3.66	11.13	3.54	10.76	3.49	10.34	3.37	9.65	3.17
	18	11.40	3.72	10.61	3.57	9.92	3.51	10.14	3.41	9.88	3.23
	20	10.75	3.74	10.21	3.59	9.99	3.53	9.96	3.45	9.91	3.32
	21	10.31	3.75	9.67	3.61	9.42	3.55	9.58	3.48	9.83	3.36
	22	10.07	3.77	9.92	3.62	9.86	3.57	9.80	3.50	9.71	3.40
	24	9.36	3.81	9.73	3.67	9.88	3.61	9.67	3.56	9.32	3.48
1.6 + 2.0 + 2.0 + 3.5 + 6.0	16	12.04	3.66	11.13	3.54	10.76	3.49	10.34	3.37	9.65	3.17
	18	11.40	3.72	10.61	3.57	9.92	3.51	10.14	3.41	9.88	3.23
	20	10.75	3.74	10.21	3.59	9.99	3.53	9.96	3.45	9.91	3.32
	21	10.31	3.75	9.67	3.61	9.42	3.55	9.58	3.48	9.83	3.36
	22	10.07	3.77	9.92	3.62	9.86	3.57	9.80	3.50	9.71	3.40
	24	9.36	3.81	9.73	3.67	9.88	3.61	9.67	3.56	9.32	3.48

Combination (Capacity)	Indoor Air Temp. °C DB	Outdoor Air Temp. °C											
		16/15		15/14		10/9		7/6		6/5		2/1	
		Total Q	Input Power	Total Q	Input Power	Total Q	Input Power	Total Q	Input Power	Total Q	Input Power	Total Q	Input Power
1.6 + 2.0 + 2.0 + 3.5 + 7.1	16	20.14	2.80	19.73	2.87	17.66	3.23	16.41	3.44	15.61	3.49	12.40	3.69
	18	19.30	2.92	18.87	2.99	16.73	3.32	15.45	3.53	14.70	3.58	11.71	3.77
	20	19.01	3.00	18.51	3.06	16.00	3.40	14.50	3.60	13.79	3.64	10.96	3.78
	21	19.04	3.03	18.48	3.08	15.66	3.33	13.96	3.48	13.28	3.55	10.56	3.80
	22	19.20	3.05	18.67	3.12	16.03	3.46	14.45	3.67	13.58	3.70	10.13	3.82
	24	19.90	3.08	19.09	3.15	15.06	3.51	12.64	3.72	11.96	3.75	9.22	3.86
1.6 + 2.0 + 2.0 + 4.2 + 4.2	16	20.14	2.80	19.73	2.87	17.66	3.23	16.41	3.44	15.61	3.49	12.40	3.69
	18	19.30	2.92	18.87	2.99	16.73	3.32	15.45	3.53	14.70	3.58	11.71	3.77
	20	19.01	3.00	18.51	3.06	16.00	3.40	14.50	3.60	13.79	3.64	10.96	3.78
	21	19.04	3.03	18.48	3.08	15.66	3.33	13.96	3.48	13.28	3.55	10.56	3.80
	22	19.20	3.05	18.67	3.12	16.03	3.46	14.45	3.67	13.58	3.70	10.13	3.82
	24	19.90	3.08	19.09	3.15	15.06	3.51	12.64	3.72	11.96	3.75	9.22	3.86
1.6 + 2.0 + 2.0 + 4.2 + 5.0	16	20.14	2.80	19.73	2.87	17.66	3.23	16.41	3.44	15.61	3.49	12.40	3.69
	18	19.30	2.92	18.87	2.99	16.73	3.32	15.45	3.53	14.70	3.58	11.71	3.77
	20	19.01	3.00	18.51	3.06	16.00	3.40	14.50	3.60	13.79	3.64	10.96	3.78
	21	19.04	3.03	18.48	3.08	15.66	3.33	13.96	3.48	13.28	3.55	10.56	3.80
	22	19.20	3.05	18.67	3.12	16.03	3.46	14.45	3.67	13.58	3.70	10.13	3.82
	24	19.90	3.08	19.09	3.15	15.06	3.51	12.64	3.72	11.96	3.75	9.22	3.86
1.6 + 2.0 + 2.0 + 4.2 + 6.0	16	20.14	2.80	19.73	2.87	17.66	3.23	16.41	3.44	15.61	3.49	12.40	3.69
	18	19.30	2.92	18.87	2.99	16.73	3.32	15.45	3.53	14.70	3.58	11.71	3.77
	20	19.01	3.00	18.51	3.06	16.00	3.40	14.50	3.60	13.79	3.64	10.96	3.78
	21	19.04	3.03	18.48	3.08	15.66	3.33	13.96	3.48	13.28	3.55	10.56	3.80
	22	19.20	3.05	18.67	3.12	16.03	3.46	14.45	3.67	13.58	3.70	10.13	3.82
	24	19.90	3.08	19.09	3.15	15.06	3.51	12.64	3.72	11.96	3.75	9.22	3.86
1.6 + 2.0 + 2.0 + 4.2 + 7.1	16	20.14	2.79	19.73	2.86	17.66	3.22	16.41	3.43	15.61	3.48	12.40	3.68
	18	19.30	2.91	18.87	2.98	16.73	3.32	15.45	3.52	14.70	3.57	11.71	3.76
	20	19.01	2.99	18.51	3.05	16.00	3.39	14.50	3.59	13.79	3.63	10.96	3.77
	21	19.04	3.02	18.48	3.07	15.66	3.32	13.96	3.47	13.28	3.54	10.56	3.79
	22	19.20	3.04	18.67	3.11	16.03	3.45	14.45	3.66	13.58	3.69	10.13	3.81
	24	19.90	3.07	19.09	3.14	15.06	3.50	12.64	3.71	11.96	3.74	9.22	3.84
1.6 + 2.0 + 2.0 + 5.0 + 5.0	16	20.14	2.81	19.73	2.88	17.66	3.24	16.41	3.45	15.61	3.50	12.40	3.70
	18	19.30	2.93	18.87	2.99	16.73	3.33	15.45	3.54	14.70	3.59	11.71	3.78
	20	19.01	3.00	18.51	3.07	16.00	3.41	14.50	3.61	13.79	3.65	10.96	3.79
	21	19.04	3.04	18.48	3.09	15.66	3.34	13.96	3.49	13.28	3.56	10.56	3.81
	22	19.20	3.06	18.67	3.13	16.03	3.47	14.45	3.68	13.58	3.71	10.13	3.83
	24	19.90	3.09	19.09	3.16	15.06	3.52	12.64	3.73	11.96	3.76	9.22	3.87

Combination (Capacity)	Indoor Air Temp. °C DB	Outdoor Air Temp. °C									
		0/-1		-5/-6		-7/-8		-10/-11		-15/-	
		Total Q	Input Power	Total Q	Input Power	Total Q	Input Power	Total Q	Input Power	Total Q	Input Power
1.6 + 2.0 + 2.0 + 3.5 + 7.1	16	12.04	3.65	11.13	3.53	10.76	3.48	10.34	3.36	9.65	3.16
	18	11.40	3.71	10.61	3.56	9.92	3.50	10.14	3.40	9.88	3.22
	20	10.75	3.73	10.21	3.58	9.99	3.52	9.96	3.44	9.91	3.31
	21	10.31	3.74	9.67	3.60	9.42	3.54	9.58	3.47	9.83	3.35
	22	10.07	3.76	9.92	3.61	9.86	3.56	9.80	3.49	9.71	3.39
	24	9.36	3.80	9.73	3.66	9.88	3.60	9.67	3.55	9.32	3.47
1.6 + 2.0 + 2.0 + 4.2 + 4.2	16	12.04	3.65	11.13	3.53	10.76	3.48	10.34	3.36	9.65	3.16
	18	11.40	3.71	10.61	3.56	9.92	3.50	10.14	3.40	9.88	3.22
	20	10.75	3.73	10.21	3.58	9.99	3.52	9.96	3.44	9.91	3.31
	21	10.31	3.74	9.67	3.60	9.42	3.54	9.58	3.47	9.83	3.35
	22	10.07	3.76	9.92	3.61	9.86	3.56	9.80	3.49	9.71	3.39
	24	9.36	3.80	9.73	3.66	9.88	3.60	9.67	3.55	9.32	3.47
1.6 + 2.0 + 2.0 + 4.2 + 5.0	16	12.04	3.65	11.13	3.53	10.76	3.48	10.34	3.36	9.65	3.16
	18	11.40	3.71	10.61	3.56	9.92	3.50	10.14	3.40	9.88	3.22
	20	10.75	3.73	10.21	3.58	9.99	3.52	9.96	3.44	9.91	3.31
	21	10.31	3.74	9.67	3.60	9.42	3.54	9.58	3.47	9.83	3.35
	22	10.07	3.76	9.92	3.61	9.86	3.56	9.80	3.49	9.71	3.39
	24	9.36	3.80	9.73	3.66	9.88	3.60	9.67	3.55	9.32	3.47
1.6 + 2.0 + 2.0 + 4.2 + 6.0	16	12.04	3.65	11.13	3.53	10.76	3.48	10.34	3.36	9.65	3.16
	18	11.40	3.71	10.61	3.56	9.92	3.50	10.14	3.40	9.88	3.22
	20	10.75	3.73	10.21	3.58	9.99	3.52	9.96	3.44	9.91	3.31
	21	10.31	3.74	9.67	3.60	9.42	3.54	9.58	3.47	9.83	3.35
	22	10.07	3.76	9.92	3.61	9.86	3.56	9.80	3.49	9.71	3.39
	24	9.36	3.80	9.73	3.66	9.88	3.60	9.67	3.55	9.32	3.47
1.6 + 2.0 + 2.0 + 4.2 + 7.1	16	12.04	3.64	11.13	3.52	10.76	3.47	10.34	3.35	9.65	3.15
	18	11.40	3.70	10.61	3.55	9.92	3.49	10.14	3.39	9.88	3.21
	20	10.75	3.71	10.21	3.57	9.99	3.51	9.96	3.43	9.91	3.30
	21	10.31	3.73	9.67	3.59	9.42	3.53	9.58	3.46	9.83	3.34
	22	10.07	3.75	9.92	3.60	9.86	3.55	9.80	3.48	9.71	3.38
	24	9.36	3.79	9.73	3.65	9.88	3.59	9.67	3.54	9.32	3.46
1.6 + 2.0 + 2.0 + 5.0 + 5.0	16	12.04	3.66	11.13	3.54	10.76	3.49	10.34	3.37	9.65	3.17
	18	11.40	3.72	10.61	3.57	9.92	3.51	10.14	3.41	9.88	3.23
	20	10.75	3.74	10.21	3.59	9.99	3.53	9.96	3.45	9.91	3.32
	21	10.31	3.75	9.67	3.61	9.42	3.55	9.58	3.48	9.83	3.36
	22	10.07	3.77	9.92	3.62	9.86	3.57	9.80	3.50	9.71	3.40
	24	9.36	3.81	9.73	3.67	9.88	3.61	9.67	3.56	9.32	3.48

Combination (Capacity)	Indoor Air Temp. °C DB	Outdoor Air Temp. °C											
		16/15		15/14		10/9		7/6		6/5		2/1	
		Total Q	Input Power	Total Q	Input Power	Total Q	Input Power	Total Q	Input Power	Total Q	Input Power	Total Q	Input Power
1.6 + 2.0 + 2.0 + 5.0 + 6.0	16	20.14	2.81	19.73	2.88	17.66	3.24	16.41	3.45	15.61	3.50	12.40	3.70
	18	19.30	2.93	18.87	2.99	16.73	3.33	15.45	3.54	14.70	3.59	11.71	3.78
	20	19.01	3.00	18.51	3.07	16.00	3.41	14.50	3.61	13.79	3.65	10.96	3.79
	21	19.04	3.04	18.48	3.09	15.66	3.34	13.96	3.49	13.28	3.56	10.56	3.81
	22	19.20	3.06	18.67	3.13	16.03	3.47	14.45	3.68	13.58	3.71	10.13	3.83
	24	19.90	3.09	19.09	3.16	15.06	3.52	12.64	3.73	11.96	3.76	9.22	3.87
1.6 + 2.0 + 2.0 + 5.0 + 7.1	16	20.14	2.85	19.73	2.92	17.66	3.28	16.41	3.50	15.61	3.55	12.40	3.76
	18	19.30	2.97	18.87	3.04	16.73	3.38	15.45	3.59	14.70	3.64	11.71	3.83
	20	19.01	3.05	18.51	3.11	16.00	3.46	14.50	3.66	13.79	3.70	10.96	3.85
	21	19.04	3.08	18.48	3.13	15.66	3.39	13.96	3.54	13.28	3.60	10.56	3.86
	22	19.20	3.10	18.67	3.17	16.03	3.52	14.45	3.73	13.58	3.76	10.13	3.88
	24	19.90	3.13	19.09	3.20	15.06	3.57	12.64	3.78	11.96	3.81	9.22	3.92
1.6 + 2.0 + 2.0 + 6.0 + 6.0	16	20.14	2.81	19.73	2.88	17.66	3.24	16.41	3.45	15.61	3.50	12.40	3.70
	18	19.30	2.93	18.87	2.99	16.73	3.33	15.45	3.54	14.70	3.59	11.71	3.78
	20	19.01	3.00	18.51	3.07	16.00	3.41	14.50	3.61	13.79	3.65	10.96	3.79
	21	19.04	3.04	18.48	3.09	15.66	3.34	13.96	3.49	13.28	3.56	10.56	3.81
	22	19.20	3.06	18.67	3.13	16.03	3.47	14.45	3.68	13.58	3.71	10.13	3.83
	24	19.90	3.09	19.09	3.16	15.06	3.52	12.64	3.73	11.96	3.76	9.22	3.87
1.6 + 2.0 + 2.5 + 2.5 + 2.5	16	20.14	2.86	19.73	2.94	17.66	3.30	16.41	3.52	15.61	3.57	12.40	3.78
	18	19.30	2.98	18.87	3.05	16.73	3.40	15.45	3.61	14.70	3.66	11.71	3.85
	20	19.01	3.06	18.51	3.13	16.00	3.47	14.50	3.68	13.79	3.72	10.96	3.87
	21	19.04	3.10	18.48	3.15	15.66	3.40	13.96	3.56	13.28	3.62	10.56	3.88
	22	19.20	3.12	18.67	3.19	16.03	3.54	14.45	3.75	13.58	3.78	10.13	3.90
	24	19.90	3.15	19.09	3.22	15.06	3.59	12.64	3.80	11.96	3.83	9.22	3.94
1.6 + 2.0 + 2.5 + 2.5 + 3.5	16	20.14	2.84	19.73	2.91	17.66	3.27	16.41	3.49	15.61	3.54	12.40	3.75
	18	19.30	2.96	18.87	3.03	16.73	3.37	15.45	3.58	14.70	3.63	11.71	3.82
	20	19.01	3.04	18.51	3.11	16.00	3.45	14.50	3.65	13.79	3.69	10.96	3.84
	21	19.04	3.07	18.48	3.12	15.66	3.38	13.96	3.53	13.28	3.59	10.56	3.85
	22	19.20	3.09	18.67	3.16	16.03	3.51	14.45	3.72	13.58	3.75	10.13	3.87
	24	19.90	3.12	19.09	3.19	15.06	3.56	12.64	3.77	11.96	3.80	9.22	3.91
1.6 + 2.0 + 2.5 + 2.5 + 4.2	16	20.14	2.83	19.73	2.90	17.66	3.26	16.41	3.48	15.61	3.53	12.40	3.74
	18	19.30	2.95	18.87	3.02	16.73	3.36	15.45	3.57	14.70	3.62	11.71	3.81
	20	19.01	3.03	18.51	3.10	16.00	3.44	14.50	3.64	13.79	3.68	10.96	3.83
	21	19.04	3.06	18.48	3.11	15.66	3.37	13.96	3.52	13.28	3.58	10.56	3.84
	22	19.20	3.08	18.67	3.15	16.03	3.50	14.45	3.71	13.58	3.74	10.13	3.86
	24	19.90	3.11	19.09	3.19	15.06	3.55	12.64	3.76	11.96	3.79	9.22	3.90

Combination (Capacity)	Indoor Air Temp. °C DB	Outdoor Air Temp. °C									
		0/-1		-5/-6		-7/-8		-10/-11		-15/-	
		Total Q	Input Power	Total Q	Input Power	Total Q	Input Power	Total Q	Input Power	Total Q	Input Power
1.6 + 2.0 + 2.0 + 5.0 + 6.0	16	12.04	3.66	11.13	3.54	10.76	3.49	10.34	3.37	9.65	3.17
	18	11.40	3.72	10.61	3.57	9.92	3.51	10.14	3.41	9.88	3.23
	20	10.75	3.74	10.21	3.59	9.99	3.53	9.96	3.45	9.91	3.32
	21	10.31	3.75	9.67	3.61	9.42	3.55	9.58	3.48	9.83	3.36
	22	10.07	3.77	9.92	3.62	9.86	3.57	9.80	3.50	9.71	3.40
	24	9.36	3.81	9.73	3.67	9.88	3.61	9.67	3.56	9.32	3.48
1.6 + 2.0 + 2.0 + 5.0 + 7.1	16	12.04	3.71	11.13	3.59	10.76	3.54	10.34	3.42	9.65	3.21
	18	11.40	3.77	10.61	3.62	9.92	3.56	10.14	3.45	9.88	3.28
	20	10.75	3.79	10.21	3.64	9.99	3.58	9.96	3.50	9.91	3.37
	21	10.31	3.80	9.67	3.66	9.42	3.60	9.58	3.53	9.83	3.41
	22	10.07	3.82	9.92	3.67	9.86	3.61	9.80	3.55	9.71	3.45
	24	9.36	3.86	9.73	3.72	9.88	3.66	9.67	3.61	9.32	3.53
1.6 + 2.0 + 2.0 + 6.0 + 6.0	16	12.04	3.66	11.13	3.54	10.76	3.49	10.34	3.37	9.65	3.17
	18	11.40	3.72	10.61	3.57	9.92	3.51	10.14	3.41	9.88	3.23
	20	10.75	3.74	10.21	3.59	9.99	3.53	9.96	3.45	9.91	3.32
	21	10.31	3.75	9.67	3.61	9.42	3.55	9.58	3.48	9.83	3.36
	22	10.07	3.77	9.92	3.62	9.86	3.57	9.80	3.50	9.71	3.40
	24	9.36	3.81	9.73	3.67	9.88	3.61	9.67	3.56	9.32	3.48
1.6 + 2.0 + 2.5 + 2.5 + 2.5	16	12.04	3.73	11.13	3.61	10.76	3.56	10.34	3.44	9.65	3.23
	18	11.40	3.79	10.61	3.64	9.92	3.58	10.14	3.47	9.88	3.29
	20	10.75	3.81	10.21	3.66	9.99	3.60	9.96	3.52	9.91	3.39
	21	10.31	3.82	9.67	3.68	9.42	3.62	9.58	3.55	9.83	3.42
	22	10.07	3.84	9.92	3.69	9.86	3.63	9.80	3.57	9.71	3.46
	24	9.36	3.88	9.73	3.74	9.88	3.68	9.67	3.63	9.32	3.55
1.6 + 2.0 + 2.5 + 2.5 + 3.5	16	12.04	3.70	11.13	3.58	10.76	3.53	10.34	3.41	9.65	3.21
	18	11.40	3.76	10.61	3.61	9.92	3.55	10.14	3.44	9.88	3.27
	20	10.75	3.78	10.21	3.63	9.99	3.57	9.96	3.49	9.91	3.36
	21	10.31	3.79	9.67	3.65	9.42	3.59	9.58	3.52	9.83	3.40
	22	10.07	3.81	9.92	3.66	9.86	3.61	9.80	3.54	9.71	3.44
	24	9.36	3.85	9.73	3.71	9.88	3.65	9.67	3.60	9.32	3.52
1.6 + 2.0 + 2.5 + 2.5 + 4.2	16	12.04	3.69	11.13	3.57	10.76	3.52	10.34	3.40	9.65	3.20
	18	11.40	3.75	10.61	3.60	9.92	3.54	10.14	3.43	9.88	3.26
	20	10.75	3.77	10.21	3.62	9.99	3.56	9.96	3.48	9.91	3.35
	21	10.31	3.78	9.67	3.64	9.42	3.58	9.58	3.51	9.83	3.39
	22	10.07	3.80	9.92	3.65	9.86	3.60	9.80	3.53	9.71	3.43
	24	9.36	3.84	9.73	3.70	9.88	3.64	9.67	3.59	9.32	3.51

Combination (Capacity)	Indoor Air Temp. °C DB	Outdoor Air Temp. °C											
		16/15		15/14		10/9		7/6		6/5		2/1	
		Total Q	Input Power	Total Q	Input Power	Total Q	Input Power	Total Q	Input Power	Total Q	Input Power	Total Q	Input Power
1.6 + 2.0 + 2.5 + 2.5 + 5.0	16	20.14	2.79	19.73	2.86	17.66	3.21	16.41	3.42	15.61	3.47	12.40	3.67
	18	19.30	2.90	18.87	2.97	16.73	3.31	15.45	3.51	14.70	3.56	11.71	3.75
	20	19.01	2.98	18.51	3.05	16.00	3.38	14.50	3.58	13.79	3.62	10.96	3.76
	21	19.04	3.01	18.48	3.06	15.66	3.31	13.96	3.46	13.28	3.53	10.56	3.78
	22	19.20	3.03	18.67	3.10	16.03	3.44	14.45	3.65	13.58	3.68	10.13	3.80
	24	19.90	3.06	19.09	3.13	15.06	3.49	12.64	3.70	11.96	3.73	9.22	3.83
1.6 + 2.0 + 2.5 + 2.5 + 6.0	16	20.14	2.79	19.73	2.86	17.66	3.21	16.41	3.42	15.61	3.47	12.40	3.67
	18	19.30	2.90	18.87	2.97	16.73	3.31	15.45	3.51	14.70	3.56	11.71	3.75
	20	19.01	2.98	18.51	3.05	16.00	3.38	14.50	3.58	13.79	3.62	10.96	3.76
	21	19.04	3.01	18.48	3.06	15.66	3.31	13.96	3.46	13.28	3.53	10.56	3.78
	22	19.20	3.03	18.67	3.10	16.03	3.44	14.45	3.65	13.58	3.68	10.13	3.80
	24	19.90	3.06	19.09	3.13	15.06	3.49	12.64	3.70	11.96	3.73	9.22	3.83
1.6 + 2.0 + 2.5 + 2.5 + 7.1	16	20.14	2.82	19.73	2.89	17.66	3.24	16.41	3.46	15.61	3.51	12.40	3.71
	18	19.30	2.93	18.87	3.00	16.73	3.34	15.45	3.55	14.70	3.60	11.71	3.79
	20	19.01	3.01	18.51	3.08	16.00	3.42	14.50	3.62	13.79	3.66	10.96	3.80
	21	19.04	3.05	18.48	3.10	15.66	3.35	13.96	3.50	13.28	3.57	10.56	3.82
	22	19.20	3.07	18.67	3.14	16.03	3.48	14.45	3.69	13.58	3.72	10.13	3.84
	24	19.90	3.10	19.09	3.17	15.06	3.53	12.64	3.74	11.96	3.77	9.22	3.88
1.6 + 2.0 + 2.5 + 3.5 + 3.5	16	20.14	2.82	19.73	2.89	17.66	3.24	16.41	3.46	15.61	3.51	12.40	3.71
	18	19.30	2.93	18.87	3.00	16.73	3.34	15.45	3.55	14.70	3.60	11.71	3.79
	20	19.01	3.01	18.51	3.08	16.00	3.42	14.50	3.62	13.79	3.66	10.96	3.80
	21	19.04	3.05	18.48	3.10	15.66	3.35	13.96	3.50	13.28	3.57	10.56	3.82
	22	19.20	3.07	18.67	3.14	16.03	3.48	14.45	3.69	13.58	3.72	10.13	3.84
	24	19.90	3.10	19.09	3.17	15.06	3.53	12.64	3.74	11.96	3.77	9.22	3.88
1.6 + 2.0 + 2.5 + 3.5 + 4.2	16	20.14	2.81	19.73	2.88	17.66	3.24	16.41	3.45	15.61	3.50	12.40	3.70
	18	19.30	2.93	18.87	2.99	16.73	3.33	15.45	3.54	14.70	3.59	11.71	3.78
	20	19.01	3.00	18.51	3.07	16.00	3.41	14.50	3.61	13.79	3.65	10.96	3.79
	21	19.04	3.04	18.48	3.09	15.66	3.34	13.96	3.49	13.28	3.56	10.56	3.81
	22	19.20	3.06	18.67	3.13	16.03	3.47	14.45	3.68	13.58	3.71	10.13	3.83
	24	19.90	3.09	19.09	3.16	15.06	3.52	12.64	3.73	11.96	3.76	9.22	3.87
1.6 + 2.0 + 2.5 + 3.5 + 5.0	16	20.14	2.81	19.73	2.88	17.66	3.24	16.41	3.45	15.61	3.50	12.40	3.70
	18	19.30	2.93	18.87	2.99	16.73	3.33	15.45	3.54	14.70	3.59	11.71	3.78
	20	19.01	3.00	18.51	3.07	16.00	3.41	14.50	3.61	13.79	3.65	10.96	3.79
	21	19.04	3.04	18.48	3.09	15.66	3.34	13.96	3.49	13.28	3.56	10.56	3.81
	22	19.20	3.06	18.67	3.13	16.03	3.47	14.45	3.68	13.58	3.71	10.13	3.83
	24	19.90	3.09	19.09	3.16	15.06	3.52	12.64	3.73	11.96	3.76	9.22	3.87



Combination (Capacity)	Indoor Air Temp. °C DB	Outdoor Air Temp. °C									
		0/-1		-5/-6		-7/-8		-10/-11		-15/-	
		Total Q	Input Power	Total Q	Input Power	Total Q	Input Power	Total Q	Input Power	Total Q	Input Power
1.6 + 2.0 + 2.5 + 2.5 + 5.0	16	12.04	3.63	11.13	3.51	10.76	3.46	10.34	3.34	9.65	3.14
	18	11.40	3.69	10.61	3.54	9.92	3.48	10.14	3.38	9.88	3.20
	20	10.75	3.70	10.21	3.56	9.99	3.50	9.96	3.42	9.91	3.29
	21	10.31	3.72	9.67	3.58	9.42	3.52	9.58	3.45	9.83	3.33
	22	10.07	3.74	9.92	3.59	9.86	3.54	9.80	3.47	9.71	3.37
	24	9.36	3.78	9.73	3.64	9.88	3.58	9.67	3.53	9.32	3.45
1.6 + 2.0 + 2.5 + 2.5 + 6.0	16	12.04	3.63	11.13	3.51	10.76	3.46	10.34	3.34	9.65	3.14
	18	11.40	3.69	10.61	3.54	9.92	3.48	10.14	3.38	9.88	3.20
	20	10.75	3.70	10.21	3.56	9.99	3.50	9.96	3.42	9.91	3.29
	21	10.31	3.72	9.67	3.58	9.42	3.52	9.58	3.45	9.83	3.33
	22	10.07	3.74	9.92	3.59	9.86	3.54	9.80	3.47	9.71	3.37
	24	9.36	3.78	9.73	3.64	9.88	3.58	9.67	3.53	9.32	3.45
1.6 + 2.0 + 2.5 + 2.5 + 7.1	16	12.04	3.67	11.13	3.55	10.76	3.50	10.34	3.38	9.65	3.18
	18	11.40	3.73	10.61	3.58	9.92	3.52	10.14	3.42	9.88	3.24
	20	10.75	3.75	10.21	3.60	9.99	3.54	9.96	3.46	9.91	3.33
	21	10.31	3.76	9.67	3.62	9.42	3.56	9.58	3.49	9.83	3.37
	22	10.07	3.78	9.92	3.63	9.86	3.58	9.80	3.51	9.71	3.41
	24	9.36	3.82	9.73	3.68	9.88	3.62	9.67	3.57	9.32	3.49
1.6 + 2.0 + 2.5 + 3.5 + 3.5	16	12.04	3.67	11.13	3.55	10.76	3.50	10.34	3.38	9.65	3.18
	18	11.40	3.73	10.61	3.58	9.92	3.52	10.14	3.42	9.88	3.24
	20	10.75	3.75	10.21	3.60	9.99	3.54	9.96	3.46	9.91	3.33
	21	10.31	3.76	9.67	3.62	9.42	3.56	9.58	3.49	9.83	3.37
	22	10.07	3.78	9.92	3.63	9.86	3.58	9.80	3.51	9.71	3.41
	24	9.36	3.82	9.73	3.68	9.88	3.62	9.67	3.57	9.32	3.49
1.6 + 2.0 + 2.5 + 3.5 + 4.2	16	12.04	3.66	11.13	3.54	10.76	3.49	10.34	3.37	9.65	3.17
	18	11.40	3.72	10.61	3.57	9.92	3.51	10.14	3.41	9.88	3.23
	20	10.75	3.74	10.21	3.59	9.99	3.53	9.96	3.45	9.91	3.32
	21	10.31	3.75	9.67	3.61	9.42	3.55	9.58	3.48	9.83	3.36
	22	10.07	3.77	9.92	3.62	9.86	3.57	9.80	3.50	9.71	3.40
	24	9.36	3.81	9.73	3.67	9.88	3.61	9.67	3.56	9.32	3.48
1.6 + 2.0 + 2.5 + 3.5 + 5.0	16	12.04	3.66	11.13	3.54	10.76	3.49	10.34	3.37	9.65	3.17
	18	11.40	3.72	10.61	3.57	9.92	3.51	10.14	3.41	9.88	3.23
	20	10.75	3.74	10.21	3.59	9.99	3.53	9.96	3.45	9.91	3.32
	21	10.31	3.75	9.67	3.61	9.42	3.55	9.58	3.48	9.83	3.36
	22	10.07	3.77	9.92	3.62	9.86	3.57	9.80	3.50	9.71	3.40
	24	9.36	3.81	9.73	3.67	9.88	3.61	9.67	3.56	9.32	3.48

Combination (Capacity)	Indoor Air Temp. °C DB	Outdoor Air Temp. °C											
		16/15		15/14		10/9		7/6		6/5		2/1	
		Total Q	Input Power	Total Q	Input Power	Total Q	Input Power	Total Q	Input Power	Total Q	Input Power	Total Q	Input Power
1.6 + 2.0 + 2.5 + 3.5 + 6.0	16	20.14	2.81	19.73	2.88	17.66	3.24	16.41	3.45	15.61	3.50	12.40	3.70
	18	19.30	2.93	18.87	2.99	16.73	3.33	15.45	3.54	14.70	3.59	11.71	3.78
	20	19.01	3.00	18.51	3.07	16.00	3.41	14.50	3.61	13.79	3.65	10.96	3.79
	21	19.04	3.04	18.48	3.09	15.66	3.34	13.96	3.49	13.28	3.56	10.56	3.81
	22	19.20	3.06	18.67	3.13	16.03	3.47	14.45	3.68	13.58	3.71	10.13	3.83
	24	19.90	3.09	19.09	3.16	15.06	3.52	12.64	3.73	11.96	3.76	9.22	3.87
1.6 + 2.0 + 2.5 + 3.5 + 7.1	16	20.14	2.80	19.73	2.87	17.66	3.23	16.41	3.44	15.61	3.49	12.40	3.69
	18	19.30	2.92	18.87	2.99	16.73	3.32	15.45	3.53	14.70	3.58	11.71	3.77
	20	19.01	3.00	18.51	3.06	16.00	3.40	14.50	3.60	13.79	3.64	10.96	3.78
	21	19.04	3.03	18.48	3.08	15.66	3.33	13.96	3.48	13.28	3.55	10.56	3.80
	22	19.20	3.05	18.67	3.12	16.03	3.46	14.45	3.67	13.58	3.70	10.13	3.82
	24	19.90	3.08	19.09	3.15	15.06	3.51	12.64	3.72	11.96	3.75	9.22	3.86
1.6 + 2.0 + 2.5 + 4.2 + 4.2	16	20.14	2.80	19.73	2.87	17.66	3.23	16.41	3.44	15.61	3.49	12.40	3.69
	18	19.30	2.92	18.87	2.99	16.73	3.32	15.45	3.53	14.70	3.58	11.71	3.77
	20	19.01	3.00	18.51	3.06	16.00	3.40	14.50	3.60	13.79	3.64	10.96	3.78
	21	19.04	3.03	18.48	3.08	15.66	3.33	13.96	3.48	13.28	3.55	10.56	3.80
	22	19.20	3.05	18.67	3.12	16.03	3.46	14.45	3.67	13.58	3.70	10.13	3.82
	24	19.90	3.08	19.09	3.15	15.06	3.51	12.64	3.72	11.96	3.75	9.22	3.86
1.6 + 2.0 + 2.5 + 4.2 + 5.0	16	20.14	2.80	19.73	2.87	17.66	3.23	16.41	3.44	15.61	3.49	12.40	3.69
	18	19.30	2.92	18.87	2.99	16.73	3.32	15.45	3.53	14.70	3.58	11.71	3.77
	20	19.01	3.00	18.51	3.06	16.00	3.40	14.50	3.60	13.79	3.64	10.96	3.78
	21	19.04	3.03	18.48	3.08	15.66	3.33	13.96	3.48	13.28	3.55	10.56	3.80
	22	19.20	3.05	18.67	3.12	16.03	3.46	14.45	3.67	13.58	3.70	10.13	3.82
	24	19.90	3.08	19.09	3.15	15.06	3.51	12.64	3.72	11.96	3.75	9.22	3.86
1.6 + 2.0 + 2.5 + 4.2 + 6.0	16	20.14	2.80	19.73	2.87	17.66	3.23	16.41	3.44	15.61	3.49	12.40	3.69
	18	19.30	2.92	18.87	2.99	16.73	3.32	15.45	3.53	14.70	3.58	11.71	3.77
	20	19.01	3.00	18.51	3.06	16.00	3.40	14.50	3.60	13.79	3.64	10.96	3.78
	21	19.04	3.03	18.48	3.08	15.66	3.33	13.96	3.48	13.28	3.55	10.56	3.80
	22	19.20	3.05	18.67	3.12	16.03	3.46	14.45	3.67	13.58	3.70	10.13	3.82
	24	19.90	3.08	19.09	3.15	15.06	3.51	12.64	3.72	11.96	3.75	9.22	3.86
1.6 + 2.0 + 2.5 + 4.2 + 7.1	16	20.14	2.79	19.73	2.86	17.66	3.22	16.41	3.43	15.61	3.48	12.40	3.68
	18	19.30	2.91	18.87	2.98	16.73	3.32	15.45	3.52	14.70	3.57	11.71	3.76
	20	19.01	2.99	18.51	3.05	16.00	3.39	14.50	3.59	13.79	3.63	10.96	3.77
	21	19.04	3.02	18.48	3.07	15.66	3.32	13.96	3.47	13.28	3.54	10.56	3.79
	22	19.20	3.04	18.67	3.11	16.03	3.45	14.45	3.66	13.58	3.69	10.13	3.81
	24	19.90	3.07	19.09	3.14	15.06	3.50	12.64	3.71	11.96	3.74	9.22	3.84

Combination (Capacity)	Indoor Air Temp. °C DB	Outdoor Air Temp. °C									
		0/-1		-5/-6		-7/-8		-10/-11		-15/-	
		Total Q	Input Power	Total Q	Input Power	Total Q	Input Power	Total Q	Input Power	Total Q	Input Power
1.6 + 2.0 + 2.5 + 3.5 + 6.0	16	12.04	3.66	11.13	3.54	10.76	3.49	10.34	3.37	9.65	3.17
	18	11.40	3.72	10.61	3.57	9.92	3.51	10.14	3.41	9.88	3.23
	20	10.75	3.74	10.21	3.59	9.99	3.53	9.96	3.45	9.91	3.32
	21	10.31	3.75	9.67	3.61	9.42	3.55	9.58	3.48	9.83	3.36
	22	10.07	3.77	9.92	3.62	9.86	3.57	9.80	3.50	9.71	3.40
	24	9.36	3.81	9.73	3.67	9.88	3.61	9.67	3.56	9.32	3.48
1.6 + 2.0 + 2.5 + 3.5 + 7.1	16	12.04	3.65	11.13	3.53	10.76	3.48	10.34	3.36	9.65	3.16
	18	11.40	3.71	10.61	3.56	9.92	3.50	10.14	3.40	9.88	3.22
	20	10.75	3.73	10.21	3.58	9.99	3.52	9.96	3.44	9.91	3.31
	21	10.31	3.74	9.67	3.60	9.42	3.54	9.58	3.47	9.83	3.35
	22	10.07	3.76	9.92	3.61	9.86	3.56	9.80	3.49	9.71	3.39
	24	9.36	3.80	9.73	3.66	9.88	3.60	9.67	3.55	9.32	3.47
1.6 + 2.0 + 2.5 + 4.2 + 4.2	16	12.04	3.65	11.13	3.53	10.76	3.48	10.34	3.36	9.65	3.16
	18	11.40	3.71	10.61	3.56	9.92	3.50	10.14	3.40	9.88	3.22
	20	10.75	3.73	10.21	3.58	9.99	3.52	9.96	3.44	9.91	3.31
	21	10.31	3.74	9.67	3.60	9.42	3.54	9.58	3.47	9.83	3.35
	22	10.07	3.76	9.92	3.61	9.86	3.56	9.80	3.49	9.71	3.39
	24	9.36	3.80	9.73	3.66	9.88	3.60	9.67	3.55	9.32	3.47
1.6 + 2.0 + 2.5 + 4.2 + 5.0	16	12.04	3.65	11.13	3.53	10.76	3.48	10.34	3.36	9.65	3.16
	18	11.40	3.71	10.61	3.56	9.92	3.50	10.14	3.40	9.88	3.22
	20	10.75	3.73	10.21	3.58	9.99	3.52	9.96	3.44	9.91	3.31
	21	10.31	3.74	9.67	3.60	9.42	3.54	9.58	3.47	9.83	3.35
	22	10.07	3.76	9.92	3.61	9.86	3.56	9.80	3.49	9.71	3.39
	24	9.36	3.80	9.73	3.66	9.88	3.60	9.67	3.55	9.32	3.47
1.6 + 2.0 + 2.5 + 4.2 + 6.0	16	12.04	3.65	11.13	3.53	10.76	3.48	10.34	3.36	9.65	3.16
	18	11.40	3.71	10.61	3.56	9.92	3.50	10.14	3.40	9.88	3.22
	20	10.75	3.73	10.21	3.58	9.99	3.52	9.96	3.44	9.91	3.31
	21	10.31	3.74	9.67	3.60	9.42	3.54	9.58	3.47	9.83	3.35
	22	10.07	3.76	9.92	3.61	9.86	3.56	9.80	3.49	9.71	3.39
	24	9.36	3.80	9.73	3.66	9.88	3.60	9.67	3.55	9.32	3.47
1.6 + 2.0 + 2.5 + 4.2 + 7.1	16	12.04	3.64	11.13	3.52	10.76	3.47	10.34	3.35	9.65	3.15
	18	11.40	3.70	10.61	3.55	9.92	3.49	10.14	3.39	9.88	3.21
	20	10.75	3.71	10.21	3.57	9.99	3.51	9.96	3.43	9.91	3.30
	21	10.31	3.73	9.67	3.59	9.42	3.53	9.58	3.46	9.83	3.34
	22	10.07	3.75	9.92	3.60	9.86	3.55	9.80	3.48	9.71	3.38
	24	9.36	3.79	9.73	3.65	9.88	3.59	9.67	3.54	9.32	3.46

Combination (Capacity)	Indoor Air Temp. °C DB	Outdoor Air Temp. °C											
		16/15		15/14		10/9		7/6		6/5		2/1	
		Total Q	Input Power	Total Q	Input Power	Total Q	Input Power	Total Q	Input Power	Total Q	Input Power	Total Q	Input Power
1.6 + 2.0 + 2.5 + 5.0 + 5.0	16	20.14	2.81	19.73	2.88	17.66	3.24	16.41	3.45	15.61	3.50	12.40	3.70
	18	19.30	2.93	18.87	2.99	16.73	3.33	15.45	3.54	14.70	3.59	11.71	3.78
	20	19.01	3.00	18.51	3.07	16.00	3.41	14.50	3.61	13.79	3.65	10.96	3.79
	21	19.04	3.04	18.48	3.09	15.66	3.34	13.96	3.49	13.28	3.56	10.56	3.81
	22	19.20	3.06	18.67	3.13	16.03	3.47	14.45	3.68	13.58	3.71	10.13	3.83
	24	19.90	3.09	19.09	3.16	15.06	3.52	12.64	3.73	11.96	3.76	9.22	3.87
1.6 + 2.0 + 2.5 + 5.0 + 6.0	16	20.14	2.81	19.73	2.88	17.66	3.24	16.41	3.45	15.61	3.50	12.40	3.70
	18	19.30	2.93	18.87	2.99	16.73	3.33	15.45	3.54	14.70	3.59	11.71	3.78
	20	19.01	3.00	18.51	3.07	16.00	3.41	14.50	3.61	13.79	3.65	10.96	3.79
	21	19.04	3.04	18.48	3.09	15.66	3.34	13.96	3.49	13.28	3.56	10.56	3.81
	22	19.20	3.06	18.67	3.13	16.03	3.47	14.45	3.68	13.58	3.71	10.13	3.83
	24	19.90	3.09	19.09	3.16	15.06	3.52	12.64	3.73	11.96	3.76	9.22	3.87
1.6 + 2.0 + 2.5 + 5.0 + 7.1	16	20.14	2.85	19.73	2.92	17.66	3.28	16.41	3.50	15.61	3.55	12.40	3.76
	18	19.30	2.97	18.87	3.04	16.73	3.38	15.45	3.59	14.70	3.64	11.71	3.83
	20	19.01	3.05	18.51	3.11	16.00	3.46	14.50	3.66	13.79	3.70	10.96	3.85
	21	19.04	3.08	18.48	3.13	15.66	3.39	13.96	3.54	13.28	3.60	10.56	3.86
	22	19.20	3.10	18.67	3.17	16.03	3.52	14.45	3.73	13.58	3.76	10.13	3.88
	24	19.90	3.13	19.09	3.20	15.06	3.57	12.64	3.78	11.96	3.81	9.22	3.92
1.6 + 2.0 + 2.5 + 6.0 + 6.0	16	20.14	2.81	19.73	2.88	17.66	3.24	16.41	3.45	15.61	3.50	12.40	3.70
	18	19.30	2.93	18.87	2.99	16.73	3.33	15.45	3.54	14.70	3.59	11.71	3.78
	20	19.01	3.00	18.51	3.07	16.00	3.41	14.50	3.61	13.79	3.65	10.96	3.79
	21	19.04	3.04	18.48	3.09	15.66	3.34	13.96	3.49	13.28	3.56	10.56	3.81
	22	19.20	3.06	18.67	3.13	16.03	3.47	14.45	3.68	13.58	3.71	10.13	3.83
	24	19.90	3.09	19.09	3.16	15.06	3.52	12.64	3.73	11.96	3.76	9.22	3.87
1.6 + 2.0 + 3.5 + 3.5 + 3.5	16	20.14	2.79	19.73	2.86	17.66	3.22	16.41	3.43	15.61	3.48	12.40	3.68
	18	19.30	2.91	18.87	2.98	16.73	3.32	15.45	3.52	14.70	3.57	11.71	3.76
	20	19.01	2.99	18.51	3.05	16.00	3.39	14.50	3.59	13.79	3.63	10.96	3.77
	21	19.04	3.02	18.48	3.07	15.66	3.32	13.96	3.47	13.28	3.54	10.56	3.79
	22	19.20	3.04	18.67	3.11	16.03	3.45	14.45	3.66	13.58	3.69	10.13	3.81
	24	19.90	3.07	19.09	3.14	15.06	3.50	12.64	3.71	11.96	3.74	9.22	3.84
1.6 + 2.0 + 3.5 + 3.5 + 4.2	16	20.14	2.83	19.73	2.90	17.66	3.26	16.41	3.48	15.61	3.53	12.40	3.74
	18	19.30	2.95	18.87	3.02	16.73	3.36	15.45	3.57	14.70	3.62	11.71	3.81
	20	19.01	3.03	18.51	3.10	16.00	3.44	14.50	3.64	13.79	3.68	10.96	3.83
	21	19.04	3.06	18.48	3.11	15.66	3.37	13.96	3.52	13.28	3.58	10.56	3.84
	22	19.20	3.08	18.67	3.15	16.03	3.50	14.45	3.71	13.58	3.74	10.13	3.86
	24	19.90	3.11	19.09	3.19	15.06	3.55	12.64	3.76	11.96	3.79	9.22	3.90

Combination (Capacity)	Indoor Air Temp. °C DB	Outdoor Air Temp. °C									
		0/-1		-5/-6		-7/-8		-10/-11		-15/-	
		Total Q	Input Power	Total Q	Input Power	Total Q	Input Power	Total Q	Input Power	Total Q	Input Power
1.6 + 2.0 + 2.5 + 5.0 + 5.0	16	12.04	3.66	11.13	3.54	10.76	3.49	10.34	3.37	9.65	3.17
	18	11.40	3.72	10.61	3.57	9.92	3.51	10.14	3.41	9.88	3.23
	20	10.75	3.74	10.21	3.59	9.99	3.53	9.96	3.45	9.91	3.32
	21	10.31	3.75	9.67	3.61	9.42	3.55	9.58	3.48	9.83	3.36
	22	10.07	3.77	9.92	3.62	9.86	3.57	9.80	3.50	9.71	3.40
	24	9.36	3.81	9.73	3.67	9.88	3.61	9.67	3.56	9.32	3.48
1.6 + 2.0 + 2.5 + 5.0 + 6.0	16	12.04	3.66	11.13	3.54	10.76	3.49	10.34	3.37	9.65	3.17
	18	11.40	3.72	10.61	3.57	9.92	3.51	10.14	3.41	9.88	3.23
	20	10.75	3.74	10.21	3.59	9.99	3.53	9.96	3.45	9.91	3.32
	21	10.31	3.75	9.67	3.61	9.42	3.55	9.58	3.48	9.83	3.36
	22	10.07	3.77	9.92	3.62	9.86	3.57	9.80	3.50	9.71	3.40
	24	9.36	3.81	9.73	3.67	9.88	3.61	9.67	3.56	9.32	3.48
1.6 + 2.0 + 2.5 + 5.0 + 7.1	16	12.04	3.71	11.13	3.59	10.76	3.54	10.34	3.42	9.65	3.21
	18	11.40	3.77	10.61	3.62	9.92	3.56	10.14	3.45	9.88	3.28
	20	10.75	3.79	10.21	3.64	9.99	3.58	9.96	3.50	9.91	3.37
	21	10.31	3.80	9.67	3.66	9.42	3.60	9.58	3.53	9.83	3.41
	22	10.07	3.82	9.92	3.67	9.86	3.61	9.80	3.55	9.71	3.45
	24	9.36	3.86	9.73	3.72	9.88	3.66	9.67	3.61	9.32	3.53
1.6 + 2.0 + 2.5 + 6.0 + 6.0	16	12.04	3.66	11.13	3.54	10.76	3.49	10.34	3.37	9.65	3.17
	18	11.40	3.72	10.61	3.57	9.92	3.51	10.14	3.41	9.88	3.23
	20	10.75	3.74	10.21	3.59	9.99	3.53	9.96	3.45	9.91	3.32
	21	10.31	3.75	9.67	3.61	9.42	3.55	9.58	3.48	9.83	3.36
	22	10.07	3.77	9.92	3.62	9.86	3.57	9.80	3.50	9.71	3.40
	24	9.36	3.81	9.73	3.67	9.88	3.61	9.67	3.56	9.32	3.48
1.6 + 2.0 + 3.5 + 3.5 + 3.5	16	12.04	3.64	11.13	3.52	10.76	3.47	10.34	3.35	9.65	3.15
	18	11.40	3.70	10.61	3.55	9.92	3.49	10.14	3.39	9.88	3.21
	20	10.75	3.71	10.21	3.57	9.99	3.51	9.96	3.43	9.91	3.30
	21	10.31	3.73	9.67	3.59	9.42	3.53	9.58	3.46	9.83	3.34
	22	10.07	3.75	9.92	3.60	9.86	3.55	9.80	3.48	9.71	3.38
	24	9.36	3.79	9.73	3.65	9.88	3.59	9.67	3.54	9.32	3.46
1.6 + 2.0 + 3.5 + 3.5 + 4.2	16	12.04	3.69	11.13	3.57	10.76	3.52	10.34	3.40	9.65	3.20
	18	11.40	3.75	10.61	3.60	9.92	3.54	10.14	3.43	9.88	3.26
	20	10.75	3.77	10.21	3.62	9.99	3.56	9.96	3.48	9.91	3.35
	21	10.31	3.78	9.67	3.64	9.42	3.58	9.58	3.51	9.83	3.39
	22	10.07	3.80	9.92	3.65	9.86	3.60	9.80	3.53	9.71	3.43
	24	9.36	3.84	9.73	3.70	9.88	3.64	9.67	3.59	9.32	3.51

Combination (Capacity)	Indoor Air Temp. °C DB	Outdoor Air Temp. °C											
		16/15		15/14		10/9		7/6		6/5		2/1	
		Total Q	Input Power	Total Q	Input Power	Total Q	Input Power	Total Q	Input Power	Total Q	Input Power	Total Q	Input Power
1.6 + 2.0 + 3.5 + 3.5 + 5.0	16	20.14	2.79	19.73	2.86	17.66	3.22	16.41	3.43	15.61	3.48	12.40	3.68
	18	19.30	2.91	18.87	2.98	16.73	3.32	15.45	3.52	14.70	3.57	11.71	3.76
	20	19.01	2.99	18.51	3.05	16.00	3.39	14.50	3.59	13.79	3.63	10.96	3.77
	21	19.04	3.02	18.48	3.07	15.66	3.32	13.96	3.47	13.28	3.54	10.56	3.79
	22	19.20	3.04	18.67	3.11	16.03	3.45	14.45	3.66	13.58	3.69	10.13	3.81
	24	19.90	3.07	19.09	3.14	15.06	3.50	12.64	3.71	11.96	3.74	9.22	3.84
1.6 + 2.0 + 3.5 + 3.5 + 6.0	16	20.14	2.79	19.73	2.86	17.66	3.22	16.41	3.43	15.61	3.48	12.40	3.68
	18	19.30	2.91	18.87	2.98	16.73	3.32	15.45	3.52	14.70	3.57	11.71	3.76
	20	19.01	2.99	18.51	3.05	16.00	3.39	14.50	3.59	13.79	3.63	10.96	3.77
	21	19.04	3.02	18.48	3.07	15.66	3.32	13.96	3.47	13.28	3.54	10.56	3.79
	22	19.20	3.04	18.67	3.11	16.03	3.45	14.45	3.66	13.58	3.69	10.13	3.81
	24	19.90	3.07	19.09	3.14	15.06	3.50	12.64	3.71	11.96	3.74	9.22	3.84
1.6 + 2.0 + 3.5 + 3.5 + 7.1	16	20.14	2.82	19.73	2.90	17.66	3.25	16.41	3.47	15.61	3.52	12.40	3.73
	18	19.30	2.94	18.87	3.01	16.73	3.35	15.45	3.56	14.70	3.61	11.71	3.80
	20	19.01	3.02	18.51	3.09	16.00	3.43	14.50	3.63	13.79	3.67	10.96	3.81
	21	19.04	3.05	18.48	3.10	15.66	3.36	13.96	3.51	13.28	3.58	10.56	3.83
	22	19.20	3.08	18.67	3.15	16.03	3.49	14.45	3.70	13.58	3.73	10.13	3.85
	24	19.90	3.10	19.09	3.18	15.06	3.54	12.64	3.75	11.96	3.78	9.22	3.89
1.6 + 2.0 + 3.5 + 4.2 + 4.2	16	20.14	2.82	19.73	2.90	17.66	3.25	16.41	3.47	15.61	3.52	12.40	3.73
	18	19.30	2.94	18.87	3.01	16.73	3.35	15.45	3.56	14.70	3.61	11.71	3.80
	20	19.01	3.02	18.51	3.09	16.00	3.43	14.50	3.63	13.79	3.67	10.96	3.81
	21	19.04	3.05	18.48	3.10	15.66	3.36	13.96	3.51	13.28	3.58	10.56	3.83
	22	19.20	3.08	18.67	3.15	16.03	3.49	14.45	3.70	13.58	3.73	10.13	3.85
	24	19.90	3.10	19.09	3.18	15.06	3.54	12.64	3.75	11.96	3.78	9.22	3.89
1.6 + 2.0 + 3.5 + 4.2 + 5.0	16	20.14	2.82	19.73	2.90	17.66	3.25	16.41	3.47	15.61	3.52	12.40	3.73
	18	19.30	2.94	18.87	3.01	16.73	3.35	15.45	3.56	14.70	3.61	11.71	3.80
	20	19.01	3.02	18.51	3.09	16.00	3.43	14.50	3.63	13.79	3.67	10.96	3.81
	21	19.04	3.05	18.48	3.10	15.66	3.36	13.96	3.51	13.28	3.58	10.56	3.83
	22	19.20	3.08	18.67	3.15	16.03	3.49	14.45	3.70	13.58	3.73	10.13	3.85
	24	19.90	3.10	19.09	3.18	15.06	3.54	12.64	3.75	11.96	3.78	9.22	3.89
1.6 + 2.0 + 3.5 + 4.2 + 6.0	16	20.14	2.82	19.73	2.90	17.66	3.25	16.41	3.47	15.61	3.52	12.40	3.73
	18	19.30	2.94	18.87	3.01	16.73	3.35	15.45	3.56	14.70	3.61	11.71	3.80
	20	19.01	3.02	18.51	3.09	16.00	3.43	14.50	3.63	13.79	3.67	10.96	3.81
	21	19.04	3.05	18.48	3.10	15.66	3.36	13.96	3.51	13.28	3.58	10.56	3.83
	22	19.20	3.08	18.67	3.15	16.03	3.49	14.45	3.70	13.58	3.73	10.13	3.85
	24	19.90	3.10	19.09	3.18	15.06	3.54	12.64	3.75	11.96	3.78	9.22	3.89

Combination (Capacity)	Indoor Air Temp. °C DB	Outdoor Air Temp. °C									
		0/-1		-5/-6		-7/-8		-10/-11		-15/-	
		Total Q	Input Power	Total Q	Input Power	Total Q	Input Power	Total Q	Input Power	Total Q	Input Power
1.6 + 2.0 + 3.5 + 3.5 + 5.0	16	12.04	3.64	11.13	3.52	10.76	3.47	10.34	3.35	9.65	3.15
	18	11.40	3.70	10.61	3.55	9.92	3.49	10.14	3.39	9.88	3.21
	20	10.75	3.71	10.21	3.57	9.99	3.51	9.96	3.43	9.91	3.30
	21	10.31	3.73	9.67	3.59	9.42	3.53	9.58	3.46	9.83	3.34
	22	10.07	3.75	9.92	3.60	9.86	3.55	9.80	3.48	9.71	3.38
	24	9.36	3.79	9.73	3.65	9.88	3.59	9.67	3.54	9.32	3.46
1.6 + 2.0 + 3.5 + 3.5 + 6.0	16	12.04	3.64	11.13	3.52	10.76	3.47	10.34	3.35	9.65	3.15
	18	11.40	3.70	10.61	3.55	9.92	3.49	10.14	3.39	9.88	3.21
	20	10.75	3.71	10.21	3.57	9.99	3.51	9.96	3.43	9.91	3.30
	21	10.31	3.73	9.67	3.59	9.42	3.53	9.58	3.46	9.83	3.34
	22	10.07	3.75	9.92	3.60	9.86	3.55	9.80	3.48	9.71	3.38
	24	9.36	3.79	9.73	3.65	9.88	3.59	9.67	3.54	9.32	3.46
1.6 + 2.0 + 3.5 + 3.5 + 7.1	16	12.04	3.68	11.13	3.56	10.76	3.51	10.34	3.39	9.65	3.19
	18	11.40	3.74	10.61	3.59	9.92	3.53	10.14	3.42	9.88	3.25
	20	10.75	3.76	10.21	3.61	9.99	3.55	9.96	3.47	9.91	3.34
	21	10.31	3.77	9.67	3.63	9.42	3.57	9.58	3.50	9.83	3.38
	22	10.07	3.79	9.92	3.64	9.86	3.59	9.80	3.52	9.71	3.42
	24	9.36	3.83	9.73	3.69	9.88	3.63	9.67	3.58	9.32	3.50
1.6 + 2.0 + 3.5 + 4.2 + 4.2	16	12.04	3.68	11.13	3.56	10.76	3.51	10.34	3.39	9.65	3.19
	18	11.40	3.74	10.61	3.59	9.92	3.53	10.14	3.42	9.88	3.25
	20	10.75	3.76	10.21	3.61	9.99	3.55	9.96	3.47	9.91	3.34
	21	10.31	3.77	9.67	3.63	9.42	3.57	9.58	3.50	9.83	3.38
	22	10.07	3.79	9.92	3.64	9.86	3.59	9.80	3.52	9.71	3.42
	24	9.36	3.83	9.73	3.69	9.88	3.63	9.67	3.58	9.32	3.50
1.6 + 2.0 + 3.5 + 4.2 + 5.0	16	12.04	3.68	11.13	3.56	10.76	3.51	10.34	3.39	9.65	3.19
	18	11.40	3.74	10.61	3.59	9.92	3.53	10.14	3.42	9.88	3.25
	20	10.75	3.76	10.21	3.61	9.99	3.55	9.96	3.47	9.91	3.34
	21	10.31	3.77	9.67	3.63	9.42	3.57	9.58	3.50	9.83	3.38
	22	10.07	3.79	9.92	3.64	9.86	3.59	9.80	3.52	9.71	3.42
	24	9.36	3.83	9.73	3.69	9.88	3.63	9.67	3.58	9.32	3.50
1.6 + 2.0 + 3.5 + 4.2 + 6.0	16	12.04	3.68	11.13	3.56	10.76	3.51	10.34	3.39	9.65	3.19
	18	11.40	3.74	10.61	3.59	9.92	3.53	10.14	3.42	9.88	3.25
	20	10.75	3.76	10.21	3.61	9.99	3.55	9.96	3.47	9.91	3.34
	21	10.31	3.77	9.67	3.63	9.42	3.57	9.58	3.50	9.83	3.38
	22	10.07	3.79	9.92	3.64	9.86	3.59	9.80	3.52	9.71	3.42
	24	9.36	3.83	9.73	3.69	9.88	3.63	9.67	3.58	9.32	3.50

Combination (Capacity)	Indoor Air Temp. °C DB	Outdoor Air Temp. °C											
		16/15		15/14		10/9		7/6		6/5		2/1	
		Total Q	Input Power	Total Q	Input Power	Total Q	Input Power	Total Q	Input Power	Total Q	Input Power	Total Q	Input Power
1.6 + 2.0 + 3.5 + 5.0 + 5.0	16	20.14	2.84	19.73	2.91	17.66	3.27	16.41	3.49	15.61	3.54	12.40	3.75
	18	19.30	2.96	18.87	3.03	16.73	3.37	15.45	3.58	14.70	3.63	11.71	3.82
	20	19.01	3.04	18.51	3.11	16.00	3.45	14.50	3.65	13.79	3.69	10.96	3.84
	21	19.04	3.07	18.48	3.12	15.66	3.38	13.96	3.53	13.28	3.59	10.56	3.85
	22	19.20	3.09	18.67	3.16	16.03	3.51	14.45	3.72	13.58	3.75	10.13	3.87
	24	19.90	3.12	19.09	3.19	15.06	3.56	12.64	3.77	11.96	3.80	9.22	3.91
1.6 + 2.0 + 3.5 + 5.0 + 6.0	16	20.14	2.84	19.73	2.91	17.66	3.27	16.41	3.49	15.61	3.54	12.40	3.75
	18	19.30	2.96	18.87	3.03	16.73	3.37	15.45	3.58	14.70	3.63	11.71	3.82
	20	19.01	3.04	18.51	3.11	16.00	3.45	14.50	3.65	13.79	3.69	10.96	3.84
	21	19.04	3.07	18.48	3.12	15.66	3.38	13.96	3.53	13.28	3.59	10.56	3.85
	22	19.20	3.09	18.67	3.16	16.03	3.51	14.45	3.72	13.58	3.75	10.13	3.87
	24	19.90	3.12	19.09	3.19	15.06	3.56	12.64	3.77	11.96	3.80	9.22	3.91
1.6 + 2.0 + 4.2 + 4.2 + 4.2	16	20.14	2.82	19.73	2.89	17.66	3.24	16.41	3.46	15.61	3.51	12.40	3.71
	18	19.30	2.93	18.87	3.00	16.73	3.34	15.45	3.55	14.70	3.60	11.71	3.79
	20	19.01	3.01	18.51	3.08	16.00	3.42	14.50	3.62	13.79	3.66	10.96	3.80
	21	19.04	3.05	18.48	3.10	15.66	3.35	13.96	3.50	13.28	3.57	10.56	3.82
	22	19.20	3.07	18.67	3.14	16.03	3.48	14.45	3.69	13.58	3.72	10.13	3.84
	24	19.90	3.10	19.09	3.17	15.06	3.53	12.64	3.74	11.96	3.77	9.22	3.88
1.6 + 2.0 + 4.2 + 4.2 + 5.0	16	20.14	2.82	19.73	2.89	17.66	3.24	16.41	3.46	15.61	3.51	12.40	3.71
	18	19.30	2.93	18.87	3.00	16.73	3.34	15.45	3.55	14.70	3.60	11.71	3.79
	20	19.01	3.01	18.51	3.08	16.00	3.42	14.50	3.62	13.79	3.66	10.96	3.80
	21	19.04	3.05	18.48	3.10	15.66	3.35	13.96	3.50	13.28	3.57	10.56	3.82
	22	19.20	3.07	18.67	3.14	16.03	3.48	14.45	3.69	13.58	3.72	10.13	3.84
	24	19.90	3.10	19.09	3.17	15.06	3.53	12.64	3.74	11.96	3.77	9.22	3.88
1.6 + 2.0 + 4.2 + 4.2 + 6.0	16	20.14	2.82	19.73	2.89	17.66	3.24	16.41	3.46	15.61	3.51	12.40	3.71
	18	19.30	2.93	18.87	3.00	16.73	3.34	15.45	3.55	14.70	3.60	11.71	3.79
	20	19.01	3.01	18.51	3.08	16.00	3.42	14.50	3.62	13.79	3.66	10.96	3.80
	21	19.04	3.05	18.48	3.10	15.66	3.35	13.96	3.50	13.28	3.57	10.56	3.82
	22	19.20	3.07	18.67	3.14	16.03	3.48	14.45	3.69	13.58	3.72	10.13	3.84
	24	19.90	3.10	19.09	3.17	15.06	3.53	12.64	3.74	11.96	3.77	9.22	3.88
1.6 + 2.0 + 4.2 + 5.0 + 5.0	16	20.14	2.83	19.73	2.90	17.66	3.26	16.41	3.48	15.61	3.53	12.40	3.74
	18	19.30	2.95	18.87	3.02	16.73	3.36	15.45	3.57	14.70	3.62	11.71	3.81
	20	19.01	3.03	18.51	3.10	16.00	3.44	14.50	3.64	13.79	3.68	10.96	3.83
	21	19.04	3.06	18.48	3.11	15.66	3.37	13.96	3.52	13.28	3.58	10.56	3.84
	22	19.20	3.08	18.67	3.15	16.03	3.50	14.45	3.71	13.58	3.74	10.13	3.86
	24	19.90	3.11	19.09	3.19	15.06	3.55	12.64	3.76	11.96	3.79	9.22	3.90



Combination (Capacity)	Indoor Air Temp. °C DB	Outdoor Air Temp. °C									
		0/-1		-5/-6		-7/-8		-10/-11		-15/-	
		Total Q	Input Power	Total Q	Input Power	Total Q	Input Power	Total Q	Input Power	Total Q	Input Power
1.6 + 2.0 + 3.5 + 5.0 + 5.0	16	12.04	3.70	11.13	3.58	10.76	3.53	10.34	3.41	9.65	3.21
	18	11.40	3.76	10.61	3.61	9.92	3.55	10.14	3.44	9.88	3.27
	20	10.75	3.78	10.21	3.63	9.99	3.57	9.96	3.49	9.91	3.36
	21	10.31	3.79	9.67	3.65	9.42	3.59	9.58	3.52	9.83	3.40
	22	10.07	3.81	9.92	3.66	9.86	3.61	9.80	3.54	9.71	3.44
	24	9.36	3.85	9.73	3.71	9.88	3.65	9.67	3.60	9.32	3.52
1.6 + 2.0 + 3.5 + 5.0 + 6.0	16	12.04	3.70	11.13	3.58	10.76	3.53	10.34	3.41	9.65	3.21
	18	11.40	3.76	10.61	3.61	9.92	3.55	10.14	3.44	9.88	3.27
	20	10.75	3.78	10.21	3.63	9.99	3.57	9.96	3.49	9.91	3.36
	21	10.31	3.79	9.67	3.65	9.42	3.59	9.58	3.52	9.83	3.40
	22	10.07	3.81	9.92	3.66	9.86	3.61	9.80	3.54	9.71	3.44
	24	9.36	3.85	9.73	3.71	9.88	3.65	9.67	3.60	9.32	3.52
1.6 + 2.0 + 4.2 + 4.2 + 4.2	16	12.04	3.67	11.13	3.55	10.76	3.50	10.34	3.38	9.65	3.18
	18	11.40	3.73	10.61	3.58	9.92	3.52	10.14	3.42	9.88	3.24
	20	10.75	3.75	10.21	3.60	9.99	3.54	9.96	3.46	9.91	3.33
	21	10.31	3.76	9.67	3.62	9.42	3.56	9.58	3.49	9.83	3.37
	22	10.07	3.78	9.92	3.63	9.86	3.58	9.80	3.51	9.71	3.41
	24	9.36	3.82	9.73	3.68	9.88	3.62	9.67	3.57	9.32	3.49
1.6 + 2.0 + 4.2 + 4.2 + 5.0	16	12.04	3.67	11.13	3.55	10.76	3.50	10.34	3.38	9.65	3.18
	18	11.40	3.73	10.61	3.58	9.92	3.52	10.14	3.42	9.88	3.24
	20	10.75	3.75	10.21	3.60	9.99	3.54	9.96	3.46	9.91	3.33
	21	10.31	3.76	9.67	3.62	9.42	3.56	9.58	3.49	9.83	3.37
	22	10.07	3.78	9.92	3.63	9.86	3.58	9.80	3.51	9.71	3.41
	24	9.36	3.82	9.73	3.68	9.88	3.62	9.67	3.57	9.32	3.49
1.6 + 2.0 + 4.2 + 4.2 + 6.0	16	12.04	3.67	11.13	3.55	10.76	3.50	10.34	3.38	9.65	3.18
	18	11.40	3.73	10.61	3.58	9.92	3.52	10.14	3.42	9.88	3.24
	20	10.75	3.75	10.21	3.60	9.99	3.54	9.96	3.46	9.91	3.33
	21	10.31	3.76	9.67	3.62	9.42	3.56	9.58	3.49	9.83	3.37
	22	10.07	3.78	9.92	3.63	9.86	3.58	9.80	3.51	9.71	3.41
	24	9.36	3.82	9.73	3.68	9.88	3.62	9.67	3.57	9.32	3.49
1.6 + 2.0 + 4.2 + 5.0 + 5.0	16	12.04	3.69	11.13	3.57	10.76	3.52	10.34	3.40	9.65	3.20
	18	11.40	3.75	10.61	3.60	9.92	3.54	10.14	3.43	9.88	3.26
	20	10.75	3.77	10.21	3.62	9.99	3.56	9.96	3.48	9.91	3.35
	21	10.31	3.78	9.67	3.64	9.42	3.58	9.58	3.51	9.83	3.39
	22	10.07	3.80	9.92	3.65	9.86	3.60	9.80	3.53	9.71	3.43
	24	9.36	3.84	9.73	3.70	9.88	3.64	9.67	3.59	9.32	3.51

Combination (Capacity)	Indoor Air Temp. °C DB	Outdoor Air Temp. °C											
		16/15		15/14		10/9		7/6		6/5		2/1	
		Total Q	Input Power	Total Q	Input Power	Total Q	Input Power	Total Q	Input Power	Total Q	Input Power	Total Q	Input Power
1.6 + 2.5 + 2.5 + 2.5 + 2.5	16	20.14	2.86	19.73	2.94	17.66	3.30	16.41	3.52	15.61	3.57	12.40	3.78
	18	19.30	2.98	18.87	3.05	16.73	3.40	15.45	3.61	14.70	3.66	11.71	3.85
	20	19.01	3.06	18.51	3.13	16.00	3.47	14.50	3.68	13.79	3.72	10.96	3.87
	21	19.04	3.10	18.48	3.15	15.66	3.40	13.96	3.56	13.28	3.62	10.56	3.88
	22	19.20	3.12	18.67	3.19	16.03	3.54	14.45	3.75	13.58	3.78	10.13	3.90
	24	19.90	3.15	19.09	3.22	15.06	3.59	12.64	3.80	11.96	3.83	9.22	3.94
1.6 + 2.5 + 2.5 + 2.5 + 3.5	16	20.14	2.84	19.73	2.91	17.66	3.27	16.41	3.49	15.61	3.54	12.40	3.75
	18	19.30	2.96	18.87	3.03	16.73	3.37	15.45	3.58	14.70	3.63	11.71	3.82
	20	19.01	3.04	18.51	3.11	16.00	3.45	14.50	3.65	13.79	3.69	10.96	3.84
	21	19.04	3.07	18.48	3.12	15.66	3.38	13.96	3.53	13.28	3.59	10.56	3.85
	22	19.20	3.09	18.67	3.16	16.03	3.51	14.45	3.72	13.58	3.75	10.13	3.87
	24	19.90	3.12	19.09	3.19	15.06	3.56	12.64	3.77	11.96	3.80	9.22	3.91
1.6 + 2.5 + 2.5 + 2.5 + 4.2	16	20.14	2.83	19.73	2.90	17.66	3.26	16.41	3.48	15.61	3.53	12.40	3.74
	18	19.30	2.95	18.87	3.02	16.73	3.36	15.45	3.57	14.70	3.62	11.71	3.81
	20	19.01	3.03	18.51	3.10	16.00	3.44	14.50	3.64	13.79	3.68	10.96	3.83
	21	19.04	3.06	18.48	3.11	15.66	3.37	13.96	3.52	13.28	3.58	10.56	3.84
	22	19.20	3.08	18.67	3.15	16.03	3.50	14.45	3.71	13.58	3.74	10.13	3.86
	24	19.90	3.11	19.09	3.19	15.06	3.55	12.64	3.76	11.96	3.79	9.22	3.90
1.6 + 2.5 + 2.5 + 2.5 + 5.0	16	20.14	2.79	19.73	2.86	17.66	3.21	16.41	3.42	15.61	3.47	12.40	3.67
	18	19.30	2.90	18.87	2.97	16.73	3.31	15.45	3.51	14.70	3.56	11.71	3.75
	20	19.01	2.98	18.51	3.05	16.00	3.38	14.50	3.58	13.79	3.62	10.96	3.76
	21	19.04	3.01	18.48	3.06	15.66	3.31	13.96	3.46	13.28	3.53	10.56	3.78
	22	19.20	3.03	18.67	3.10	16.03	3.44	14.45	3.65	13.58	3.68	10.13	3.80
	24	19.90	3.06	19.09	3.13	15.06	3.49	12.64	3.70	11.96	3.73	9.22	3.83
1.6 + 2.5 + 2.5 + 2.5 + 6.0	16	20.14	2.79	19.73	2.86	17.66	3.21	16.41	3.42	15.61	3.47	12.40	3.67
	18	19.30	2.90	18.87	2.97	16.73	3.31	15.45	3.51	14.70	3.56	11.71	3.75
	20	19.01	2.98	18.51	3.05	16.00	3.38	14.50	3.58	13.79	3.62	10.96	3.76
	21	19.04	3.01	18.48	3.06	15.66	3.31	13.96	3.46	13.28	3.53	10.56	3.78
	22	19.20	3.03	18.67	3.10	16.03	3.44	14.45	3.65	13.58	3.68	10.13	3.80
	24	19.90	3.06	19.09	3.13	15.06	3.49	12.64	3.70	11.96	3.73	9.22	3.83
1.6 + 2.5 + 2.5 + 2.5 + 7.1	16	20.14	2.82	19.73	2.89	17.66	3.24	16.41	3.46	15.61	3.51	12.40	3.71
	18	19.30	2.93	18.87	3.00	16.73	3.34	15.45	3.55	14.70	3.60	11.71	3.79
	20	19.01	3.01	18.51	3.08	16.00	3.42	14.50	3.62	13.79	3.66	10.96	3.80
	21	19.04	3.05	18.48	3.10	15.66	3.35	13.96	3.50	13.28	3.57	10.56	3.82
	22	19.20	3.07	18.67	3.14	16.03	3.48	14.45	3.69	13.58	3.72	10.13	3.84
	24	19.90	3.10	19.09	3.17	15.06	3.53	12.64	3.74	11.96	3.77	9.22	3.88

Combination (Capacity)	Indoor Air Temp. °C DB	Outdoor Air Temp. °C									
		0/-1		-5/-6		-7/-8		-10/-11		-15/-	
		Total Q	Input Power	Total Q	Input Power	Total Q	Input Power	Total Q	Input Power	Total Q	Input Power
1.6 + 2.5 + 2.5 + 2.5 + 2.5	16	12.04	3.73	11.13	3.61	10.76	3.56	10.34	3.44	9.65	3.23
	18	11.40	3.79	10.61	3.64	9.92	3.58	10.14	3.47	9.88	3.29
	20	10.75	3.81	10.21	3.66	9.99	3.60	9.96	3.52	9.91	3.39
	21	10.31	3.82	9.67	3.68	9.42	3.62	9.58	3.55	9.83	3.42
	22	10.07	3.84	9.92	3.69	9.86	3.63	9.80	3.57	9.71	3.46
	24	9.36	3.88	9.73	3.74	9.88	3.68	9.67	3.63	9.32	3.55
1.6 + 2.5 + 2.5 + 2.5 + 3.5	16	12.04	3.70	11.13	3.58	10.76	3.53	10.34	3.41	9.65	3.21
	18	11.40	3.76	10.61	3.61	9.92	3.55	10.14	3.44	9.88	3.27
	20	10.75	3.78	10.21	3.63	9.99	3.57	9.96	3.49	9.91	3.36
	21	10.31	3.79	9.67	3.65	9.42	3.59	9.58	3.52	9.83	3.40
	22	10.07	3.81	9.92	3.66	9.86	3.61	9.80	3.54	9.71	3.44
	24	9.36	3.85	9.73	3.71	9.88	3.65	9.67	3.60	9.32	3.52
1.6 + 2.5 + 2.5 + 2.5 + 4.2	16	12.04	3.69	11.13	3.57	10.76	3.52	10.34	3.40	9.65	3.20
	18	11.40	3.75	10.61	3.60	9.92	3.54	10.14	3.43	9.88	3.26
	20	10.75	3.77	10.21	3.62	9.99	3.56	9.96	3.48	9.91	3.35
	21	10.31	3.78	9.67	3.64	9.42	3.58	9.58	3.51	9.83	3.39
	22	10.07	3.80	9.92	3.65	9.86	3.60	9.80	3.53	9.71	3.43
	24	9.36	3.84	9.73	3.70	9.88	3.64	9.67	3.59	9.32	3.51
1.6 + 2.5 + 2.5 + 2.5 + 5.0	16	12.04	3.63	11.13	3.51	10.76	3.46	10.34	3.34	9.65	3.14
	18	11.40	3.69	10.61	3.54	9.92	3.48	10.14	3.38	9.88	3.20
	20	10.75	3.70	10.21	3.56	9.99	3.50	9.96	3.42	9.91	3.29
	21	10.31	3.72	9.67	3.58	9.42	3.52	9.58	3.45	9.83	3.33
	22	10.07	3.74	9.92	3.59	9.86	3.54	9.80	3.47	9.71	3.37
	24	9.36	3.78	9.73	3.64	9.88	3.58	9.67	3.53	9.32	3.45
1.6 + 2.5 + 2.5 + 2.5 + 6.0	16	12.04	3.63	11.13	3.51	10.76	3.46	10.34	3.34	9.65	3.14
	18	11.40	3.69	10.61	3.54	9.92	3.48	10.14	3.38	9.88	3.20
	20	10.75	3.70	10.21	3.56	9.99	3.50	9.96	3.42	9.91	3.29
	21	10.31	3.72	9.67	3.58	9.42	3.52	9.58	3.45	9.83	3.33
	22	10.07	3.74	9.92	3.59	9.86	3.54	9.80	3.47	9.71	3.37
	24	9.36	3.78	9.73	3.64	9.88	3.58	9.67	3.53	9.32	3.45
1.6 + 2.5 + 2.5 + 2.5 + 7.1	16	12.04	3.67	11.13	3.55	10.76	3.50	10.34	3.38	9.65	3.18
	18	11.40	3.73	10.61	3.58	9.92	3.52	10.14	3.42	9.88	3.24
	20	10.75	3.75	10.21	3.60	9.99	3.54	9.96	3.46	9.91	3.33
	21	10.31	3.76	9.67	3.62	9.42	3.56	9.58	3.49	9.83	3.37
	22	10.07	3.78	9.92	3.63	9.86	3.58	9.80	3.51	9.71	3.41
	24	9.36	3.82	9.73	3.68	9.88	3.62	9.67	3.57	9.32	3.49

Combination (Capacity)	Indoor Air Temp. °C DB	Outdoor Air Temp. °C											
		16/15		15/14		10/9		7/6		6/5		2/1	
		Total Q	Input Power	Total Q	Input Power	Total Q	Input Power	Total Q	Input Power	Total Q	Input Power	Total Q	Input Power
1.6 + 2.5 + 2.5 + 3.5 + 3.5	16	20.14	2.82	19.73	2.89	17.66	3.24	16.41	3.46	15.61	3.51	12.40	3.71
	18	19.30	2.93	18.87	3.00	16.73	3.34	15.45	3.55	14.70	3.60	11.71	3.79
	20	19.01	3.01	18.51	3.08	16.00	3.42	14.50	3.62	13.79	3.66	10.96	3.80
	21	19.04	3.05	18.48	3.10	15.66	3.35	13.96	3.50	13.28	3.57	10.56	3.82
	22	19.20	3.07	18.67	3.14	16.03	3.48	14.45	3.69	13.58	3.72	10.13	3.84
	24	19.90	3.10	19.09	3.17	15.06	3.53	12.64	3.74	11.96	3.77	9.22	3.88
1.6 + 2.5 + 2.5 + 3.5 + 4.2	16	20.14	2.81	19.73	2.88	17.66	3.24	16.41	3.45	15.61	3.50	12.40	3.70
	18	19.30	2.93	18.87	2.99	16.73	3.33	15.45	3.54	14.70	3.59	11.71	3.78
	20	19.01	3.00	18.51	3.07	16.00	3.41	14.50	3.61	13.79	3.65	10.96	3.79
	21	19.04	3.04	18.48	3.09	15.66	3.34	13.96	3.49	13.28	3.56	10.56	3.81
	22	19.20	3.06	18.67	3.13	16.03	3.47	14.45	3.68	13.58	3.71	10.13	3.83
	24	19.90	3.09	19.09	3.16	15.06	3.52	12.64	3.73	11.96	3.76	9.22	3.87
1.6 + 2.5 + 2.5 + 3.5 + 5.0	16	20.14	2.81	19.73	2.88	17.66	3.24	16.41	3.45	15.61	3.50	12.40	3.70
	18	19.30	2.93	18.87	2.99	16.73	3.33	15.45	3.54	14.70	3.59	11.71	3.78
	20	19.01	3.00	18.51	3.07	16.00	3.41	14.50	3.61	13.79	3.65	10.96	3.79
	21	19.04	3.04	18.48	3.09	15.66	3.34	13.96	3.49	13.28	3.56	10.56	3.81
	22	19.20	3.06	18.67	3.13	16.03	3.47	14.45	3.68	13.58	3.71	10.13	3.83
	24	19.90	3.09	19.09	3.16	15.06	3.52	12.64	3.73	11.96	3.76	9.22	3.87
1.6 + 2.5 + 2.5 + 3.5 + 6.0	16	20.14	2.81	19.73	2.88	17.66	3.24	16.41	3.45	15.61	3.50	12.40	3.70
	18	19.30	2.93	18.87	2.99	16.73	3.33	15.45	3.54	14.70	3.59	11.71	3.78
	20	19.01	3.00	18.51	3.07	16.00	3.41	14.50	3.61	13.79	3.65	10.96	3.79
	21	19.04	3.04	18.48	3.09	15.66	3.34	13.96	3.49	13.28	3.56	10.56	3.81
	22	19.20	3.06	18.67	3.13	16.03	3.47	14.45	3.68	13.58	3.71	10.13	3.83
	24	19.90	3.09	19.09	3.16	15.06	3.52	12.64	3.73	11.96	3.76	9.22	3.87
1.6 + 2.5 + 2.5 + 3.5 + 7.1	16	20.14	2.80	19.73	2.87	17.66	3.23	16.41	3.44	15.61	3.49	12.40	3.69
	18	19.30	2.92	18.87	2.99	16.73	3.32	15.45	3.53	14.70	3.58	11.71	3.77
	20	19.01	3.00	18.51	3.06	16.00	3.40	14.50	3.60	13.79	3.64	10.96	3.78
	21	19.04	3.03	18.48	3.08	15.66	3.33	13.96	3.48	13.28	3.55	10.56	3.80
	22	19.20	3.05	18.67	3.12	16.03	3.46	14.45	3.67	13.58	3.70	10.13	3.82
	24	19.90	3.08	19.09	3.15	15.06	3.51	12.64	3.72	11.96	3.75	9.22	3.86
1.6 + 2.5 + 2.5 + 4.2 + 4.2	16	20.14	2.80	19.73	2.87	17.66	3.23	16.41	3.44	15.61	3.49	12.40	3.69
	18	19.30	2.92	18.87	2.99	16.73	3.32	15.45	3.53	14.70	3.58	11.71	3.77
	20	19.01	3.00	18.51	3.06	16.00	3.40	14.50	3.60	13.79	3.64	10.96	3.78
	21	19.04	3.03	18.48	3.08	15.66	3.33	13.96	3.48	13.28	3.55	10.56	3.80
	22	19.20	3.05	18.67	3.12	16.03	3.46	14.45	3.67	13.58	3.70	10.13	3.82
	24	19.90	3.08	19.09	3.15	15.06	3.51	12.64	3.72	11.96	3.75	9.22	3.86

Combination (Capacity)	Indoor Air Temp. °C DB	Outdoor Air Temp. °C									
		0/-1		-5/-6		-7/-8		-10/-11		-15/-	
		Total Q	Input Power	Total Q	Input Power	Total Q	Input Power	Total Q	Input Power	Total Q	Input Power
1.6 + 2.5 + 2.5 + 3.5 + 3.5	16	12.04	3.67	11.13	3.55	10.76	3.50	10.34	3.38	9.65	3.18
	18	11.40	3.73	10.61	3.58	9.92	3.52	10.14	3.42	9.88	3.24
	20	10.75	3.75	10.21	3.60	9.99	3.54	9.96	3.46	9.91	3.33
	21	10.31	3.76	9.67	3.62	9.42	3.56	9.58	3.49	9.83	3.37
	22	10.07	3.78	9.92	3.63	9.86	3.58	9.80	3.51	9.71	3.41
	24	9.36	3.82	9.73	3.68	9.88	3.62	9.67	3.57	9.32	3.49
1.6 + 2.5 + 2.5 + 3.5 + 4.2	16	12.04	3.66	11.13	3.54	10.76	3.49	10.34	3.37	9.65	3.17
	18	11.40	3.72	10.61	3.57	9.92	3.51	10.14	3.41	9.88	3.23
	20	10.75	3.74	10.21	3.59	9.99	3.53	9.96	3.45	9.91	3.32
	21	10.31	3.75	9.67	3.61	9.42	3.55	9.58	3.48	9.83	3.36
	22	10.07	3.77	9.92	3.62	9.86	3.57	9.80	3.50	9.71	3.40
	24	9.36	3.81	9.73	3.67	9.88	3.61	9.67	3.56	9.32	3.48
1.6 + 2.5 + 2.5 + 3.5 + 5.0	16	12.04	3.66	11.13	3.54	10.76	3.49	10.34	3.37	9.65	3.17
	18	11.40	3.72	10.61	3.57	9.92	3.51	10.14	3.41	9.88	3.23
	20	10.75	3.74	10.21	3.59	9.99	3.53	9.96	3.45	9.91	3.32
	21	10.31	3.75	9.67	3.61	9.42	3.55	9.58	3.48	9.83	3.36
	22	10.07	3.77	9.92	3.62	9.86	3.57	9.80	3.50	9.71	3.40
	24	9.36	3.81	9.73	3.67	9.88	3.61	9.67	3.56	9.32	3.48
1.6 + 2.5 + 2.5 + 3.5 + 6.0	16	12.04	3.66	11.13	3.54	10.76	3.49	10.34	3.37	9.65	3.17
	18	11.40	3.72	10.61	3.57	9.92	3.51	10.14	3.41	9.88	3.23
	20	10.75	3.74	10.21	3.59	9.99	3.53	9.96	3.45	9.91	3.32
	21	10.31	3.75	9.67	3.61	9.42	3.55	9.58	3.48	9.83	3.36
	22	10.07	3.77	9.92	3.62	9.86	3.57	9.80	3.50	9.71	3.40
	24	9.36	3.81	9.73	3.67	9.88	3.61	9.67	3.56	9.32	3.48
1.6 + 2.5 + 2.5 + 3.5 + 7.1	16	12.04	3.65	11.13	3.53	10.76	3.48	10.34	3.36	9.65	3.16
	18	11.40	3.71	10.61	3.56	9.92	3.50	10.14	3.40	9.88	3.22
	20	10.75	3.73	10.21	3.58	9.99	3.52	9.96	3.44	9.91	3.31
	21	10.31	3.74	9.67	3.60	9.42	3.54	9.58	3.47	9.83	3.35
	22	10.07	3.76	9.92	3.61	9.86	3.56	9.80	3.49	9.71	3.39
	24	9.36	3.80	9.73	3.66	9.88	3.60	9.67	3.55	9.32	3.47
1.6 + 2.5 + 2.5 + 4.2 + 4.2	16	12.04	3.65	11.13	3.53	10.76	3.48	10.34	3.36	9.65	3.16
	18	11.40	3.71	10.61	3.56	9.92	3.50	10.14	3.40	9.88	3.22
	20	10.75	3.73	10.21	3.58	9.99	3.52	9.96	3.44	9.91	3.31
	21	10.31	3.74	9.67	3.60	9.42	3.54	9.58	3.47	9.83	3.35
	22	10.07	3.76	9.92	3.61	9.86	3.56	9.80	3.49	9.71	3.39
	24	9.36	3.80	9.73	3.66	9.88	3.60	9.67	3.55	9.32	3.47

Combination (Capacity)	Indoor Air Temp. °C DB	Outdoor Air Temp. °C											
		16/15		15/14		10/9		7/6		6/5		2/1	
		Total Q	Input Power	Total Q	Input Power	Total Q	Input Power	Total Q	Input Power	Total Q	Input Power	Total Q	Input Power
1.6 + 2.5 + 2.5 + 4.2 + 5.0	16	20.14	2.80	19.73	2.87	17.66	3.23	16.41	3.44	15.61	3.49	12.40	3.69
	18	19.30	2.92	18.87	2.99	16.73	3.32	15.45	3.53	14.70	3.58	11.71	3.77
	20	19.01	3.00	18.51	3.06	16.00	3.40	14.50	3.60	13.79	3.64	10.96	3.78
	21	19.04	3.03	18.48	3.08	15.66	3.33	13.96	3.48	13.28	3.55	10.56	3.80
	22	19.20	3.05	18.67	3.12	16.03	3.46	14.45	3.67	13.58	3.70	10.13	3.82
	24	19.90	3.08	19.09	3.15	15.06	3.51	12.64	3.72	11.96	3.75	9.22	3.86
1.6 + 2.5 + 2.5 + 4.2 + 6.0	16	20.14	2.80	19.73	2.87	17.66	3.23	16.41	3.44	15.61	3.49	12.40	3.69
	18	19.30	2.92	18.87	2.99	16.73	3.32	15.45	3.53	14.70	3.58	11.71	3.77
	20	19.01	3.00	18.51	3.06	16.00	3.40	14.50	3.60	13.79	3.64	10.96	3.78
	21	19.04	3.03	18.48	3.08	15.66	3.33	13.96	3.48	13.28	3.55	10.56	3.80
	22	19.20	3.05	18.67	3.12	16.03	3.46	14.45	3.67	13.58	3.70	10.13	3.82
	24	19.90	3.08	19.09	3.15	15.06	3.51	12.64	3.72	11.96	3.75	9.22	3.86
1.6 + 2.5 + 2.5 + 4.2 + 7.1	16	20.14	2.79	19.73	2.86	17.66	3.22	16.41	3.43	15.61	3.48	12.40	3.68
	18	19.30	2.91	18.87	2.98	16.73	3.32	15.45	3.52	14.70	3.57	11.71	3.76
	20	19.01	2.99	18.51	3.05	16.00	3.39	14.50	3.59	13.79	3.63	10.96	3.77
	21	19.04	3.02	18.48	3.07	15.66	3.32	13.96	3.47	13.28	3.54	10.56	3.79
	22	19.20	3.04	18.67	3.11	16.03	3.45	14.45	3.66	13.58	3.69	10.13	3.81
	24	19.90	3.07	19.09	3.14	15.06	3.50	12.64	3.71	11.96	3.74	9.22	3.84
1.6 + 2.5 + 2.5 + 5.0 + 5.0	16	20.14	2.81	19.73	2.88	17.66	3.24	16.41	3.45	15.61	3.50	12.40	3.70
	18	19.30	2.93	18.87	2.99	16.73	3.33	15.45	3.54	14.70	3.59	11.71	3.78
	20	19.01	3.00	18.51	3.07	16.00	3.41	14.50	3.61	13.79	3.65	10.96	3.79
	21	19.04	3.04	18.48	3.09	15.66	3.34	13.96	3.49	13.28	3.56	10.56	3.81
	22	19.20	3.06	18.67	3.13	16.03	3.47	14.45	3.68	13.58	3.71	10.13	3.83
	24	19.90	3.09	19.09	3.16	15.06	3.52	12.64	3.73	11.96	3.76	9.22	3.87
1.6 + 2.5 + 2.5 + 5.0 + 6.0	16	20.14	2.81	19.73	2.88	17.66	3.24	16.41	3.45	15.61	3.50	12.40	3.70
	18	19.30	2.93	18.87	2.99	16.73	3.33	15.45	3.54	14.70	3.59	11.71	3.78
	20	19.01	3.00	18.51	3.07	16.00	3.41	14.50	3.61	13.79	3.65	10.96	3.79
	21	19.04	3.04	18.48	3.09	15.66	3.34	13.96	3.49	13.28	3.56	10.56	3.81
	22	19.20	3.06	18.67	3.13	16.03	3.47	14.45	3.68	13.58	3.71	10.13	3.83
	24	19.90	3.09	19.09	3.16	15.06	3.52	12.64	3.73	11.96	3.76	9.22	3.87
1.6 + 2.5 + 3.5 + 3.5 + 3.5	16	20.14	2.79	19.73	2.86	17.66	3.22	16.41	3.43	15.61	3.48	12.40	3.68
	18	19.30	2.91	18.87	2.98	16.73	3.32	15.45	3.52	14.70	3.57	11.71	3.76
	20	19.01	2.99	18.51	3.05	16.00	3.39	14.50	3.59	13.79	3.63	10.96	3.77
	21	19.04	3.02	18.48	3.07	15.66	3.32	13.96	3.47	13.28	3.54	10.56	3.79
	22	19.20	3.04	18.67	3.11	16.03	3.45	14.45	3.66	13.58	3.69	10.13	3.81
	24	19.90	3.07	19.09	3.14	15.06	3.50	12.64	3.71	11.96	3.74	9.22	3.84

Combination (Capacity)	Indoor Air Temp. °C DB	Outdoor Air Temp. °C									
		0/-1		-5/-6		-7/-8		-10/-11		-15/-	
		Total Q	Input Power	Total Q	Input Power	Total Q	Input Power	Total Q	Input Power	Total Q	Input Power
1.6 + 2.5 + 2.5 + 4.2 + 5.0	16	12.04	3.65	11.13	3.53	10.76	3.48	10.34	3.36	9.65	3.16
	18	11.40	3.71	10.61	3.56	9.92	3.50	10.14	3.40	9.88	3.22
	20	10.75	3.73	10.21	3.58	9.99	3.52	9.96	3.44	9.91	3.31
	21	10.31	3.74	9.67	3.60	9.42	3.54	9.58	3.47	9.83	3.35
	22	10.07	3.76	9.92	3.61	9.86	3.56	9.80	3.49	9.71	3.39
	24	9.36	3.80	9.73	3.66	9.88	3.60	9.67	3.55	9.32	3.47
1.6 + 2.5 + 2.5 + 4.2 + 6.0	16	12.04	3.65	11.13	3.53	10.76	3.48	10.34	3.36	9.65	3.16
	18	11.40	3.71	10.61	3.56	9.92	3.50	10.14	3.40	9.88	3.22
	20	10.75	3.73	10.21	3.58	9.99	3.52	9.96	3.44	9.91	3.31
	21	10.31	3.74	9.67	3.60	9.42	3.54	9.58	3.47	9.83	3.35
	22	10.07	3.76	9.92	3.61	9.86	3.56	9.80	3.49	9.71	3.39
	24	9.36	3.80	9.73	3.66	9.88	3.60	9.67	3.55	9.32	3.47
1.6 + 2.5 + 2.5 + 4.2 + 7.1	16	12.04	3.64	11.13	3.52	10.76	3.47	10.34	3.35	9.65	3.15
	18	11.40	3.70	10.61	3.55	9.92	3.49	10.14	3.39	9.88	3.21
	20	10.75	3.71	10.21	3.57	9.99	3.51	9.96	3.43	9.91	3.30
	21	10.31	3.73	9.67	3.59	9.42	3.53	9.58	3.46	9.83	3.34
	22	10.07	3.75	9.92	3.60	9.86	3.55	9.80	3.48	9.71	3.38
	24	9.36	3.79	9.73	3.65	9.88	3.59	9.67	3.54	9.32	3.46
1.6 + 2.5 + 2.5 + 5.0 + 5.0	16	12.04	3.66	11.13	3.54	10.76	3.49	10.34	3.37	9.65	3.17
	18	11.40	3.72	10.61	3.57	9.92	3.51	10.14	3.41	9.88	3.23
	20	10.75	3.74	10.21	3.59	9.99	3.53	9.96	3.45	9.91	3.32
	21	10.31	3.75	9.67	3.61	9.42	3.55	9.58	3.48	9.83	3.36
	22	10.07	3.77	9.92	3.62	9.86	3.57	9.80	3.50	9.71	3.40
	24	9.36	3.81	9.73	3.67	9.88	3.61	9.67	3.56	9.32	3.48
1.6 + 2.5 + 2.5 + 5.0 + 6.0	16	12.04	3.66	11.13	3.54	10.76	3.49	10.34	3.37	9.65	3.17
	18	11.40	3.72	10.61	3.57	9.92	3.51	10.14	3.41	9.88	3.23
	20	10.75	3.74	10.21	3.59	9.99	3.53	9.96	3.45	9.91	3.32
	21	10.31	3.75	9.67	3.61	9.42	3.55	9.58	3.48	9.83	3.36
	22	10.07	3.77	9.92	3.62	9.86	3.57	9.80	3.50	9.71	3.40
	24	9.36	3.81	9.73	3.67	9.88	3.61	9.67	3.56	9.32	3.48
1.6 + 2.5 + 3.5 + 3.5 + 3.5	16	12.04	3.64	11.13	3.52	10.76	3.47	10.34	3.35	9.65	3.15
	18	11.40	3.70	10.61	3.55	9.92	3.49	10.14	3.39	9.88	3.21
	20	10.75	3.71	10.21	3.57	9.99	3.51	9.96	3.43	9.91	3.30
	21	10.31	3.73	9.67	3.59	9.42	3.53	9.58	3.46	9.83	3.34
	22	10.07	3.75	9.92	3.60	9.86	3.55	9.80	3.48	9.71	3.38
	24	9.36	3.79	9.73	3.65	9.88	3.59	9.67	3.54	9.32	3.46

Combination (Capacity)	Indoor Air Temp. °C DB	Outdoor Air Temp. °C											
		16/15		15/14		10/9		7/6		6/5		2/1	
		Total Q	Input Power	Total Q	Input Power	Total Q	Input Power	Total Q	Input Power	Total Q	Input Power	Total Q	Input Power
1.6 + 2.5 + 3.5 + 3.5 + 4.2	16	20.14	2.83	19.73	2.90	17.66	3.26	16.41	3.48	15.61	3.53	12.40	3.74
	18	19.30	2.95	18.87	3.02	16.73	3.36	15.45	3.57	14.70	3.62	11.71	3.81
	20	19.01	3.03	18.51	3.10	16.00	3.44	14.50	3.64	13.79	3.68	10.96	3.83
	21	19.04	3.06	18.48	3.11	15.66	3.37	13.96	3.52	13.28	3.58	10.56	3.84
	22	19.20	3.08	18.67	3.15	16.03	3.50	14.45	3.71	13.58	3.74	10.13	3.86
	24	19.90	3.11	19.09	3.19	15.06	3.55	12.64	3.76	11.96	3.79	9.22	3.90
1.6 + 2.5 + 3.5 + 3.5 + 5.0	16	20.14	2.79	19.73	2.86	17.66	3.22	16.41	3.43	15.61	3.48	12.40	3.68
	18	19.30	2.91	18.87	2.98	16.73	3.32	15.45	3.52	14.70	3.57	11.71	3.76
	20	19.01	2.99	18.51	3.05	16.00	3.39	14.50	3.59	13.79	3.63	10.96	3.77
	21	19.04	3.02	18.48	3.07	15.66	3.32	13.96	3.47	13.28	3.54	10.56	3.79
	22	19.20	3.04	18.67	3.11	16.03	3.45	14.45	3.66	13.58	3.69	10.13	3.81
	24	19.90	3.07	19.09	3.14	15.06	3.50	12.64	3.71	11.96	3.74	9.22	3.84
1.6 + 2.5 + 3.5 + 3.5 + 6.0	16	20.14	2.79	19.73	2.86	17.66	3.22	16.41	3.43	15.61	3.48	12.40	3.68
	18	19.30	2.91	18.87	2.98	16.73	3.32	15.45	3.52	14.70	3.57	11.71	3.76
	20	19.01	2.99	18.51	3.05	16.00	3.39	14.50	3.59	13.79	3.63	10.96	3.77
	21	19.04	3.02	18.48	3.07	15.66	3.32	13.96	3.47	13.28	3.54	10.56	3.79
	22	19.20	3.04	18.67	3.11	16.03	3.45	14.45	3.66	13.58	3.69	10.13	3.81
	24	19.90	3.07	19.09	3.14	15.06	3.50	12.64	3.71	11.96	3.74	9.22	3.84
1.6 + 2.5 + 3.5 + 3.5 + 7.1	16	20.14	2.82	19.73	2.90	17.66	3.25	16.41	3.47	15.61	3.52	12.40	3.73
	18	19.30	2.94	18.87	3.01	16.73	3.35	15.45	3.56	14.70	3.61	11.71	3.80
	20	19.01	3.02	18.51	3.09	16.00	3.43	14.50	3.63	13.79	3.67	10.96	3.81
	21	19.04	3.05	18.48	3.10	15.66	3.36	13.96	3.51	13.28	3.58	10.56	3.83
	22	19.20	3.08	18.67	3.15	16.03	3.49	14.45	3.70	13.58	3.73	10.13	3.85
	24	19.90	3.10	19.09	3.18	15.06	3.54	12.64	3.75	11.96	3.78	9.22	3.89
1.6 + 2.5 + 3.5 + 4.2 + 4.2	16	20.14	2.82	19.73	2.90	17.66	3.25	16.41	3.47	15.61	3.52	12.40	3.73
	18	19.30	2.94	18.87	3.01	16.73	3.35	15.45	3.56	14.70	3.61	11.71	3.80
	20	19.01	3.02	18.51	3.09	16.00	3.43	14.50	3.63	13.79	3.67	10.96	3.81
	21	19.04	3.05	18.48	3.10	15.66	3.36	13.96	3.51	13.28	3.58	10.56	3.83
	22	19.20	3.08	18.67	3.15	16.03	3.49	14.45	3.70	13.58	3.73	10.13	3.85
	24	19.90	3.10	19.09	3.18	15.06	3.54	12.64	3.75	11.96	3.78	9.22	3.89
1.6 + 2.5 + 3.5 + 4.2 + 5.0	16	20.14	2.82	19.73	2.90	17.66	3.25	16.41	3.47	15.61	3.52	12.40	3.73
	18	19.30	2.94	18.87	3.01	16.73	3.35	15.45	3.56	14.70	3.61	11.71	3.80
	20	19.01	3.02	18.51	3.09	16.00	3.43	14.50	3.63	13.79	3.67	10.96	3.81
	21	19.04	3.05	18.48	3.10	15.66	3.36	13.96	3.51	13.28	3.58	10.56	3.83
	22	19.20	3.08	18.67	3.15	16.03	3.49	14.45	3.70	13.58	3.73	10.13	3.85
	24	19.90	3.10	19.09	3.18	15.06	3.54	12.64	3.75	11.96	3.78	9.22	3.89



Combination (Capacity)	Indoor Air Temp. °C DB	Outdoor Air Temp. °C									
		0/-1		-5/-6		-7/-8		-10/-11		-15/-	
		Total Q	Input Power	Total Q	Input Power	Total Q	Input Power	Total Q	Input Power	Total Q	Input Power
1.6 + 2.5 + 3.5 + 3.5 + 4.2	16	12.04	3.69	11.13	3.57	10.76	3.52	10.34	3.40	9.65	3.20
	18	11.40	3.75	10.61	3.60	9.92	3.54	10.14	3.43	9.88	3.26
	20	10.75	3.77	10.21	3.62	9.99	3.56	9.96	3.48	9.91	3.35
	21	10.31	3.78	9.67	3.64	9.42	3.58	9.58	3.51	9.83	3.39
	22	10.07	3.80	9.92	3.65	9.86	3.60	9.80	3.53	9.71	3.43
	24	9.36	3.84	9.73	3.70	9.88	3.64	9.67	3.59	9.32	3.51
1.6 + 2.5 + 3.5 + 3.5 + 5.0	16	12.04	3.64	11.13	3.52	10.76	3.47	10.34	3.35	9.65	3.15
	18	11.40	3.70	10.61	3.55	9.92	3.49	10.14	3.39	9.88	3.21
	20	10.75	3.71	10.21	3.57	9.99	3.51	9.96	3.43	9.91	3.30
	21	10.31	3.73	9.67	3.59	9.42	3.53	9.58	3.46	9.83	3.34
	22	10.07	3.75	9.92	3.60	9.86	3.55	9.80	3.48	9.71	3.38
	24	9.36	3.79	9.73	3.65	9.88	3.59	9.67	3.54	9.32	3.46
1.6 + 2.5 + 3.5 + 3.5 + 6.0	16	12.04	3.64	11.13	3.52	10.76	3.47	10.34	3.35	9.65	3.15
	18	11.40	3.70	10.61	3.55	9.92	3.49	10.14	3.39	9.88	3.21
	20	10.75	3.71	10.21	3.57	9.99	3.51	9.96	3.43	9.91	3.30
	21	10.31	3.73	9.67	3.59	9.42	3.53	9.58	3.46	9.83	3.34
	22	10.07	3.75	9.92	3.60	9.86	3.55	9.80	3.48	9.71	3.38
	24	9.36	3.79	9.73	3.65	9.88	3.59	9.67	3.54	9.32	3.46
1.6 + 2.5 + 3.5 + 3.5 + 7.1	16	12.04	3.68	11.13	3.56	10.76	3.51	10.34	3.39	9.65	3.19
	18	11.40	3.74	10.61	3.59	9.92	3.53	10.14	3.42	9.88	3.25
	20	10.75	3.76	10.21	3.61	9.99	3.55	9.96	3.47	9.91	3.34
	21	10.31	3.77	9.67	3.63	9.42	3.57	9.58	3.50	9.83	3.38
	22	10.07	3.79	9.92	3.64	9.86	3.59	9.80	3.52	9.71	3.42
	24	9.36	3.83	9.73	3.69	9.88	3.63	9.67	3.58	9.32	3.50
1.6 + 2.5 + 3.5 + 4.2 + 4.2	16	12.04	3.68	11.13	3.56	10.76	3.51	10.34	3.39	9.65	3.19
	18	11.40	3.74	10.61	3.59	9.92	3.53	10.14	3.42	9.88	3.25
	20	10.75	3.76	10.21	3.61	9.99	3.55	9.96	3.47	9.91	3.34
	21	10.31	3.77	9.67	3.63	9.42	3.57	9.58	3.50	9.83	3.38
	22	10.07	3.79	9.92	3.64	9.86	3.59	9.80	3.52	9.71	3.42
	24	9.36	3.83	9.73	3.69	9.88	3.63	9.67	3.58	9.32	3.50
1.6 + 2.5 + 3.5 + 4.2 + 5.0	16	12.04	3.68	11.13	3.56	10.76	3.51	10.34	3.39	9.65	3.19
	18	11.40	3.74	10.61	3.59	9.92	3.53	10.14	3.42	9.88	3.25
	20	10.75	3.76	10.21	3.61	9.99	3.55	9.96	3.47	9.91	3.34
	21	10.31	3.77	9.67	3.63	9.42	3.57	9.58	3.50	9.83	3.38
	22	10.07	3.79	9.92	3.64	9.86	3.59	9.80	3.52	9.71	3.42
	24	9.36	3.83	9.73	3.69	9.88	3.63	9.67	3.58	9.32	3.50

Combination (Capacity)	Indoor Air Temp. °C DB	Outdoor Air Temp. °C											
		16/15		15/14		10/9		7/6		6/5		2/1	
		Total Q	Input Power	Total Q	Input Power	Total Q	Input Power	Total Q	Input Power	Total Q	Input Power	Total Q	Input Power
1.6 + 2.5 + 3.5 + 4.2 + 6.0	16	20.14	2.82	19.73	2.90	17.66	3.25	16.41	3.47	15.61	3.52	12.40	3.73
	18	19.30	2.94	18.87	3.01	16.73	3.35	15.45	3.56	14.70	3.61	11.71	3.80
	20	19.01	3.02	18.51	3.09	16.00	3.43	14.50	3.63	13.79	3.67	10.96	3.81
	21	19.04	3.05	18.48	3.10	15.66	3.36	13.96	3.51	13.28	3.58	10.56	3.83
	22	19.20	3.08	18.67	3.15	16.03	3.49	14.45	3.70	13.58	3.73	10.13	3.85
	24	19.90	3.10	19.09	3.18	15.06	3.54	12.64	3.75	11.96	3.78	9.22	3.89
1.6 + 2.5 + 3.5 + 5.0 + 5.0	16	20.14	2.84	19.73	2.91	17.66	3.27	16.41	3.49	15.61	3.54	12.40	3.75
	18	19.30	2.96	18.87	3.03	16.73	3.37	15.45	3.58	14.70	3.63	11.71	3.82
	20	19.01	3.04	18.51	3.11	16.00	3.45	14.50	3.65	13.79	3.69	10.96	3.84
	21	19.04	3.07	18.48	3.12	15.66	3.38	13.96	3.53	13.28	3.59	10.56	3.85
	22	19.20	3.09	18.67	3.16	16.03	3.51	14.45	3.72	13.58	3.75	10.13	3.87
	24	19.90	3.12	19.09	3.19	15.06	3.56	12.64	3.77	11.96	3.80	9.22	3.91
1.6 + 2.5 + 4.2 + 4.2 + 4.2	16	20.14	2.82	19.73	2.89	17.66	3.24	16.41	3.46	15.61	3.51	12.40	3.71
	18	19.30	2.93	18.87	3.00	16.73	3.34	15.45	3.55	14.70	3.60	11.71	3.79
	20	19.01	3.01	18.51	3.08	16.00	3.42	14.50	3.62	13.79	3.66	10.96	3.80
	21	19.04	3.05	18.48	3.10	15.66	3.35	13.96	3.50	13.28	3.57	10.56	3.82
	22	19.20	3.07	18.67	3.14	16.03	3.48	14.45	3.69	13.58	3.72	10.13	3.84
	24	19.90	3.10	19.09	3.17	15.06	3.53	12.64	3.74	11.96	3.77	9.22	3.88
1.6 + 2.5 + 4.2 + 4.2 + 5.0	16	20.14	2.82	19.73	2.89	17.66	3.24	16.41	3.46	15.61	3.51	12.40	3.71
	18	19.30	2.93	18.87	3.00	16.73	3.34	15.45	3.55	14.70	3.60	11.71	3.79
	20	19.01	3.01	18.51	3.08	16.00	3.42	14.50	3.62	13.79	3.66	10.96	3.80
	21	19.04	3.05	18.48	3.10	15.66	3.35	13.96	3.50	13.28	3.57	10.56	3.82
	22	19.20	3.07	18.67	3.14	16.03	3.48	14.45	3.69	13.58	3.72	10.13	3.84
	24	19.90	3.10	19.09	3.17	15.06	3.53	12.64	3.74	11.96	3.77	9.22	3.88
1.6 + 2.5 + 4.2 + 5.0 + 5.0	16	20.14	2.83	19.73	2.90	17.66	3.26	16.41	3.48	15.61	3.53	12.40	3.74
	18	19.30	2.95	18.87	3.02	16.73	3.36	15.45	3.57	14.70	3.62	11.71	3.81
	20	19.01	3.03	18.51	3.10	16.00	3.44	14.50	3.64	13.79	3.68	10.96	3.83
	21	19.04	3.06	18.48	3.11	15.66	3.37	13.96	3.52	13.28	3.58	10.56	3.84
	22	19.20	3.08	18.67	3.15	16.03	3.50	14.45	3.71	13.58	3.74	10.13	3.86
	24	19.90	3.11	19.09	3.19	15.06	3.55	12.64	3.76	11.96	3.79	9.22	3.90
1.6 + 3.5 + 3.5 + 3.5 + 3.5	16	20.14	2.82	19.73	2.89	17.66	3.24	16.41	3.46	15.61	3.51	12.40	3.71
	18	19.30	2.93	18.87	3.00	16.73	3.34	15.45	3.55	14.70	3.60	11.71	3.79
	20	19.01	3.01	18.51	3.08	16.00	3.42	14.50	3.62	13.79	3.66	10.96	3.80
	21	19.04	3.05	18.48	3.10	15.66	3.35	13.96	3.50	13.28	3.57	10.56	3.82
	22	19.20	3.07	18.67	3.14	16.03	3.48	14.45	3.69	13.58	3.72	10.13	3.84
	24	19.90	3.10	19.09	3.17	15.06	3.53	12.64	3.74	11.96	3.77	9.22	3.88

Combination (Capacity)	Indoor Air Temp. °C DB	Outdoor Air Temp. °C									
		0/-1		-5/-6		-7/-8		-10/-11		-15/-	
		Total Q	Input Power	Total Q	Input Power	Total Q	Input Power	Total Q	Input Power	Total Q	Input Power
1.6 + 2.5 + 3.5 + 4.2 + 6.0	16	12.04	3.68	11.13	3.56	10.76	3.51	10.34	3.39	9.65	3.19
	18	11.40	3.74	10.61	3.59	9.92	3.53	10.14	3.42	9.88	3.25
	20	10.75	3.76	10.21	3.61	9.99	3.55	9.96	3.47	9.91	3.34
	21	10.31	3.77	9.67	3.63	9.42	3.57	9.58	3.50	9.83	3.38
	22	10.07	3.79	9.92	3.64	9.86	3.59	9.80	3.52	9.71	3.42
	24	9.36	3.83	9.73	3.69	9.88	3.63	9.67	3.58	9.32	3.50
1.6 + 2.5 + 3.5 + 5.0 + 5.0	16	12.04	3.70	11.13	3.58	10.76	3.53	10.34	3.41	9.65	3.21
	18	11.40	3.76	10.61	3.61	9.92	3.55	10.14	3.44	9.88	3.27
	20	10.75	3.78	10.21	3.63	9.99	3.57	9.96	3.49	9.91	3.36
	21	10.31	3.79	9.67	3.65	9.42	3.59	9.58	3.52	9.83	3.40
	22	10.07	3.81	9.92	3.66	9.86	3.61	9.80	3.54	9.71	3.44
	24	9.36	3.85	9.73	3.71	9.88	3.65	9.67	3.60	9.32	3.52
1.6 + 2.5 + 4.2 + 4.2 + 4.2	16	12.04	3.67	11.13	3.55	10.76	3.50	10.34	3.38	9.65	3.18
	18	11.40	3.73	10.61	3.58	9.92	3.52	10.14	3.42	9.88	3.24
	20	10.75	3.75	10.21	3.60	9.99	3.54	9.96	3.46	9.91	3.33
	21	10.31	3.76	9.67	3.62	9.42	3.56	9.58	3.49	9.83	3.37
	22	10.07	3.78	9.92	3.63	9.86	3.58	9.80	3.51	9.71	3.41
	24	9.36	3.82	9.73	3.68	9.88	3.62	9.67	3.57	9.32	3.49
1.6 + 2.5 + 4.2 + 4.2 + 5.0	16	12.04	3.67	11.13	3.55	10.76	3.50	10.34	3.38	9.65	3.18
	18	11.40	3.73	10.61	3.58	9.92	3.52	10.14	3.42	9.88	3.24
	20	10.75	3.75	10.21	3.60	9.99	3.54	9.96	3.46	9.91	3.33
	21	10.31	3.76	9.67	3.62	9.42	3.56	9.58	3.49	9.83	3.37
	22	10.07	3.78	9.92	3.63	9.86	3.58	9.80	3.51	9.71	3.41
	24	9.36	3.82	9.73	3.68	9.88	3.62	9.67	3.57	9.32	3.49
1.6 + 2.5 + 4.2 + 5.0 + 5.0	16	12.04	3.69	11.13	3.57	10.76	3.52	10.34	3.40	9.65	3.20
	18	11.40	3.75	10.61	3.60	9.92	3.54	10.14	3.43	9.88	3.26
	20	10.75	3.77	10.21	3.62	9.99	3.56	9.96	3.48	9.91	3.35
	21	10.31	3.78	9.67	3.64	9.42	3.58	9.58	3.51	9.83	3.39
	22	10.07	3.80	9.92	3.65	9.86	3.60	9.80	3.53	9.71	3.43
	24	9.36	3.84	9.73	3.70	9.88	3.64	9.67	3.59	9.32	3.51
1.6 + 3.5 + 3.5 + 3.5 + 3.5	16	12.04	3.67	11.13	3.55	10.76	3.50	10.34	3.38	9.65	3.18
	18	11.40	3.73	10.61	3.58	9.92	3.52	10.14	3.42	9.88	3.24
	20	10.75	3.75	10.21	3.60	9.99	3.54	9.96	3.46	9.91	3.33
	21	10.31	3.76	9.67	3.62	9.42	3.56	9.58	3.49	9.83	3.37
	22	10.07	3.78	9.92	3.63	9.86	3.58	9.80	3.51	9.71	3.41
	24	9.36	3.82	9.73	3.68	9.88	3.62	9.67	3.57	9.32	3.49

Combination (Capacity)	Indoor Air Temp. °C DB	Outdoor Air Temp. °C											
		16/15		15/14		10/9		7/6		6/5		2/1	
		Total Q	Input Power	Total Q	Input Power	Total Q	Input Power	Total Q	Input Power	Total Q	Input Power	Total Q	Input Power
1.6 + 3.5 + 3.5 + 3.5 + 4.2	16	20.14	2.81	19.73	2.88	17.66	3.24	16.41	3.45	15.61	3.50	12.40	3.70
	18	19.30	2.93	18.87	2.99	16.73	3.33	15.45	3.54	14.70	3.59	11.71	3.78
	20	19.01	3.00	18.51	3.07	16.00	3.41	14.50	3.61	13.79	3.65	10.96	3.79
	21	19.04	3.04	18.48	3.09	15.66	3.34	13.96	3.49	13.28	3.56	10.56	3.81
	22	19.20	3.06	18.67	3.13	16.03	3.47	14.45	3.68	13.58	3.71	10.13	3.83
	24	19.90	3.09	19.09	3.16	15.06	3.52	12.64	3.73	11.96	3.76	9.22	3.87
1.6 + 3.5 + 3.5 + 3.5 + 5.0	16	20.14	2.82	19.73	2.89	17.66	3.24	16.41	3.46	15.61	3.51	12.40	3.71
	18	19.30	2.93	18.87	3.00	16.73	3.34	15.45	3.55	14.70	3.60	11.71	3.79
	20	19.01	3.01	18.51	3.08	16.00	3.42	14.50	3.62	13.79	3.66	10.96	3.80
	21	19.04	3.05	18.48	3.10	15.66	3.35	13.96	3.50	13.28	3.57	10.56	3.82
	22	19.20	3.07	18.67	3.14	16.03	3.48	14.45	3.69	13.58	3.72	10.13	3.84
	24	19.90	3.10	19.09	3.17	15.06	3.53	12.64	3.74	11.96	3.77	9.22	3.88
1.6 + 3.5 + 3.5 + 3.5 + 6.0	16	20.14	2.82	19.73	2.89	17.66	3.24	16.41	3.46	15.61	3.51	12.40	3.71
	18	19.30	2.93	18.87	3.00	16.73	3.34	15.45	3.55	14.70	3.60	11.71	3.79
	20	19.01	3.01	18.51	3.08	16.00	3.42	14.50	3.62	13.79	3.66	10.96	3.80
	21	19.04	3.05	18.48	3.10	15.66	3.35	13.96	3.50	13.28	3.57	10.56	3.82
	22	19.20	3.07	18.67	3.14	16.03	3.48	14.45	3.69	13.58	3.72	10.13	3.84
	24	19.90	3.10	19.09	3.17	15.06	3.53	12.64	3.74	11.96	3.77	9.22	3.88
1.6 + 3.5 + 3.5 + 4.2 + 4.2	16	20.14	2.80	19.73	2.87	17.66	3.23	16.41	3.44	15.61	3.49	12.40	3.69
	18	19.30	2.92	18.87	2.99	16.73	3.32	15.45	3.53	14.70	3.58	11.71	3.77
	20	19.01	3.00	18.51	3.06	16.00	3.40	14.50	3.60	13.79	3.64	10.96	3.78
	21	19.04	3.03	18.48	3.08	15.66	3.33	13.96	3.48	13.28	3.55	10.56	3.80
	22	19.20	3.05	18.67	3.12	16.03	3.46	14.45	3.67	13.58	3.70	10.13	3.82
	24	19.90	3.08	19.09	3.15	15.06	3.51	12.64	3.72	11.96	3.75	9.22	3.86
1.6 + 3.5 + 3.5 + 4.2 + 5.0	16	20.14	2.81	19.73	2.88	17.66	3.24	16.41	3.45	15.61	3.50	12.40	3.70
	18	19.30	2.93	18.87	2.99	16.73	3.33	15.45	3.54	14.70	3.59	11.71	3.78
	20	19.01	3.00	18.51	3.07	16.00	3.41	14.50	3.61	13.79	3.65	10.96	3.79
	21	19.04	3.04	18.48	3.09	15.66	3.34	13.96	3.49	13.28	3.56	10.56	3.81
	22	19.20	3.06	18.67	3.13	16.03	3.47	14.45	3.68	13.58	3.71	10.13	3.83
	24	19.90	3.09	19.09	3.16	15.06	3.52	12.64	3.73	11.96	3.76	9.22	3.87
1.6 + 3.5 + 4.2 + 4.2 + 4.2	16	20.14	2.79	19.73	2.86	17.66	3.22	16.41	3.43	15.61	3.48	12.40	3.68
	18	19.30	2.91	18.87	2.98	16.73	3.32	15.45	3.52	14.70	3.57	11.71	3.76
	20	19.01	2.99	18.51	3.05	16.00	3.39	14.50	3.59	13.79	3.63	10.96	3.77
	21	19.04	3.02	18.48	3.07	15.66	3.32	13.96	3.47	13.28	3.54	10.56	3.79
	22	19.20	3.04	18.67	3.11	16.03	3.45	14.45	3.66	13.58	3.69	10.13	3.81
	24	19.90	3.07	19.09	3.14	15.06	3.50	12.64	3.71	11.96	3.74	9.22	3.84

Combination (Capacity)	Indoor Air Temp. °C DB	Outdoor Air Temp. °C									
		0/-1		-5/-6		-7/-8		-10/-11		-15/-	
		Total Q	Input Power	Total Q	Input Power	Total Q	Input Power	Total Q	Input Power	Total Q	Input Power
1.6 + 3.5 + 3.5 + 3.5 + 4.2	16	12.04	3.66	11.13	3.54	10.76	3.49	10.34	3.37	9.65	3.17
	18	11.40	3.72	10.61	3.57	9.92	3.51	10.14	3.41	9.88	3.23
	20	10.75	3.74	10.21	3.59	9.99	3.53	9.96	3.45	9.91	3.32
	21	10.31	3.75	9.67	3.61	9.42	3.55	9.58	3.48	9.83	3.36
	22	10.07	3.77	9.92	3.62	9.86	3.57	9.80	3.50	9.71	3.40
	24	9.36	3.81	9.73	3.67	9.88	3.61	9.67	3.56	9.32	3.48
1.6 + 3.5 + 3.5 + 3.5 + 5.0	16	12.04	3.67	11.13	3.55	10.76	3.50	10.34	3.38	9.65	3.18
	18	11.40	3.73	10.61	3.58	9.92	3.52	10.14	3.42	9.88	3.24
	20	10.75	3.75	10.21	3.60	9.99	3.54	9.96	3.46	9.91	3.33
	21	10.31	3.76	9.67	3.62	9.42	3.56	9.58	3.49	9.83	3.37
	22	10.07	3.78	9.92	3.63	9.86	3.58	9.80	3.51	9.71	3.41
	24	9.36	3.82	9.73	3.68	9.88	3.62	9.67	3.57	9.32	3.49
1.6 + 3.5 + 3.5 + 3.5 + 6.0	16	12.04	3.67	11.13	3.55	10.76	3.50	10.34	3.38	9.65	3.18
	18	11.40	3.73	10.61	3.58	9.92	3.52	10.14	3.42	9.88	3.24
	20	10.75	3.75	10.21	3.60	9.99	3.54	9.96	3.46	9.91	3.33
	21	10.31	3.76	9.67	3.62	9.42	3.56	9.58	3.49	9.83	3.37
	22	10.07	3.78	9.92	3.63	9.86	3.58	9.80	3.51	9.71	3.41
	24	9.36	3.82	9.73	3.68	9.88	3.62	9.67	3.57	9.32	3.49
1.6 + 3.5 + 3.5 + 4.2 + 4.2	16	12.04	3.65	11.13	3.53	10.76	3.48	10.34	3.36	9.65	3.16
	18	11.40	3.71	10.61	3.56	9.92	3.50	10.14	3.40	9.88	3.22
	20	10.75	3.73	10.21	3.58	9.99	3.52	9.96	3.44	9.91	3.31
	21	10.31	3.74	9.67	3.60	9.42	3.54	9.58	3.47	9.83	3.35
	22	10.07	3.76	9.92	3.61	9.86	3.56	9.80	3.49	9.71	3.39
	24	9.36	3.80	9.73	3.66	9.88	3.60	9.67	3.55	9.32	3.47
1.6 + 3.5 + 3.5 + 4.2 + 5.0	16	12.04	3.66	11.13	3.54	10.76	3.49	10.34	3.37	9.65	3.17
	18	11.40	3.72	10.61	3.57	9.92	3.51	10.14	3.41	9.88	3.23
	20	10.75	3.74	10.21	3.59	9.99	3.53	9.96	3.45	9.91	3.32
	21	10.31	3.75	9.67	3.61	9.42	3.55	9.58	3.48	9.83	3.36
	22	10.07	3.77	9.92	3.62	9.86	3.57	9.80	3.50	9.71	3.40
	24	9.36	3.81	9.73	3.67	9.88	3.61	9.67	3.56	9.32	3.48
1.6 + 3.5 + 4.2 + 4.2 + 4.2	16	12.04	3.64	11.13	3.52	10.76	3.47	10.34	3.35	9.65	3.15
	18	11.40	3.70	10.61	3.55	9.92	3.49	10.14	3.39	9.88	3.21
	20	10.75	3.71	10.21	3.57	9.99	3.51	9.96	3.43	9.91	3.30
	21	10.31	3.73	9.67	3.59	9.42	3.53	9.58	3.46	9.83	3.34
	22	10.07	3.75	9.92	3.60	9.86	3.55	9.80	3.48	9.71	3.38
	24	9.36	3.79	9.73	3.65	9.88	3.59	9.67	3.54	9.32	3.46

Combination (Capacity)	Indoor Air Temp. °C DB	Outdoor Air Temp. °C											
		16/15		15/14		10/9		7/6		6/5		2/1	
		Total Q	Input Power	Total Q	Input Power	Total Q	Input Power	Total Q	Input Power	Total Q	Input Power	Total Q	Input Power
2.0 + 2.0 + 2.0 + 2.0 + 2.0	16	20.14	2.86	19.73	2.93	17.66	3.29	16.41	3.51	15.61	3.56	12.40	3.77
	18	19.30	2.97	18.87	3.04	16.73	3.39	15.45	3.60	14.70	3.65	11.71	3.84
	20	19.01	3.05	18.51	3.12	16.00	3.46	14.50	3.67	13.79	3.71	10.96	3.86
	21	19.04	3.09	18.48	3.14	15.66	3.40	13.96	3.55	13.28	3.61	10.56	3.87
	22	19.20	3.11	18.67	3.18	16.03	3.53	14.45	3.74	13.58	3.77	10.13	3.89
	24	19.90	3.14	19.09	3.21	15.06	3.58	12.64	3.79	11.96	3.82	9.22	3.93
2.0 + 2.0 + 2.0 + 2.0 + 2.5	16	20.14	2.86	19.73	2.93	17.66	3.29	16.41	3.51	15.61	3.56	12.40	3.77
	18	19.30	2.97	18.87	3.04	16.73	3.39	15.45	3.60	14.70	3.65	11.71	3.84
	20	19.01	3.05	18.51	3.12	16.00	3.46	14.50	3.67	13.79	3.71	10.96	3.86
	21	19.04	3.09	18.48	3.14	15.66	3.40	13.96	3.55	13.28	3.61	10.56	3.87
	22	19.20	3.11	18.67	3.18	16.03	3.53	14.45	3.74	13.58	3.77	10.13	3.89
	24	19.90	3.14	19.09	3.21	15.06	3.58	12.64	3.79	11.96	3.82	9.22	3.93
2.0 + 2.0 + 2.0 + 2.0 + 3.5	16	20.14	2.83	19.73	2.90	17.66	3.26	16.41	3.48	15.61	3.53	12.40	3.74
	18	19.30	2.95	18.87	3.02	16.73	3.36	15.45	3.57	14.70	3.62	11.71	3.81
	20	19.01	3.03	18.51	3.10	16.00	3.44	14.50	3.64	13.79	3.68	10.96	3.83
	21	19.04	3.06	18.48	3.11	15.66	3.37	13.96	3.52	13.28	3.58	10.56	3.84
	22	19.20	3.08	18.67	3.15	16.03	3.50	14.45	3.71	13.58	3.74	10.13	3.86
	24	19.90	3.11	19.09	3.19	15.06	3.55	12.64	3.76	11.96	3.79	9.22	3.90
2.0 + 2.0 + 2.0 + 2.0 + 4.2	16	20.14	2.82	19.73	2.90	17.66	3.25	16.41	3.47	15.61	3.52	12.40	3.73
	18	19.30	2.94	18.87	3.01	16.73	3.35	15.45	3.56	14.70	3.61	11.71	3.80
	20	19.01	3.02	18.51	3.09	16.00	3.43	14.50	3.63	13.79	3.67	10.96	3.81
	21	19.04	3.05	18.48	3.10	15.66	3.36	13.96	3.51	13.28	3.58	10.56	3.83
	22	19.20	3.08	18.67	3.15	16.03	3.49	14.45	3.70	13.58	3.73	10.13	3.85
	24	19.90	3.10	19.09	3.18	15.06	3.54	12.64	3.75	11.96	3.78	9.22	3.89
2.0 + 2.0 + 2.0 + 2.0 + 5.0	16	20.14	2.82	19.73	2.90	17.66	3.25	16.41	3.47	15.61	3.52	12.40	3.73
	18	19.30	2.94	18.87	3.01	16.73	3.35	15.45	3.56	14.70	3.61	11.71	3.80
	20	19.01	3.02	18.51	3.09	16.00	3.43	14.50	3.63	13.79	3.67	10.96	3.81
	21	19.04	3.05	18.48	3.10	15.66	3.36	13.96	3.51	13.28	3.58	10.56	3.83
	22	19.20	3.08	18.67	3.15	16.03	3.49	14.45	3.70	13.58	3.73	10.13	3.85
	24	19.90	3.10	19.09	3.18	15.06	3.54	12.64	3.75	11.96	3.78	9.22	3.89
2.0 + 2.0 + 2.0 + 2.0 + 6.0	16	20.14	2.82	19.73	2.90	17.66	3.25	16.41	3.47	15.61	3.52	12.40	3.73
	18	19.30	2.94	18.87	3.01	16.73	3.35	15.45	3.56	14.70	3.61	11.71	3.80
	20	19.01	3.02	18.51	3.09	16.00	3.43	14.50	3.63	13.79	3.67	10.96	3.81
	21	19.04	3.05	18.48	3.10	15.66	3.36	13.96	3.51	13.28	3.58	10.56	3.83
	22	19.20	3.08	18.67	3.15	16.03	3.49	14.45	3.70	13.58	3.73	10.13	3.85
	24	19.90	3.10	19.09	3.18	15.06	3.54	12.64	3.75	11.96	3.78	9.22	3.89

Combination (Capacity)	Indoor Air Temp. °C DB	Outdoor Air Temp. °C									
		0/-1		-5/-6		-7/-8		-10/-11		-15/-	
		Total Q	Input Power	Total Q	Input Power	Total Q	Input Power	Total Q	Input Power	Total Q	Input Power
2.0 + 2.0 + 2.0 + 2.0 + 2.0	16	12.04	3.72	11.13	3.60	10.76	3.55	10.34	3.43	9.65	3.22
	18	11.40	3.78	10.61	3.63	9.92	3.57	10.14	3.46	9.88	3.29
	20	10.75	3.80	10.21	3.65	9.99	3.59	9.96	3.51	9.91	3.38
	21	10.31	3.81	9.67	3.67	9.42	3.61	9.58	3.54	9.83	3.42
	22	10.07	3.83	9.92	3.68	9.86	3.62	9.80	3.56	9.71	3.46
	24	9.36	3.87	9.73	3.73	9.88	3.67	9.67	3.62	9.32	3.54
2.0 + 2.0 + 2.0 + 2.0 + 2.5	16	12.04	3.72	11.13	3.60	10.76	3.55	10.34	3.43	9.65	3.22
	18	11.40	3.78	10.61	3.63	9.92	3.57	10.14	3.46	9.88	3.29
	20	10.75	3.80	10.21	3.65	9.99	3.59	9.96	3.51	9.91	3.38
	21	10.31	3.81	9.67	3.67	9.42	3.61	9.58	3.54	9.83	3.42
	22	10.07	3.83	9.92	3.68	9.86	3.62	9.80	3.56	9.71	3.46
	24	9.36	3.87	9.73	3.73	9.88	3.67	9.67	3.62	9.32	3.54
2.0 + 2.0 + 2.0 + 2.0 + 3.5	16	12.04	3.69	11.13	3.57	10.76	3.52	10.34	3.40	9.65	3.20
	18	11.40	3.75	10.61	3.60	9.92	3.54	10.14	3.43	9.88	3.26
	20	10.75	3.77	10.21	3.62	9.99	3.56	9.96	3.48	9.91	3.35
	21	10.31	3.78	9.67	3.64	9.42	3.58	9.58	3.51	9.83	3.39
	22	10.07	3.80	9.92	3.65	9.86	3.60	9.80	3.53	9.71	3.43
	24	9.36	3.84	9.73	3.70	9.88	3.64	9.67	3.59	9.32	3.51
2.0 + 2.0 + 2.0 + 2.0 + 4.2	16	12.04	3.68	11.13	3.56	10.76	3.51	10.34	3.39	9.65	3.19
	18	11.40	3.74	10.61	3.59	9.92	3.53	10.14	3.42	9.88	3.25
	20	10.75	3.76	10.21	3.61	9.99	3.55	9.96	3.47	9.91	3.34
	21	10.31	3.77	9.67	3.63	9.42	3.57	9.58	3.50	9.83	3.38
	22	10.07	3.79	9.92	3.64	9.86	3.59	9.80	3.52	9.71	3.42
	24	9.36	3.83	9.73	3.69	9.88	3.63	9.67	3.58	9.32	3.50
2.0 + 2.0 + 2.0 + 2.0 + 5.0	16	12.04	3.68	11.13	3.56	10.76	3.51	10.34	3.39	9.65	3.19
	18	11.40	3.74	10.61	3.59	9.92	3.53	10.14	3.42	9.88	3.25
	20	10.75	3.76	10.21	3.61	9.99	3.55	9.96	3.47	9.91	3.34
	21	10.31	3.77	9.67	3.63	9.42	3.57	9.58	3.50	9.83	3.38
	22	10.07	3.79	9.92	3.64	9.86	3.59	9.80	3.52	9.71	3.42
	24	9.36	3.83	9.73	3.69	9.88	3.63	9.67	3.58	9.32	3.50
2.0 + 2.0 + 2.0 + 2.0 + 6.0	16	12.04	3.68	11.13	3.56	10.76	3.51	10.34	3.39	9.65	3.19
	18	11.40	3.74	10.61	3.59	9.92	3.53	10.14	3.42	9.88	3.25
	20	10.75	3.76	10.21	3.61	9.99	3.55	9.96	3.47	9.91	3.34
	21	10.31	3.77	9.67	3.63	9.42	3.57	9.58	3.50	9.83	3.38
	22	10.07	3.79	9.92	3.64	9.86	3.59	9.80	3.52	9.71	3.42
	24	9.36	3.83	9.73	3.69	9.88	3.63	9.67	3.58	9.32	3.50

Combination (Capacity)	Indoor Air Temp. °C DB	Outdoor Air Temp. °C											
		16/15		15/14		10/9		7/6		6/5		2/1	
		Total Q	Input Power	Total Q	Input Power	Total Q	Input Power	Total Q	Input Power	Total Q	Input Power	Total Q	Input Power
2.0 + 2.0 + 2.0 + 2.0 + 7.1	16	20.14	2.81	19.73	2.88	17.66	3.24	16.41	3.45	15.61	3.50	12.40	3.70
	18	19.30	2.93	18.87	2.99	16.73	3.33	15.45	3.54	14.70	3.59	11.71	3.78
	20	19.01	3.00	18.51	3.07	16.00	3.41	14.50	3.61	13.79	3.65	10.96	3.79
	21	19.04	3.04	18.48	3.09	15.66	3.34	13.96	3.49	13.28	3.56	10.56	3.81
	22	19.20	3.06	18.67	3.13	16.03	3.47	14.45	3.68	13.58	3.71	10.13	3.83
	24	19.90	3.09	19.09	3.16	15.06	3.52	12.64	3.73	11.96	3.76	9.22	3.87
2.0 + 2.0 + 2.0 + 2.5 + 2.5	16	20.14	2.86	19.73	2.93	17.66	3.29	16.41	3.51	15.61	3.56	12.40	3.77
	18	19.30	2.97	18.87	3.04	16.73	3.39	15.45	3.60	14.70	3.65	11.71	3.84
	20	19.01	3.05	18.51	3.12	16.00	3.46	14.50	3.67	13.79	3.71	10.96	3.86
	21	19.04	3.09	18.48	3.14	15.66	3.40	13.96	3.55	13.28	3.61	10.56	3.87
	22	19.20	3.11	18.67	3.18	16.03	3.53	14.45	3.74	13.58	3.77	10.13	3.89
	24	19.90	3.14	19.09	3.21	15.06	3.58	12.64	3.79	11.96	3.82	9.22	3.93
2.0 + 2.0 + 2.0 + 2.5 + 3.5	16	20.14	2.83	19.73	2.90	17.66	3.26	16.41	3.48	15.61	3.53	12.40	3.74
	18	19.30	2.95	18.87	3.02	16.73	3.36	15.45	3.57	14.70	3.62	11.71	3.81
	20	19.01	3.03	18.51	3.10	16.00	3.44	14.50	3.64	13.79	3.68	10.96	3.83
	21	19.04	3.06	18.48	3.11	15.66	3.37	13.96	3.52	13.28	3.58	10.56	3.84
	22	19.20	3.08	18.67	3.15	16.03	3.50	14.45	3.71	13.58	3.74	10.13	3.86
	24	19.90	3.11	19.09	3.19	15.06	3.55	12.64	3.76	11.96	3.79	9.22	3.90
2.0 + 2.0 + 2.0 + 2.5 + 4.2	16	20.14	2.82	19.73	2.90	17.66	3.25	16.41	3.47	15.61	3.52	12.40	3.73
	18	19.30	2.94	18.87	3.01	16.73	3.35	15.45	3.56	14.70	3.61	11.71	3.80
	20	19.01	3.02	18.51	3.09	16.00	3.43	14.50	3.63	13.79	3.67	10.96	3.81
	21	19.04	3.05	18.48	3.10	15.66	3.36	13.96	3.51	13.28	3.58	10.56	3.83
	22	19.20	3.08	18.67	3.15	16.03	3.49	14.45	3.70	13.58	3.73	10.13	3.85
	24	19.90	3.10	19.09	3.18	15.06	3.54	12.64	3.75	11.96	3.78	9.22	3.89
2.0 + 2.0 + 2.0 + 2.5 + 5.0	16	20.14	2.82	19.73	2.90	17.66	3.25	16.41	3.47	15.61	3.52	12.40	3.73
	18	19.30	2.94	18.87	3.01	16.73	3.35	15.45	3.56	14.70	3.61	11.71	3.80
	20	19.01	3.02	18.51	3.09	16.00	3.43	14.50	3.63	13.79	3.67	10.96	3.81
	21	19.04	3.05	18.48	3.10	15.66	3.36	13.96	3.51	13.28	3.58	10.56	3.83
	22	19.20	3.08	18.67	3.15	16.03	3.49	14.45	3.70	13.58	3.73	10.13	3.85
	24	19.90	3.10	19.09	3.18	15.06	3.54	12.64	3.75	11.96	3.78	9.22	3.89
2.0 + 2.0 + 2.0 + 2.5 + 6.0	16	20.14	2.82	19.73	2.90	17.66	3.25	16.41	3.47	15.61	3.52	12.40	3.73
	18	19.30	2.94	18.87	3.01	16.73	3.35	15.45	3.56	14.70	3.61	11.71	3.80
	20	19.01	3.02	18.51	3.09	16.00	3.43	14.50	3.63	13.79	3.67	10.96	3.81
	21	19.04	3.05	18.48	3.10	15.66	3.36	13.96	3.51	13.28	3.58	10.56	3.83
	22	19.20	3.08	18.67	3.15	16.03	3.49	14.45	3.70	13.58	3.73	10.13	3.85
	24	19.90	3.10	19.09	3.18	15.06	3.54	12.64	3.75	11.96	3.78	9.22	3.89



Combination (Capacity)	Indoor Air Temp. °C DB	Outdoor Air Temp. °C									
		0/-1		-5/-6		-7/-8		-10/-11		-15/-	
		Total Q	Input Power	Total Q	Input Power	Total Q	Input Power	Total Q	Input Power	Total Q	Input Power
2.0 + 2.0 + 2.0 + 2.0 + 7.1	16	12.04	3.66	11.13	3.54	10.76	3.49	10.34	3.37	9.65	3.17
	18	11.40	3.72	10.61	3.57	9.92	3.51	10.14	3.41	9.88	3.23
	20	10.75	3.74	10.21	3.59	9.99	3.53	9.96	3.45	9.91	3.32
	21	10.31	3.75	9.67	3.61	9.42	3.55	9.58	3.48	9.83	3.36
	22	10.07	3.77	9.92	3.62	9.86	3.57	9.80	3.50	9.71	3.40
	24	9.36	3.81	9.73	3.67	9.88	3.61	9.67	3.56	9.32	3.48
2.0 + 2.0 + 2.0 + 2.5 + 2.5	16	12.04	3.72	11.13	3.60	10.76	3.55	10.34	3.43	9.65	3.22
	18	11.40	3.78	10.61	3.63	9.92	3.57	10.14	3.46	9.88	3.29
	20	10.75	3.80	10.21	3.65	9.99	3.59	9.96	3.51	9.91	3.38
	21	10.31	3.81	9.67	3.67	9.42	3.61	9.58	3.54	9.83	3.42
	22	10.07	3.83	9.92	3.68	9.86	3.62	9.80	3.56	9.71	3.46
	24	9.36	3.87	9.73	3.73	9.88	3.67	9.67	3.62	9.32	3.54
2.0 + 2.0 + 2.0 + 2.5 + 3.5	16	12.04	3.69	11.13	3.57	10.76	3.52	10.34	3.40	9.65	3.20
	18	11.40	3.75	10.61	3.60	9.92	3.54	10.14	3.43	9.88	3.26
	20	10.75	3.77	10.21	3.62	9.99	3.56	9.96	3.48	9.91	3.35
	21	10.31	3.78	9.67	3.64	9.42	3.58	9.58	3.51	9.83	3.39
	22	10.07	3.80	9.92	3.65	9.86	3.60	9.80	3.53	9.71	3.43
	24	9.36	3.84	9.73	3.70	9.88	3.64	9.67	3.59	9.32	3.51
2.0 + 2.0 + 2.0 + 2.5 + 4.2	16	12.04	3.68	11.13	3.56	10.76	3.51	10.34	3.39	9.65	3.19
	18	11.40	3.74	10.61	3.59	9.92	3.53	10.14	3.42	9.88	3.25
	20	10.75	3.76	10.21	3.61	9.99	3.55	9.96	3.47	9.91	3.34
	21	10.31	3.77	9.67	3.63	9.42	3.57	9.58	3.50	9.83	3.38
	22	10.07	3.79	9.92	3.64	9.86	3.59	9.80	3.52	9.71	3.42
	24	9.36	3.83	9.73	3.69	9.88	3.63	9.67	3.58	9.32	3.50
2.0 + 2.0 + 2.0 + 2.5 + 5.0	16	12.04	3.68	11.13	3.56	10.76	3.51	10.34	3.39	9.65	3.19
	18	11.40	3.74	10.61	3.59	9.92	3.53	10.14	3.42	9.88	3.25
	20	10.75	3.76	10.21	3.61	9.99	3.55	9.96	3.47	9.91	3.34
	21	10.31	3.77	9.67	3.63	9.42	3.57	9.58	3.50	9.83	3.38
	22	10.07	3.79	9.92	3.64	9.86	3.59	9.80	3.52	9.71	3.42
	24	9.36	3.83	9.73	3.69	9.88	3.63	9.67	3.58	9.32	3.50
2.0 + 2.0 + 2.0 + 2.5 + 6.0	16	12.04	3.68	11.13	3.56	10.76	3.51	10.34	3.39	9.65	3.19
	18	11.40	3.74	10.61	3.59	9.92	3.53	10.14	3.42	9.88	3.25
	20	10.75	3.76	10.21	3.61	9.99	3.55	9.96	3.47	9.91	3.34
	21	10.31	3.77	9.67	3.63	9.42	3.57	9.58	3.50	9.83	3.38
	22	10.07	3.79	9.92	3.64	9.86	3.59	9.80	3.52	9.71	3.42
	24	9.36	3.83	9.73	3.69	9.88	3.63	9.67	3.58	9.32	3.50

Combination (Capacity)	Indoor Air Temp. °C DB	Outdoor Air Temp. °C											
		16/15		15/14		10/9		7/6		6/5		2/1	
		Total Q	Input Power	Total Q	Input Power	Total Q	Input Power	Total Q	Input Power	Total Q	Input Power	Total Q	Input Power
2.0 + 2.0 + 2.0 + 2.5 + 7.1	16	20.14	2.81	19.73	2.88	17.66	3.24	16.41	3.45	15.61	3.50	12.40	3.70
	18	19.30	2.93	18.87	2.99	16.73	3.33	15.45	3.54	14.70	3.59	11.71	3.78
	20	19.01	3.00	18.51	3.07	16.00	3.41	14.50	3.61	13.79	3.65	10.96	3.79
	21	19.04	3.04	18.48	3.09	15.66	3.34	13.96	3.49	13.28	3.56	10.56	3.81
	22	19.20	3.06	18.67	3.13	16.03	3.47	14.45	3.68	13.58	3.71	10.13	3.83
	24	19.90	3.09	19.09	3.16	15.06	3.52	12.64	3.73	11.96	3.76	9.22	3.87
2.0 + 2.0 + 2.0 + 3.5 + 3.5	16	20.14	2.81	19.73	2.88	17.66	3.24	16.41	3.45	15.61	3.50	12.40	3.70
	18	19.30	2.93	18.87	2.99	16.73	3.33	15.45	3.54	14.70	3.59	11.71	3.78
	20	19.01	3.00	18.51	3.07	16.00	3.41	14.50	3.61	13.79	3.65	10.96	3.79
	21	19.04	3.04	18.48	3.09	15.66	3.34	13.96	3.49	13.28	3.56	10.56	3.81
	22	19.20	3.06	18.67	3.13	16.03	3.47	14.45	3.68	13.58	3.71	10.13	3.83
	24	19.90	3.09	19.09	3.16	15.06	3.52	12.64	3.73	11.96	3.76	9.22	3.87
2.0 + 2.0 + 2.0 + 3.5 + 4.2	16	20.14	2.80	19.73	2.87	17.66	3.23	16.41	3.44	15.61	3.49	12.40	3.69
	18	19.30	2.92	18.87	2.99	16.73	3.32	15.45	3.53	14.70	3.58	11.71	3.77
	20	19.01	3.00	18.51	3.06	16.00	3.40	14.50	3.60	13.79	3.64	10.96	3.78
	21	19.04	3.03	18.48	3.08	15.66	3.33	13.96	3.48	13.28	3.55	10.56	3.80
	22	19.20	3.05	18.67	3.12	16.03	3.46	14.45	3.67	13.58	3.70	10.13	3.82
	24	19.90	3.08	19.09	3.15	15.06	3.51	12.64	3.72	11.96	3.75	9.22	3.86
2.0 + 2.0 + 2.0 + 3.5 + 5.0	16	20.14	2.80	19.73	2.87	17.66	3.23	16.41	3.44	15.61	3.49	12.40	3.69
	18	19.30	2.92	18.87	2.99	16.73	3.32	15.45	3.53	14.70	3.58	11.71	3.77
	20	19.01	3.00	18.51	3.06	16.00	3.40	14.50	3.60	13.79	3.64	10.96	3.78
	21	19.04	3.03	18.48	3.08	15.66	3.33	13.96	3.48	13.28	3.55	10.56	3.80
	22	19.20	3.05	18.67	3.12	16.03	3.46	14.45	3.67	13.58	3.70	10.13	3.82
	24	19.90	3.08	19.09	3.15	15.06	3.51	12.64	3.72	11.96	3.75	9.22	3.86
2.0 + 2.0 + 2.0 + 3.5 + 6.0	16	20.14	2.80	19.73	2.87	17.66	3.23	16.41	3.44	15.61	3.49	12.40	3.69
	18	19.30	2.92	18.87	2.99	16.73	3.32	15.45	3.53	14.70	3.58	11.71	3.77
	20	19.01	3.00	18.51	3.06	16.00	3.40	14.50	3.60	13.79	3.64	10.96	3.78
	21	19.04	3.03	18.48	3.08	15.66	3.33	13.96	3.48	13.28	3.55	10.56	3.80
	22	19.20	3.05	18.67	3.12	16.03	3.46	14.45	3.67	13.58	3.70	10.13	3.82
	24	19.90	3.08	19.09	3.15	15.06	3.51	12.64	3.72	11.96	3.75	9.22	3.86
2.0 + 2.0 + 2.0 + 3.5 + 7.1	16	20.14	2.79	19.73	2.86	17.66	3.22	16.41	3.43	15.61	3.48	12.40	3.68
	18	19.30	2.91	18.87	2.98	16.73	3.32	15.45	3.52	14.70	3.57	11.71	3.76
	20	19.01	2.99	18.51	3.05	16.00	3.39	14.50	3.59	13.79	3.63	10.96	3.77
	21	19.04	3.02	18.48	3.07	15.66	3.32	13.96	3.47	13.28	3.54	10.56	3.79
	22	19.20	3.04	18.67	3.11	16.03	3.45	14.45	3.66	13.58	3.69	10.13	3.81
	24	19.90	3.07	19.09	3.14	15.06	3.50	12.64	3.71	11.96	3.74	9.22	3.84

Combination (Capacity)	Indoor Air Temp. °C DB	Outdoor Air Temp. °C									
		0/-1		-5/-6		-7/-8		-10/-11		-15/-	
		Total Q	Input Power	Total Q	Input Power	Total Q	Input Power	Total Q	Input Power	Total Q	Input Power
2.0 + 2.0 + 2.0 + 2.5 + 7.1	16	12.04	3.66	11.13	3.54	10.76	3.49	10.34	3.37	9.65	3.17
	18	11.40	3.72	10.61	3.57	9.92	3.51	10.14	3.41	9.88	3.23
	20	10.75	3.74	10.21	3.59	9.99	3.53	9.96	3.45	9.91	3.32
	21	10.31	3.75	9.67	3.61	9.42	3.55	9.58	3.48	9.83	3.36
	22	10.07	3.77	9.92	3.62	9.86	3.57	9.80	3.50	9.71	3.40
	24	9.36	3.81	9.73	3.67	9.88	3.61	9.67	3.56	9.32	3.48
2.0 + 2.0 + 2.0 + 3.5 + 3.5	16	12.04	3.66	11.13	3.54	10.76	3.49	10.34	3.37	9.65	3.17
	18	11.40	3.72	10.61	3.57	9.92	3.51	10.14	3.41	9.88	3.23
	20	10.75	3.74	10.21	3.59	9.99	3.53	9.96	3.45	9.91	3.32
	21	10.31	3.75	9.67	3.61	9.42	3.55	9.58	3.48	9.83	3.36
	22	10.07	3.77	9.92	3.62	9.86	3.57	9.80	3.50	9.71	3.40
	24	9.36	3.81	9.73	3.67	9.88	3.61	9.67	3.56	9.32	3.48
2.0 + 2.0 + 2.0 + 3.5 + 4.2	16	12.04	3.65	11.13	3.53	10.76	3.48	10.34	3.36	9.65	3.16
	18	11.40	3.71	10.61	3.56	9.92	3.50	10.14	3.40	9.88	3.22
	20	10.75	3.73	10.21	3.58	9.99	3.52	9.96	3.44	9.91	3.31
	21	10.31	3.74	9.67	3.60	9.42	3.54	9.58	3.47	9.83	3.35
	22	10.07	3.76	9.92	3.61	9.86	3.56	9.80	3.49	9.71	3.39
	24	9.36	3.80	9.73	3.66	9.88	3.60	9.67	3.55	9.32	3.47
2.0 + 2.0 + 2.0 + 3.5 + 5.0	16	12.04	3.65	11.13	3.53	10.76	3.48	10.34	3.36	9.65	3.16
	18	11.40	3.71	10.61	3.56	9.92	3.50	10.14	3.40	9.88	3.22
	20	10.75	3.73	10.21	3.58	9.99	3.52	9.96	3.44	9.91	3.31
	21	10.31	3.74	9.67	3.60	9.42	3.54	9.58	3.47	9.83	3.35
	22	10.07	3.76	9.92	3.61	9.86	3.56	9.80	3.49	9.71	3.39
	24	9.36	3.80	9.73	3.66	9.88	3.60	9.67	3.55	9.32	3.47
2.0 + 2.0 + 2.0 + 3.5 + 6.0	16	12.04	3.65	11.13	3.53	10.76	3.48	10.34	3.36	9.65	3.16
	18	11.40	3.71	10.61	3.56	9.92	3.50	10.14	3.40	9.88	3.22
	20	10.75	3.73	10.21	3.58	9.99	3.52	9.96	3.44	9.91	3.31
	21	10.31	3.74	9.67	3.60	9.42	3.54	9.58	3.47	9.83	3.35
	22	10.07	3.76	9.92	3.61	9.86	3.56	9.80	3.49	9.71	3.39
	24	9.36	3.80	9.73	3.66	9.88	3.60	9.67	3.55	9.32	3.47
2.0 + 2.0 + 2.0 + 3.5 + 7.1	16	12.04	3.64	11.13	3.52	10.76	3.47	10.34	3.35	9.65	3.15
	18	11.40	3.70	10.61	3.55	9.92	3.49	10.14	3.39	9.88	3.21
	20	10.75	3.71	10.21	3.57	9.99	3.51	9.96	3.43	9.91	3.30
	21	10.31	3.73	9.67	3.59	9.42	3.53	9.58	3.46	9.83	3.34
	22	10.07	3.75	9.92	3.60	9.86	3.55	9.80	3.48	9.71	3.38
	24	9.36	3.79	9.73	3.65	9.88	3.59	9.67	3.54	9.32	3.46

Combination (Capacity)	Indoor Air Temp. °C DB	Outdoor Air Temp. °C											
		16/15		15/14		10/9		7/6		6/5		2/1	
		Total Q	Input Power	Total Q	Input Power	Total Q	Input Power	Total Q	Input Power	Total Q	Input Power	Total Q	Input Power
2.0 + 2.0 + 2.0 + 4.2 + 4.2	16	20.14	2.79	19.73	2.86	17.66	3.22	16.41	3.43	15.61	3.48	12.40	3.68
	18	19.30	2.91	18.87	2.98	16.73	3.32	15.45	3.52	14.70	3.57	11.71	3.76
	20	19.01	2.99	18.51	3.05	16.00	3.39	14.50	3.59	13.79	3.63	10.96	3.77
	21	19.04	3.02	18.48	3.07	15.66	3.32	13.96	3.47	13.28	3.54	10.56	3.79
	22	19.20	3.04	18.67	3.11	16.03	3.45	14.45	3.66	13.58	3.69	10.13	3.81
	24	19.90	3.07	19.09	3.14	15.06	3.50	12.64	3.71	11.96	3.74	9.22	3.84
2.0 + 2.0 + 2.0 + 4.2 + 5.0	16	20.14	2.79	19.73	2.86	17.66	3.22	16.41	3.43	15.61	3.48	12.40	3.68
	18	19.30	2.91	18.87	2.98	16.73	3.32	15.45	3.52	14.70	3.57	11.71	3.76
	20	19.01	2.99	18.51	3.05	16.00	3.39	14.50	3.59	13.79	3.63	10.96	3.77
	21	19.04	3.02	18.48	3.07	15.66	3.32	13.96	3.47	13.28	3.54	10.56	3.79
	22	19.20	3.04	18.67	3.11	16.03	3.45	14.45	3.66	13.58	3.69	10.13	3.81
	24	19.90	3.07	19.09	3.14	15.06	3.50	12.64	3.71	11.96	3.74	9.22	3.84
2.0 + 2.0 + 2.0 + 4.2 + 6.0	16	20.14	2.79	19.73	2.86	17.66	3.22	16.41	3.43	15.61	3.48	12.40	3.68
	18	19.30	2.91	18.87	2.98	16.73	3.32	15.45	3.52	14.70	3.57	11.71	3.76
	20	19.01	2.99	18.51	3.05	16.00	3.39	14.50	3.59	13.79	3.63	10.96	3.77
	21	19.04	3.02	18.48	3.07	15.66	3.32	13.96	3.47	13.28	3.54	10.56	3.79
	22	19.20	3.04	18.67	3.11	16.03	3.45	14.45	3.66	13.58	3.69	10.13	3.81
	24	19.90	3.07	19.09	3.14	15.06	3.50	12.64	3.71	11.96	3.74	9.22	3.84
2.0 + 2.0 + 2.0 + 4.2 + 7.1	16	20.14	2.82	19.73	2.90	17.66	3.25	16.41	3.47	15.61	3.52	12.40	3.73
	18	19.30	2.94	18.87	3.01	16.73	3.35	15.45	3.56	14.70	3.61	11.71	3.80
	20	19.01	3.02	18.51	3.09	16.00	3.43	14.50	3.63	13.79	3.67	10.96	3.81
	21	19.04	3.05	18.48	3.10	15.66	3.36	13.96	3.51	13.28	3.58	10.56	3.83
	22	19.20	3.08	18.67	3.15	16.03	3.49	14.45	3.70	13.58	3.73	10.13	3.85
	24	19.90	3.10	19.09	3.18	15.06	3.54	12.64	3.75	11.96	3.78	9.22	3.89
2.0 + 2.0 + 2.0 + 5.0 + 5.0	16	20.14	2.85	19.73	2.92	17.66	3.28	16.41	3.50	15.61	3.55	12.40	3.76
	18	19.30	2.97	18.87	3.04	16.73	3.38	15.45	3.59	14.70	3.64	11.71	3.83
	20	19.01	3.05	18.51	3.11	16.00	3.46	14.50	3.66	13.79	3.70	10.96	3.85
	21	19.04	3.08	18.48	3.13	15.66	3.39	13.96	3.54	13.28	3.60	10.56	3.86
	22	19.20	3.10	18.67	3.17	16.03	3.52	14.45	3.73	13.58	3.76	10.13	3.88
	24	19.90	3.13	19.09	3.20	15.06	3.57	12.64	3.78	11.96	3.81	9.22	3.92
2.0 + 2.0 + 2.0 + 5.0 + 6.0	16	20.14	2.85	19.73	2.92	17.66	3.28	16.41	3.50	15.61	3.55	12.40	3.76
	18	19.30	2.97	18.87	3.04	16.73	3.38	15.45	3.59	14.70	3.64	11.71	3.83
	20	19.01	3.05	18.51	3.11	16.00	3.46	14.50	3.66	13.79	3.70	10.96	3.85
	21	19.04	3.08	18.48	3.13	15.66	3.39	13.96	3.54	13.28	3.60	10.56	3.86
	22	19.20	3.10	18.67	3.17	16.03	3.52	14.45	3.73	13.58	3.76	10.13	3.88
	24	19.90	3.13	19.09	3.20	15.06	3.57	12.64	3.78	11.96	3.81	9.22	3.92

Combination (Capacity)	Indoor Air Temp. °C DB	Outdoor Air Temp. °C									
		0/-1		-5/-6		-7/-8		-10/-11		-15/-	
		Total Q	Input Power	Total Q	Input Power	Total Q	Input Power	Total Q	Input Power	Total Q	Input Power
2.0 + 2.0 + 2.0 + 4.2 + 4.2	16	12.04	3.64	11.13	3.52	10.76	3.47	10.34	3.35	9.65	3.15
	18	11.40	3.70	10.61	3.55	9.92	3.49	10.14	3.39	9.88	3.21
	20	10.75	3.71	10.21	3.57	9.99	3.51	9.96	3.43	9.91	3.30
	21	10.31	3.73	9.67	3.59	9.42	3.53	9.58	3.46	9.83	3.34
	22	10.07	3.75	9.92	3.60	9.86	3.55	9.80	3.48	9.71	3.38
	24	9.36	3.79	9.73	3.65	9.88	3.59	9.67	3.54	9.32	3.46
2.0 + 2.0 + 2.0 + 4.2 + 5.0	16	12.04	3.64	11.13	3.52	10.76	3.47	10.34	3.35	9.65	3.15
	18	11.40	3.70	10.61	3.55	9.92	3.49	10.14	3.39	9.88	3.21
	20	10.75	3.71	10.21	3.57	9.99	3.51	9.96	3.43	9.91	3.30
	21	10.31	3.73	9.67	3.59	9.42	3.53	9.58	3.46	9.83	3.34
	22	10.07	3.75	9.92	3.60	9.86	3.55	9.80	3.48	9.71	3.38
	24	9.36	3.79	9.73	3.65	9.88	3.59	9.67	3.54	9.32	3.46
2.0 + 2.0 + 2.0 + 4.2 + 6.0	16	12.04	3.64	11.13	3.52	10.76	3.47	10.34	3.35	9.65	3.15
	18	11.40	3.70	10.61	3.55	9.92	3.49	10.14	3.39	9.88	3.21
	20	10.75	3.71	10.21	3.57	9.99	3.51	9.96	3.43	9.91	3.30
	21	10.31	3.73	9.67	3.59	9.42	3.53	9.58	3.46	9.83	3.34
	22	10.07	3.75	9.92	3.60	9.86	3.55	9.80	3.48	9.71	3.38
	24	9.36	3.79	9.73	3.65	9.88	3.59	9.67	3.54	9.32	3.46
2.0 + 2.0 + 2.0 + 4.2 + 7.1	16	12.04	3.68	11.13	3.56	10.76	3.51	10.34	3.39	9.65	3.19
	18	11.40	3.74	10.61	3.59	9.92	3.53	10.14	3.42	9.88	3.25
	20	10.75	3.76	10.21	3.61	9.99	3.55	9.96	3.47	9.91	3.34
	21	10.31	3.77	9.67	3.63	9.42	3.57	9.58	3.50	9.83	3.38
	22	10.07	3.79	9.92	3.64	9.86	3.59	9.80	3.52	9.71	3.42
	24	9.36	3.83	9.73	3.69	9.88	3.63	9.67	3.58	9.32	3.50
2.0 + 2.0 + 2.0 + 5.0 + 5.0	16	12.04	3.71	11.13	3.59	10.76	3.54	10.34	3.42	9.65	3.21
	18	11.40	3.77	10.61	3.62	9.92	3.56	10.14	3.45	9.88	3.28
	20	10.75	3.79	10.21	3.64	9.99	3.58	9.96	3.50	9.91	3.37
	21	10.31	3.80	9.67	3.66	9.42	3.60	9.58	3.53	9.83	3.41
	22	10.07	3.82	9.92	3.67	9.86	3.61	9.80	3.55	9.71	3.45
	24	9.36	3.86	9.73	3.72	9.88	3.66	9.67	3.61	9.32	3.53
2.0 + 2.0 + 2.0 + 5.0 + 6.0	16	12.04	3.71	11.13	3.59	10.76	3.54	10.34	3.42	9.65	3.21
	18	11.40	3.77	10.61	3.62	9.92	3.56	10.14	3.45	9.88	3.28
	20	10.75	3.79	10.21	3.64	9.99	3.58	9.96	3.50	9.91	3.37
	21	10.31	3.80	9.67	3.66	9.42	3.60	9.58	3.53	9.83	3.41
	22	10.07	3.82	9.92	3.67	9.86	3.61	9.80	3.55	9.71	3.45
	24	9.36	3.86	9.73	3.72	9.88	3.66	9.67	3.61	9.32	3.53

Combination (Capacity)	Indoor Air Temp. °C DB	Outdoor Air Temp. °C											
		16/15		15/14		10/9		7/6		6/5		2/1	
		Total Q	Input Power	Total Q	Input Power	Total Q	Input Power	Total Q	Input Power	Total Q	Input Power	Total Q	Input Power
2.0 + 2.0 + 2.0 + 5.0 + 7.1	16	20.14	2.84	19.73	2.91	17.66	3.27	16.41	3.49	15.61	3.54	12.40	3.75
	18	19.30	2.96	18.87	3.03	16.73	3.37	15.45	3.58	14.70	3.63	11.71	3.82
	20	19.01	3.04	18.51	3.11	16.00	3.45	14.50	3.65	13.79	3.69	10.96	3.84
	21	19.04	3.07	18.48	3.12	15.66	3.38	13.96	3.53	13.28	3.59	10.56	3.85
	22	19.20	3.09	18.67	3.16	16.03	3.51	14.45	3.72	13.58	3.75	10.13	3.87
	24	19.90	3.12	19.09	3.19	15.06	3.56	12.64	3.77	11.96	3.80	9.22	3.91
2.0 + 2.0 + 2.0 + 6.0 + 6.0	16	20.14	2.85	19.73	2.92	17.66	3.28	16.41	3.50	15.61	3.55	12.40	3.76
	18	19.30	2.97	18.87	3.04	16.73	3.38	15.45	3.59	14.70	3.64	11.71	3.83
	20	19.01	3.05	18.51	3.11	16.00	3.46	14.50	3.66	13.79	3.70	10.96	3.85
	21	19.04	3.08	18.48	3.13	15.66	3.39	13.96	3.54	13.28	3.60	10.56	3.86
	22	19.20	3.10	18.67	3.17	16.03	3.52	14.45	3.73	13.58	3.76	10.13	3.88
	24	19.90	3.13	19.09	3.20	15.06	3.57	12.64	3.78	11.96	3.81	9.22	3.92
2.0 + 2.0 + 2.5 + 2.5 + 2.5	16	20.14	2.86	19.73	2.93	17.66	3.29	16.41	3.51	15.61	3.56	12.40	3.77
	18	19.30	2.97	18.87	3.04	16.73	3.39	15.45	3.60	14.70	3.65	11.71	3.84
	20	19.01	3.05	18.51	3.12	16.00	3.46	14.50	3.67	13.79	3.71	10.96	3.86
	21	19.04	3.09	18.48	3.14	15.66	3.40	13.96	3.55	13.28	3.61	10.56	3.87
	22	19.20	3.11	18.67	3.18	16.03	3.53	14.45	3.74	13.58	3.77	10.13	3.89
	24	19.90	3.14	19.09	3.21	15.06	3.58	12.64	3.79	11.96	3.82	9.22	3.93
2.0 + 2.0 + 2.5 + 2.5 + 3.5	16	20.14	2.83	19.73	2.90	17.66	3.26	16.41	3.48	15.61	3.53	12.40	3.74
	18	19.30	2.95	18.87	3.02	16.73	3.36	15.45	3.57	14.70	3.62	11.71	3.81
	20	19.01	3.03	18.51	3.10	16.00	3.44	14.50	3.64	13.79	3.68	10.96	3.83
	21	19.04	3.06	18.48	3.11	15.66	3.37	13.96	3.52	13.28	3.58	10.56	3.84
	22	19.20	3.08	18.67	3.15	16.03	3.50	14.45	3.71	13.58	3.74	10.13	3.86
	24	19.90	3.11	19.09	3.19	15.06	3.55	12.64	3.76	11.96	3.79	9.22	3.90
2.0 + 2.0 + 2.5 + 2.5 + 4.2	16	20.14	2.82	19.73	2.90	17.66	3.25	16.41	3.47	15.61	3.52	12.40	3.73
	18	19.30	2.94	18.87	3.01	16.73	3.35	15.45	3.56	14.70	3.61	11.71	3.80
	20	19.01	3.02	18.51	3.09	16.00	3.43	14.50	3.63	13.79	3.67	10.96	3.81
	21	19.04	3.05	18.48	3.10	15.66	3.36	13.96	3.51	13.28	3.58	10.56	3.83
	22	19.20	3.08	18.67	3.15	16.03	3.49	14.45	3.70	13.58	3.73	10.13	3.85
	24	19.90	3.10	19.09	3.18	15.06	3.54	12.64	3.75	11.96	3.78	9.22	3.89
2.0 + 2.0 + 2.5 + 2.5 + 5.0	16	20.14	2.82	19.73	2.90	17.66	3.25	16.41	3.47	15.61	3.52	12.40	3.73
	18	19.30	2.94	18.87	3.01	16.73	3.35	15.45	3.56	14.70	3.61	11.71	3.80
	20	19.01	3.02	18.51	3.09	16.00	3.43	14.50	3.63	13.79	3.67	10.96	3.81
	21	19.04	3.05	18.48	3.10	15.66	3.36	13.96	3.51	13.28	3.58	10.56	3.83
	22	19.20	3.08	18.67	3.15	16.03	3.49	14.45	3.70	13.58	3.73	10.13	3.85
	24	19.90	3.10	19.09	3.18	15.06	3.54	12.64	3.75	11.96	3.78	9.22	3.89

Combination (Capacity)	Indoor Air Temp. °C DB	Outdoor Air Temp. °C									
		0/-1		-5/-6		-7/-8		-10/-11		-15/-	
		Total Q	Input Power	Total Q	Input Power	Total Q	Input Power	Total Q	Input Power	Total Q	Input Power
2.0 + 2.0 + 2.0 + 5.0 + 7.1	16	12.04	3.70	11.13	3.58	10.76	3.53	10.34	3.41	9.65	3.21
	18	11.40	3.76	10.61	3.61	9.92	3.55	10.14	3.44	9.88	3.27
	20	10.75	3.78	10.21	3.63	9.99	3.57	9.96	3.49	9.91	3.36
	21	10.31	3.79	9.67	3.65	9.42	3.59	9.58	3.52	9.83	3.40
	22	10.07	3.81	9.92	3.66	9.86	3.61	9.80	3.54	9.71	3.44
	24	9.36	3.85	9.73	3.71	9.88	3.65	9.67	3.60	9.32	3.52
2.0 + 2.0 + 2.0 + 6.0 + 6.0	16	12.04	3.71	11.13	3.59	10.76	3.54	10.34	3.42	9.65	3.21
	18	11.40	3.77	10.61	3.62	9.92	3.56	10.14	3.45	9.88	3.28
	20	10.75	3.79	10.21	3.64	9.99	3.58	9.96	3.50	9.91	3.37
	21	10.31	3.80	9.67	3.66	9.42	3.60	9.58	3.53	9.83	3.41
	22	10.07	3.82	9.92	3.67	9.86	3.61	9.80	3.55	9.71	3.45
	24	9.36	3.86	9.73	3.72	9.88	3.66	9.67	3.61	9.32	3.53
2.0 + 2.0 + 2.5 + 2.5 + 2.5	16	12.04	3.72	11.13	3.60	10.76	3.55	10.34	3.43	9.65	3.22
	18	11.40	3.78	10.61	3.63	9.92	3.57	10.14	3.46	9.88	3.29
	20	10.75	3.80	10.21	3.65	9.99	3.59	9.96	3.51	9.91	3.38
	21	10.31	3.81	9.67	3.67	9.42	3.61	9.58	3.54	9.83	3.42
	22	10.07	3.83	9.92	3.68	9.86	3.62	9.80	3.56	9.71	3.46
	24	9.36	3.87	9.73	3.73	9.88	3.67	9.67	3.62	9.32	3.54
2.0 + 2.0 + 2.5 + 2.5 + 3.5	16	12.04	3.69	11.13	3.57	10.76	3.52	10.34	3.40	9.65	3.20
	18	11.40	3.75	10.61	3.60	9.92	3.54	10.14	3.43	9.88	3.26
	20	10.75	3.77	10.21	3.62	9.99	3.56	9.96	3.48	9.91	3.35
	21	10.31	3.78	9.67	3.64	9.42	3.58	9.58	3.51	9.83	3.39
	22	10.07	3.80	9.92	3.65	9.86	3.60	9.80	3.53	9.71	3.43
	24	9.36	3.84	9.73	3.70	9.88	3.64	9.67	3.59	9.32	3.51
2.0 + 2.0 + 2.5 + 2.5 + 4.2	16	12.04	3.68	11.13	3.56	10.76	3.51	10.34	3.39	9.65	3.19
	18	11.40	3.74	10.61	3.59	9.92	3.53	10.14	3.42	9.88	3.25
	20	10.75	3.76	10.21	3.61	9.99	3.55	9.96	3.47	9.91	3.34
	21	10.31	3.77	9.67	3.63	9.42	3.57	9.58	3.50	9.83	3.38
	22	10.07	3.79	9.92	3.64	9.86	3.59	9.80	3.52	9.71	3.42
	24	9.36	3.83	9.73	3.69	9.88	3.63	9.67	3.58	9.32	3.50
2.0 + 2.0 + 2.5 + 2.5 + 5.0	16	12.04	3.68	11.13	3.56	10.76	3.51	10.34	3.39	9.65	3.19
	18	11.40	3.74	10.61	3.59	9.92	3.53	10.14	3.42	9.88	3.25
	20	10.75	3.76	10.21	3.61	9.99	3.55	9.96	3.47	9.91	3.34
	21	10.31	3.77	9.67	3.63	9.42	3.57	9.58	3.50	9.83	3.38
	22	10.07	3.79	9.92	3.64	9.86	3.59	9.80	3.52	9.71	3.42
	24	9.36	3.83	9.73	3.69	9.88	3.63	9.67	3.58	9.32	3.50

Combination (Capacity)	Indoor Air Temp. °C DB	Outdoor Air Temp. °C											
		16/15		15/14		10/9		7/6		6/5		2/1	
		Total Q	Input Power	Total Q	Input Power	Total Q	Input Power	Total Q	Input Power	Total Q	Input Power	Total Q	Input Power
2.0 + 2.0 + 2.5 + 2.5 + 6.0	16	20.14	2.82	19.73	2.90	17.66	3.25	16.41	3.47	15.61	3.52	12.40	3.73
	18	19.30	2.94	18.87	3.01	16.73	3.35	15.45	3.56	14.70	3.61	11.71	3.80
	20	19.01	3.02	18.51	3.09	16.00	3.43	14.50	3.63	13.79	3.67	10.96	3.81
	21	19.04	3.05	18.48	3.10	15.66	3.36	13.96	3.51	13.28	3.58	10.56	3.83
	22	19.20	3.08	18.67	3.15	16.03	3.49	14.45	3.70	13.58	3.73	10.13	3.85
	24	19.90	3.10	19.09	3.18	15.06	3.54	12.64	3.75	11.96	3.78	9.22	3.89
2.0 + 2.0 + 2.5 + 2.5 + 7.1	16	20.14	2.81	19.73	2.88	17.66	3.24	16.41	3.45	15.61	3.50	12.40	3.70
	18	19.30	2.93	18.87	2.99	16.73	3.33	15.45	3.54	14.70	3.59	11.71	3.78
	20	19.01	3.00	18.51	3.07	16.00	3.41	14.50	3.61	13.79	3.65	10.96	3.79
	21	19.04	3.04	18.48	3.09	15.66	3.34	13.96	3.49	13.28	3.56	10.56	3.81
	22	19.20	3.06	18.67	3.13	16.03	3.47	14.45	3.68	13.58	3.71	10.13	3.83
	24	19.90	3.09	19.09	3.16	15.06	3.52	12.64	3.73	11.96	3.76	9.22	3.87
2.0 + 2.0 + 2.5 + 3.5 + 3.5	16	20.14	2.81	19.73	2.88	17.66	3.24	16.41	3.45	15.61	3.50	12.40	3.70
	18	19.30	2.93	18.87	2.99	16.73	3.33	15.45	3.54	14.70	3.59	11.71	3.78
	20	19.01	3.00	18.51	3.07	16.00	3.41	14.50	3.61	13.79	3.65	10.96	3.79
	21	19.04	3.04	18.48	3.09	15.66	3.34	13.96	3.49	13.28	3.56	10.56	3.81
	22	19.20	3.06	18.67	3.13	16.03	3.47	14.45	3.68	13.58	3.71	10.13	3.83
	24	19.90	3.09	19.09	3.16	15.06	3.52	12.64	3.73	11.96	3.76	9.22	3.87
2.0 + 2.0 + 2.5 + 3.5 + 4.2	16	20.14	2.80	19.73	2.87	17.66	3.23	16.41	3.44	15.61	3.49	12.40	3.69
	18	19.30	2.92	18.87	2.99	16.73	3.32	15.45	3.53	14.70	3.58	11.71	3.77
	20	19.01	3.00	18.51	3.06	16.00	3.40	14.50	3.60	13.79	3.64	10.96	3.78
	21	19.04	3.03	18.48	3.08	15.66	3.33	13.96	3.48	13.28	3.55	10.56	3.80
	22	19.20	3.05	18.67	3.12	16.03	3.46	14.45	3.67	13.58	3.70	10.13	3.82
	24	19.90	3.08	19.09	3.15	15.06	3.51	12.64	3.72	11.96	3.75	9.22	3.86
2.0 + 2.0 + 2.5 + 3.5 + 5.0	16	20.14	2.80	19.73	2.87	17.66	3.23	16.41	3.44	15.61	3.49	12.40	3.69
	18	19.30	2.92	18.87	2.99	16.73	3.32	15.45	3.53	14.70	3.58	11.71	3.77
	20	19.01	3.00	18.51	3.06	16.00	3.40	14.50	3.60	13.79	3.64	10.96	3.78
	21	19.04	3.03	18.48	3.08	15.66	3.33	13.96	3.48	13.28	3.55	10.56	3.80
	22	19.20	3.05	18.67	3.12	16.03	3.46	14.45	3.67	13.58	3.70	10.13	3.82
	24	19.90	3.08	19.09	3.15	15.06	3.51	12.64	3.72	11.96	3.75	9.22	3.86
2.0 + 2.0 + 2.5 + 3.5 + 6.0	16	20.14	2.80	19.73	2.87	17.66	3.23	16.41	3.44	15.61	3.49	12.40	3.69
	18	19.30	2.92	18.87	2.99	16.73	3.32	15.45	3.53	14.70	3.58	11.71	3.77
	20	19.01	3.00	18.51	3.06	16.00	3.40	14.50	3.60	13.79	3.64	10.96	3.78
	21	19.04	3.03	18.48	3.08	15.66	3.33	13.96	3.48	13.28	3.55	10.56	3.80
	22	19.20	3.05	18.67	3.12	16.03	3.46	14.45	3.67	13.58	3.70	10.13	3.82
	24	19.90	3.08	19.09	3.15	15.06	3.51	12.64	3.72	11.96	3.75	9.22	3.86



Combination (Capacity)	Indoor Air Temp. °C DB	Outdoor Air Temp. °C									
		0/-1		-5/-6		-7/-8		-10/-11		-15/-	
		Total Q	Input Power	Total Q	Input Power	Total Q	Input Power	Total Q	Input Power	Total Q	Input Power
2.0 + 2.0 + 2.5 + 2.5 + 6.0	16	12.04	3.68	11.13	3.56	10.76	3.51	10.34	3.39	9.65	3.19
	18	11.40	3.74	10.61	3.59	9.92	3.53	10.14	3.42	9.88	3.25
	20	10.75	3.76	10.21	3.61	9.99	3.55	9.96	3.47	9.91	3.34
	21	10.31	3.77	9.67	3.63	9.42	3.57	9.58	3.50	9.83	3.38
	22	10.07	3.79	9.92	3.64	9.86	3.59	9.80	3.52	9.71	3.42
	24	9.36	3.83	9.73	3.69	9.88	3.63	9.67	3.58	9.32	3.50
2.0 + 2.0 + 2.5 + 2.5 + 7.1	16	12.04	3.66	11.13	3.54	10.76	3.49	10.34	3.37	9.65	3.17
	18	11.40	3.72	10.61	3.57	9.92	3.51	10.14	3.41	9.88	3.23
	20	10.75	3.74	10.21	3.59	9.99	3.53	9.96	3.45	9.91	3.32
	21	10.31	3.75	9.67	3.61	9.42	3.55	9.58	3.48	9.83	3.36
	22	10.07	3.77	9.92	3.62	9.86	3.57	9.80	3.50	9.71	3.40
	24	9.36	3.81	9.73	3.67	9.88	3.61	9.67	3.56	9.32	3.48
2.0 + 2.0 + 2.5 + 3.5 + 3.5	16	12.04	3.66	11.13	3.54	10.76	3.49	10.34	3.37	9.65	3.17
	18	11.40	3.72	10.61	3.57	9.92	3.51	10.14	3.41	9.88	3.23
	20	10.75	3.74	10.21	3.59	9.99	3.53	9.96	3.45	9.91	3.32
	21	10.31	3.75	9.67	3.61	9.42	3.55	9.58	3.48	9.83	3.36
	22	10.07	3.77	9.92	3.62	9.86	3.57	9.80	3.50	9.71	3.40
	24	9.36	3.81	9.73	3.67	9.88	3.61	9.67	3.56	9.32	3.48
2.0 + 2.0 + 2.5 + 3.5 + 4.2	16	12.04	3.65	11.13	3.53	10.76	3.48	10.34	3.36	9.65	3.16
	18	11.40	3.71	10.61	3.56	9.92	3.50	10.14	3.40	9.88	3.22
	20	10.75	3.73	10.21	3.58	9.99	3.52	9.96	3.44	9.91	3.31
	21	10.31	3.74	9.67	3.60	9.42	3.54	9.58	3.47	9.83	3.35
	22	10.07	3.76	9.92	3.61	9.86	3.56	9.80	3.49	9.71	3.39
	24	9.36	3.80	9.73	3.66	9.88	3.60	9.67	3.55	9.32	3.47
2.0 + 2.0 + 2.5 + 3.5 + 5.0	16	12.04	3.65	11.13	3.53	10.76	3.48	10.34	3.36	9.65	3.16
	18	11.40	3.71	10.61	3.56	9.92	3.50	10.14	3.40	9.88	3.22
	20	10.75	3.73	10.21	3.58	9.99	3.52	9.96	3.44	9.91	3.31
	21	10.31	3.74	9.67	3.60	9.42	3.54	9.58	3.47	9.83	3.35
	22	10.07	3.76	9.92	3.61	9.86	3.56	9.80	3.49	9.71	3.39
	24	9.36	3.80	9.73	3.66	9.88	3.60	9.67	3.55	9.32	3.47
2.0 + 2.0 + 2.5 + 3.5 + 6.0	16	12.04	3.65	11.13	3.53	10.76	3.48	10.34	3.36	9.65	3.16
	18	11.40	3.71	10.61	3.56	9.92	3.50	10.14	3.40	9.88	3.22
	20	10.75	3.73	10.21	3.58	9.99	3.52	9.96	3.44	9.91	3.31
	21	10.31	3.74	9.67	3.60	9.42	3.54	9.58	3.47	9.83	3.35
	22	10.07	3.76	9.92	3.61	9.86	3.56	9.80	3.49	9.71	3.39
	24	9.36	3.80	9.73	3.66	9.88	3.60	9.67	3.55	9.32	3.47

Combination (Capacity)	Indoor Air Temp. °C DB	Outdoor Air Temp. °C											
		16/15		15/14		10/9		7/6		6/5		2/1	
		Total Q	Input Power	Total Q	Input Power	Total Q	Input Power	Total Q	Input Power	Total Q	Input Power	Total Q	Input Power
2.0 + 2.0 + 2.5 + 3.5 + 7.1	16	20.14	2.79	19.73	2.86	17.66	3.22	16.41	3.43	15.61	3.48	12.40	3.68
	18	19.30	2.91	18.87	2.98	16.73	3.32	15.45	3.52	14.70	3.57	11.71	3.76
	20	19.01	2.99	18.51	3.05	16.00	3.39	14.50	3.59	13.79	3.63	10.96	3.77
	21	19.04	3.02	18.48	3.07	15.66	3.32	13.96	3.47	13.28	3.54	10.56	3.79
	22	19.20	3.04	18.67	3.11	16.03	3.45	14.45	3.66	13.58	3.69	10.13	3.81
	24	19.90	3.07	19.09	3.14	15.06	3.50	12.64	3.71	11.96	3.74	9.22	3.84
2.0 + 2.0 + 2.5 + 4.2 + 4.2	16	20.14	2.79	19.73	2.86	17.66	3.22	16.41	3.43	15.61	3.48	12.40	3.68
	18	19.30	2.91	18.87	2.98	16.73	3.32	15.45	3.52	14.70	3.57	11.71	3.76
	20	19.01	2.99	18.51	3.05	16.00	3.39	14.50	3.59	13.79	3.63	10.96	3.77
	21	19.04	3.02	18.48	3.07	15.66	3.32	13.96	3.47	13.28	3.54	10.56	3.79
	22	19.20	3.04	18.67	3.11	16.03	3.45	14.45	3.66	13.58	3.69	10.13	3.81
	24	19.90	3.07	19.09	3.14	15.06	3.50	12.64	3.71	11.96	3.74	9.22	3.84
2.0 + 2.0 + 2.5 + 4.2 + 5.0	16	20.14	2.79	19.73	2.86	17.66	3.22	16.41	3.43	15.61	3.48	12.40	3.68
	18	19.30	2.91	18.87	2.98	16.73	3.32	15.45	3.52	14.70	3.57	11.71	3.76
	20	19.01	2.99	18.51	3.05	16.00	3.39	14.50	3.59	13.79	3.63	10.96	3.77
	21	19.04	3.02	18.48	3.07	15.66	3.32	13.96	3.47	13.28	3.54	10.56	3.79
	22	19.20	3.04	18.67	3.11	16.03	3.45	14.45	3.66	13.58	3.69	10.13	3.81
	24	19.90	3.07	19.09	3.14	15.06	3.50	12.64	3.71	11.96	3.74	9.22	3.84
2.0 + 2.0 + 2.5 + 4.2 + 6.0	16	20.14	2.79	19.73	2.86	17.66	3.22	16.41	3.43	15.61	3.48	12.40	3.68
	18	19.30	2.91	18.87	2.98	16.73	3.32	15.45	3.52	14.70	3.57	11.71	3.76
	20	19.01	2.99	18.51	3.05	16.00	3.39	14.50	3.59	13.79	3.63	10.96	3.77
	21	19.04	3.02	18.48	3.07	15.66	3.32	13.96	3.47	13.28	3.54	10.56	3.79
	22	19.20	3.04	18.67	3.11	16.03	3.45	14.45	3.66	13.58	3.69	10.13	3.81
	24	19.90	3.07	19.09	3.14	15.06	3.50	12.64	3.71	11.96	3.74	9.22	3.84
2.0 + 2.0 + 2.5 + 4.2 + 7.1	16	20.14	2.82	19.73	2.90	17.66	3.25	16.41	3.47	15.61	3.52	12.40	3.73
	18	19.30	2.94	18.87	3.01	16.73	3.35	15.45	3.56	14.70	3.61	11.71	3.80
	20	19.01	3.02	18.51	3.09	16.00	3.43	14.50	3.63	13.79	3.67	10.96	3.81
	21	19.04	3.05	18.48	3.10	15.66	3.36	13.96	3.51	13.28	3.58	10.56	3.83
	22	19.20	3.08	18.67	3.15	16.03	3.49	14.45	3.70	13.58	3.73	10.13	3.85
	24	19.90	3.10	19.09	3.18	15.06	3.54	12.64	3.75	11.96	3.78	9.22	3.89
2.0 + 2.0 + 2.5 + 5.0 + 5.0	16	20.14	2.85	19.73	2.92	17.66	3.28	16.41	3.50	15.61	3.55	12.40	3.76
	18	19.30	2.97	18.87	3.04	16.73	3.38	15.45	3.59	14.70	3.64	11.71	3.83
	20	19.01	3.05	18.51	3.11	16.00	3.46	14.50	3.66	13.79	3.70	10.96	3.85
	21	19.04	3.08	18.48	3.13	15.66	3.39	13.96	3.54	13.28	3.60	10.56	3.86
	22	19.20	3.10	18.67	3.17	16.03	3.52	14.45	3.73	13.58	3.76	10.13	3.88
	24	19.90	3.13	19.09	3.20	15.06	3.57	12.64	3.78	11.96	3.81	9.22	3.92

Combination (Capacity)	Indoor Air Temp. °C DB	Outdoor Air Temp. °C									
		0/-1		-5/-6		-7/-8		-10/-11		-15/-	
		Total Q	Input Power	Total Q	Input Power	Total Q	Input Power	Total Q	Input Power	Total Q	Input Power
2.0 + 2.0 + 2.5 + 3.5 + 7.1	16	12.04	3.64	11.13	3.52	10.76	3.47	10.34	3.35	9.65	3.15
	18	11.40	3.70	10.61	3.55	9.92	3.49	10.14	3.39	9.88	3.21
	20	10.75	3.71	10.21	3.57	9.99	3.51	9.96	3.43	9.91	3.30
	21	10.31	3.73	9.67	3.59	9.42	3.53	9.58	3.46	9.83	3.34
	22	10.07	3.75	9.92	3.60	9.86	3.55	9.80	3.48	9.71	3.38
	24	9.36	3.79	9.73	3.65	9.88	3.59	9.67	3.54	9.32	3.46
2.0 + 2.0 + 2.5 + 4.2 + 4.2	16	12.04	3.64	11.13	3.52	10.76	3.47	10.34	3.35	9.65	3.15
	18	11.40	3.70	10.61	3.55	9.92	3.49	10.14	3.39	9.88	3.21
	20	10.75	3.71	10.21	3.57	9.99	3.51	9.96	3.43	9.91	3.30
	21	10.31	3.73	9.67	3.59	9.42	3.53	9.58	3.46	9.83	3.34
	22	10.07	3.75	9.92	3.60	9.86	3.55	9.80	3.48	9.71	3.38
	24	9.36	3.79	9.73	3.65	9.88	3.59	9.67	3.54	9.32	3.46
2.0 + 2.0 + 2.5 + 4.2 + 5.0	16	12.04	3.64	11.13	3.52	10.76	3.47	10.34	3.35	9.65	3.15
	18	11.40	3.70	10.61	3.55	9.92	3.49	10.14	3.39	9.88	3.21
	20	10.75	3.71	10.21	3.57	9.99	3.51	9.96	3.43	9.91	3.30
	21	10.31	3.73	9.67	3.59	9.42	3.53	9.58	3.46	9.83	3.34
	22	10.07	3.75	9.92	3.60	9.86	3.55	9.80	3.48	9.71	3.38
	24	9.36	3.79	9.73	3.65	9.88	3.59	9.67	3.54	9.32	3.46
2.0 + 2.0 + 2.5 + 4.2 + 6.0	16	12.04	3.64	11.13	3.52	10.76	3.47	10.34	3.35	9.65	3.15
	18	11.40	3.70	10.61	3.55	9.92	3.49	10.14	3.39	9.88	3.21
	20	10.75	3.71	10.21	3.57	9.99	3.51	9.96	3.43	9.91	3.30
	21	10.31	3.73	9.67	3.59	9.42	3.53	9.58	3.46	9.83	3.34
	22	10.07	3.75	9.92	3.60	9.86	3.55	9.80	3.48	9.71	3.38
	24	9.36	3.79	9.73	3.65	9.88	3.59	9.67	3.54	9.32	3.46
2.0 + 2.0 + 2.5 + 4.2 + 7.1	16	12.04	3.68	11.13	3.56	10.76	3.51	10.34	3.39	9.65	3.19
	18	11.40	3.74	10.61	3.59	9.92	3.53	10.14	3.42	9.88	3.25
	20	10.75	3.76	10.21	3.61	9.99	3.55	9.96	3.47	9.91	3.34
	21	10.31	3.77	9.67	3.63	9.42	3.57	9.58	3.50	9.83	3.38
	22	10.07	3.79	9.92	3.64	9.86	3.59	9.80	3.52	9.71	3.42
	24	9.36	3.83	9.73	3.69	9.88	3.63	9.67	3.58	9.32	3.50
2.0 + 2.0 + 2.5 + 5.0 + 5.0	16	12.04	3.71	11.13	3.59	10.76	3.54	10.34	3.42	9.65	3.21
	18	11.40	3.77	10.61	3.62	9.92	3.56	10.14	3.45	9.88	3.28
	20	10.75	3.79	10.21	3.64	9.99	3.58	9.96	3.50	9.91	3.37
	21	10.31	3.80	9.67	3.66	9.42	3.60	9.58	3.53	9.83	3.41
	22	10.07	3.82	9.92	3.67	9.86	3.61	9.80	3.55	9.71	3.45
	24	9.36	3.86	9.73	3.72	9.88	3.66	9.67	3.61	9.32	3.53

Combination (Capacity)	Indoor Air Temp. °C DB	Outdoor Air Temp. °C											
		16/15		15/14		10/9		7/6		6/5		2/1	
		Total Q	Input Power	Total Q	Input Power	Total Q	Input Power	Total Q	Input Power	Total Q	Input Power	Total Q	Input Power
2.0 + 2.0 + 2.5 + 5.0 + 6.0	16	20.14	2.85	19.73	2.92	17.66	3.28	16.41	3.50	15.61	3.55	12.40	3.76
	18	19.30	2.97	18.87	3.04	16.73	3.38	15.45	3.59	14.70	3.64	11.71	3.83
	20	19.01	3.05	18.51	3.11	16.00	3.46	14.50	3.66	13.79	3.70	10.96	3.85
	21	19.04	3.08	18.48	3.13	15.66	3.39	13.96	3.54	13.28	3.60	10.56	3.86
	22	19.20	3.10	18.67	3.17	16.03	3.52	14.45	3.73	13.58	3.76	10.13	3.88
	24	19.90	3.13	19.09	3.20	15.06	3.57	12.64	3.78	11.96	3.81	9.22	3.92
2.0 + 2.0 + 3.5 + 3.5 + 3.5	16	20.14	2.83	19.73	2.90	17.66	3.26	16.41	3.48	15.61	3.53	12.40	3.74
	18	19.30	2.95	18.87	3.02	16.73	3.36	15.45	3.57	14.70	3.62	11.71	3.81
	20	19.01	3.03	18.51	3.10	16.00	3.44	14.50	3.64	13.79	3.68	10.96	3.83
	21	19.04	3.06	18.48	3.11	15.66	3.37	13.96	3.52	13.28	3.58	10.56	3.84
	22	19.20	3.08	18.67	3.15	16.03	3.50	14.45	3.71	13.58	3.74	10.13	3.86
	24	19.90	3.11	19.09	3.19	15.06	3.55	12.64	3.76	11.96	3.79	9.22	3.90
2.0 + 2.0 + 3.5 + 3.5 + 4.2	16	20.14	2.82	19.73	2.90	17.66	3.25	16.41	3.47	15.61	3.52	12.40	3.73
	18	19.30	2.94	18.87	3.01	16.73	3.35	15.45	3.56	14.70	3.61	11.71	3.80
	20	19.01	3.02	18.51	3.09	16.00	3.43	14.50	3.63	13.79	3.67	10.96	3.81
	21	19.04	3.05	18.48	3.10	15.66	3.36	13.96	3.51	13.28	3.58	10.56	3.83
	22	19.20	3.08	18.67	3.15	16.03	3.49	14.45	3.70	13.58	3.73	10.13	3.85
	24	19.90	3.10	19.09	3.18	15.06	3.54	12.64	3.75	11.96	3.78	9.22	3.89
2.0 + 2.0 + 3.5 + 3.5 + 5.0	16	20.14	2.82	19.73	2.90	17.66	3.25	16.41	3.47	15.61	3.52	12.40	3.73
	18	19.30	2.94	18.87	3.01	16.73	3.35	15.45	3.56	14.70	3.61	11.71	3.80
	20	19.01	3.02	18.51	3.09	16.00	3.43	14.50	3.63	13.79	3.67	10.96	3.81
	21	19.04	3.05	18.48	3.10	15.66	3.36	13.96	3.51	13.28	3.58	10.56	3.83
	22	19.20	3.08	18.67	3.15	16.03	3.49	14.45	3.70	13.58	3.73	10.13	3.85
	24	19.90	3.10	19.09	3.18	15.06	3.54	12.64	3.75	11.96	3.78	9.22	3.89
2.0 + 2.0 + 3.5 + 3.5 + 6.0	16	20.14	2.82	19.73	2.90	17.66	3.25	16.41	3.47	15.61	3.52	12.40	3.73
	18	19.30	2.94	18.87	3.01	16.73	3.35	15.45	3.56	14.70	3.61	11.71	3.80
	20	19.01	3.02	18.51	3.09	16.00	3.43	14.50	3.63	13.79	3.67	10.96	3.81
	21	19.04	3.05	18.48	3.10	15.66	3.36	13.96	3.51	13.28	3.58	10.56	3.83
	22	19.20	3.08	18.67	3.15	16.03	3.49	14.45	3.70	13.58	3.73	10.13	3.85
	24	19.90	3.10	19.09	3.18	15.06	3.54	12.64	3.75	11.96	3.78	9.22	3.89
2.0 + 2.0 + 3.5 + 3.5 + 7.1	16	20.14	2.82	19.73	2.89	17.66	3.24	16.41	3.46	15.61	3.51	12.40	3.71
	18	19.30	2.93	18.87	3.00	16.73	3.34	15.45	3.55	14.70	3.60	11.71	3.79
	20	19.01	3.01	18.51	3.08	16.00	3.42	14.50	3.62	13.79	3.66	10.96	3.80
	21	19.04	3.05	18.48	3.10	15.66	3.35	13.96	3.50	13.28	3.57	10.56	3.82
	22	19.20	3.07	18.67	3.14	16.03	3.48	14.45	3.69	13.58	3.72	10.13	3.84
	24	19.90	3.10	19.09	3.17	15.06	3.53	12.64	3.74	11.96	3.77	9.22	3.88

Combination (Capacity)	Indoor Air Temp. °C DB	Outdoor Air Temp. °C									
		0/-1		-5/-6		-7/-8		-10/-11		-15/-	
		Total Q	Input Power	Total Q	Input Power	Total Q	Input Power	Total Q	Input Power	Total Q	Input Power
2.0 + 2.0 + 2.5 + 5.0 + 6.0	16	12.04	3.71	11.13	3.59	10.76	3.54	10.34	3.42	9.65	3.21
	18	11.40	3.77	10.61	3.62	9.92	3.56	10.14	3.45	9.88	3.28
	20	10.75	3.79	10.21	3.64	9.99	3.58	9.96	3.50	9.91	3.37
	21	10.31	3.80	9.67	3.66	9.42	3.60	9.58	3.53	9.83	3.41
	22	10.07	3.82	9.92	3.67	9.86	3.61	9.80	3.55	9.71	3.45
	24	9.36	3.86	9.73	3.72	9.88	3.66	9.67	3.61	9.32	3.53
2.0 + 2.0 + 3.5 + 3.5 + 3.5	16	12.04	3.69	11.13	3.57	10.76	3.52	10.34	3.40	9.65	3.20
	18	11.40	3.75	10.61	3.60	9.92	3.54	10.14	3.43	9.88	3.26
	20	10.75	3.77	10.21	3.62	9.99	3.56	9.96	3.48	9.91	3.35
	21	10.31	3.78	9.67	3.64	9.42	3.58	9.58	3.51	9.83	3.39
	22	10.07	3.80	9.92	3.65	9.86	3.60	9.80	3.53	9.71	3.43
	24	9.36	3.84	9.73	3.70	9.88	3.64	9.67	3.59	9.32	3.51
2.0 + 2.0 + 3.5 + 3.5 + 4.2	16	12.04	3.68	11.13	3.56	10.76	3.51	10.34	3.39	9.65	3.19
	18	11.40	3.74	10.61	3.59	9.92	3.53	10.14	3.42	9.88	3.25
	20	10.75	3.76	10.21	3.61	9.99	3.55	9.96	3.47	9.91	3.34
	21	10.31	3.77	9.67	3.63	9.42	3.57	9.58	3.50	9.83	3.38
	22	10.07	3.79	9.92	3.64	9.86	3.59	9.80	3.52	9.71	3.42
	24	9.36	3.83	9.73	3.69	9.88	3.63	9.67	3.58	9.32	3.50
2.0 + 2.0 + 3.5 + 3.5 + 5.0	16	12.04	3.68	11.13	3.56	10.76	3.51	10.34	3.39	9.65	3.19
	18	11.40	3.74	10.61	3.59	9.92	3.53	10.14	3.42	9.88	3.25
	20	10.75	3.76	10.21	3.61	9.99	3.55	9.96	3.47	9.91	3.34
	21	10.31	3.77	9.67	3.63	9.42	3.57	9.58	3.50	9.83	3.38
	22	10.07	3.79	9.92	3.64	9.86	3.59	9.80	3.52	9.71	3.42
	24	9.36	3.83	9.73	3.69	9.88	3.63	9.67	3.58	9.32	3.50
2.0 + 2.0 + 3.5 + 3.5 + 6.0	16	12.04	3.68	11.13	3.56	10.76	3.51	10.34	3.39	9.65	3.19
	18	11.40	3.74	10.61	3.59	9.92	3.53	10.14	3.42	9.88	3.25
	20	10.75	3.76	10.21	3.61	9.99	3.55	9.96	3.47	9.91	3.34
	21	10.31	3.77	9.67	3.63	9.42	3.57	9.58	3.50	9.83	3.38
	22	10.07	3.79	9.92	3.64	9.86	3.59	9.80	3.52	9.71	3.42
	24	9.36	3.83	9.73	3.69	9.88	3.63	9.67	3.58	9.32	3.50
2.0 + 2.0 + 3.5 + 3.5 + 7.1	16	12.04	3.67	11.13	3.55	10.76	3.50	10.34	3.38	9.65	3.18
	18	11.40	3.73	10.61	3.58	9.92	3.52	10.14	3.42	9.88	3.24
	20	10.75	3.75	10.21	3.60	9.99	3.54	9.96	3.46	9.91	3.33
	21	10.31	3.76	9.67	3.62	9.42	3.56	9.58	3.49	9.83	3.37
	22	10.07	3.78	9.92	3.63	9.86	3.58	9.80	3.51	9.71	3.41
	24	9.36	3.82	9.73	3.68	9.88	3.62	9.67	3.57	9.32	3.49

Combination (Capacity)	Indoor Air Temp. °C DB	Outdoor Air Temp. °C											
		16/15		15/14		10/9		7/6		6/5		2/1	
		Total Q	Input Power	Total Q	Input Power	Total Q	Input Power	Total Q	Input Power	Total Q	Input Power	Total Q	Input Power
2.0 + 2.0 + 3.5 + 4.2 + 4.2	16	20.14	2.82	19.73	2.89	17.66	3.24	16.41	3.46	15.61	3.51	12.40	3.71
	18	19.30	2.93	18.87	3.00	16.73	3.34	15.45	3.55	14.70	3.60	11.71	3.79
	20	19.01	3.01	18.51	3.08	16.00	3.42	14.50	3.62	13.79	3.66	10.96	3.80
	21	19.04	3.05	18.48	3.10	15.66	3.35	13.96	3.50	13.28	3.57	10.56	3.82
	22	19.20	3.07	18.67	3.14	16.03	3.48	14.45	3.69	13.58	3.72	10.13	3.84
	24	19.90	3.10	19.09	3.17	15.06	3.53	12.64	3.74	11.96	3.77	9.22	3.88
2.0 + 2.0 + 3.5 + 4.2 + 5.0	16	20.14	2.82	19.73	2.89	17.66	3.24	16.41	3.46	15.61	3.51	12.40	3.71
	18	19.30	2.93	18.87	3.00	16.73	3.34	15.45	3.55	14.70	3.60	11.71	3.79
	20	19.01	3.01	18.51	3.08	16.00	3.42	14.50	3.62	13.79	3.66	10.96	3.80
	21	19.04	3.05	18.48	3.10	15.66	3.35	13.96	3.50	13.28	3.57	10.56	3.82
	22	19.20	3.07	18.67	3.14	16.03	3.48	14.45	3.69	13.58	3.72	10.13	3.84
	24	19.90	3.10	19.09	3.17	15.06	3.53	12.64	3.74	11.96	3.77	9.22	3.88
2.0 + 2.0 + 3.5 + 4.2 + 6.0	16	20.14	2.82	19.73	2.89	17.66	3.24	16.41	3.46	15.61	3.51	12.40	3.71
	18	19.30	2.93	18.87	3.00	16.73	3.34	15.45	3.55	14.70	3.60	11.71	3.79
	20	19.01	3.01	18.51	3.08	16.00	3.42	14.50	3.62	13.79	3.66	10.96	3.80
	21	19.04	3.05	18.48	3.10	15.66	3.35	13.96	3.50	13.28	3.57	10.56	3.82
	22	19.20	3.07	18.67	3.14	16.03	3.48	14.45	3.69	13.58	3.72	10.13	3.84
	24	19.90	3.10	19.09	3.17	15.06	3.53	12.64	3.74	11.96	3.77	9.22	3.88
2.0 + 2.0 + 3.5 + 5.0 + 5.0	16	20.14	2.83	19.73	2.90	17.66	3.26	16.41	3.48	15.61	3.53	12.40	3.74
	18	19.30	2.95	18.87	3.02	16.73	3.36	15.45	3.57	14.70	3.62	11.71	3.81
	20	19.01	3.03	18.51	3.10	16.00	3.44	14.50	3.64	13.79	3.68	10.96	3.83
	21	19.04	3.06	18.48	3.11	15.66	3.37	13.96	3.52	13.28	3.58	10.56	3.84
	22	19.20	3.08	18.67	3.15	16.03	3.50	14.45	3.71	13.58	3.74	10.13	3.86
	24	19.90	3.11	19.09	3.19	15.06	3.55	12.64	3.76	11.96	3.79	9.22	3.90
2.0 + 2.0 + 4.2 + 4.2 + 4.2	16	20.14	2.81	19.73	2.88	17.66	3.24	16.41	3.45	15.61	3.50	12.40	3.70
	18	19.30	2.93	18.87	2.99	16.73	3.33	15.45	3.54	14.70	3.59	11.71	3.78
	20	19.01	3.00	18.51	3.07	16.00	3.41	14.50	3.61	13.79	3.65	10.96	3.79
	21	19.04	3.04	18.48	3.09	15.66	3.34	13.96	3.49	13.28	3.56	10.56	3.81
	22	19.20	3.06	18.67	3.13	16.03	3.47	14.45	3.68	13.58	3.71	10.13	3.83
	24	19.90	3.09	19.09	3.16	15.06	3.52	12.64	3.73	11.96	3.76	9.22	3.87
2.0 + 2.0 + 4.2 + 4.2 + 5.0	16	20.14	2.81	19.73	2.88	17.66	3.24	16.41	3.45	15.61	3.50	12.40	3.70
	18	19.30	2.93	18.87	2.99	16.73	3.33	15.45	3.54	14.70	3.59	11.71	3.78
	20	19.01	3.00	18.51	3.07	16.00	3.41	14.50	3.61	13.79	3.65	10.96	3.79
	21	19.04	3.04	18.48	3.09	15.66	3.34	13.96	3.49	13.28	3.56	10.56	3.81
	22	19.20	3.06	18.67	3.13	16.03	3.47	14.45	3.68	13.58	3.71	10.13	3.83
	24	19.90	3.09	19.09	3.16	15.06	3.52	12.64	3.73	11.96	3.76	9.22	3.87

Combination (Capacity)	Indoor Air Temp. °C DB	Outdoor Air Temp. °C									
		0/-1		-5/-6		-7/-8		-10/-11		-15/-	
		Total Q	Input Power	Total Q	Input Power	Total Q	Input Power	Total Q	Input Power	Total Q	Input Power
2.0 + 2.0 + 3.5 + 4.2 + 4.2	16	12.04	3.67	11.13	3.55	10.76	3.50	10.34	3.38	9.65	3.18
	18	11.40	3.73	10.61	3.58	9.92	3.52	10.14	3.42	9.88	3.24
	20	10.75	3.75	10.21	3.60	9.99	3.54	9.96	3.46	9.91	3.33
	21	10.31	3.76	9.67	3.62	9.42	3.56	9.58	3.49	9.83	3.37
	22	10.07	3.78	9.92	3.63	9.86	3.58	9.80	3.51	9.71	3.41
	24	9.36	3.82	9.73	3.68	9.88	3.62	9.67	3.57	9.32	3.49
2.0 + 2.0 + 3.5 + 4.2 + 5.0	16	12.04	3.67	11.13	3.55	10.76	3.50	10.34	3.38	9.65	3.18
	18	11.40	3.73	10.61	3.58	9.92	3.52	10.14	3.42	9.88	3.24
	20	10.75	3.75	10.21	3.60	9.99	3.54	9.96	3.46	9.91	3.33
	21	10.31	3.76	9.67	3.62	9.42	3.56	9.58	3.49	9.83	3.37
	22	10.07	3.78	9.92	3.63	9.86	3.58	9.80	3.51	9.71	3.41
	24	9.36	3.82	9.73	3.68	9.88	3.62	9.67	3.57	9.32	3.49
2.0 + 2.0 + 3.5 + 4.2 + 6.0	16	12.04	3.67	11.13	3.55	10.76	3.50	10.34	3.38	9.65	3.18
	18	11.40	3.73	10.61	3.58	9.92	3.52	10.14	3.42	9.88	3.24
	20	10.75	3.75	10.21	3.60	9.99	3.54	9.96	3.46	9.91	3.33
	21	10.31	3.76	9.67	3.62	9.42	3.56	9.58	3.49	9.83	3.37
	22	10.07	3.78	9.92	3.63	9.86	3.58	9.80	3.51	9.71	3.41
	24	9.36	3.82	9.73	3.68	9.88	3.62	9.67	3.57	9.32	3.49
2.0 + 2.0 + 3.5 + 5.0 + 5.0	16	12.04	3.69	11.13	3.57	10.76	3.52	10.34	3.40	9.65	3.20
	18	11.40	3.75	10.61	3.60	9.92	3.54	10.14	3.43	9.88	3.26
	20	10.75	3.77	10.21	3.62	9.99	3.56	9.96	3.48	9.91	3.35
	21	10.31	3.78	9.67	3.64	9.42	3.58	9.58	3.51	9.83	3.39
	22	10.07	3.80	9.92	3.65	9.86	3.60	9.80	3.53	9.71	3.43
	24	9.36	3.84	9.73	3.70	9.88	3.64	9.67	3.59	9.32	3.51
2.0 + 2.0 + 4.2 + 4.2 + 4.2	16	12.04	3.66	11.13	3.54	10.76	3.49	10.34	3.37	9.65	3.17
	18	11.40	3.72	10.61	3.57	9.92	3.51	10.14	3.41	9.88	3.23
	20	10.75	3.74	10.21	3.59	9.99	3.53	9.96	3.45	9.91	3.32
	21	10.31	3.75	9.67	3.61	9.42	3.55	9.58	3.48	9.83	3.36
	22	10.07	3.77	9.92	3.62	9.86	3.57	9.80	3.50	9.71	3.40
	24	9.36	3.81	9.73	3.67	9.88	3.61	9.67	3.56	9.32	3.48
2.0 + 2.0 + 4.2 + 4.2 + 5.0	16	12.04	3.66	11.13	3.54	10.76	3.49	10.34	3.37	9.65	3.17
	18	11.40	3.72	10.61	3.57	9.92	3.51	10.14	3.41	9.88	3.23
	20	10.75	3.74	10.21	3.59	9.99	3.53	9.96	3.45	9.91	3.32
	21	10.31	3.75	9.67	3.61	9.42	3.55	9.58	3.48	9.83	3.36
	22	10.07	3.77	9.92	3.62	9.86	3.57	9.80	3.50	9.71	3.40
	24	9.36	3.81	9.73	3.67	9.88	3.61	9.67	3.56	9.32	3.48

Combination (Capacity)	Indoor Air Temp. °C DB	Outdoor Air Temp. °C											
		16/15		15/14		10/9		7/6		6/5		2/1	
		Total Q	Input Power	Total Q	Input Power	Total Q	Input Power	Total Q	Input Power	Total Q	Input Power	Total Q	Input Power
2.0 + 2.0 + 4.2 + 5.0 + 5.0	16	20.14	2.87	19.73	2.94	17.66	3.31	16.41	3.53	15.61	3.58	12.40	3.79
	18	19.30	2.99	18.87	3.06	16.73	3.41	15.45	3.62	14.70	3.66	11.71	3.86
	20	19.01	3.07	18.51	3.14	16.00	3.48	14.50	3.69	13.79	3.73	10.96	3.88
	21	19.04	3.10	18.48	3.16	15.66	3.41	13.96	3.57	13.28	3.63	10.56	3.89
	22	19.20	3.13	18.67	3.20	16.03	3.55	14.45	3.76	13.58	3.79	10.13	3.91
	24	19.90	3.16	19.09	3.23	15.06	3.60	12.64	3.82	11.96	3.84	9.22	3.95
2.0 + 2.5 + 2.5 + 2.5 + 2.5	16	20.14	2.86	19.73	2.93	17.66	3.29	16.41	3.51	15.61	3.56	12.40	3.77
	18	19.30	2.97	18.87	3.04	16.73	3.39	15.45	3.60	14.70	3.65	11.71	3.84
	20	19.01	3.05	18.51	3.12	16.00	3.46	14.50	3.67	13.79	3.71	10.96	3.86
	21	19.04	3.09	18.48	3.14	15.66	3.40	13.96	3.55	13.28	3.61	10.56	3.87
	22	19.20	3.11	18.67	3.18	16.03	3.53	14.45	3.74	13.58	3.77	10.13	3.89
	24	19.90	3.14	19.09	3.21	15.06	3.58	12.64	3.79	11.96	3.82	9.22	3.93
2.0 + 2.5 + 2.5 + 2.5 + 3.5	16	20.14	2.83	19.73	2.90	17.66	3.26	16.41	3.48	15.61	3.53	12.40	3.74
	18	19.30	2.95	18.87	3.02	16.73	3.36	15.45	3.57	14.70	3.62	11.71	3.81
	20	19.01	3.03	18.51	3.10	16.00	3.44	14.50	3.64	13.79	3.68	10.96	3.83
	21	19.04	3.06	18.48	3.11	15.66	3.37	13.96	3.52	13.28	3.58	10.56	3.84
	22	19.20	3.08	18.67	3.15	16.03	3.50	14.45	3.71	13.58	3.74	10.13	3.86
	24	19.90	3.11	19.09	3.19	15.06	3.55	12.64	3.76	11.96	3.79	9.22	3.90
2.0 + 2.5 + 2.5 + 2.5 + 4.2	16	20.14	2.82	19.73	2.90	17.66	3.25	16.41	3.47	15.61	3.52	12.40	3.73
	18	19.30	2.94	18.87	3.01	16.73	3.35	15.45	3.56	14.70	3.61	11.71	3.80
	20	19.01	3.02	18.51	3.09	16.00	3.43	14.50	3.63	13.79	3.67	10.96	3.81
	21	19.04	3.05	18.48	3.10	15.66	3.36	13.96	3.51	13.28	3.58	10.56	3.83
	22	19.20	3.08	18.67	3.15	16.03	3.49	14.45	3.70	13.58	3.73	10.13	3.85
	24	19.90	3.10	19.09	3.18	15.06	3.54	12.64	3.75	11.96	3.78	9.22	3.89
2.0 + 2.5 + 2.5 + 2.5 + 5.0	16	20.14	2.82	19.73	2.90	17.66	3.25	16.41	3.47	15.61	3.52	12.40	3.73
	18	19.30	2.94	18.87	3.01	16.73	3.35	15.45	3.56	14.70	3.61	11.71	3.80
	20	19.01	3.02	18.51	3.09	16.00	3.43	14.50	3.63	13.79	3.67	10.96	3.81
	21	19.04	3.05	18.48	3.10	15.66	3.36	13.96	3.51	13.28	3.58	10.56	3.83
	22	19.20	3.08	18.67	3.15	16.03	3.49	14.45	3.70	13.58	3.73	10.13	3.85
	24	19.90	3.10	19.09	3.18	15.06	3.54	12.64	3.75	11.96	3.78	9.22	3.89
2.0 + 2.5 + 2.5 + 2.5 + 6.0	16	20.14	2.82	19.73	2.90	17.66	3.25	16.41	3.47	15.61	3.52	12.40	3.73
	18	19.30	2.94	18.87	3.01	16.73	3.35	15.45	3.56	14.70	3.61	11.71	3.80
	20	19.01	3.02	18.51	3.09	16.00	3.43	14.50	3.63	13.79	3.67	10.96	3.81
	21	19.04	3.05	18.48	3.10	15.66	3.36	13.96	3.51	13.28	3.58	10.56	3.83
	22	19.20	3.08	18.67	3.15	16.03	3.49	14.45	3.70	13.58	3.73	10.13	3.85
	24	19.90	3.10	19.09	3.18	15.06	3.54	12.64	3.75	11.96	3.78	9.22	3.89



Combination (Capacity)	Indoor Air Temp. °C DB	Outdoor Air Temp. °C									
		0/-1		-5/-6		-7/-8		-10/-11		-15/-	
		Total Q	Input Power	Total Q	Input Power	Total Q	Input Power	Total Q	Input Power	Total Q	Input Power
2.0 + 2.0 + 4.2 + 5.0 + 5.0	16	12.04	3.74	11.13	3.62	10.76	3.57	10.34	3.45	9.65	3.24
	18	11.40	3.80	10.61	3.65	9.92	3.59	10.14	3.48	9.88	3.30
	20	10.75	3.82	10.21	3.67	9.99	3.61	9.96	3.53	9.91	3.39
	21	10.31	3.84	9.67	3.69	9.42	3.63	9.58	3.55	9.83	3.43
	22	10.07	3.85	9.92	3.70	9.86	3.64	9.80	3.58	9.71	3.47
	24	9.36	3.89	9.73	3.75	9.88	3.69	9.67	3.64	9.32	3.56
2.0 + 2.5 + 2.5 + 2.5 + 2.5	16	12.04	3.72	11.13	3.60	10.76	3.55	10.34	3.43	9.65	3.22
	18	11.40	3.78	10.61	3.63	9.92	3.57	10.14	3.46	9.88	3.29
	20	10.75	3.80	10.21	3.65	9.99	3.59	9.96	3.51	9.91	3.38
	21	10.31	3.81	9.67	3.67	9.42	3.61	9.58	3.54	9.83	3.42
	22	10.07	3.83	9.92	3.68	9.86	3.62	9.80	3.56	9.71	3.46
	24	9.36	3.87	9.73	3.73	9.88	3.67	9.67	3.62	9.32	3.54
2.0 + 2.5 + 2.5 + 2.5 + 3.5	16	12.04	3.69	11.13	3.57	10.76	3.52	10.34	3.40	9.65	3.20
	18	11.40	3.75	10.61	3.60	9.92	3.54	10.14	3.43	9.88	3.26
	20	10.75	3.77	10.21	3.62	9.99	3.56	9.96	3.48	9.91	3.35
	21	10.31	3.78	9.67	3.64	9.42	3.58	9.58	3.51	9.83	3.39
	22	10.07	3.80	9.92	3.65	9.86	3.60	9.80	3.53	9.71	3.43
	24	9.36	3.84	9.73	3.70	9.88	3.64	9.67	3.59	9.32	3.51
2.0 + 2.5 + 2.5 + 2.5 + 4.2	16	12.04	3.68	11.13	3.56	10.76	3.51	10.34	3.39	9.65	3.19
	18	11.40	3.74	10.61	3.59	9.92	3.53	10.14	3.42	9.88	3.25
	20	10.75	3.76	10.21	3.61	9.99	3.55	9.96	3.47	9.91	3.34
	21	10.31	3.77	9.67	3.63	9.42	3.57	9.58	3.50	9.83	3.38
	22	10.07	3.79	9.92	3.64	9.86	3.59	9.80	3.52	9.71	3.42
	24	9.36	3.83	9.73	3.69	9.88	3.63	9.67	3.58	9.32	3.50
2.0 + 2.5 + 2.5 + 2.5 + 5.0	16	12.04	3.68	11.13	3.56	10.76	3.51	10.34	3.39	9.65	3.19
	18	11.40	3.74	10.61	3.59	9.92	3.53	10.14	3.42	9.88	3.25
	20	10.75	3.76	10.21	3.61	9.99	3.55	9.96	3.47	9.91	3.34
	21	10.31	3.77	9.67	3.63	9.42	3.57	9.58	3.50	9.83	3.38
	22	10.07	3.79	9.92	3.64	9.86	3.59	9.80	3.52	9.71	3.42
	24	9.36	3.83	9.73	3.69	9.88	3.63	9.67	3.58	9.32	3.50
2.0 + 2.5 + 2.5 + 2.5 + 6.0	16	12.04	3.68	11.13	3.56	10.76	3.51	10.34	3.39	9.65	3.19
	18	11.40	3.74	10.61	3.59	9.92	3.53	10.14	3.42	9.88	3.25
	20	10.75	3.76	10.21	3.61	9.99	3.55	9.96	3.47	9.91	3.34
	21	10.31	3.77	9.67	3.63	9.42	3.57	9.58	3.50	9.83	3.38
	22	10.07	3.79	9.92	3.64	9.86	3.59	9.80	3.52	9.71	3.42
	24	9.36	3.83	9.73	3.69	9.88	3.63	9.67	3.58	9.32	3.50

Combination (Capacity)	Indoor Air Temp. °C DB	Outdoor Air Temp. °C											
		16/15		15/14		10/9		7/6		6/5		2/1	
		Total Q	Input Power	Total Q	Input Power	Total Q	Input Power	Total Q	Input Power	Total Q	Input Power	Total Q	Input Power
2.0 + 2.5 + 2.5 + 2.5 + 7.1	16	20.14	2.81	19.73	2.88	17.66	3.24	16.41	3.45	15.61	3.50	12.40	3.70
	18	19.30	2.93	18.87	2.99	16.73	3.33	15.45	3.54	14.70	3.59	11.71	3.78
	20	19.01	3.00	18.51	3.07	16.00	3.41	14.50	3.61	13.79	3.65	10.96	3.79
	21	19.04	3.04	18.48	3.09	15.66	3.34	13.96	3.49	13.28	3.56	10.56	3.81
	22	19.20	3.06	18.67	3.13	16.03	3.47	14.45	3.68	13.58	3.71	10.13	3.83
	24	19.90	3.09	19.09	3.16	15.06	3.52	12.64	3.73	11.96	3.76	9.22	3.87
2.0 + 2.5 + 2.5 + 3.5 + 3.5	16	20.14	2.81	19.73	2.88	17.66	3.24	16.41	3.45	15.61	3.50	12.40	3.70
	18	19.30	2.93	18.87	2.99	16.73	3.33	15.45	3.54	14.70	3.59	11.71	3.78
	20	19.01	3.00	18.51	3.07	16.00	3.41	14.50	3.61	13.79	3.65	10.96	3.79
	21	19.04	3.04	18.48	3.09	15.66	3.34	13.96	3.49	13.28	3.56	10.56	3.81
	22	19.20	3.06	18.67	3.13	16.03	3.47	14.45	3.68	13.58	3.71	10.13	3.83
	24	19.90	3.09	19.09	3.16	15.06	3.52	12.64	3.73	11.96	3.76	9.22	3.87
2.0 + 2.5 + 2.5 + 3.5 + 4.2	16	20.14	2.80	19.73	2.87	17.66	3.23	16.41	3.44	15.61	3.49	12.40	3.69
	18	19.30	2.92	18.87	2.99	16.73	3.32	15.45	3.53	14.70	3.58	11.71	3.77
	20	19.01	3.00	18.51	3.06	16.00	3.40	14.50	3.60	13.79	3.64	10.96	3.78
	21	19.04	3.03	18.48	3.08	15.66	3.33	13.96	3.48	13.28	3.55	10.56	3.80
	22	19.20	3.05	18.67	3.12	16.03	3.46	14.45	3.67	13.58	3.70	10.13	3.82
	24	19.90	3.08	19.09	3.15	15.06	3.51	12.64	3.72	11.96	3.75	9.22	3.86
2.0 + 2.5 + 2.5 + 3.5 + 5.0	16	20.14	2.80	19.73	2.87	17.66	3.23	16.41	3.44	15.61	3.49	12.40	3.69
	18	19.30	2.92	18.87	2.99	16.73	3.32	15.45	3.53	14.70	3.58	11.71	3.77
	20	19.01	3.00	18.51	3.06	16.00	3.40	14.50	3.60	13.79	3.64	10.96	3.78
	21	19.04	3.03	18.48	3.08	15.66	3.33	13.96	3.48	13.28	3.55	10.56	3.80
	22	19.20	3.05	18.67	3.12	16.03	3.46	14.45	3.67	13.58	3.70	10.13	3.82
	24	19.90	3.08	19.09	3.15	15.06	3.51	12.64	3.72	11.96	3.75	9.22	3.86
2.0 + 2.5 + 2.5 + 3.5 + 6.0	16	20.14	2.80	19.73	2.87	17.66	3.23	16.41	3.44	15.61	3.49	12.40	3.69
	18	19.30	2.92	18.87	2.99	16.73	3.32	15.45	3.53	14.70	3.58	11.71	3.77
	20	19.01	3.00	18.51	3.06	16.00	3.40	14.50	3.60	13.79	3.64	10.96	3.78
	21	19.04	3.03	18.48	3.08	15.66	3.33	13.96	3.48	13.28	3.55	10.56	3.80
	22	19.20	3.05	18.67	3.12	16.03	3.46	14.45	3.67	13.58	3.70	10.13	3.82
	24	19.90	3.08	19.09	3.15	15.06	3.51	12.64	3.72	11.96	3.75	9.22	3.86
2.0 + 2.5 + 2.5 + 3.5 + 7.1	16	20.14	2.79	19.73	2.86	17.66	3.22	16.41	3.43	15.61	3.48	12.40	3.68
	18	19.30	2.91	18.87	2.98	16.73	3.32	15.45	3.52	14.70	3.57	11.71	3.76
	20	19.01	2.99	18.51	3.05	16.00	3.39	14.50	3.59	13.79	3.63	10.96	3.77
	21	19.04	3.02	18.48	3.07	15.66	3.32	13.96	3.47	13.28	3.54	10.56	3.79
	22	19.20	3.04	18.67	3.11	16.03	3.45	14.45	3.66	13.58	3.69	10.13	3.81
	24	19.90	3.07	19.09	3.14	15.06	3.50	12.64	3.71	11.96	3.74	9.22	3.84

Combination (Capacity)	Indoor Air Temp. °C DB	Outdoor Air Temp. °C									
		0/-1		-5/-6		-7/-8		-10/-11		-15/-	
		Total Q	Input Power	Total Q	Input Power	Total Q	Input Power	Total Q	Input Power	Total Q	Input Power
2.0 + 2.5 + 2.5 + 2.5 + 7.1	16	12.04	3.66	11.13	3.54	10.76	3.49	10.34	3.37	9.65	3.17
	18	11.40	3.72	10.61	3.57	9.92	3.51	10.14	3.41	9.88	3.23
	20	10.75	3.74	10.21	3.59	9.99	3.53	9.96	3.45	9.91	3.32
	21	10.31	3.75	9.67	3.61	9.42	3.55	9.58	3.48	9.83	3.36
	22	10.07	3.77	9.92	3.62	9.86	3.57	9.80	3.50	9.71	3.40
	24	9.36	3.81	9.73	3.67	9.88	3.61	9.67	3.56	9.32	3.48
2.0 + 2.5 + 2.5 + 3.5 + 3.5	16	12.04	3.66	11.13	3.54	10.76	3.49	10.34	3.37	9.65	3.17
	18	11.40	3.72	10.61	3.57	9.92	3.51	10.14	3.41	9.88	3.23
	20	10.75	3.74	10.21	3.59	9.99	3.53	9.96	3.45	9.91	3.32
	21	10.31	3.75	9.67	3.61	9.42	3.55	9.58	3.48	9.83	3.36
	22	10.07	3.77	9.92	3.62	9.86	3.57	9.80	3.50	9.71	3.40
	24	9.36	3.81	9.73	3.67	9.88	3.61	9.67	3.56	9.32	3.48
2.0 + 2.5 + 2.5 + 3.5 + 4.2	16	12.04	3.65	11.13	3.53	10.76	3.48	10.34	3.36	9.65	3.16
	18	11.40	3.71	10.61	3.56	9.92	3.50	10.14	3.40	9.88	3.22
	20	10.75	3.73	10.21	3.58	9.99	3.52	9.96	3.44	9.91	3.31
	21	10.31	3.74	9.67	3.60	9.42	3.54	9.58	3.47	9.83	3.35
	22	10.07	3.76	9.92	3.61	9.86	3.56	9.80	3.49	9.71	3.39
	24	9.36	3.80	9.73	3.66	9.88	3.60	9.67	3.55	9.32	3.47
2.0 + 2.5 + 2.5 + 3.5 + 5.0	16	12.04	3.65	11.13	3.53	10.76	3.48	10.34	3.36	9.65	3.16
	18	11.40	3.71	10.61	3.56	9.92	3.50	10.14	3.40	9.88	3.22
	20	10.75	3.73	10.21	3.58	9.99	3.52	9.96	3.44	9.91	3.31
	21	10.31	3.74	9.67	3.60	9.42	3.54	9.58	3.47	9.83	3.35
	22	10.07	3.76	9.92	3.61	9.86	3.56	9.80	3.49	9.71	3.39
	24	9.36	3.80	9.73	3.66	9.88	3.60	9.67	3.55	9.32	3.47
2.0 + 2.5 + 2.5 + 3.5 + 6.0	16	12.04	3.65	11.13	3.53	10.76	3.48	10.34	3.36	9.65	3.16
	18	11.40	3.71	10.61	3.56	9.92	3.50	10.14	3.40	9.88	3.22
	20	10.75	3.73	10.21	3.58	9.99	3.52	9.96	3.44	9.91	3.31
	21	10.31	3.74	9.67	3.60	9.42	3.54	9.58	3.47	9.83	3.35
	22	10.07	3.76	9.92	3.61	9.86	3.56	9.80	3.49	9.71	3.39
	24	9.36	3.80	9.73	3.66	9.88	3.60	9.67	3.55	9.32	3.47
2.0 + 2.5 + 2.5 + 3.5 + 7.1	16	12.04	3.64	11.13	3.52	10.76	3.47	10.34	3.35	9.65	3.15
	18	11.40	3.70	10.61	3.55	9.92	3.49	10.14	3.39	9.88	3.21
	20	10.75	3.71	10.21	3.57	9.99	3.51	9.96	3.43	9.91	3.30
	21	10.31	3.73	9.67	3.59	9.42	3.53	9.58	3.46	9.83	3.34
	22	10.07	3.75	9.92	3.60	9.86	3.55	9.80	3.48	9.71	3.38
	24	9.36	3.79	9.73	3.65	9.88	3.59	9.67	3.54	9.32	3.46

Combination (Capacity)	Indoor Air Temp. °C DB	Outdoor Air Temp. °C											
		16/15		15/14		10/9		7/6		6/5		2/1	
		Total Q	Input Power	Total Q	Input Power	Total Q	Input Power	Total Q	Input Power	Total Q	Input Power	Total Q	Input Power
2.0 + 2.5 + 2.5 + 4.2 + 4.2	16	20.14	2.79	19.73	2.86	17.66	3.22	16.41	3.43	15.61	3.48	12.40	3.68
	18	19.30	2.91	18.87	2.98	16.73	3.32	15.45	3.52	14.70	3.57	11.71	3.76
	20	19.01	2.99	18.51	3.05	16.00	3.39	14.50	3.59	13.79	3.63	10.96	3.77
	21	19.04	3.02	18.48	3.07	15.66	3.32	13.96	3.47	13.28	3.54	10.56	3.79
	22	19.20	3.04	18.67	3.11	16.03	3.45	14.45	3.66	13.58	3.69	10.13	3.81
	24	19.90	3.07	19.09	3.14	15.06	3.50	12.64	3.71	11.96	3.74	9.22	3.84
2.0 + 2.5 + 2.5 + 4.2 + 5.0	16	20.14	2.79	19.73	2.86	17.66	3.22	16.41	3.43	15.61	3.48	12.40	3.68
	18	19.30	2.91	18.87	2.98	16.73	3.32	15.45	3.52	14.70	3.57	11.71	3.76
	20	19.01	2.99	18.51	3.05	16.00	3.39	14.50	3.59	13.79	3.63	10.96	3.77
	21	19.04	3.02	18.48	3.07	15.66	3.32	13.96	3.47	13.28	3.54	10.56	3.79
	22	19.20	3.04	18.67	3.11	16.03	3.45	14.45	3.66	13.58	3.69	10.13	3.81
	24	19.90	3.07	19.09	3.14	15.06	3.50	12.64	3.71	11.96	3.74	9.22	3.84
2.0 + 2.5 + 2.5 + 4.2 + 6.0	16	20.14	2.79	19.73	2.86	17.66	3.22	16.41	3.43	15.61	3.48	12.40	3.68
	18	19.30	2.91	18.87	2.98	16.73	3.32	15.45	3.52	14.70	3.57	11.71	3.76
	20	19.01	2.99	18.51	3.05	16.00	3.39	14.50	3.59	13.79	3.63	10.96	3.77
	21	19.04	3.02	18.48	3.07	15.66	3.32	13.96	3.47	13.28	3.54	10.56	3.79
	22	19.20	3.04	18.67	3.11	16.03	3.45	14.45	3.66	13.58	3.69	10.13	3.81
	24	19.90	3.07	19.09	3.14	15.06	3.50	12.64	3.71	11.96	3.74	9.22	3.84
2.0 + 2.5 + 2.5 + 4.2 + 7.1	16	20.14	2.82	19.73	2.90	17.66	3.25	16.41	3.47	15.61	3.52	12.40	3.73
	18	19.30	2.94	18.87	3.01	16.73	3.35	15.45	3.56	14.70	3.61	11.71	3.80
	20	19.01	3.02	18.51	3.09	16.00	3.43	14.50	3.63	13.79	3.67	10.96	3.81
	21	19.04	3.05	18.48	3.10	15.66	3.36	13.96	3.51	13.28	3.58	10.56	3.83
	22	19.20	3.08	18.67	3.15	16.03	3.49	14.45	3.70	13.58	3.73	10.13	3.85
	24	19.90	3.10	19.09	3.18	15.06	3.54	12.64	3.75	11.96	3.78	9.22	3.89
2.0 + 2.5 + 2.5 + 5.0 + 5.0	16	20.14	2.85	19.73	2.92	17.66	3.28	16.41	3.50	15.61	3.55	12.40	3.76
	18	19.30	2.97	18.87	3.04	16.73	3.38	15.45	3.59	14.70	3.64	11.71	3.83
	20	19.01	3.05	18.51	3.11	16.00	3.46	14.50	3.66	13.79	3.70	10.96	3.85
	21	19.04	3.08	18.48	3.13	15.66	3.39	13.96	3.54	13.28	3.60	10.56	3.86
	22	19.20	3.10	18.67	3.17	16.03	3.52	14.45	3.73	13.58	3.76	10.13	3.88
	24	19.90	3.13	19.09	3.20	15.06	3.57	12.64	3.78	11.96	3.81	9.22	3.92
2.0 + 2.5 + 2.5 + 5.0 + 6.0	16	20.14	2.85	19.73	2.92	17.66	3.28	16.41	3.50	15.61	3.55	12.40	3.76
	18	19.30	2.97	18.87	3.04	16.73	3.38	15.45	3.59	14.70	3.64	11.71	3.83
	20	19.01	3.05	18.51	3.11	16.00	3.46	14.50	3.66	13.79	3.70	10.96	3.85
	21	19.04	3.08	18.48	3.13	15.66	3.39	13.96	3.54	13.28	3.60	10.56	3.86
	22	19.20	3.10	18.67	3.17	16.03	3.52	14.45	3.73	13.58	3.76	10.13	3.88
	24	19.90	3.13	19.09	3.20	15.06	3.57	12.64	3.78	11.96	3.81	9.22	3.92

Combination (Capacity)	Indoor Air Temp. °C DB	Outdoor Air Temp. °C									
		0/-1		-5/-6		-7/-8		-10/-11		-15/-	
		Total Q	Input Power	Total Q	Input Power	Total Q	Input Power	Total Q	Input Power	Total Q	Input Power
2.0 + 2.5 + 2.5 + 4.2 + 4.2	16	12.04	3.64	11.13	3.52	10.76	3.47	10.34	3.35	9.65	3.15
	18	11.40	3.70	10.61	3.55	9.92	3.49	10.14	3.39	9.88	3.21
	20	10.75	3.71	10.21	3.57	9.99	3.51	9.96	3.43	9.91	3.30
	21	10.31	3.73	9.67	3.59	9.42	3.53	9.58	3.46	9.83	3.34
	22	10.07	3.75	9.92	3.60	9.86	3.55	9.80	3.48	9.71	3.38
	24	9.36	3.79	9.73	3.65	9.88	3.59	9.67	3.54	9.32	3.46
2.0 + 2.5 + 2.5 + 4.2 + 5.0	16	12.04	3.64	11.13	3.52	10.76	3.47	10.34	3.35	9.65	3.15
	18	11.40	3.70	10.61	3.55	9.92	3.49	10.14	3.39	9.88	3.21
	20	10.75	3.71	10.21	3.57	9.99	3.51	9.96	3.43	9.91	3.30
	21	10.31	3.73	9.67	3.59	9.42	3.53	9.58	3.46	9.83	3.34
	22	10.07	3.75	9.92	3.60	9.86	3.55	9.80	3.48	9.71	3.38
	24	9.36	3.79	9.73	3.65	9.88	3.59	9.67	3.54	9.32	3.46
2.0 + 2.5 + 2.5 + 4.2 + 6.0	16	12.04	3.64	11.13	3.52	10.76	3.47	10.34	3.35	9.65	3.15
	18	11.40	3.70	10.61	3.55	9.92	3.49	10.14	3.39	9.88	3.21
	20	10.75	3.71	10.21	3.57	9.99	3.51	9.96	3.43	9.91	3.30
	21	10.31	3.73	9.67	3.59	9.42	3.53	9.58	3.46	9.83	3.34
	22	10.07	3.75	9.92	3.60	9.86	3.55	9.80	3.48	9.71	3.38
	24	9.36	3.79	9.73	3.65	9.88	3.59	9.67	3.54	9.32	3.46
2.0 + 2.5 + 2.5 + 4.2 + 7.1	16	12.04	3.68	11.13	3.56	10.76	3.51	10.34	3.39	9.65	3.19
	18	11.40	3.74	10.61	3.59	9.92	3.53	10.14	3.42	9.88	3.25
	20	10.75	3.76	10.21	3.61	9.99	3.55	9.96	3.47	9.91	3.34
	21	10.31	3.77	9.67	3.63	9.42	3.57	9.58	3.50	9.83	3.38
	22	10.07	3.79	9.92	3.64	9.86	3.59	9.80	3.52	9.71	3.42
	24	9.36	3.83	9.73	3.69	9.88	3.63	9.67	3.58	9.32	3.50
2.0 + 2.5 + 2.5 + 5.0 + 5.0	16	12.04	3.71	11.13	3.59	10.76	3.54	10.34	3.42	9.65	3.21
	18	11.40	3.77	10.61	3.62	9.92	3.56	10.14	3.45	9.88	3.28
	20	10.75	3.79	10.21	3.64	9.99	3.58	9.96	3.50	9.91	3.37
	21	10.31	3.80	9.67	3.66	9.42	3.60	9.58	3.53	9.83	3.41
	22	10.07	3.82	9.92	3.67	9.86	3.61	9.80	3.55	9.71	3.45
	24	9.36	3.86	9.73	3.72	9.88	3.66	9.67	3.61	9.32	3.53
2.0 + 2.5 + 2.5 + 5.0 + 6.0	16	12.04	3.71	11.13	3.59	10.76	3.54	10.34	3.42	9.65	3.21
	18	11.40	3.77	10.61	3.62	9.92	3.56	10.14	3.45	9.88	3.28
	20	10.75	3.79	10.21	3.64	9.99	3.58	9.96	3.50	9.91	3.37
	21	10.31	3.80	9.67	3.66	9.42	3.60	9.58	3.53	9.83	3.41
	22	10.07	3.82	9.92	3.67	9.86	3.61	9.80	3.55	9.71	3.45
	24	9.36	3.86	9.73	3.72	9.88	3.66	9.67	3.61	9.32	3.53

Combination (Capacity)	Indoor Air Temp. °C DB	Outdoor Air Temp. °C											
		16/15		15/14		10/9		7/6		6/5		2/1	
		Total Q	Input Power	Total Q	Input Power	Total Q	Input Power	Total Q	Input Power	Total Q	Input Power	Total Q	Input Power
2.0 + 2.5 + 3.5 + 3.5 + 3.5	16	20.14	2.83	19.73	2.90	17.66	3.26	16.41	3.48	15.61	3.53	12.40	3.74
	18	19.30	2.95	18.87	3.02	16.73	3.36	15.45	3.57	14.70	3.62	11.71	3.81
	20	19.01	3.03	18.51	3.10	16.00	3.44	14.50	3.64	13.79	3.68	10.96	3.83
	21	19.04	3.06	18.48	3.11	15.66	3.37	13.96	3.52	13.28	3.58	10.56	3.84
	22	19.20	3.08	18.67	3.15	16.03	3.50	14.45	3.71	13.58	3.74	10.13	3.86
	24	19.90	3.11	19.09	3.19	15.06	3.55	12.64	3.76	11.96	3.79	9.22	3.90
2.0 + 2.5 + 3.5 + 3.5 + 4.2	16	20.14	2.82	19.73	2.90	17.66	3.25	16.41	3.47	15.61	3.52	12.40	3.73
	18	19.30	2.94	18.87	3.01	16.73	3.35	15.45	3.56	14.70	3.61	11.71	3.80
	20	19.01	3.02	18.51	3.09	16.00	3.43	14.50	3.63	13.79	3.67	10.96	3.81
	21	19.04	3.05	18.48	3.10	15.66	3.36	13.96	3.51	13.28	3.58	10.56	3.83
	22	19.20	3.08	18.67	3.15	16.03	3.49	14.45	3.70	13.58	3.73	10.13	3.85
	24	19.90	3.10	19.09	3.18	15.06	3.54	12.64	3.75	11.96	3.78	9.22	3.89
2.0 + 2.5 + 3.5 + 3.5 + 5.0	16	20.14	2.82	19.73	2.90	17.66	3.25	16.41	3.47	15.61	3.52	12.40	3.73
	18	19.30	2.94	18.87	3.01	16.73	3.35	15.45	3.56	14.70	3.61	11.71	3.80
	20	19.01	3.02	18.51	3.09	16.00	3.43	14.50	3.63	13.79	3.67	10.96	3.81
	21	19.04	3.05	18.48	3.10	15.66	3.36	13.96	3.51	13.28	3.58	10.56	3.83
	22	19.20	3.08	18.67	3.15	16.03	3.49	14.45	3.70	13.58	3.73	10.13	3.85
	24	19.90	3.10	19.09	3.18	15.06	3.54	12.64	3.75	11.96	3.78	9.22	3.89
2.0 + 2.5 + 3.5 + 3.5 + 6.0	16	20.14	2.82	19.73	2.90	17.66	3.25	16.41	3.47	15.61	3.52	12.40	3.73
	18	19.30	2.94	18.87	3.01	16.73	3.35	15.45	3.56	14.70	3.61	11.71	3.80
	20	19.01	3.02	18.51	3.09	16.00	3.43	14.50	3.63	13.79	3.67	10.96	3.81
	21	19.04	3.05	18.48	3.10	15.66	3.36	13.96	3.51	13.28	3.58	10.56	3.83
	22	19.20	3.08	18.67	3.15	16.03	3.49	14.45	3.70	13.58	3.73	10.13	3.85
	24	19.90	3.10	19.09	3.18	15.06	3.54	12.64	3.75	11.96	3.78	9.22	3.89
2.0 + 2.5 + 3.5 + 4.2 + 4.2	16	20.14	2.82	19.73	2.89	17.66	3.24	16.41	3.46	15.61	3.51	12.40	3.71
	18	19.30	2.93	18.87	3.00	16.73	3.34	15.45	3.55	14.70	3.60	11.71	3.79
	20	19.01	3.01	18.51	3.08	16.00	3.42	14.50	3.62	13.79	3.66	10.96	3.80
	21	19.04	3.05	18.48	3.10	15.66	3.35	13.96	3.50	13.28	3.57	10.56	3.82
	22	19.20	3.07	18.67	3.14	16.03	3.48	14.45	3.69	13.58	3.72	10.13	3.84
	24	19.90	3.10	19.09	3.17	15.06	3.53	12.64	3.74	11.96	3.77	9.22	3.88
2.0 + 2.5 + 3.5 + 4.2 + 5.0	16	20.14	2.82	19.73	2.89	17.66	3.24	16.41	3.46	15.61	3.51	12.40	3.71
	18	19.30	2.93	18.87	3.00	16.73	3.34	15.45	3.55	14.70	3.60	11.71	3.79
	20	19.01	3.01	18.51	3.08	16.00	3.42	14.50	3.62	13.79	3.66	10.96	3.80
	21	19.04	3.05	18.48	3.10	15.66	3.35	13.96	3.50	13.28	3.57	10.56	3.82
	22	19.20	3.07	18.67	3.14	16.03	3.48	14.45	3.69	13.58	3.72	10.13	3.84
	24	19.90	3.10	19.09	3.17	15.06	3.53	12.64	3.74	11.96	3.77	9.22	3.88

Combination (Capacity)	Indoor Air Temp. °C DB	Outdoor Air Temp. °C									
		0/-1		-5/-6		-7/-8		-10/-11		-15/-	
		Total Q	Input Power	Total Q	Input Power	Total Q	Input Power	Total Q	Input Power	Total Q	Input Power
2.0 + 2.5 + 3.5 + 3.5 + 3.5	16	12.04	3.69	11.13	3.57	10.76	3.52	10.34	3.40	9.65	3.20
	18	11.40	3.75	10.61	3.60	9.92	3.54	10.14	3.43	9.88	3.26
	20	10.75	3.77	10.21	3.62	9.99	3.56	9.96	3.48	9.91	3.35
	21	10.31	3.78	9.67	3.64	9.42	3.58	9.58	3.51	9.83	3.39
	22	10.07	3.80	9.92	3.65	9.86	3.60	9.80	3.53	9.71	3.43
	24	9.36	3.84	9.73	3.70	9.88	3.64	9.67	3.59	9.32	3.51
2.0 + 2.5 + 3.5 + 3.5 + 4.2	16	12.04	3.68	11.13	3.56	10.76	3.51	10.34	3.39	9.65	3.19
	18	11.40	3.74	10.61	3.59	9.92	3.53	10.14	3.42	9.88	3.25
	20	10.75	3.76	10.21	3.61	9.99	3.55	9.96	3.47	9.91	3.34
	21	10.31	3.77	9.67	3.63	9.42	3.57	9.58	3.50	9.83	3.38
	22	10.07	3.79	9.92	3.64	9.86	3.59	9.80	3.52	9.71	3.42
	24	9.36	3.83	9.73	3.69	9.88	3.63	9.67	3.58	9.32	3.50
2.0 + 2.5 + 3.5 + 3.5 + 5.0	16	12.04	3.68	11.13	3.56	10.76	3.51	10.34	3.39	9.65	3.19
	18	11.40	3.74	10.61	3.59	9.92	3.53	10.14	3.42	9.88	3.25
	20	10.75	3.76	10.21	3.61	9.99	3.55	9.96	3.47	9.91	3.34
	21	10.31	3.77	9.67	3.63	9.42	3.57	9.58	3.50	9.83	3.38
	22	10.07	3.79	9.92	3.64	9.86	3.59	9.80	3.52	9.71	3.42
	24	9.36	3.83	9.73	3.69	9.88	3.63	9.67	3.58	9.32	3.50
2.0 + 2.5 + 3.5 + 3.5 + 6.0	16	12.04	3.68	11.13	3.56	10.76	3.51	10.34	3.39	9.65	3.19
	18	11.40	3.74	10.61	3.59	9.92	3.53	10.14	3.42	9.88	3.25
	20	10.75	3.76	10.21	3.61	9.99	3.55	9.96	3.47	9.91	3.34
	21	10.31	3.77	9.67	3.63	9.42	3.57	9.58	3.50	9.83	3.38
	22	10.07	3.79	9.92	3.64	9.86	3.59	9.80	3.52	9.71	3.42
	24	9.36	3.83	9.73	3.69	9.88	3.63	9.67	3.58	9.32	3.50
2.0 + 2.5 + 3.5 + 4.2 + 4.2	16	12.04	3.67	11.13	3.55	10.76	3.50	10.34	3.38	9.65	3.18
	18	11.40	3.73	10.61	3.58	9.92	3.52	10.14	3.42	9.88	3.24
	20	10.75	3.75	10.21	3.60	9.99	3.54	9.96	3.46	9.91	3.33
	21	10.31	3.76	9.67	3.62	9.42	3.56	9.58	3.49	9.83	3.37
	22	10.07	3.78	9.92	3.63	9.86	3.58	9.80	3.51	9.71	3.41
	24	9.36	3.82	9.73	3.68	9.88	3.62	9.67	3.57	9.32	3.49
2.0 + 2.5 + 3.5 + 4.2 + 5.0	16	12.04	3.67	11.13	3.55	10.76	3.50	10.34	3.38	9.65	3.18
	18	11.40	3.73	10.61	3.58	9.92	3.52	10.14	3.42	9.88	3.24
	20	10.75	3.75	10.21	3.60	9.99	3.54	9.96	3.46	9.91	3.33
	21	10.31	3.76	9.67	3.62	9.42	3.56	9.58	3.49	9.83	3.37
	22	10.07	3.78	9.92	3.63	9.86	3.58	9.80	3.51	9.71	3.41
	24	9.36	3.82	9.73	3.68	9.88	3.62	9.67	3.57	9.32	3.49

Combination (Capacity)	Indoor Air Temp. °C DB	Outdoor Air Temp. °C											
		16/15		15/14		10/9		7/6		6/5		2/1	
		Total Q	Input Power	Total Q	Input Power	Total Q	Input Power	Total Q	Input Power	Total Q	Input Power	Total Q	Input Power
2.0 + 2.5 + 3.5 + 4.2 + 6.0	16	20.14	2.82	19.73	2.89	17.66	3.24	16.41	3.46	15.61	3.51	12.40	3.71
	18	19.30	2.93	18.87	3.00	16.73	3.34	15.45	3.55	14.70	3.60	11.71	3.79
	20	19.01	3.01	18.51	3.08	16.00	3.42	14.50	3.62	13.79	3.66	10.96	3.80
	21	19.04	3.05	18.48	3.10	15.66	3.35	13.96	3.50	13.28	3.57	10.56	3.82
	22	19.20	3.07	18.67	3.14	16.03	3.48	14.45	3.69	13.58	3.72	10.13	3.84
	24	19.90	3.10	19.09	3.17	15.06	3.53	12.64	3.74	11.96	3.77	9.22	3.88
2.0 + 2.5 + 3.5 + 5.0 + 5.0	16	20.14	2.83	19.73	2.90	17.66	3.26	16.41	3.48	15.61	3.53	12.40	3.74
	18	19.30	2.95	18.87	3.02	16.73	3.36	15.45	3.57	14.70	3.62	11.71	3.81
	20	19.01	3.03	18.51	3.10	16.00	3.44	14.50	3.64	13.79	3.68	10.96	3.83
	21	19.04	3.06	18.48	3.11	15.66	3.37	13.96	3.52	13.28	3.58	10.56	3.84
	22	19.20	3.08	18.67	3.15	16.03	3.50	14.45	3.71	13.58	3.74	10.13	3.86
	24	19.90	3.11	19.09	3.19	15.06	3.55	12.64	3.76	11.96	3.79	9.22	3.90
2.0 + 2.5 + 4.2 + 4.2 + 4.2	16	20.14	2.81	19.73	2.88	17.66	3.24	16.41	3.45	15.61	3.50	12.40	3.70
	18	19.30	2.93	18.87	2.99	16.73	3.33	15.45	3.54	14.70	3.59	11.71	3.78
	20	19.01	3.00	18.51	3.07	16.00	3.41	14.50	3.61	13.79	3.65	10.96	3.79
	21	19.04	3.04	18.48	3.09	15.66	3.34	13.96	3.49	13.28	3.56	10.56	3.81
	22	19.20	3.06	18.67	3.13	16.03	3.47	14.45	3.68	13.58	3.71	10.13	3.83
	24	19.90	3.09	19.09	3.16	15.06	3.52	12.64	3.73	11.96	3.76	9.22	3.87
2.0 + 2.5 + 4.2 + 4.2 + 5.0	16	20.14	2.81	19.73	2.88	17.66	3.24	16.41	3.45	15.61	3.50	12.40	3.70
	18	19.30	2.93	18.87	2.99	16.73	3.33	15.45	3.54	14.70	3.59	11.71	3.78
	20	19.01	3.00	18.51	3.07	16.00	3.41	14.50	3.61	13.79	3.65	10.96	3.79
	21	19.04	3.04	18.48	3.09	15.66	3.34	13.96	3.49	13.28	3.56	10.56	3.81
	22	19.20	3.06	18.67	3.13	16.03	3.47	14.45	3.68	13.58	3.71	10.13	3.83
	24	19.90	3.09	19.09	3.16	15.06	3.52	12.64	3.73	11.96	3.76	9.22	3.87
2.0 + 3.5 + 3.5 + 3.5 + 3.5	16	20.14	2.81	19.73	2.88	17.66	3.24	16.41	3.45	15.61	3.50	12.40	3.70
	18	19.30	2.93	18.87	2.99	16.73	3.33	15.45	3.54	14.70	3.59	11.71	3.78
	20	19.01	3.00	18.51	3.07	16.00	3.41	14.50	3.61	13.79	3.65	10.96	3.79
	21	19.04	3.04	18.48	3.09	15.66	3.34	13.96	3.49	13.28	3.56	10.56	3.81
	22	19.20	3.06	18.67	3.13	16.03	3.47	14.45	3.68	13.58	3.71	10.13	3.83
	24	19.90	3.09	19.09	3.16	15.06	3.52	12.64	3.73	11.96	3.76	9.22	3.87
2.0 + 3.5 + 3.5 + 3.5 + 4.2	16	20.14	2.80	19.73	2.87	17.66	3.23	16.41	3.44	15.61	3.49	12.40	3.69
	18	19.30	2.92	18.87	2.99	16.73	3.32	15.45	3.53	14.70	3.58	11.71	3.77
	20	19.01	3.00	18.51	3.06	16.00	3.40	14.50	3.60	13.79	3.64	10.96	3.78
	21	19.04	3.03	18.48	3.08	15.66	3.33	13.96	3.48	13.28	3.55	10.56	3.80
	22	19.20	3.05	18.67	3.12	16.03	3.46	14.45	3.67	13.58	3.70	10.13	3.82
	24	19.90	3.08	19.09	3.15	15.06	3.51	12.64	3.72	11.96	3.75	9.22	3.86



Combination (Capacity)	Indoor Air Temp. °C DB	Outdoor Air Temp. °C									
		0/-1		-5/-6		-7/-8		-10/-11		-15/-	
		Total Q	Input Power	Total Q	Input Power	Total Q	Input Power	Total Q	Input Power	Total Q	Input Power
2.0 + 2.5 + 3.5 + 4.2 + 6.0	16	12.04	3.67	11.13	3.55	10.76	3.50	10.34	3.38	9.65	3.18
	18	11.40	3.73	10.61	3.58	9.92	3.52	10.14	3.42	9.88	3.24
	20	10.75	3.75	10.21	3.60	9.99	3.54	9.96	3.46	9.91	3.33
	21	10.31	3.76	9.67	3.62	9.42	3.56	9.58	3.49	9.83	3.37
	22	10.07	3.78	9.92	3.63	9.86	3.58	9.80	3.51	9.71	3.41
	24	9.36	3.82	9.73	3.68	9.88	3.62	9.67	3.57	9.32	3.49
2.0 + 2.5 + 3.5 + 5.0 + 5.0	16	12.04	3.69	11.13	3.57	10.76	3.52	10.34	3.40	9.65	3.20
	18	11.40	3.75	10.61	3.60	9.92	3.54	10.14	3.43	9.88	3.26
	20	10.75	3.77	10.21	3.62	9.99	3.56	9.96	3.48	9.91	3.35
	21	10.31	3.78	9.67	3.64	9.42	3.58	9.58	3.51	9.83	3.39
	22	10.07	3.80	9.92	3.65	9.86	3.60	9.80	3.53	9.71	3.43
	24	9.36	3.84	9.73	3.70	9.88	3.64	9.67	3.59	9.32	3.51
2.0 + 2.5 + 4.2 + 4.2 + 4.2	16	12.04	3.66	11.13	3.54	10.76	3.49	10.34	3.37	9.65	3.17
	18	11.40	3.72	10.61	3.57	9.92	3.51	10.14	3.41	9.88	3.23
	20	10.75	3.74	10.21	3.59	9.99	3.53	9.96	3.45	9.91	3.32
	21	10.31	3.75	9.67	3.61	9.42	3.55	9.58	3.48	9.83	3.36
	22	10.07	3.77	9.92	3.62	9.86	3.57	9.80	3.50	9.71	3.40
	24	9.36	3.81	9.73	3.67	9.88	3.61	9.67	3.56	9.32	3.48
2.0 + 2.5 + 4.2 + 4.2 + 5.0	16	12.04	3.66	11.13	3.54	10.76	3.49	10.34	3.37	9.65	3.17
	18	11.40	3.72	10.61	3.57	9.92	3.51	10.14	3.41	9.88	3.23
	20	10.75	3.74	10.21	3.59	9.99	3.53	9.96	3.45	9.91	3.32
	21	10.31	3.75	9.67	3.61	9.42	3.55	9.58	3.48	9.83	3.36
	22	10.07	3.77	9.92	3.62	9.86	3.57	9.80	3.50	9.71	3.40
	24	9.36	3.81	9.73	3.67	9.88	3.61	9.67	3.56	9.32	3.48
2.0 + 3.5 + 3.5 + 3.5 + 3.5	16	12.04	3.66	11.13	3.54	10.76	3.49	10.34	3.37	9.65	3.17
	18	11.40	3.72	10.61	3.57	9.92	3.51	10.14	3.41	9.88	3.23
	20	10.75	3.74	10.21	3.59	9.99	3.53	9.96	3.45	9.91	3.32
	21	10.31	3.75	9.67	3.61	9.42	3.55	9.58	3.48	9.83	3.36
	22	10.07	3.77	9.92	3.62	9.86	3.57	9.80	3.50	9.71	3.40
	24	9.36	3.81	9.73	3.67	9.88	3.61	9.67	3.56	9.32	3.48
2.0 + 3.5 + 3.5 + 3.5 + 4.2	16	12.04	3.65	11.13	3.53	10.76	3.48	10.34	3.36	9.65	3.16
	18	11.40	3.71	10.61	3.56	9.92	3.50	10.14	3.40	9.88	3.22
	20	10.75	3.73	10.21	3.58	9.99	3.52	9.96	3.44	9.91	3.31
	21	10.31	3.74	9.67	3.60	9.42	3.54	9.58	3.47	9.83	3.35
	22	10.07	3.76	9.92	3.61	9.86	3.56	9.80	3.49	9.71	3.39
	24	9.36	3.80	9.73	3.66	9.88	3.60	9.67	3.55	9.32	3.47

Combination (Capacity)	Indoor Air Temp. °C DB	Outdoor Air Temp. °C											
		16/15		15/14		10/9		7/6		6/5		2/1	
		Total Q	Input Power	Total Q	Input Power	Total Q	Input Power	Total Q	Input Power	Total Q	Input Power	Total Q	Input Power
2.0 + 3.5 + 3.5 + 3.5 + 5.0	16	20.14	2.81	19.73	2.88	17.66	3.24	16.41	3.45	15.61	3.50	12.40	3.70
	18	19.30	2.93	18.87	2.99	16.73	3.33	15.45	3.54	14.70	3.59	11.71	3.78
	20	19.01	3.00	18.51	3.07	16.00	3.41	14.50	3.61	13.79	3.65	10.96	3.79
	21	19.04	3.04	18.48	3.09	15.66	3.34	13.96	3.49	13.28	3.56	10.56	3.81
	22	19.20	3.06	18.67	3.13	16.03	3.47	14.45	3.68	13.58	3.71	10.13	3.83
	24	19.90	3.09	19.09	3.16	15.06	3.52	12.64	3.73	11.96	3.76	9.22	3.87
2.0 + 3.5 + 3.5 + 4.2 + 4.2	16	20.14	2.79	19.73	2.86	17.66	3.22	16.41	3.43	15.61	3.48	12.40	3.68
	18	19.30	2.91	18.87	2.98	16.73	3.32	15.45	3.52	14.70	3.57	11.71	3.76
	20	19.01	2.99	18.51	3.05	16.00	3.39	14.50	3.59	13.79	3.63	10.96	3.77
	21	19.04	3.02	18.48	3.07	15.66	3.32	13.96	3.47	13.28	3.54	10.56	3.79
	22	19.20	3.04	18.67	3.11	16.03	3.45	14.45	3.66	13.58	3.69	10.13	3.81
	24	19.90	3.07	19.09	3.14	15.06	3.50	12.64	3.71	11.96	3.74	9.22	3.84
2.0 + 3.5 + 3.5 + 4.2 + 5.0	16	20.14	2.80	19.73	2.87	17.66	3.23	16.41	3.44	15.61	3.49	12.40	3.69
	18	19.30	2.92	18.87	2.99	16.73	3.32	15.45	3.53	14.70	3.58	11.71	3.77
	20	19.01	3.00	18.51	3.06	16.00	3.40	14.50	3.60	13.79	3.64	10.96	3.78
	21	19.04	3.03	18.48	3.08	15.66	3.33	13.96	3.48	13.28	3.55	10.56	3.80
	22	19.20	3.05	18.67	3.12	16.03	3.46	14.45	3.67	13.58	3.70	10.13	3.82
	24	19.90	3.08	19.09	3.15	15.06	3.51	12.64	3.72	11.96	3.75	9.22	3.86
2.0 + 3.5 + 4.2 + 4.2 + 4.2	16	20.14	2.79	19.73	2.86	17.66	3.21	16.41	3.42	15.61	3.47	12.40	3.67
	18	19.30	2.90	18.87	2.97	16.73	3.31	15.45	3.51	14.70	3.56	11.71	3.75
	20	19.01	2.98	18.51	3.05	16.00	3.38	14.50	3.58	13.79	3.62	10.96	3.76
	21	19.04	3.01	18.48	3.06	15.66	3.31	13.96	3.46	13.28	3.53	10.56	3.78
	22	19.20	3.03	18.67	3.10	16.03	3.44	14.45	3.65	13.58	3.68	10.13	3.80
	24	19.90	3.06	19.09	3.13	15.06	3.49	12.64	3.70	11.96	3.73	9.22	3.83
2.5 + 2.5 + 2.5 + 2.5 + 2.5	16	20.14	2.86	19.73	2.93	17.66	3.29	16.41	3.51	15.61	3.56	12.40	3.77
	18	19.30	2.97	18.87	3.04	16.73	3.39	15.45	3.60	14.70	3.65	11.71	3.84
	20	19.01	3.05	18.51	3.12	16.00	3.46	14.50	3.67	13.79	3.71	10.96	3.86
	21	19.04	3.09	18.48	3.14	15.66	3.40	13.96	3.55	13.28	3.61	10.56	3.87
	22	19.20	3.11	18.67	3.18	16.03	3.53	14.45	3.74	13.58	3.77	10.13	3.89
	24	19.90	3.14	19.09	3.21	15.06	3.58	12.64	3.79	11.96	3.82	9.22	3.93
2.5 + 2.5 + 2.5 + 2.5 + 3.5	16	20.14	2.83	19.73	2.90	17.66	3.26	16.41	3.48	15.61	3.53	12.40	3.74
	18	19.30	2.95	18.87	3.02	16.73	3.36	15.45	3.57	14.70	3.62	11.71	3.81
	20	19.01	3.03	18.51	3.10	16.00	3.44	14.50	3.64	13.79	3.68	10.96	3.83
	21	19.04	3.06	18.48	3.11	15.66	3.37	13.96	3.52	13.28	3.58	10.56	3.84
	22	19.20	3.08	18.67	3.15	16.03	3.50	14.45	3.71	13.58	3.74	10.13	3.86
	24	19.90	3.11	19.09	3.19	15.06	3.55	12.64	3.76	11.96	3.79	9.22	3.90

Combination (Capacity)	Indoor Air Temp. °C DB	Outdoor Air Temp. °C									
		0/-1		-5/-6		-7/-8		-10/-11		-15/-	
		Total Q	Input Power	Total Q	Input Power	Total Q	Input Power	Total Q	Input Power	Total Q	Input Power
2.0 + 3.5 + 3.5 + 3.5 + 5.0	16	12.04	3.66	11.13	3.54	10.76	3.49	10.34	3.37	9.65	3.17
	18	11.40	3.72	10.61	3.57	9.92	3.51	10.14	3.41	9.88	3.23
	20	10.75	3.74	10.21	3.59	9.99	3.53	9.96	3.45	9.91	3.32
	21	10.31	3.75	9.67	3.61	9.42	3.55	9.58	3.48	9.83	3.36
	22	10.07	3.77	9.92	3.62	9.86	3.57	9.80	3.50	9.71	3.40
	24	9.36	3.81	9.73	3.67	9.88	3.61	9.67	3.56	9.32	3.48
2.0 + 3.5 + 3.5 + 4.2 + 4.2	16	12.04	3.64	11.13	3.52	10.76	3.47	10.34	3.35	9.65	3.15
	18	11.40	3.70	10.61	3.55	9.92	3.49	10.14	3.39	9.88	3.21
	20	10.75	3.71	10.21	3.57	9.99	3.51	9.96	3.43	9.91	3.30
	21	10.31	3.73	9.67	3.59	9.42	3.53	9.58	3.46	9.83	3.34
	22	10.07	3.75	9.92	3.60	9.86	3.55	9.80	3.48	9.71	3.38
	24	9.36	3.79	9.73	3.65	9.88	3.59	9.67	3.54	9.32	3.46
2.0 + 3.5 + 3.5 + 4.2 + 5.0	16	12.04	3.65	11.13	3.53	10.76	3.48	10.34	3.36	9.65	3.16
	18	11.40	3.71	10.61	3.56	9.92	3.50	10.14	3.40	9.88	3.22
	20	10.75	3.73	10.21	3.58	9.99	3.52	9.96	3.44	9.91	3.31
	21	10.31	3.74	9.67	3.60	9.42	3.54	9.58	3.47	9.83	3.35
	22	10.07	3.76	9.92	3.61	9.86	3.56	9.80	3.49	9.71	3.39
	24	9.36	3.80	9.73	3.66	9.88	3.60	9.67	3.55	9.32	3.47
2.0 + 3.5 + 4.2 + 4.2 + 4.2	16	12.04	3.63	11.13	3.51	10.76	3.46	10.34	3.34	9.65	3.14
	18	11.40	3.69	10.61	3.54	9.92	3.48	10.14	3.38	9.88	3.20
	20	10.75	3.70	10.21	3.56	9.99	3.50	9.96	3.42	9.91	3.29
	21	10.31	3.72	9.67	3.58	9.42	3.52	9.58	3.45	9.83	3.33
	22	10.07	3.74	9.92	3.59	9.86	3.54	9.80	3.47	9.71	3.37
	24	9.36	3.78	9.73	3.64	9.88	3.58	9.67	3.53	9.32	3.45
2.5 + 2.5 + 2.5 + 2.5 + 2.5	16	12.04	3.72	11.13	3.60	10.76	3.55	10.34	3.43	9.65	3.22
	18	11.40	3.78	10.61	3.63	9.92	3.57	10.14	3.46	9.88	3.29
	20	10.75	3.80	10.21	3.65	9.99	3.59	9.96	3.51	9.91	3.38
	21	10.31	3.81	9.67	3.67	9.42	3.61	9.58	3.54	9.83	3.42
	22	10.07	3.83	9.92	3.68	9.86	3.62	9.80	3.56	9.71	3.46
	24	9.36	3.87	9.73	3.73	9.88	3.67	9.67	3.62	9.32	3.54
2.5 + 2.5 + 2.5 + 2.5 + 3.5	16	12.04	3.69	11.13	3.57	10.76	3.52	10.34	3.40	9.65	3.20
	18	11.40	3.75	10.61	3.60	9.92	3.54	10.14	3.43	9.88	3.26
	20	10.75	3.77	10.21	3.62	9.99	3.56	9.96	3.48	9.91	3.35
	21	10.31	3.78	9.67	3.64	9.42	3.58	9.58	3.51	9.83	3.39
	22	10.07	3.80	9.92	3.65	9.86	3.60	9.80	3.53	9.71	3.43
	24	9.36	3.84	9.73	3.70	9.88	3.64	9.67	3.59	9.32	3.51

Combination (Capacity)	Indoor Air Temp. °C DB	Outdoor Air Temp. °C											
		16/15		15/14		10/9		7/6		6/5		2/1	
		Total Q	Input Power	Total Q	Input Power	Total Q	Input Power	Total Q	Input Power	Total Q	Input Power	Total Q	Input Power
2.5 + 2.5 + 2.5 + 2.5 + 4.2	16	20.14	2.82	19.73	2.90	17.66	3.25	16.41	3.47	15.61	3.52	12.40	3.73
	18	19.30	2.94	18.87	3.01	16.73	3.35	15.45	3.56	14.70	3.61	11.71	3.80
	20	19.01	3.02	18.51	3.09	16.00	3.43	14.50	3.63	13.79	3.67	10.96	3.81
	21	19.04	3.05	18.48	3.10	15.66	3.36	13.96	3.51	13.28	3.58	10.56	3.83
	22	19.20	3.08	18.67	3.15	16.03	3.49	14.45	3.70	13.58	3.73	10.13	3.85
	24	19.90	3.10	19.09	3.18	15.06	3.54	12.64	3.75	11.96	3.78	9.22	3.89
2.5 + 2.5 + 2.5 + 2.5 + 5.0	16	20.14	2.82	19.73	2.90	17.66	3.25	16.41	3.47	15.61	3.52	12.40	3.73
	18	19.30	2.94	18.87	3.01	16.73	3.35	15.45	3.56	14.70	3.61	11.71	3.80
	20	19.01	3.02	18.51	3.09	16.00	3.43	14.50	3.63	13.79	3.67	10.96	3.81
	21	19.04	3.05	18.48	3.10	15.66	3.36	13.96	3.51	13.28	3.58	10.56	3.83
	22	19.20	3.08	18.67	3.15	16.03	3.49	14.45	3.70	13.58	3.73	10.13	3.85
	24	19.90	3.10	19.09	3.18	15.06	3.54	12.64	3.75	11.96	3.78	9.22	3.89
2.5 + 2.5 + 2.5 + 2.5 + 6.0	16	20.14	2.82	19.73	2.90	17.66	3.25	16.41	3.47	15.61	3.52	12.40	3.73
	18	19.30	2.94	18.87	3.01	16.73	3.35	15.45	3.56	14.70	3.61	11.71	3.80
	20	19.01	3.02	18.51	3.09	16.00	3.43	14.50	3.63	13.79	3.67	10.96	3.81
	21	19.04	3.05	18.48	3.10	15.66	3.36	13.96	3.51	13.28	3.58	10.56	3.83
	22	19.20	3.08	18.67	3.15	16.03	3.49	14.45	3.70	13.58	3.73	10.13	3.85
	24	19.90	3.10	19.09	3.18	15.06	3.54	12.64	3.75	11.96	3.78	9.22	3.89
2.5 + 2.5 + 2.5 + 2.5 + 7.1	16	20.14	2.81	19.73	2.88	17.66	3.24	16.41	3.45	15.61	3.50	12.40	3.70
	18	19.30	2.93	18.87	2.99	16.73	3.33	15.45	3.54	14.70	3.59	11.71	3.78
	20	19.01	3.00	18.51	3.07	16.00	3.41	14.50	3.61	13.79	3.65	10.96	3.79
	21	19.04	3.04	18.48	3.09	15.66	3.34	13.96	3.49	13.28	3.56	10.56	3.81
	22	19.20	3.06	18.67	3.13	16.03	3.47	14.45	3.68	13.58	3.71	10.13	3.83
	24	19.90	3.09	19.09	3.16	15.06	3.52	12.64	3.73	11.96	3.76	9.22	3.87
2.5 + 2.5 + 2.5 + 3.5 + 3.5	16	20.14	2.81	19.73	2.88	17.66	3.24	16.41	3.45	15.61	3.50	12.40	3.70
	18	19.30	2.93	18.87	2.99	16.73	3.33	15.45	3.54	14.70	3.59	11.71	3.78
	20	19.01	3.00	18.51	3.07	16.00	3.41	14.50	3.61	13.79	3.65	10.96	3.79
	21	19.04	3.04	18.48	3.09	15.66	3.34	13.96	3.49	13.28	3.56	10.56	3.81
	22	19.20	3.06	18.67	3.13	16.03	3.47	14.45	3.68	13.58	3.71	10.13	3.83
	24	19.90	3.09	19.09	3.16	15.06	3.52	12.64	3.73	11.96	3.76	9.22	3.87
2.5 + 2.5 + 2.5 + 3.5 + 4.2	16	20.14	2.80	19.73	2.87	17.66	3.23	16.41	3.44	15.61	3.49	12.40	3.69
	18	19.30	2.92	18.87	2.99	16.73	3.32	15.45	3.53	14.70	3.58	11.71	3.77
	20	19.01	3.00	18.51	3.06	16.00	3.40	14.50	3.60	13.79	3.64	10.96	3.78
	21	19.04	3.03	18.48	3.08	15.66	3.33	13.96	3.48	13.28	3.55	10.56	3.80
	22	19.20	3.05	18.67	3.12	16.03	3.46	14.45	3.67	13.58	3.70	10.13	3.82
	24	19.90	3.08	19.09	3.15	15.06	3.51	12.64	3.72	11.96	3.75	9.22	3.86

Combination (Capacity)	Indoor Air Temp. °C DB	Outdoor Air Temp. °C									
		0/-1		-5/-6		-7/-8		-10/-11		-15/-	
		Total Q	Input Power	Total Q	Input Power	Total Q	Input Power	Total Q	Input Power	Total Q	Input Power
2.5 + 2.5 + 2.5 + 2.5 + 4.2	16	12.04	3.68	11.13	3.56	10.76	3.51	10.34	3.39	9.65	3.19
	18	11.40	3.74	10.61	3.59	9.92	3.53	10.14	3.42	9.88	3.25
	20	10.75	3.76	10.21	3.61	9.99	3.55	9.96	3.47	9.91	3.34
	21	10.31	3.77	9.67	3.63	9.42	3.57	9.58	3.50	9.83	3.38
	22	10.07	3.79	9.92	3.64	9.86	3.59	9.80	3.52	9.71	3.42
	24	9.36	3.83	9.73	3.69	9.88	3.63	9.67	3.58	9.32	3.50
2.5 + 2.5 + 2.5 + 2.5 + 5.0	16	12.04	3.68	11.13	3.56	10.76	3.51	10.34	3.39	9.65	3.19
	18	11.40	3.74	10.61	3.59	9.92	3.53	10.14	3.42	9.88	3.25
	20	10.75	3.76	10.21	3.61	9.99	3.55	9.96	3.47	9.91	3.34
	21	10.31	3.77	9.67	3.63	9.42	3.57	9.58	3.50	9.83	3.38
	22	10.07	3.79	9.92	3.64	9.86	3.59	9.80	3.52	9.71	3.42
	24	9.36	3.83	9.73	3.69	9.88	3.63	9.67	3.58	9.32	3.50
2.5 + 2.5 + 2.5 + 2.5 + 6.0	16	12.04	3.68	11.13	3.56	10.76	3.51	10.34	3.39	9.65	3.19
	18	11.40	3.74	10.61	3.59	9.92	3.53	10.14	3.42	9.88	3.25
	20	10.75	3.76	10.21	3.61	9.99	3.55	9.96	3.47	9.91	3.34
	21	10.31	3.77	9.67	3.63	9.42	3.57	9.58	3.50	9.83	3.38
	22	10.07	3.79	9.92	3.64	9.86	3.59	9.80	3.52	9.71	3.42
	24	9.36	3.83	9.73	3.69	9.88	3.63	9.67	3.58	9.32	3.50
2.5 + 2.5 + 2.5 + 2.5 + 7.1	16	12.04	3.66	11.13	3.54	10.76	3.49	10.34	3.37	9.65	3.17
	18	11.40	3.72	10.61	3.57	9.92	3.51	10.14	3.41	9.88	3.23
	20	10.75	3.74	10.21	3.59	9.99	3.53	9.96	3.45	9.91	3.32
	21	10.31	3.75	9.67	3.61	9.42	3.55	9.58	3.48	9.83	3.36
	22	10.07	3.77	9.92	3.62	9.86	3.57	9.80	3.50	9.71	3.40
	24	9.36	3.81	9.73	3.67	9.88	3.61	9.67	3.56	9.32	3.48
2.5 + 2.5 + 2.5 + 3.5 + 3.5	16	12.04	3.66	11.13	3.54	10.76	3.49	10.34	3.37	9.65	3.17
	18	11.40	3.72	10.61	3.57	9.92	3.51	10.14	3.41	9.88	3.23
	20	10.75	3.74	10.21	3.59	9.99	3.53	9.96	3.45	9.91	3.32
	21	10.31	3.75	9.67	3.61	9.42	3.55	9.58	3.48	9.83	3.36
	22	10.07	3.77	9.92	3.62	9.86	3.57	9.80	3.50	9.71	3.40
	24	9.36	3.81	9.73	3.67	9.88	3.61	9.67	3.56	9.32	3.48
2.5 + 2.5 + 2.5 + 3.5 + 4.2	16	12.04	3.65	11.13	3.53	10.76	3.48	10.34	3.36	9.65	3.16
	18	11.40	3.71	10.61	3.56	9.92	3.50	10.14	3.40	9.88	3.22
	20	10.75	3.73	10.21	3.58	9.99	3.52	9.96	3.44	9.91	3.31
	21	10.31	3.74	9.67	3.60	9.42	3.54	9.58	3.47	9.83	3.35
	22	10.07	3.76	9.92	3.61	9.86	3.56	9.80	3.49	9.71	3.39
	24	9.36	3.80	9.73	3.66	9.88	3.60	9.67	3.55	9.32	3.47

Combination (Capacity)	Indoor Air Temp. °C DB	Outdoor Air Temp. °C											
		16/15		15/14		10/9		7/6		6/5		2/1	
		Total Q	Input Power	Total Q	Input Power	Total Q	Input Power	Total Q	Input Power	Total Q	Input Power	Total Q	Input Power
2.5 + 2.5 + 2.5 + 3.5 + 5.0	16	20.14	2.80	19.73	2.87	17.66	3.23	16.41	3.44	15.61	3.49	12.40	3.69
	18	19.30	2.92	18.87	2.99	16.73	3.32	15.45	3.53	14.70	3.58	11.71	3.77
	20	19.01	3.00	18.51	3.06	16.00	3.40	14.50	3.60	13.79	3.64	10.96	3.78
	21	19.04	3.03	18.48	3.08	15.66	3.33	13.96	3.48	13.28	3.55	10.56	3.80
	22	19.20	3.05	18.67	3.12	16.03	3.46	14.45	3.67	13.58	3.70	10.13	3.82
	24	19.90	3.08	19.09	3.15	15.06	3.51	12.64	3.72	11.96	3.75	9.22	3.86
2.5 + 2.5 + 2.5 + 3.5 + 6.0	16	20.14	2.80	19.73	2.87	17.66	3.23	16.41	3.44	15.61	3.49	12.40	3.69
	18	19.30	2.92	18.87	2.99	16.73	3.32	15.45	3.53	14.70	3.58	11.71	3.77
	20	19.01	3.00	18.51	3.06	16.00	3.40	14.50	3.60	13.79	3.64	10.96	3.78
	21	19.04	3.03	18.48	3.08	15.66	3.33	13.96	3.48	13.28	3.55	10.56	3.80
	22	19.20	3.05	18.67	3.12	16.03	3.46	14.45	3.67	13.58	3.70	10.13	3.82
	24	19.90	3.08	19.09	3.15	15.06	3.51	12.64	3.72	11.96	3.75	9.22	3.86
2.5 + 2.5 + 2.5 + 3.5 + 7.1	16	20.14	2.79	19.73	2.86	17.66	3.22	16.41	3.43	15.61	3.48	12.40	3.68
	18	19.30	2.91	18.87	2.98	16.73	3.32	15.45	3.52	14.70	3.57	11.71	3.76
	20	19.01	2.99	18.51	3.05	16.00	3.39	14.50	3.59	13.79	3.63	10.96	3.77
	21	19.04	3.02	18.48	3.07	15.66	3.32	13.96	3.47	13.28	3.54	10.56	3.79
	22	19.20	3.04	18.67	3.11	16.03	3.45	14.45	3.66	13.58	3.69	10.13	3.81
	24	19.90	3.07	19.09	3.14	15.06	3.50	12.64	3.71	11.96	3.74	9.22	3.84
2.5 + 2.5 + 2.5 + 4.2 + 4.2	16	20.14	2.79	19.73	2.86	17.66	3.22	16.41	3.43	15.61	3.48	12.40	3.68
	18	19.30	2.91	18.87	2.98	16.73	3.32	15.45	3.52	14.70	3.57	11.71	3.76
	20	19.01	2.99	18.51	3.05	16.00	3.39	14.50	3.59	13.79	3.63	10.96	3.77
	21	19.04	3.02	18.48	3.07	15.66	3.32	13.96	3.47	13.28	3.54	10.56	3.79
	22	19.20	3.04	18.67	3.11	16.03	3.45	14.45	3.66	13.58	3.69	10.13	3.81
	24	19.90	3.07	19.09	3.14	15.06	3.50	12.64	3.71	11.96	3.74	9.22	3.84
2.5 + 2.5 + 2.5 + 4.2 + 5.0	16	20.14	2.79	19.73	2.86	17.66	3.22	16.41	3.43	15.61	3.48	12.40	3.68
	18	19.30	2.91	18.87	2.98	16.73	3.32	15.45	3.52	14.70	3.57	11.71	3.76
	20	19.01	2.99	18.51	3.05	16.00	3.39	14.50	3.59	13.79	3.63	10.96	3.77
	21	19.04	3.02	18.48	3.07	15.66	3.32	13.96	3.47	13.28	3.54	10.56	3.79
	22	19.20	3.04	18.67	3.11	16.03	3.45	14.45	3.66	13.58	3.69	10.13	3.81
	24	19.90	3.07	19.09	3.14	15.06	3.50	12.64	3.71	11.96	3.74	9.22	3.84
2.5 + 2.5 + 2.5 + 4.2 + 6.0	16	20.14	2.79	19.73	2.86	17.66	3.22	16.41	3.43	15.61	3.48	12.40	3.68
	18	19.30	2.91	18.87	2.98	16.73	3.32	15.45	3.52	14.70	3.57	11.71	3.76
	20	19.01	2.99	18.51	3.05	16.00	3.39	14.50	3.59	13.79	3.63	10.96	3.77
	21	19.04	3.02	18.48	3.07	15.66	3.32	13.96	3.47	13.28	3.54	10.56	3.79
	22	19.20	3.04	18.67	3.11	16.03	3.45	14.45	3.66	13.58	3.69	10.13	3.81
	24	19.90	3.07	19.09	3.14	15.06	3.50	12.64	3.71	11.96	3.74	9.22	3.84

Combination (Capacity)	Indoor Air Temp. °C DB	Outdoor Air Temp. °C									
		0/-1		-5/-6		-7/-8		-10/-11		-15/-	
		Total Q	Input Power	Total Q	Input Power	Total Q	Input Power	Total Q	Input Power	Total Q	Input Power
2.5 + 2.5 + 2.5 + 3.5 + 5.0	16	12.04	3.65	11.13	3.53	10.76	3.48	10.34	3.36	9.65	3.16
	18	11.40	3.71	10.61	3.56	9.92	3.50	10.14	3.40	9.88	3.22
	20	10.75	3.73	10.21	3.58	9.99	3.52	9.96	3.44	9.91	3.31
	21	10.31	3.74	9.67	3.60	9.42	3.54	9.58	3.47	9.83	3.35
	22	10.07	3.76	9.92	3.61	9.86	3.56	9.80	3.49	9.71	3.39
	24	9.36	3.80	9.73	3.66	9.88	3.60	9.67	3.55	9.32	3.47
2.5 + 2.5 + 2.5 + 3.5 + 6.0	16	12.04	3.65	11.13	3.53	10.76	3.48	10.34	3.36	9.65	3.16
	18	11.40	3.71	10.61	3.56	9.92	3.50	10.14	3.40	9.88	3.22
	20	10.75	3.73	10.21	3.58	9.99	3.52	9.96	3.44	9.91	3.31
	21	10.31	3.74	9.67	3.60	9.42	3.54	9.58	3.47	9.83	3.35
	22	10.07	3.76	9.92	3.61	9.86	3.56	9.80	3.49	9.71	3.39
	24	9.36	3.80	9.73	3.66	9.88	3.60	9.67	3.55	9.32	3.47
2.5 + 2.5 + 2.5 + 3.5 + 7.1	16	12.04	3.64	11.13	3.52	10.76	3.47	10.34	3.35	9.65	3.15
	18	11.40	3.70	10.61	3.55	9.92	3.49	10.14	3.39	9.88	3.21
	20	10.75	3.71	10.21	3.57	9.99	3.51	9.96	3.43	9.91	3.30
	21	10.31	3.73	9.67	3.59	9.42	3.53	9.58	3.46	9.83	3.34
	22	10.07	3.75	9.92	3.60	9.86	3.55	9.80	3.48	9.71	3.38
	24	9.36	3.79	9.73	3.65	9.88	3.59	9.67	3.54	9.32	3.46
2.5 + 2.5 + 2.5 + 4.2 + 4.2	16	12.04	3.64	11.13	3.52	10.76	3.47	10.34	3.35	9.65	3.15
	18	11.40	3.70	10.61	3.55	9.92	3.49	10.14	3.39	9.88	3.21
	20	10.75	3.71	10.21	3.57	9.99	3.51	9.96	3.43	9.91	3.30
	21	10.31	3.73	9.67	3.59	9.42	3.53	9.58	3.46	9.83	3.34
	22	10.07	3.75	9.92	3.60	9.86	3.55	9.80	3.48	9.71	3.38
	24	9.36	3.79	9.73	3.65	9.88	3.59	9.67	3.54	9.32	3.46
2.5 + 2.5 + 2.5 + 4.2 + 5.0	16	12.04	3.64	11.13	3.52	10.76	3.47	10.34	3.35	9.65	3.15
	18	11.40	3.70	10.61	3.55	9.92	3.49	10.14	3.39	9.88	3.21
	20	10.75	3.71	10.21	3.57	9.99	3.51	9.96	3.43	9.91	3.30
	21	10.31	3.73	9.67	3.59	9.42	3.53	9.58	3.46	9.83	3.34
	22	10.07	3.75	9.92	3.60	9.86	3.55	9.80	3.48	9.71	3.38
	24	9.36	3.79	9.73	3.65	9.88	3.59	9.67	3.54	9.32	3.46
2.5 + 2.5 + 2.5 + 4.2 + 6.0	16	12.04	3.64	11.13	3.52	10.76	3.47	10.34	3.35	9.65	3.15
	18	11.40	3.70	10.61	3.55	9.92	3.49	10.14	3.39	9.88	3.21
	20	10.75	3.71	10.21	3.57	9.99	3.51	9.96	3.43	9.91	3.30
	21	10.31	3.73	9.67	3.59	9.42	3.53	9.58	3.46	9.83	3.34
	22	10.07	3.75	9.92	3.60	9.86	3.55	9.80	3.48	9.71	3.38
	24	9.36	3.79	9.73	3.65	9.88	3.59	9.67	3.54	9.32	3.46

Combination (Capacity)	Indoor Air Temp. °C DB	Outdoor Air Temp. °C											
		16/15		15/14		10/9		7/6		6/5		2/1	
		Total Q	Input Power	Total Q	Input Power	Total Q	Input Power	Total Q	Input Power	Total Q	Input Power	Total Q	Input Power
2.5 + 2.5 + 2.5 + 5.0 + 5.0	16	20.14	2.85	19.73	2.92	17.66	3.28	16.41	3.50	15.61	3.55	12.40	3.76
	18	19.30	2.97	18.87	3.04	16.73	3.38	15.45	3.59	14.70	3.64	11.71	3.83
	20	19.01	3.05	18.51	3.11	16.00	3.46	14.50	3.66	13.79	3.70	10.96	3.85
	21	19.04	3.08	18.48	3.13	15.66	3.39	13.96	3.54	13.28	3.60	10.56	3.86
	22	19.20	3.10	18.67	3.17	16.03	3.52	14.45	3.73	13.58	3.76	10.13	3.88
	24	19.90	3.13	19.09	3.20	15.06	3.57	12.64	3.78	11.96	3.81	9.22	3.92
2.5 + 2.5 + 3.5 + 3.5 + 3.5	16	20.14	2.83	19.73	2.90	17.66	3.26	16.41	3.48	15.61	3.53	12.40	3.74
	18	19.30	2.95	18.87	3.02	16.73	3.36	15.45	3.57	14.70	3.62	11.71	3.81
	20	19.01	3.03	18.51	3.10	16.00	3.44	14.50	3.64	13.79	3.68	10.96	3.83
	21	19.04	3.06	18.48	3.11	15.66	3.37	13.96	3.52	13.28	3.58	10.56	3.84
	22	19.20	3.08	18.67	3.15	16.03	3.50	14.45	3.71	13.58	3.74	10.13	3.86
	24	19.90	3.11	19.09	3.19	15.06	3.55	12.64	3.76	11.96	3.79	9.22	3.90
2.5 + 2.5 + 3.5 + 3.5 + 4.2	16	20.14	2.82	19.73	2.90	17.66	3.25	16.41	3.47	15.61	3.52	12.40	3.73
	18	19.30	2.94	18.87	3.01	16.73	3.35	15.45	3.56	14.70	3.61	11.71	3.80
	20	19.01	3.02	18.51	3.09	16.00	3.43	14.50	3.63	13.79	3.67	10.96	3.81
	21	19.04	3.05	18.48	3.10	15.66	3.36	13.96	3.51	13.28	3.58	10.56	3.83
	22	19.20	3.08	18.67	3.15	16.03	3.49	14.45	3.70	13.58	3.73	10.13	3.85
	24	19.90	3.10	19.09	3.18	15.06	3.54	12.64	3.75	11.96	3.78	9.22	3.89
2.5 + 2.5 + 3.5 + 3.5 + 5.0	16	20.14	2.82	19.73	2.90	17.66	3.25	16.41	3.47	15.61	3.52	12.40	3.73
	18	19.30	2.94	18.87	3.01	16.73	3.35	15.45	3.56	14.70	3.61	11.71	3.80
	20	19.01	3.02	18.51	3.09	16.00	3.43	14.50	3.63	13.79	3.67	10.96	3.81
	21	19.04	3.05	18.48	3.10	15.66	3.36	13.96	3.51	13.28	3.58	10.56	3.83
	22	19.20	3.08	18.67	3.15	16.03	3.49	14.45	3.70	13.58	3.73	10.13	3.85
	24	19.90	3.10	19.09	3.18	15.06	3.54	12.64	3.75	11.96	3.78	9.22	3.89
2.5 + 2.5 + 3.5 + 3.5 + 6.0	16	20.14	2.82	19.73	2.90	17.66	3.25	16.41	3.47	15.61	3.52	12.40	3.73
	18	19.30	2.94	18.87	3.01	16.73	3.35	15.45	3.56	14.70	3.61	11.71	3.80
	20	19.01	3.02	18.51	3.09	16.00	3.43	14.50	3.63	13.79	3.67	10.96	3.81
	21	19.04	3.05	18.48	3.10	15.66	3.36	13.96	3.51	13.28	3.58	10.56	3.83
	22	19.20	3.08	18.67	3.15	16.03	3.49	14.45	3.70	13.58	3.73	10.13	3.85
	24	19.90	3.10	19.09	3.18	15.06	3.54	12.64	3.75	11.96	3.78	9.22	3.89
2.5 + 2.5 + 3.5 + 4.2 + 4.2	16	20.14	2.82	19.73	2.89	17.66	3.24	16.41	3.46	15.61	3.51	12.40	3.71
	18	19.30	2.93	18.87	3.00	16.73	3.34	15.45	3.55	14.70	3.60	11.71	3.79
	20	19.01	3.01	18.51	3.08	16.00	3.42	14.50	3.62	13.79	3.66	10.96	3.80
	21	19.04	3.05	18.48	3.10	15.66	3.35	13.96	3.50	13.28	3.57	10.56	3.82
	22	19.20	3.07	18.67	3.14	16.03	3.48	14.45	3.69	13.58	3.72	10.13	3.84
	24	19.90	3.10	19.09	3.17	15.06	3.53	12.64	3.74	11.96	3.77	9.22	3.88



Combination (Capacity)	Indoor Air Temp. °C DB	Outdoor Air Temp. °C									
		0/-1		-5/-6		-7/-8		-10/-11		-15/-	
		Total Q	Input Power	Total Q	Input Power	Total Q	Input Power	Total Q	Input Power	Total Q	Input Power
2.5 + 2.5 + 2.5 + 5.0 + 5.0	16	12.04	3.71	11.13	3.59	10.76	3.54	10.34	3.42	9.65	3.21
	18	11.40	3.77	10.61	3.62	9.92	3.56	10.14	3.45	9.88	3.28
	20	10.75	3.79	10.21	3.64	9.99	3.58	9.96	3.50	9.91	3.37
	21	10.31	3.80	9.67	3.66	9.42	3.60	9.58	3.53	9.83	3.41
	22	10.07	3.82	9.92	3.67	9.86	3.61	9.80	3.55	9.71	3.45
	24	9.36	3.86	9.73	3.72	9.88	3.66	9.67	3.61	9.32	3.53
2.5 + 2.5 + 3.5 + 3.5 + 3.5	16	12.04	3.69	11.13	3.57	10.76	3.52	10.34	3.40	9.65	3.20
	18	11.40	3.75	10.61	3.60	9.92	3.54	10.14	3.43	9.88	3.26
	20	10.75	3.77	10.21	3.62	9.99	3.56	9.96	3.48	9.91	3.35
	21	10.31	3.78	9.67	3.64	9.42	3.58	9.58	3.51	9.83	3.39
	22	10.07	3.80	9.92	3.65	9.86	3.60	9.80	3.53	9.71	3.43
	24	9.36	3.84	9.73	3.70	9.88	3.64	9.67	3.59	9.32	3.51
2.5 + 2.5 + 3.5 + 3.5 + 4.2	16	12.04	3.68	11.13	3.56	10.76	3.51	10.34	3.39	9.65	3.19
	18	11.40	3.74	10.61	3.59	9.92	3.53	10.14	3.42	9.88	3.25
	20	10.75	3.76	10.21	3.61	9.99	3.55	9.96	3.47	9.91	3.34
	21	10.31	3.77	9.67	3.63	9.42	3.57	9.58	3.50	9.83	3.38
	22	10.07	3.79	9.92	3.64	9.86	3.59	9.80	3.52	9.71	3.42
	24	9.36	3.83	9.73	3.69	9.88	3.63	9.67	3.58	9.32	3.50
2.5 + 2.5 + 3.5 + 3.5 + 5.0	16	12.04	3.68	11.13	3.56	10.76	3.51	10.34	3.39	9.65	3.19
	18	11.40	3.74	10.61	3.59	9.92	3.53	10.14	3.42	9.88	3.25
	20	10.75	3.76	10.21	3.61	9.99	3.55	9.96	3.47	9.91	3.34
	21	10.31	3.77	9.67	3.63	9.42	3.57	9.58	3.50	9.83	3.38
	22	10.07	3.79	9.92	3.64	9.86	3.59	9.80	3.52	9.71	3.42
	24	9.36	3.83	9.73	3.69	9.88	3.63	9.67	3.58	9.32	3.50
2.5 + 2.5 + 3.5 + 3.5 + 6.0	16	12.04	3.68	11.13	3.56	10.76	3.51	10.34	3.39	9.65	3.19
	18	11.40	3.74	10.61	3.59	9.92	3.53	10.14	3.42	9.88	3.25
	20	10.75	3.76	10.21	3.61	9.99	3.55	9.96	3.47	9.91	3.34
	21	10.31	3.77	9.67	3.63	9.42	3.57	9.58	3.50	9.83	3.38
	22	10.07	3.79	9.92	3.64	9.86	3.59	9.80	3.52	9.71	3.42
	24	9.36	3.83	9.73	3.69	9.88	3.63	9.67	3.58	9.32	3.50
2.5 + 2.5 + 3.5 + 4.2 + 4.2	16	12.04	3.67	11.13	3.55	10.76	3.50	10.34	3.38	9.65	3.18
	18	11.40	3.73	10.61	3.58	9.92	3.52	10.14	3.42	9.88	3.24
	20	10.75	3.75	10.21	3.60	9.99	3.54	9.96	3.46	9.91	3.33
	21	10.31	3.76	9.67	3.62	9.42	3.56	9.58	3.49	9.83	3.37
	22	10.07	3.78	9.92	3.63	9.86	3.58	9.80	3.51	9.71	3.41
	24	9.36	3.82	9.73	3.68	9.88	3.62	9.67	3.57	9.32	3.49

Combination (Capacity)	Indoor Air Temp. °C DB	Outdoor Air Temp. °C											
		16/15		15/14		10/9		7/6		6/5		2/1	
		Total Q	Input Power	Total Q	Input Power	Total Q	Input Power	Total Q	Input Power	Total Q	Input Power	Total Q	Input Power
2.5 + 2.5 + 3.5 + 4.2 + 5.0	16	20.14	2.82	19.73	2.89	17.66	3.24	16.41	3.46	15.61	3.51	12.40	3.71
	18	19.30	2.93	18.87	3.00	16.73	3.34	15.45	3.55	14.70	3.60	11.71	3.79
	20	19.01	3.01	18.51	3.08	16.00	3.42	14.50	3.62	13.79	3.66	10.96	3.80
	21	19.04	3.05	18.48	3.10	15.66	3.35	13.96	3.50	13.28	3.57	10.56	3.82
	22	19.20	3.07	18.67	3.14	16.03	3.48	14.45	3.69	13.58	3.72	10.13	3.84
	24	19.90	3.10	19.09	3.17	15.06	3.53	12.64	3.74	11.96	3.77	9.22	3.88
2.5 + 2.5 + 4.2 + 4.2 + 4.2	16	20.14	2.81	19.73	2.88	17.66	3.24	16.41	3.45	15.61	3.50	12.40	3.70
	18	19.30	2.93	18.87	2.99	16.73	3.33	15.45	3.54	14.70	3.59	11.71	3.78
	20	19.01	3.00	18.51	3.07	16.00	3.41	14.50	3.61	13.79	3.65	10.96	3.79
	21	19.04	3.04	18.48	3.09	15.66	3.34	13.96	3.49	13.28	3.56	10.56	3.81
	22	19.20	3.06	18.67	3.13	16.03	3.47	14.45	3.68	13.58	3.71	10.13	3.83
	24	19.90	3.09	19.09	3.16	15.06	3.52	12.64	3.73	11.96	3.76	9.22	3.87
2.5 + 3.5 + 3.5 + 3.5 + 3.5	16	20.14	2.81	19.73	2.88	17.66	3.24	16.41	3.45	15.61	3.50	12.40	3.70
	18	19.30	2.93	18.87	2.99	16.73	3.33	15.45	3.54	14.70	3.59	11.71	3.78
	20	19.01	3.00	18.51	3.07	16.00	3.41	14.50	3.61	13.79	3.65	10.96	3.79
	21	19.04	3.04	18.48	3.09	15.66	3.34	13.96	3.49	13.28	3.56	10.56	3.81
	22	19.20	3.06	18.67	3.13	16.03	3.47	14.45	3.68	13.58	3.71	10.13	3.83
	24	19.90	3.09	19.09	3.16	15.06	3.52	12.64	3.73	11.96	3.76	9.22	3.87
2.5 + 3.5 + 3.5 + 3.5 + 4.2	16	20.14	2.80	19.73	2.87	17.66	3.23	16.41	3.44	15.61	3.49	12.40	3.69
	18	19.30	2.92	18.87	2.99	16.73	3.32	15.45	3.53	14.70	3.58	11.71	3.77
	20	19.01	3.00	18.51	3.06	16.00	3.40	14.50	3.60	13.79	3.64	10.96	3.78
	21	19.04	3.03	18.48	3.08	15.66	3.33	13.96	3.48	13.28	3.55	10.56	3.80
	22	19.20	3.05	18.67	3.12	16.03	3.46	14.45	3.67	13.58	3.70	10.13	3.82
	24	19.90	3.08	19.09	3.15	15.06	3.51	12.64	3.72	11.96	3.75	9.22	3.86
2.5 + 3.5 + 3.5 + 3.5 + 5.0	16	20.14	2.81	19.73	2.88	17.66	3.24	16.41	3.45	15.61	3.50	12.40	3.70
	18	19.30	2.93	18.87	2.99	16.73	3.33	15.45	3.54	14.70	3.59	11.71	3.78
	20	19.01	3.00	18.51	3.07	16.00	3.41	14.50	3.61	13.79	3.65	10.96	3.79
	21	19.04	3.04	18.48	3.09	15.66	3.34	13.96	3.49	13.28	3.56	10.56	3.81
	22	19.20	3.06	18.67	3.13	16.03	3.47	14.45	3.68	13.58	3.71	10.13	3.83
	24	19.90	3.09	19.09	3.16	15.06	3.52	12.64	3.73	11.96	3.76	9.22	3.87
2.5 + 3.5 + 3.5 + 4.2 + 4.2	16	20.14	2.79	19.73	2.86	17.66	3.22	16.41	3.43	15.61	3.48	12.40	3.68
	18	19.30	2.91	18.87	2.98	16.73	3.32	15.45	3.52	14.70	3.57	11.71	3.76
	20	19.01	2.99	18.51	3.05	16.00	3.39	14.50	3.59	13.79	3.63	10.96	3.77
	21	19.04	3.02	18.48	3.07	15.66	3.32	13.96	3.47	13.28	3.54	10.56	3.79
	22	19.20	3.04	18.67	3.11	16.03	3.45	14.45	3.66	13.58	3.69	10.13	3.81
	24	19.90	3.07	19.09	3.14	15.06	3.50	12.64	3.71	11.96	3.74	9.22	3.84

Combination (Capacity)	Indoor Air Temp. °C DB	Outdoor Air Temp. °C									
		0/-1		-5/-6		-7/-8		-10/-11		-15/-	
		Total Q	Input Power	Total Q	Input Power	Total Q	Input Power	Total Q	Input Power	Total Q	Input Power
2.5 + 2.5 + 3.5 + 4.2 + 5.0	16	12.04	3.67	11.13	3.55	10.76	3.50	10.34	3.38	9.65	3.18
	18	11.40	3.73	10.61	3.58	9.92	3.52	10.14	3.42	9.88	3.24
	20	10.75	3.75	10.21	3.60	9.99	3.54	9.96	3.46	9.91	3.33
	21	10.31	3.76	9.67	3.62	9.42	3.56	9.58	3.49	9.83	3.37
	22	10.07	3.78	9.92	3.63	9.86	3.58	9.80	3.51	9.71	3.41
	24	9.36	3.82	9.73	3.68	9.88	3.62	9.67	3.57	9.32	3.49
2.5 + 2.5 + 4.2 + 4.2 + 4.2	16	12.04	3.66	11.13	3.54	10.76	3.49	10.34	3.37	9.65	3.17
	18	11.40	3.72	10.61	3.57	9.92	3.51	10.14	3.41	9.88	3.23
	20	10.75	3.74	10.21	3.59	9.99	3.53	9.96	3.45	9.91	3.32
	21	10.31	3.75	9.67	3.61	9.42	3.55	9.58	3.48	9.83	3.36
	22	10.07	3.77	9.92	3.62	9.86	3.57	9.80	3.50	9.71	3.40
	24	9.36	3.81	9.73	3.67	9.88	3.61	9.67	3.56	9.32	3.48
2.5 + 3.5 + 3.5 + 3.5 + 3.5	16	12.04	3.66	11.13	3.54	10.76	3.49	10.34	3.37	9.65	3.17
	18	11.40	3.72	10.61	3.57	9.92	3.51	10.14	3.41	9.88	3.23
	20	10.75	3.74	10.21	3.59	9.99	3.53	9.96	3.45	9.91	3.32
	21	10.31	3.75	9.67	3.61	9.42	3.55	9.58	3.48	9.83	3.36
	22	10.07	3.77	9.92	3.62	9.86	3.57	9.80	3.50	9.71	3.40
	24	9.36	3.81	9.73	3.67	9.88	3.61	9.67	3.56	9.32	3.48
2.5 + 3.5 + 3.5 + 3.5 + 4.2	16	12.04	3.65	11.13	3.53	10.76	3.48	10.34	3.36	9.65	3.16
	18	11.40	3.71	10.61	3.56	9.92	3.50	10.14	3.40	9.88	3.22
	20	10.75	3.73	10.21	3.58	9.99	3.52	9.96	3.44	9.91	3.31
	21	10.31	3.74	9.67	3.60	9.42	3.54	9.58	3.47	9.83	3.35
	22	10.07	3.76	9.92	3.61	9.86	3.56	9.80	3.49	9.71	3.39
	24	9.36	3.80	9.73	3.66	9.88	3.60	9.67	3.55	9.32	3.47
2.5 + 3.5 + 3.5 + 3.5 + 5.0	16	12.04	3.66	11.13	3.54	10.76	3.49	10.34	3.37	9.65	3.17
	18	11.40	3.72	10.61	3.57	9.92	3.51	10.14	3.41	9.88	3.23
	20	10.75	3.74	10.21	3.59	9.99	3.53	9.96	3.45	9.91	3.32
	21	10.31	3.75	9.67	3.61	9.42	3.55	9.58	3.48	9.83	3.36
	22	10.07	3.77	9.92	3.62	9.86	3.57	9.80	3.50	9.71	3.40
	24	9.36	3.81	9.73	3.67	9.88	3.61	9.67	3.56	9.32	3.48
2.5 + 3.5 + 3.5 + 4.2 + 4.2	16	12.04	3.64	11.13	3.52	10.76	3.47	10.34	3.35	9.65	3.15
	18	11.40	3.70	10.61	3.55	9.92	3.49	10.14	3.39	9.88	3.21
	20	10.75	3.71	10.21	3.57	9.99	3.51	9.96	3.43	9.91	3.30
	21	10.31	3.73	9.67	3.59	9.42	3.53	9.58	3.46	9.83	3.34
	22	10.07	3.75	9.92	3.60	9.86	3.55	9.80	3.48	9.71	3.38
	24	9.36	3.79	9.73	3.65	9.88	3.59	9.67	3.54	9.32	3.46

Combination (Capacity)	Indoor Air Temp. °C DB	Outdoor Air Temp. °C											
		16/15		15/14		10/9		7/6		6/5		2/1	
		Total Q	Input Power	Total Q	Input Power	Total Q	Input Power	Total Q	Input Power	Total Q	Input Power	Total Q	Input Power
3.5 + 3.5 + 3.5 + 3.5 + 3.5	16	20.14	2.79	19.73	2.86	17.66	3.21	16.41	3.42	15.61	3.47	12.40	3.67
	18	19.30	2.90	18.87	2.97	16.73	3.31	15.45	3.51	14.70	3.56	11.71	3.75
	20	19.01	2.98	18.51	3.05	16.00	3.38	14.50	3.58	13.79	3.62	10.96	3.76
	21	19.04	3.01	18.48	3.06	15.66	3.31	13.96	3.46	13.28	3.53	10.56	3.78
	22	19.20	3.03	18.67	3.10	16.03	3.44	14.45	3.65	13.58	3.68	10.13	3.80
	24	19.90	3.06	19.09	3.13	15.06	3.49	12.64	3.70	11.96	3.73	9.22	3.83
3.5 + 3.5 + 3.5 + 3.5 + 4.2	16	20.14	2.82	19.73	2.90	17.66	3.25	16.41	3.47	15.61	3.52	12.40	3.73
	18	19.30	2.94	18.87	3.01	16.73	3.35	15.45	3.56	14.70	3.61	11.71	3.80
	20	19.01	3.02	18.51	3.09	16.00	3.43	14.50	3.63	13.79	3.67	10.96	3.81
	21	19.04	3.05	18.48	3.10	15.66	3.36	13.96	3.51	13.28	3.58	10.56	3.83
	22	19.20	3.08	18.67	3.15	16.03	3.49	14.45	3.70	13.58	3.73	10.13	3.85
	24	19.90	3.10	19.09	3.18	15.06	3.54	12.64	3.75	11.96	3.78	9.22	3.89

Combination (Capacity)	Indoor Air Temp. °C DB	Outdoor Air Temp. °C									
		0/-1		-5/-6		-7/-8		-10/-11		-15/-	
		Total Q	Input Power	Total Q	Input Power	Total Q	Input Power	Total Q	Input Power	Total Q	Input Power
3.5 + 3.5 + 3.5 + 3.5 + 3.5	16	12.04	3.63	11.13	3.51	10.76	3.46	10.34	3.34	9.65	3.14
	18	11.40	3.69	10.61	3.54	9.92	3.48	10.14	3.38	9.88	3.20
	20	10.75	3.70	10.21	3.56	9.99	3.50	9.96	3.42	9.91	3.29
	21	10.31	3.72	9.67	3.58	9.42	3.52	9.58	3.45	9.83	3.33
	22	10.07	3.74	9.92	3.59	9.86	3.54	9.80	3.47	9.71	3.37
	24	9.36	3.78	9.73	3.64	9.88	3.58	9.67	3.53	9.32	3.45
3.5 + 3.5 + 3.5 + 3.5 + 4.2	16	12.04	3.68	11.13	3.56	10.76	3.51	10.34	3.39	9.65	3.19
	18	11.40	3.74	10.61	3.59	9.92	3.53	10.14	3.42	9.88	3.25
	20	10.75	3.76	10.21	3.61	9.99	3.55	9.96	3.47	9.91	3.34
	21	10.31	3.77	9.67	3.63	9.42	3.57	9.58	3.50	9.83	3.38
	22	10.07	3.79	9.92	3.64	9.86	3.59	9.80	3.52	9.71	3.42
	24	9.36	3.83	9.73	3.69	9.88	3.63	9.67	3.58	9.32	3.50

Total Q: Total Heating Capacity (kW)  
Input Power (kW)

## 19. Service Data

Service Data provided are based on the air conditioner running under rated frequency during forced cooling / forced heating mode.

### 19.1 Operation Characteristics (CU-4Z80TBE)

#### 19.1.1 One Indoor Unit Operation

- Cooling Characteristic

[Condition] Room temperature: 27°C (DBT), 19°C (WBT)

Operation condition: High fan speed

Piping Length: 5m

Voltage: 230V, 50Hz

A) Indoor unit capacity: Cooling (2.0kW), CS-Z20TKEW, service mode frequency = 20 Hz

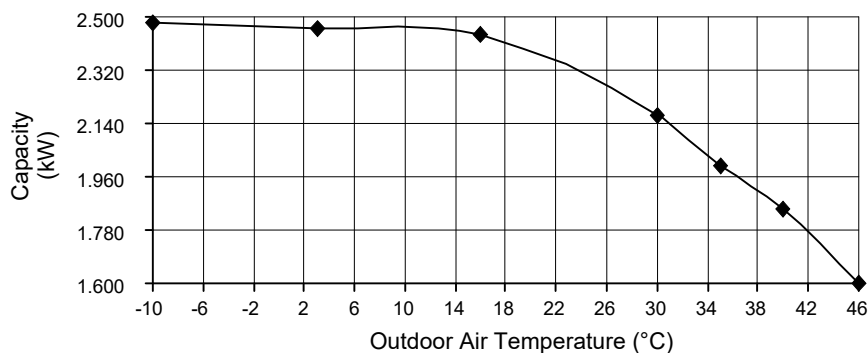
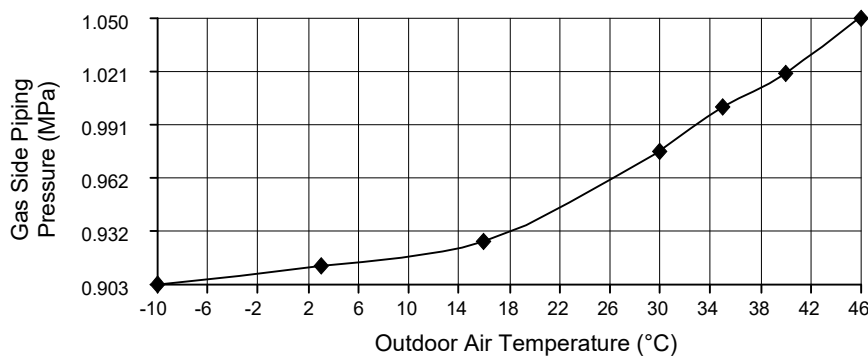
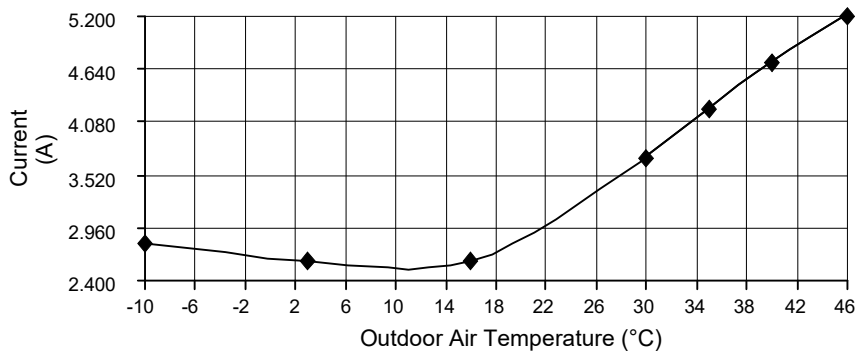
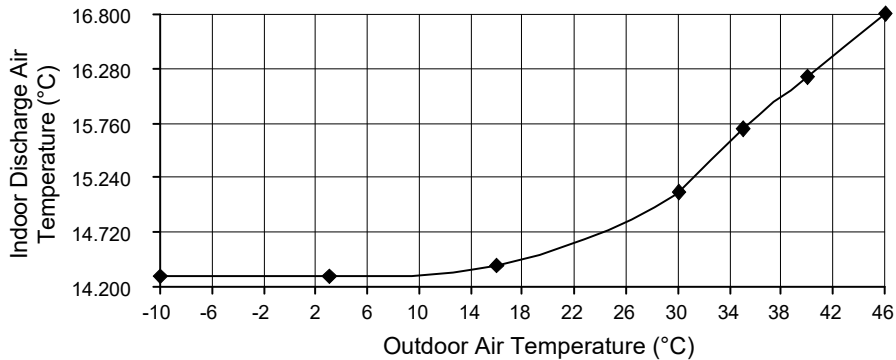

- Cooling Characteristic  
 [Condition] Room temperature: 27°C (DBT), 19°C (WBT)  
 Operation condition: High fan speed  
 Piping Length: 5m  
 Voltage: 230V, 50Hz

B) Indoor unit capacity: Cooling (2.5kW), CS-Z25TKEW, service mode frequency = 20 Hz

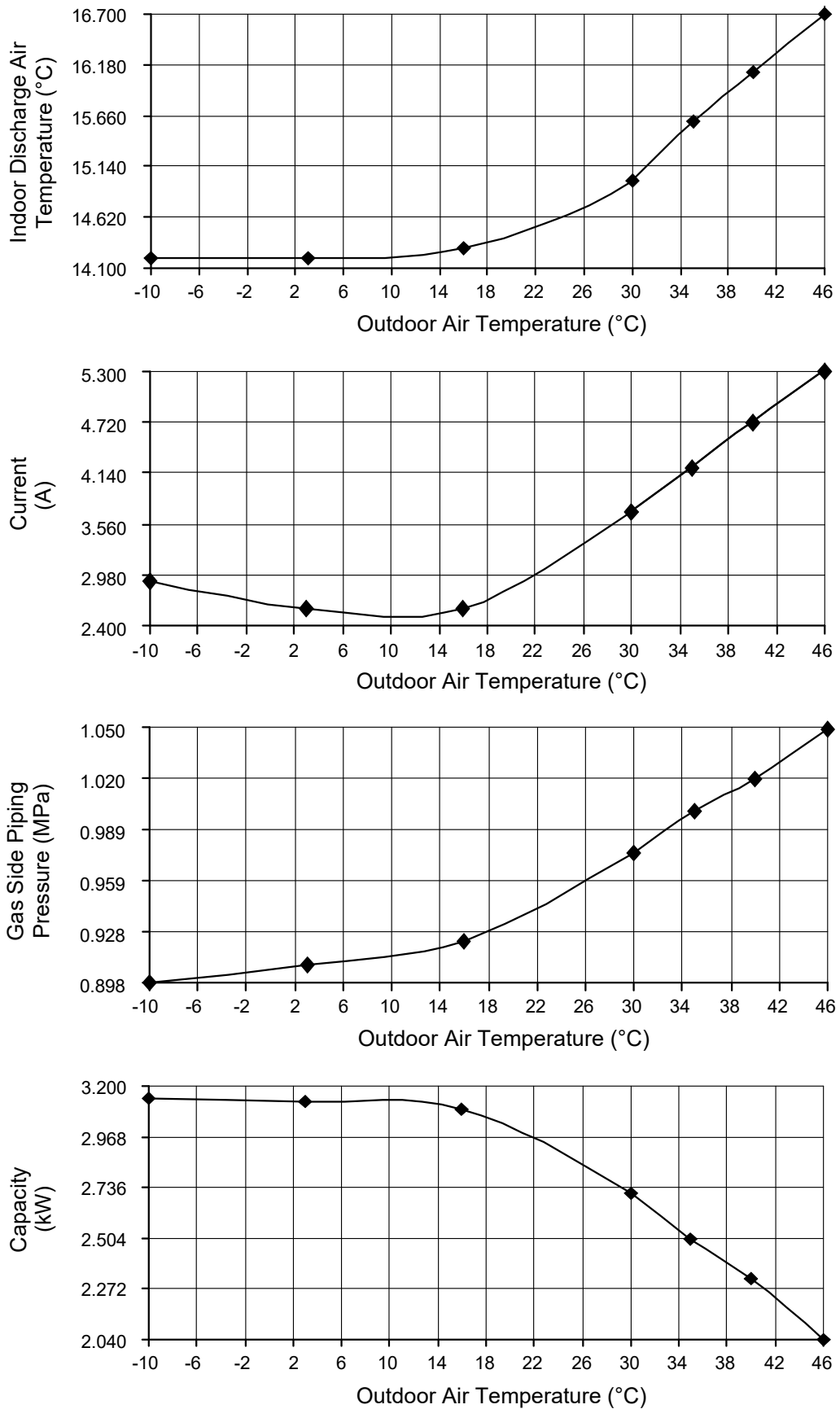

- Cooling Characteristic  
 [Condition] Room temperature: 27°C (DBT), 19°C (WBT)  
 Operation condition: High fan speed  
 Piping Length: 5m  
 Voltage: 230V, 50Hz

C) Indoor unit capacity: Cooling (4.2kW), CS-Z42TKEW, service mode frequency = 34 Hz

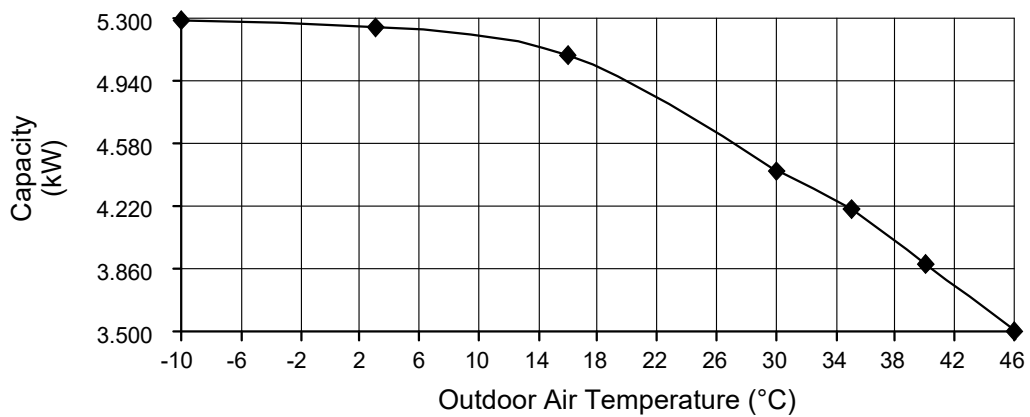
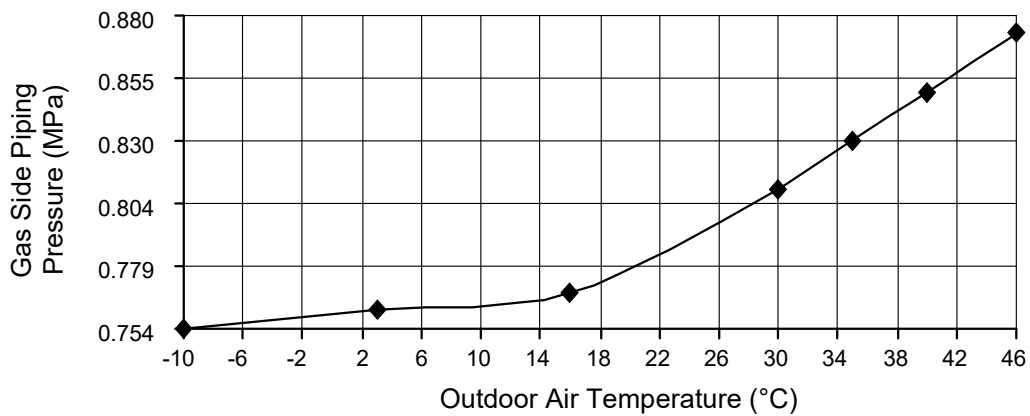
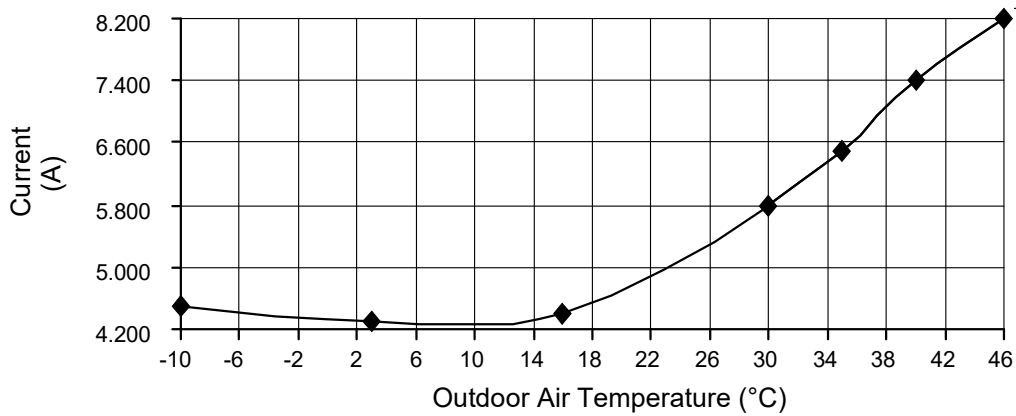
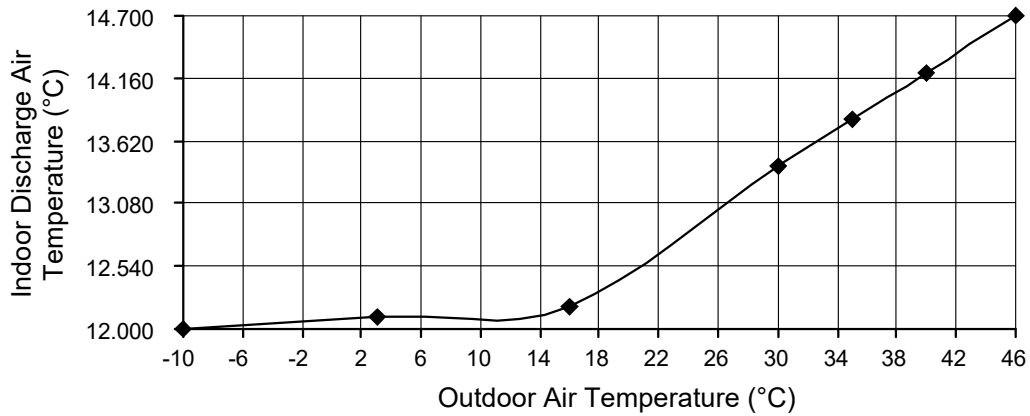



- Cooling Characteristic  
 [Condition] Room temperature: 27°C (DBT), 19°C (WBT)  
 Operation condition: High fan speed  
 Piping Length: 5m  
 Voltage: 230V, 50Hz

D) Indoor unit capacity: Cooling (5.0kW), CS-Z50TKEW, service mode frequency = 49 Hz

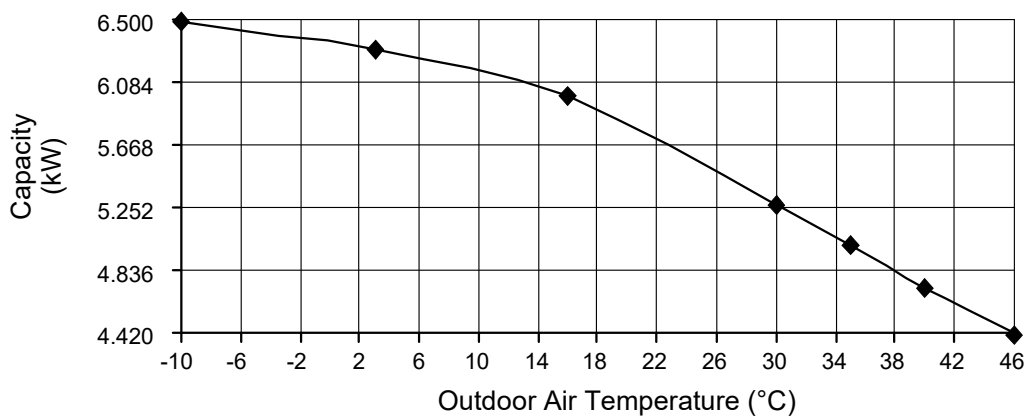
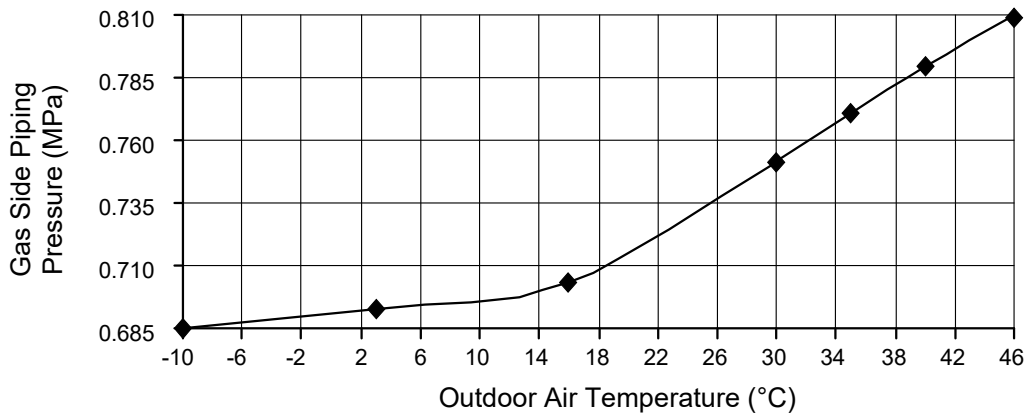
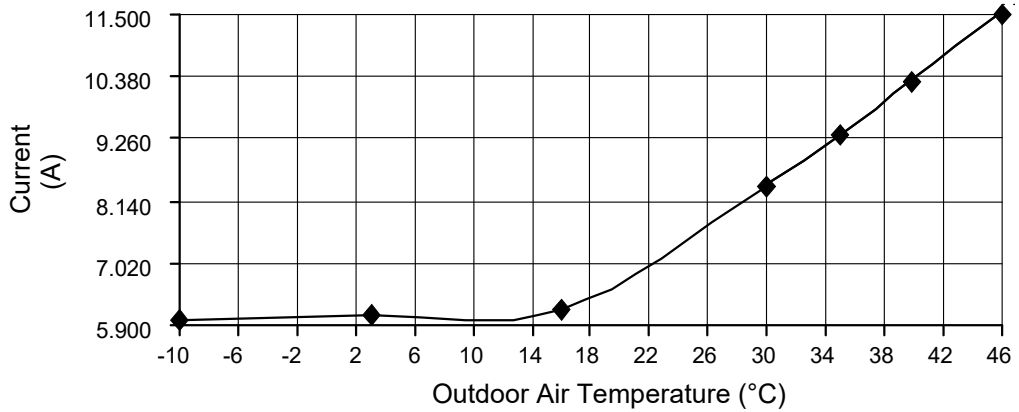
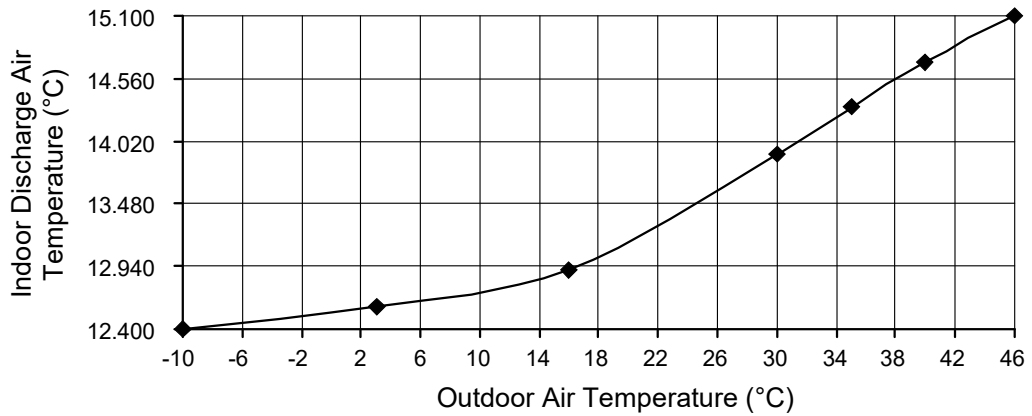

- Heating Characteristic  
 [Condition] Room temperature: 20°C (DBT), 12°C (WBT)  
 Operation condition: High fan speed  
 Piping Length: 5m  
 Voltage: 230V, 50Hz

A) Indoor unit capacity: Heating (2.0kW), CS-Z20TKEW, service mode frequency = 39 Hz

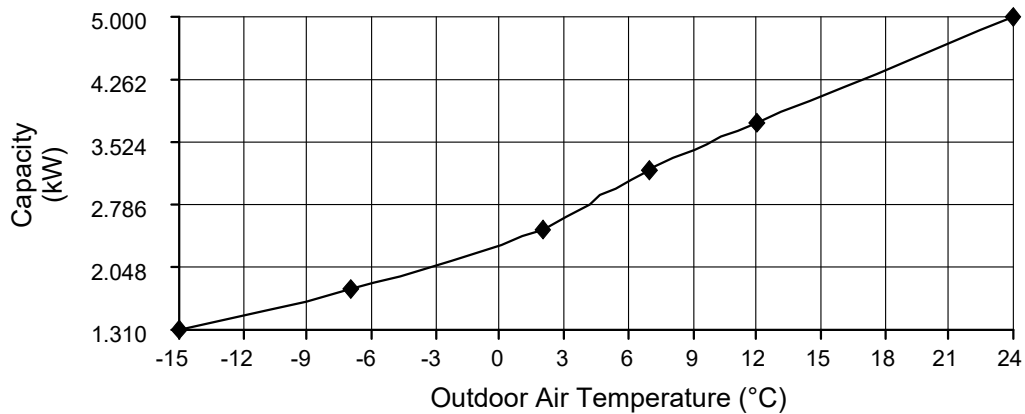
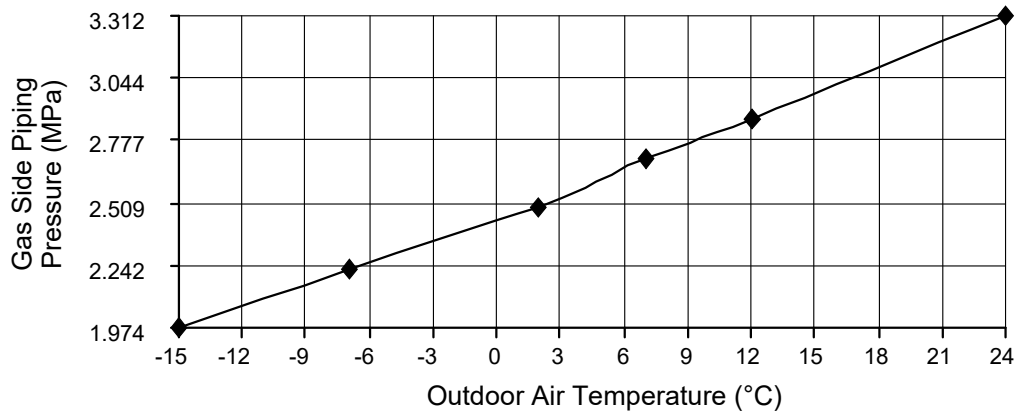
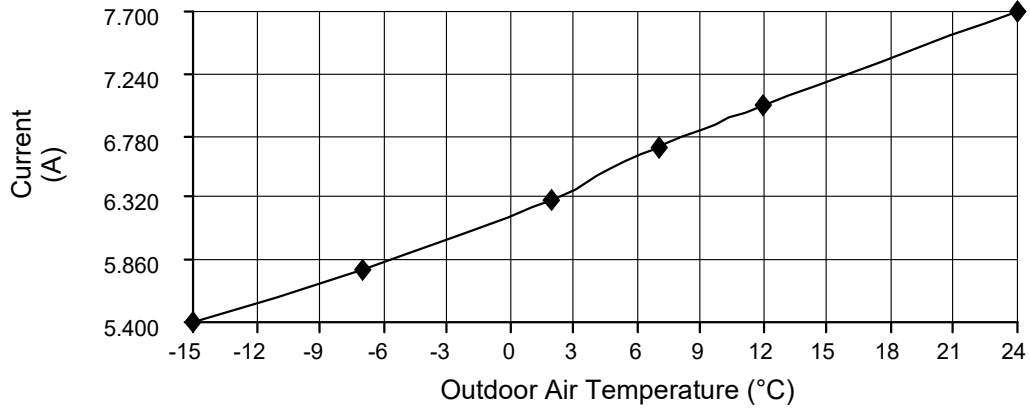
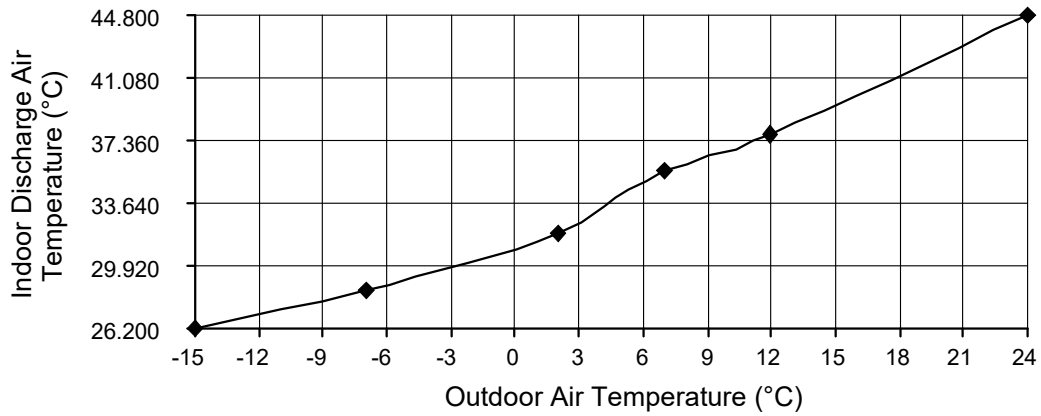

- Heating Characteristic
- [Condition] Room temperature: 20°C (DBT), 12°C (WBT)  
 Operation condition: High fan speed  
 Piping Length: 5m  
 Voltage: 230V, 50Hz

B) Indoor unit capacity: Heating (2.5kW), CS-Z25TKEW, service mode frequency = 39 Hz

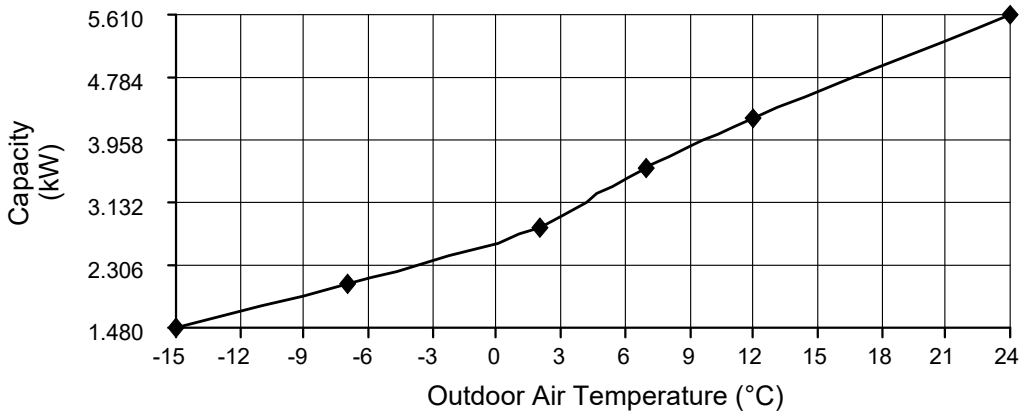
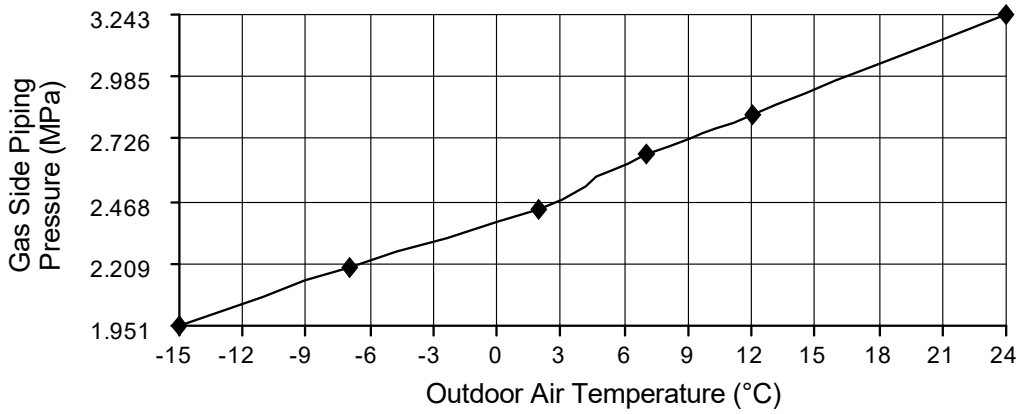
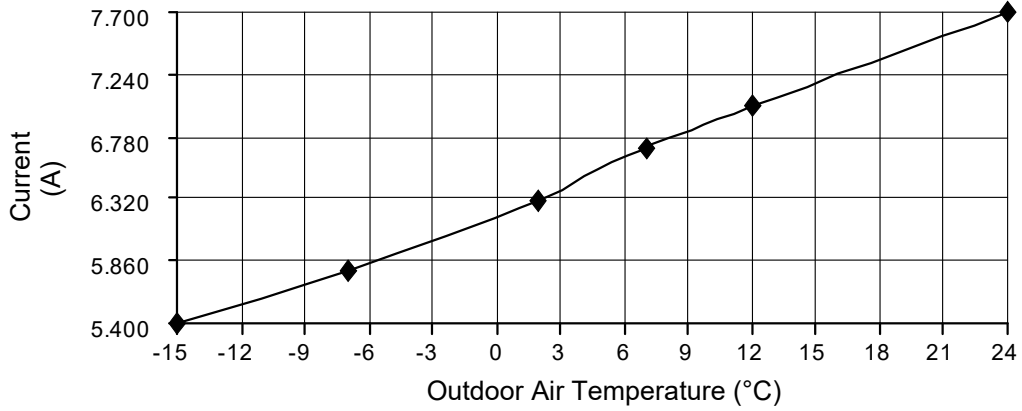
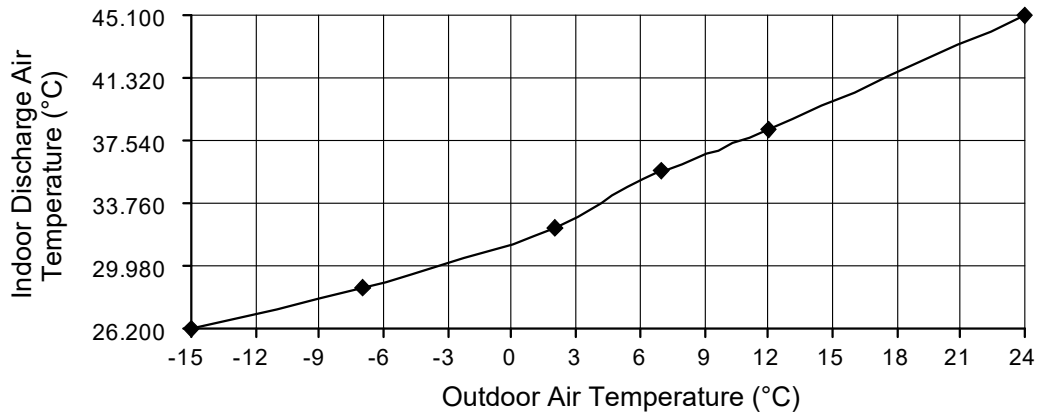

- Heating Characteristic
- [Condition] Room temperature: 20°C (DBT), 12°C (WBT)  
 Operation condition: High fan speed  
 Piping Length: 5m  
 Voltage: 230V, 50Hz

C) Indoor unit capacity: Heating (4.0kW), CS-Z42TKEW, service mode frequency = 47 Hz

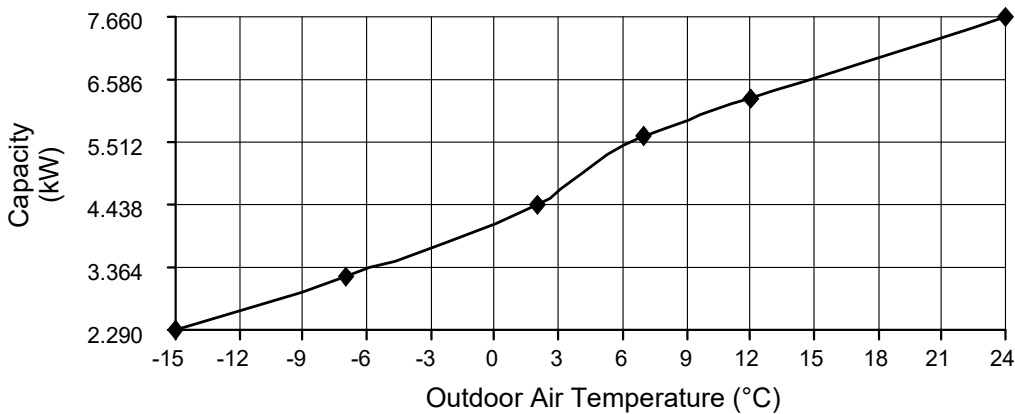
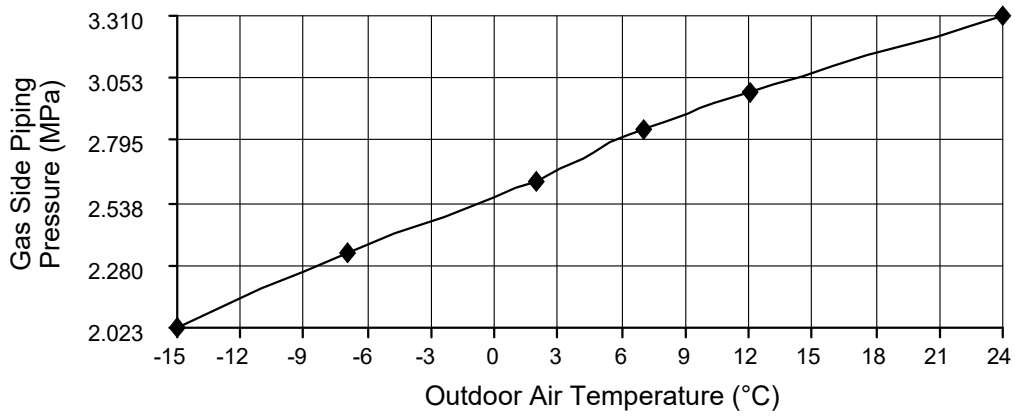
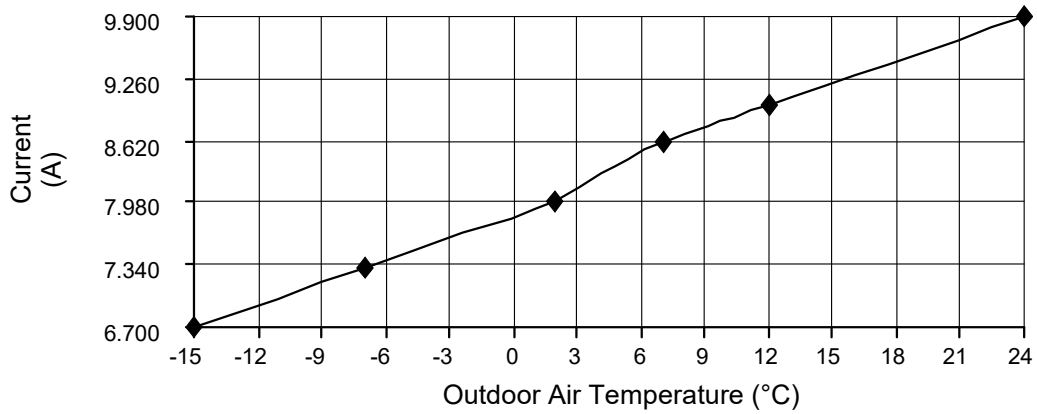
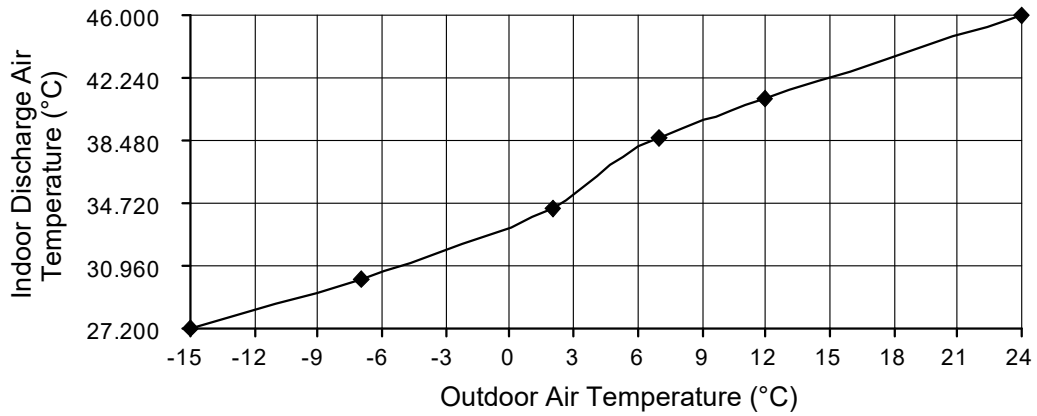

- Heating Characteristic
- [Condition] Room temperature: 20°C (DBT), 12°C (WBT)  
 Operation condition: High fan speed  
 Piping Length: 5m  
 Voltage: 230V, 50Hz

D) Indoor unit capacity: Heating (5.0kW), CS-Z50TKEW, service mode frequency = 55 Hz

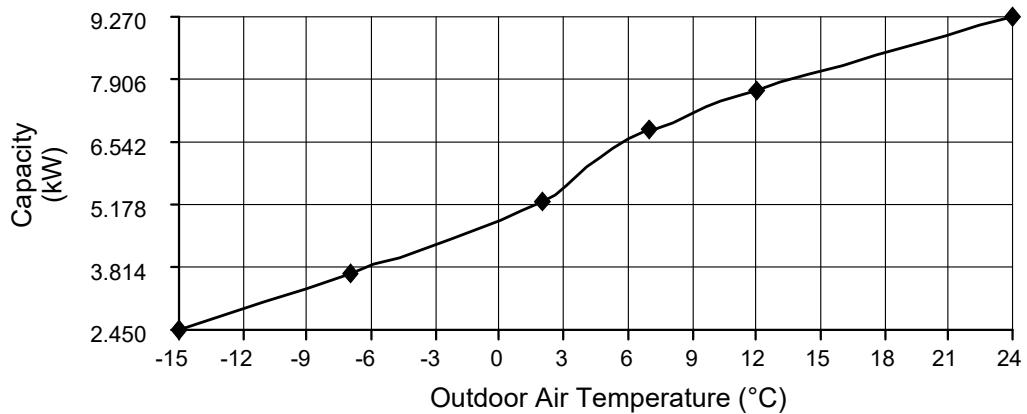
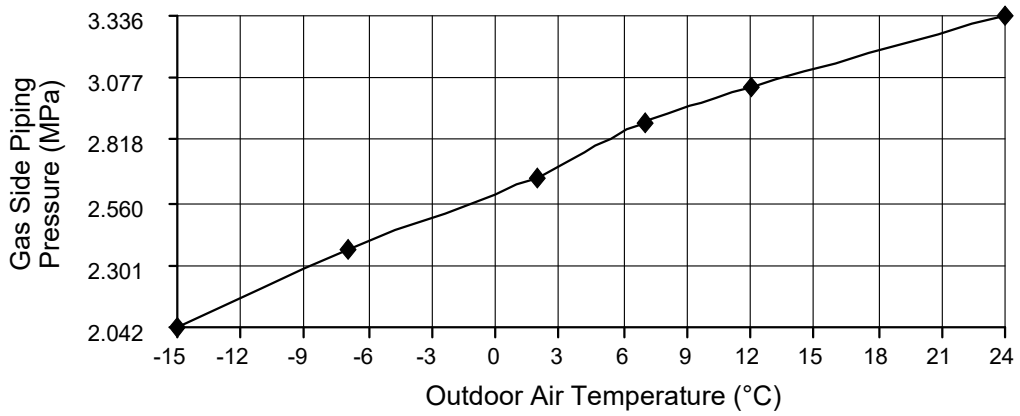
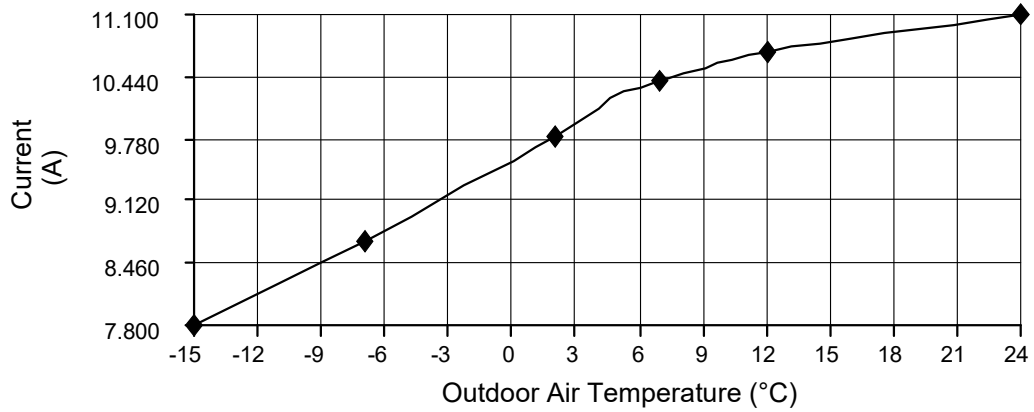
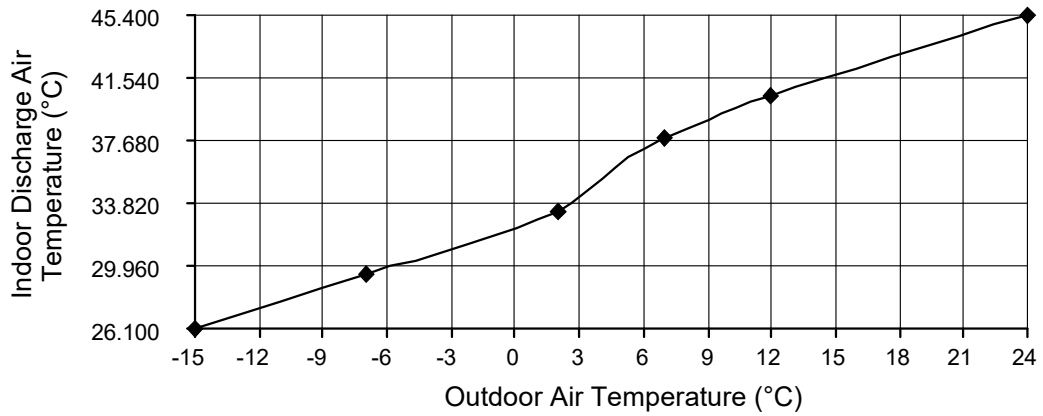

## 19.1.2 Two Indoor Unit Operation

- Cooling Characteristic

[Condition] Room temperature: 27°C (DBT), 19°C (WBT)

Operation condition: High fan speed

Piping Length: 5m

Voltage: 230V, 50Hz

A) Indoor unit capacity: Cooling (2.0kW + 2.5kW), CS-Z20TKEW + CS-Z25TKEW, service mode frequency = 49 Hz

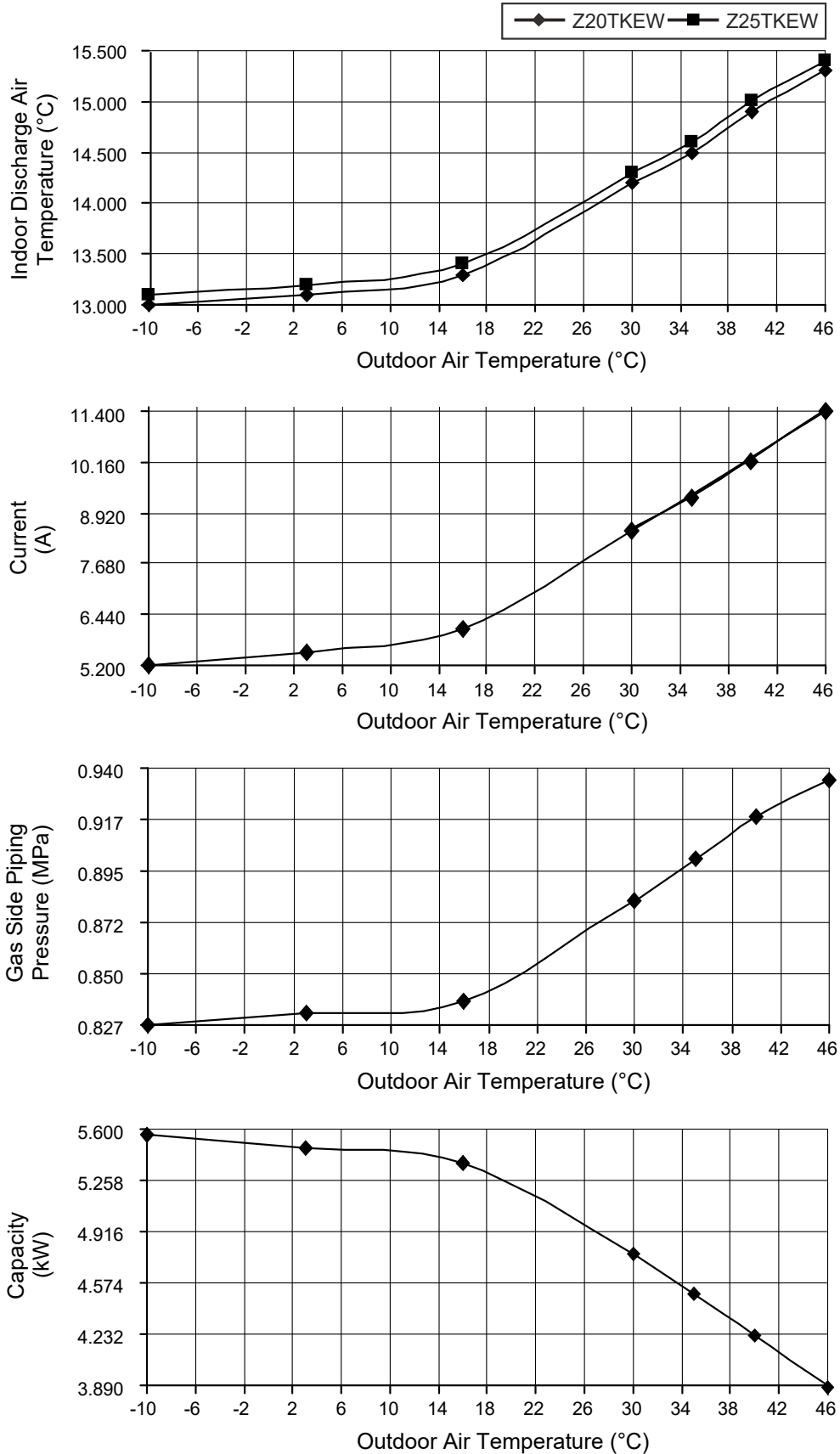

- Cooling Characteristic
- [Condition] Room temperature: 27°C (DBT), 19°C (WBT)  
 Operation condition: High fan speed  
 Piping Length: 5m  
 Voltage: 230V, 50Hz

B) Indoor unit capacity: Cooling (2.0kW + 4.2kW), CS-Z20TKEW + CS-Z42TKEW, service mode frequency = 49 Hz

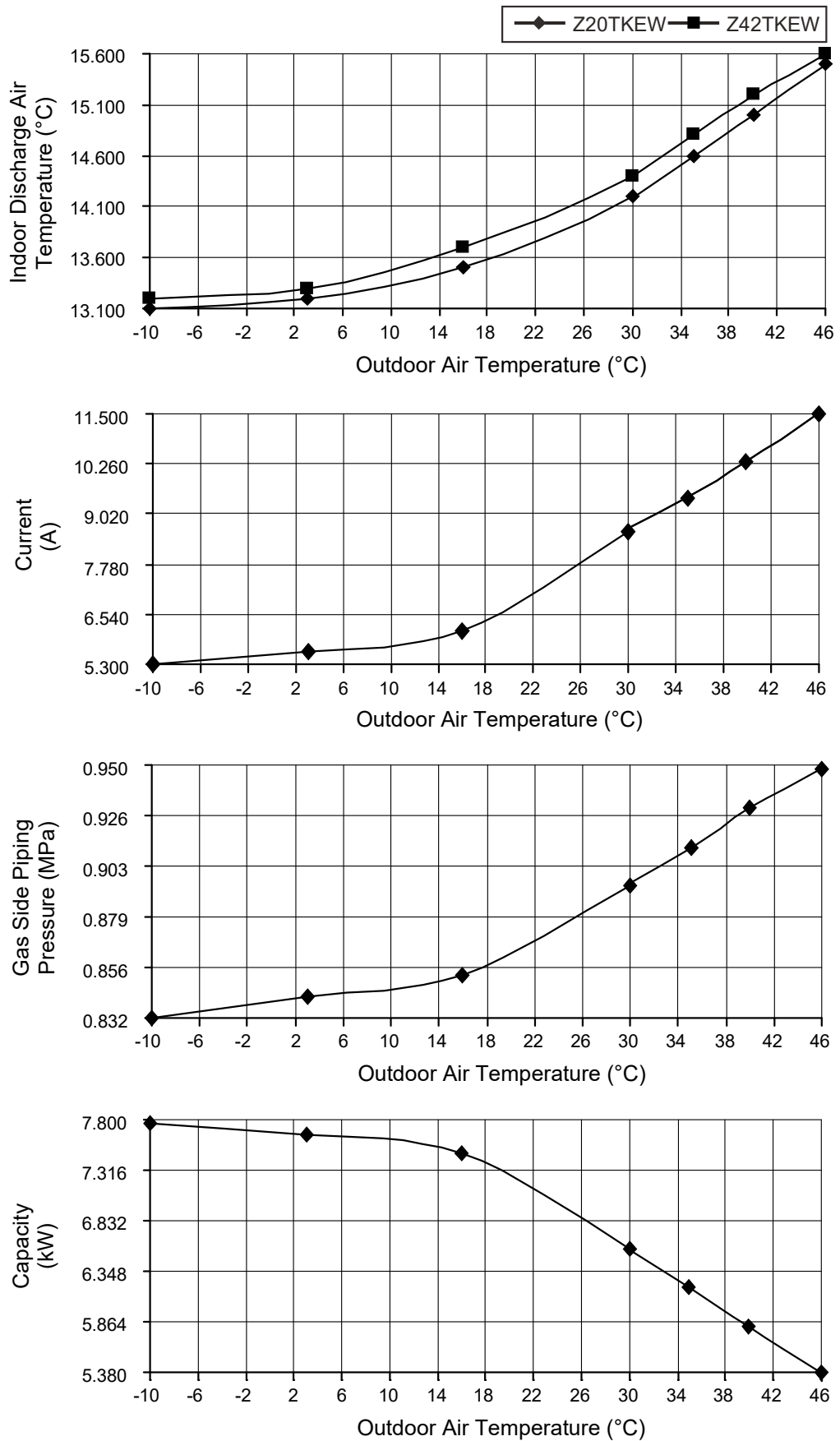

- Cooling Characteristic
- [Condition] Room temperature: 27°C (DBT), 19°C (WBT)  
 Operation condition: High fan speed  
 Piping Length: 5m  
 Voltage: 230V, 50Hz

C) Indoor unit capacity: Cooling (2.0kW + 5.0kW), CS-Z20TKEW + CS-Z50TKEW, service mode frequency = 51 Hz

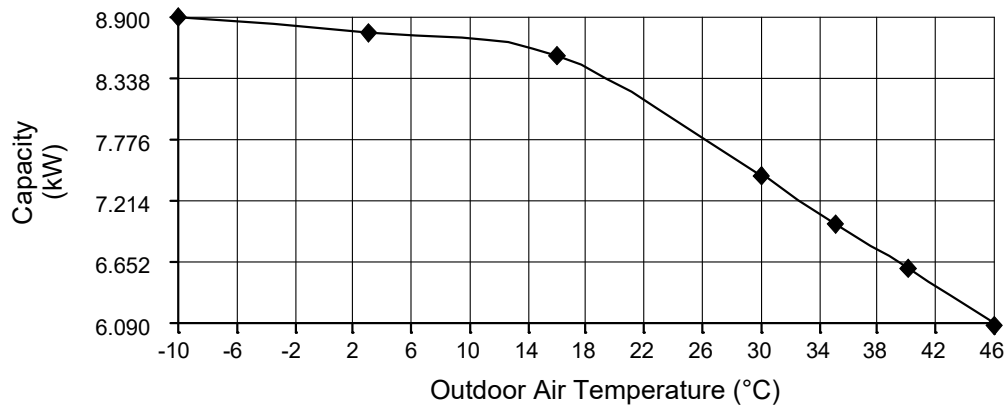
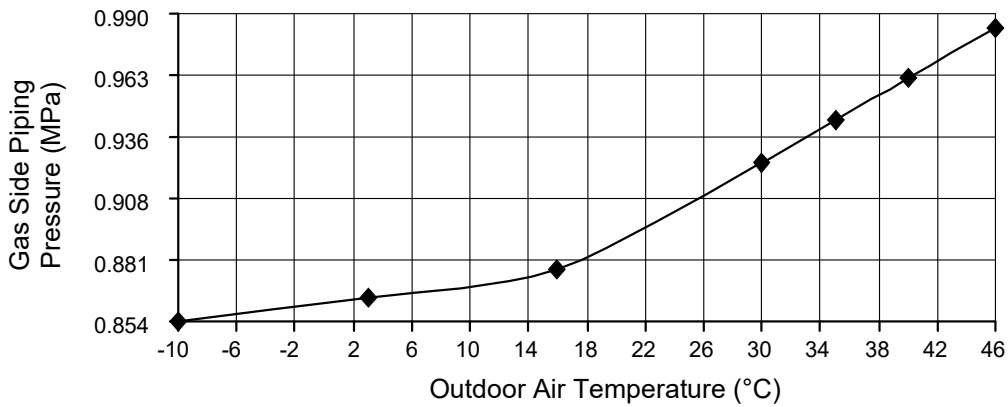
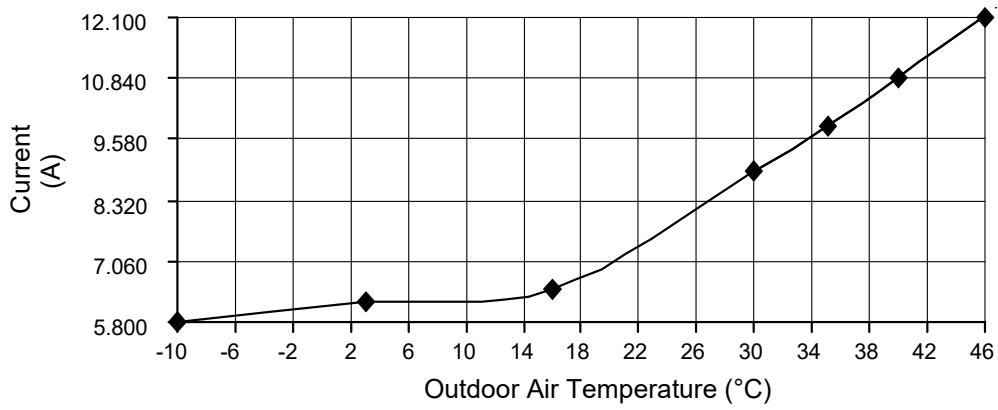
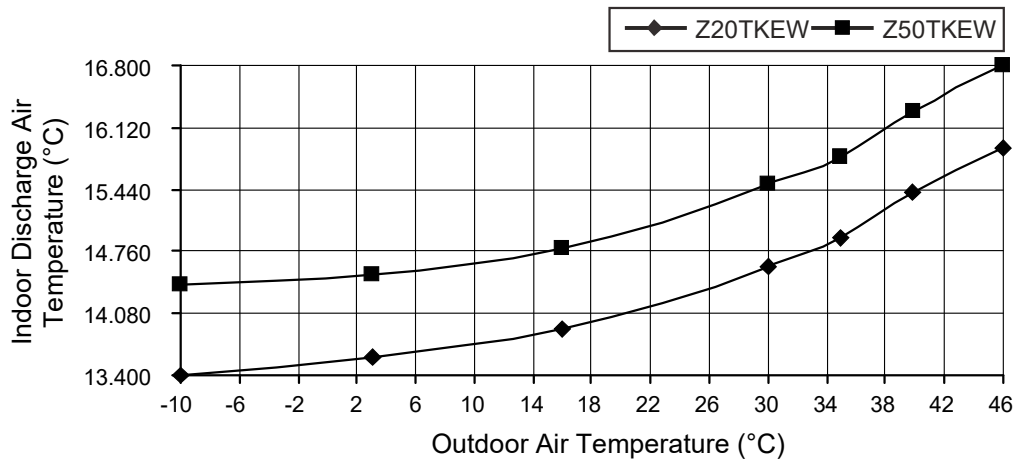



- Cooling Characteristic  
 [Condition] Room temperature: 27°C (DBT), 19°C (WBT)  
 Operation condition: High fan speed  
 Piping Length: 5m  
 Voltage: 230V, 50Hz

D) Indoor unit capacity: Cooling (2.5kW + 4.2kW), CS-Z25TKEW + CS-Z42TKEW, service mode frequency = 49 Hz

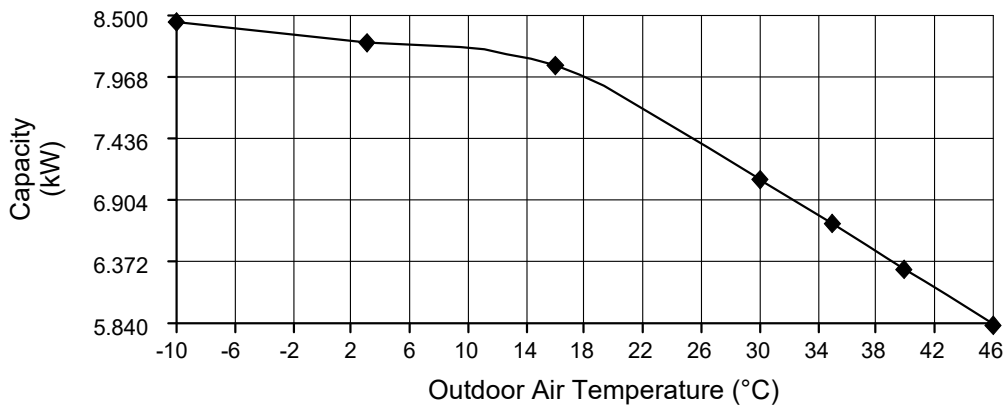
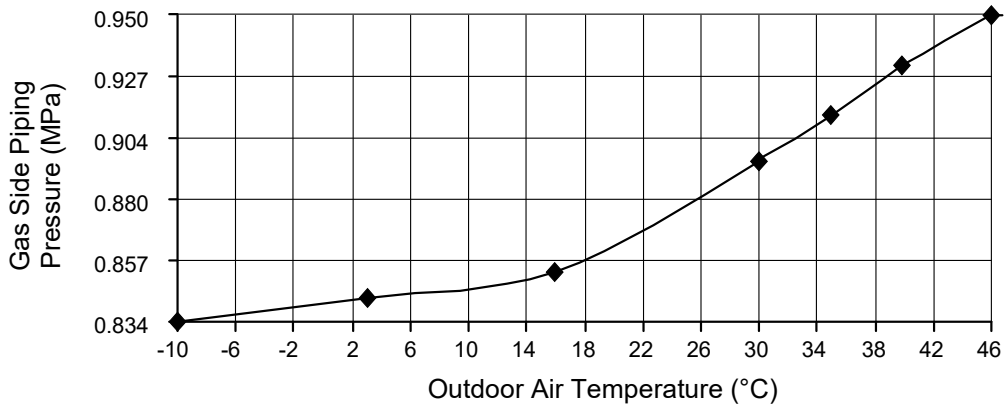
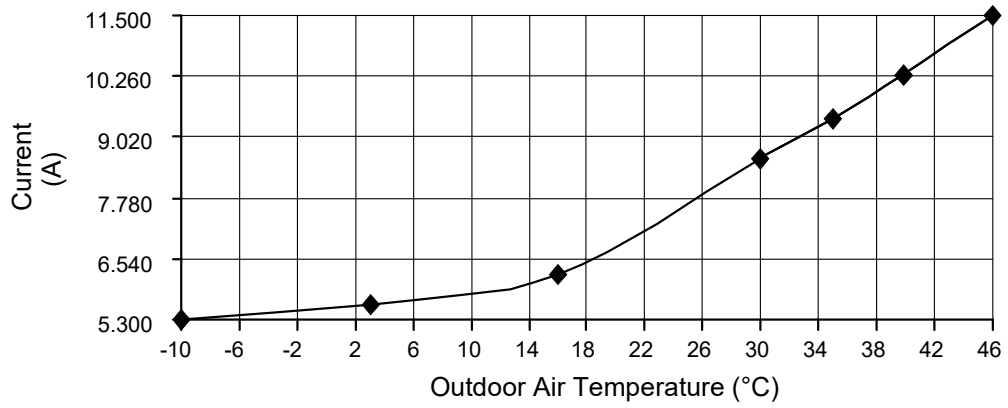
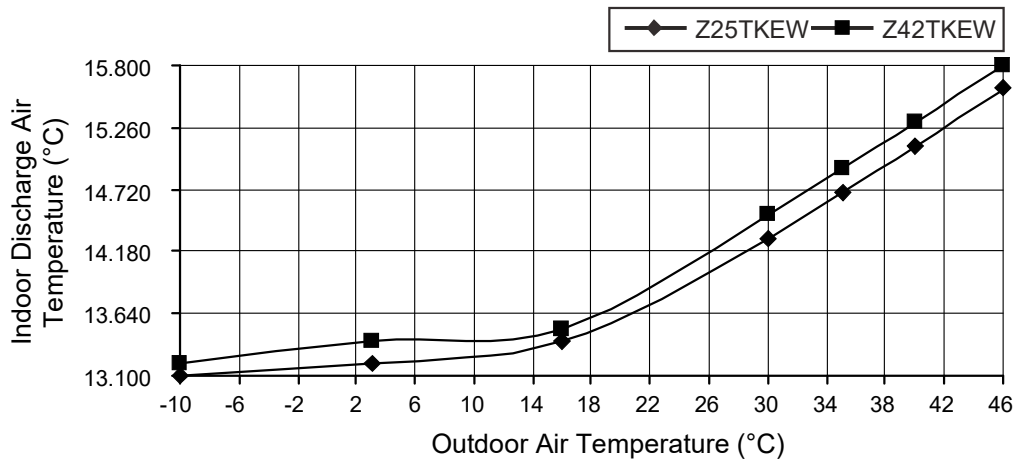

- Cooling Characteristic
- [Condition] Room temperature: 27°C (DBT), 19°C (WBT)  
 Operation condition: High fan speed  
 Piping Length: 5m  
 Voltage: 230V, 50Hz

E) Indoor unit capacity: Cooling (2.5kW + 5.0kW), CS-Z25TKEW + CS-Z50TKEW, service mode frequency = 51 Hz

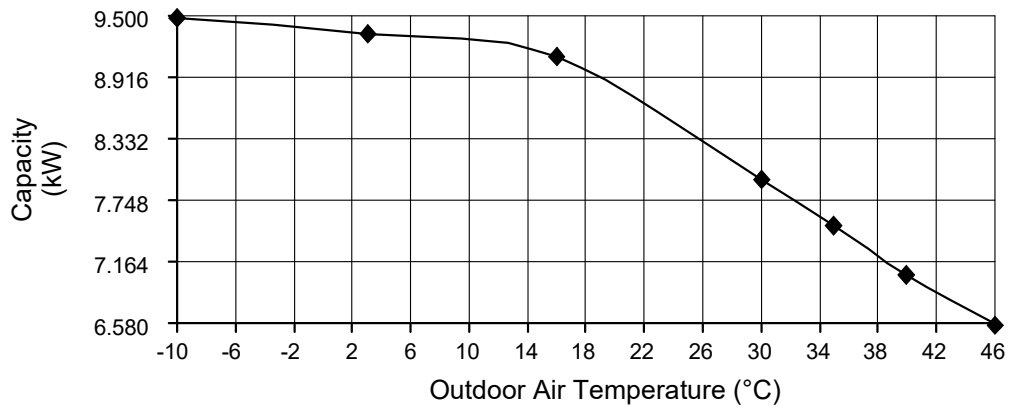
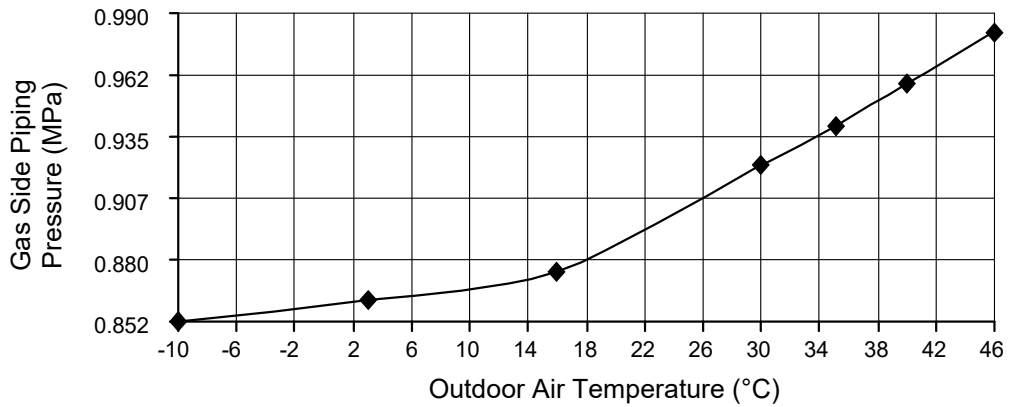
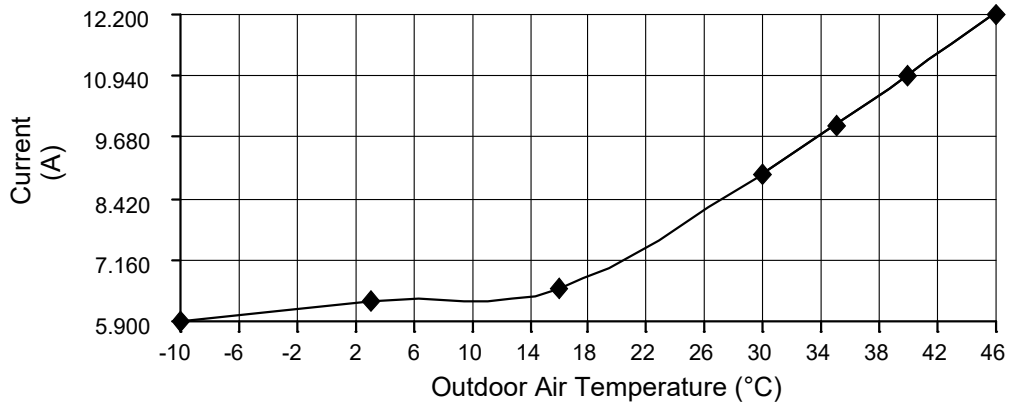
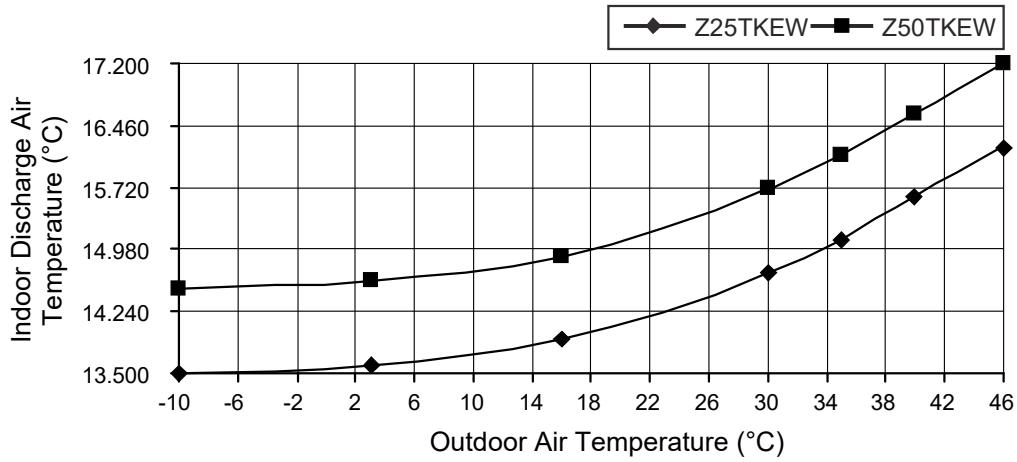

- Cooling Characteristic  
 [Condition] Room temperature: 27°C (DBT), 19°C (WBT)  
 Operation condition: High fan speed  
 Piping Length: 5m  
 Voltage: 230V, 50Hz

F) Indoor unit capacity: Cooling (4.2kW + 5.0kW), CS-Z42TKEW + CS-Z50TKEW, service mode frequency = 53 Hz

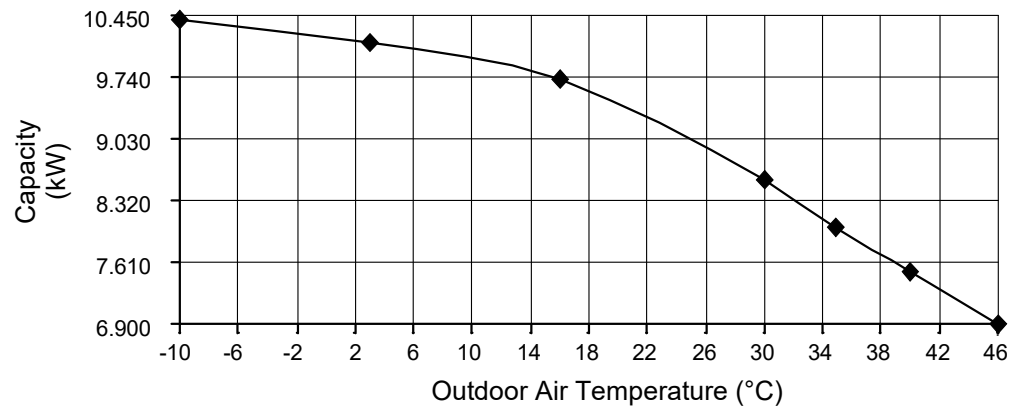
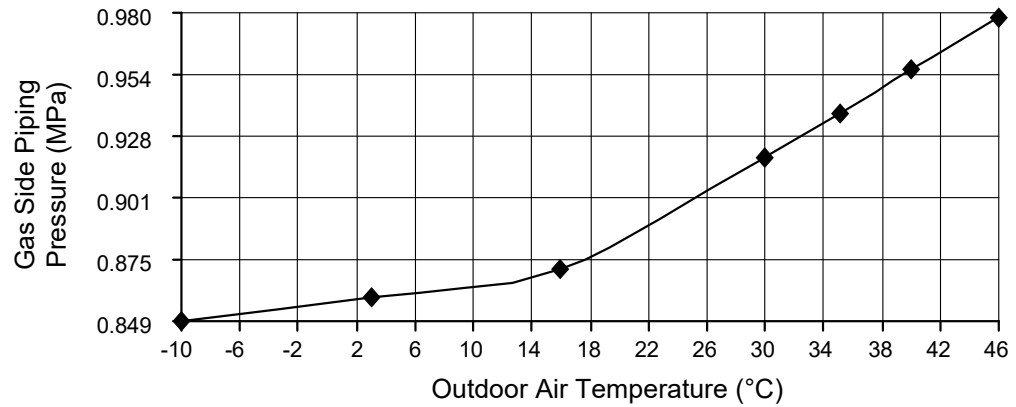
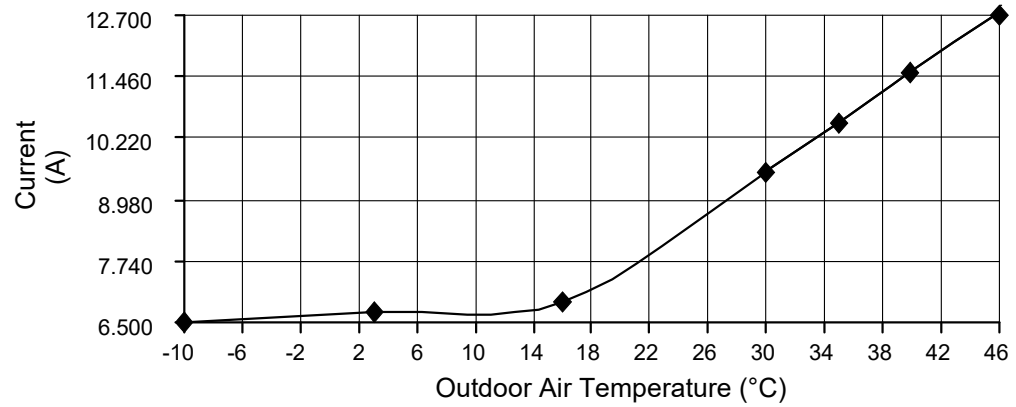
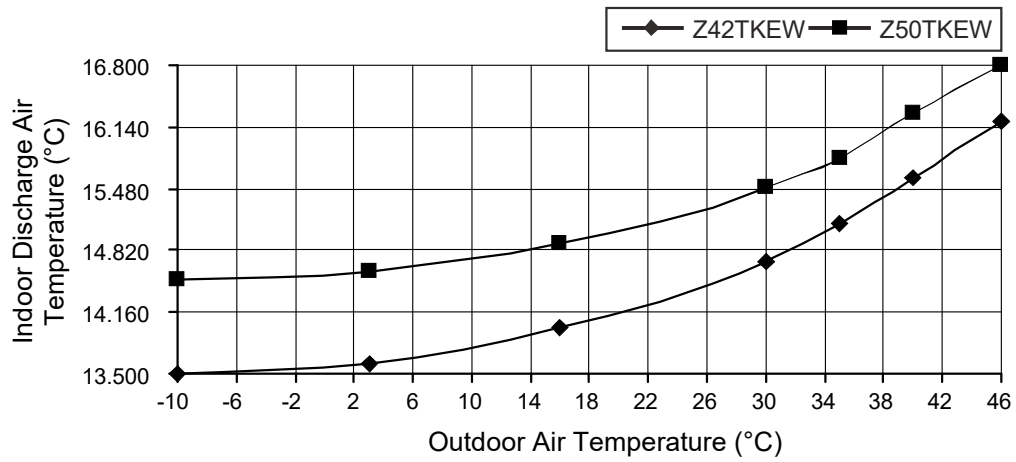

- Heating Characteristic
- [Condition] Room temperature: 20°C (DBT), 12°C (WBT)  
 Operation condition: High fan speed  
 Piping Length: 5m  
 Voltage: 230V, 50Hz

A) Indoor unit capacity: Heating (2.0kW + 2.5kW), CS-Z20TKEW + CS-Z25TKEW, service mode frequency = 58 Hz

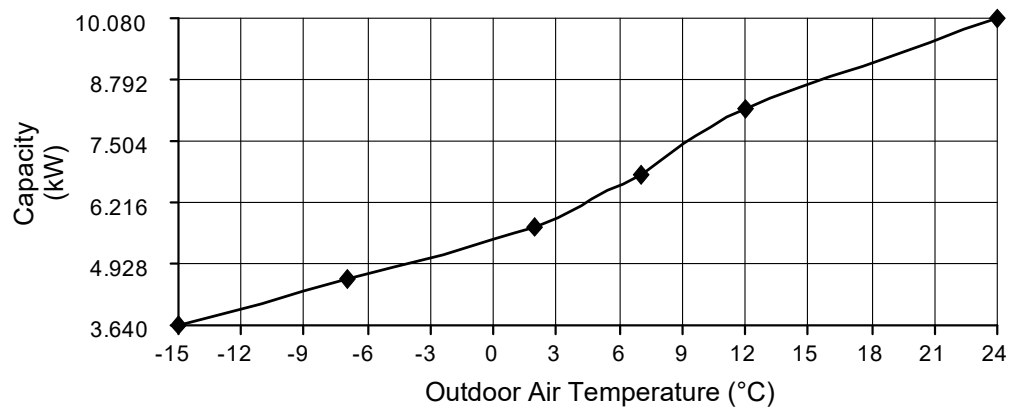
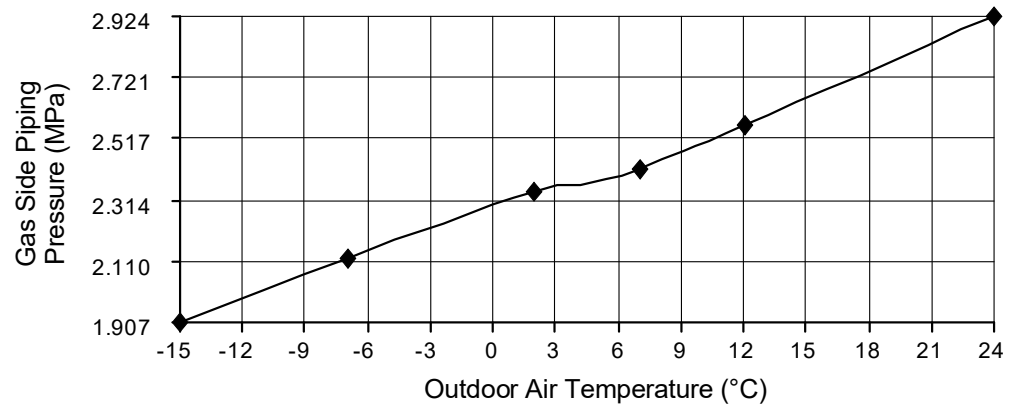
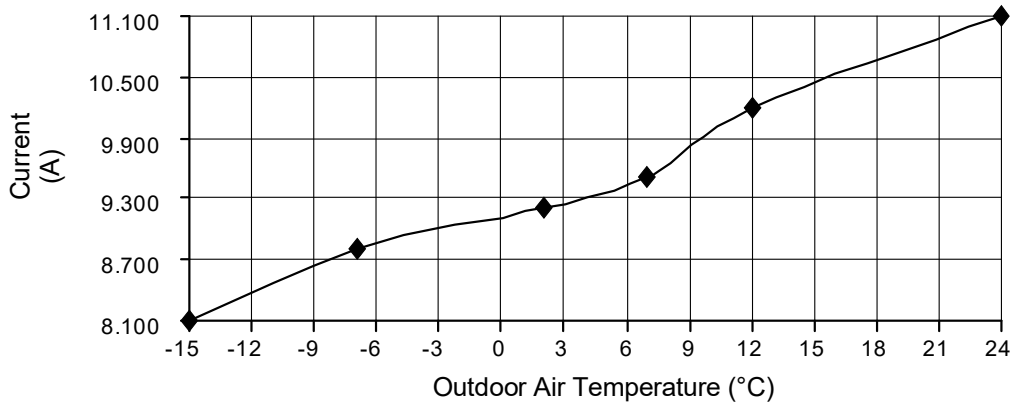
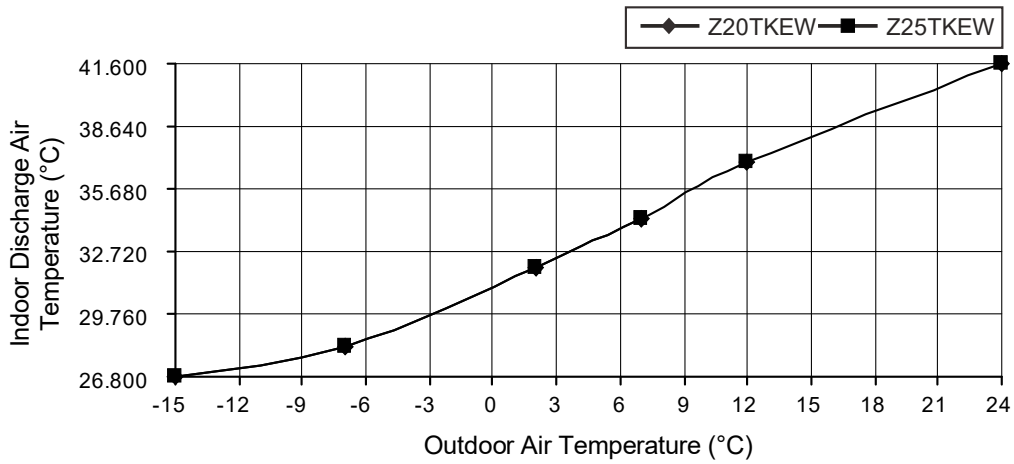

- Heating Characteristic
- [Condition] Room temperature: 20°C (DBT), 12°C (WBT)  
 Operation condition: High fan speed  
 Piping Length: 5m  
 Voltage: 230V, 50Hz

B) Indoor unit capacity: Heating (2.0kW + 4.0kW), CS-Z20TKEW + CS-Z42TKEW, service mode frequency = 64 Hz

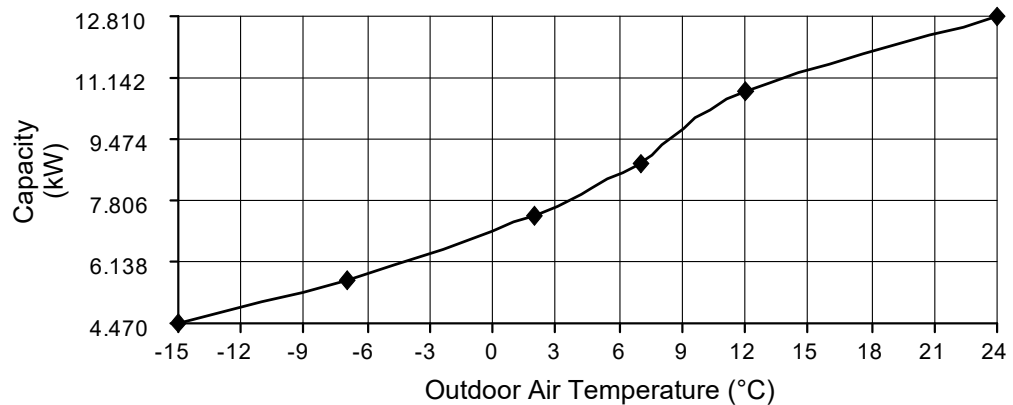
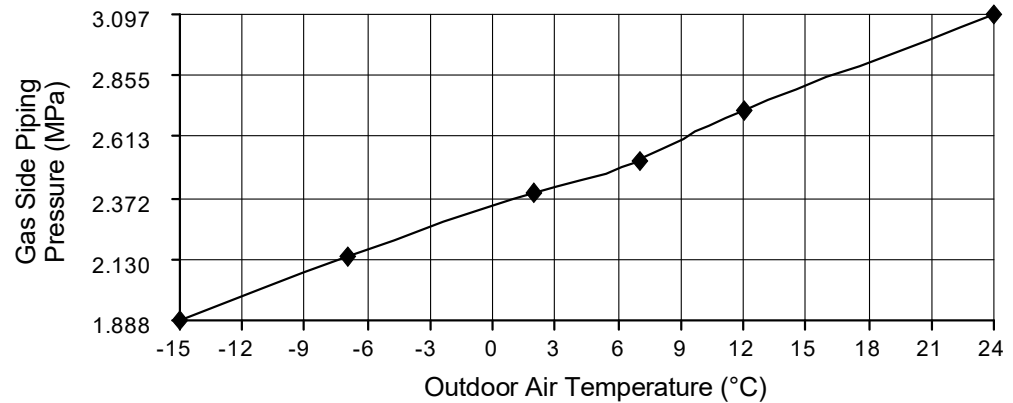
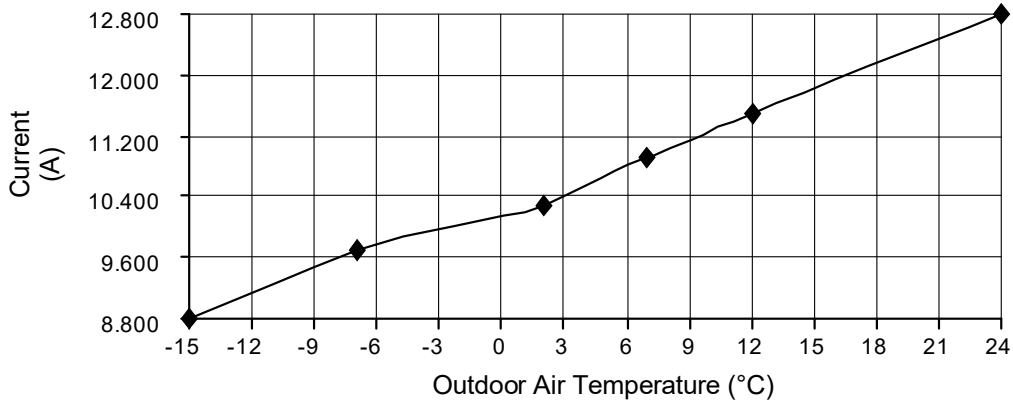
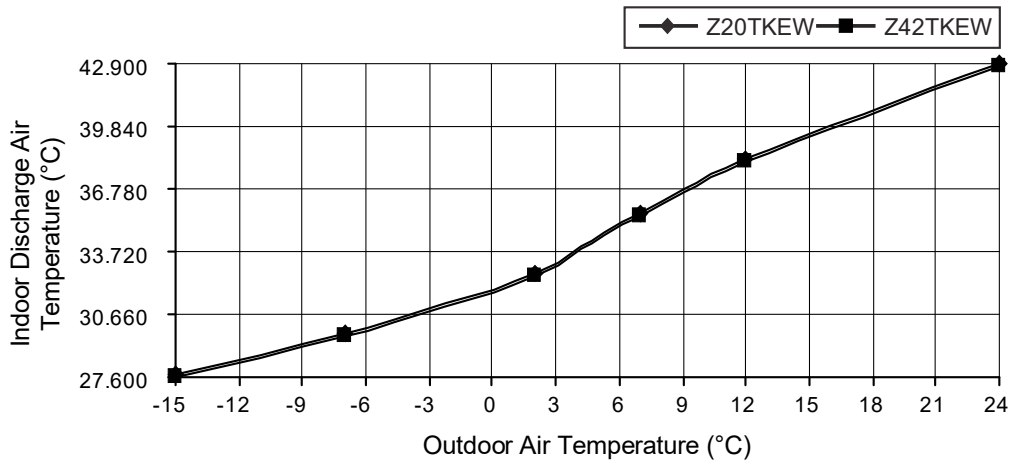

- Heating Characteristic
- [Condition] Room temperature: 20°C (DBT), 12°C (WBT)  
 Operation condition: High fan speed  
 Piping Length: 5m  
 Voltage: 230V, 50Hz

C) Indoor unit capacity: Heating (2.0kW + 5.0kW), CS-Z20TKEW + CS-Z50TKEW, service mode frequency = 68 Hz

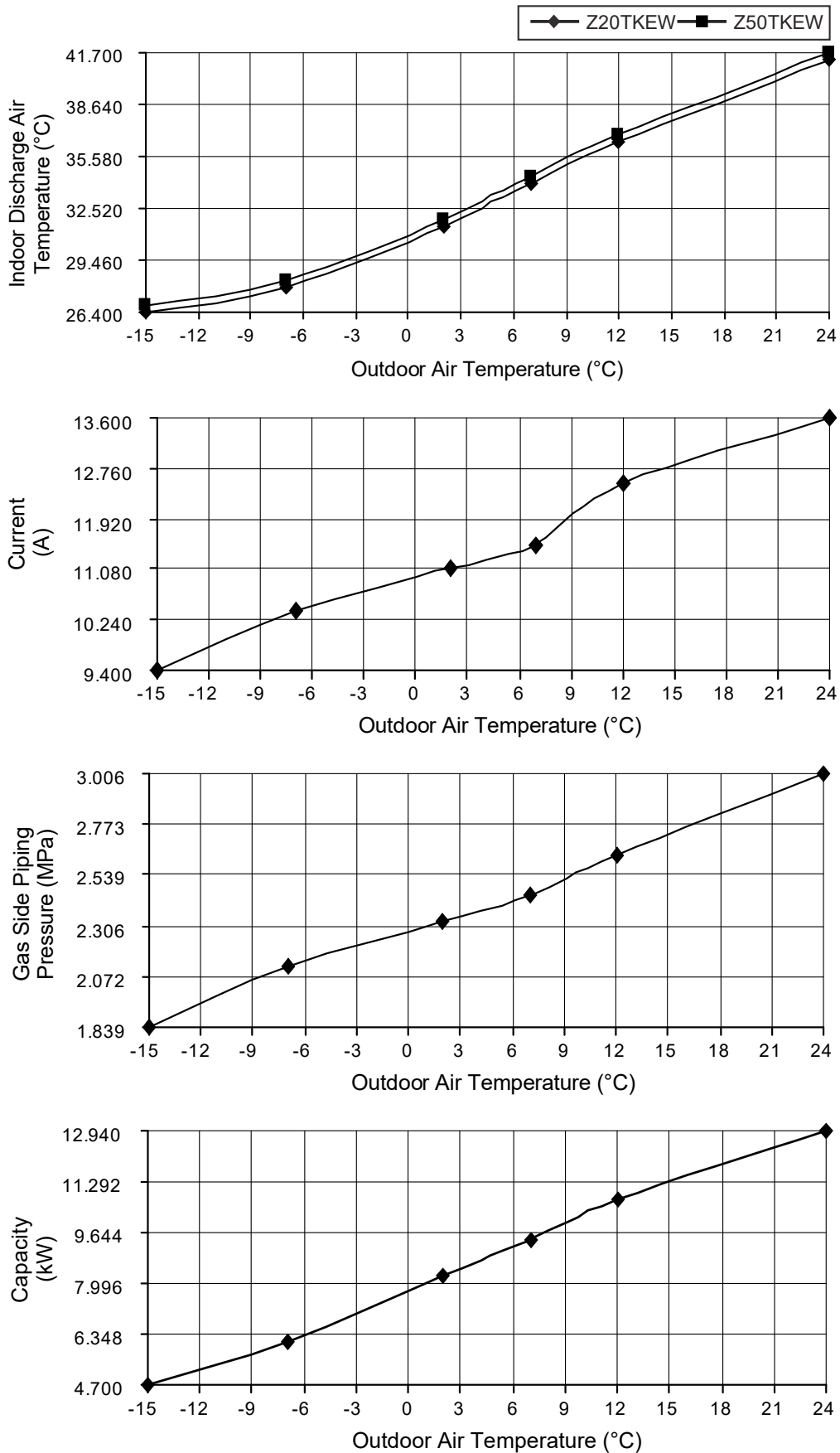

- Heating Characteristic
- [Condition] Room temperature: 20°C (DBT), 12°C (WBT)  
 Operation condition: High fan speed  
 Piping Length: 5m  
 Voltage: 230V, 50Hz

D) Indoor unit capacity: Heating (2.5kW + 4.0kW), CS-Z25TKEW + CS-Z42TKEW, service mode frequency = 64 Hz

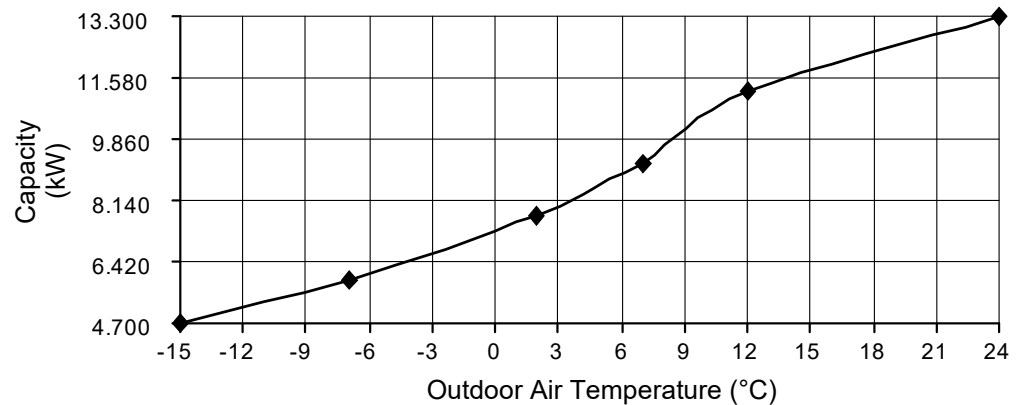
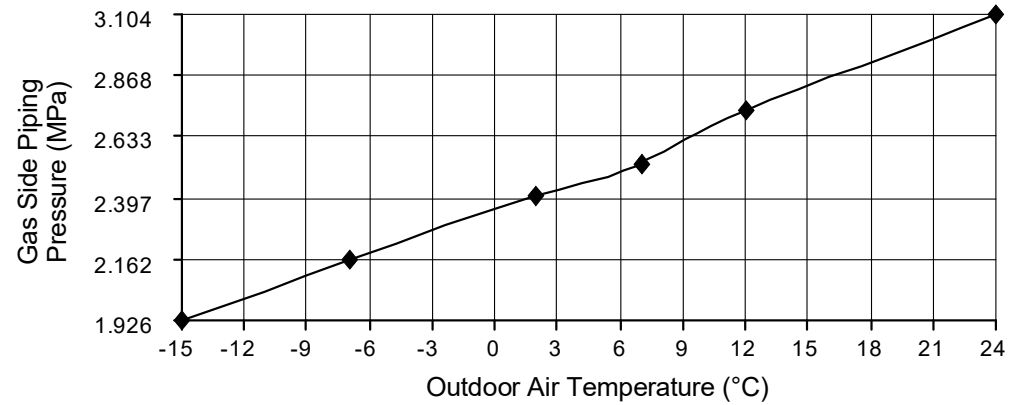
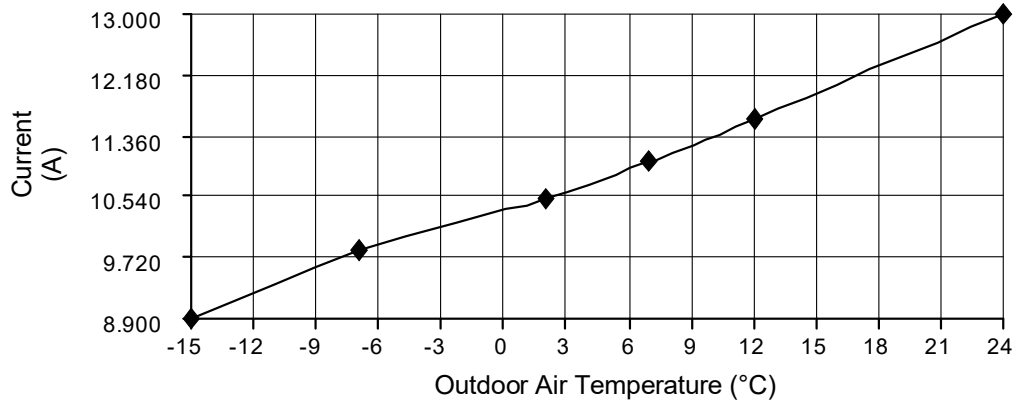
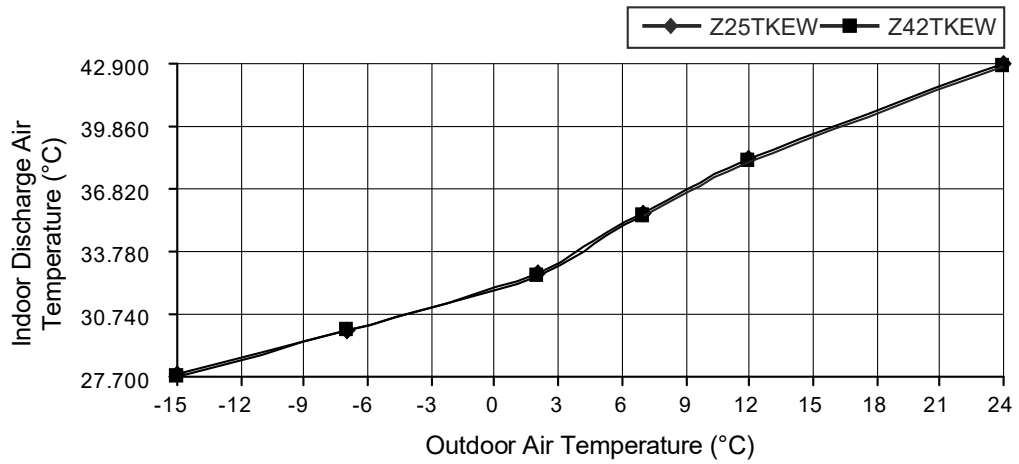

- Heating Characteristic  
 [Condition] Room temperature: 20°C (DBT), 12°C (WBT)  
 Operation condition: High fan speed  
 Piping Length: 5m  
 Voltage: 230V, 50Hz

E) Indoor unit capacity: Heating (2.5kW + 5.0kW), CS-Z25TKEW + CS-Z50TKEW, service mode frequency = 68 Hz

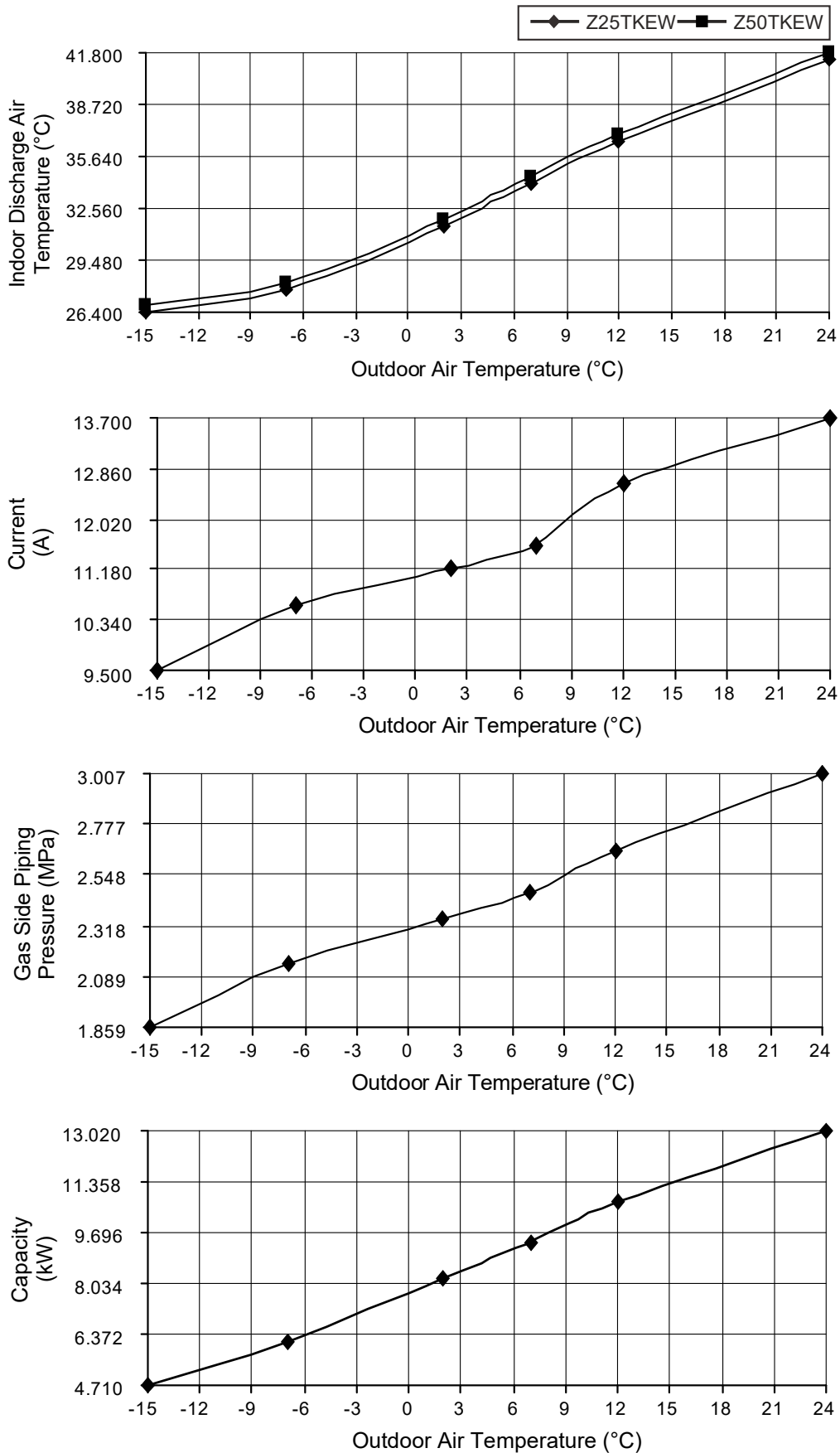



- Heating Characteristic
- [Condition] Room temperature: 20°C (DBT), 12°C (WBT)  
 Operation condition: High fan speed  
 Piping Length: 5m  
 Voltage: 230V, 50Hz

F) Indoor unit capacity: Heating (4.0kW + 5.0kW), CS-Z42TKEW + CS-Z50TKEW, service mode frequency = 73 Hz

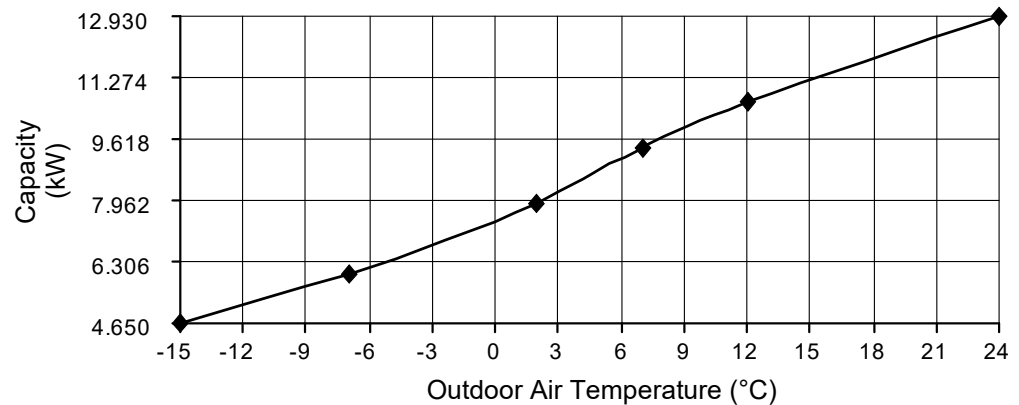
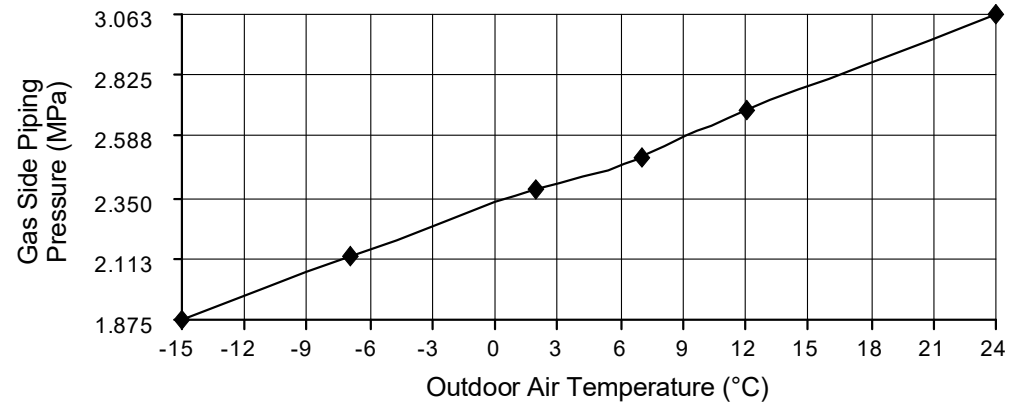
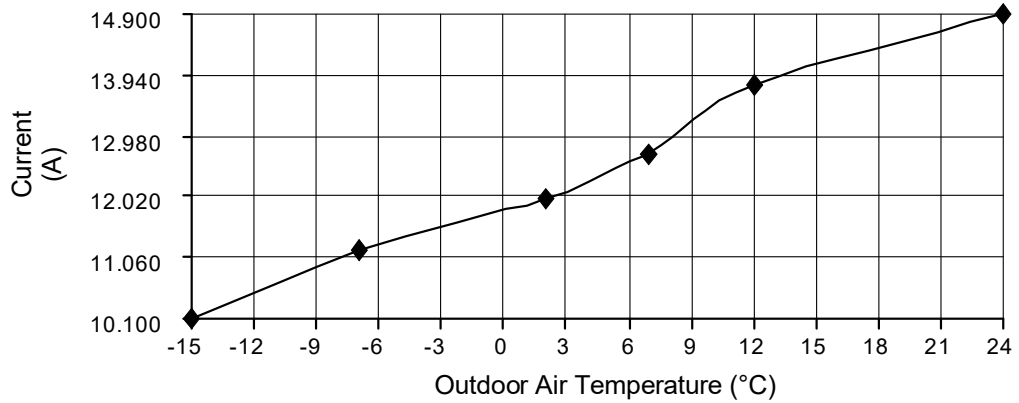
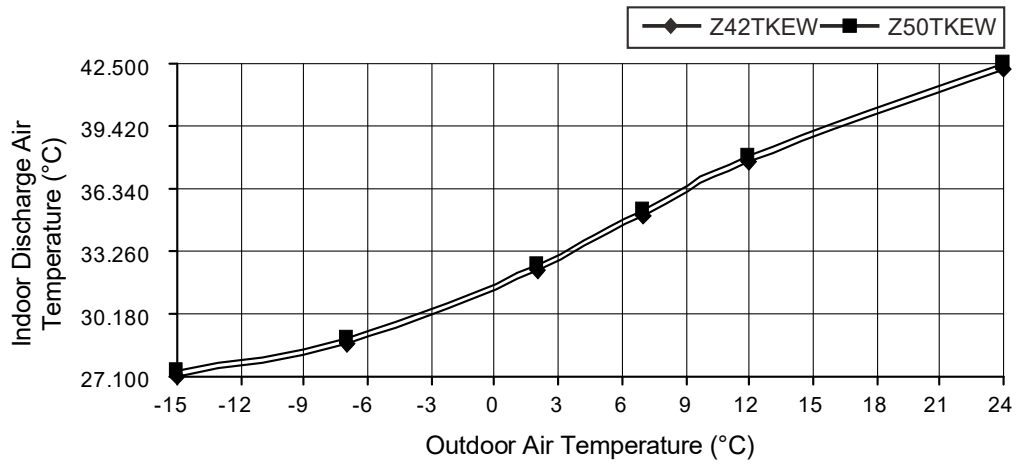

### 19.1.3 Three Indoor Units Operation

- Cooling Characteristic

[Condition] Room temperature: 27°C (DBT), 19°C (WBT)

Operation condition: High fan speed

Piping Length: 5m

Voltage: 230V, 50Hz

A) Indoor unit capacity: Cooling (2.0kW + 2.5kW + 4.2kW), CS-Z20TKEW + CS-Z25TKEW + CS-Z42TKEW, service mode frequency = 55 Hz

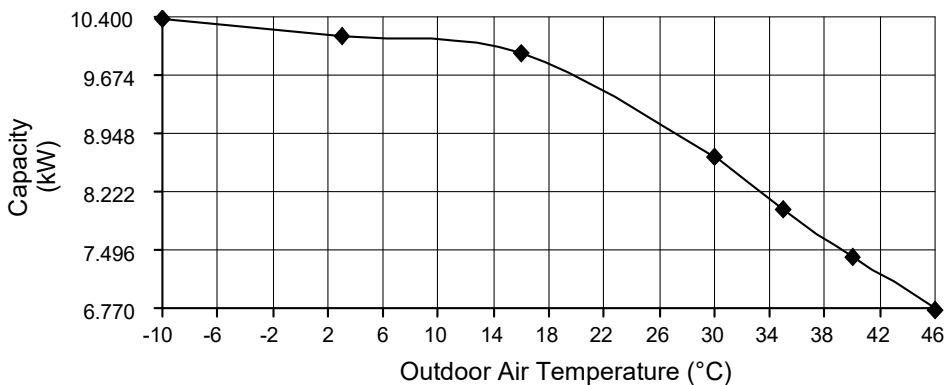
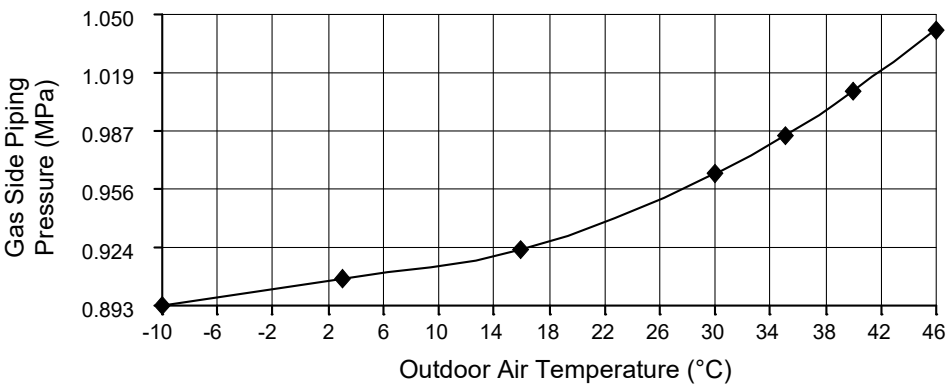
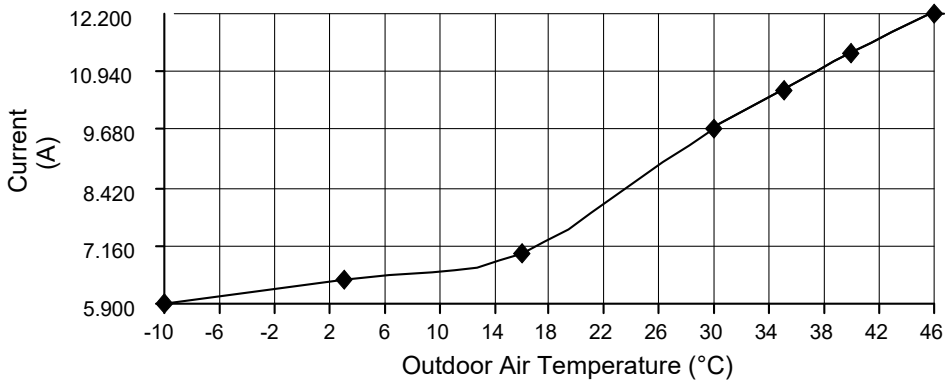
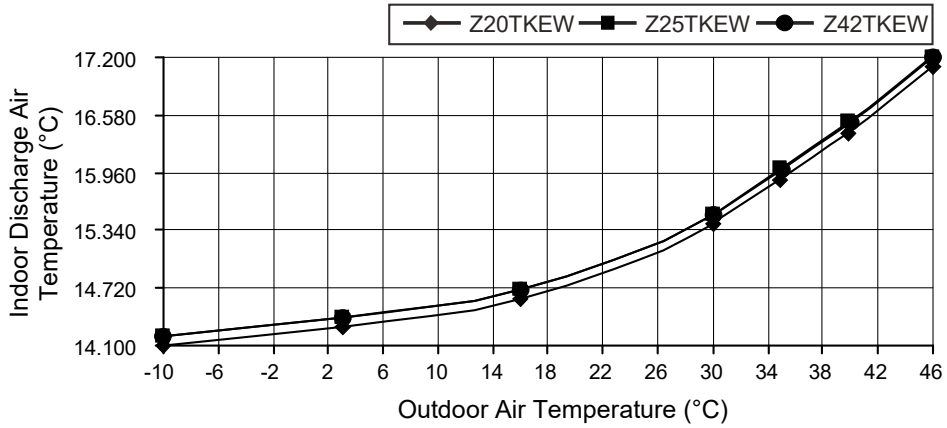

- Cooling Characteristic  
 [Condition] Room temperature: 27°C (DBT), 19°C (WBT)  
 Operation condition: High fan speed  
 Piping Length: 5m  
 Voltage: 230V, 50Hz

B) Indoor unit capacity: Cooling (2.0kW + 2.5kW + 5.0kW), CS-Z20TKEW + CS-Z25TKEW + CS-Z50TKEW, service mode frequency = 57 Hz

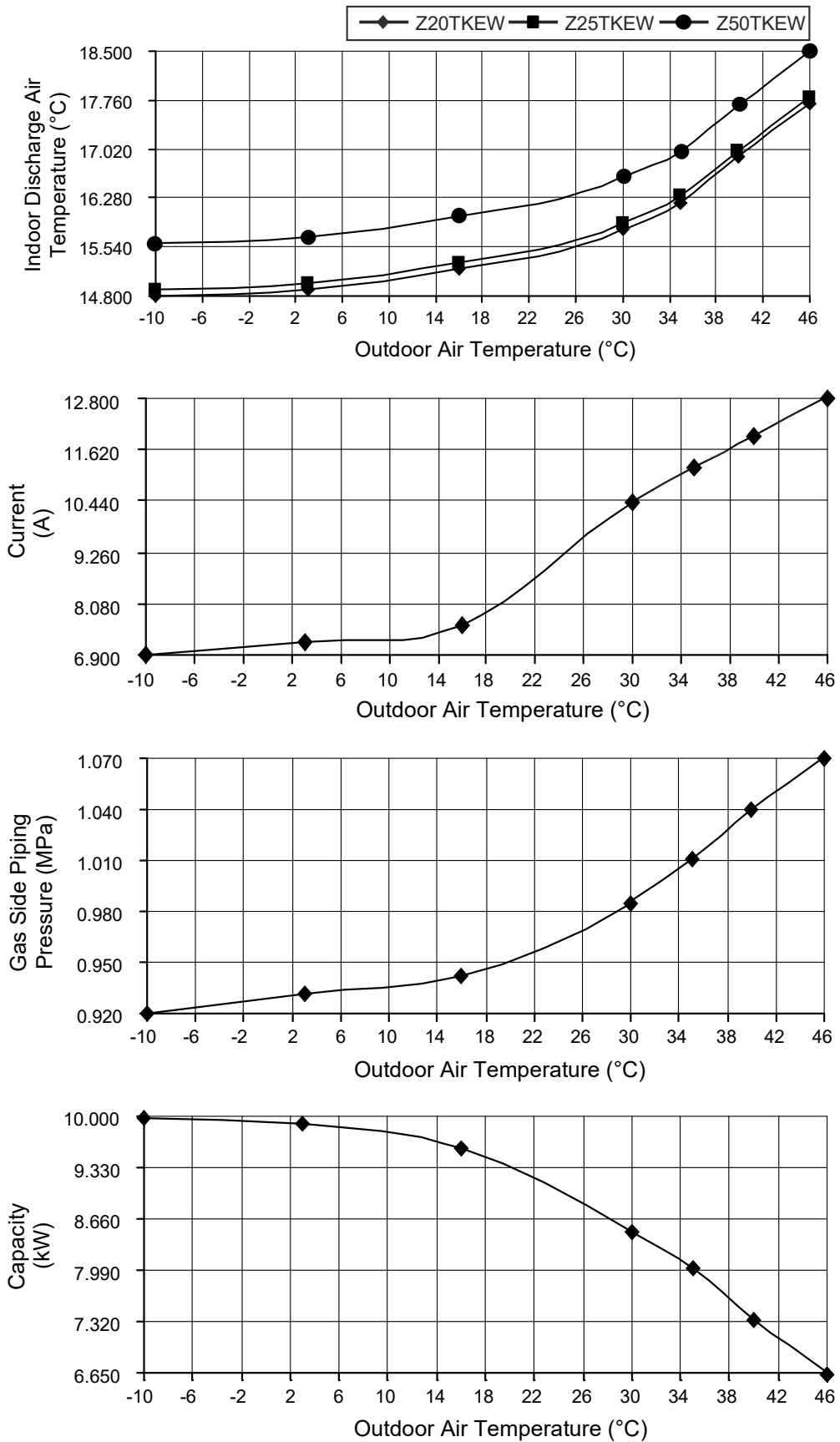

- Cooling Characteristic  
 [Condition] Room temperature: 27°C (DBT), 19°C (WBT)  
 Operation condition: High fan speed  
 Piping Length: 5m  
 Voltage: 230V, 50Hz

C) Indoor unit capacity: Cooling (2.0kW + 4.2kW + 5.0kW), CS-Z20TKEW + CS-Z42TKEW + CS-Z50TKEW, service mode frequency = 59 Hz

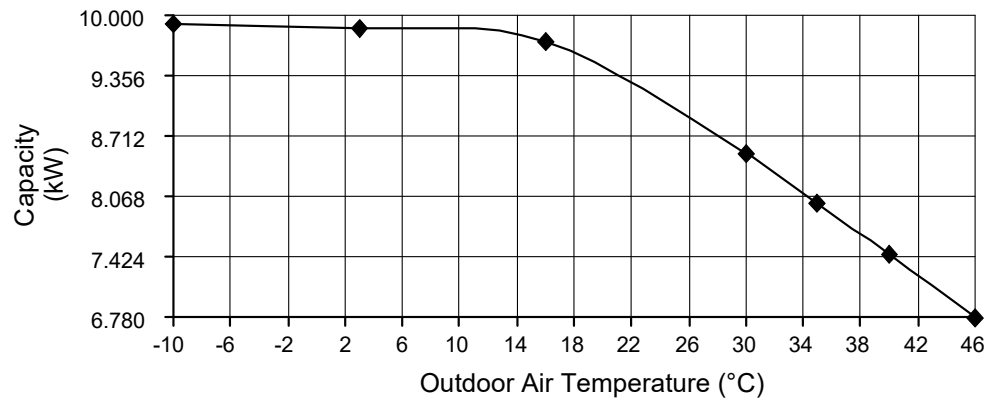
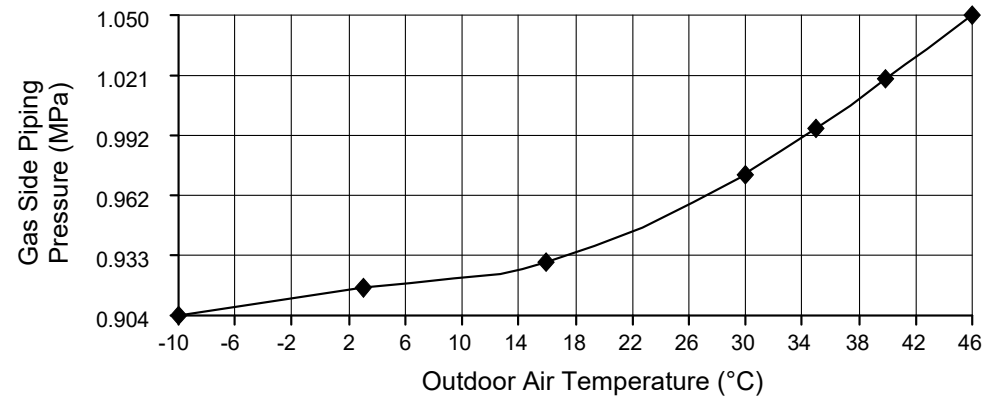
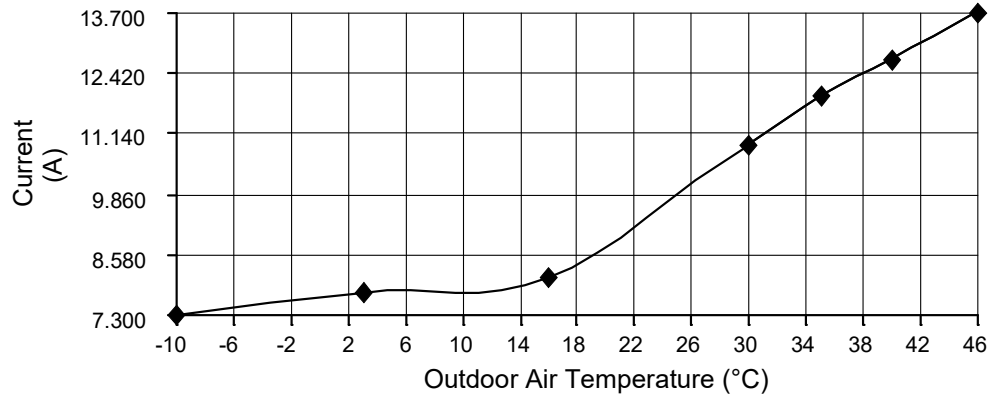
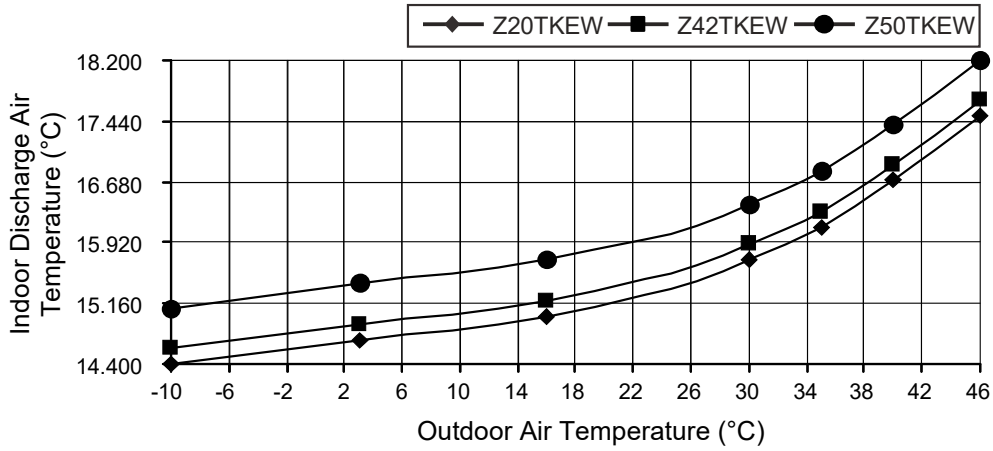

- Cooling Characteristic  
 [Condition] Room temperature: 27°C (DBT), 19°C (WBT)  
 Operation condition: High fan speed  
 Piping Length: 5m  
 Voltage: 230V, 50Hz

D) Indoor unit capacity: Cooling (2.5kW + 4.2kW + 5.0kW), CS-Z25TKEW + CS-Z42TKEW + CS-Z50TKEW, service mode frequency = 59 Hz

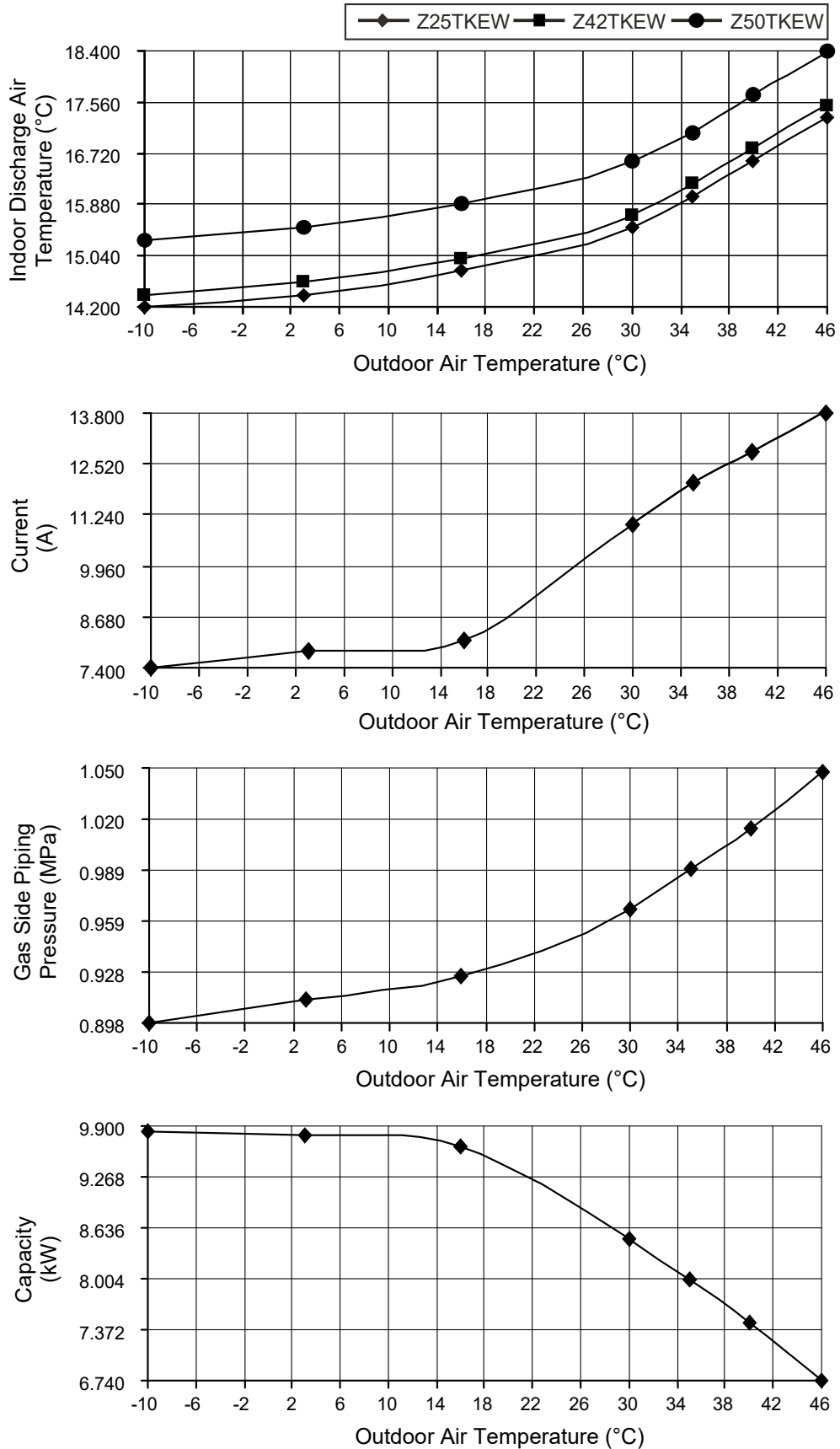

- Heating Characteristic  
 [Condition] Room temperature: 20°C (DBT), 12°C (WBT)  
 Operation condition: High fan speed  
 Piping Length: 5m  
 Voltage: 230V, 50Hz

A) Indoor unit capacity: Heating (2.0kW + 2.5kW + 4.0kW), CS-Z20TKEW + CS-Z25TKEW + CS-Z42TKEW, service mode frequency = 77 Hz

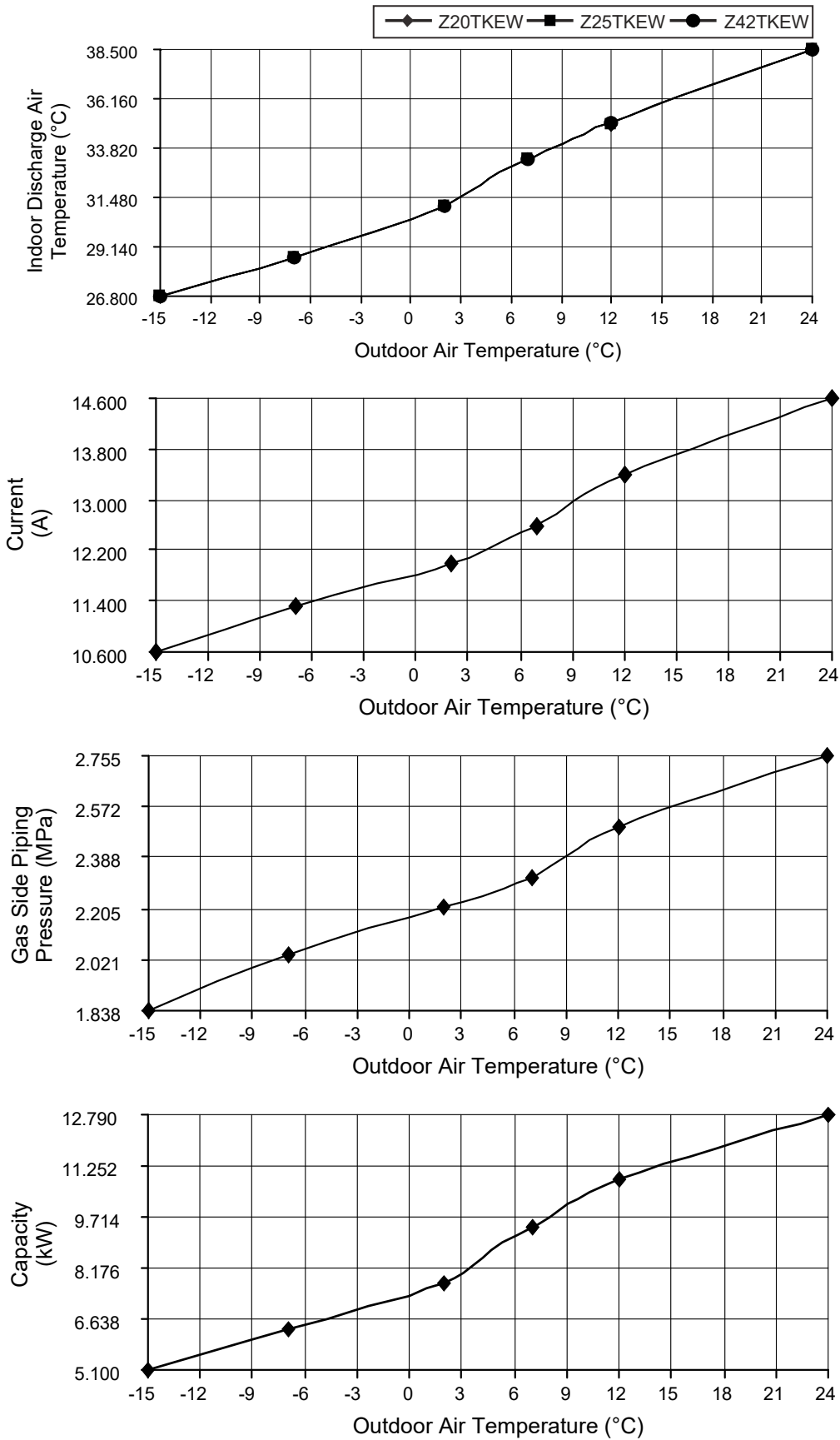

- Heating Characteristic
- [Condition] Room temperature: 20°C (DBT), 12°C (WBT)  
 Operation condition: High fan speed  
 Piping Length: 5m  
 Voltage: 230V, 50Hz

B) Indoor unit capacity: Heating (2.0kW + 2.5kW + 5.0kW), CS-Z20TKEW + CS-Z25TKEW + CS-Z50TKEW, service mode frequency = 77 Hz

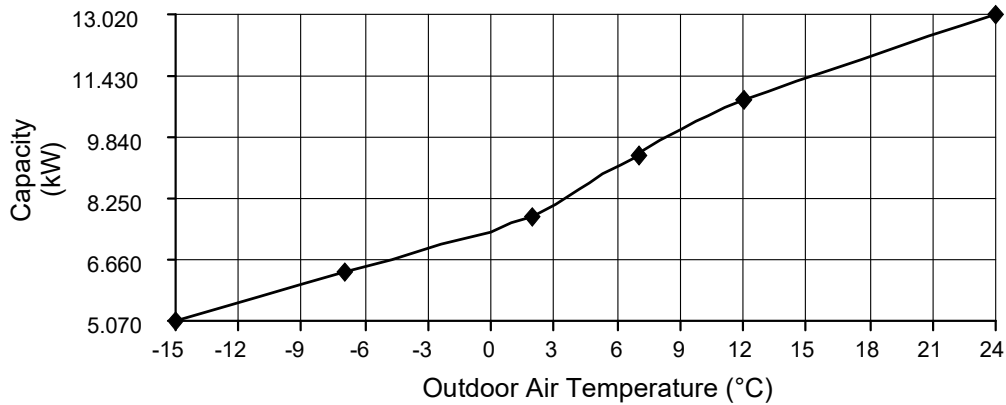
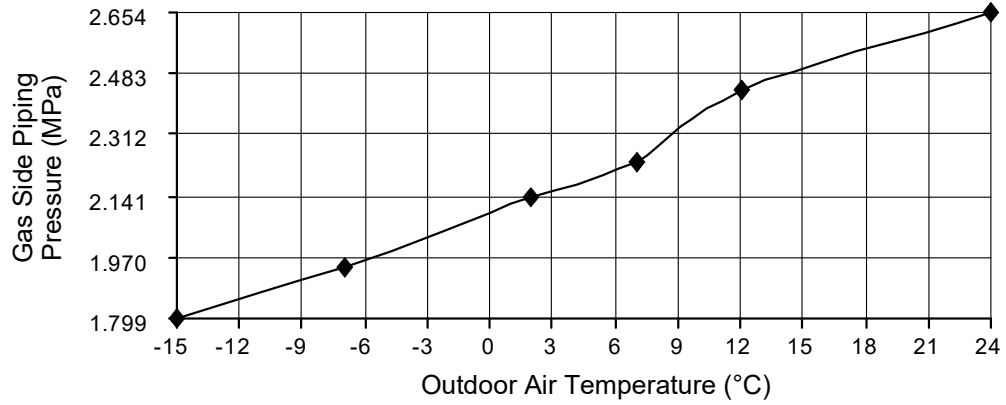
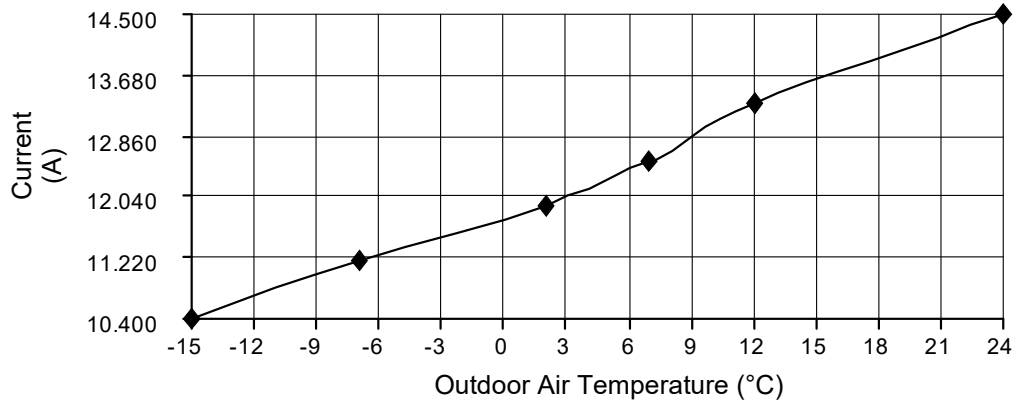
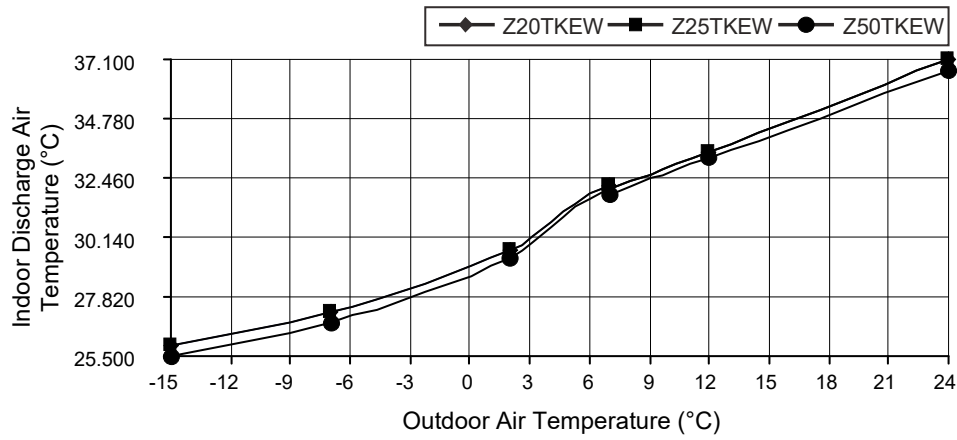

- Heating Characteristic  
 [Condition] Room temperature: 20°C (DBT), 12°C (WBT)  
 Operation condition: High fan speed  
 Piping Length: 5m  
 Voltage: 230V, 50Hz

C) Indoor unit capacity: Heating (2.0kW + 4.0kW + 5.0kW), CS-Z20TKEW + CS-Z42TKEW + CS-Z50TKEW, service mode frequency = 82 Hz

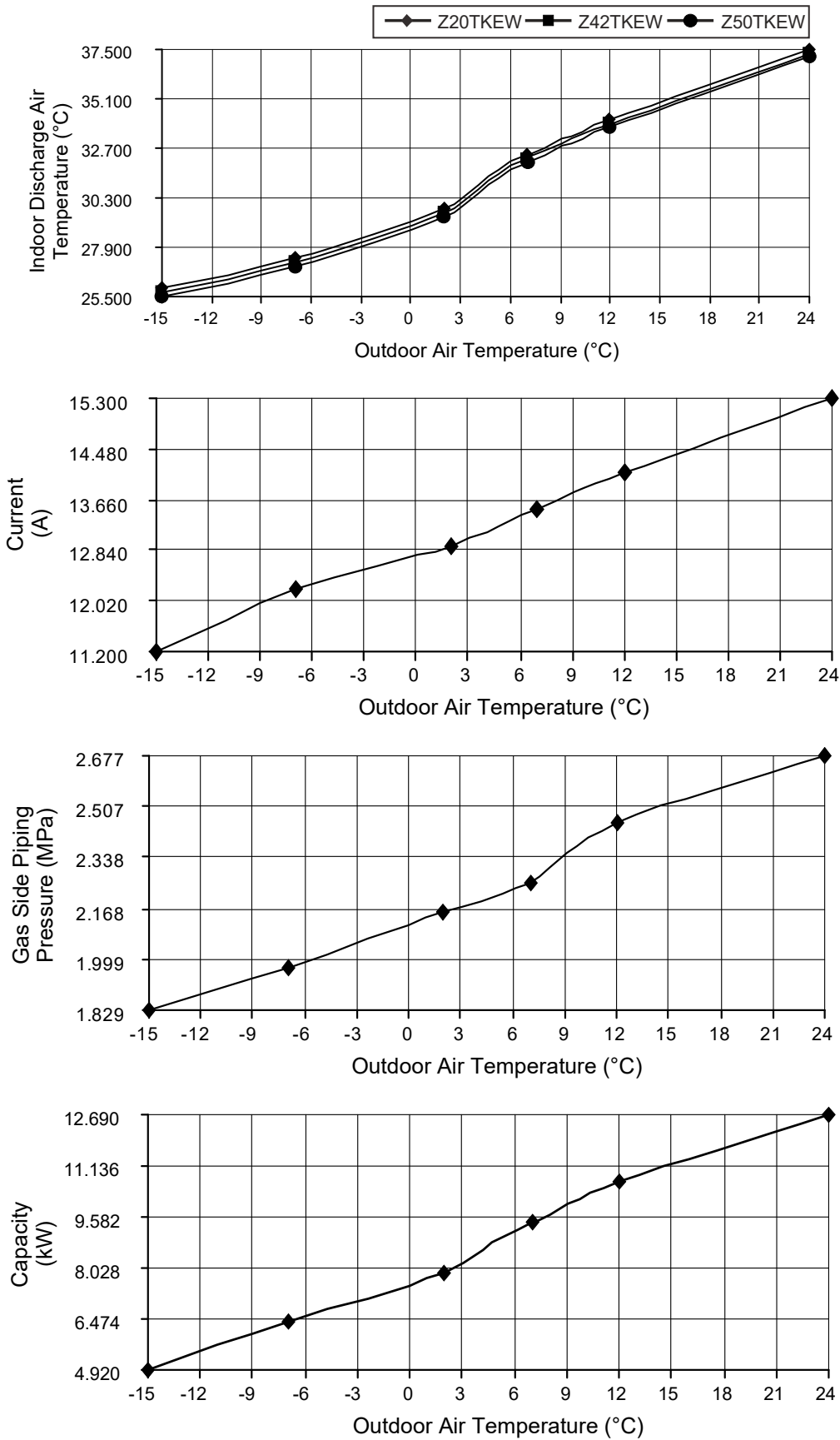



- Heating Characteristic
- [Condition] Room temperature: 20°C (DBT), 12°C (WBT)  
 Operation condition: High fan speed  
 Piping Length: 5m  
 Voltage: 230V, 50Hz

D) Indoor unit capacity: Heating (2.5kW + 4.0kW + 5.0kW), CS-Z25TKEW + CS-Z42TKEW + CS-Z50TKEW, service mode frequency = 82 Hz

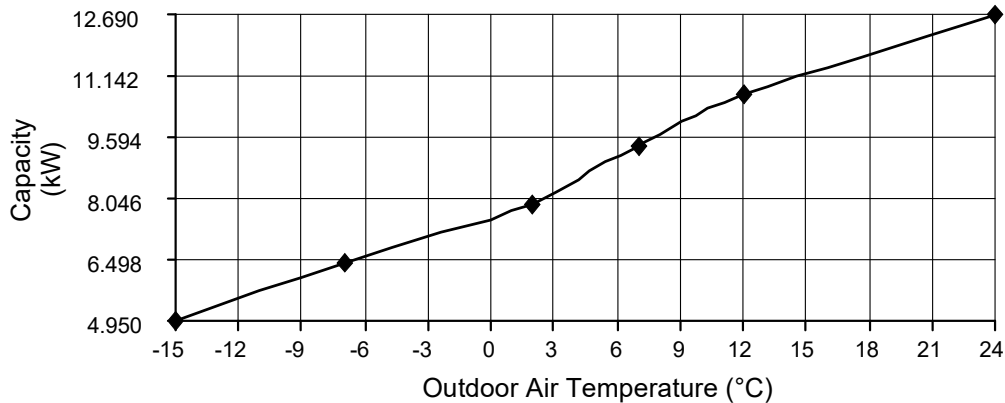
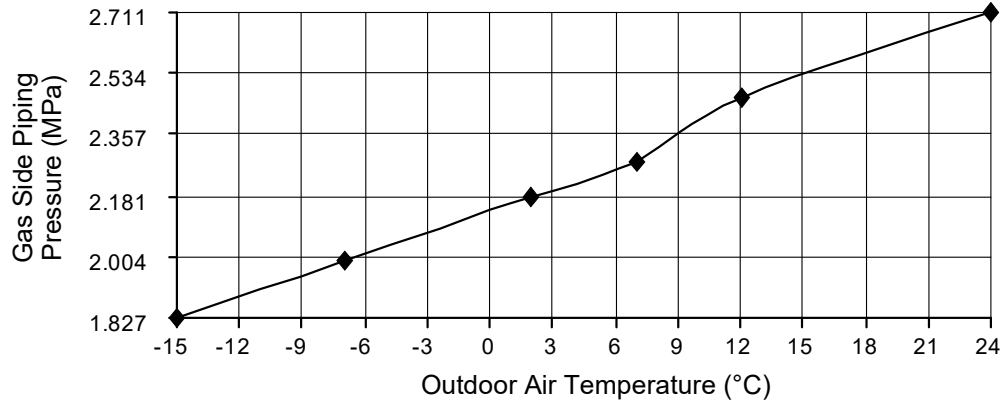
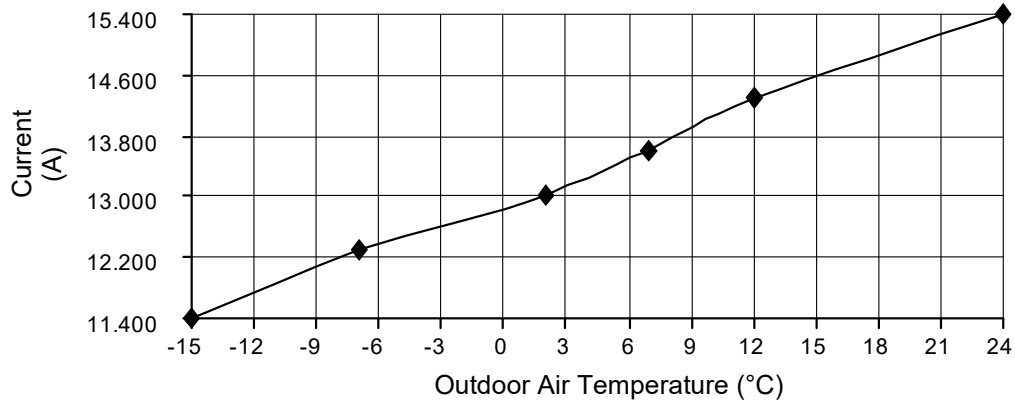
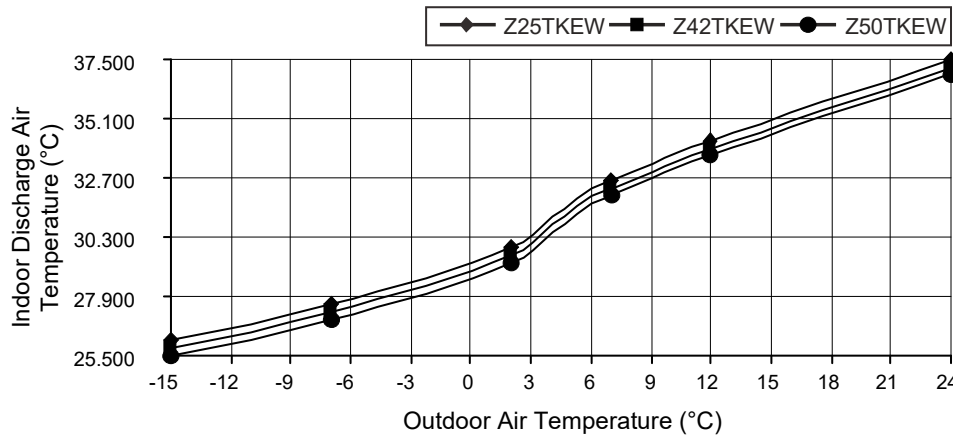

### 19.1.4 Four Indoor Units Operation

- Cooling Characteristic

[Condition] Room temperature: 27°C (DBT), 19°C (WBT)

Operation condition: High fan speed

Piping Length: 5m

Voltage: 230V, 50Hz

A) Indoor unit capacity: Cooling (2.0kW + 2.5kW + 4.2kW + 5.0kW), CS-Z20TKEW + CS-Z25TKEW + CS-Z42TKEW + CS-Z50TKEW, service mode frequency = 65 Hz

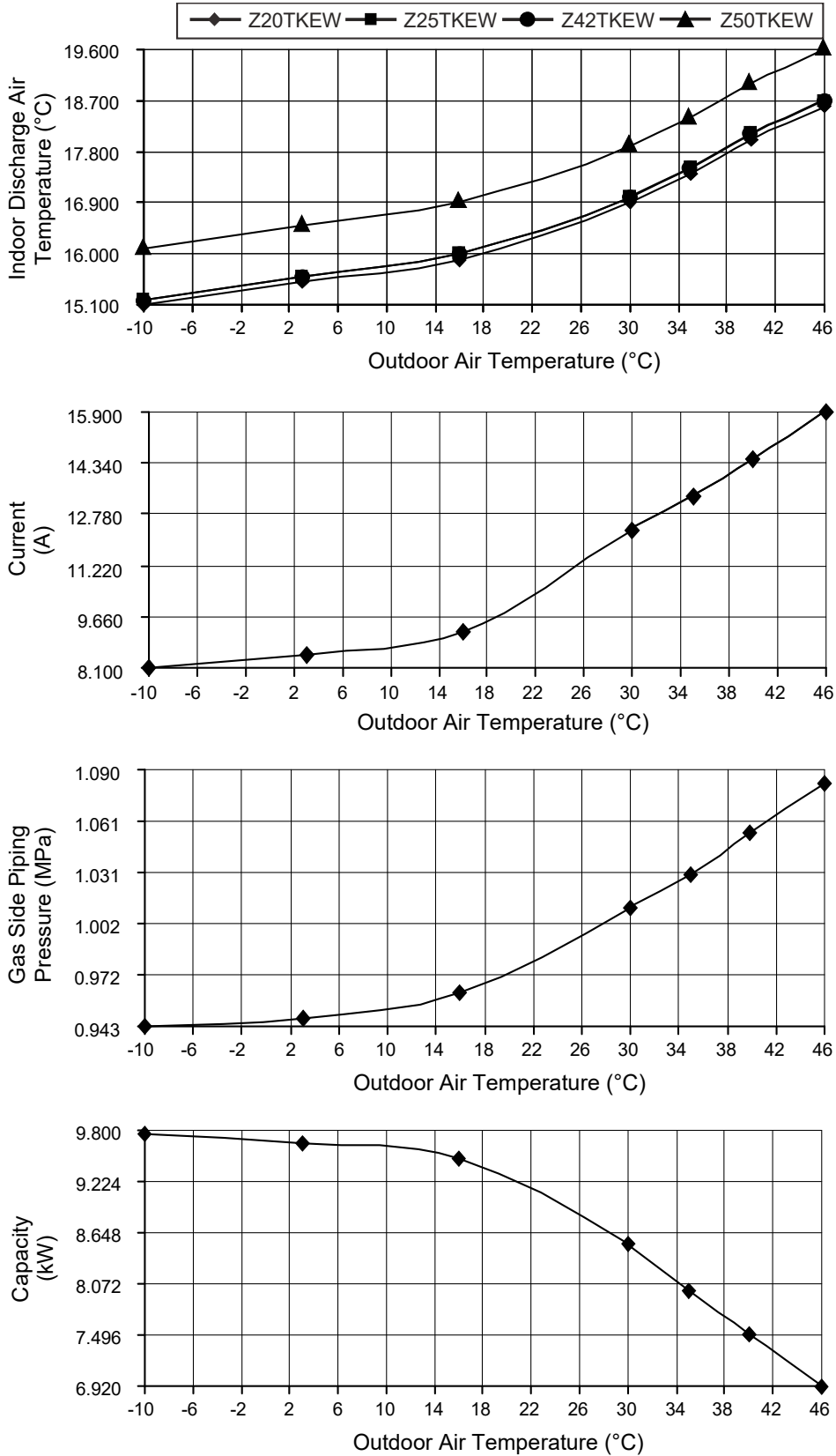

- Heating Characteristic
- [Condition] Room temperature: 20°C (DBT), 12°C (WBT)  
 Operation condition: High fan speed  
 Piping Length: 5m  
 Voltage: 230V, 50Hz

A) Indoor unit capacity: Heating (2.0kW + 2.5kW + 4.0kW + 5.0kW), CS-Z20TKEW + CS-Z25TKEW + CS-Z42TKEW + CS-Z50TKEW, service mode frequency = 86 Hz

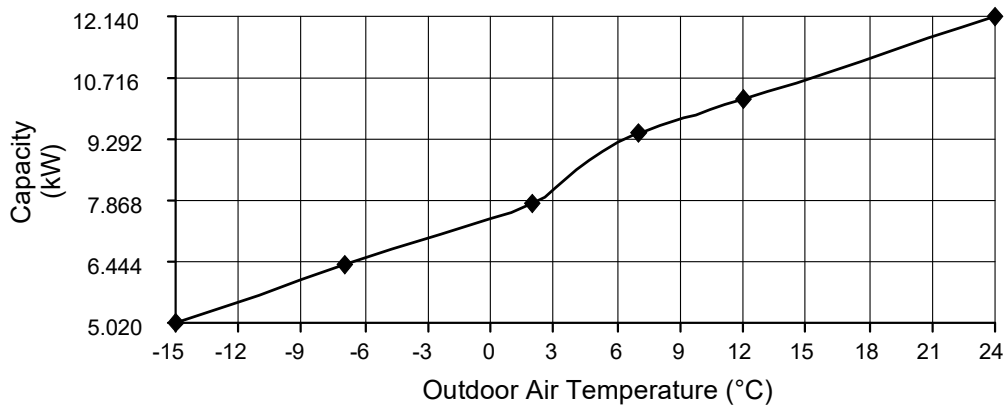
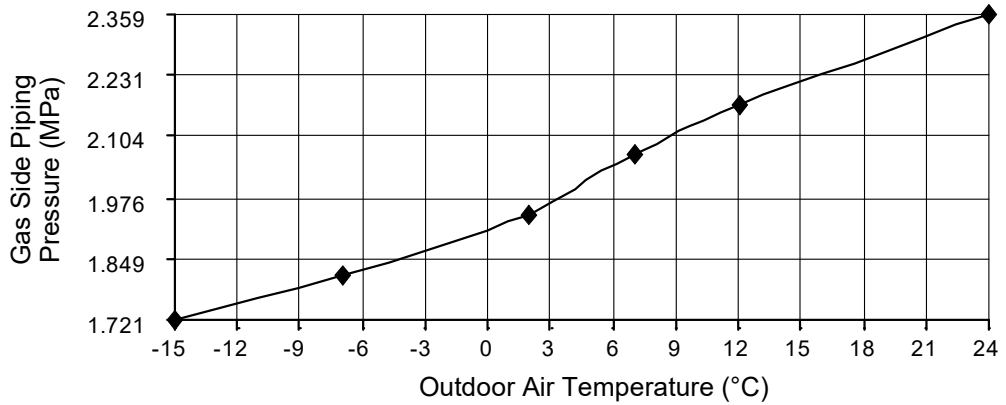
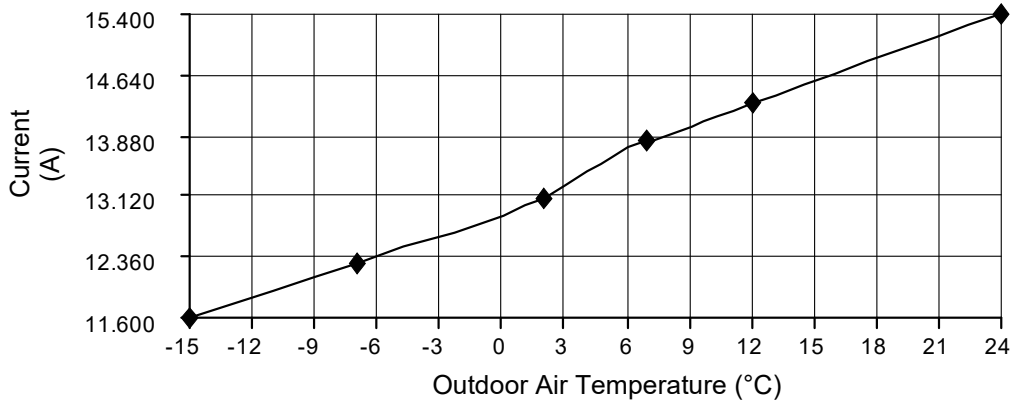
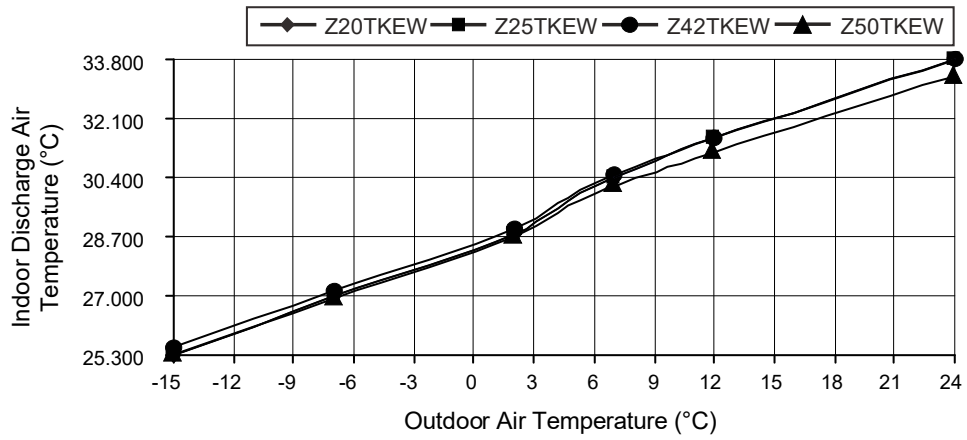

## 19.2 Operation Characteristics (CU-5Z90TBE)

### 19.2.1 One Indoor Unit Operation

- Cooling Characteristic

[Condition] Room temperature: 27°C (DBT), 19°C (WBT)

Operation condition: High fan speed

Piping Length: 5m

Voltage: 230V, 50Hz

A) Indoor unit capacity: Cooling (2.0kW), CS-Z20TKEW, service mode frequency = 20 Hz

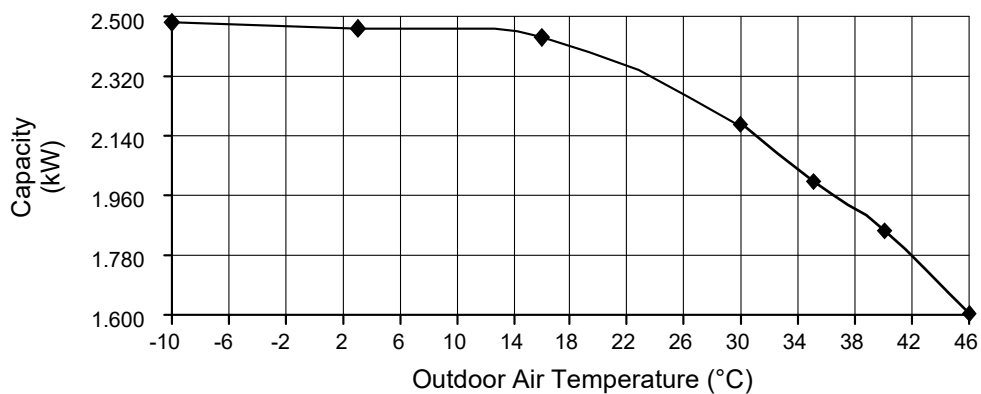
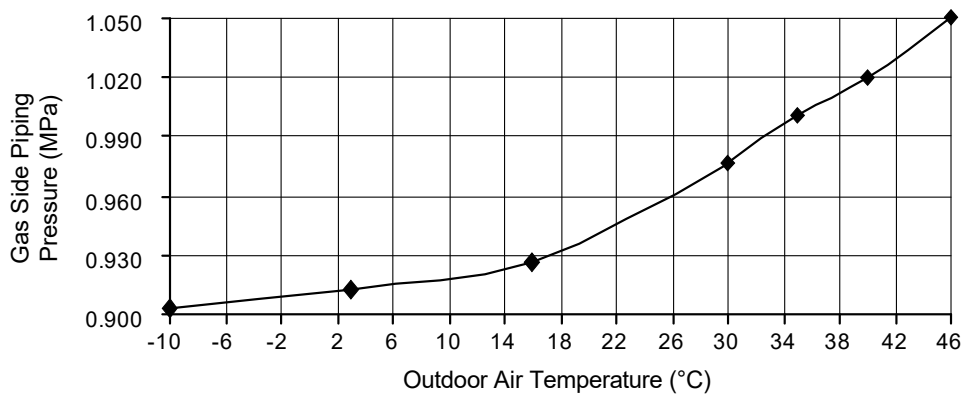
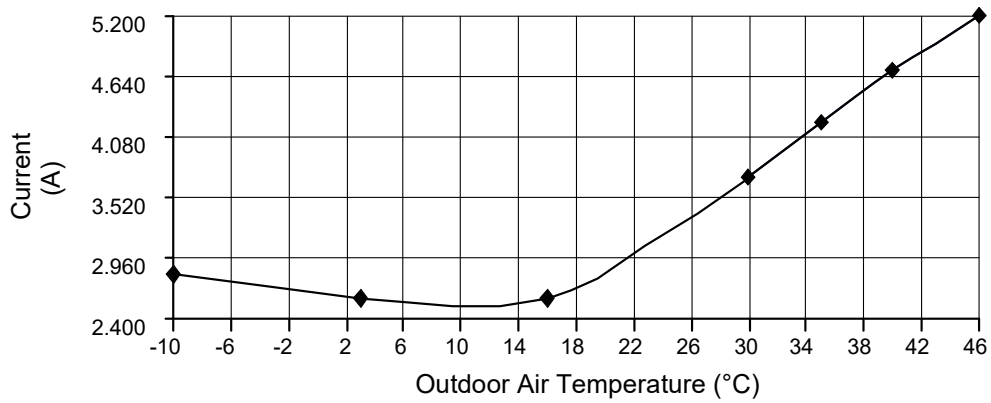
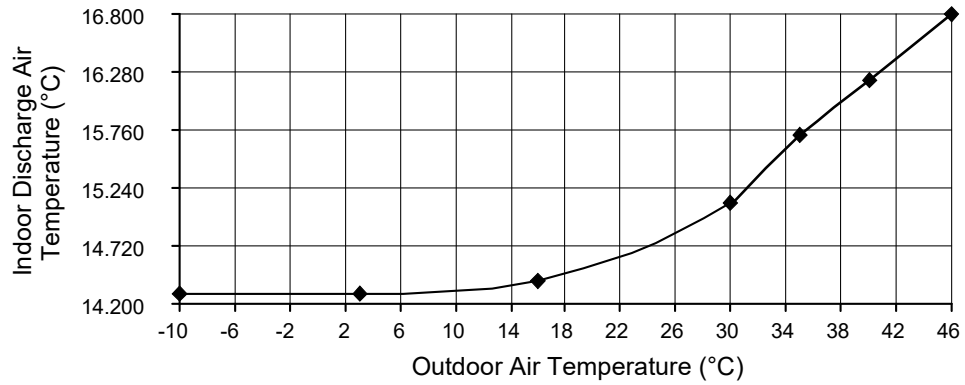

- Cooling Characteristic  
 [Condition] Room temperature: 27°C (DBT), 19°C (WBT)  
 Operation condition: High fan speed  
 Piping Length: 5m  
 Voltage: 230V, 50Hz

B) Indoor unit capacity: Cooling (2.5kW), CS-Z25TKEW, service mode frequency = 20 Hz

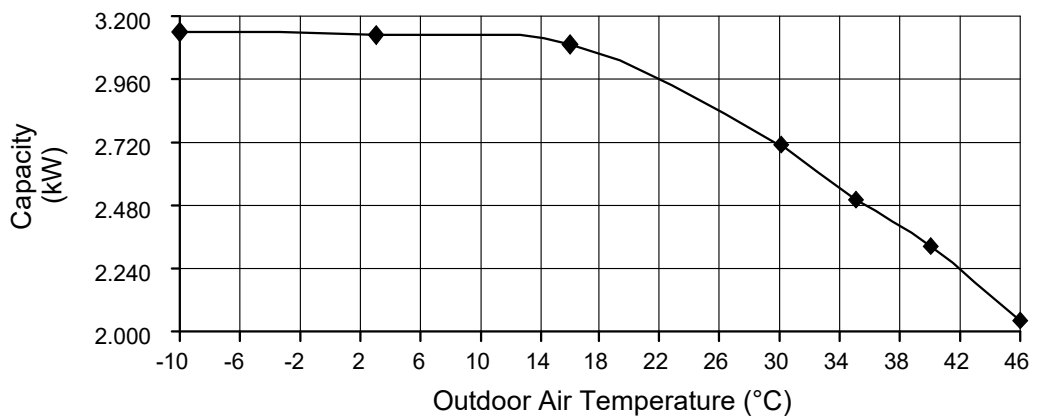
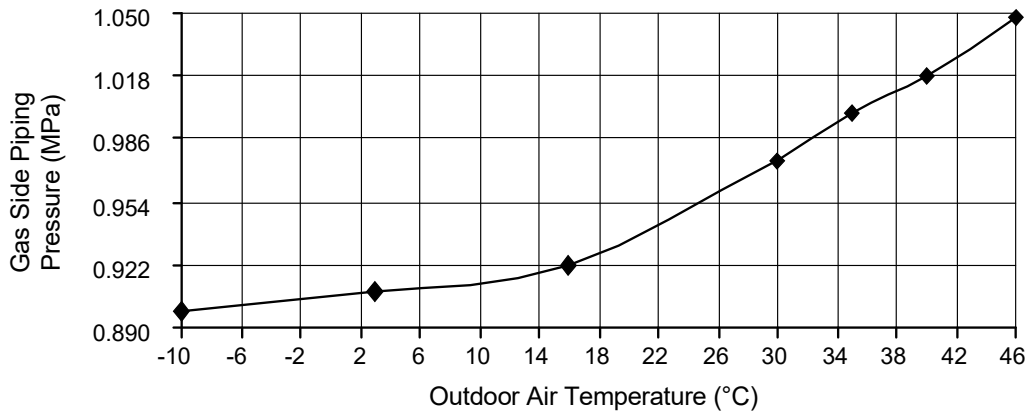
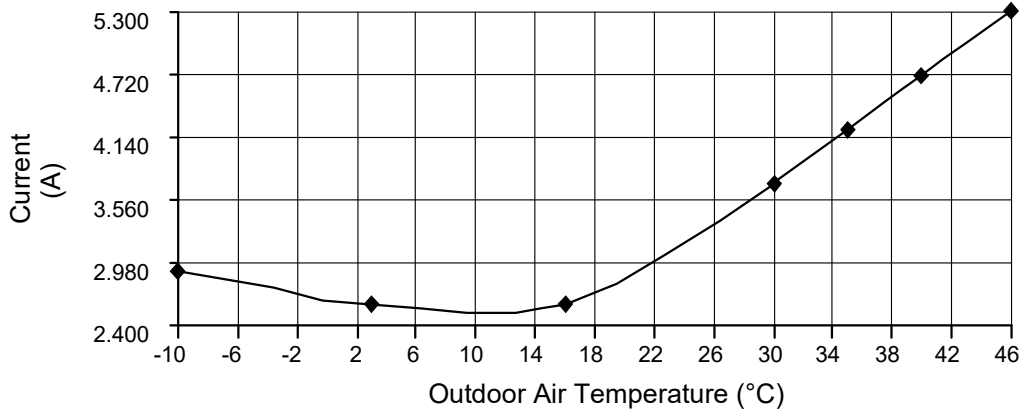
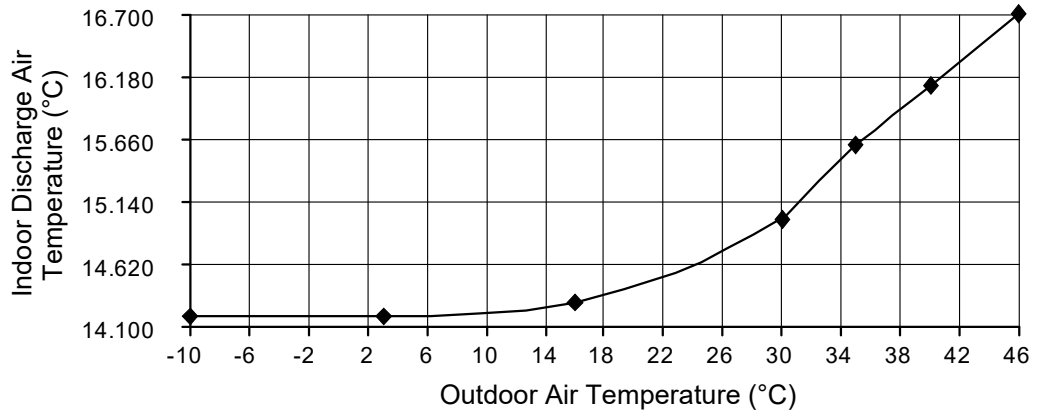

- Cooling Characteristic
- [Condition] Room temperature: 27°C (DBT), 19°C (WBT)  
 Operation condition: High fan speed  
 Piping Length: 5m  
 Voltage: 230V, 50Hz

C) Indoor unit capacity: Cooling (4.2kW), CS-Z42TKEW, service mode frequency = 34 Hz

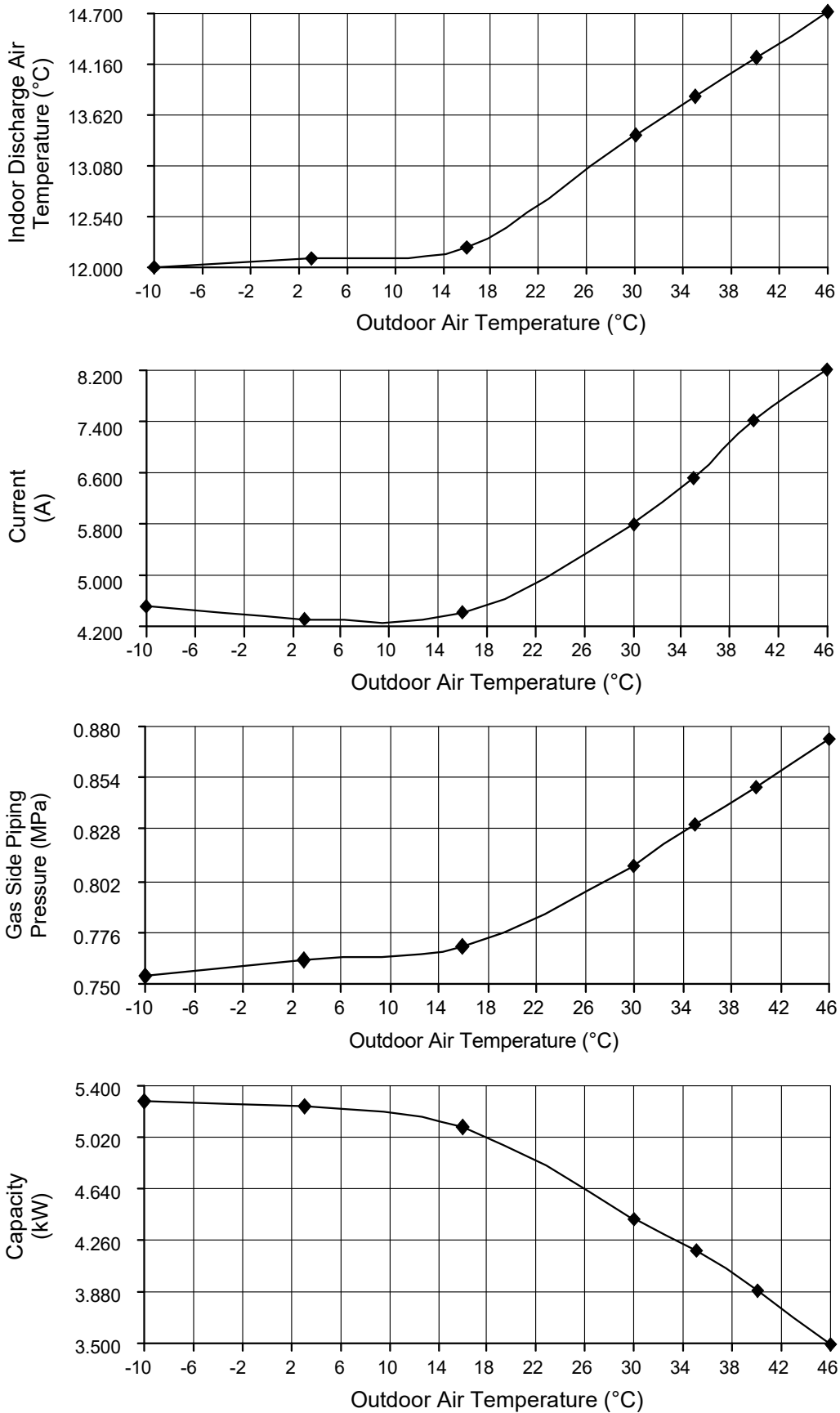

- Cooling Characteristic  
 [Condition] Room temperature: 27°C (DBT), 19°C (WBT)  
 Operation condition: High fan speed  
 Piping Length: 5m  
 Voltage: 230V, 50Hz

D) Indoor unit capacity: Cooling (5.0kW), CS-Z50TKEW, service mode frequency = 49 Hz

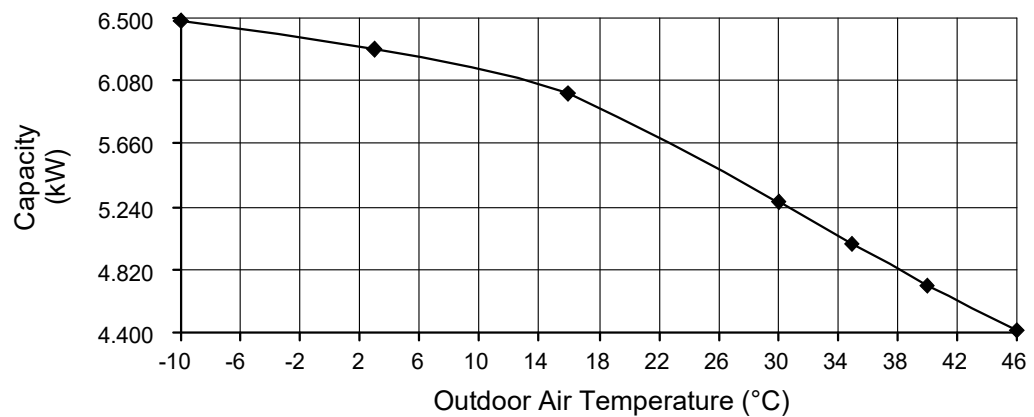
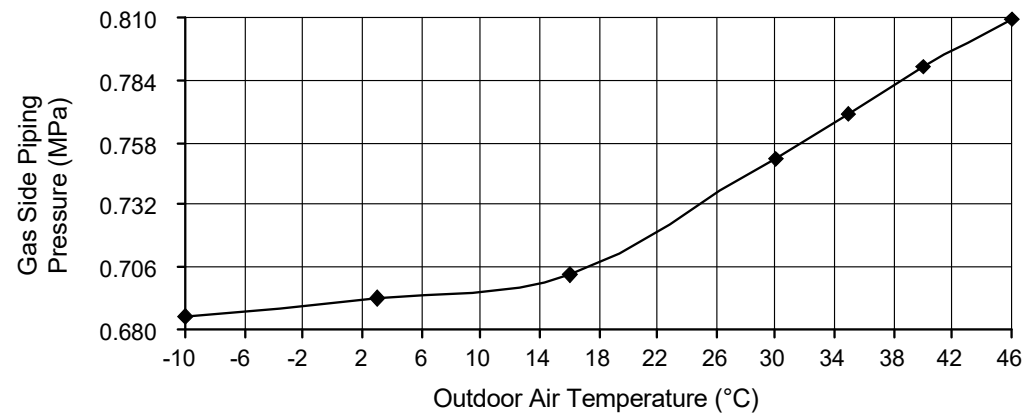
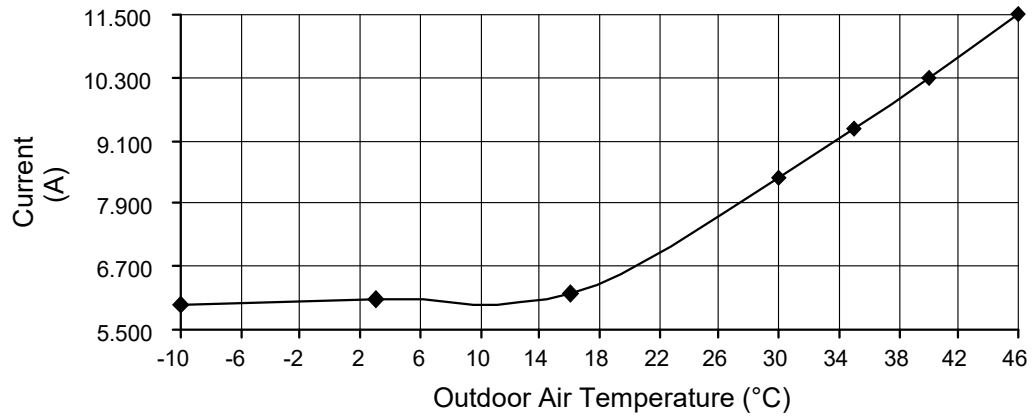
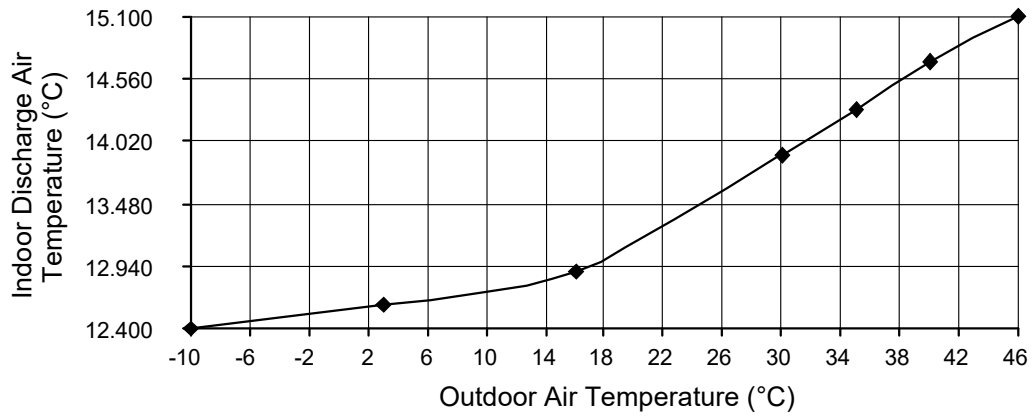

- Heating Characteristic  
 [Condition] Room temperature: 20°C (DBT), 12°C (WBT)  
 Operation condition: High fan speed  
 Piping Length: 5m  
 Voltage: 230V, 50Hz

A) Indoor unit capacity: Heating (2.0kW), CS-Z20TKEW, service mode frequency = 39 Hz

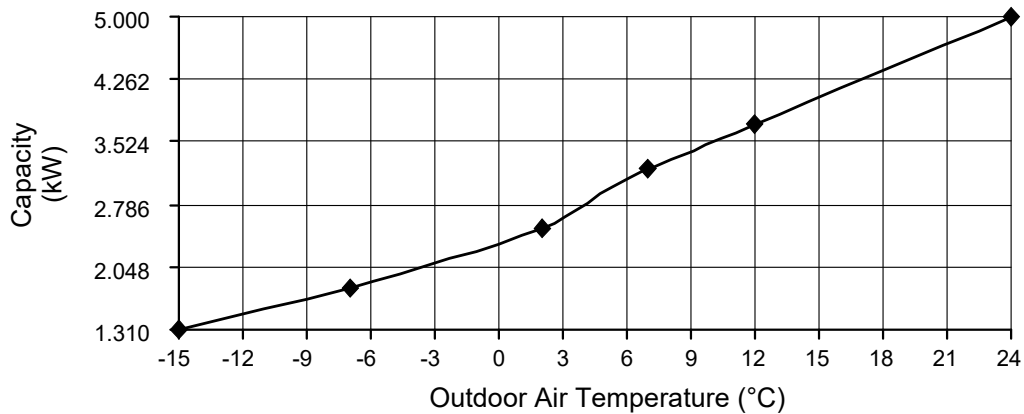
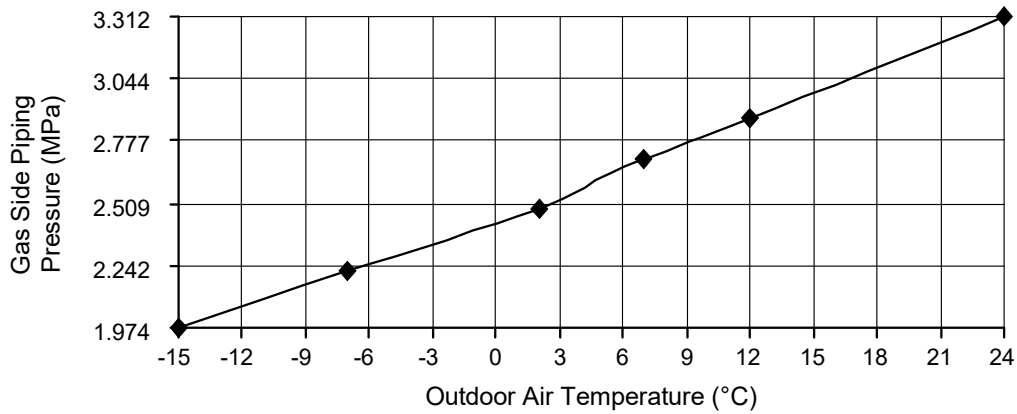
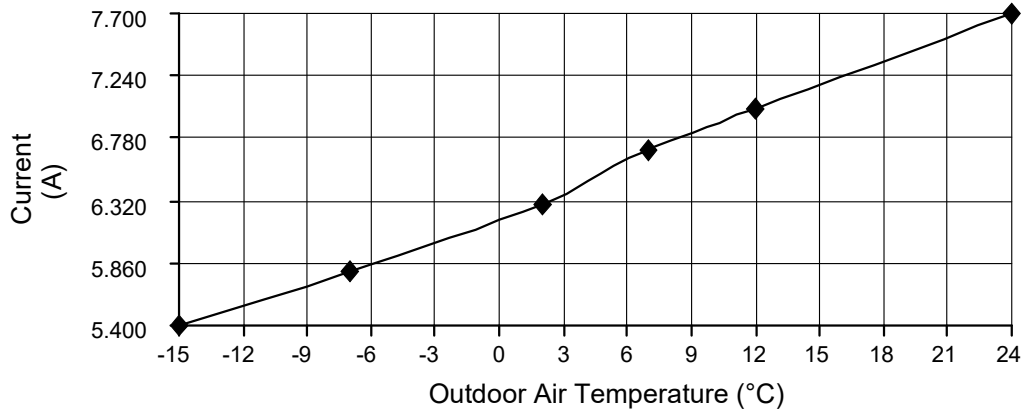
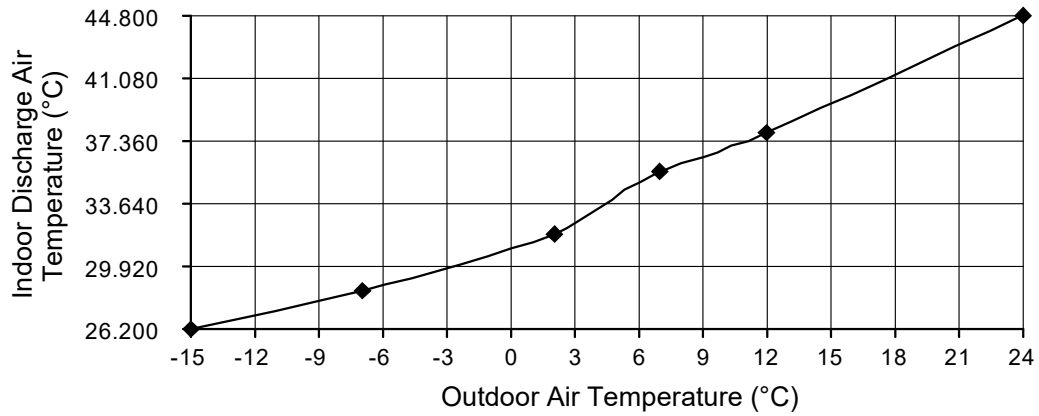



- Heating Characteristic
- [Condition] Room temperature: 20°C (DBT), 12°C (WBT)  
 Operation condition: High fan speed  
 Piping Length: 5m  
 Voltage: 230V, 50Hz

B) Indoor unit capacity: Heating (2.5kW), CS-Z25TKEW, service mode frequency = 39 Hz

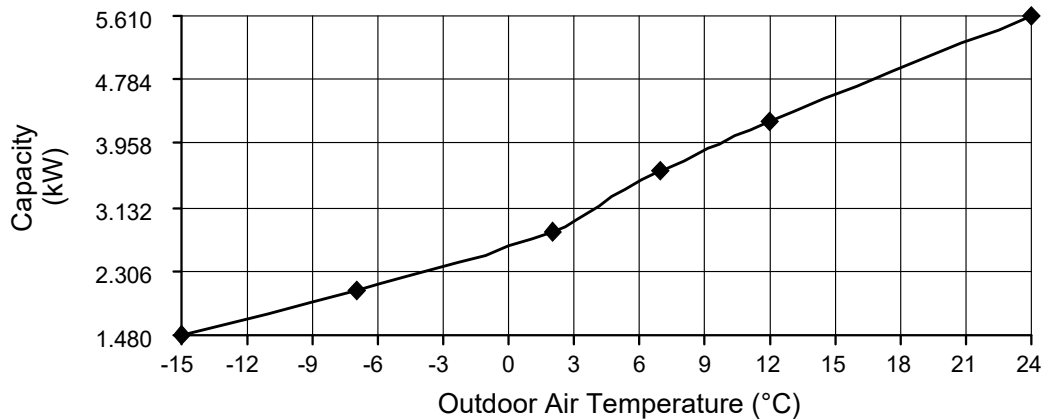
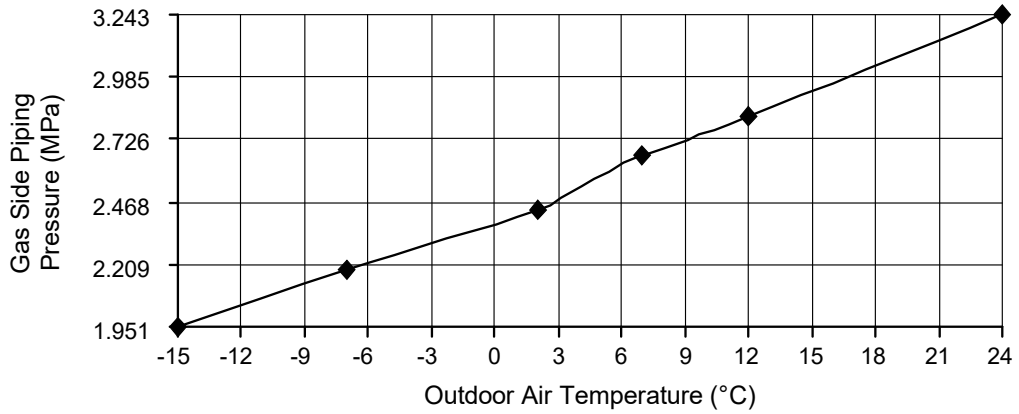
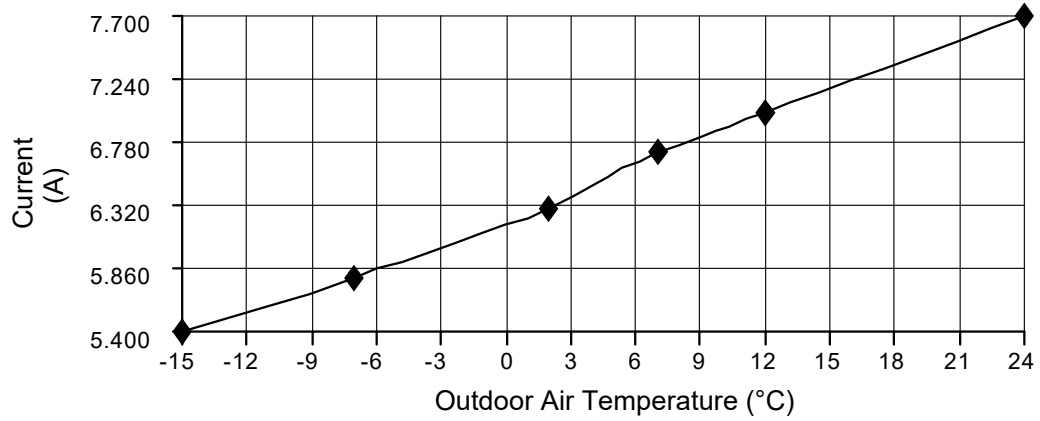
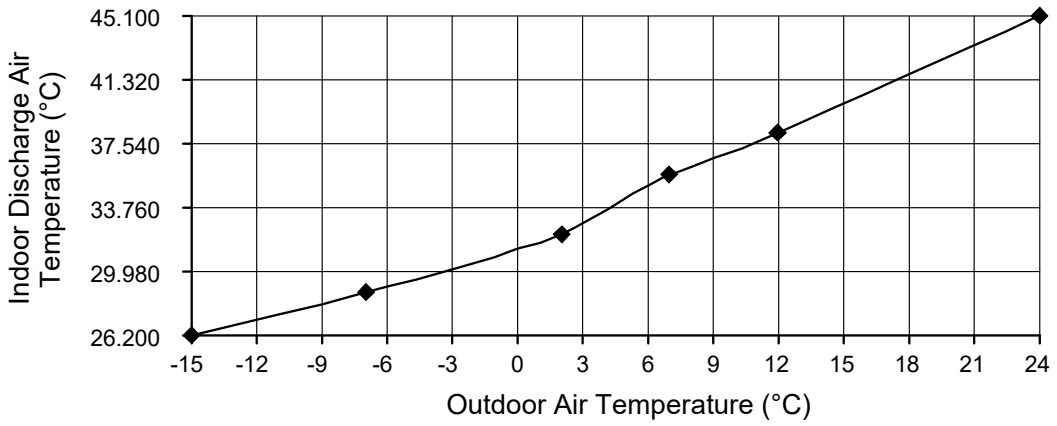

- Heating Characteristic  
 [Condition] Room temperature: 20°C (DBT), 12°C (WBT)  
 Operation condition: High fan speed  
 Piping Length: 5m  
 Voltage: 230V, 50Hz

C) Indoor unit capacity: Heating (4.0kW), CS-Z42TKEW, service mode frequency = 47 Hz

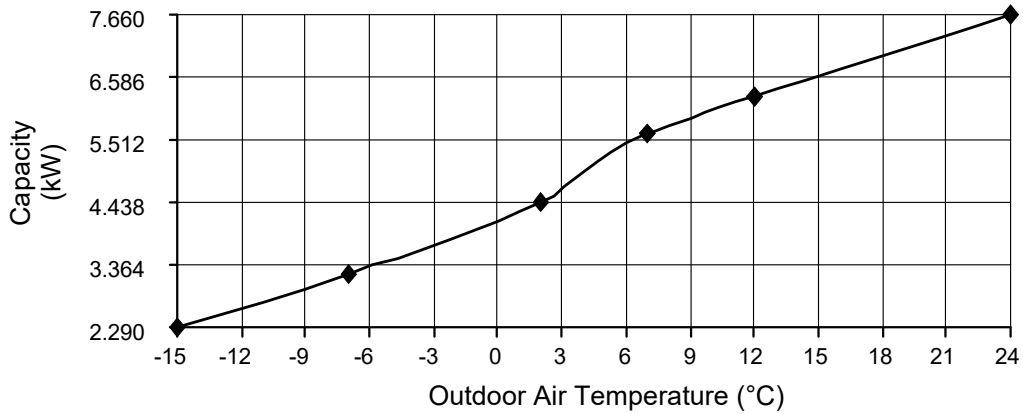
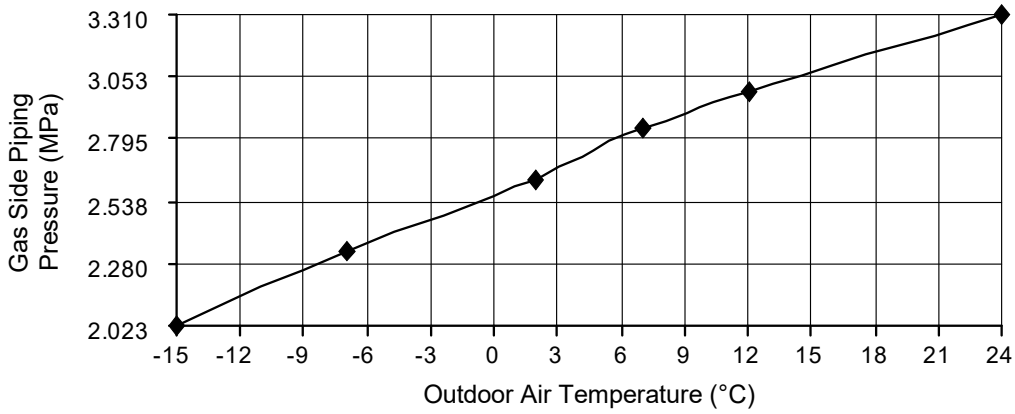
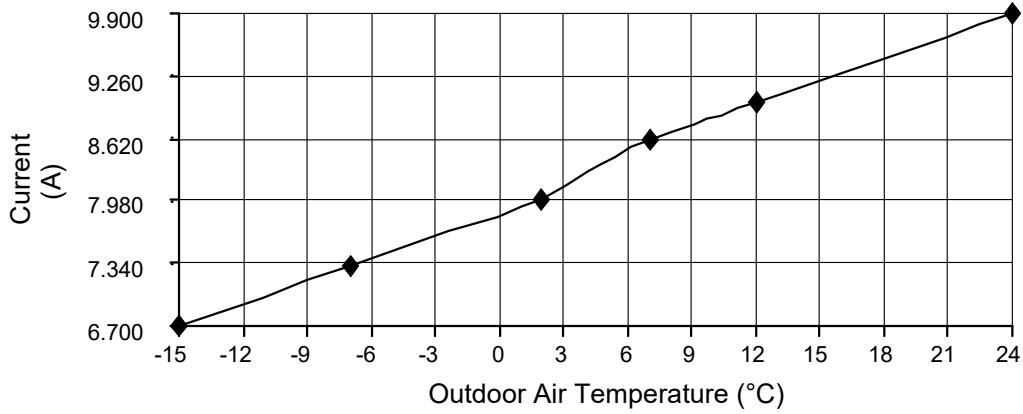
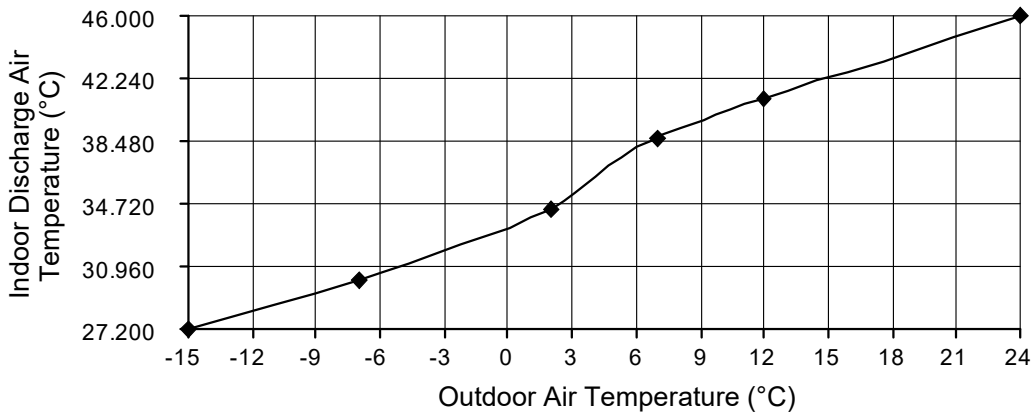

- Heating Characteristic
- [Condition] Room temperature: 20°C (DBT), 12°C (WBT)  
 Operation condition: High fan speed  
 Piping Length: 5m  
 Voltage: 230V, 50Hz

D) Indoor unit capacity: Heating (5.0kW), CS-Z50TKEW, service mode frequency = 55 Hz

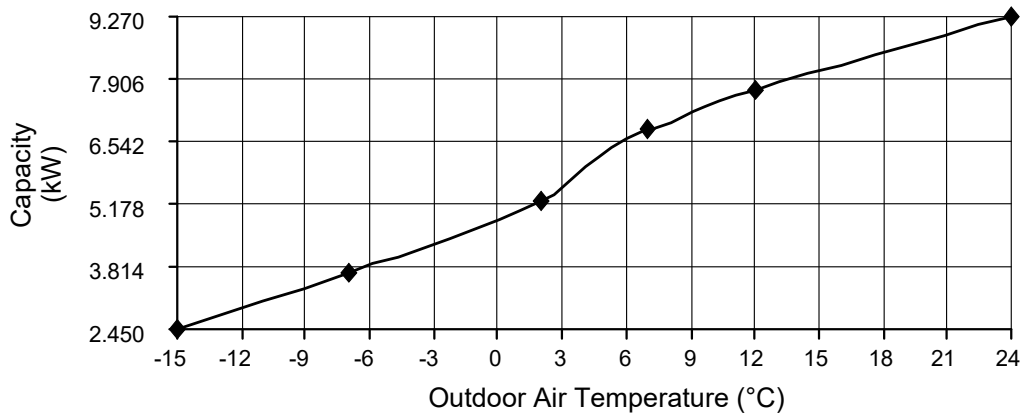
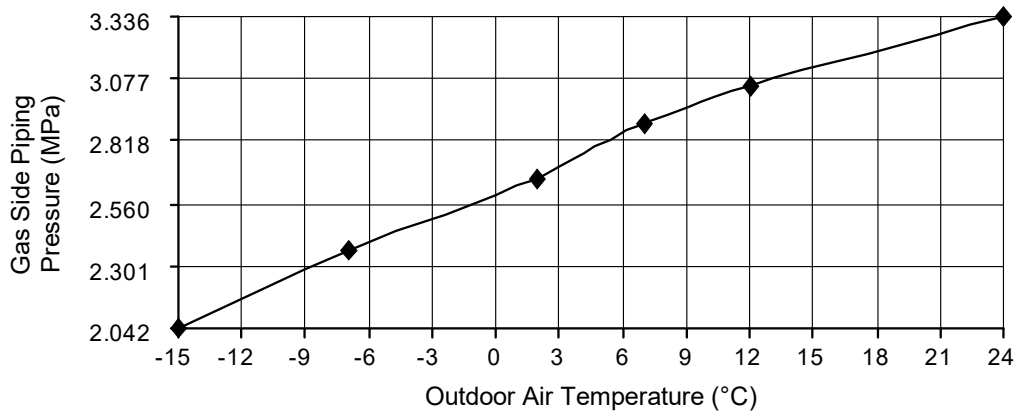
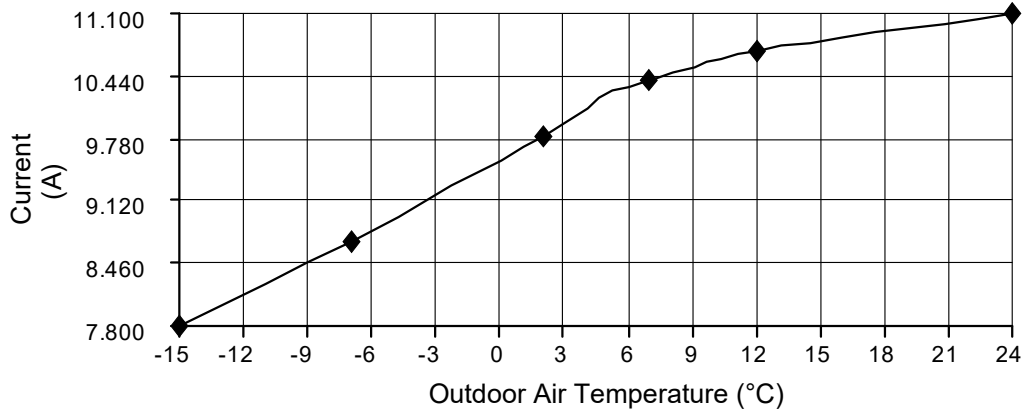
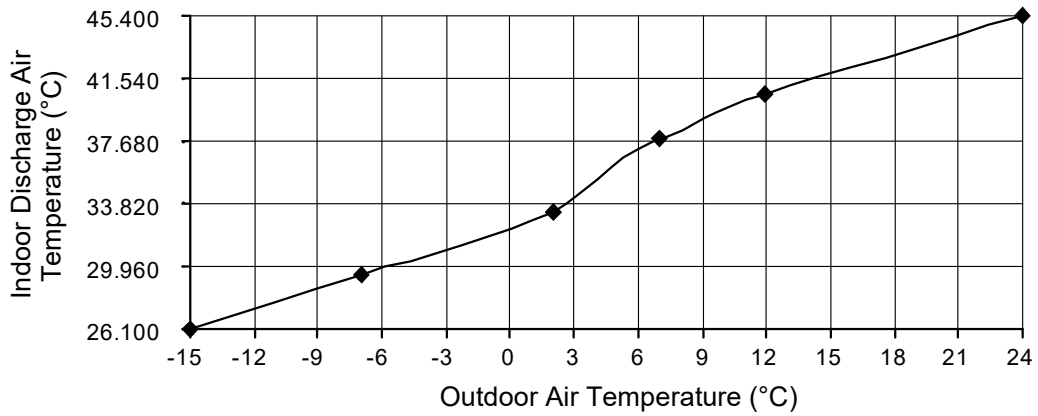

## 19.2.2 Two Indoor Unit Operation

- Cooling Characteristic

[Condition] Room temperature: 27°C (DBT), 19°C (WBT)

Operation condition: High fan speed

Piping Length: 5m

Voltage: 230V, 50Hz

A) Indoor unit capacity: Cooling (2.0kW + 2.5kW), CS-Z20TKEW + CS-Z25TKEW, service mode frequency = 49 Hz

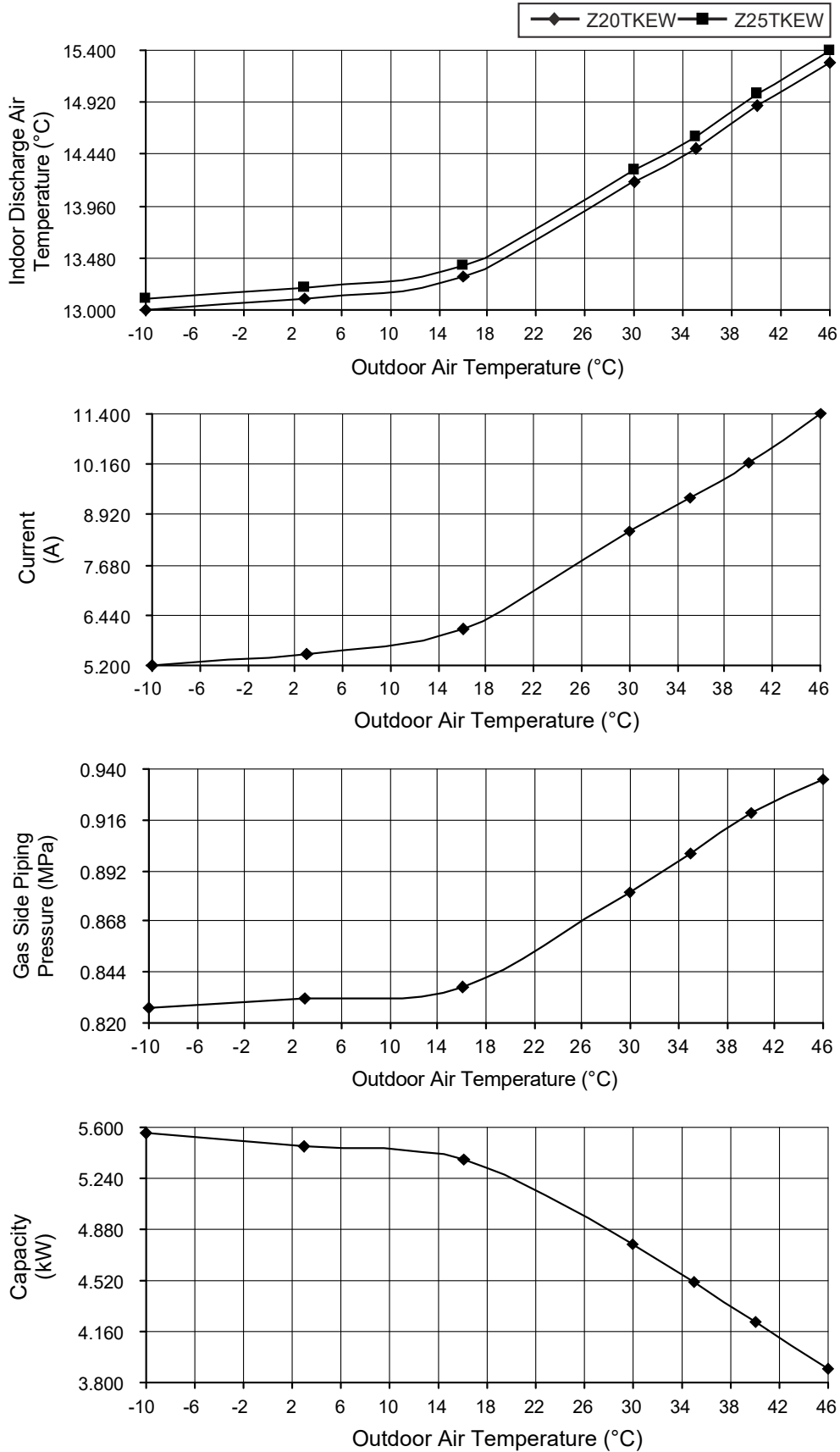

- Cooling Characteristic  
 [Condition] Room temperature: 27°C (DBT), 19°C (WBT)  
 Operation condition: High fan speed  
 Piping Length: 5m  
 Voltage: 230V, 50Hz

B) Indoor unit capacity: Cooling (2.0kW + 4.2kW), CS-Z20TKEW + CS-Z42TKEW, service mode frequency = 49 Hz

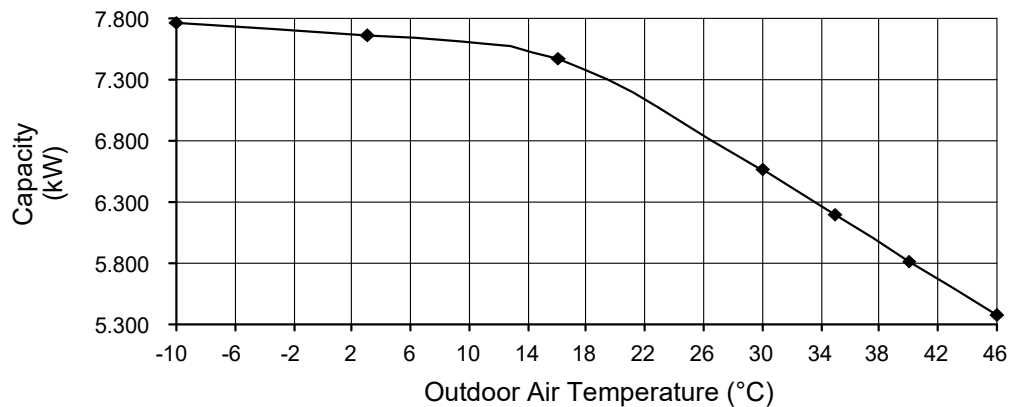
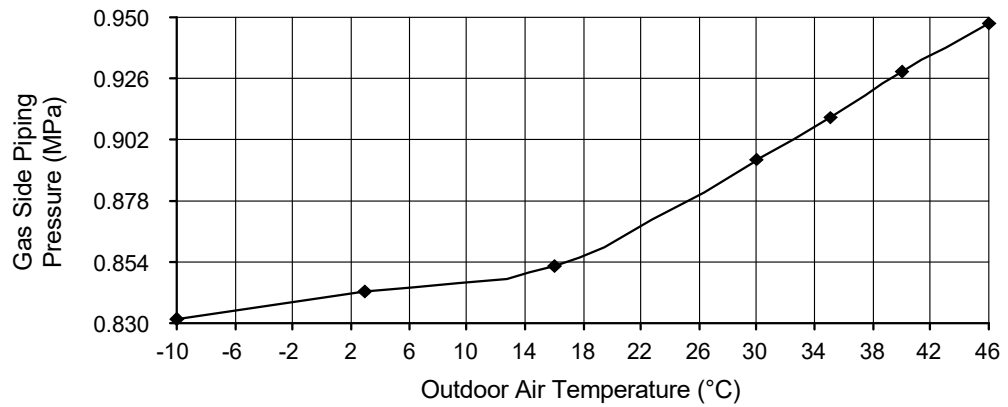
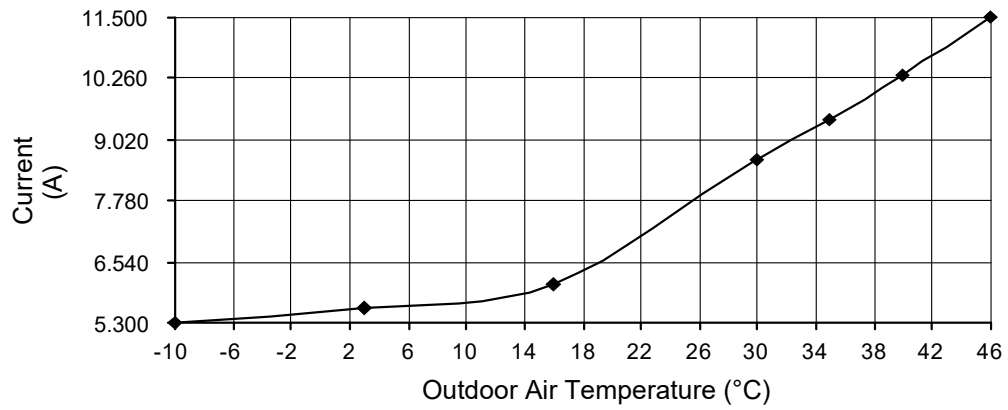
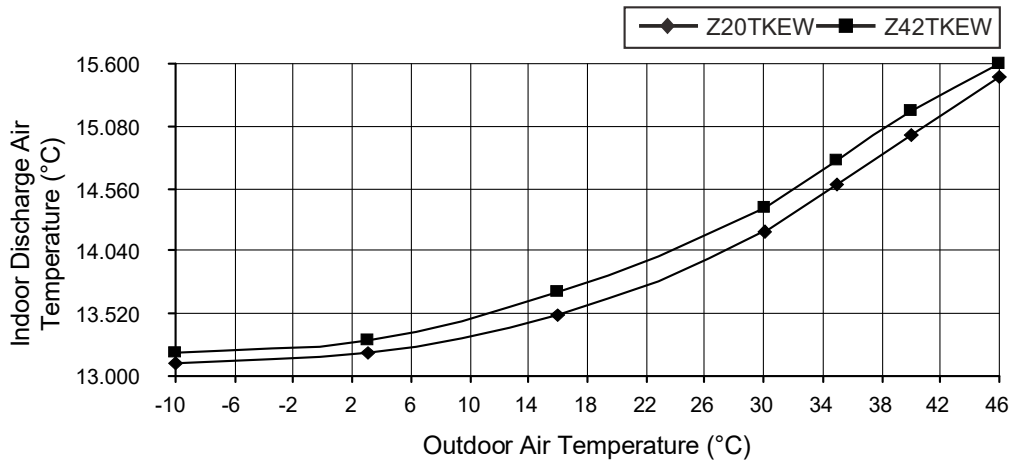

- Cooling Characteristic  
 [Condition] Room temperature: 27°C (DBT), 19°C (WBT)  
 Operation condition: High fan speed  
 Piping Length: 5m  
 Voltage: 230V, 50Hz

C) Indoor unit capacity: Cooling (2.0kW + 5.0kW), CS-Z20TKEW + CS-Z50TKEW, service mode frequency = 51 Hz

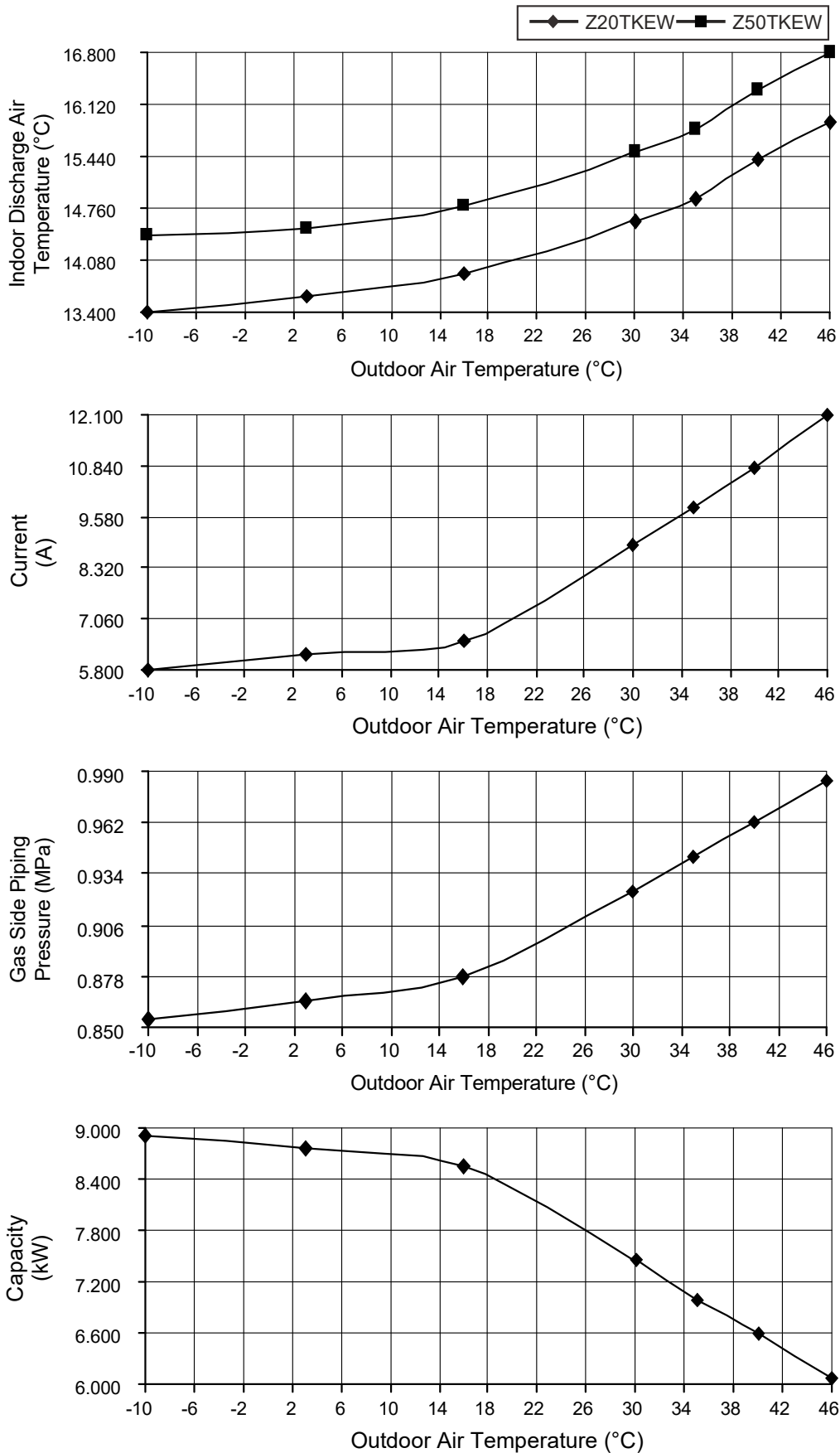

- Cooling Characteristic  
 [Condition] Room temperature: 27°C (DBT), 19°C (WBT)  
 Operation condition: High fan speed  
 Piping Length: 5m  
 Voltage: 230V, 50Hz

D) Indoor unit capacity: Cooling (2.5kW + 4.2kW), CS-Z25TKEW + CS-Z42TKEW, service mode frequency = 49 Hz

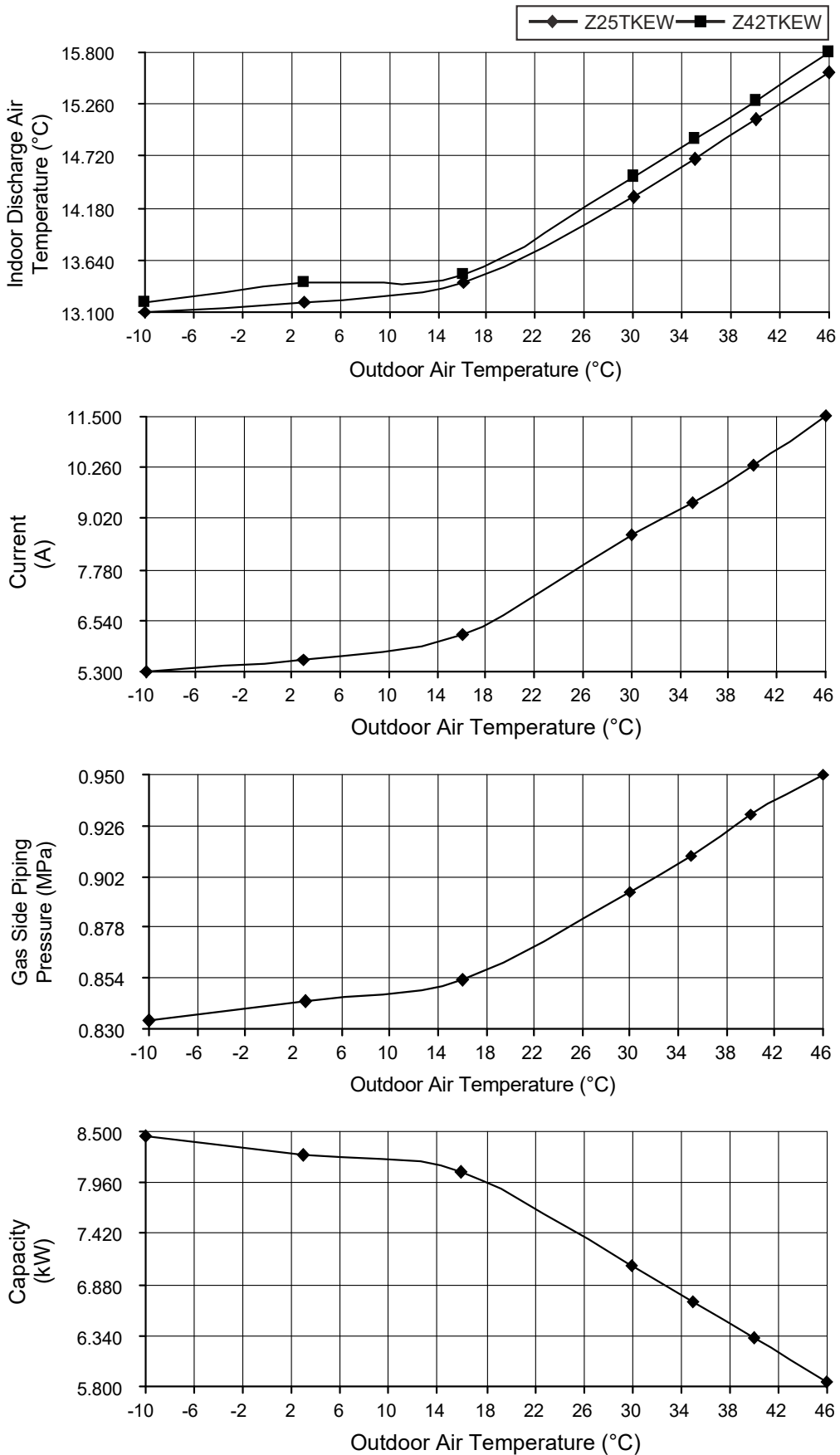

- Cooling Characteristic
- [Condition] Room temperature: 27°C (DBT), 19°C (WBT)  
 Operation condition: High fan speed  
 Piping Length: 5m  
 Voltage: 230V, 50Hz

E) Indoor unit capacity: Cooling (2.5kW + 5.0kW), CS-Z25TKEW + CS-Z50TKEW, service mode frequency = 51 Hz

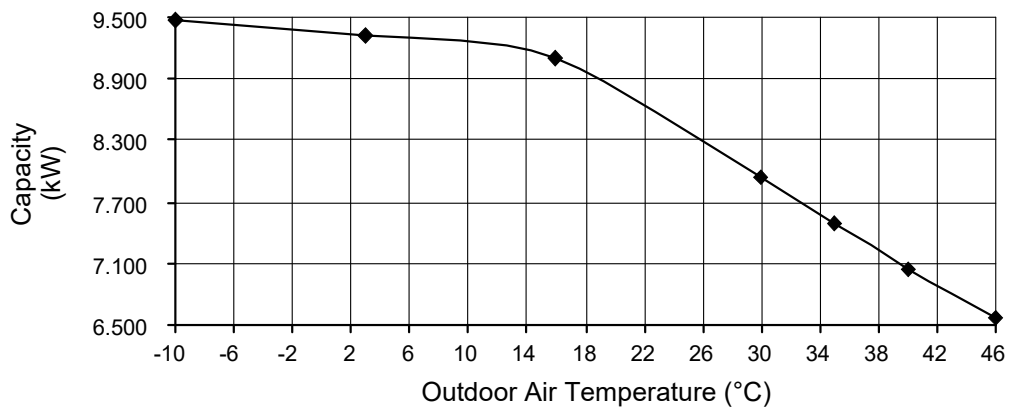
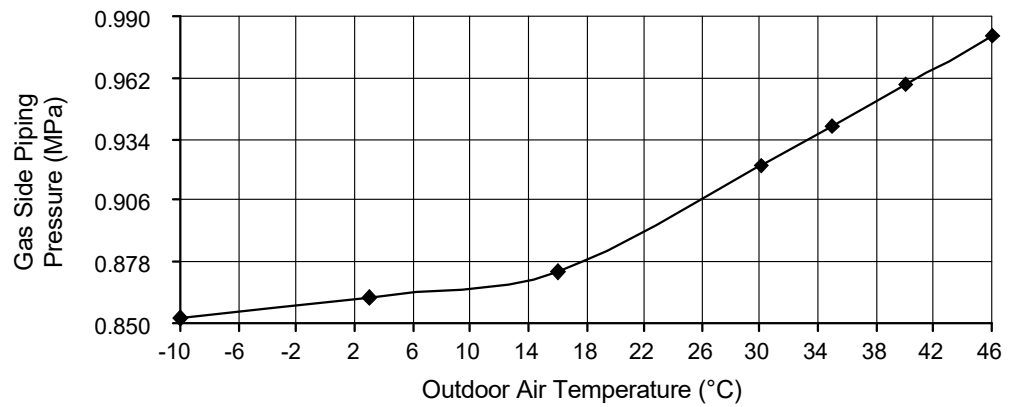
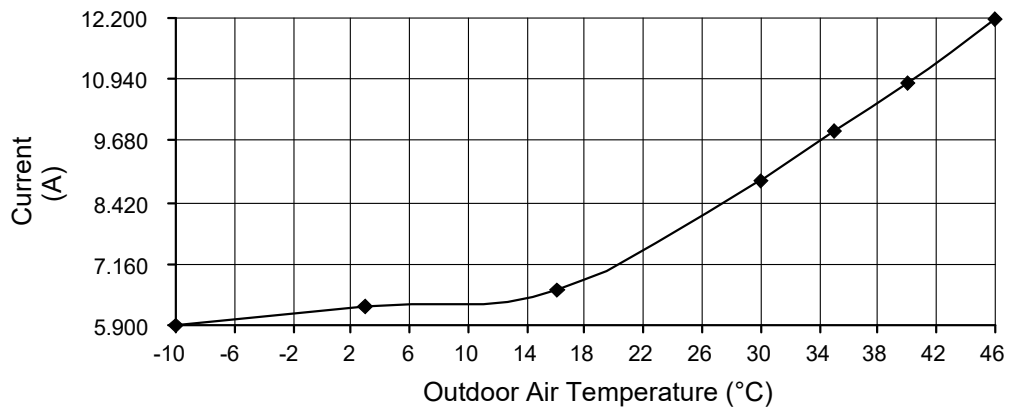
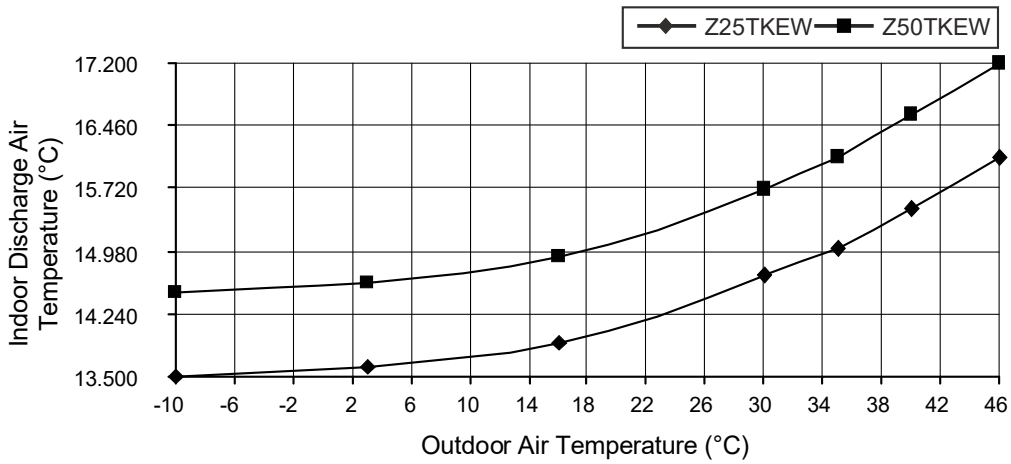



- Cooling Characteristic  
 [Condition] Room temperature: 27°C (DBT), 19°C (WBT)  
 Operation condition: High fan speed  
 Piping Length: 5m  
 Voltage: 230V, 50Hz

F) Indoor unit capacity: Cooling (4.2kW + 5.0kW), CS-Z42TKEW + CS-Z50TKEW, service mode frequency = 53 Hz

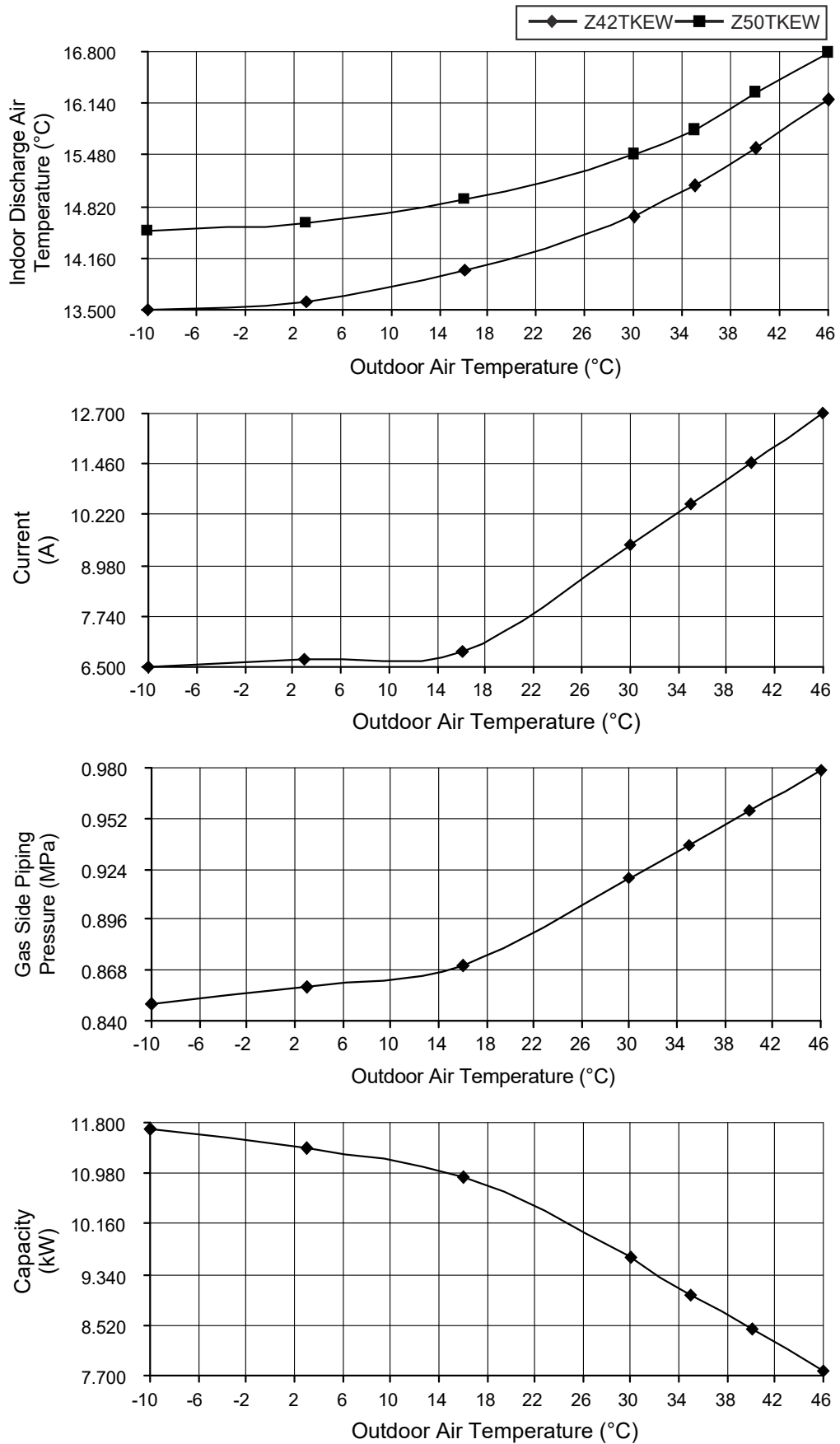

- Heating Characteristic  
 [Condition] Room temperature: 20°C (DBT), 12°C (WBT)  
 Operation condition: High fan speed  
 Piping Length: 5m  
 Voltage: 230V, 50Hz

A) Indoor unit capacity: Heating (2.0kW + 2.5kW), CS-Z20TKEW + CS-Z25TKEW, service mode frequency = 58 Hz

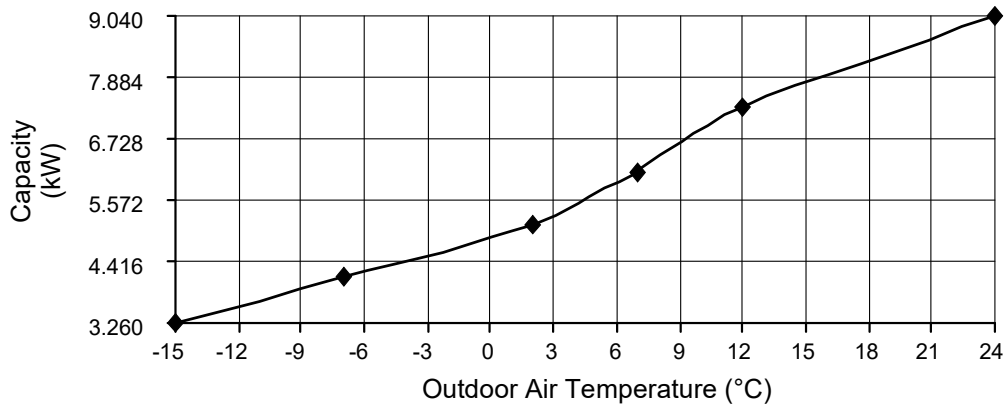
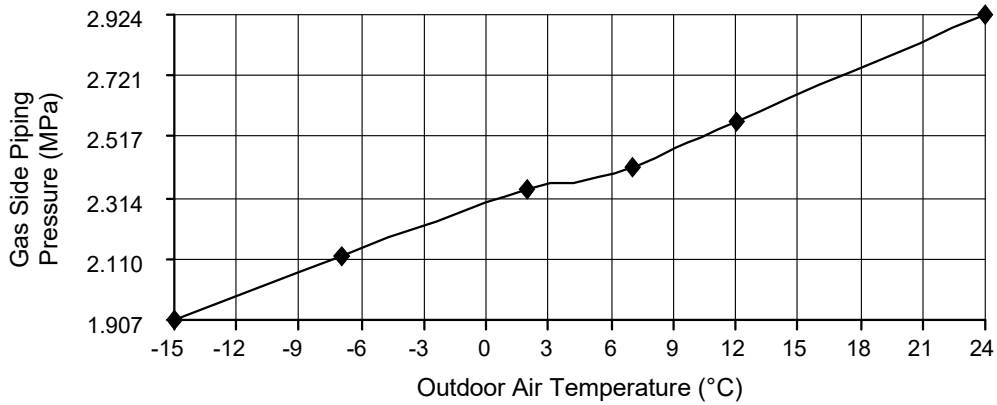
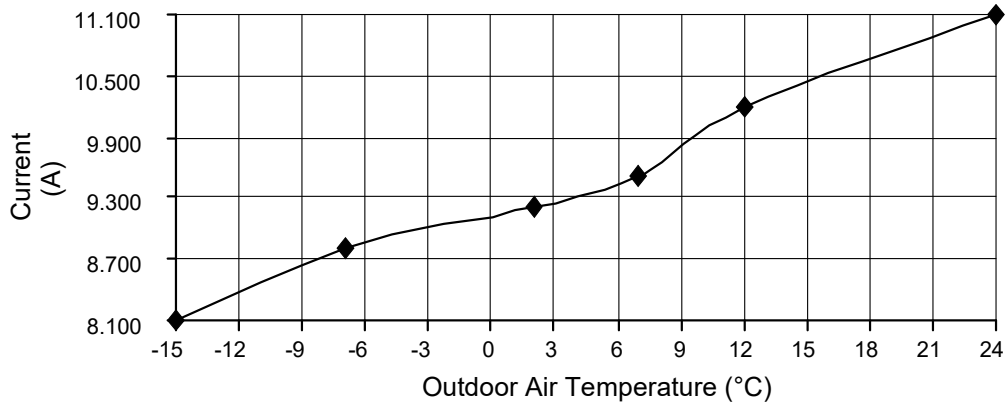
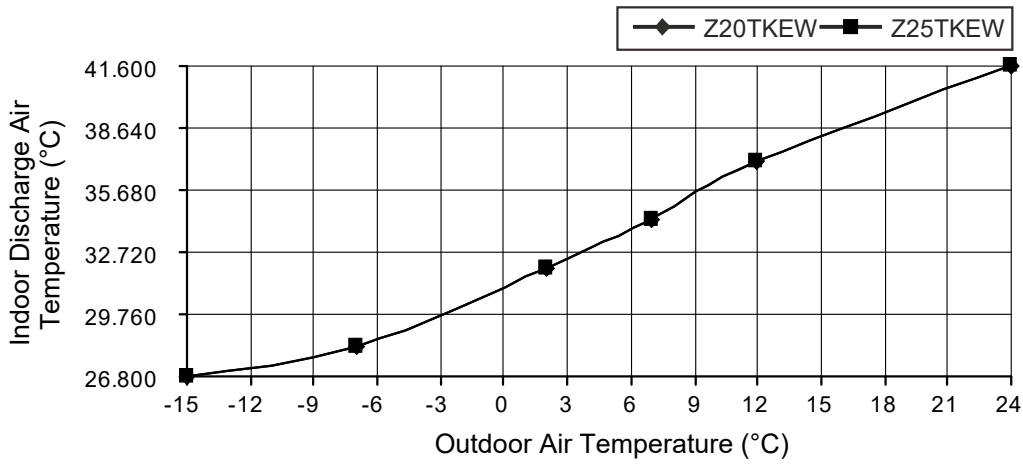

- Heating Characteristic
- [Condition] Room temperature: 20°C (DBT), 12°C (WBT)  
 Operation condition: High fan speed  
 Piping Length: 5m  
 Voltage: 230V, 50Hz

B) Indoor unit capacity: Heating (2.0kW + 4.0kW), CS-Z20TKEW + CS-Z42TKEW, service mode frequency = 64 Hz

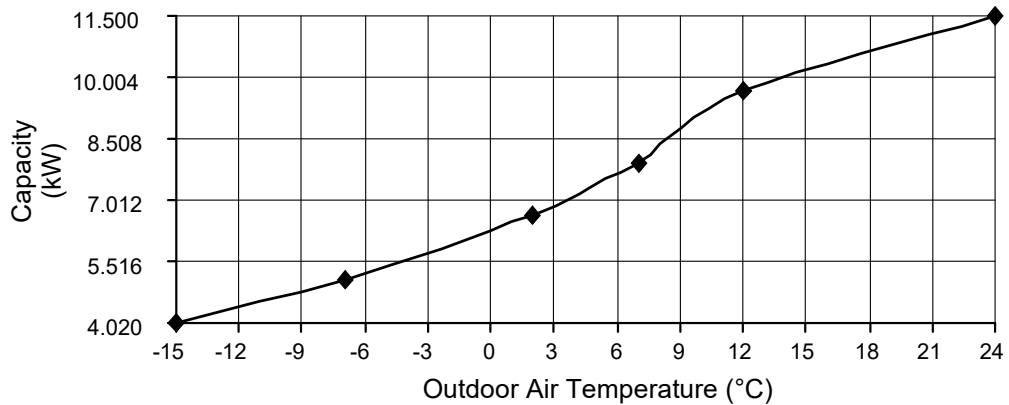
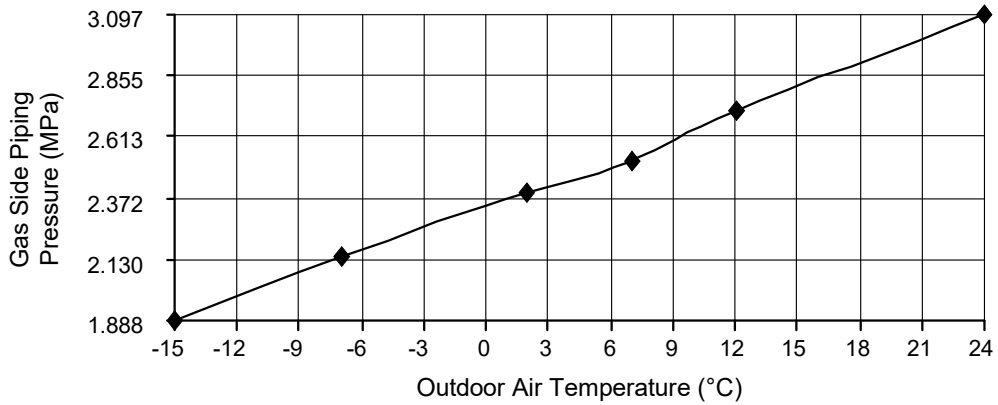
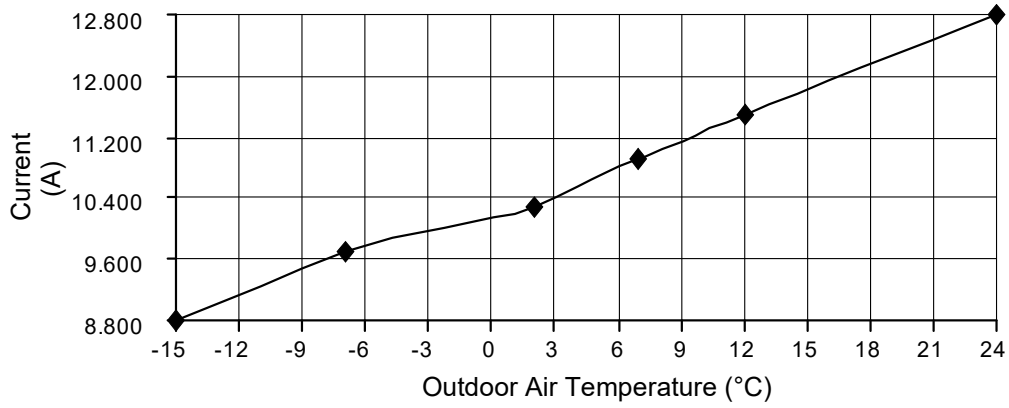
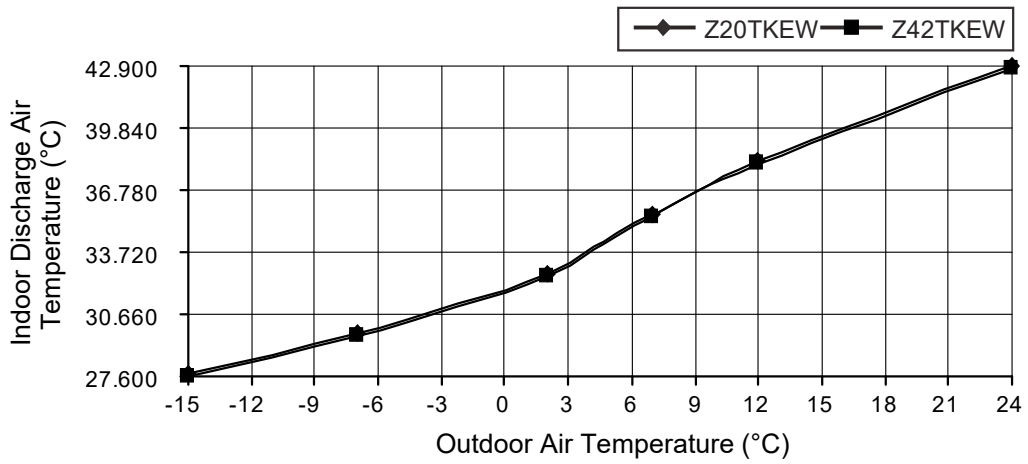

- Heating Characteristic
- [Condition] Room temperature: 20°C (DBT), 12°C (WBT)  
 Operation condition: High fan speed  
 Piping Length: 5m  
 Voltage: 230V, 50Hz

C) Indoor unit capacity: Heating (2.0kW + 5.0kW), CS-Z20TKEW + CS-Z50TKEW, service mode frequency = 68 Hz

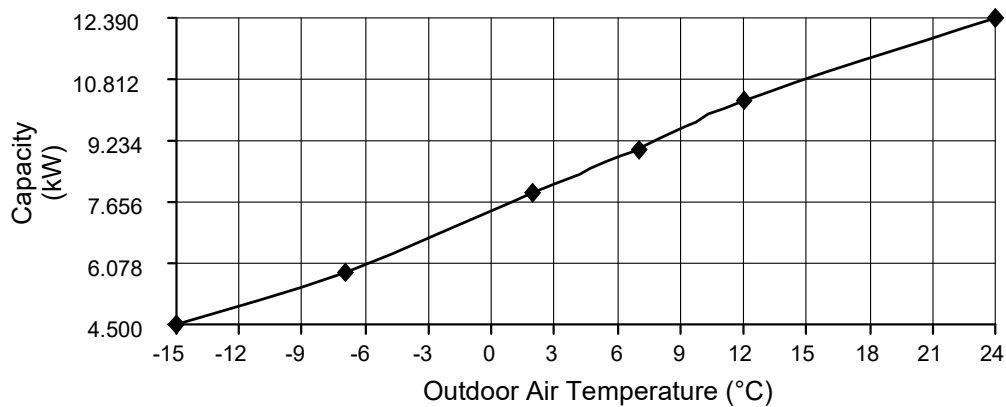
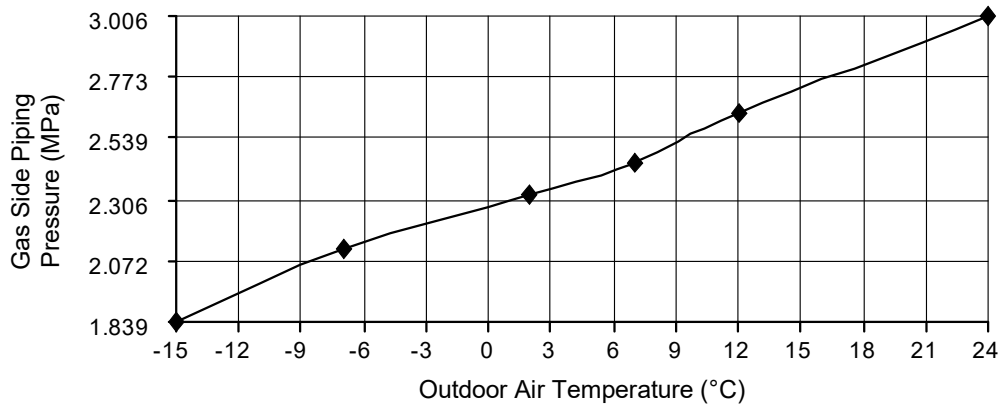
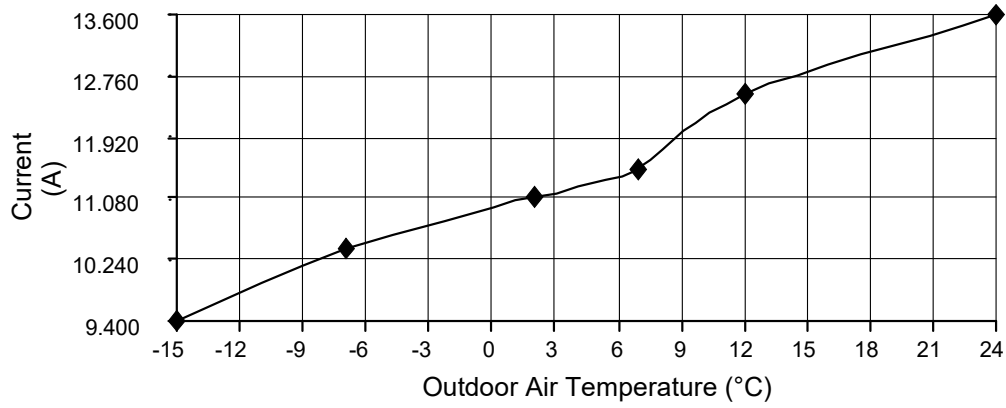
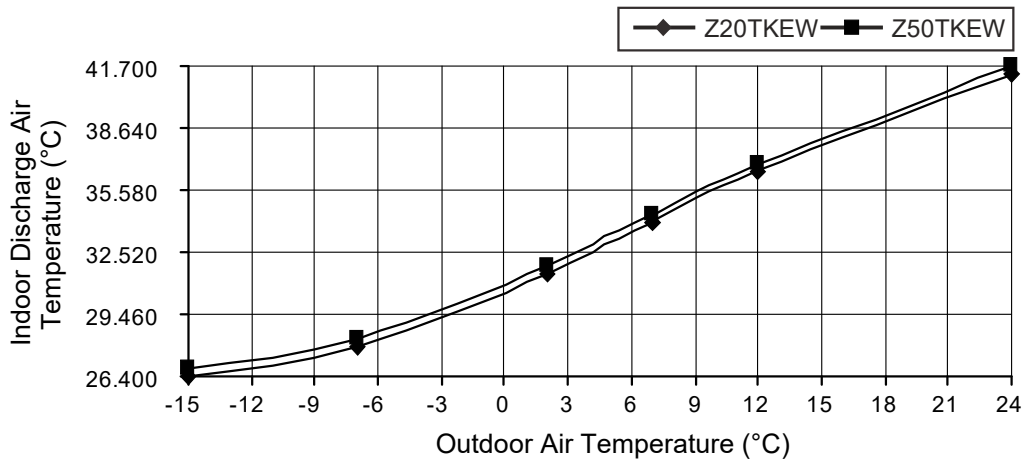

- Heating Characteristic
- [Condition] Room temperature: 20°C (DBT), 12°C (WBT)  
 Operation condition: High fan speed  
 Piping Length: 5m  
 Voltage: 230V, 50Hz

D) Indoor unit capacity: Heating (2.5kW + 4.0kW), CS-Z25TKEW + CS-Z42TKEW, service mode frequency = 64 Hz

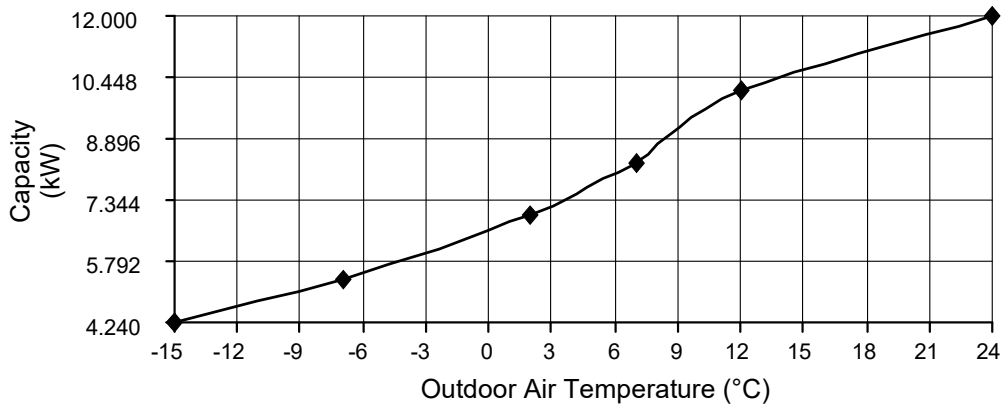
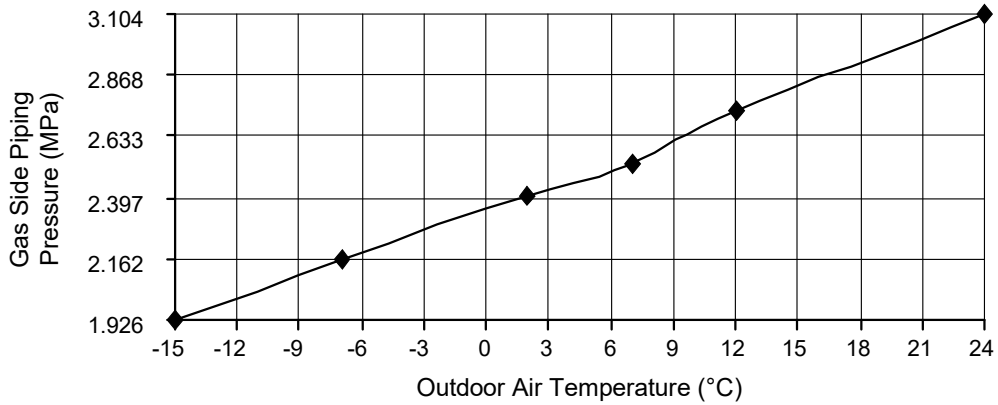
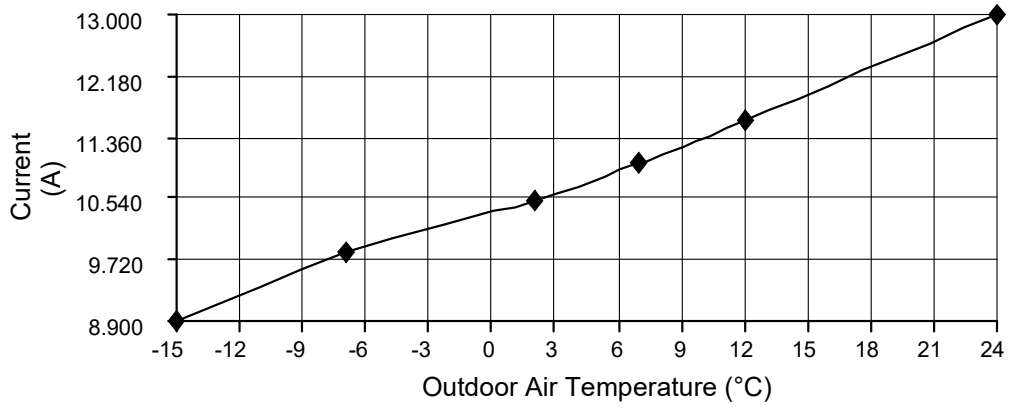
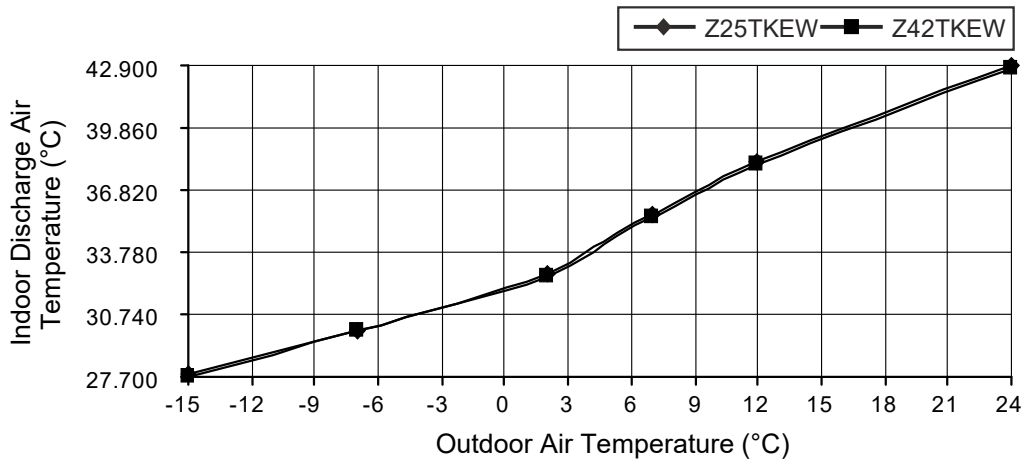

- Heating Characteristic
- [Condition] Room temperature: 20°C (DBT), 12°C (WBT)  
 Operation condition: High fan speed  
 Piping Length: 5m  
 Voltage: 230V, 50Hz

E) Indoor unit capacity: Heating (2.5kW + 5.0kW), CS-Z25TKEW + CS-Z50TKEW, service mode frequency = 68 Hz

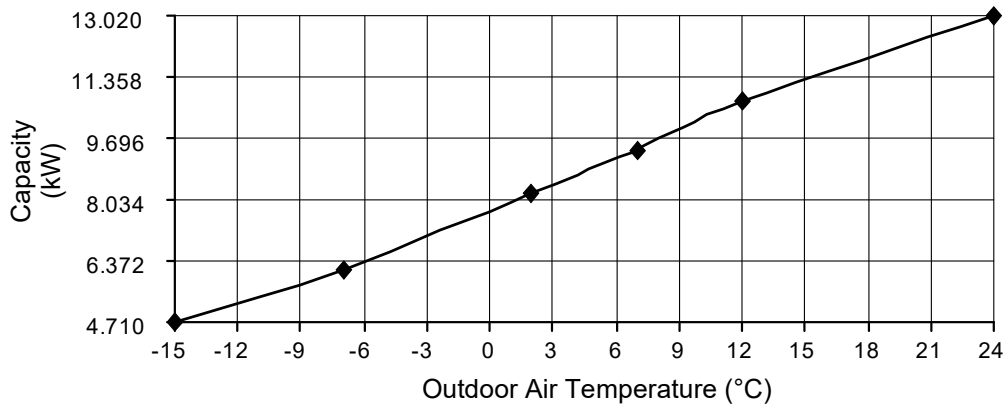
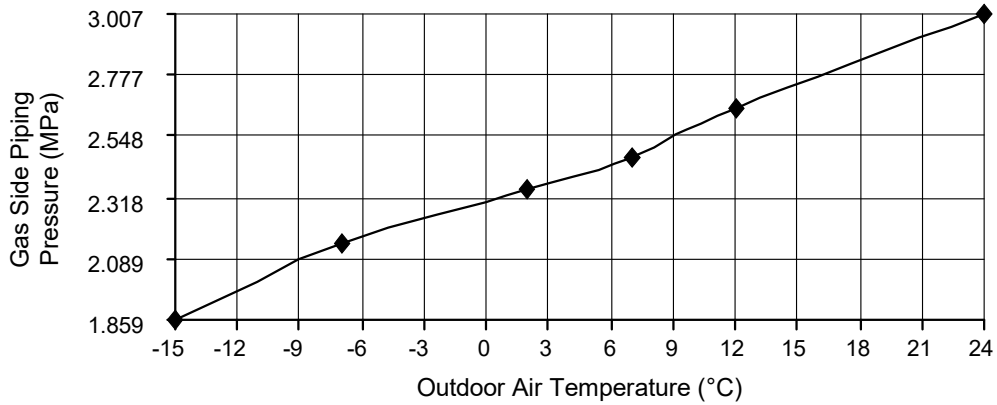
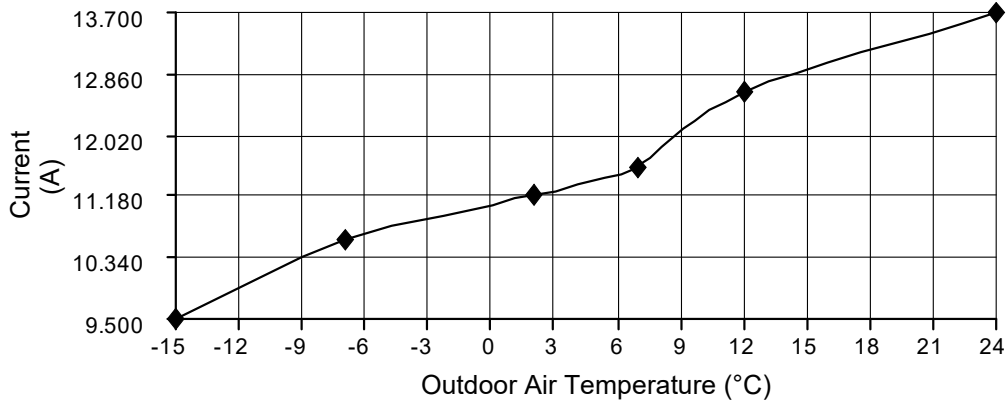
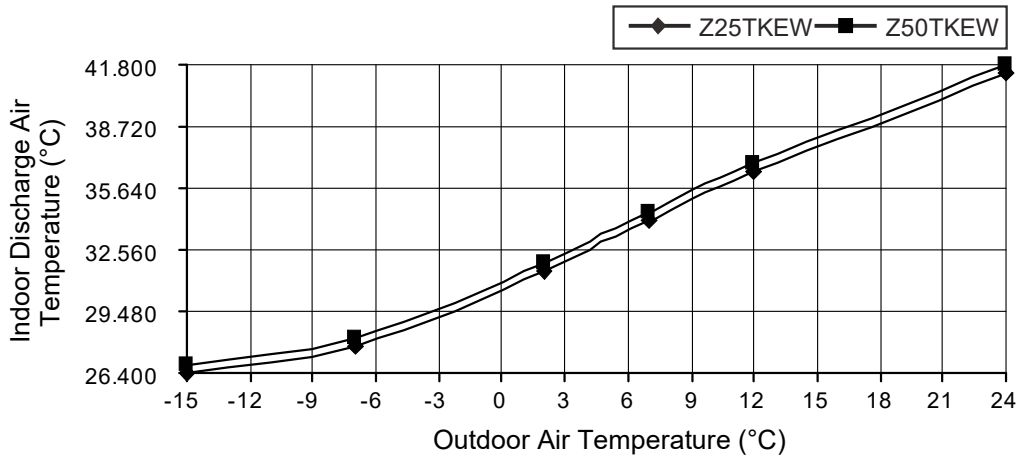

- Heating Characteristic
- [Condition] Room temperature: 20°C (DBT), 12°C (WBT)  
 Operation condition: High fan speed  
 Piping Length: 5m  
 Voltage: 230V, 50Hz

F) Indoor unit capacity: Heating (4.0kW + 5.0kW), CS-Z42TKEW + CS-Z50TKEW, service mode frequency = 73 Hz

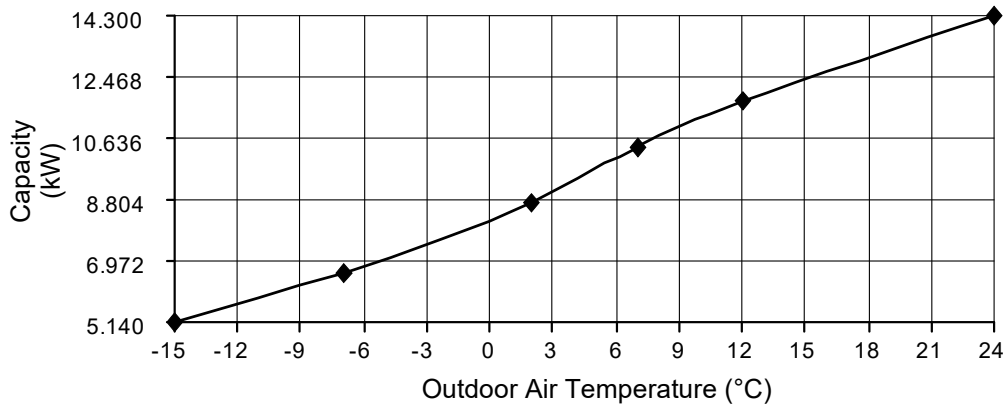
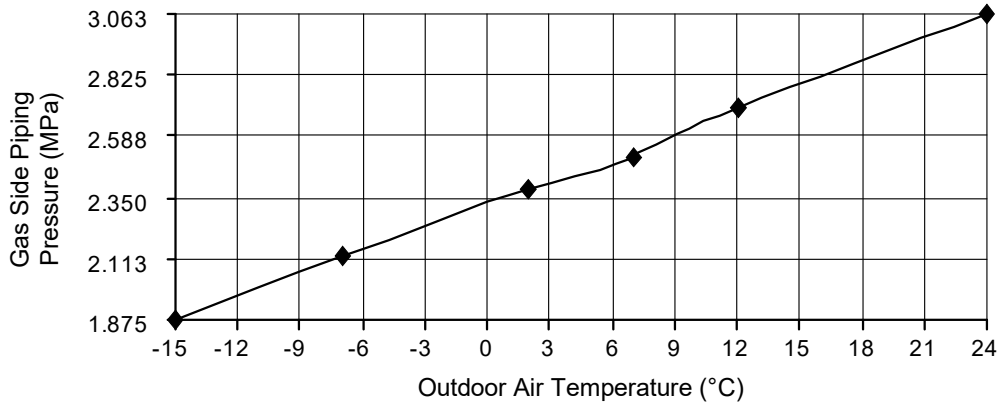
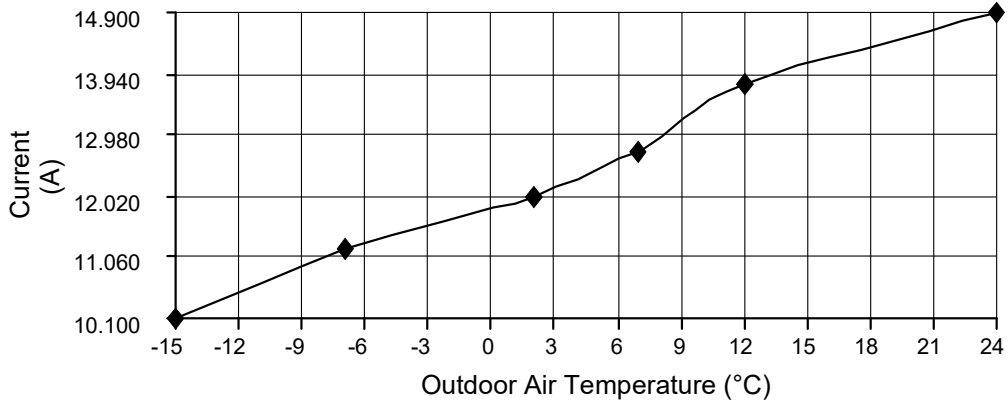
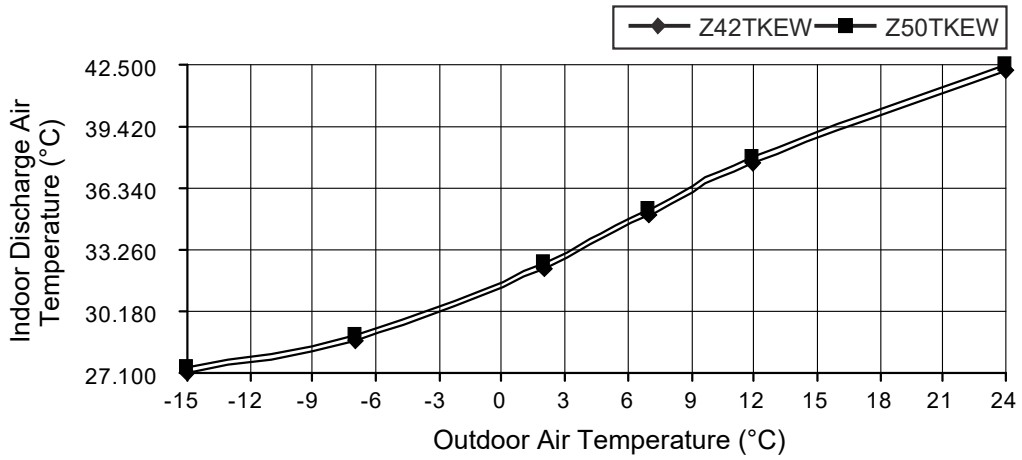

### 19.2.3 Three Indoor Units Operation

- Cooling Characteristic

[Condition] Room temperature: 27°C (DBT), 19°C (WBT)

Operation condition: High fan speed

Piping Length: 5m

Voltage: 230V, 50Hz

A) Indoor unit capacity: Cooling (2.0kW + 2.5kW + 4.2kW), CS-Z20TKEW + CS-Z25TKEW + CS-Z42TKEW, service mode frequency = 55 Hz

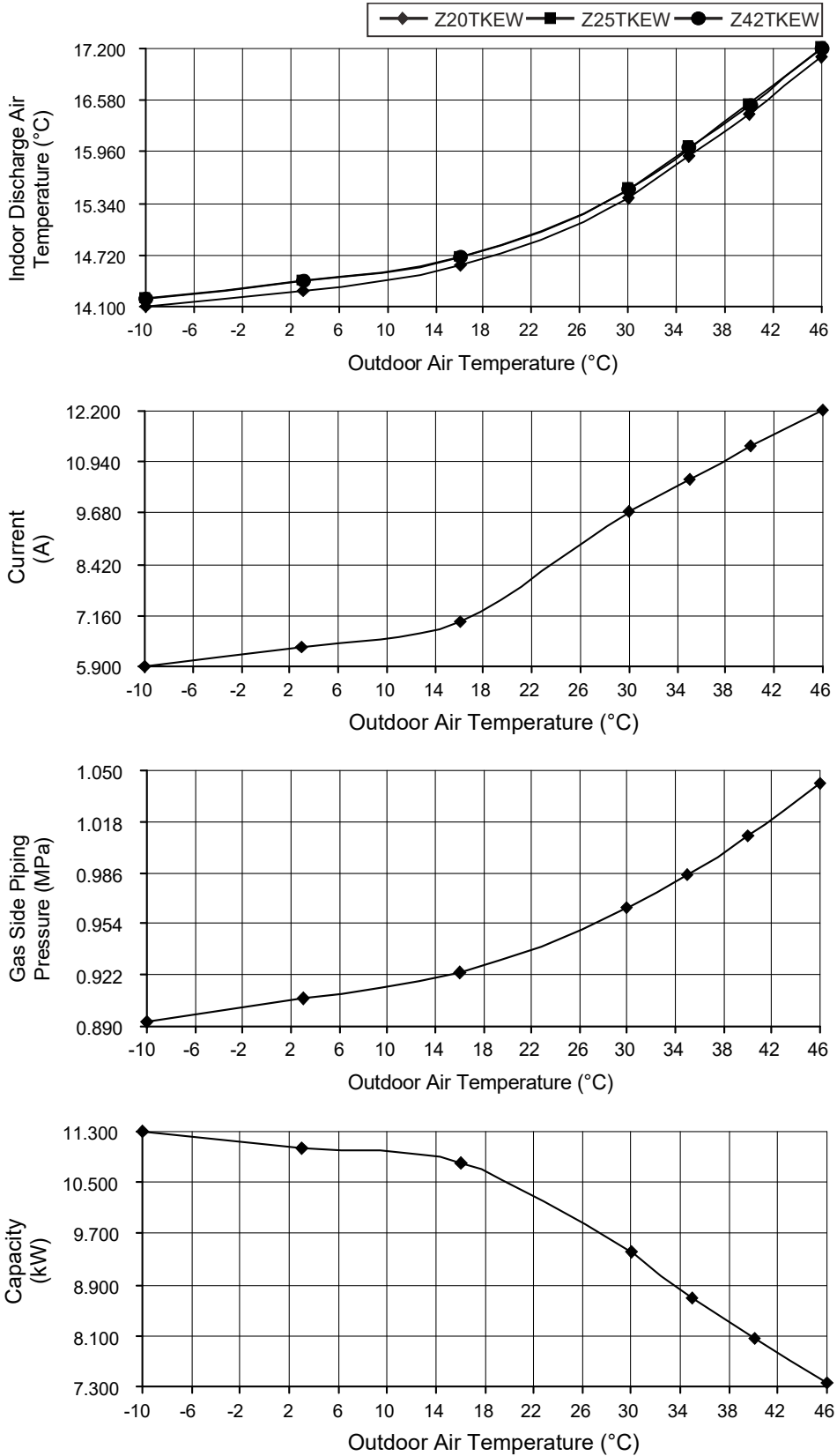



- Cooling Characteristic
- [Condition] Room temperature: 27°C (DBT), 19°C (WBT)  
 Operation condition: High fan speed  
 Piping Length: 5m  
 Voltage: 230V, 50Hz

B) Indoor unit capacity: Cooling (2.0kW + 2.5kW + 5.0kW), CS-Z20TKEW + CS-Z25TKEW + CS-Z50TKEW, service mode frequency = 57 Hz

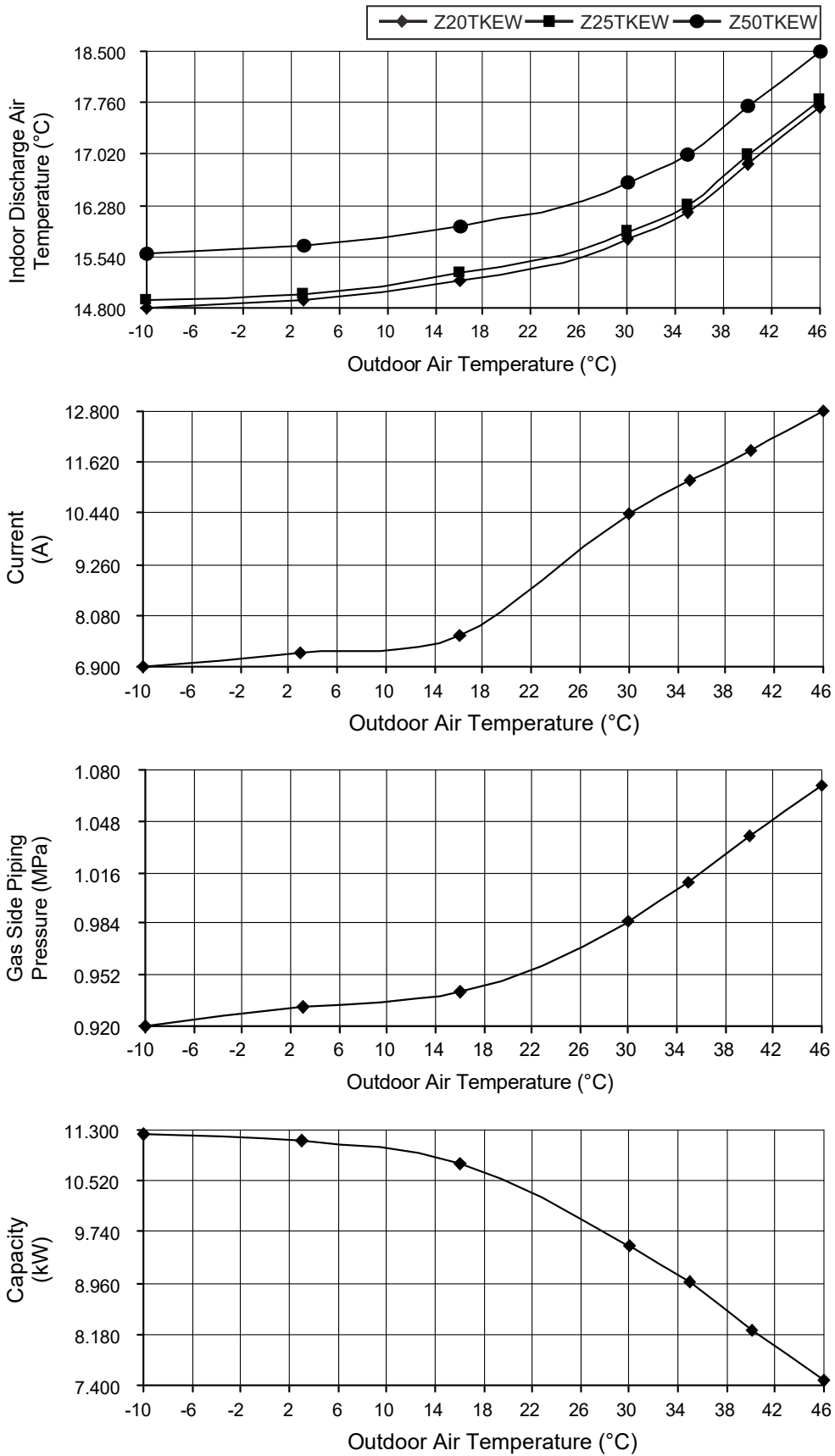

- Cooling Characteristic
- [Condition] Room temperature: 27°C (DBT), 19°C (WBT)  
 Operation condition: High fan speed  
 Piping Length: 5m  
 Voltage: 230V, 50Hz

C) Indoor unit capacity: Cooling (2.0kW + 4.2kW + 5.0kW), CS-Z20TKEW + CS-Z42TKEW + CS-Z50TKEW, service mode frequency = 59 Hz

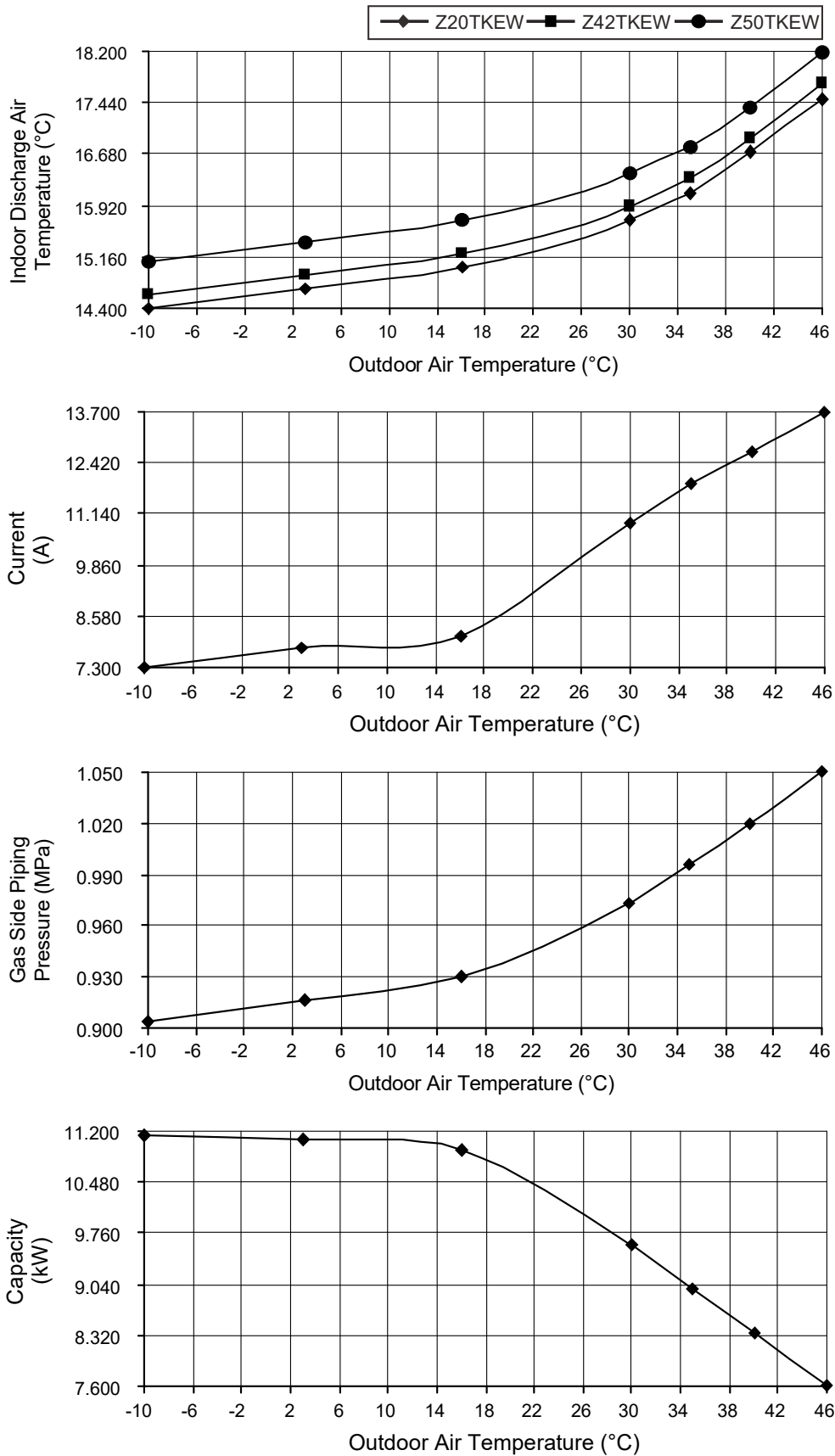

- Cooling Characteristic  
 [Condition] Room temperature: 27°C (DBT), 19°C (WBT)  
 Operation condition: High fan speed  
 Piping Length: 5m  
 Voltage: 230V, 50Hz

D) Indoor unit capacity: Cooling (2.5kW + 4.2kW + 5.0kW), CS-Z25TKEW + CS-Z42TKEW + CS-Z50TKEW, service mode frequency = 59 Hz

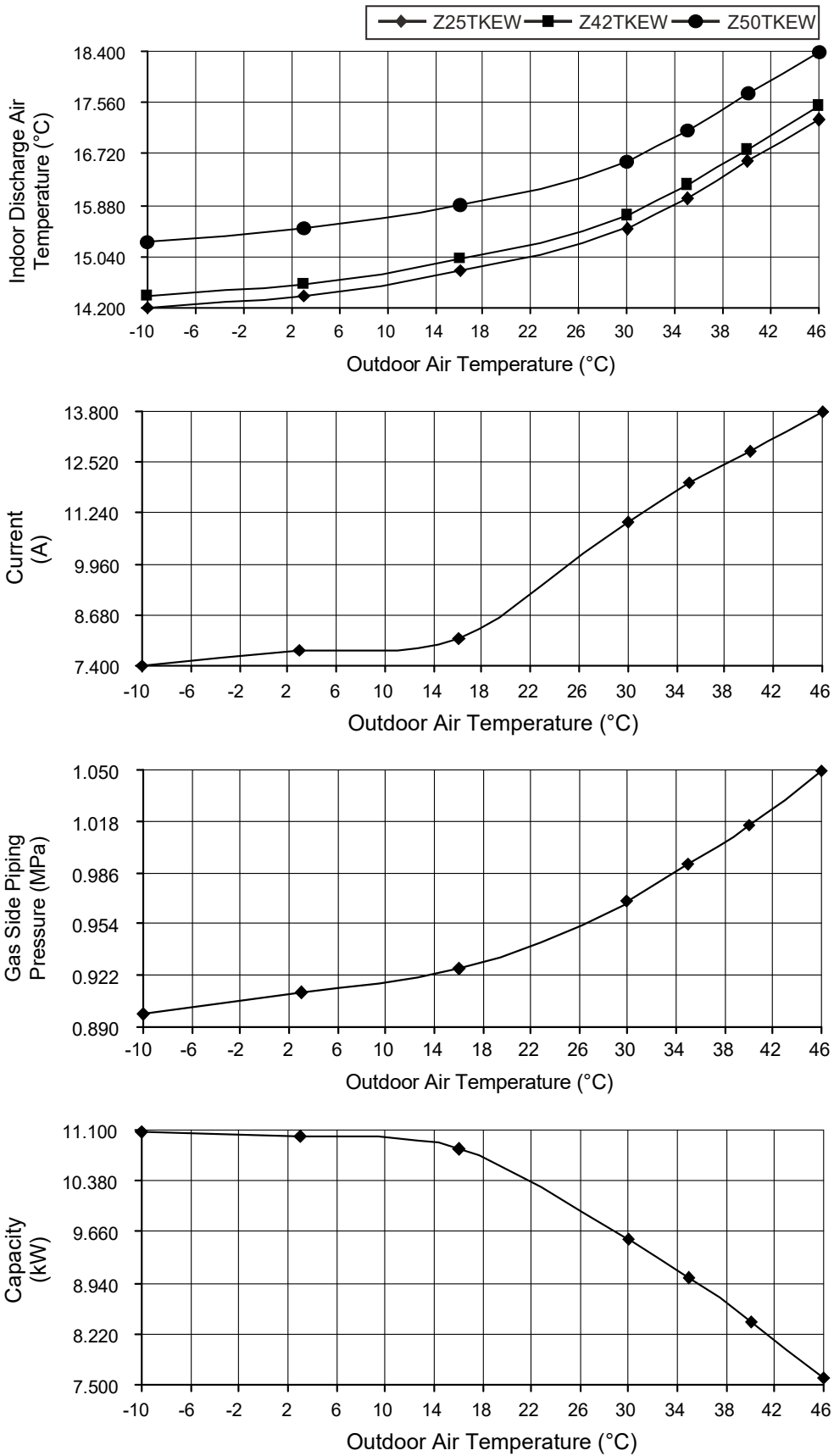

- Heating Characteristic
- [Condition] Room temperature: 20°C (DBT), 12°C (WBT)  
 Operation condition: High fan speed  
 Piping Length: 5m  
 Voltage: 230V, 50Hz

A) Indoor unit capacity: Heating (2.0kW + 2.5kW + 4.2kW), CS-Z20TKEW + CS-Z25TKEW + CS-Z42TKEW, service mode frequency = 77 Hz

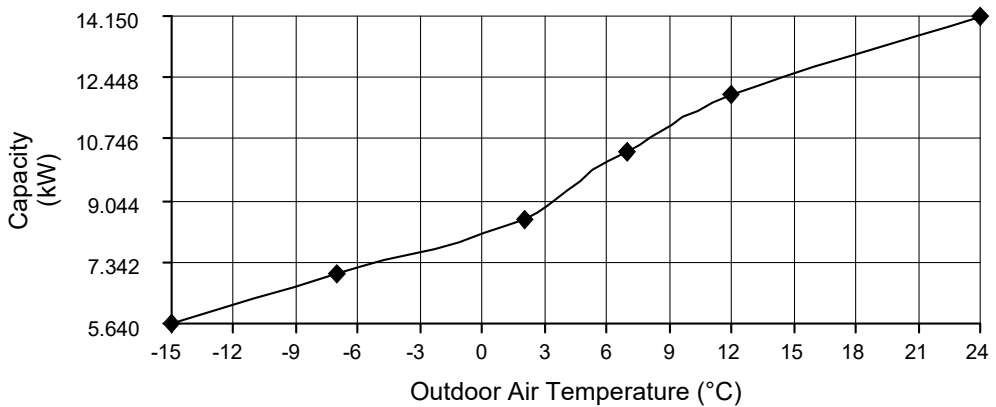
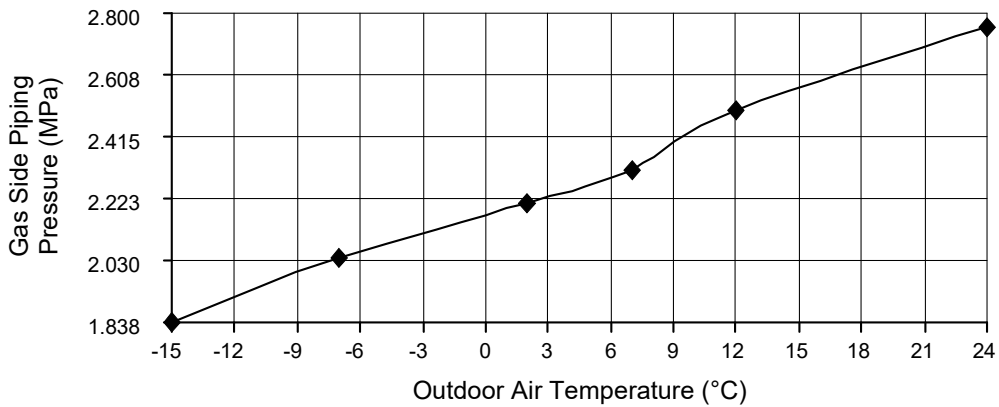
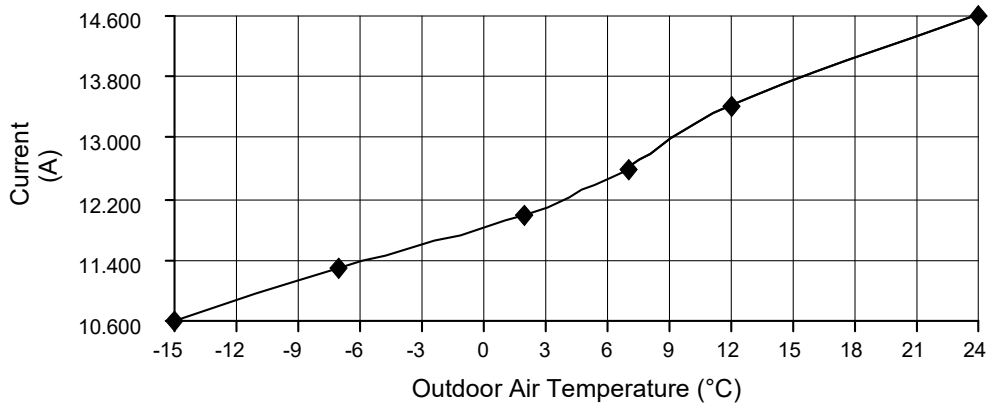
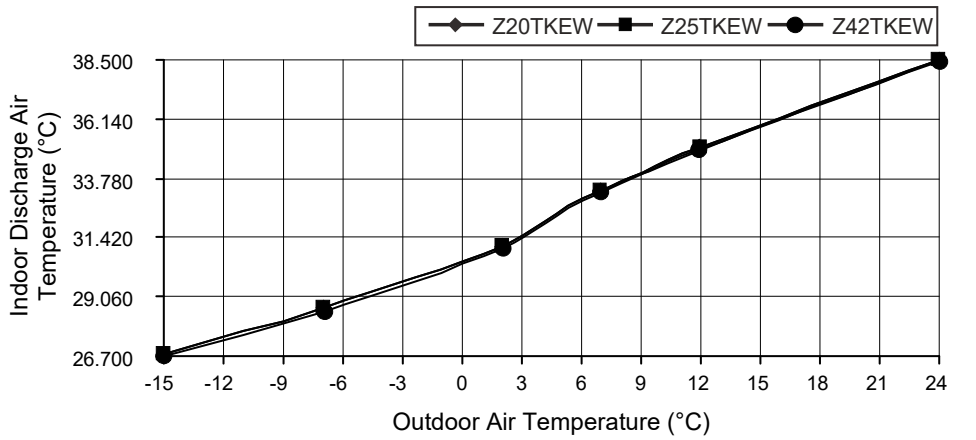

- Heating Characteristic  
 [Condition] Room temperature: 20°C (DBT), 12°C (WBT)  
 Operation condition: High fan speed  
 Piping Length: 5m  
 Voltage: 230V, 50Hz

B) Indoor unit capacity: Heating (2.0kW + 2.5kW + 5.0kW), CS-Z20TKEW + CS-Z25TKEW + CS-Z50TKEW, service mode frequency = 77 Hz

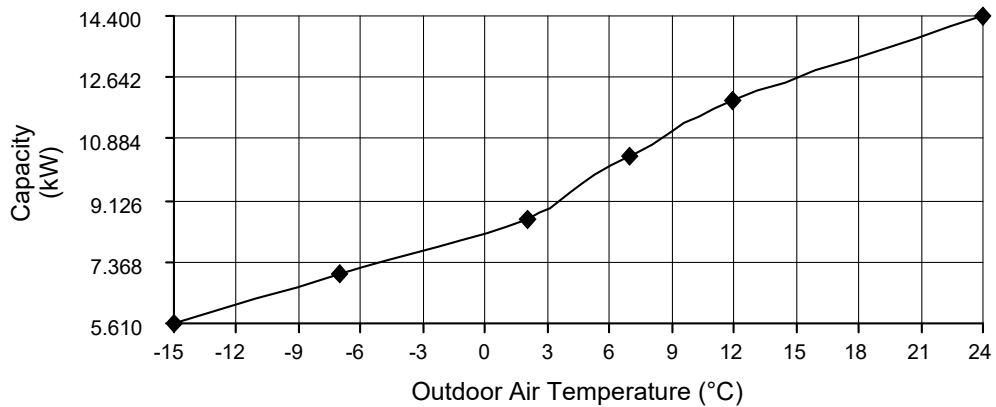
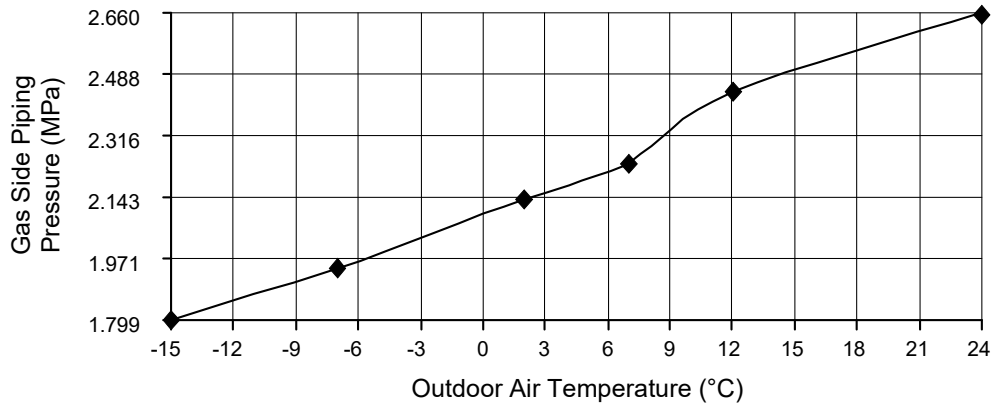
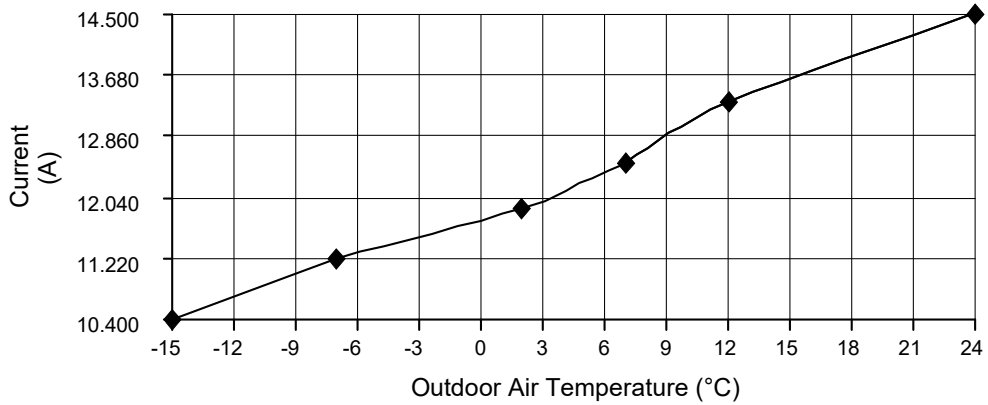
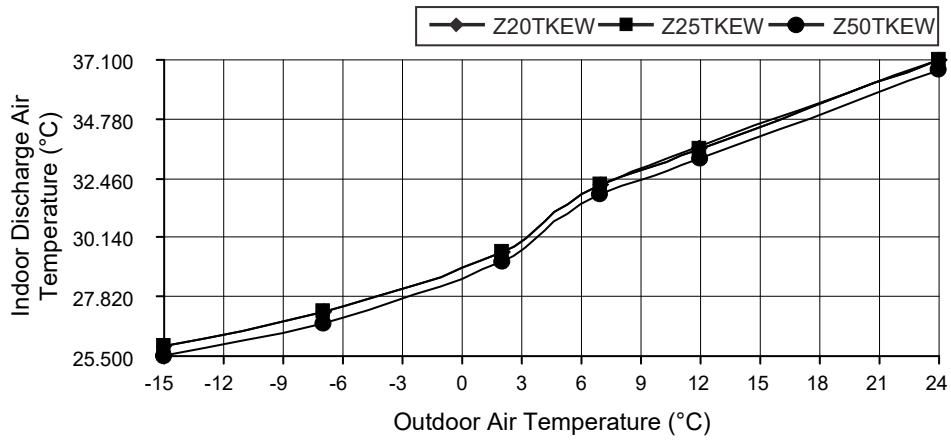

- Heating Characteristic  
 [Condition] Room temperature: 20°C (DBT), 12°C (WBT)  
 Operation condition: High fan speed  
 Piping Length: 5m  
 Voltage: 230V, 50Hz

C) Indoor unit capacity: Heating (2.0kW + 4.0kW + 5.0kW), CS-Z20TKEW + CS-Z42TKEW + CS-Z50TKEW, service mode frequency = 82 Hz

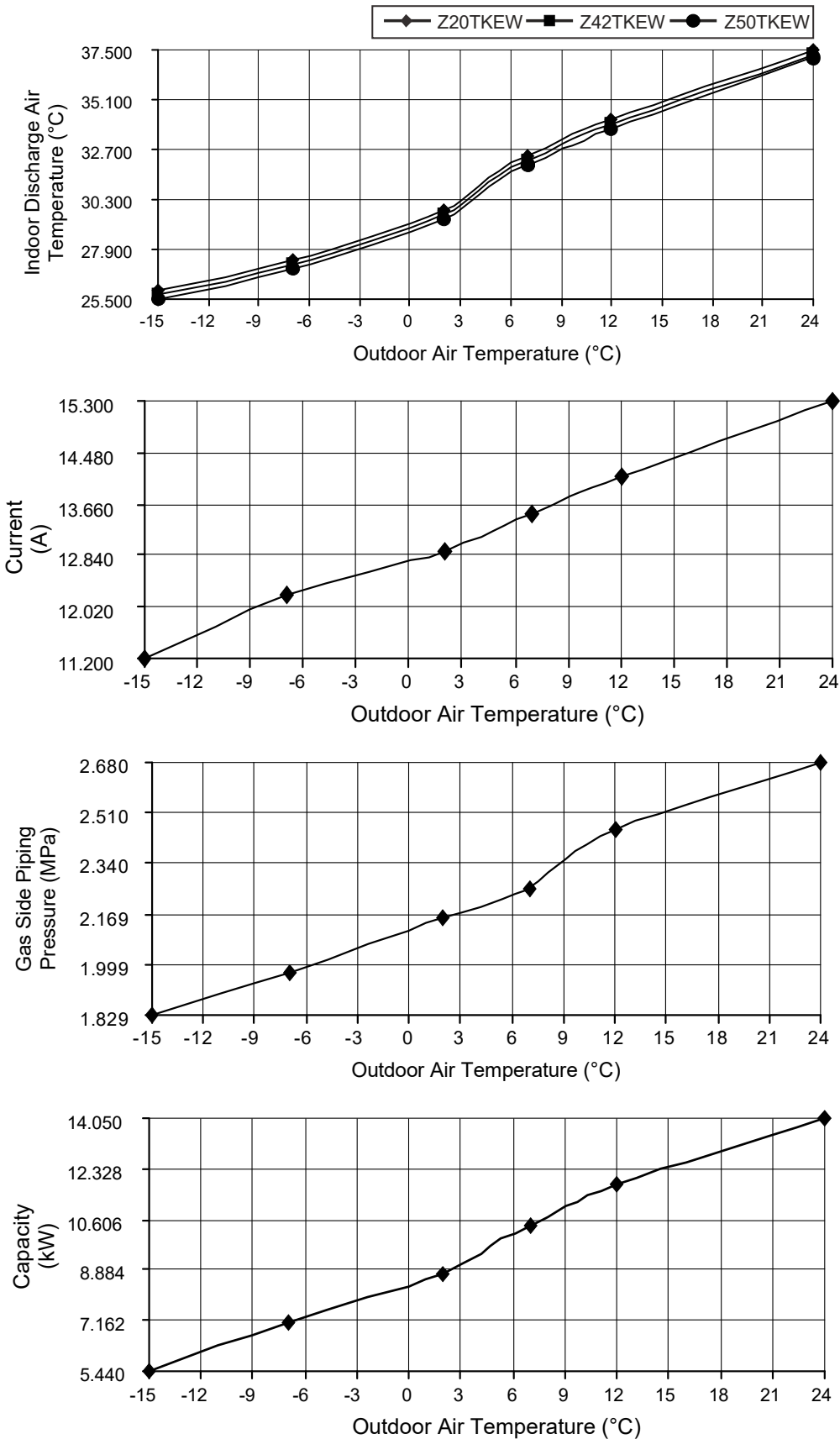

- Heating Characteristic
- [Condition] Room temperature: 20°C (DBT), 12°C (WBT)  
 Operation condition: High fan speed  
 Piping Length: 5m  
 Voltage: 230V, 50Hz

D) Indoor unit capacity: Heating (2.5kW + 4.0kW + 5.0kW), CS-Z25TKEW + CS-Z42TKEW + CS-Z50TKEW, service mode frequency = 82 Hz

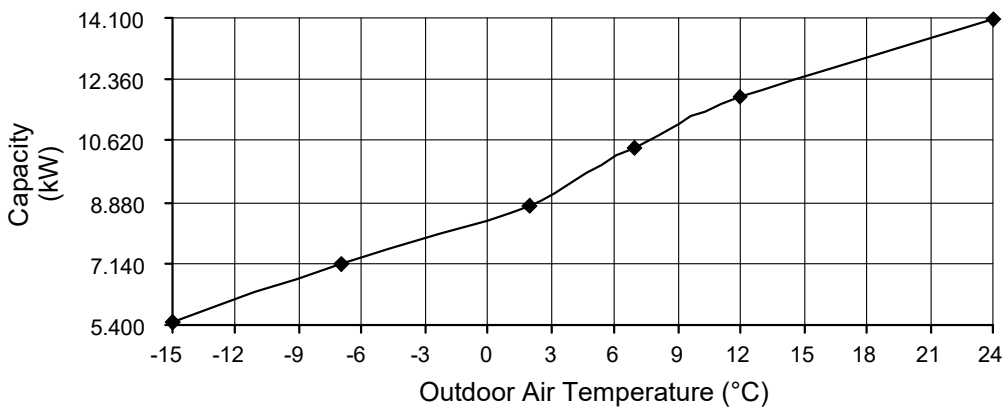
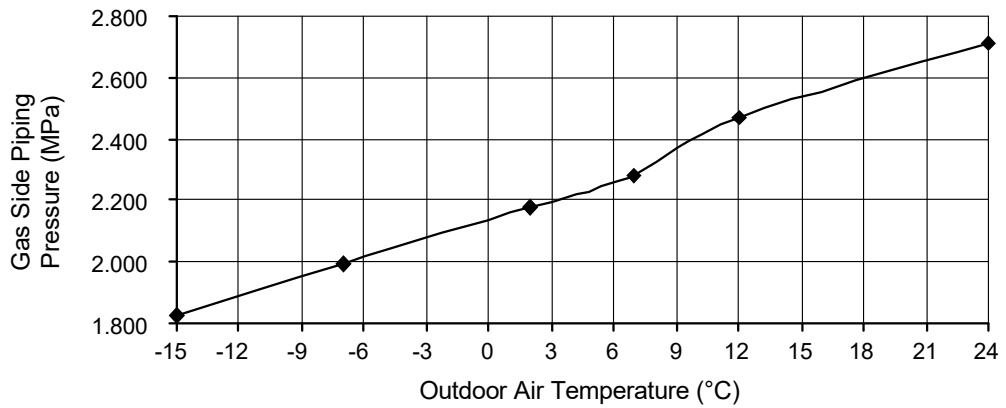
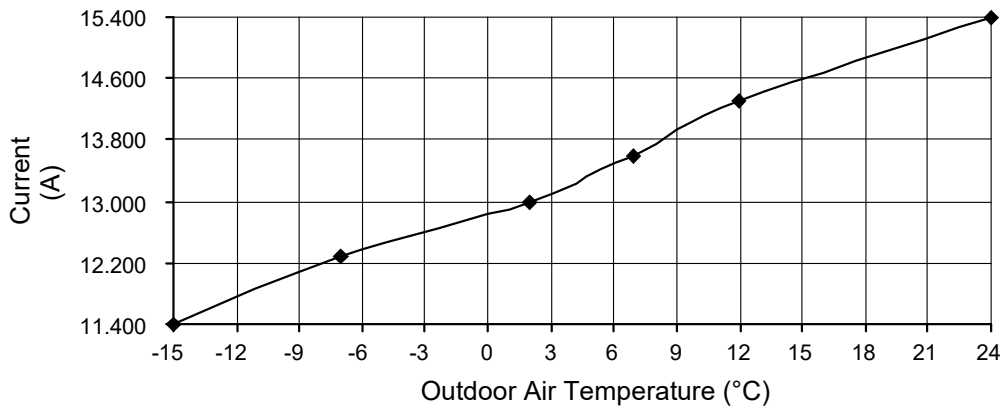
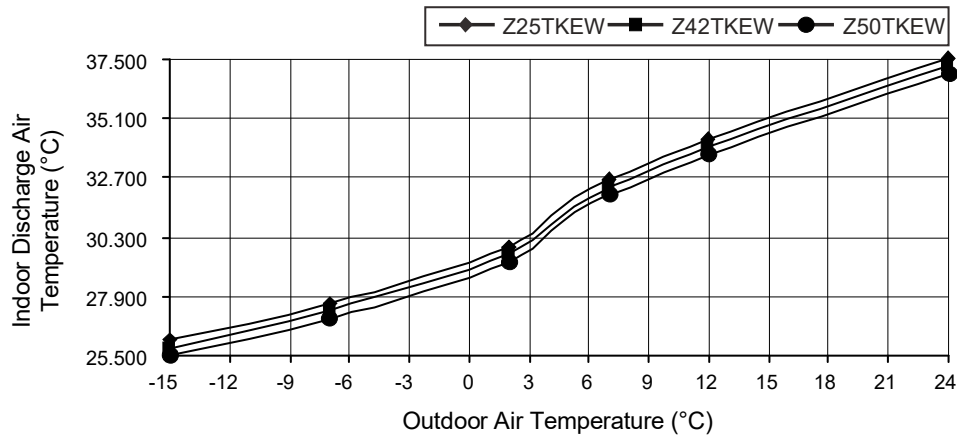

## 19.2.4 Four Indoor Units Operation

- Cooling Characteristic

[Condition] Room temperature: 27°C (DBT), 19°C (WBT)

Operation condition: High fan speed

Piping Length: 5m

Voltage: 230V, 50Hz

A) Indoor unit capacity: Cooling (2.0kW + 2.5kW + 4.2kW + 5.0kW), CS-Z20TKEW + CS-Z25TKEW + CS-Z42TKEW + CS-Z50TKEW, service mode frequency = 65 Hz

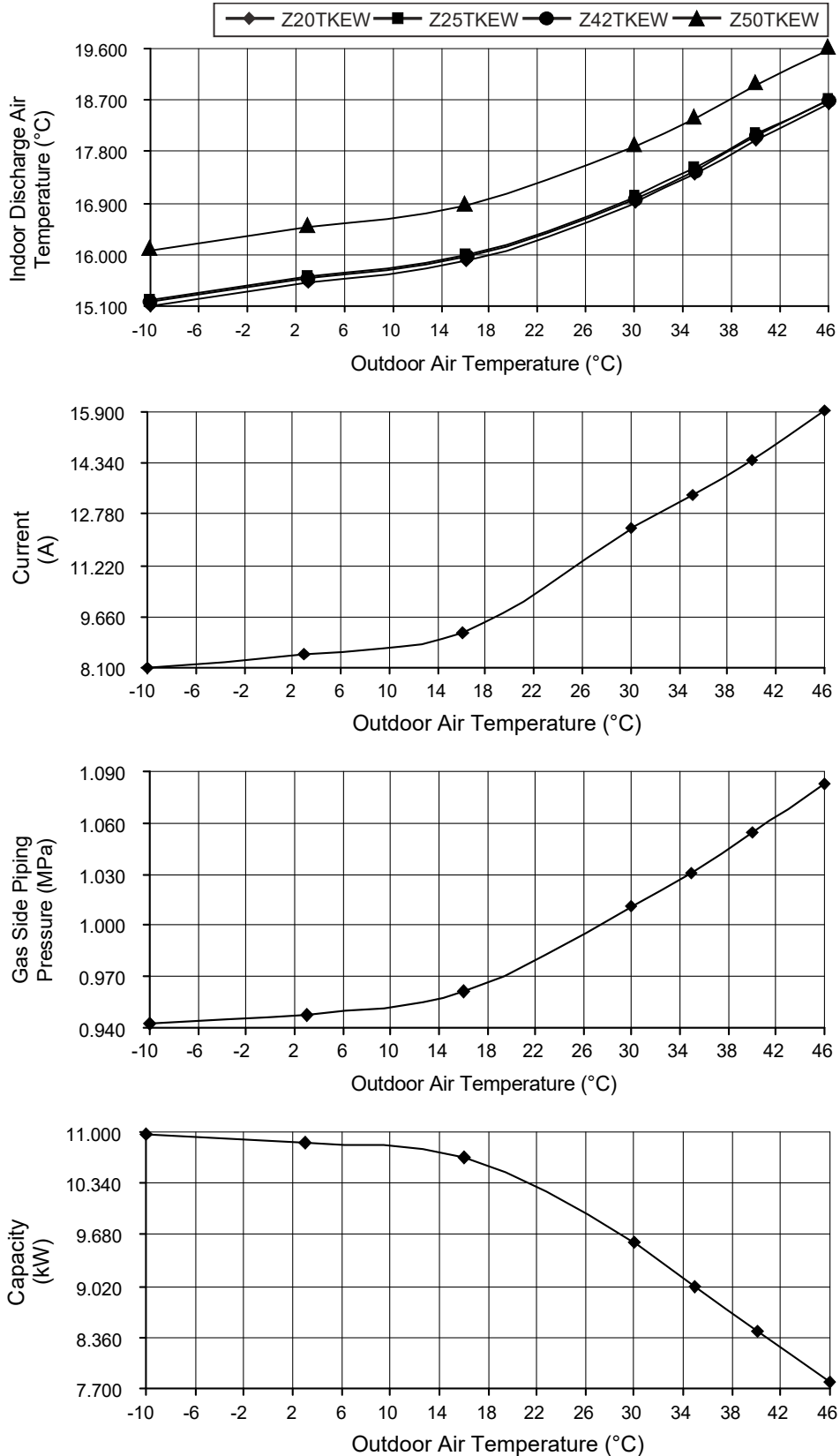



- Heating Characteristic
- [Condition] Room temperature: 20°C (DBT), 12°C (WBT)  
 Operation condition: High fan speed  
 Piping Length: 5m  
 Voltage: 230V, 50Hz

A) Indoor unit capacity: Heating (2.0kW + 2.5kW + 4.0kW + 5.0kW), CS-Z20TKEW + CS-Z25TKEW + CS-Z42TKEW + CS-Z50TKEW, service mode frequency = 86 Hz

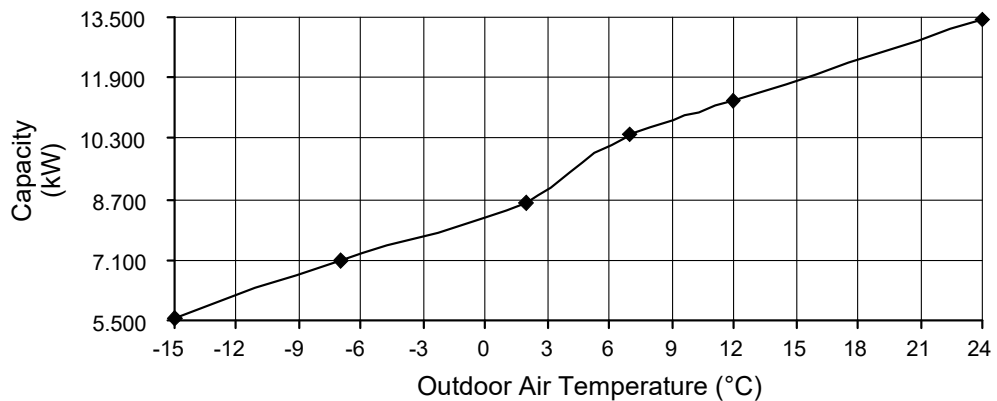
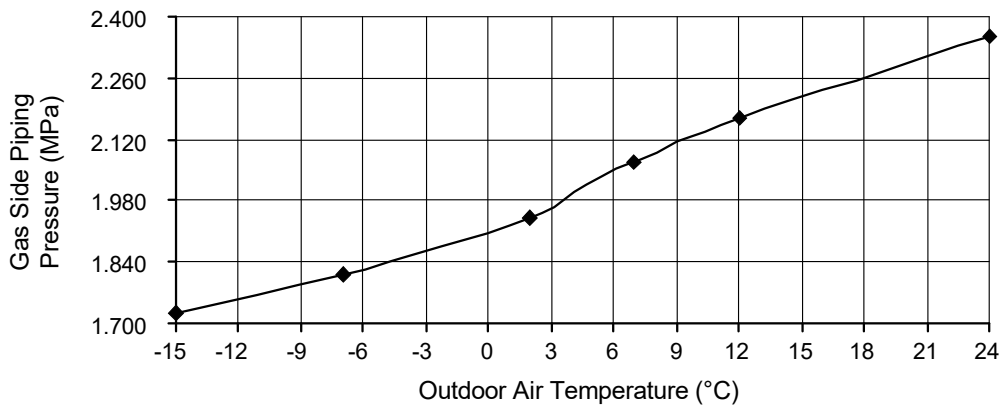
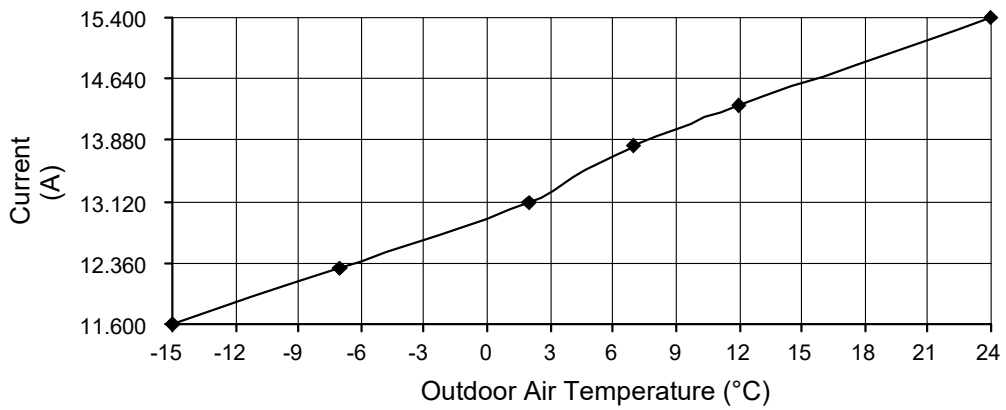
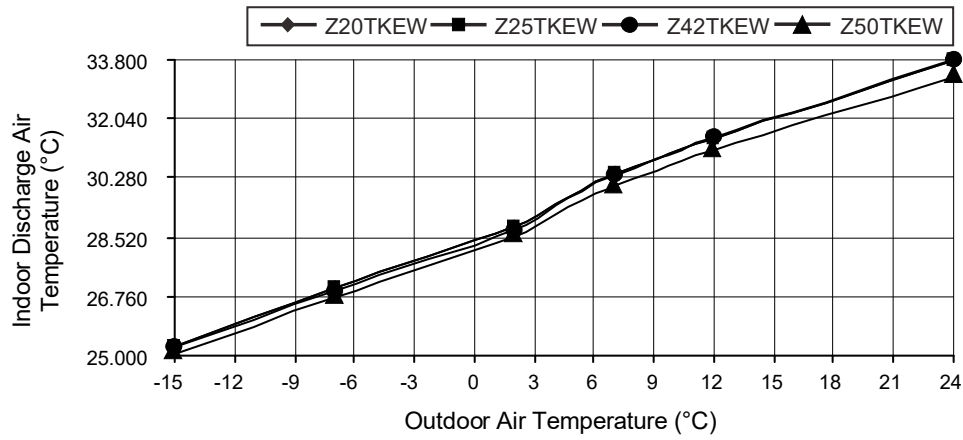

## 19.2.5 Five Indoor Units Operation

- Cooling Characteristic

[Condition] Room temperature: 27°C (DBT), 19°C (WBT)

Operation condition: High fan speed

Piping Length: 5m

Voltage: 230V, 50Hz

A) Indoor unit capacity: Cooling (2.0kW + 2.5kW + 4.2kW + 4.2kW + 5.0kW), CS-Z20TKEW + CS-Z25TKEW + CS-Z42TKEW + CS-Z42TKEW + CS-Z50TKEW, service mode frequency = 75 Hz

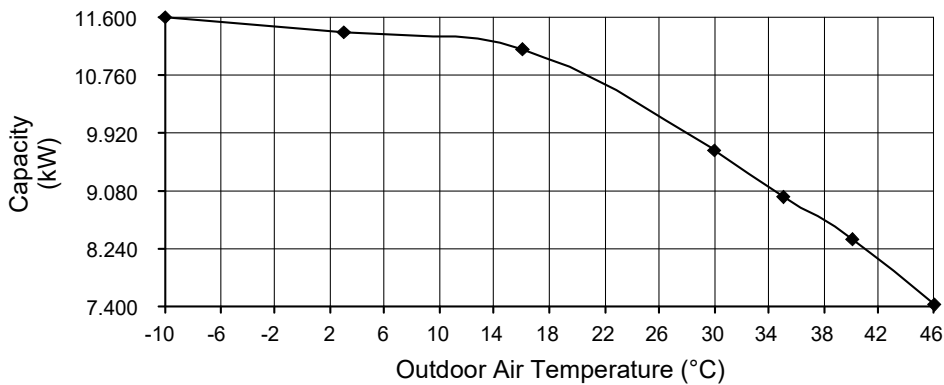
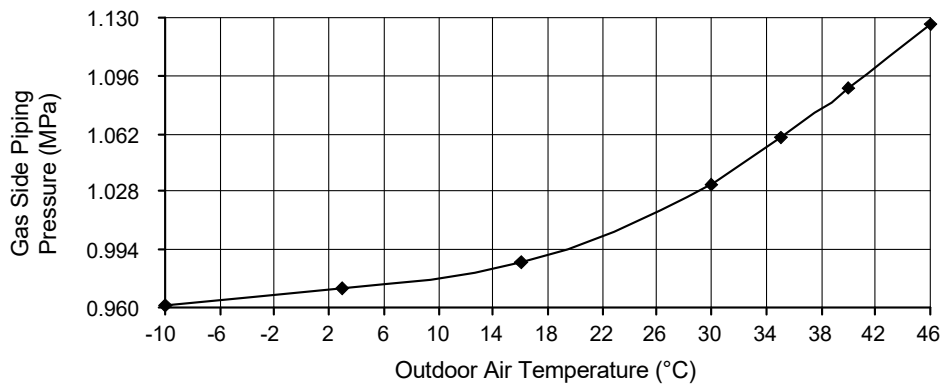
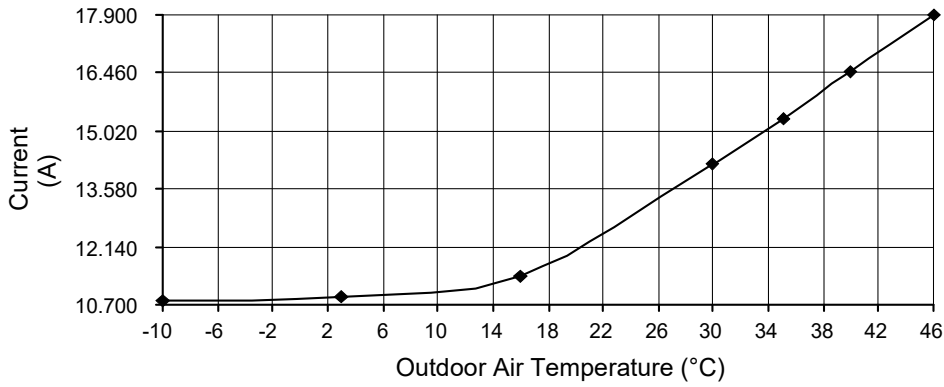
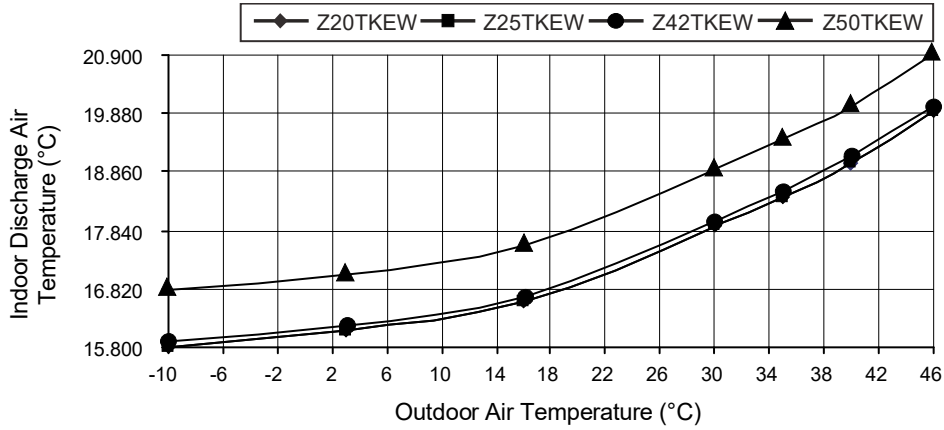

- Heating Characteristic
- [Condition] Room temperature: 20°C (DBT), 12°C (WBT)  
 Operation condition: High fan speed  
 Piping Length: 5m  
 Voltage: 230V, 50Hz



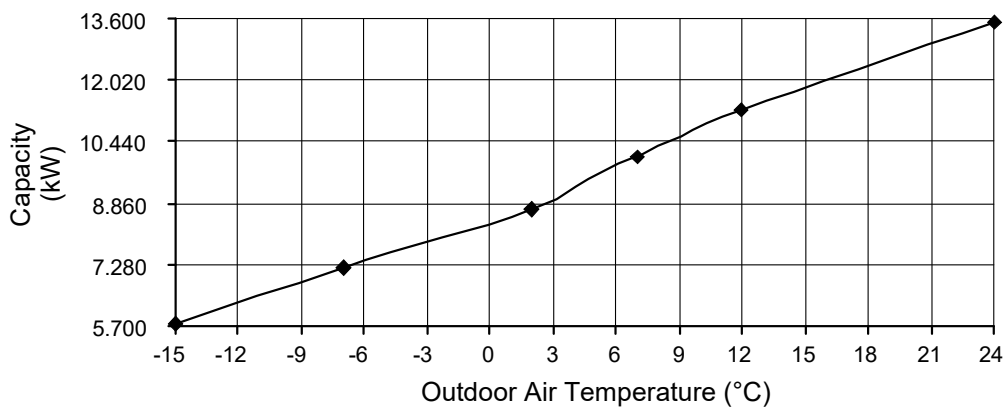
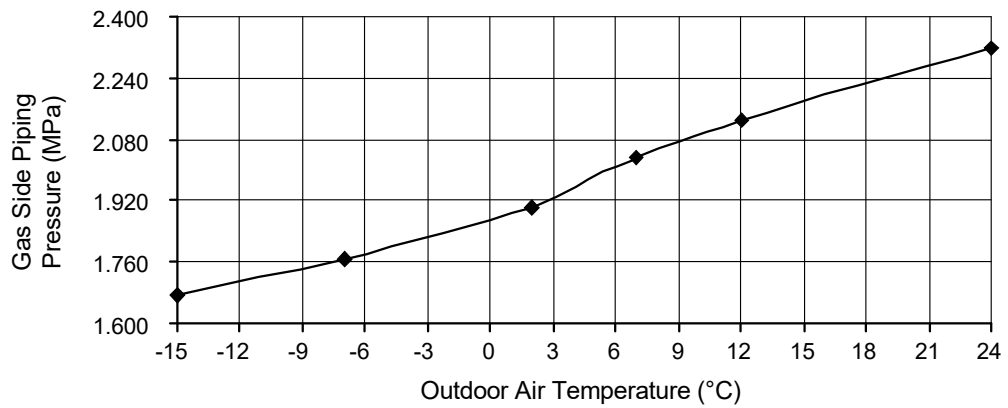
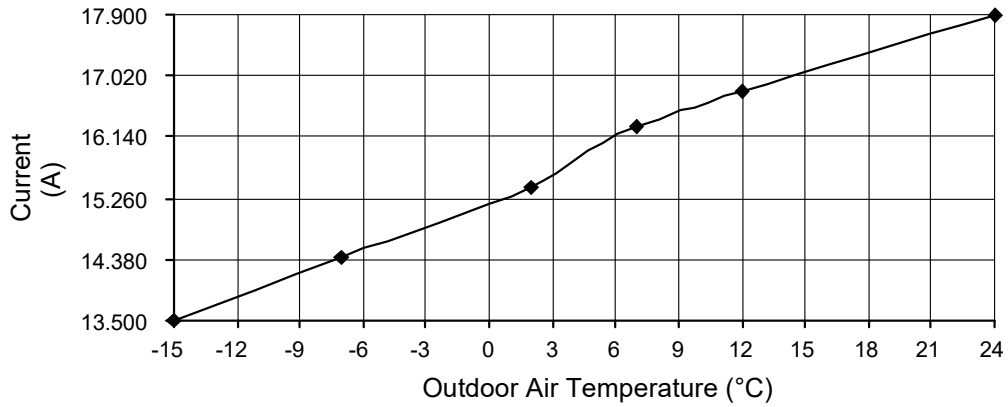
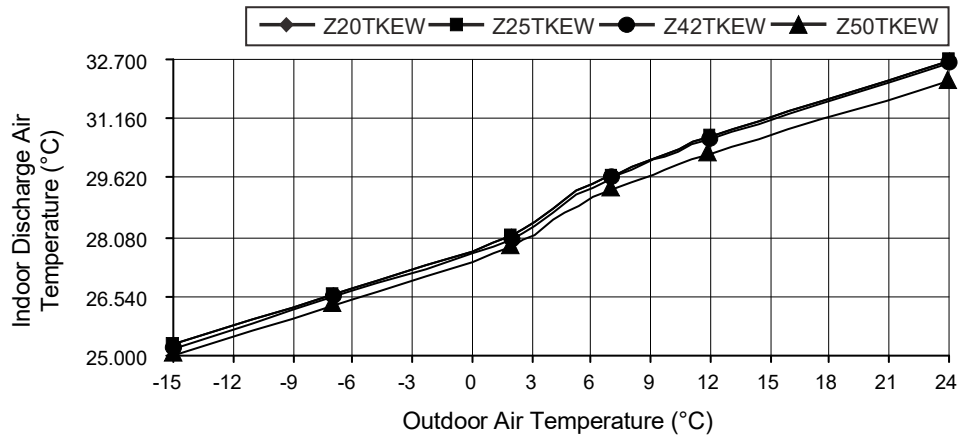



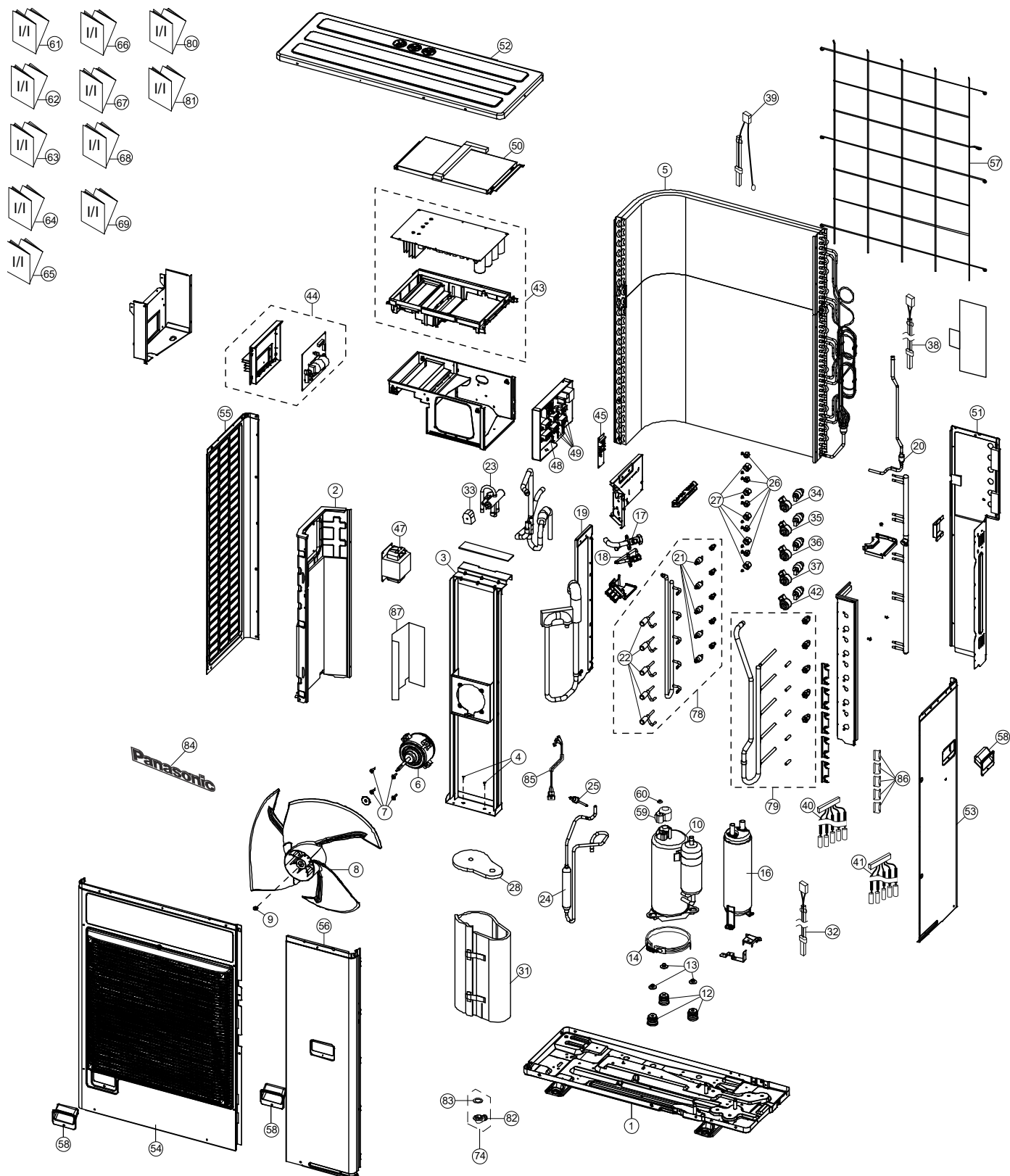

A) Indoor unit capacity: Heating (2.0kW + 2.5kW + 4.0kW + 4.0kW + 5.0kW), CS-Z20TKEW + CS-Z25TKEW + CS-Z42TKEW + CS-Z42TKEW + CS-Z50TKEW, service mode frequency = 95 Hz



## 20. Exploded View and Replacement Parts List











**Note**  
 The above exploded view is for the purpose of parts disassembly and replacement.  
 The non-numbered parts are not kept as standard service parts.

SAFETY	REF.NO.	DESCRIPTION & NAME	QTY.	CU-4Z80TBE	REMARK
	1	BASE PAN ASS'Y	1	CWD52K1345A	
	2	SOUND - PROOF BOARD	1	CWH151367	
	3	FAN MOTOR BRACKET	1	CWD54K1081	
	4	SCREW - FAN MOTOR BRACKET	3	CWH551217	
	5	CONDENSER COMPLETE	1	ACXB32C14960	
	6	FAN MOTOR	1	L6CBYYL0098	O
	7	SCREW - FAN MOTOR MOUNT	4	CWH551323	
	8	PROPELLER FAN ASSY	1	CWH03K1075	
	9	NUT	1	CWH561092	
	10	COMPRESSOR	1	9KD240XBB21	O
	12	BUSHING - COMPRESSOR MOUNT	3	CWH50055	
	13	NUT - COMPRESSOR MOUNT	3	CWH561049	
	14	CRANKCASE HEATER	1	CWA341093	
	16	ACCUMULATOR	1	CWB131064	
	17	3-WAYS VALVE (GAS)	1	CWB011769	O
	18	3-WAY VALVE (LIQUID)	1	CWB011770	O
	19	HOLDER COUPLING	1	CWH351262	
	20	STRAINER	1	CWB11061	
	21	STRAINER	4	CWB111081	
	22	EXPANSION VALVE	4	CWB051029	O
	23	4-WAYS VALVE	1	CWB001026J	O
	24	DISCHARGE MUFFLER	1	ACXB12-00650	
	25	HEATING PRESSURE SWITCH	1	CWA101013	O
	26	FLARE NUT (1/4)	4	CWT251030	
	27	FLARE NUT (3/8)	4	CWT251031	
	28	SOUND PROOF MATERIAL	1	CWG302804	
	31	SOUND PROOF MATERIAL	1	CWG302801	
	32	SENSOR - COMPLETE (DISCHARGE TEMP SENSOR CN-DIS)	1	CWA50C3091	O
	33	V-COIL CO. (4 WAY VALVE CN-HOT)	1	CWA43C2586	O
	34	V-COIL CO. (EXPAND VALVE - WHITE CN-EV1)	1	CWA43C2587	O
	35	V-COIL CO. (EXPAND VALVE - YELLOW CN-EV2)	1	CWA43C2588	O
	36	V-COIL CO.(EXPAND VALVE-BLUE CN-EV3)	1	CWA43C2589	O
	37	V-COIL CO. (EXPAND VALVE - RED CN-EV4)	1	CWA43C2590	O
	38	SENSOR - COMPLETE (DEFROST TEMP SENSOR CN-TH2)	1	CWA50C3087	O
	39	SENSOR - COMPLETE (OUTDOOR TEMP SENSOR CN-TH1)	1	ACXA50C00930	O
	40	SENSOR - COMPLETE (CN-TH4)	1	CWA50C3131	O
	41	SENSOR - COMPLETE (CN-TH3)	1	CWA50C3132	O
	43	ELECTRONIC CONTROLLER - MAIN	1	ACXA73C30450R	O
	44	ELECTRONIC CONTROLLER (NOISE FILTER)	1	ACXA73C29300	O
	45	ELECTRONIC CONTROLLER (DISPLAY)	1	CWA747223	O

SAFETY	REF.NO.	DESCRIPTION & NAME	QTY.	CU-4Z80TBE	REMARK
	47	REACTOR	1	G0C602J00013	O
	48	TERMINAL BOARD ASS'Y (L, N)	1	CWA28K1195	O
	49	TERMINAL BOARD ASS'Y (1, 2, 3)	4	CWA28K1196	O
	50	CONTROL BOARD COVER (TOP PCB)	1	CWH131613	
	51	CABINET REAR PLATE - COMPLETE	1	CWE02C1078	
	52	CABINET TOP PLATE	1	CWE03C1150	
	53	CABINET SIDE PLATE - COMPLETE	1	CWE04C1462	
	54	CABINET FRONT PLATE	1	CWE06C1475	
	55	CABINET SIDE PLATE	1	CWE041734A	
	56	CABINET FRONT PLATE - COMPLETE	1	CWE06C1476	
	57	WIRE NET	1	CWD041203A	
	58	HANDLE	2	CWE161021	
	59	TERMINAL COVER	1	CWH171039A	
	60	NUT - TERMINAL COVER	1	CWH7080300J	
	61	INSTALLATION INSTRUCTION	1	ACXF60-16610	
	62	INSTALLATION INSTRUCTION	1	ACXF60-16620	
	63	INSTALLATION INSTRUCTION	1	ACXF60-16630	
	64	INSTALLATION INSTRUCTION	1	ACXF60-16640	
	65	INSTALLATION INSTRUCTION	1	ACXF60-16650	
	66	INSTALLATION INSTRUCTION	1	ACXF60-16660	
	67	INSTALLATION INSTRUCTION	1	ACXF60-16670	
	68	INSTALLATION INSTRUCTION	1	ACXF60-16680	
	69	INSTALLATION INSTRUCTION	1	ACXF60-16690	
	74	ACCESSORY CO. (DRAIN ELBOW)	1	CWG87C900	
	78	TUBE ASS'Y (LIQUID)	1	CWT029448	
	79	TUBE ASS'Y (GAS)	1	ACXT00-51010	
	80	INSTALLATION INSTRUCTION	1	ACXF60-16700	
	81	INSTALLATION INSTRUCTION	1	ACXF60-16710	
	82	FLEXIBLE PIPE (L-TUBE)	1	CWH5850080	
	83	PACKING - L.TUBE	1	CWB81012	
	84	PANASONIC BADGE	1	CWE373439	
	85	LEAD WIRE - COMPRESSOR	1	CWA68C1395	
	86	HOLDER - SENSOR	5	CWH321111	
	87	SOUND PROOF MATERIAL	1	CWG302802	

(Note)

- All parts are supplied from PAPAMY, Malaysia (Vendor Code: 00029488).
- "O" marked parts are recommended to be kept in stock.

SAFETY	REF.NO.	DESCRIPTION & NAME	QTY.	CU-5Z90TBE	REMARK
	1	BASE PAN ASS'Y	1	CWD52K1345A	
	2	SOUND-PROOF BOARD	1	CWH151367	
	3	FAN MOTOR BRACKET	1	CWD54K1081	
	4	SCREW-FAN MOTOR BRACKET	3	CWH551217	
	5	CONDENSER COMPLETE	1	ACXB32C14960	
	6	FAN MOTOR	1	L6CBYYL0098	O
	7	SCREW-FAN MOTOR MOUNT	4	CWH551323	
	8	PROPELLER FAN ASSY	1	CWH03K1075	
	9	NUT	1	CWH561092	
	10	COMPRESSOR	1	9KD240XBB21	O
	12	BUSHING - COMPRESSOR MOUNT	3	CWH50055	
	13	NUT-COMPRESSOR MOUNT	3	CWH561049	
	14	CRANKCASE HEATER	1	CWA341093	
	16	ACCUMULATOR	1	CWB131064	
	17	3-WAYS VALVE(GAS)	1	CWB011769	O
	18	3-WAY VALVE(LIQUID)	1	CWB011770	O
	19	HOLDER COUPLING	1	CWH351262	
	20	STRAINER	1	CWB11061	
	21	STRAINER	5	CWB111081	
	22	EXPANSION VALVE	5	CWB051029	O
	23	4-WAYS VALVE	1	CWB001026J	O
	24	DISCHARGE MUFFLER	1	ACXB12-00650	
	25	HEATING PRESSURE SWITCH	1	CWA101013	O
	26	FLARE NUT (1/4)	5	CWT251030	
	27	FLARE NUT (3/8)	5	CWT251031	
	28	SOUND PROOF MATERIAL	1	CWG302804	
	31	SOUND PROOF MATERIAL	1	CWG302801	
	32	SENSOR-COMPLETE(DISCHARGE TEMP SENSOR CN-DIS)	1	CWA50C3091	O
	33	V-COIL CO.(4 WAY VALVE CN-HOT)	1	CWA43C2586	O
	34	V-COIL CO.(EXPAND VALVE-WHITE CN-EV1)	1	CWA43C2587	O
	35	V-COIL CO.(EXPAND VALVE-YELLOW CN-EV2)	1	CWA43C2588	O
	36	V-COIL CO.(EXPAND VALVE-BLUE CN-EV3)	1	CWA43C2589	O
	37	V-COIL CO.(EXPAND VALVE-RED CN-EV4)	1	CWA43C2590	O
	38	SENSOR-COMPLETE(DEFROST TEMP SENSOR CN-TH2)	1	CWA50C3087	O
	39	SENSOR-COMPLETE(OUTDOOR TEMP SENSOR CN-TH1)	1	ACXA50C00930	O
	40	SENSOR-COMPLETE(CN-TH4)	1	CWA50C3089	O
	41	SENSOR-COMPLETE(CN-TH3)	1	CWA50C3090	O
	42	V-COIL CO.(EXPAND VALVE-BLACK CN-EV5)	1	CWA43C2591	
	43	ELECTRONIC CONTROLLER-MAIN	1	ACXA73C30440R	O
	44	ELECTRONIC CONTROLLER(NOISE FILTER)	1	ACXA73C29300	O

SAFETY	REF.NO.	DESCRIPTION & NAME	QTY.	CU-5Z90TBE	REMARK
	45	ELECTRONIC CONTROLLER(DISPLAY)	1	CWA747223	O
	47	REACTOR	1	G0C602J00013	O
	48	TERMINAL BOARD ASS'Y (L,N)	1	CWA28K1195	O
	49	TERMINAL BOARD ASS'Y(1,2,3)	5	CWA28K1196	O
	50	CONTROL BOARD COVER(TOP PCB)	1	CWH131613	
	51	CABINET REAR PLATE-COMPLETE	1	CWE02C1078	
	52	CABINET TOP PLATE	1	CWE03C1150	
	53	CABINET SIDE PLATE-COMPLETE	1	CWE04C1462	
	54	CABINET FRONT PLATE	1	CWE06C1475	
	55	CABINET SIDE PLATE	1	CWE041734A	
	56	CABINET FRONT PLATE-COMPLETE	1	CWE06C1476	
	57	WIRE NET	1	CWD041203A	
	58	HANDLE	2	CWE161021	
	59	TERMINAL COVER	1	CWH171039A	
	60	NUT - TERMINAL COVER	1	CWH7080300J	
	61	INSTALLATION INSTRUCTION	1	ACXF60-16610	
	62	INSTALLATION INSTRUCTION	1	ACXF60-16620	
	63	INSTALLATION INSTRUCTION	1	ACXF60-16630	
	64	INSTALLATION INSTRUCTION	1	ACXF60-16640	
	65	INSTALLATION INSTRUCTION	1	ACXF60-16650	
	66	INSTALLATION INSTRUCTION	1	ACXF60-16660	
	67	INSTALLATION INSTRUCTION	1	ACXF60-16670	
	68	INSTALLATION INSTRUCTION	1	ACXF60-16680	
	69	INSTALLATION INSTRUCTION	1	ACXF60-16690	
	74	ACCESSORY CO.(DRAIN ELBOW)	1	CWG87C900	
	78	TUBE ASS'Y (LIQUID)	1	CWT029390	
	79	TUBE ASS'Y (GAS)	1	ACXT00-50990	
	80	INSTALLATION INSTRUCTION	1	ACXF60-16700	
	81	INSTALLATION INSTRUCTION	1	ACXF60-16710	
	82	FLEXIBLE PIPE (L-TUBE)	1	CWH5850080	
	83	PACKING-L.TUBE	1	CWB81012	
	84	PANASONIC BADGE	1	CWE373439	
	85	LEAD WIRE-COMPRESSOR	1	CWA68C1395	
	86	HOLDER-SENSOR	5	CWH321111	
	87	SOUND PROOF MATERIAL	1	CWG302802	

(Note)

- All parts are supplied from PAPAMY, Malaysia (Vendor Code: 00029488).
- “O” marked parts are recommended to be kept in stock.